

FCC Test Report

Report No.: RF190315C05 R5

FCC ID: A4RG020MN

Test Model: G020M, G020N

Received Date: Mar. 15, 2019

Test Date: May 27 to June 17, 2019

Issued Date: July 06, 2019

Applicant: Google LLC

Address: 1600 Amphitheatre Parkway, Mountain View, CA 94043, USA

Issued By: Bureau Veritas Consumer Products Services (H.K.) Ltd., Taoyuan Branch
Hsin Chu Laboratory

Lab Address: E-2, No.1, Li Hsin 1st Road, Hsinchu Science Park, Hsinchu City 300,
Taiwan R.O.C.

Test Location: E-2, No.1, Li Hsin 1st Road, Hsinchu Science Park, Hsinchu City 300,
Taiwan R.O.C.

**FCC Registration /
Designation Number:** 723255 / TW2022



This report is for your exclusive use. Any copying or replication of this report to or for any other person or entity, or use of our name or trademark, is permitted only with our prior written permission. This report sets forth our findings solely with respect to the test samples identified herein. The results set forth in this report are not indicative or representative of the quality or characteristics of the lot from which a test sample was taken or any similar or identical product unless specifically and expressly noted. Our report includes all of the tests requested by you and the results thereof based upon the information that you provided to us. You have 60 days from date of issuance of this report to notify us of any material error or omission caused by our negligence, provided, however, that such notice shall be in writing and shall specifically address the issue you wish to raise. A failure to raise such issue within the prescribed time shall constitute your unqualified acceptance of the completeness of this report, the tests conducted and the correctness of the report contents. Unless specific mention, the uncertainty of measurement has been explicitly taken into account to declare the compliance or non-compliance to the specification. The report must not be used by the client to claim product certification, approval, or endorsement by TAF or any government agencies.

Table of Contents

Release Control Record	4
1 Certificate of Conformity	5
2 Summary of Test Results	6
2.1 Measurement Uncertainty	6
2.2 Modification Record	6
3 General Information	7
3.1 General Description of EUT	7
3.2 Description of Test Modes	8
3.2.1 Test Mode Applicability and Tested Channel Detail	9
3.3 Description of Support Units	12
3.3.1 Configuration of System under Test	12
3.4 General Description of Applied Standards	13
3.5 Test Instruments	14
4 Test Types and Results	19
4.1 Duty Cycle Measurement	19
4.1.1 Applicable Rule and Limits of Duty Cycle Measurement	19
4.1.2 Test Procedures	19
4.1.3 Deviation from Test Standard	19
4.1.4 Test Setup	19
4.1.5 EUT Operating Conditions	19
4.1.6 Test Results (Mode 1)	20
4.1.7 Test Results (Mode 2)	21
4.2 Output Power Measurement	22
4.2.1 Limits of Output Power Measurement	22
4.2.2 Test Setup	22
4.2.3 Test Procedures	23
4.2.4 Deviation from Test Standard	23
4.2.5 EUT Operating Conditions	23
4.2.6 Test Results	24
4.3 Radiated Emission Measurement	25
4.3.1 Limits of Radiated Emission Measurement	25
4.3.2 Test Procedures	26
4.3.3 Deviation from Test Standard	27
4.3.4 Test Setup	28
4.3.5 EUT Operating Conditions	29
4.3.6 Test Results	30
4.4 Conducted Emission Measurement	38
4.4.1 Limits of Conducted Emission Measurement	38
4.4.2 Test Procedures	38
4.4.3 Deviation from Test Standard	38
4.4.4 Test Setup	38
4.4.5 EUT Operating Conditions	38
4.4.6 Test Results	39
4.5 6dB Bandwidth Measurement	41
4.5.1 Applicable Rule and Limits of 6dB Bandwidth Measurement	41
4.5.2 Test Setup	41
4.5.3 Test Procedure	41
4.5.4 Deviation from Test Standard	41
4.5.5 EUT Operating Conditions	41
4.5.6 Test Result	42
4.6 20dB Bandwidth Measurement	43
4.6.1 Applicable Rule and Limits of 20dB Bandwidth Measurement	43
4.6.2 Test Setup	43

4.6.3	Test Procedure	43
4.6.4	Deviation from Test Standard	44
4.6.5	EUT Operating Conditions.....	44
4.6.6	Test Result.....	45
4.7	Frequency Stability Measurement.....	46
4.7.1	Applicable Rule and Limits of Frequency Stability Measurement	46
4.7.2	Test Setup.....	46
4.7.3	Test Procedure	47
4.7.4	Deviation from Test Standard	47
4.7.5	EUT Operating Conditions.....	47
4.7.6	Test Result.....	48
4.8	99% Bandwidth Measurement	49
4.8.1	Limits of 99% Bandwidth Measurement	49
4.8.2	Test Setup.....	49
4.8.3	Test Procedure	49
4.8.4	Deviation from Test Standard	49
4.8.5	EUT Operating Conditions.....	49
4.8.6	Test Result.....	50
4.9	Peak Power Spectral Density Measurement	51
4.9.1	Applicable Rule and Limits of Peak Power Spectral Density Measurement	51
4.9.2	Test Setup.....	51
4.9.3	Test Procedures.....	52
4.9.4	Deviation from Test Standard	52
4.9.5	EUT Operating Conditions.....	52
4.9.6	Offset Calculation	53
4.9.7	Test Results	54
5	Pictures of Test Arrangements.....	55
	Appendix – Information of the Testing Laboratories	56

Release Control Record

Issue No.	Description	Date Issued
RF190315C05	Original release.	June 24, 2019
RF190315C05 R1	1. Modify the description of measurement. 2. Modify EIRP of model G020N.	June 25, 2019
RF190315C05 R2	Modify the description of duty cycle measurement.	June 26, 2019
RF190315C05 R3	Modify the applied standards of section 3.4.	July 04, 2019
RF190315C05 R4	Add the Duty Cycle 0.12% test result.	July 05, 2019
RF190315C05 R5	Add the test instruments for above 40GHz test item.	July 06, 2019

1 Certificate of Conformity

Product: Phone
Test Model: G020M, G020N
Sample Status: EVT
Applicant: Google LLC
Test Date: May 27 to June 17, 2019
Standards: 47 CFR FCC Part 15, Subpart C (Section 15.255) as referenced by FCC DA 18-1308
ANSI C63.10: 2013

The above equipment has been tested by **Bureau Veritas Consumer Products Services (H.K.) Ltd., Taoyuan Branch**, and found compliance with the requirement of the above standards. The test record, data evaluation & Equipment Under Test (EUT) configurations represented herein are true and accurate accounts of the measurements of the sample's EMC characteristics under the conditions specified in this report.

Prepared by : Phoenix Huang , **Date:** July 06, 2019
Phoenix Huang / Specialist

Approved by : Wen Yu , **Date:** July 06, 2019
Wen Yu / Supervisor

2 Summary of Test Results

Standard	Test Items	Limit	Test Procedure	Note	Remarks
§15.255 (f) /FCC Waiver	20 dB Bandwidth	57 -64 GHz	ANSI 63.10		Meet the requirement of limit.
§15.255 (f)	Frequency Stability	57 -64 GHz	ANSI 63.10	Extreme Temperature: -20, +50 °C	Meet the requirement of limit.
§15.255 (e)	6 dB Bandwidth / OBW	Reporting Purposes Only	ANSI 63.10		Reference only.
FCC Waiver	Duty Cycle	10% within 33ms	ANSI 63.10		Meet the requirement of limit.
FCC Waiver	Peak EIRP	13 dBm/10% duty cycle	Substitution Method		Meet the requirement of limit.
-	Average EIRP	RF Exposure Purposes	Substitution Method		Reference only.
FCC Waiver	Peak PSD	13 dBm/MHz	ANSI 63.10		Meet the requirement of limit.
§15.255 (d)(2)	30 MHz - 40 GHz Radiated Emissions	74dBuV/m for Peak 54dBuV/m for Average	ANSI 63.10		Meet the requirement of limit. Minimum passing margin is -7.4dB at 39.89MHz.
§15.255 (d)(3)	40 GHz - 200 GHz Radiated Emissions	90 pW/cm ²	ANSI 63.10	-10dBm EIRP at 3m	
§15.207	AC Line Conducted Emissions	Refer §15.207	ANSI 63.10		Meet the requirement of limit. Minimum passing margin is -14.65dB at 0.38828MHz.
§15.255 (g) /§1.1310(e)	RF Exposure	Refer §1.1310(e)	Calculation Only		See Note 2

Note:

1. Determining compliance based on the results of the compliance measurement, not taking into account measurement instrumentation uncertainty.
2. The " RF Exposure" was recorded in another test report.

2.1 Measurement Uncertainty

Where relevant, the following measurement uncertainty levels have been estimated for tests performed on the EUT as specified in CISPR 16-4-2:

Measurement	Frequency	Expanded Uncertainty (k=2) (±)
Conducted Emissions at mains ports	150kHz ~ 30MHz	1.8 dB
Radiated Emissions up to 1 GHz	30MHz ~ 1GHz	5.1 dB
Radiated Emissions above 1 GHz	1GHz ~ 6GHz	5.1 dB
	6GHz ~ 18GHz	5.0 dB
	18GHz ~ 40GHz	5.2 dB
	40GHz ~ 200GHz	5.4 dB

2.2 Modification Record

There were no modifications required for compliance.

3 General Information

3.1 General Description of EUT

Product	Phone
Test Model	G020M, G020N
Identification No. of EUT	934AZ06962
Status of EUT	Normal Operating Condition
Battery Nominal Voltage	3.85 VDC
Battery Voltage Operation Range	3.5 – 4.4 Vdc
Modulation Type	FMCW
Modulation Technology	Pulse
Transfer Rate	N/A
Operating Frequency	58 – 63.5 GHz
Antenna Type	Microstrip Patch <input checked="" type="checkbox"/> Integral <input type="checkbox"/> Exernal
Antenna Connector	NA
Antenna Gain	6 dBi, <input checked="" type="checkbox"/> Specified by manufacturer <input type="checkbox"/> Measured
Test sequence / test software used:	See 3.2 Description of Test Modes
Output Power (EIRP)	11.65 dBm
Accessory Device	Refer to Notes as below
Data Cable Supplied	Refer to Notes as below

Note:

1. The difference between model G020I, G020M, and G020N is on supporting WWAN bands, and other features and hardware are the same.
2. The test results in this report are based on the highest EIRP model G020I to be the worst case measurements. Please refer to section 4.1 for the measured and compared EIRP results.
3. The above EUT information is declared by manufacturer and for more detailed features description, please refer to the manufacturer's specifications or user's manual.

3.2 Description of Test Modes

Test Mode	Frequency Range (GHz)	Channel	Frequency (GHz)	Duty Cycle
Mode 1	58 – 63.5	1	60.75	10%
Mode 2	58 – 63.5	1	60.75	0.12%

Note: All measurements were performed on mode 1 (highest duty cycle) as the worst case.

3.2.1 Test Mode Applicability and Tested Channel Detail

EUT CONFIGURE MODE	APPLICABLE TO										DESCRIPTION
	DC	RE ≥ 1G	RE < 1G	PLC	6dB BW	20dB BW	FS	99% BW	OP	PSD	
1	√	√	√	√	√	√	√	√	√	√	Duty Cycle 10%
2	√	-	-	-	-	-	-	-	-	-	Duty Cycle 0.12%

Where **DC:** Duty Cycle
RE < 1G: Radiated Emission below 1GHz
6dB BW: 6dB Bandwidth
FS: Frequency Stability
OP: Output Power
RE ≥ 1G: Radiated Emission above 1GHz
PLC: Power Line Conducted Emission
20dB BW: 20dB Bandwidth
99% BW: 99% Bandwidth
PSD: Power Spectral Density

Note: The EUT had been pre-tested on the positioned of each 3 axis. The worst case was found when positioned on **Y-plane**.

Duty Cycle Test:

- Pre-Scan has been conducted to determine the worst-case mode from all possible combinations between available modulations, data rates and antenna ports (if EUT with antenna diversity architecture).
- Following channel(s) was (were) selected for the final test as listed below.

Available Mode	Tested Mode	Modulation Technology	Modulation Type
1	1	Pulse	FMCW
2	1	Pulse	FMCW

Radiated Emission Test (Above 1GHz):

- Pre-Scan has been conducted to determine the worst-case mode from all possible combinations between available modulations, data rates and antenna ports (if EUT with antenna diversity architecture).
- Following channel(s) was (were) selected for the final test as listed below.

Available Mode	Tested Mode	Modulation Technology	Modulation Type
1	1	Pulse	FMCW

Radiated Emission Test (Below 1GHz):

- Pre-Scan has been conducted to determine the worst-case mode from all possible combinations between available modulations, data rates and antenna ports (if EUT with antenna diversity architecture).
- Following channel(s) was (were) selected for the final test as listed below.

Available Mode	Tested Mode	Modulation Technology	Modulation Type
1	1	Pulse	FMCW

Power Line Conducted Emission Test:

- Pre-Scan has been conducted to determine the worst-case mode from all possible combinations between available modulations, data rates and antenna ports (if EUT with antenna diversity architecture).
- Following channel(s) was (were) selected for the final test as listed below.

Available Mode	Tested Mode	Modulation Technology	Modulation Type
1	1	Pulse	FMCW

6dB Bandwidth Test:

- Pre-Scan has been conducted to determine the worst-case mode from all possible combinations between available modulations, data rates and antenna ports (if EUT with antenna diversity architecture).
- Following channel(s) was (were) selected for the final test as listed below.

Available Mode	Tested Mode	Modulation Technology	Modulation Type
1	1	Pulse	FMCW

20dB Bandwidth test:

- Pre-Scan has been conducted to determine the worst-case mode from all possible combinations between available modulations, data rates and antenna ports (if EUT with antenna diversity architecture).
- Following channel(s) was (were) selected for the final test as listed below.

Available Mode	Tested Mode	Modulation Technology	Modulation Type
1	1	Pulse	FMCW

Frequency stability test:

- Pre-Scan has been conducted to determine the worst-case mode from all possible combinations between available modulations, data rates and antenna ports (if EUT with antenna diversity architecture).
- Following channel(s) was (were) selected for the final test as listed below.

Available Mode	Tested Mode	Modulation Technology	Modulation Type
1	1	Pulse	FMCW

99% Bandwidth Test:

- Pre-Scan has been conducted to determine the worst-case mode from all possible combinations between available modulations, data rates and antenna ports (if EUT with antenna diversity architecture).
- Following channel(s) was (were) selected for the final test as listed below.

Available Mode	Tested Mode	Modulation Technology	Modulation Type
1	1	Pulse	FMCW

Output Power Measurement:

- Pre-Scan has been conducted to determine the worst-case mode from all possible combinations between available modulations, data rates and antenna ports (if EUT with antenna diversity architecture).
- Following channel(s) was (were) selected for the final test as listed below.

Available Mode	Tested Mode	Modulation Technology	Modulation Type
1	1	Pulse	FMCW

Power Spectral Density Measurement:

- Pre-Scan has been conducted to determine the worst-case mode from all possible combinations between available modulations, data rates and antenna ports (if EUT with antenna diversity architecture).
- Following channel(s) was (were) selected for the final test as listed below.

Available Mode	Tested Mode	Modulation Technology	Modulation Type
1	1	Pulse	FMCW

Test Condition:

APPLICABLE TO	ENVIRONMENTAL CONDITIONS	INPUT POWER	TESTED BY
DC	23deg. C, 62%RH	120Vac, 60Hz	Weiwei Lo
RE \geq 1G	23deg. C, 70%RH, 25deg. C, 71%RH	120Vac, 60Hz	Andy Ho, Weiwei Lo
RE $<$ 1G	23deg. C, 68%RH	120Vac, 60Hz	Andy Ho
PLC	24deg. C, 75%RH	120Vac, 60Hz	Andy Ho
6dB BW	23deg. C, 62%RH	120Vac, 60Hz	Weiwei Lo
20dB BW	23deg. C, 62%RH	120Vac, 60Hz	Weiwei Lo
FS	23deg. C, 62%RH	120Vac, 60Hz	Weiwei Lo
99% BW	23deg. C, 62%RH	120Vac, 60Hz	Weiwei Lo
OP	23deg. C, 62%RH	120Vac, 60Hz	Weiwei Lo
PSD	23deg. C, 62%RH	120Vac, 60Hz	Weiwei Lo

3.3 Description of Support Units

The EUT has been tested as an independent unit.

ID	Descriptions	Qty.	Length (m)	Shielding (Yes/No)	Cores (Qty.)	Remarks
1.	Type C USB Cable	1	1	Yes	0	Supplied by client

3.3.1 Configuration of System under Test

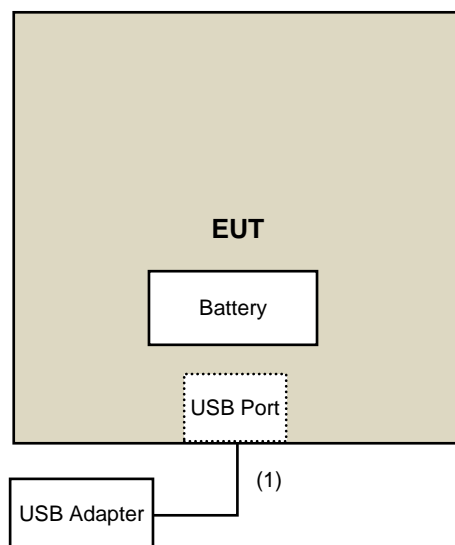

3.4 General Description of Applied Standards

The EUT is a RF Product. According to the specifications of the manufacturer, it must comply with the requirements of the following standards:

FCC Part 15, Subpart C (15.255) as referenced by FCC DA 18-1308

ANSI C63.10-2013

All test items have been performed and recorded as per the above standards.

3.5 Test Instruments

For Power Line Conducted Emission Test:

DESCRIPTION & MANUFACTURER	MODEL NO.	SERIAL NO.	CALIBRATED DATE	CALIBRATED UNTIL
Test Receiver R&S	ESCS 30	847124/029	Oct. 24, 2018	Oct. 23, 2019
Line-Impedance Stabilization Network (for EUT) R&S	ESH3-Z5	848773/004	Oct. 22, 2018	Oct. 21, 2019
Line-Impedance Stabilization Network (for Peripheral) R&S	ESH3-Z5	835239/001	Mar. 17, 2019	Mar. 16, 2020
50 ohms Terminator	N/A	3	Oct. 22, 2018	Oct. 21, 2019
RF Cable	5D-FB	COCCAB-001	Sep. 28, 2018	Sep. 27, 2019
Fixed attenuator EMCI	STI02-2200-10	003	Mar. 14, 2019	Mar. 13, 2020
Software BVADT	BVADT_Cond_V7.3.7.4	NA	NA	NA

Note:

1. The calibration interval of the above test instruments are 12 months and the calibrations are traceable to NML/ROC and NIST/USA.
2. The test was performed in Conduction 1.
3. Tested Date: May 27, 2019

For Other Test (30MHz ~ 18GHz):

Description & Manufacturer	Model No.	Serial No.	Cal. Date	Cal. Due
Test Receiver Agilent	N9038A	MY50010156	July 12, 2018	July 11, 2019
Pre-Amplifier EMCI	EMC001340	980142	Jan. 25, 2019	Jan. 24, 2020
Loop Antenna Electro-Metrics	EM-6879	269	Sep. 07, 2018	Sep. 06, 2019
RF Cable	NA	LOOPCAB-001	Jan. 14, 2019	Jan. 13, 2020
RF Cable	NA	LOOPCAB-002	Jan. 14, 2019	Jan. 13, 2020
Pre-Amplifier Mini-Circuits	ZFL-1000VH2B	AMP-ZFL-05	Apr. 30, 2019	Apr. 29, 2020
Trilog Broadband Antenna SCHWARZBECK	VULB 9168	9168-361	Nov. 22, 2018	Nov. 21, 2019
RF Cable	8D	966-3-1	Mar. 18, 2019	Mar. 17, 2020
RF Cable	8D	966-3-2	Mar. 18, 2019	Mar. 17, 2020
RF Cable	8D	966-3-3	Mar. 18, 2019	Mar. 17, 2020
Fixed attenuator Mini-Circuits	UNAT-5+	PAD-3m-3-01	Sep. 27, 2018	Sep. 26, 2019
Horn_Antenna SCHWARZBECK	BBHA9120-D	9120D-406	Nov. 25, 2018	Nov. 24, 2019
Pre-Amplifier EMCI	EMC12630SE	980384	Jan. 28, 2019	Jan. 27, 2020
RF Cable	EMC104-SM-SM-1200	160922	Jan. 28, 2019	Jan. 27, 2020
RF Cable	EMC104-SM-SM-2000	180601	June 12, 2018	June 11, 2019
RF Cable	EMC104-SM-SM-6000	180602	June 12, 2018	June 11, 2019
Software	ADT_Radiated_V8.7.08	NA	NA	NA
Antenna Tower & Turn Table Max-Full	MF-7802	MF780208406	NA	NA
Boresight Antenna Fixture	FBA-01	FBA-SIP01	NA	NA

Note:

1. The calibration interval of the above test instruments is 12 months and the calibrations are traceable to NML/ROC and NIST/USA.
2. The test was performed in 966 Chamber No. 3.
3. Loop antenna was used for all emissions below 30 MHz.
4. Tested Date: May 27 to June 01, 2019

For Other Test (18 ~ 40 GHz):

DESCRIPTION & MANUFACTURER	MODEL NO.	SERIAL NO.	CALIBRATED DATE	CALIBRATED UNTIL
Test Receiver Agilent	N9038A	MY50010156	July 12, 2018	July 11, 2019
Spectrum Analyzer Keysight	N9030A	MY54490679	July 23, 2018	July 22, 2019
Pre-Amplifier EMCI	EMC184045SE	980387	Jan. 28, 2019	Jan. 27, 2020
Horn_Antenna SCHWARZBECK	BBHA 9170	BBHA9170519	Nov. 25, 2018	Nov. 24, 2019
RF Cable	EMC102-KM-KM-1200	160924	Jan. 28, 2019	Jan. 27, 2020
RF Cable	EMC102-KM-KM-1200	160925	Jan. 28, 2019	Jan. 27, 2020
Software	ADT_Radiated_V8.7.08	NA	NA	NA
Antenna Tower & Turn Table Max-Full	MF-7802	MF780208406	NA	NA

Note:

1. The calibration interval of the above test instruments is 12 months and the calibrations are traceable to NML/ROC and NIST/USA.
2. The test was performed in 966 Chamber No. 3.
3. Tested Date: June 15, 2019

For Other Test (Above 40 GHz):

Description & Manufacturer	Model No.	Serial No.	Cal. Date	Cal. Due
Spectrum Analyzer Agilent	E4446A	MY48250254	Nov. 14, 2018	Nov. 13, 2019
*Spectrum Analyzer Keysight	N9041B	US56480107	Aug. 14, 2017	Aug. 13, 2019
*Horn Antenna (33~55GHz) OML	M22RH	110215-1	Oct. 17, 2017	Oct. 16, 2019
*Horn Antenna (50~75GHz) OML	M15HWD	110215-1	Oct. 17, 2017	Oct. 16, 2019
*Horn Antenna (75~110GHz) OML	M10RH	110215-1	Oct. 17, 2017	Oct. 16, 2019
*Horn Antenna(110~170GHz) OML	M06HWD	110215-1	Oct. 17, 2017	Oct. 16, 2019
*Horn Antenna (140~220GHz) OML	M05RH	110215-1	Oct. 17, 2017	Oct. 16, 2019
GENERAL PURPOSE DETECTOR Millitech	DET-15- RPFW0 A18483	084	C.O.C	C.O.C
Digital Storage Oscilloscope Keysight	DSOX6002A+ DSOX6000- AMG	MY56270092	Jan. 17, 2019	Jan. 16, 2020
*WR15CH Conical Horn Keysight	WR15CH	WR15CH-01	Oct. 17, 2017	Oct. 16, 2019
*WR10CH Conical Horn Keysight	WR10CH	WR10CH-01	Oct. 17, 2017	Oct. 16, 2019
*Millimeter-Wave Signal Generator Frequency Extension Module (50~75 GHz) Keysight	E8257DV15	US54250106	Oct. 17, 2017	Oct. 16, 2019
*Millimeter-Wave Signal Generator Frequency Extension Module (75~110 GHz) Keysight	E8257DV10	US53250009	Oct. 17, 2017	Oct. 16, 2019
PSG analog signal generator Keysight	E8257D	MY53401987	Jun. 26, 2018	Jun. 25, 2019
*Power meter Keysight	E4417A	MY55276004	Oct. 17, 2017	Oct. 16, 2019
*Waveguide Power Sensor Keysight	V8486A	MY55170003	Oct. 17, 2017	Oct. 16, 2019
*Waveguide Power Sensor Keysight	W8486A	MY55230006	Oct. 17, 2017	Oct. 16, 2019
Antenna Tower & Turn Table CT	NA	NA	NA	NA
Millimeter-Wave Signal Generator Frequency Extension Module (110~170 GHz) Keysight	E8257DV06- DC9	US53250019	C.O.C	C.O.C
Millimeter-Wave Signal Generator Frequency Extension Module (170~260 GHz) DVI	VDIWR4.3SGX	SGX 290	C.O.C	C.O.C
Millimeter-Wave Spectrum Analyzer Frequency Extension Module (110~170 GHz) DVI	VDIWR6.5SAX	SAX 270	C.O.C	C.O.C
Millimeter-Wave Spectrum Analyzer Frequency Extension Module (170~260 GHz) DVI	VDIWR4.3SAX	SAX 308	C.O.C	C.O.C
Spectrum Analyzer R&S	FSV40	100964	June 20, 2018	June 19, 2019

DC Power Supply Topward	6603D	795558	NA	NA
Temperature & Humidity Chamber Giant Force	GTH-150-40- SP-AR	MAA0812-008	Jan. 09, 2019	Jan. 08, 2020
True RMS Clamp Meter FLUKE	325	31130711WS	May 21, 2019	May 20, 2020

Note:

1. The calibration interval of the above test instruments is 12 months and the calibrations are traceable to NML/ROC and NIST/USA.
2. *The calibration interval of the above test instruments is 24 months and the calibrations are traceable to NML/ROC and NIST/USA.
3. The test was performed in 966 Chamber 3
4. Tested Date: June 05 to 17, 2019

4 Test Types and Results

4.1 Duty Cycle Measurement

4.1.1 Applicable Rule and Limits of Duty Cycle Measurement

Per paragraph 14 of the associated waiver, FCC DA 18-1308, the device shall operate with a maximum transmit duty cycle of 10 percent in any 33 milliseconds (ms) interval.

4.1.2 Test Procedures

The spectrum analyzer and external mixer are set up to measure the radiated output of the transmitter.

4.1.3 Deviation from Test Standard

No deviation.

4.1.4 Test Setup

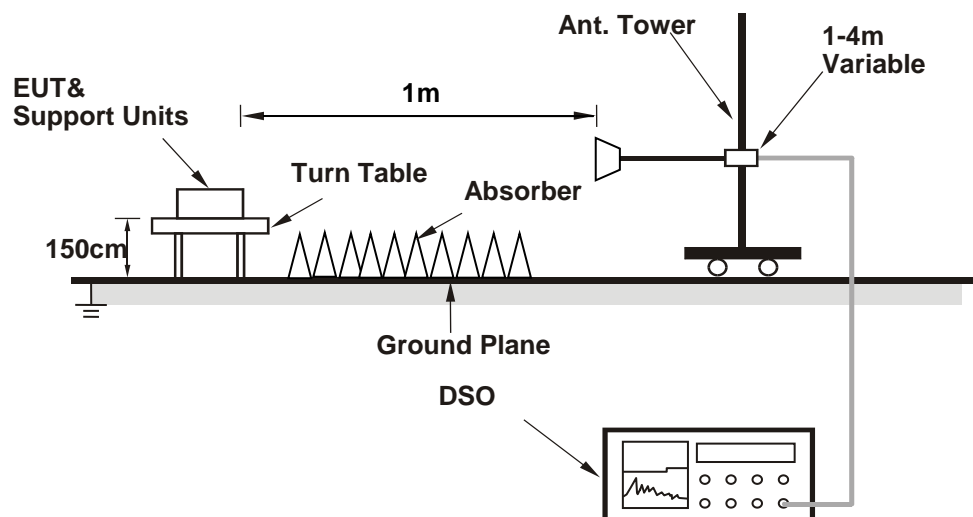

4.1.5 EUT Operating Conditions

The software provided by client to enable the EUT under transmission condition continuously at specific channel frequencies individually.

4.1.6 Test Results (Mode 1)

Maximum ON Time in any 33 ms observation period = (30 chirps) * (108.6 us/chirp) = 3.258 ms Maximum Limit = 3.3 ms
 PASS

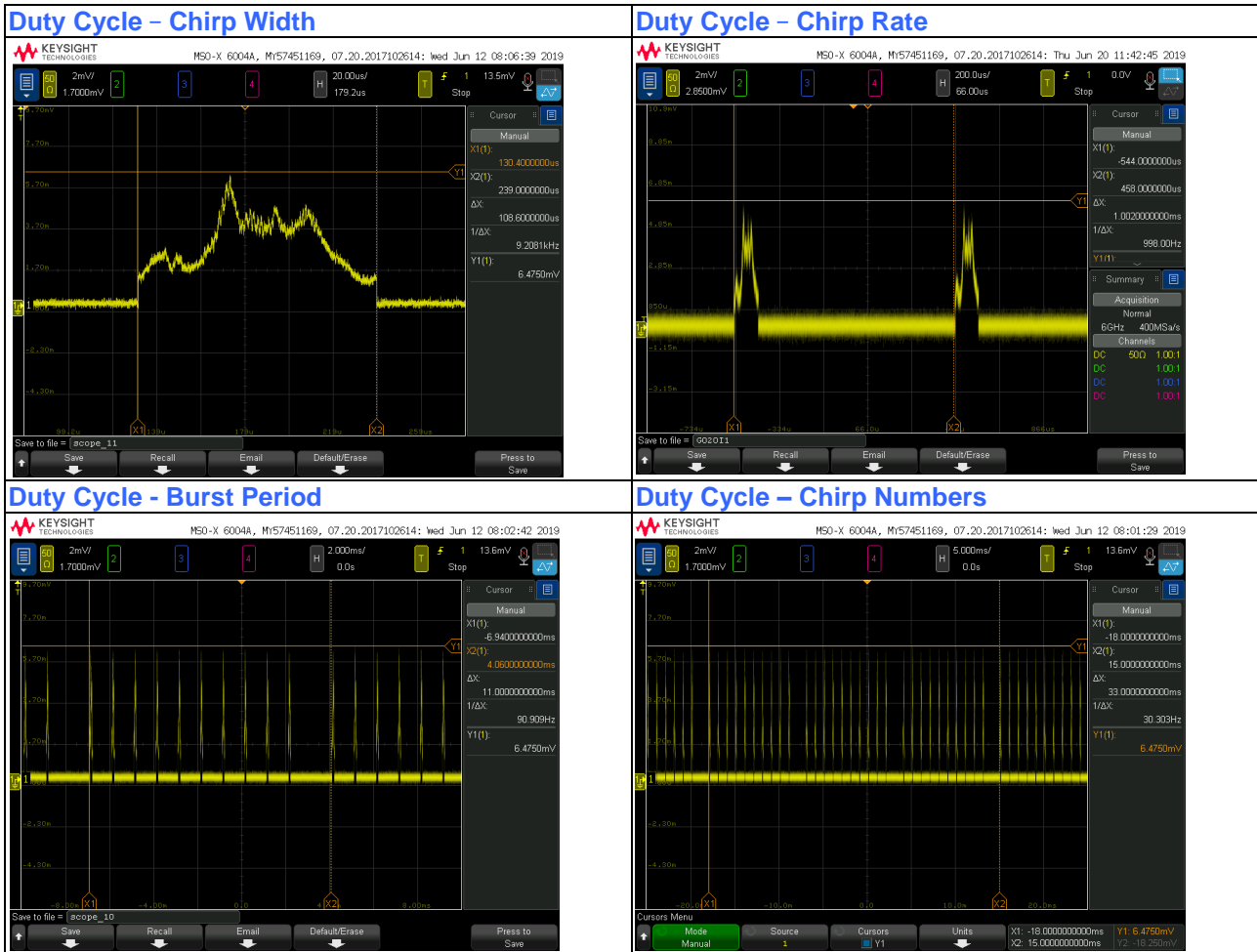

4.1.7 Test Results (Mode 2)

Minimum ON Time in any 33 ms observation period = (8 chirps) * (35.8 us/chirp) = 0.2864 ms Minimum Limit = 0.033 ms

PASS

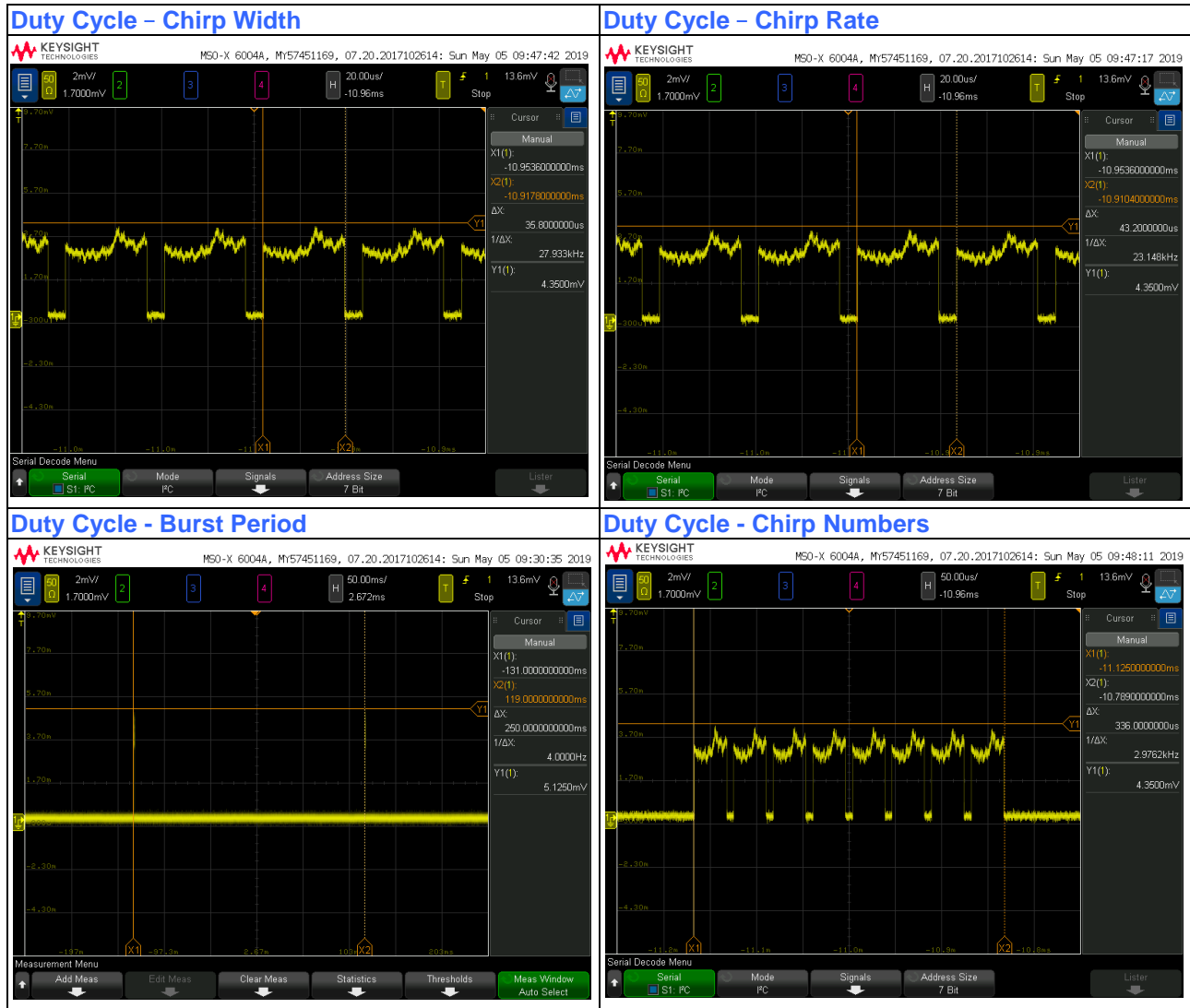

4.2 Output Power Measurement

4.2.1 Limits of Output Power Measurement

Per paragraph 14 of the associated waiver, FCC DA 18-1308, the device shall be certified for compliance with all the technical specifications applicable to operation under 47 CFR, Part 15, with the exception of the following provisions in: 1) 47 CFR § 15.255(c)(3), which is waived to allow the device to operate in the 57-64 GHz band at a maximum +13 dBm EIRP, +10 dBm transmitter conducted output power, and +13 dBm/MHz power spectral density;...

Limit

+13 dBm EIRP

+10 dBm conducted output power

4.2.2 Test Setup

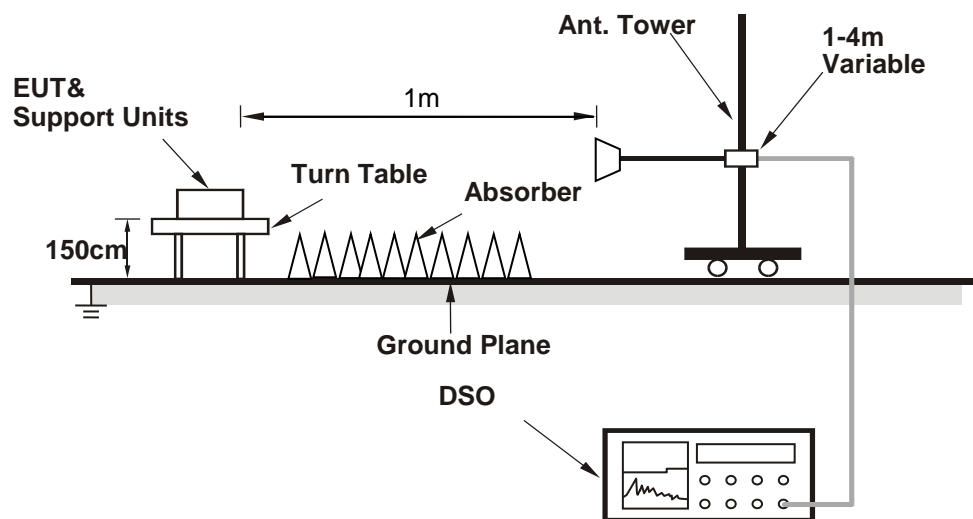

4.2.3 Test Procedures

- a. Place the EUT in a continuous transmission mode.
- b. For radiated emission measurements, attach a test receive antenna for the fundamental frequency band to the RF input of an RF detector or a downconverter with an RF detector at the output.
- c. Connect the video output of the detector to the 50 ohm input of the DSO.
- d. Place the test receive antenna in the main beam of the EUT at a distance which will provide a signal within the operating range of the RF detector.
- e. Set the sampling rate of the DSO to the required value. Adjust the memory depth, the triggering and the sweep speed to obtain a display which is representative of the signal considering the type of modulation.
- f. For radiated emission measurements, calculate the distance to the far field boundary of the fundamental emission using following equation

$$d_{\text{farfield}} = \frac{2D^2}{\lambda}$$

where:

D = largest dimension of the transmit antenna

λ = wavelength

Tx patch antenna

Frequency (GHz)	L (m)	Lambda (m)	R (Far Field) (m)
58	0.00233	0.0052	0.0021
63.5	0.00233	0.0047	0.0023

Rx horn antenna

Frequency (GHz)	L (m)	Lambda (m)	R (Far Field) (m)
58	0.025	0.0052	0.2404
63.5	0.025	0.0047	0.266

- g. Perform radiated emission measurements to keep maximize the received signal from the EUT in the far field.
- h. Record the average and peak from the DSO and the measurement distance.
- i. Disconnect the EUT from the RF input port of the instrumentation system.
- j. Connect a mm-wave source to the RF input port of the instrumentation system via a waveguide variable attenuator. The mm-wave source is unmodulated.
- k. Using substitution measurement.
- l. Measure and note the power.
- m. For conducted power measurements, calculate the conducted power using following equation

$$P_{\text{cond}} = \text{EIRP} - G_{\text{dBi}}$$

4.2.4 Deviation from Test Standard

No deviation.

4.2.5 EUT Operating Conditions

Same as Item 4.1.5.

4.2.6 Test Results

For Peak Power

Model: G020M

Channel	Frequency (GHz)	Transmit Antenna	S.G Output Value (dBm)	EIRP (dBm)	EIRP Limit (dBm)	Pass /Fail
1	60.75	24	-12.85	11.15	13	Pass

Model: G020N

Channel	Frequency (GHz)	Transmit Antenna	S.G Output Value (dBm)	EIRP (dBm)	EIRP Limit (dBm)	Pass /Fail
1	60.75	24	-12.96	11.04	13	Pass

Model: G020I

Channel	Frequency (GHz)	Transmit Antenna	S.G Output Value (dBm)	EIRP (dBm)	EIRP Limit (dBm)	Pass /Fail
1	60.75	24	-12.35	11.65	13	Pass

For Peak Conducted Power

Channel	Frequency (GHz)	EIRP (dBm)	EUT Transmit Antenna Gain (dBi)	Conducted Output Power (dBm)	Conducted Output Power limit (dBm)	Pass /Fail
1	60.75	11.65	6	5.65	10	Pass

For Average Power

Channel	Frequency (GHz)	EIRP (dBm)
1	60.75	1.65

Note:

1. The EIRP was evaluated on vertical and horizontal polarization, the worst case is Vertical polarization.
2. Average power = Peak power – 10*log(1/duty cycle).
3. All measurements were performed on the highest EIRP unit as the worst case.

4.3 Radiated Emission Measurement

4.3.1 Limits of Radiated Emission Measurement

Spurious Emission	
Frequency Range	Limitation
Radiated emissions below 40GHz	Part 15.209
Between 40GHz and 200GHz	90pW/cm ² (at 3 meter)

Note:
The levels of the spurious emissions shall not exceed the level of the fundamental emission

Emissions radiated outside of the specified bands, shall be according to the general radiated limits in 15.209 as following:

Frequencies (MHz)	Field strength (microvolts/meter)	Measurement distance (meters)
0.009-0.490	2400/F(kHz)	300
0.490-1.705	24000/F(kHz)	30
1.705-30.0	30	30
30-88	100	3
88-216	150	3
216-960	200	3
Above 960	500	3

Note:

1. The lower limit shall apply at the transition frequencies.
2. Emission level (dBuV/m) = 20 log Emission level (uV/m).
3. As shown in 15.35(b), for frequencies above 1000MHz, the field strength limits are based on average detector, however, the peak field strength of any emission shall not exceed the maximum permitted average limits, specified above by more than 20dB under any condition of modulation.
4. Section 15.205 restricted bands of operation shall compliance with the limits in Section 15.209.

4.3.2 Test Procedures

For Radiated emission below 30MHz

- a. The EUT was placed on the top of a rotating table 0.8 meters above the ground at a 3 meter chamber room. The table was rotated 360 degrees to determine the position of the highest radiation.
- b. The EUT was set 3 meters away from the interference-receiving antenna, which was mounted on the top of a variable-height antenna tower.
- c. Parallel, perpendicular, and ground-parallel orientations of the antenna are set to make the measurement.
- d. For each suspected emission, the EUT was arranged to its worst case and the rotatable table was turned from 0 degrees to 360 degrees to find the maximum reading.
- e. The test-receiver system was set to Quasi-Peak Detect Function and Specified Bandwidth with Maximum Hold Mode.

Note:

1. The resolution bandwidth and video bandwidth of test receiver/spectrum analyzer is 9kHz at frequency below 30MHz.

For Radiated emission 30MHz to 40GHz

- a. The EUT was placed on the top of a rotating table 0.8 meters (for 30MHz ~ 1GHz) / 1.5 meters (for above 1GHz) above the ground at 3 meter chamber room for test. The table was rotated 360 degrees to determine the position of the highest radiation.
- b. The EUT was set 3 meters (30MHz-18GHz) / 1 meters (18GHz-40GHz) away from the interference-receiving antenna, which was mounted on the top of a variable-height antenna tower.
- c. The height of antenna is varied from one meter to four meters above the ground to determine the maximum value of the field strength. Both horizontal and vertical polarizations of the antenna are set to make the measurement.
- d. For each suspected emission, the EUT was arranged to its worst case and then the antenna was tuned to heights from 1 meter to 4 meters and the rotatable table was turned from 0 degrees to 360 degrees to find the maximum reading.
- e. The test-receiver system was set to quasi-peak detect function and specified bandwidth with maximum hold mode when the test frequency is below 1 GHz.
- f. The test-receiver system was set to peak and average detects function and specified bandwidth with maximum hold mode when the test frequency is above 1 GHz. If the peak reading value also meets average limit, measurement with the average detector is unnecessary.

Note:

1. The resolution bandwidth and video bandwidth of test receiver/spectrum analyzer is 120kHz for Quasi-peak detection (QP) at frequency below 1GHz.
2. The resolution bandwidth of test receiver/spectrum analyzer is 1 MHz and the video bandwidth is 3 MHz for Peak detection (PK) and Average detection (AV) at frequency above 1GHz.
3. All modes of operation were investigated and the worst-case emissions are reported.

For Radiated emission above 40GHz

- a. Connect the test antenna covering the appropriate frequency range to a spectrum analyzer via an external mixer to the spectrum analyzer.
- b. Set spectrum analyzer RBW = 1 MHz, VBW = 3 MHz, average detector.
- c. Calculate the distance to the far field boundary and determine the maximum measurement distance.
- d. Perform an exploratory search for emissions and determine the approximate direction at which each observed emission emanates from the EUT.
- e. Exploratory measurements be made at a closer distance than the validated maximum measurement distance.
- f. Perform a final measurement; begin with the test antenna at the approximate position where the maximum level occurred during the exploratory scan.
- g. Slowly scan the test antenna around this position, slowly vary the test antenna polarization by rotating through at least 0° to 180°, and slowly vary the orientation of the test antenna to find the final position, polarization, and orientation at which the maximum level of the emission is observed.
- h. Record the measured reading with the test antenna fixed at this maximized position, polarization, and orientation. Record the measurement distance.
- i. Calculate the maximum field strength of the emission at the measurement distance and the adjusted/corrected power at the output of the test antenna.
- j. Calculate the EIRP from the measured field strength and then convert to the linear.
- k. Calculate the power density at the distance specified by the limit from the field strength at the distance specified by the limit.
- l. Repeat the preceding sequence for every emission observed in the frequency band under investigation.

4.3.3 Deviation from Test Standard

No deviation.

4.3.4 Test Setup

For Radiated emission below 30MHz

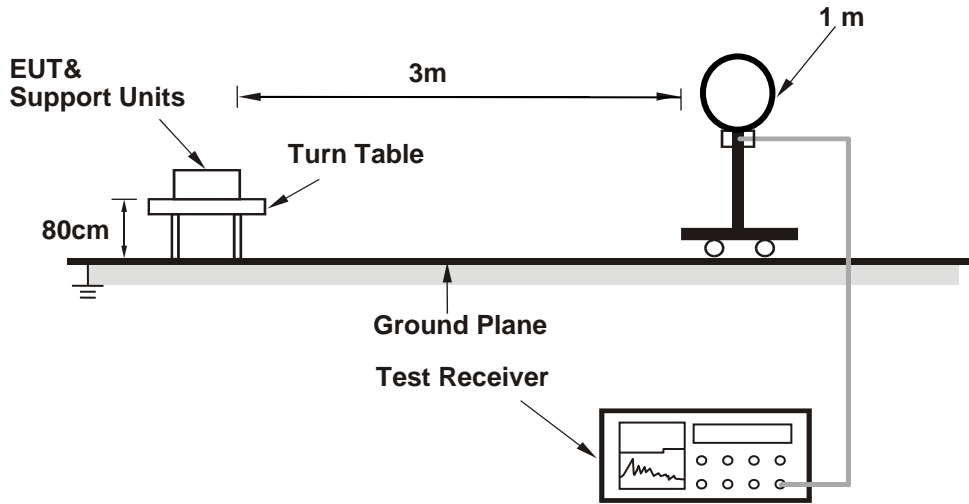

For Radiated emission 30MHz to 1GHz

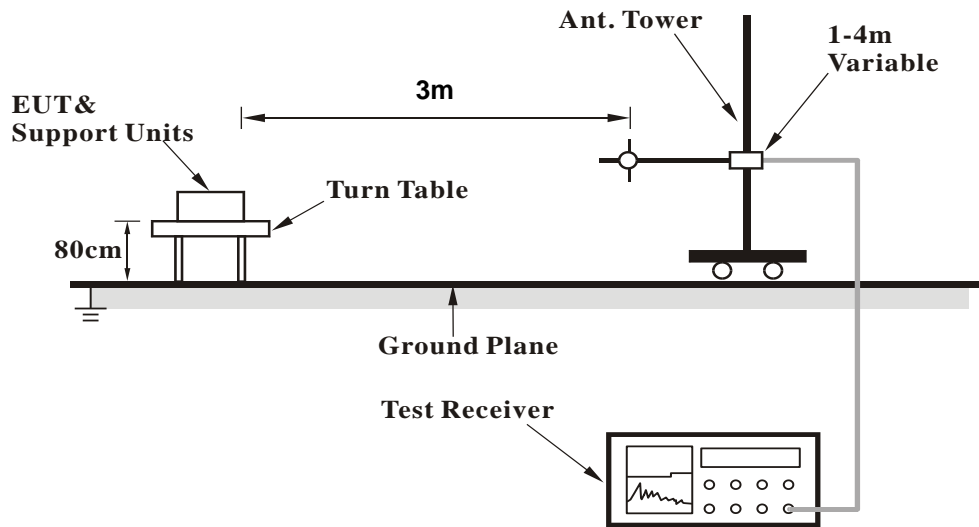

For Radiated emission 1GHz to 40GHz

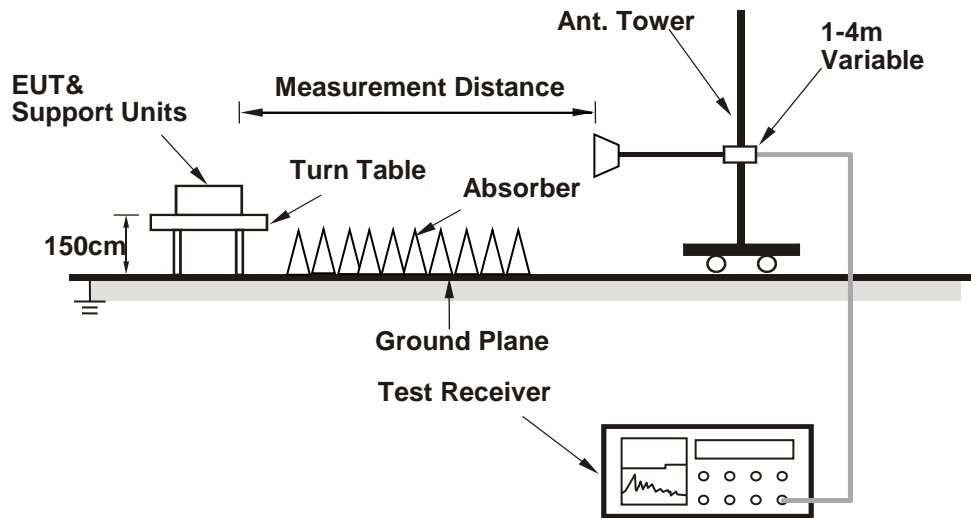

For Radiated emission above 40 GHz

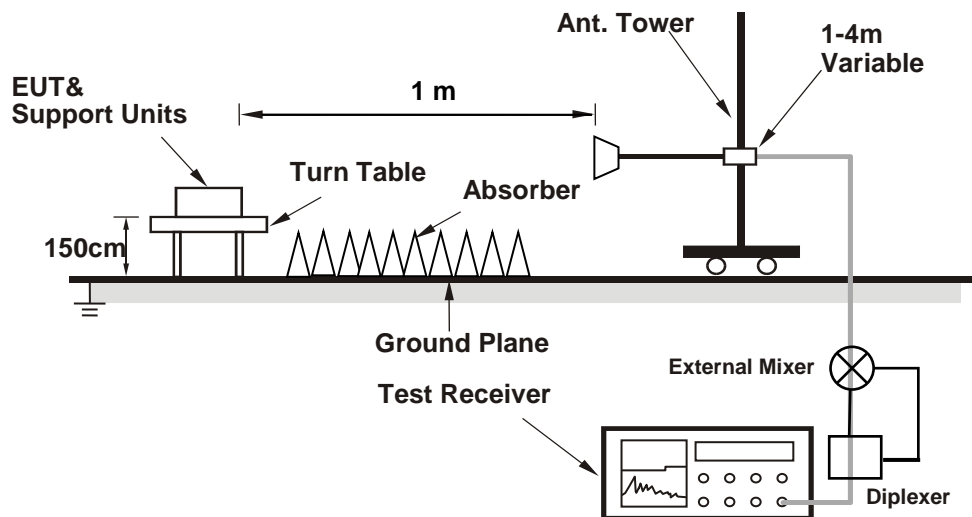

For the actual test configuration, please refer to the attached file (Test Setup Photo).

4.3.5 EUT Operating Conditions

Same as Item 4.1.5.

4.3.6 Test Results

Above 1GHz Data:

For 1~18GHz

CHANNEL	TX Channel 1	DETECTOR FUNCTION	Peak (PK)
FREQUENCY RANGE	1GHz ~ 18GHz		Average (AV)

ANTENNA POLARITY & TEST DISTANCE: HORIZONTAL AT 3 M

NO.	FREQ. (MHz)	EMISSION LEVEL (dBuV/m)	LIMIT (dBuV/m)	MARGIN (dB)	ANTENNA HEIGHT (m)	TABLE ANGLE (Degree)	RAW VALUE (dBuV)	CORRECTION FACTOR (dB/m)
1	1900.00	36.4 PK	74.0	-37.6	2.00 H	37	41.9	-5.5
2	1900.00	30.3 AV	54.0	-23.7	2.00 H	37	35.8	-5.5
3	7185.02	46.4 PK	74.0	-27.6	1.50 H	167	40.9	5.5
4	7185.02	32.5 AV	54.0	-21.5	1.50 H	167	27.0	5.5
5	17992.78	55.1 PK	74.0	-18.9	2.00 H	292	38.2	16.9
6	17992.78	43.2 AV	54.0	-10.8	2.00 H	292	26.3	16.9

REMARKS:

1. Emission Level(dBuV/m) = Raw Value(dBuV) + Correction Factor(dB/m)
2. Correction Factor(dB/m) = Antenna Factor(dB/m) + Cable Factor(dB) – Pre-Amplifier Factor(dB)
3. Margin value = Emission Level – Limit value
4. The other emission levels were very low against the limit.

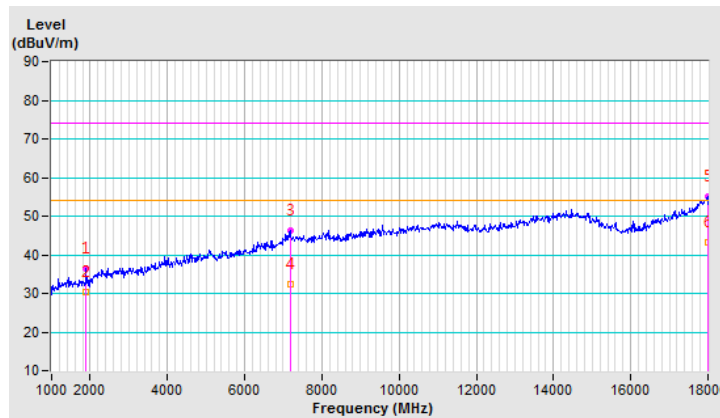

CHANNEL	TX Channel 1	DETECTOR FUNCTION	Peak (PK)
FREQUENCY RANGE	1GHz ~ 18GHz		Average (AV)

ANTENNA POLARITY & TEST DISTANCE: VERTICAL AT 3 M

NO.	FREQ. (MHz)	EMISSION LEVEL (dBuV/m)	LIMIT (dBuV/m)	MARGIN (dB)	ANTENNA HEIGHT (m)	TABLE ANGLE (Degree)	RAW VALUE (dBuV)	CORRECTION FACTOR (dB/m)
1	1500.22	33.7 PK	74.0	-40.3	1.00 V	98	39.7	-6.0
2	1500.22	20.3 AV	54.0	-33.7	1.00 V	98	26.3	-6.0
3	8140.43	45.6 PK	74.0	-28.4	2.00 V	180	39.4	6.2
4	8140.43	32.5 AV	54.0	-21.5	2.00 V	180	26.3	6.2
5	17979.60	54.9 PK	74.0	-19.1	1.50 V	139	38.2	16.7
6	17979.60	43.0 AV	54.0	-11.0	1.50 V	139	26.3	16.7

REMARKS:

1. Emission Level(dBuV/m) = Raw Value(dBuV) + Correction Factor(dB/m)
2. Correction Factor(dB/m) = Antenna Factor(dB/m) + Cable Factor(dB) – Pre-Amplifier Factor(dB)
3. Margin value = Emission Level – Limit value
4. The other emission levels were very low against the limit.

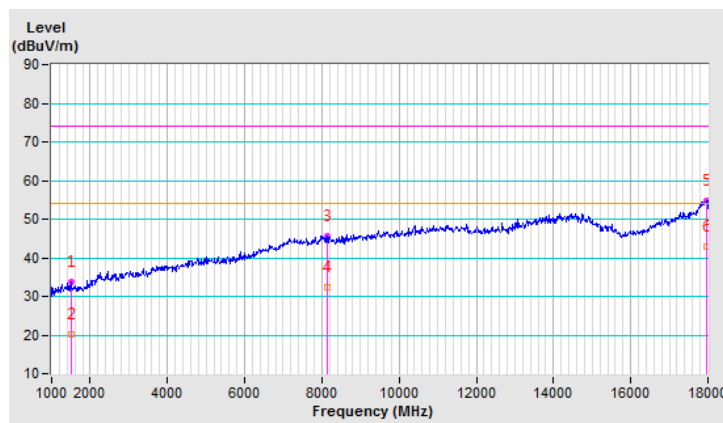

For 18~40GHz

CHANNEL	TX Channel 1	DETECTOR FUNCTION	Peak (PK)
FREQUENCY RANGE	18GHz ~ 40GHz		Average (AV)

ANTENNA POLARITY: HORIZONTAL								
NO.	FREQ. (MHz)	EMISSION LEVEL (dBuV/m)	LIMIT (dBuV/m)	MARGIN (dB)	ANTENNA HEIGHT (m)	TABLE ANGLE (Degree)	RAW VALUE (dBuV)	CORRECTION FACTOR (dB/m)
1	21062.40	38.4 PK	74.0	-35.6	1.56 H	233	57.1	-18.7
2	21062.40	24.7 AV	54.0	-29.3	1.56 H	233	43.4	-18.7
3	29210.42	47.3 PK	74.0	-26.7	1.60 H	348	65.4	-18.1
4	29210.42	42.4 AV	54.0	-11.6	1.60 H	348	60.5	-18.1
5	39318.39	48.3 PK	74.0	-25.7	1.50 H	217	58.6	-10.3
6	39318.39	35.7 AV	54.0	-18.3	1.50 H	217	46.0	-10.3

REMARKS:

1. Emission Level(dBuV/m) = Raw Value(dBuV) + Correction Factor(dB/m)
2. Correction Factor(dB/m) = Antenna Factor(dB/m) + Cable Factor(dB) – Pre-Amplifier Factor(dB)
3. The other emission levels were very low against the limit.
4. Margin value = Emission Level – Limit value
5. Shorter measurement distances was used to improve the measurement system's noise floor. As standard description is based on the measurement in distance of 3 meters, the data obtained at 1-meter distance was extrapolate results to the 3-m distance:
 Test value at 3-meter distance (dBuV)
 = Test value at 1 meter distance (dBuV) -20log(3/1)(dB)
 = Test value at 1 meter distance (dBuV) -9.54(dB).

*Measurements made at 1 meter distance. Test value converted to account for 3-meter measurement distance.

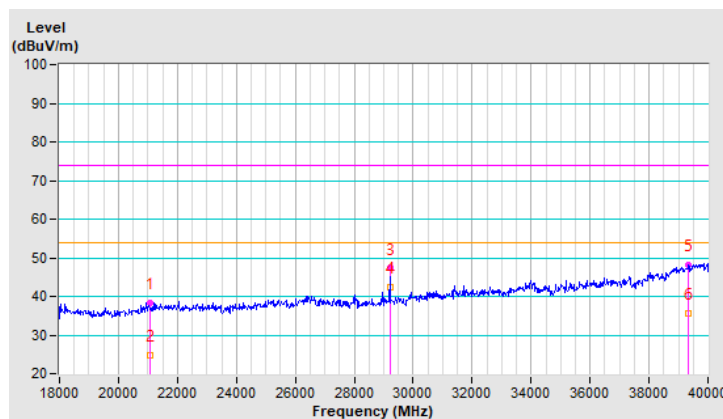

CHANNEL	TX Channel 1	DETECTOR FUNCTION	Peak (PK)
FREQUENCY RANGE	18GHz ~ 40GHz		Average (AV)

ANTENNA POLARITY: VERTICAL								
NO.	FREQ. (MHz)	EMISSION LEVEL (dBuV/m)	LIMIT (dBuV/m)	MARGIN (dB)	ANTENNA HEIGHT (m)	TABLE ANGLE (Degree)	RAW VALUE (dBuV)	CORRECTION FACTOR (dB/m)
1	20444.49	36.4 PK	74.0	-37.6	1.50 V	253	56.0	-19.6
2	20444.49	24.7 AV	54.0	-29.3	1.50 V	253	44.3	-19.6
3	29210.58	47.3 PK	74.0	-26.7	1.68 V	352	65.4	-18.1
4	29210.58	43.0 AV	54.0	-11.0	1.68 V	352	61.1	-18.1
5	39517.45	48.6 PK	74.0	-25.4	1.53 V	143	58.2	-9.6
6	39517.45	35.7 AV	54.0	-18.3	1.53 V	143	45.3	-9.6

REMARKS:

1. Emission Level(dBuV/m) = Raw Value(dBuV) + Correction Factor(dB/m)
2. Correction Factor(dB/m) = Antenna Factor(dB/m) + Cable Factor(dB) – Pre-Amplifier Factor(dB)
3. The other emission levels were very low against the limit.
4. Margin value = Emission Level – Limit value
5. Shorter measurement distances was used to improve the measurement system’s noise floor. As standard description is based on the measurement in distance of 3 meters, the data obtained at 1-meter distance was extrapolate results to the 3-m distance:
 Test value at 3-meter distance (dBuV)
 = Test value at 1 meter distance (dBuV) -20log(3/1)(dB)
 = Test value at 1 meter distance (dBuV) -9.54(dB).

*Measurements made at 1 meter distance. Test value converted to account for 3-meter measurement distance.

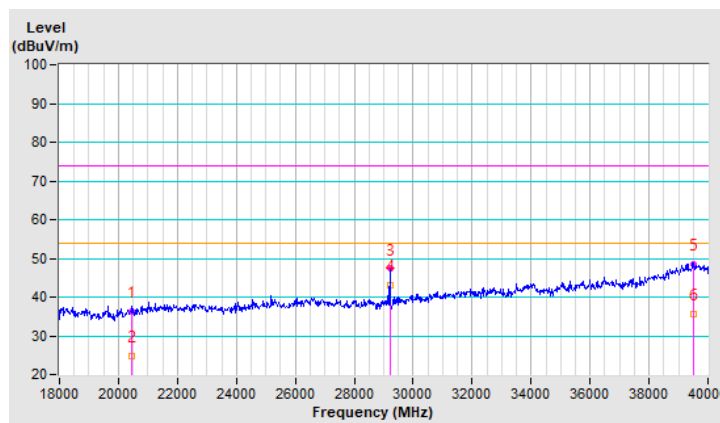

For above 40GHz

CHANNEL	TX Channel 1	DETECTOR FUNCTION	Average (AV)
FREQUENCY RANGE	40GHz ~ 200GHz		

ANTENNA POLARITY: HORIZONTAL							
NO.	Frequency (GHz)	EIRP Level (dBm)	S.G Output Value (dBm)	Transmit Antenna Gain (dBi)	Power Density (pW/cm ²)	Power Density Limit (pW/cm ²)	Margin (pW/cm ²)
1	43.67	-60.94	-84.94	24	0.001	90	-89.999
2	120.048	-45.13	-68.93	23.8	0.027	90	-89.973
3	199.25	-52.10	-76.20	24.1	0.005	90	-89.995
ANTENNA POLARITY: VERTICAL							
NO.	Frequency (GHz)	EIRP Level (dBm)	S.G Output Value (dBm)	Transmit Antenna Gain (dBi)	Power Density (pW/cm ²)	Power Density Limit (pW/cm ²)	Margin (pW/cm ²)
1	43.41	-62.30	-85.30	24	0.001	90	-89.999
2	120.014	-46.30	-70.10	23.8	0.021	90	-89.979
3	198.23	-53.20	-77.30	24.1	0.004	90	-89.996

Note:

1. The measured power level is converted to EIRP using the Friis equation:

$$EIRP = P_{cond} + G_{EUT} = P_{SG} + G_{transmit}$$

where:

P_{cond} is the EUT conducted power

G_{EUT} is the EUT antenna gain

P_{SG} is the S.G output level

$G_{transmit}$ is the transmit antenna gain

*Measurements made at 1 meter distance.

2. Power density formula as follows:

$$\text{Power density} = EIRP / (4 * \pi * r^2)$$

r is the standard distance at 3 meter

3. The far-field boundary is given in ANSI 63.10 as:

$$R \text{ far field} = (2 * L^2) / \lambda$$

L is the Largest Antenna Dimension, including the reflector

λ is the wavelength

Q-Band

Frequency (GHz)	L (m)	Lambda (m)	R (Far Field) (m)
40	0.03	0.0075	0.240
50	0.03	0.0060	0.300

V-Band

Frequency (GHz)	L (m)	Lambda (m)	R (Far Field) (m)
50	0.025	0.0075	0.208
75	0.025	0.0040	0.313

W-Band

Frequency (GHz)	L (m)	Lambda (m)	R (Far Field) (m)
75	0.018	0.0040	0.162
110	0.018	0.0027	0.238

D-Band

Frequency (GHz)	L (m)	Lambda (m)	R (Far Field) (m)
110	0.012	0.0027	0.106
170	0.012	0.0018	0.163

Y-Band

Frequency (GHz)	L (m)	Lambda (m)	R (Far Field) (m)
170	0.008	0.0018	0.073
260	0.008	0.0012	0.111

For below 1GHz

CHANNEL	TX Channel 1	DETECTOR FUNCTION	Quasi-Peak (QP)
FREQUENCY RANGE	9kHz ~ 1GHz		

ANTENNA POLARITY & TEST DISTANCE: HORIZONTAL AT 3 M								
NO.	FREQ. (MHz)	EMISSION LEVEL (dBuV/m)	LIMIT (dBuV/m)	MARGIN (dB)	ANTENNA HEIGHT (m)	TABLE ANGLE (Degree)	RAW VALUE (dBuV)	CORRECTION FACTOR (dB/m)
1	30.07	31.5 QP	40.0	-8.5	1.00 H	284	40.8	-9.3
2	49.57	30.6 QP	40.0	-9.4	1.00 H	316	39.2	-8.6
3	169.49	33.7 QP	43.5	-9.8	1.50 H	327	42.2	-8.5
4	185.03	32.0 QP	43.5	-11.5	1.50 H	322	41.5	-9.5
5	519.97	31.4 QP	46.0	-14.6	1.00 H	67	32.4	-1.0
6	626.45	32.6 QP	46.0	-13.4	1.00 H	3	31.2	1.4

REMARKS:

1. Emission Level(dBuV/m) = Raw Value(dBuV) + Correction Factor(dB/m)
2. Correction Factor(dB/m) = Antenna Factor(dB/m) + Cable Factor(dB) – Pre-Amplifier Factor(dB)
3. Margin value = Emission Level – Limit value
4. The other emission levels were very low against the limit of frequency range 30MHz~1000MHz.
5. The emission levels were very low against the limit of frequency range 9kHz~30MHz: the amplitude of spurious emissions attenuated more than 20 dB below the permissible value to be report.

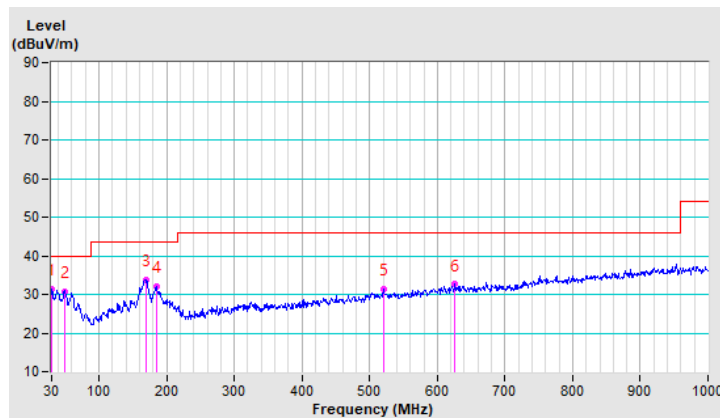

CHANNEL	TX Channel 1	DETECTOR FUNCTION	Quasi-Peak (QP)
FREQUENCY RANGE	9kHz ~ 1GHz		

ANTENNA POLARITY & TEST DISTANCE: VERTICAL AT 3 M

NO.	FREQ. (MHz)	EMISSION LEVEL (dBuV/m)	LIMIT (dBuV/m)	MARGIN (dB)	ANTENNA HEIGHT (m)	TABLE ANGLE (Degree)	RAW VALUE (dBuV)	CORRECTION FACTOR (dB/m)
1	39.89	32.6 QP	40.0	-7.4	1.00 V	264	41.9	-9.3
2	169.75	30.4 QP	43.5	-13.1	1.00 V	84	39.0	-8.6
3	264.67	27.2 QP	46.0	-18.8	1.50 V	80	34.9	-7.7
4	521.26	31.1 QP	46.0	-14.9	3.00 V	80	32.2	-1.1
5	582.39	32.1 QP	46.0	-13.9	2.00 V	296	31.7	0.4
6	776.00	34.2 QP	46.0	-11.8	1.50 V	360	30.3	3.9

REMARKS:

1. Emission Level(dBuV/m) = Raw Value(dBuV) + Correction Factor(dB/m)
2. Correction Factor(dB/m) = Antenna Factor(dB/m) + Cable Factor(dB) – Pre-Amplifier Factor(dB)
3. Margin value = Emission Level – Limit value
4. The other emission levels were very low against the limit of frequency range 30MHz~1000MHz.
5. The emission levels were very low against the limit of frequency range 9kHz~30MHz: the amplitude of spurious emissions attenuated more than 20 dB below the permissible value to be report.

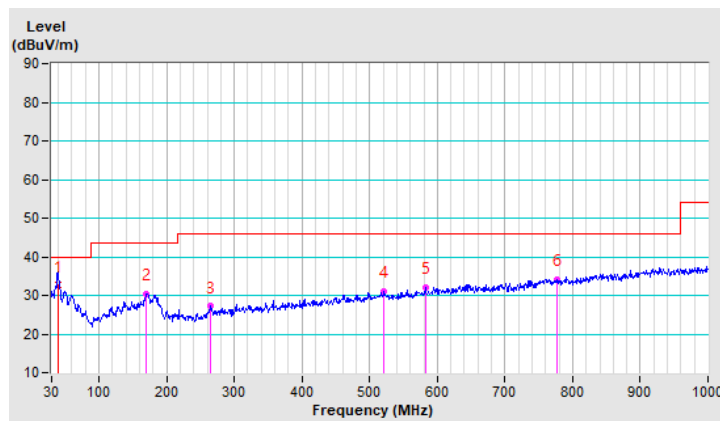

4.4 Conducted Emission Measurement

4.4.1 Limits of Conducted Emission Measurement

Frequency (MHz)	Conducted Limit (dBuV)	
	Quasi-peak	Average
0.15 - 0.5	66 - 56	56 - 46
0.50 - 5.0	56	46
5.0 - 30.0	60	50

Note: 1. The lower limit shall apply at the transition frequencies.
 2. The limit decreases in line with the logarithm of the frequency in the range of 0.15 to 0.50MHz.

4.4.2 Test Procedures

- The EUT was placed 0.4 meters from the conducting wall of the shielded room with EUT being connected to the power mains through a line impedance stabilization network (LISN). Other support units were connected to the power mains through another LISN. The two LISNs provide 50 ohm/ 50uH of coupling impedance for the measuring instrument.
- Both lines of the power mains connected to the EUT were checked for maximum conducted interference.
- The frequency range from 150kHz to 30MHz was searched. Emission levels under (Limit - 20dB) was not recorded.

Note: The resolution bandwidth and video bandwidth of test receiver is 9kHz for quasi-peak detection (QP) and average detection (AV) at frequency 0.15MHz-30MHz.

4.4.3 Deviation from Test Standard

No deviation.

4.4.4 Test Setup

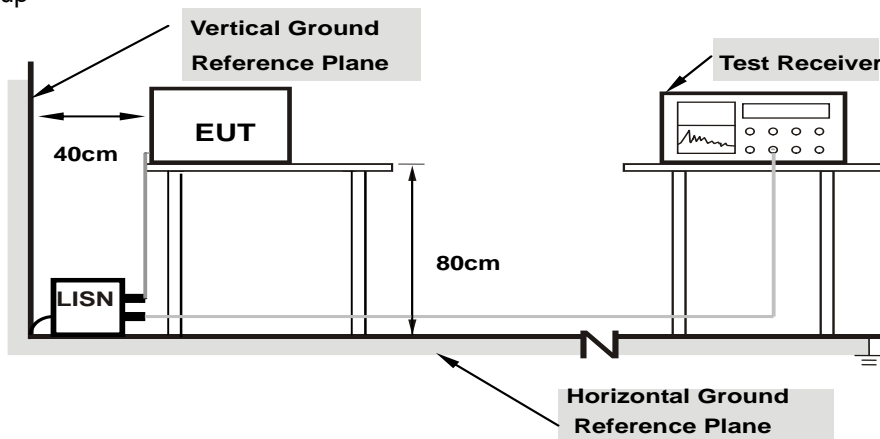

Note: 1. Support units were connected to second LISN.

For the actual test configuration, please refer to the attached file (Test Setup Photo).

4.4.5 EUT Operating Conditions

Same as 4.1.5.

4.4.6 Test Results

Channel	TX Channel 1		
Phase	Line (L)	Detector Function	Quasi-Peak (QP) / Average (AV)

No	Freq. [MHz]	Corr.	Reading Value		Emission Level		Limit		Margin	
		Factor	[dB (uV)]		[dB (uV)]		[dB (uV)]		(dB)	
		(dB)	Q.P.	AV.	Q.P.	AV.	Q.P.	AV.	Q.P.	AV.
1	0.15781	10.03	31.77	13.97	41.80	24.00	65.58	55.58	-23.78	-31.58
2	0.29063	10.06	24.16	6.87	34.22	16.93	60.51	50.51	-26.29	-33.58
3	0.38828	10.08	33.05	19.34	43.13	29.42	58.10	48.10	-14.97	-18.68
4	0.53281	10.09	15.47	1.28	25.56	11.37	56.00	46.00	-30.44	-34.63
5	7.11719	10.52	5.86	-3.38	16.38	7.14	60.00	50.00	-43.62	-42.86
6	27.12109	11.53	13.30	5.67	24.83	17.20	60.00	50.00	-35.17	-32.80

Remarks:

1. Q.P. and AV. are abbreviations of quasi-peak and average individually.
2. The emission levels of other frequencies were very low against the limit.
3. Margin value = Emission level – Limit value
4. Correction factor = Insertion loss + Cable loss
5. Emission Level = Correction Factor + Reading Value

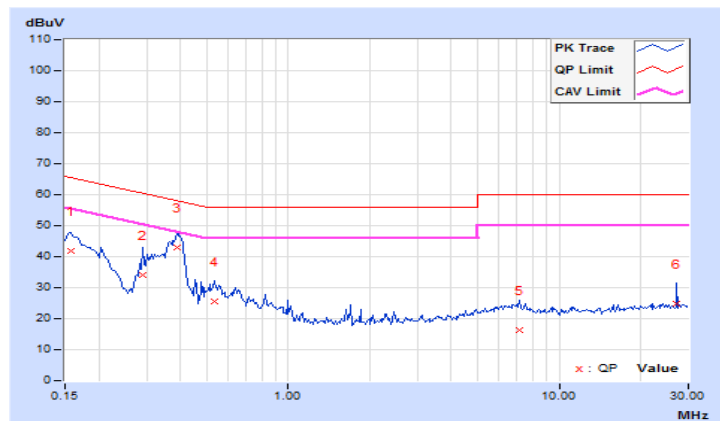

Channel	TX Channel 1		
Phase	Neutral (N)	Detector Function	Quasi-Peak (QP) / Average (AV)

No	Freq. [MHz]	Corr. Factor (dB)	Reading Value [dB (uV)]		Emission Level [dB (uV)]		Limit [dB (uV)]		Margin (dB)	
			Q.P.	AV.	Q.P.	AV.	Q.P.	AV.	Q.P.	AV.
	1	0.15000	9.94	32.55	15.24	42.49	25.18	66.00	56.00	-23.51
2	0.17734	9.95	29.06	12.30	39.01	22.25	64.61	54.61	-25.60	-32.36
3	0.29453	9.96	25.16	9.25	35.12	19.21	60.40	50.40	-25.28	-31.19
4	0.38828	9.98	33.47	20.22	43.45	30.20	58.10	48.10	-14.65	-17.90
5	0.49375	9.98	12.71	-2.34	22.69	7.64	56.10	46.10	-33.41	-38.46
6	27.12109	11.26	15.05	8.16	26.31	19.42	60.00	50.00	-33.69	-30.58

Remarks:

1. Q.P. and AV. are abbreviations of quasi-peak and average individually.
2. The emission levels of other frequencies were very low against the limit.
3. Margin value = Emission level – Limit value
4. Correction factor = Insertion loss + Cable loss
5. Emission Level = Correction Factor + Reading Value

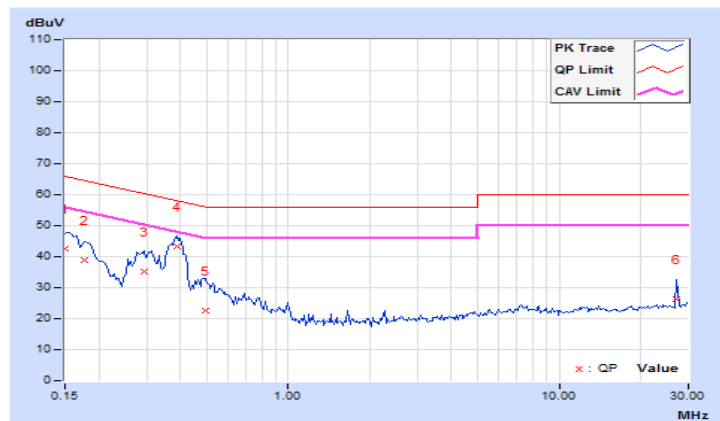

4.5 6dB Bandwidth Measurement

4.5.1 Applicable Rule and Limits of 6dB Bandwidth Measurement

Applicable Rule

§15.255 (e) (1) Transmitters with an emission bandwidth of less than 100 MHz must limit their peak transmitter conducted output power to the product of 500 mW times their emission bandwidth divided by 100 MHz. For the purposes of this paragraph, emission bandwidth is defined as the instantaneous frequency range occupied by a steady state radiated signal with modulation, outside which the radiated power spectral density never exceeds 6 dB below the maximum radiated power spectral density in the band, as measured with a 100 kHz resolution bandwidth spectrum analyzer. The center frequency must be stationary during the measurement interval, even if not stationary during normal operation (e.g., for frequency hopping devices).

Limit

None: For reporting purposes only.

4.5.2 Test Setup

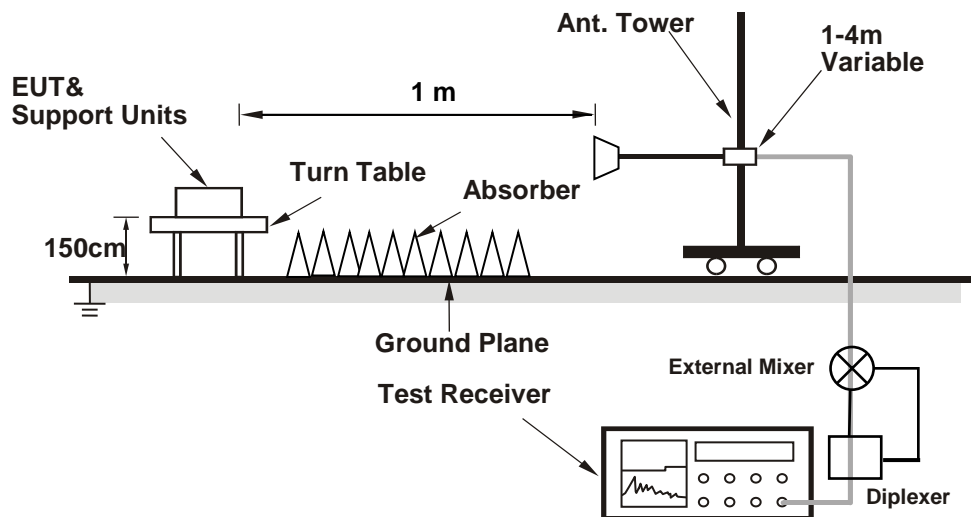

4.5.3 Test Procedure

The spectrum analyzer and external mixer are set up to measure the radiated output of the transmitter.

4.5.4 Deviation from Test Standard

No deviation.

4.5.5 EUT Operating Conditions

Same as Item 4.1.5.

4.5.6 Test Result

Channel	Frequency (GHz)	6dB Bandwidth (GHz)
1	60.75	5.591

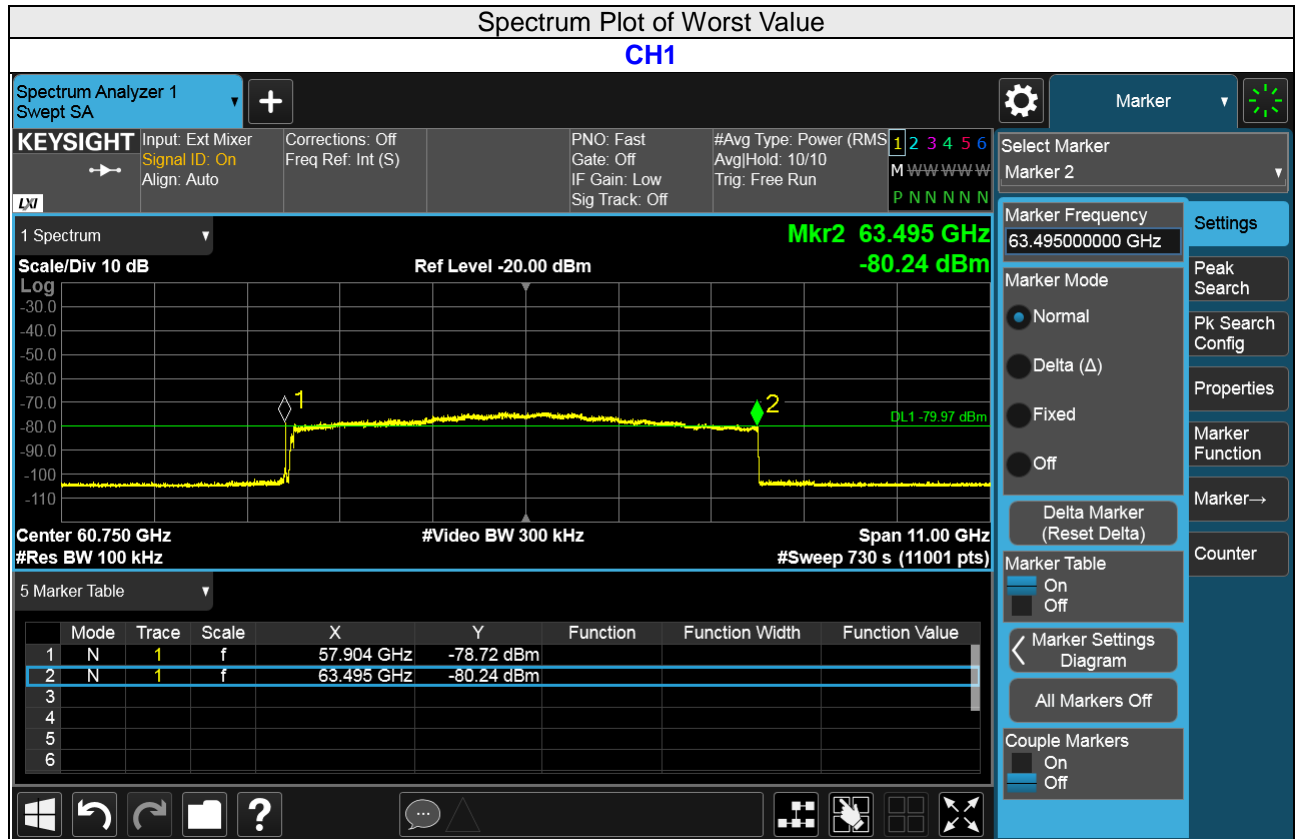

4.6 20dB Bandwidth Measurement

4.6.1 Applicable Rule and Limits of 20dB Bandwidth Measurement

Applicable Rule

§15.215 (c) Intentional radiators operating under the alternative provisions to the general emission limits, as contained in §§15.217 through 15.257 and in subpart E of this part, must be designed to ensure that the 20 dB bandwidth of the emission, or whatever bandwidth may otherwise be specified in the specific rule section under which the equipment operates, is contained within the frequency band designated in the rule section under which the equipment is operated. In the case of intentional radiators operating under the provisions of subpart E, the emission bandwidth may span across multiple contiguous frequency bands identified in that subpart. The requirement to contain the designated bandwidth of the emission within the specified frequency band includes the effects from frequency sweeping, frequency hopping and other modulation techniques that may be employed as well as the frequency stability of the transmitter over expected variations in temperature and supply voltage.

Per paragraph 14 of the associated waiver, FCC DA 18-1308, the device shall be certified for compliance with all the technical specifications applicable to operation under 47 CFR. Part 15, with the exception of the following provisions in: 1) 47 CFR § 15.255(c)(3), which is waived to allow the device to operate in the 57-64 GHz band at a maximum +13 dBm EIRP, +10 dBm transmitter conducted output power, and +13 dBm/MHz power spectral density;...

Limit

57 to 64 GHz

4.6.2 Test Setup

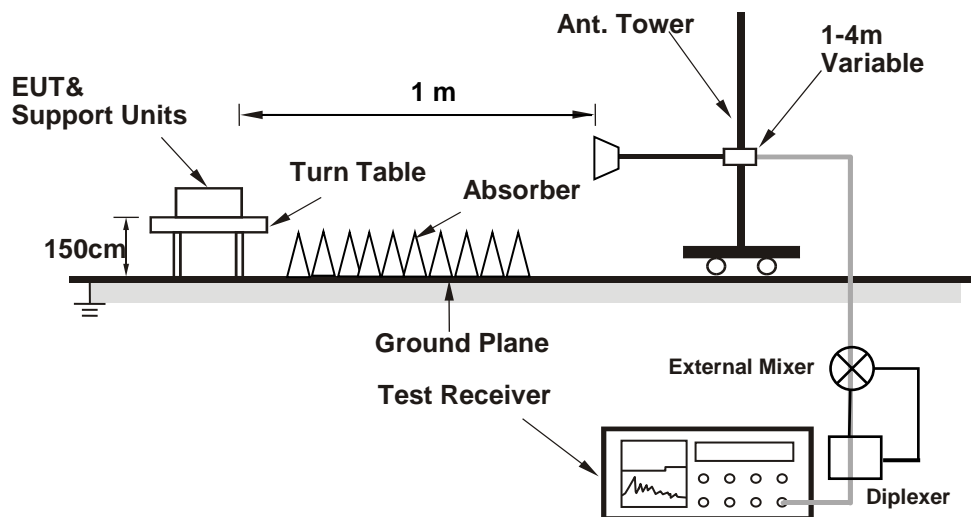

4.6.3 Test Procedure

The spectrum analyzer and external mixer are set up to measure the radiated output of the transmitter.

Follow ANSI C63.10 Clauses 9.3 and 9.14

The 20 dB bandwidth is measured at the reference condition of 20 deg C and 3.85 VDC.

4.6.4 Deviation from Test Standard

No deviation.

4.6.5 EUT Operating Conditions

Same as Item 4.1.5.

4.6.6 Test Result

Results at Reference 20 Deg C and 3.85 Vdc Condition

20 dB Bandwidth (GHz)	Low Frequency (GHz)	High Frequency (GHz)
5.558	57.950	63.508

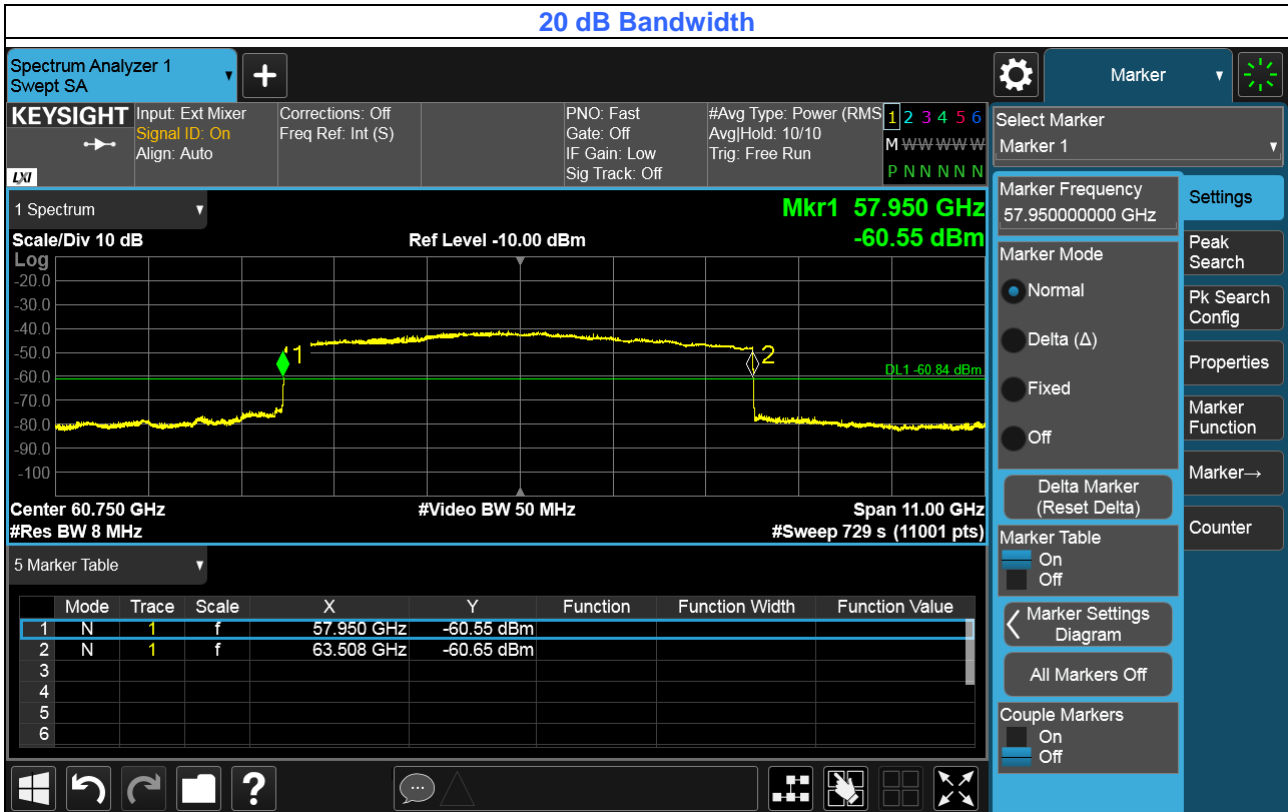

4.7 Frequency Stability Measurement

4.7.1 Applicable Rule and Limits of Frequency Stability Measurement

Applicable Rule

§15.255 (f) Fundamental emissions must be contained within the frequency bands specified in this section during all conditions of operation. Equipment is presumed to operate over the temperature range -20 to +50 degrees Celsius with an input voltage variation of 85% to 115% of rated input voltage, unless justification is presented to demonstrate otherwise.

Per paragraph 14 of the associated waiver, FCC DA 18-1308, the device shall be certified for compliance with all the technical specifications applicable to operation under 47 CFR, Part 15, with the exception of the following provisions in: 1) 47 CFR § 15.255(c)(3), which is waived to allow the device to operate in the 57-64 GHz band at a maximum +13 dBm EIRP, +10 dBm transmitter conducted output power, and +13 dBm/MHz power spectral density;...

Limit

57 to 64 GHz

4.7.2 Test Setup

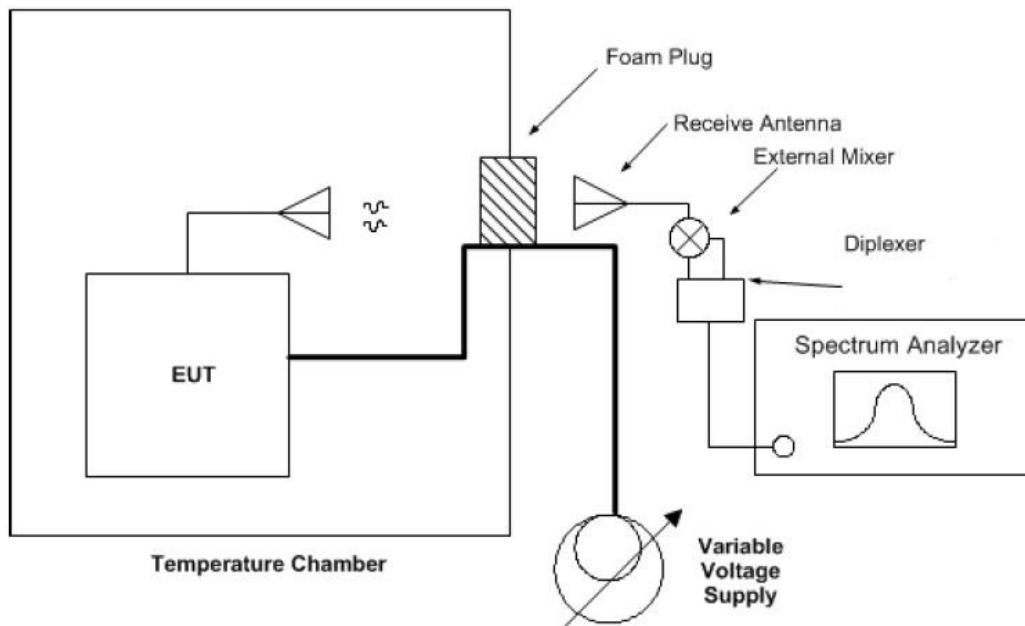

4.7.3 Test Procedure

The EUT is then placed in an environmental chamber and set to operate in a CW mode, with power furnished by an adjustable source. The carrier frequency is counted at each extreme condition and compared with the reference condition.

- a. Arrange EUT and test equipment as above setup configuration.
- b. With the EUT at ambient temperature and voltage source set to the EUT nominal operating voltage (100%), record the spectrum mask of the EUT emission on the spectrum analyzer.
- c. Vary EUT power supply between 85% and 115% of nominal, and record the frequency excursion of the EUT emission mask.
- d. Set the power supply to 100% nominal setting, and raise EUT operating temperature to 50 °C. Record the frequency excursion of the EUT emission mask.
- e. Repeat step d) at each 10 °C increment down to -20 °C

4.7.4 Deviation from Test Standard

No deviation.

4.7.5 EUT Operating Conditions

Same as Item 4.1.5.

4.7.6 Test Result

Delta over Temperature and Voltage Extremes

Low Frequency

Reference Condition: 3.85Vdc @ 20°C			
Power Supply (Vdc/Vac)	Environment Temperature (°C)	Frequency	Limit
		(MHz)	(GHz)
3.85	50	57945.6707	>57
3.85	40	57945.7576	>57
3.85	30	57946.1203	>57
3.85	20	57946.0000	>57
3.85	10	57946.0092	>57
3.85	0	57946.1503	>57
3.85	-10	57945.7401	>57
3.85	-20	57946.0758	>57
3.50	20	57946.0063	>57
4.40	20	57946.0074	>57

Note: When the voltage lower than 3.5V, the EUT can't operation.

High Frequency

Reference Condition: 3.85Vdc @ 20°C			
Power Supply (Vdc/Vac)	Environment Temperature (°C)	Frequency	Limit
		(MHz)	(GHz)
3.85	50	63508.6707	<64
3.85	40	63508.7576	<64
3.85	30	63509.1203	<64
3.85	20	63509.0000	<64
3.85	10	63509.0092	<64
3.85	0	63509.1503	<64
3.85	-10	63508.7401	<64
3.85	-20	63509.0758	<64
3.50	20	63509.0063	<64
4.40	20	63509.0074	<64

Note: When the voltage lower than 3.5V, the EUT can't operation.

4.8 99% Bandwidth Measurement

4.8.1 Limits of 99% Bandwidth Measurement

Limit

None: For reporting purposes only.

4.8.2 Test Setup

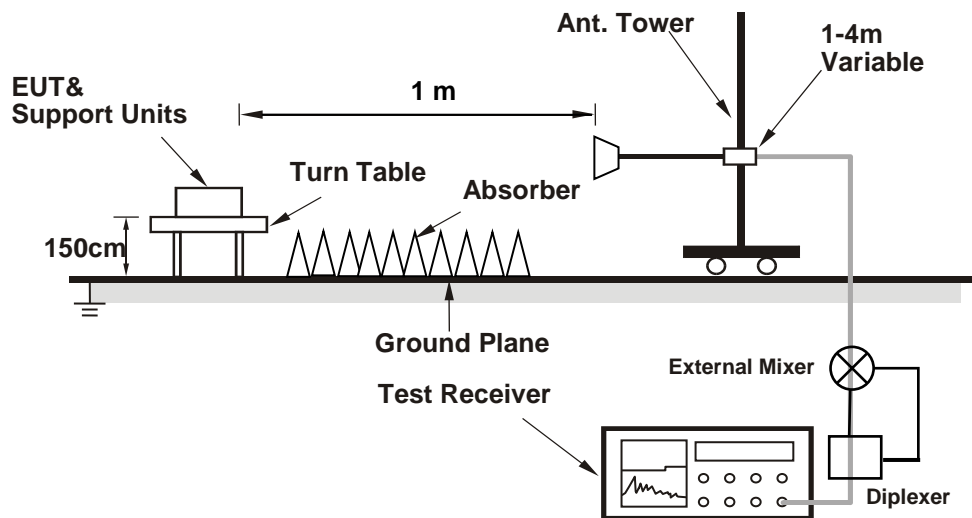

4.8.3 Test Procedure

The spectrum analyzer and external mixer are set up to measure the radiated output of the transmitter.

4.8.4 Deviation from Test Standard

No deviation.

4.8.5 EUT Operating Conditions

Same as Item 4.1.5.

4.8.6 Test Result

99% Bandwidth (GHz)
5.4145

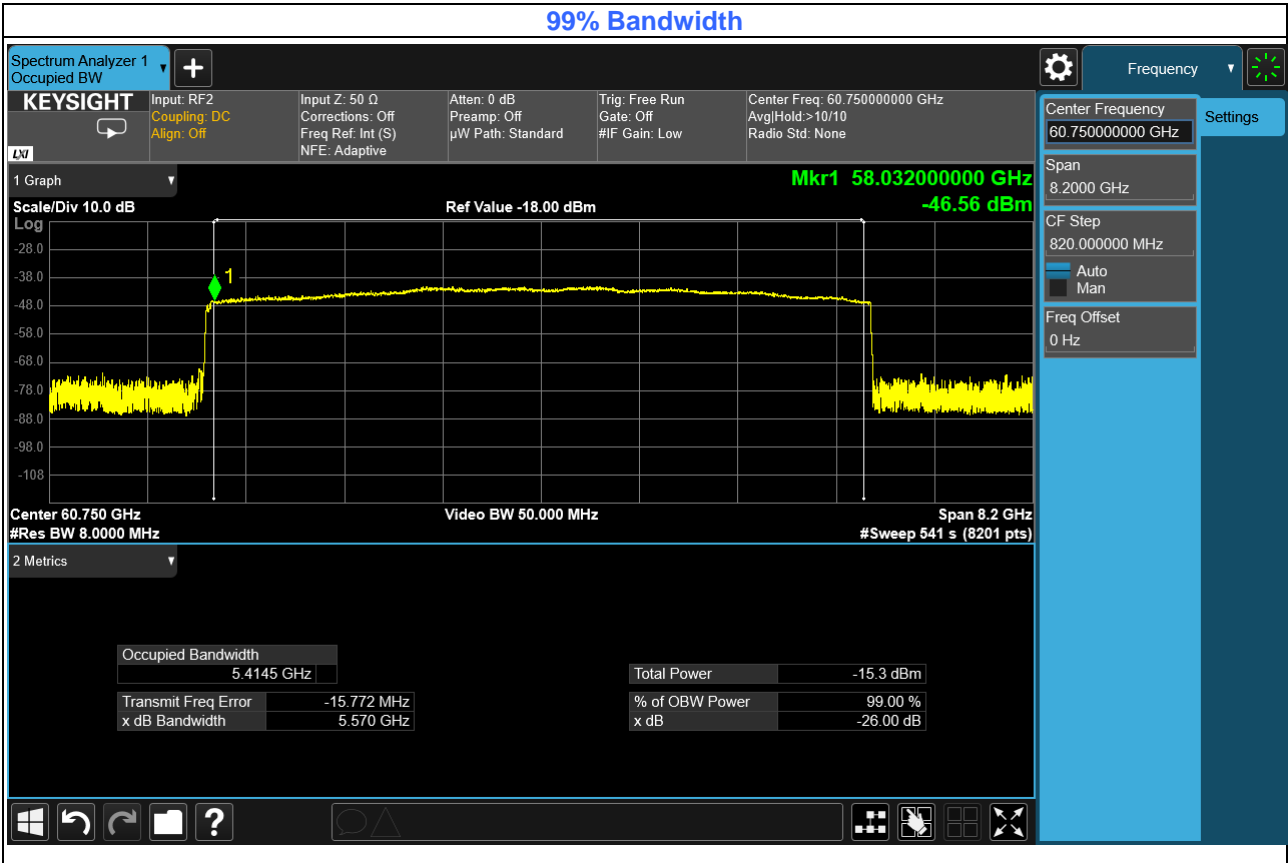

4.9 Peak Power Spectral Density Measurement

4.9.1 Applicable Rule and Limits of Peak Power Spectral Density Measurement

Applicable Rule

Per paragraph 14 of the associated waiver, FCC DA 18-1308, the device shall be certified for compliance with all the technical specifications applicable to operation under 47 CFR, Part 15, with the exception of the following provisions in: 1) 47 CFR § 15.255(c)(3), which is waived to allow the device to operate in the 57-64 GHz band at a maximum +13 dBm EIRP, +10 dBm transmitter conducted output power, and +13 dBm/MHz power spectral density;...

Limit

+13 dBm/MHz EIRP

4.9.2 Test Setup

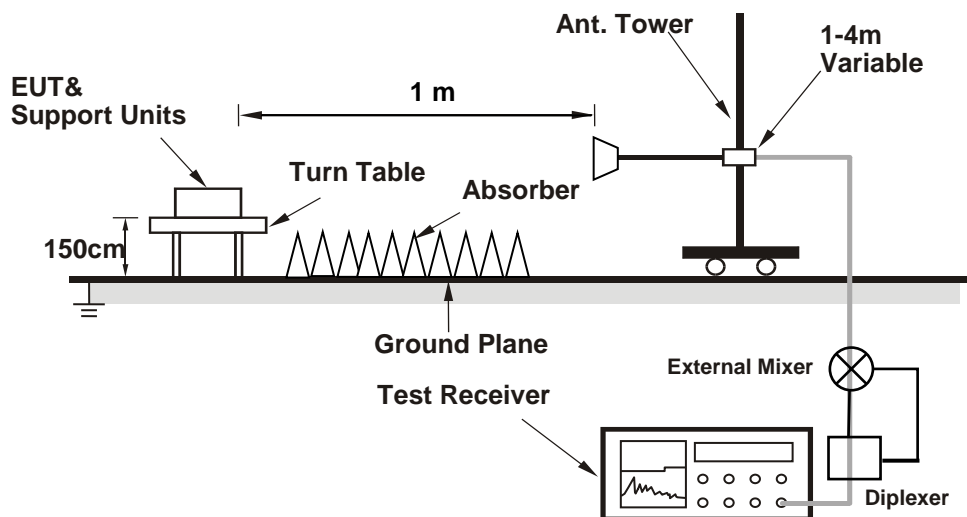

4.9.3 Test Procedures

ANSI C63.10 Clause 9.10

The fundamental signal is measured in far-field condition using a Standard Gain Horn Antenna, Low Noise Amplifier, Downconverter and Spectrum Analyzer (PXA).

Spectrum analyzer peak detector measurements are corrected for the decreased sensitivity that results when a CW signal is swept through the RBW filter at a high rate compared to the bandwidth squared.

The derivation of the FMCW Desensitization Factor is given in Keysight Application Note 5952- 1039 Appendix B.

$$\alpha = \frac{1}{\sqrt[4]{1 + \left(\frac{2\ln(2)}{\pi}\right)^2 \left(\frac{F_s}{T_s B^2}\right)^2}}$$

and

FMCW Desensitization Factor = 20 Log(α)

Where

F_s = FMCW Sweep Width or Chirp Width

T_s = FMCW Sweep Time

B = 3-dB bandwidth of Gaussian RBW Filter

4.9.4 Deviation from Test Standard

No deviation.

4.9.5 EUT Operating Conditions

Same as Item 4.1.5.

4.9.6 Offset Calculation

Follow FCC KDB 412172 Determining ERP and ERIP DR01

$$EIRP = Pr + Lp$$

$$Pr = P_{meas} - Gr + Lc + L_{atten} - G_{amp}$$

$$Lp = 20\log(f) + 20\log(d) - 27.5$$

$$EIRP = P_{meas} - Gr + Lc + L_{atten} - G_{amp} + 20\log(f) + 20\log(d) - 27.5$$

P_{meas} : Raw Reading for The Measurement (dBm)

Gr : Receiver Antenna Gain (dBi)

Lc : Cable Loss (dB)

L_{atten} : Attenuation Loss (dB)

G_{amp} : Amplifier Gain (dB)

The Offset Value at 61.048 GHz:

Gr (dBi)	Lc (dB)	Latten (dB)	Gamp (dB)	f (MHz)	d (m)	Desensitization Factor (dB)	Offset (dB)
21	7.23	0	0	61048	1	13.5	67.94

FMCW Desensitization Factor for RBW = 1 MHz

Start Freq (GHz)	Stop Freq (GHz)	FMCW Width (MHz)	Ramp Time (us)	Sweep Rate (MHz/us)	Sweep Rate (Hz/s)	RBW (MHz)	RBW (Hz)	Normalized Sweep Rate (lin)	Amplitude Loss (lin)	Amplitude Loss (dB)
58	63.5	5500	108.6	50.64	5.06E+13	1.00	1.00E+06	50.64	0.21	-13.5

4.9.7 Test Results

Peak Power Spectral Density

Freq. (GHz)	Measured Distance (m)	RBW (MHz)	Norm. Swp Rate Corr Factor (dB)	Peak PSD (dBm/MHz EIRP)	Peak PSD Limit (dBm/MHz EIRP)	Margin (dB)
61.048	1.0	1	13.5	11.57	13.00	-1.43

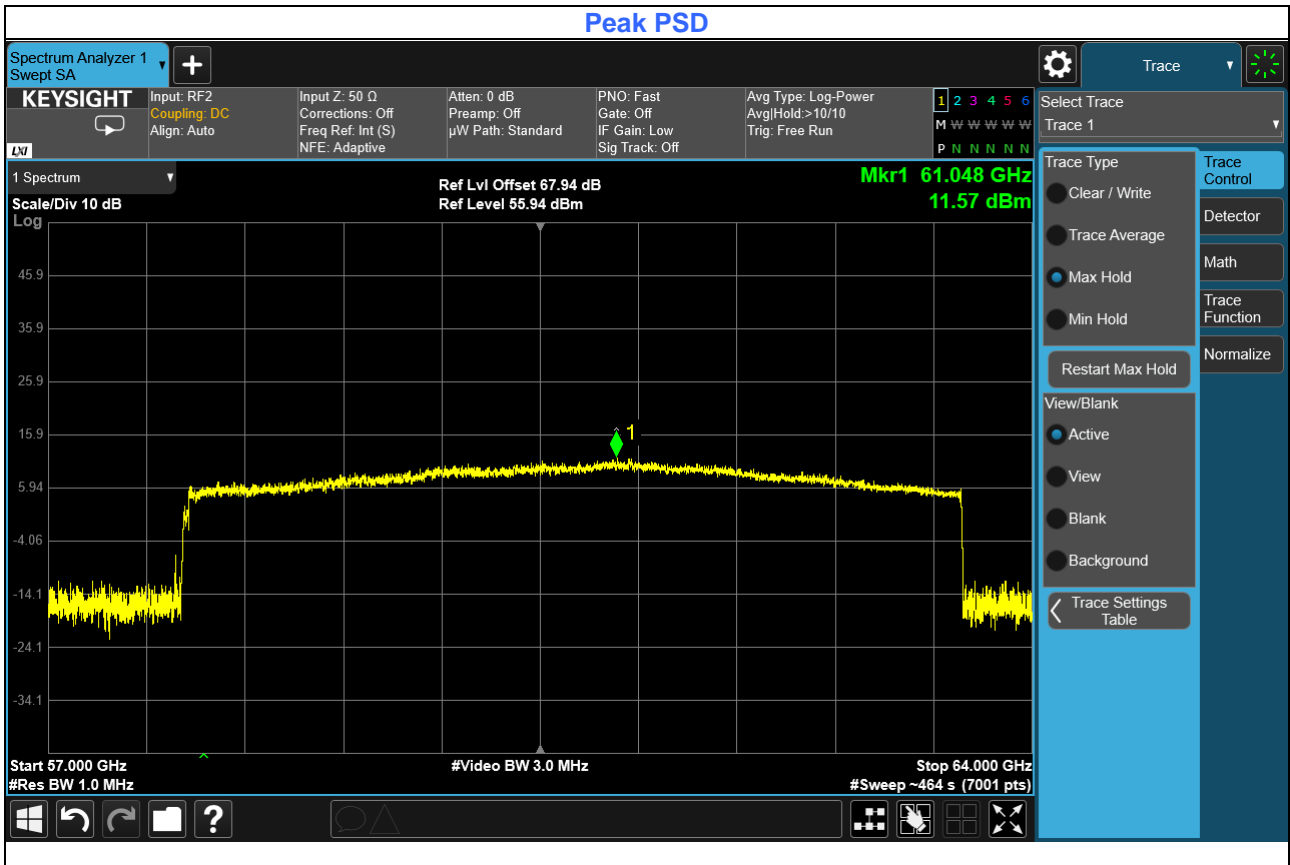

5 Pictures of Test Arrangements

Please refer to the attached file (Test Setup Photo).

Appendix – Information of the Testing Laboratories

We, Bureau Veritas Consumer Products Services (H.K.) Ltd., Taoyuan Branch, were founded in 1988 to provide our best service in EMC, Radio, Telecom and Safety consultation. Our laboratories are FCC recognized accredited test firms and accredited according to ISO/IEC 17025.

If you have any comments, please feel free to contact us at the following:

Lin Kou EMC/RF Lab

Tel: 886-2-26052180

Fax: 886-2-26051924

Hsin Chu EMC/RF/Telecom Lab

Tel: 886-3-6668565

Fax: 886-3-6668323

Hwa Ya EMC/RF/Safety Lab

Tel: 886-3-3183232

Fax: 886-3-3270892

Email: service.adt@tw.bureauveritas.com

Web Site: www.bureauveritas-adt.com

The address and road map of all our labs can be found in our web site also.

--- END ---