



# FCC RADIO TEST REPORT

FCC ID : A4RG020H  
Equipment : Smartphone  
Model Name : G020H  
Applicant : Google LLC  
1600 Amphitheatre Parkway,  
Mountain View, CA 94043, USA  
Standard : FCC Part 15 Subpart C §15.247

The product was completed on Dec. 25, 2018. We, SPORTON INTERNATIONAL INC. EMC & Wireless Communications Laboratory, would like to declare that the tested sample has been evaluated in accordance with the test procedures and has been in compliance with the applicable technical standards.

The report must not be used by the client to claim product certification, approval, or endorsement by TAF or any agency of government.

The test results in this report apply exclusively to the tested model / sample. Without written approval of SPORTON INTERNATIONAL INC. EMC & Wireless Communications Laboratory, the test report shall not be reproduced except in full.

Approved by: Jones Tsai

**SPORTON INTERNATIONAL INC. EMC & Wireless Communications Laboratory**

No. 52, Huaya 1st Rd., Guishan Dist., Taoyuan City, Taiwan (R.O.C.)



# Table of Contents

**History of this test report ..... 3**

**Summary of Test Result..... 4**

**1 General Description ..... 5**

    1.1 Product Feature of Equipment Under Test ..... 5

    1.2 Product Specification of Equipment Under Test..... 5

    1.3 Modification of EUT ..... 5

    1.4 Testing Location..... 6

    1.5 Applicable Standards ..... 6

**2 Test Configuration of Equipment Under Test..... 7**

    2.1 Carrier Frequency Channel ..... 7

    2.2 Test Mode..... 8

    2.3 Connection Diagram of Test System ..... 9

    2.4 Support Unit used in test configuration and system ..... 10

    2.5 EUT Operation Test Setup ..... 10

    2.6 Measurement Results Explanation Example..... 10

**3 Test Result ..... 11**

    3.1 6dB and 99% Bandwidth Measurement..... 11

    3.2 Output Power Measurement..... 18

    3.3 Power Spectral Density Measurement..... 19

    3.4 Conducted Band Edges and Spurious Emission Measurement ..... 26

    3.5 Radiated Band Edges and Spurious Emission Measurement ..... 35

    3.6 AC Conducted Emission Measurement ..... 39

    3.7 Antenna Requirements..... 41

**4 List of Measuring Equipment ..... 42**

**5 Uncertainty of Evaluation ..... 44**

**Appendix A. Conducted Test Results**

**Appendix B. AC Conducted Emission Test Result**

**Appendix C. Radiated Spurious Emission**

**Appendix D. Radiated Spurious Emission Plots**

**Appendix E. Duty Cycle Plots**



### History of this test report

Report No.	Version	Description	Issued Date
FR891148-01B	01	Initial issue of report	Dec. 26, 2018



## Summary of Test Result

Report Clause	Ref Std. Clause	Test Items	Result (PASS/FAIL)	Remark
3.1	15.247(a)(2)	6dB Bandwidth	Pass	-
3.1	2.1049	99% Occupied Bandwidth	Reporting only	-
3.2	15.247(b)(3)	Peak Output Power	Pass	-
3.3	15.247(e)	Power Spectral Density	Pass	-
3.4	15.247(d)	Conducted Band Edges and Spurious Emission	Pass	-
3.5	15.247(d)	Radiated Band Edges and Spurious Emission	Pass	Under limit 5.10 dB at 30.000 MHz
3.6	15.207	AC Conducted Emission	Pass	Under limit 14.51 dB at 0.168 MHz
3.7	15.203 & 15.247(b)	Antenna Requirement	Pass	-

**Reviewed by: Wii Chang**

**Report Producer: Natasha Hsieh**



# 1 General Description

## 1.1 Product Feature of Equipment Under Test

Product Feature	
Equipment	Smartphone
Model Name	G020H
Sample 1	The device with 1st battery
Sample 2	The device with 2nd battery
EUT supports Radios application	GSM/EGPRS/WCDMA/HSPA/LTE/NFC/GNSS WLAN 11b/g/n HT20 WLAN 11a/n HT20/HT40 WLAN 11ac VHT20/VHT40/VHT80 Bluetooth BR/EDR/LE
EUT Stage	Identical Prototype

Remark: The above EUT's information was declared by manufacturer.

## 1.2 Product Specification of Equipment Under Test

Standards-related Product Specification	
Tx/Rx Frequency Range	2402 MHz ~ 2480 MHz
Number of Channels	40
Carrier Frequency of Each Channel	40 Channel(37 hopping + 3 advertising channel)
Maximum Output Power to Antenna	Bluetooth LE (1Mbps) : 9.79 dBm (0.0095 W) Bluetooth LE (2Mbps) : 9.99 dBm (0.0100 W)
99% Occupied Bandwidth	Bluetooth LE (1Mbps) : 1.020 MHz Bluetooth LE (2Mbps) : 2.030 MHz
Antenna Type / Gain	PIFA Antenna type with gain -0.6 dBi
Type of Modulation	Bluetooth LE : GFSK

## 1.3 Modification of EUT

No modifications are made to the EUT during all test items.



### 1.4 Testing Location

Sporton Lab is accredited to ISO 17025 by Taiwan Accreditation Foundation (TAF code : 1190) and the FCC designation No. TW1190 and TW0007 under the FCC 2.948(e) by Mutual Recognition Agreement (MRA) in FCC Test.

<b>Test Site</b>	SPORTON INTERNATIONAL INC.		
<b>Test Site Location</b>	No.52, Huaya 1st Rd., Guishan Dist., Taoyuan City, Taiwan (R.O.C.) TEL: +886-3-327-3456 FAX: +886-3-328-4978		
<b>Test Site No.</b>	<b>Sporton Site No.</b>		
	TH05-HY	CO05-HY	03CH07-HY

**Note:** The test site complies with ANSI C63.4 2014 requirement.

### 1.5 Applicable Standards

According to the specifications of the manufacturer, the EUT must comply with the requirements of the following standards:

- ♦ FCC Part 15 Subpart C §15.247
- ♦ FCC KDB Publication No. 558074 D01 DTS Meas. Guidance v05
- ♦ FCC KDB 414788 D01 Radiated Test Site v01r01.
- ♦ ANSI C63.10-2013

**Remark:**

1. All test items were verified and recorded according to the standards and without any deviation during the test.
2. This EUT has also been tested and complied with the requirements of FCC Part 15, Subpart B, recorded in a separate test report.



## 2 Test Configuration of Equipment Under Test

### 2.1 Carrier Frequency Channel

Frequency Band	Channel	Freq. (MHz)	Channel	Freq. (MHz)
2400-2483.5 MHz	0	2402	21	2444
	1	2404	22	2446
	2	2406	23	2448
	3	2408	24	2450
	4	2410	25	2452
	5	2412	26	2454
	6	2414	27	2456
	7	2416	28	2458
	8	2418	29	2460
	9	2420	30	2462
	10	2422	31	2464
	11	2424	32	2466
	12	2426	33	2468
	13	2428	34	2470
	14	2430	35	2472
	15	2432	36	2474
	16	2434	37	2476
	17	2436	38	2478
	18	2438	39	2480
	19	2440	-	-
20	2442	-	-	



## 2.2 Test Mode

- a. The EUT has been associated with peripherals and configuration operated in a manner tended to maximize its emission characteristics in a typical application. Frequency range investigated: conduction emission (150 kHz to 30 MHz), radiation emission (9 kHz to the 10th harmonic of the highest fundamental frequency or to 40 GHz, whichever is lower). For radiated measurement, pre-scanned in three orthogonal panels, X, Y, Z. The worst cases (Z Plane for Sample 1 and X Plane for Sample 2) were recorded in this report.
- b. AC power line Conducted Emission was tested under maximum output power.

The following summary table is showing all test modes to demonstrate in compliance with the standard.

Summary table of Test Cases	
Test Item	Data Rate / Modulation
	Bluetooth – LE / GFSK
<b>Conducted Test Cases</b>	Mode 1: Bluetooth Tx CH00_2402 MHz_1Mbps Mode 2: Bluetooth Tx CH19_2440 MHz_1Mbps Mode 3: Bluetooth Tx CH39_2480 MHz_1Mbps Mode 4: Bluetooth Tx CH00_2402 MHz_2Mbps Mode 5: Bluetooth Tx CH19_2440 MHz_2Mbps Mode 6: Bluetooth Tx CH39_2480 MHz_2Mbps
<b>Radiated Test Cases</b>	Mode 1: Bluetooth Tx CH00_2402 MHz_1Mbps Mode 2: Bluetooth Tx CH19_2440 MHz_1Mbps Mode 3: Bluetooth Tx CH39_2480 MHz_1Mbps Mode 4: Bluetooth Tx CH00_2402 MHz_2Mbps Mode 5: Bluetooth Tx CH19_2440 MHz_2Mbps Mode 6: Bluetooth Tx CH39_2480 MHz_2Mbps
<b>AC Conducted Emission</b>	Mode 1: GSM850 Idle + Bluetooth Link + WLAN (2.4GHz) Link + GPS Rx + Earphone + USB Type C Cable 1 (Charging form Adapter 1) + Battery<10% for Sample 1
<b>Remark:</b> For Radiated Test Cases, the tests were performed with USB Type C Cable 1.	



## 2.3 Connection Diagram of Test System

<Bluetooth-LE Tx Mode>

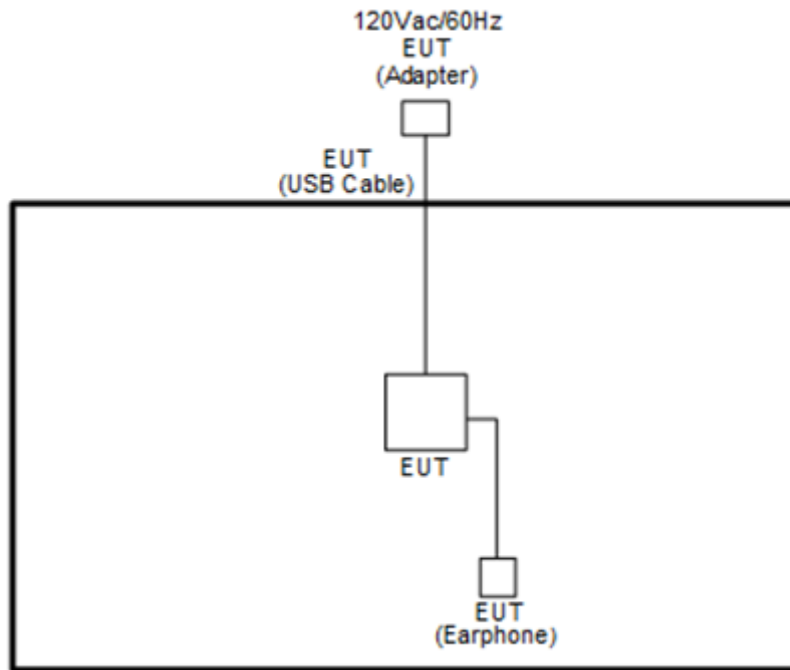

<AC Conducted Emissions Mode>

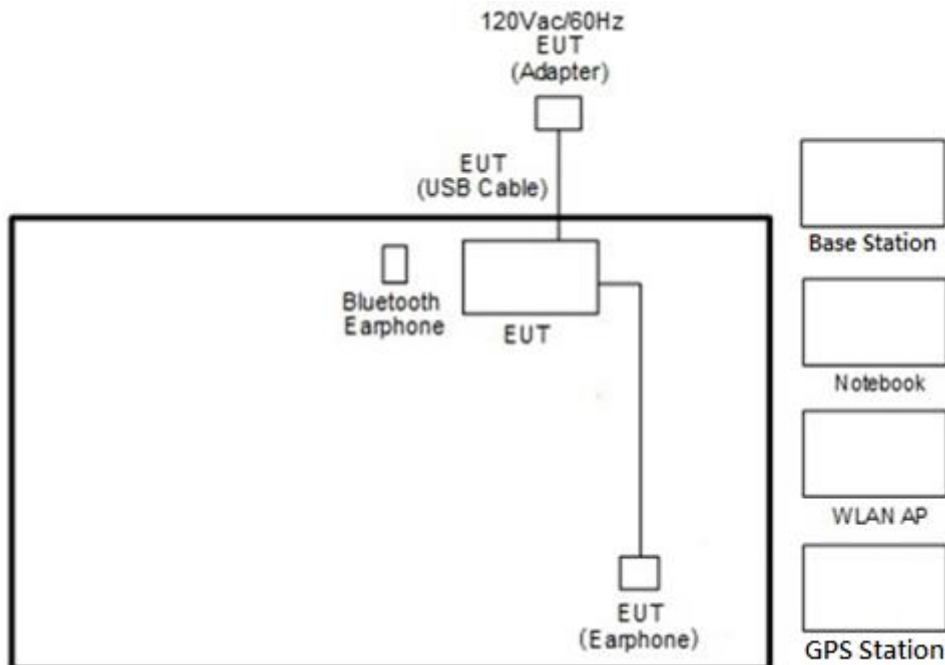



## 2.4 Support Unit used in test configuration and system

Item	Equipment	Trade Name	Model Name	FCC ID	Data Cable	Power Cord
1.	System Simulator	Anritsu	MT8820C	N/A	N/A	Unshielded, 1.8 m
2.	Bluetooth Base Station	R&S	CBT32	N/A	N/A	Unshielded, 1.8 m
3.	GPS Station	Pendulum	GSG-54	N/A	N/A	Unshielded, 1.8m
4.	Bluetooth Earphone	Sony	SBH20	PY7-RD0010	N/A	N/A
5.	WLAN AP	ASUS	RT-AC66U	MSQ-RTAC66U	N/A	Unshielded, 1.8m
6.	Notebook	DELL	Latitude E6320	FCC DoC/ Contains FCC ID: QDS-BRCM1054	N/A	AC I/P: Unshielded, 1.2 m DC O/P: Shielded, 1.8 m

## 2.5 EUT Operation Test Setup

The RF test items, utility “QRCT” was installed in Notebook which was programmed in order to make the EUT get into the engineering modes to provide channel selection, power level, data rate and the application type and for continuous transmitting signals.

## 2.6 Measurement Results Explanation Example

For all conducted test items:

The offset level is set in the spectrum analyzer to compensate the RF cable loss and attenuator factor between EUT conducted output port and spectrum analyzer. With the offset compensation, the spectrum analyzer reading level is exactly the EUT RF output level.

Example :

The spectrum analyzer offset is derived from RF cable loss and attenuator factor.

*Offset = RF cable loss + attenuator factor.*

Following shows an offset computation example with cable loss 4.2 dB and 10dB attenuator.

$$\begin{aligned} \text{Offset(dB)} &= \text{RF cable loss(dB)} + \text{attenuator factor(dB)}. \\ &= 4.2 + 10 = 14.2 \text{ (dB)} \end{aligned}$$

### 3 Test Result

#### 3.1 6dB and 99% Bandwidth Measurement

##### 3.1.1 Limit of 6dB and 99% Bandwidth

The minimum 6 dB bandwidth shall be at least 500 kHz.

##### 3.1.2 Measuring Instruments

See list of measuring equipment of this test report.

##### 3.1.3 Test Procedures

1. The testing follows the ANSI C63.10 Section 6.9.3 (OBW) and 11.8.1 (6dB BW).
2. The RF output of EUT was connected to the spectrum analyzer by RF cable and attenuator. The path loss was compensated to the results for each measurement.
3. Set to the maximum power setting and enable the EUT transmit continuously.
4. Make the measurement with the spectrum analyzer's resolution bandwidth (RBW) = 100 kHz. Set the Video bandwidth (VBW) = 300 kHz. In order to make an accurate measurement. The 6 dB bandwidth must be greater than 500 kHz.
5. For 99% Bandwidth Measurement, the spectrum analyzer's resolution bandwidth (RBW) is set 1-5% of the emission bandwidth and set the Video bandwidth (VBW)  $\geq 3 * RBW$ .
6. Measure and record the results in the test report.

##### 3.1.4 Test Setup





### 3.1.5 Test Result of 6dB Bandwidth

Please refer to Appendix A.

<1Mbps>

#### 6 dB Bandwidth Plot on Channel 00

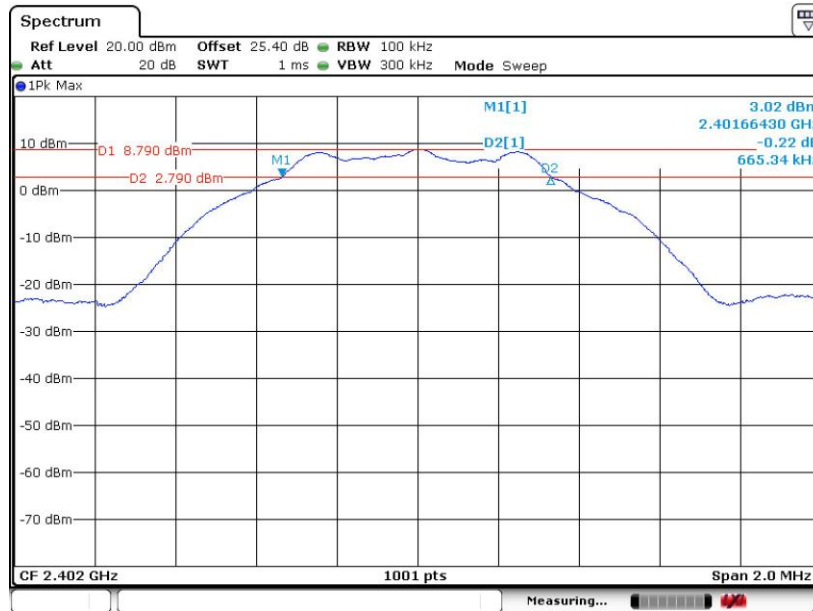

Date: 10.OCT.2018 01:06:02

#### 6 dB Bandwidth Plot on Channel 19

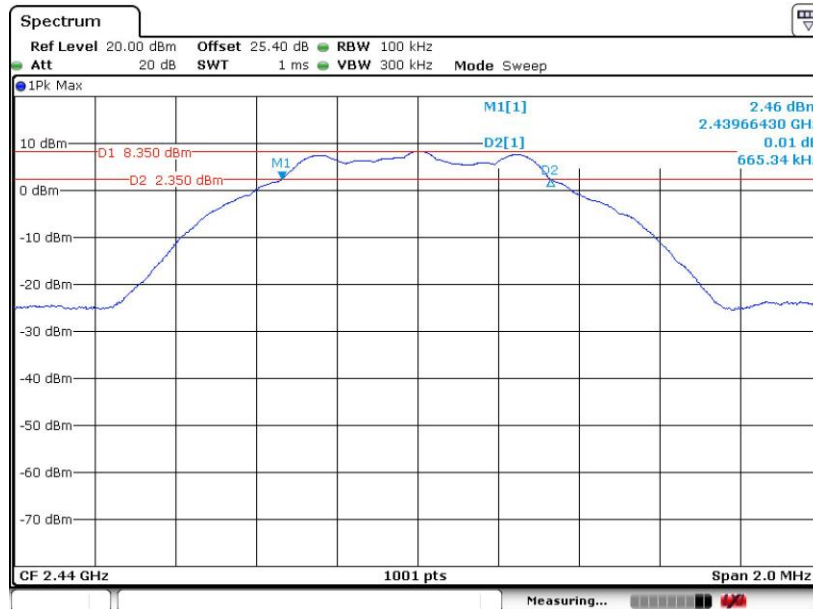

Date: 10.OCT.2018 01:04:09



6 dB Bandwidth Plot on Channel 39

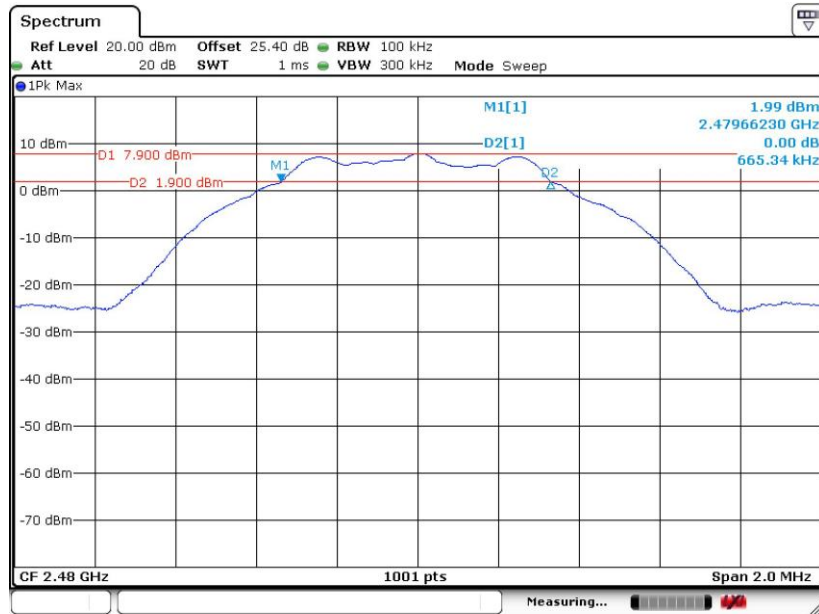

Date: 10.OCT.2018 01:01:46

<2Mbps>

6 dB Bandwidth Plot on Channel 00

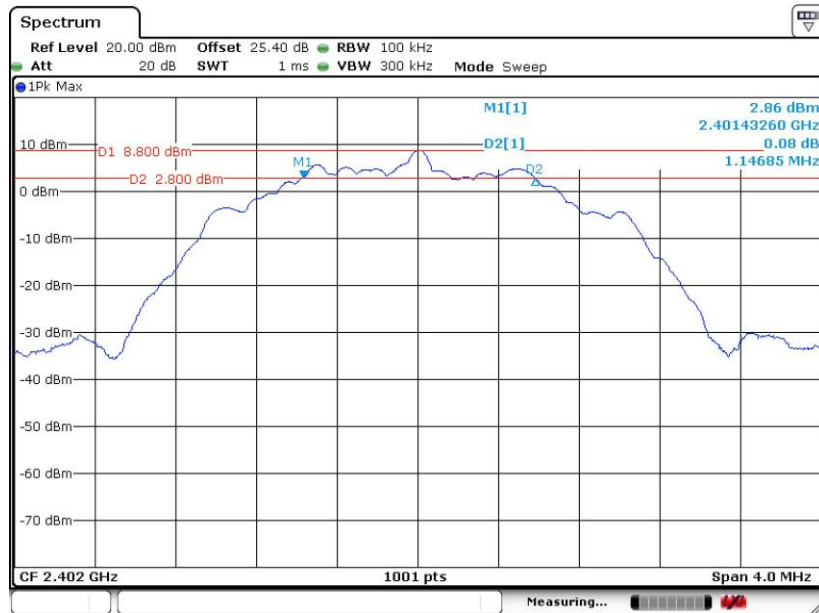

Date: 10.OCT.2018 00:46:22



6 dB Bandwidth Plot on Channel 19

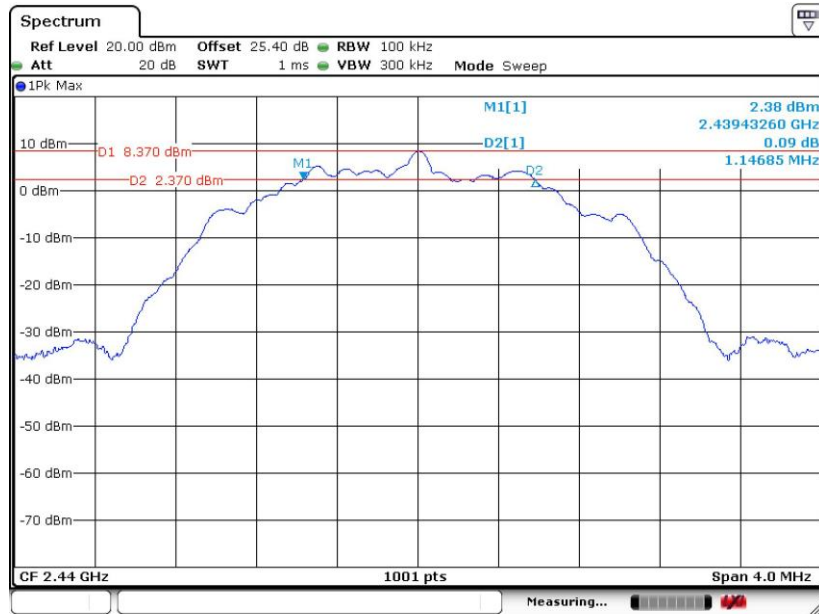

Date: 10.OCT.2018 00:52:20

6 dB Bandwidth Plot on Channel 39

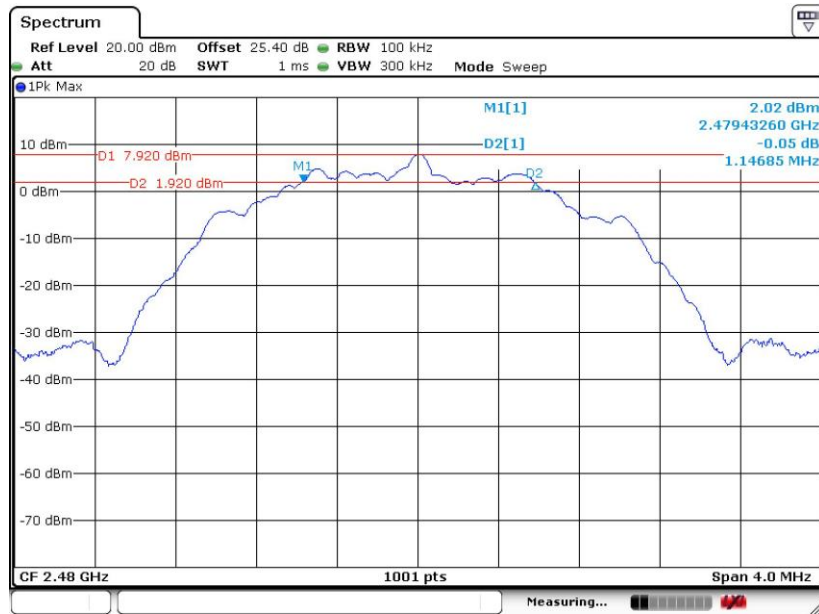

Date: 10.OCT.2018 00:58:55



### 3.1.6 Test Result of 99% Occupied Bandwidth

Please refer to Appendix A.

<1Mbps>

#### 99% Bandwidth Plot on Channel 00

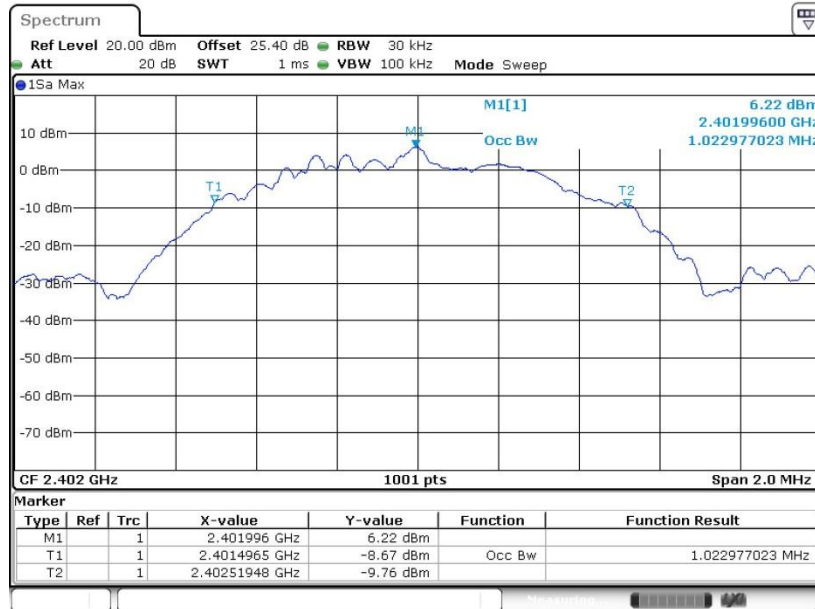

Date: 10.OCT.2018 01:07:43

#### 99% Occupied Bandwidth Plot on Channel 19

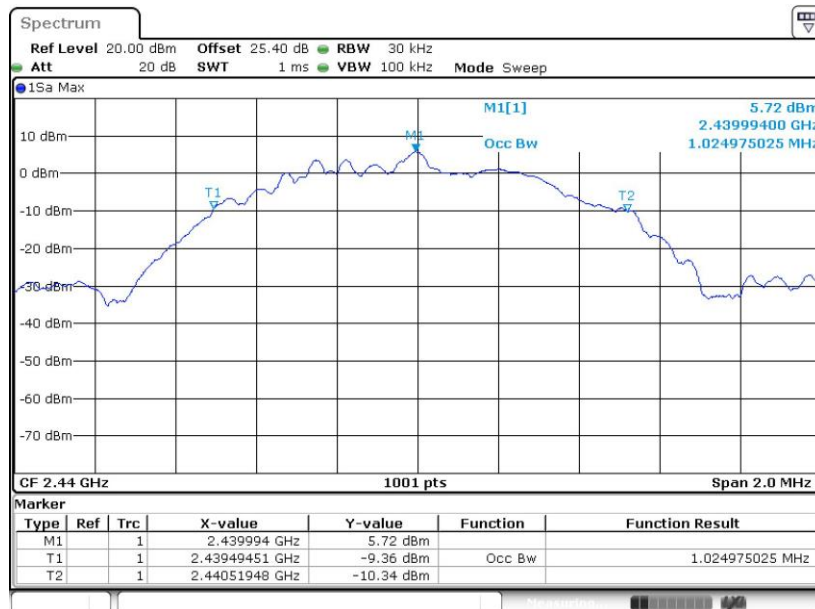

Date: 10.OCT.2018 01:05:16



99% Occupied Bandwidth Plot on Channel 39

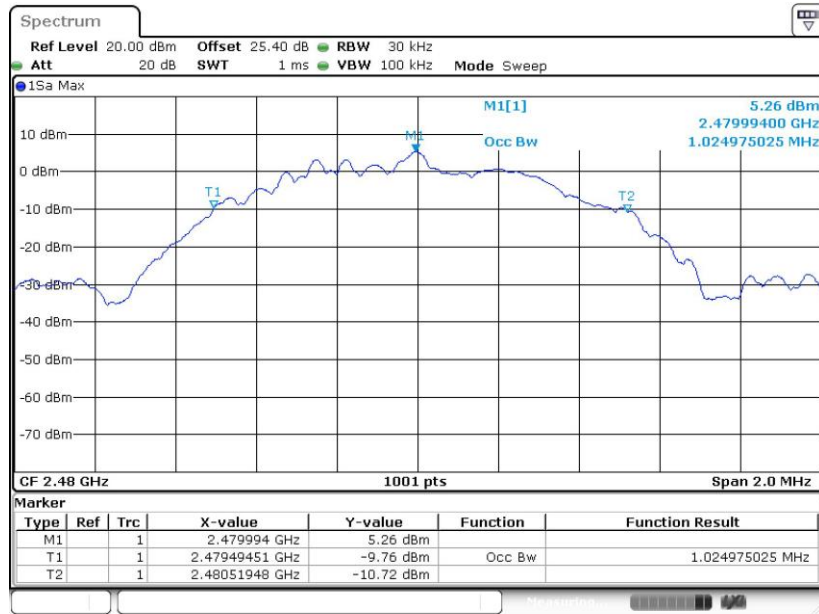

Date: 10.OCT.2018 01:03:23

<2Mbps>

99% Bandwidth Plot on Channel 00

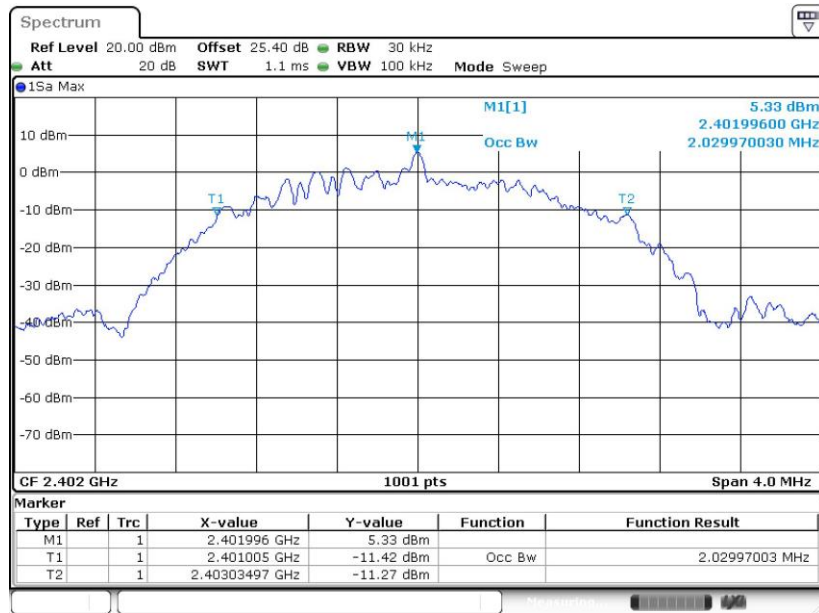

Date: 10.OCT.2018 00:51:21





99% Occupied Bandwidth Plot on Channel 19

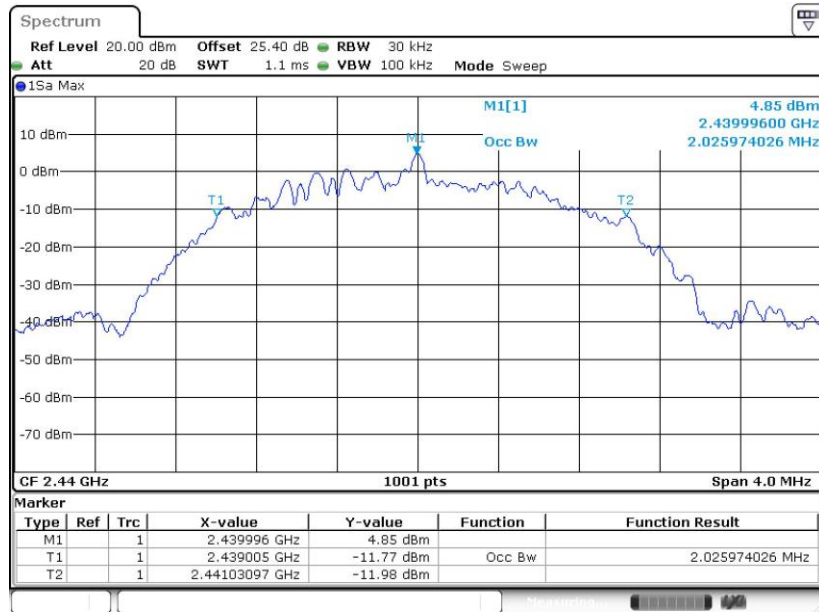

Date: 10.OCT.2018 00:57:51

99% Occupied Bandwidth Plot on Channel 39

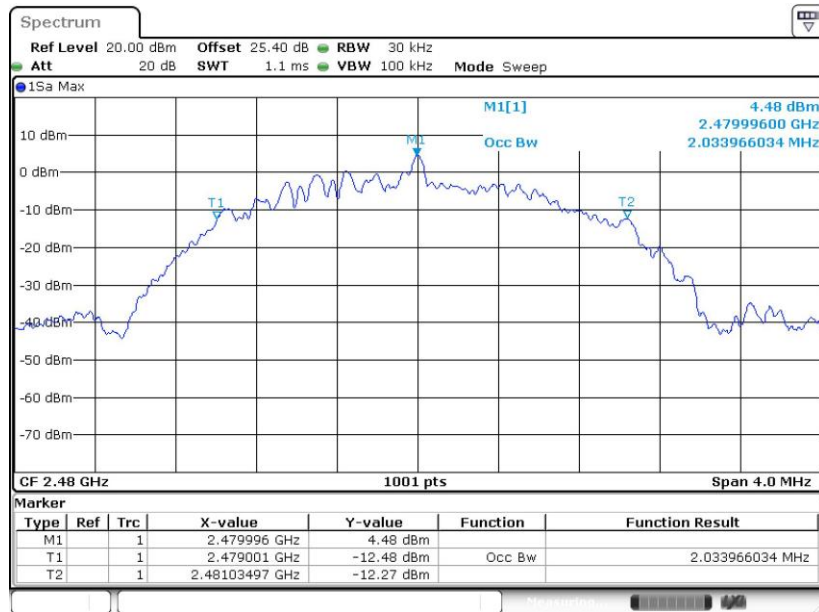

Date: 10.OCT.2018 00:58:17

Note : The occupied channel bandwidth is maintained within the band of operation for all of the modulations.

## 3.2 Output Power Measurement

### 3.2.1 Limit of Output Power

For systems using digital modulation in the 2400-2483.5MHz, the limit for peak output power is 30dBm. If transmitting antenna of directional gain greater than 6dBi is used, the peak output power from the intentional radiator shall be reduced below the above stated value by the amount in dB that the directional gain of the antenna exceeds 6 dBi. In case of point-to-point operation, the limit has to be reduced by 1dB for every 3dB that the directional gain of the antenna exceeds 6dBi.

### 3.2.2 Measuring Instruments

See list of measuring equipment of this test report.

### 3.2.3 Test Procedures

1. For Peak Power, the testing follows ANSI C63.10 Section 11.9.1.3 PKPM1.
2. For Average Power, the testing follows the Measurement Procedure of FCC KDB No. 558074 DTS D01 Meas. Guidance v05 section 9.2.3.1 Method AVGPM.
3. The RF output of EUT was connected to the power meter by RF cable and attenuator.
4. The path loss was compensated to the results for each measurement.
5. Set to the maximum power setting and enable the EUT transmit continuously.
6. Measure the conducted output power and record the results in the test report.

### 3.2.4 Test Setup

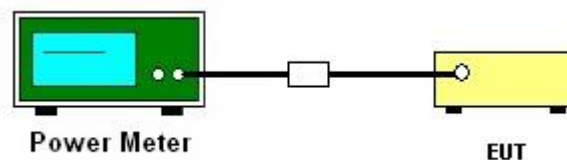

### 3.2.5 Test Result of Peak Output Power

Please refer to Appendix A.

### 3.2.6 Test Result of Average Output Power (Reporting Only)

Please refer to Appendix A.

### 3.3 Power Spectral Density Measurement

#### 3.3.1 Limit of Power Spectral Density

The peak power spectral density shall not be greater than 8dBm in any 3kHz band at any time interval of continuous transmission.

#### 3.3.2 Measuring Instruments

See list of measuring equipment of this test report.

#### 3.3.3 Test Procedures

1. The testing follows the ANSI C63.10 Section 11.10.2 Method PKPSD.
2. The RF output of EUT was connected to the spectrum analyzer by RF cable and attenuator. The path loss was compensated to the results for each measurement.
3. Set to the maximum power setting and enable the EUT transmit continuously.
4. Make the measurement with the spectrum analyzer's resolution bandwidth (RBW) = 3 kHz. Video bandwidth VBW = 10 kHz In order to make an accurate measurement, set the span to 1.5 times DTS Channel Bandwidth. (6dB BW)
5. Detector = peak, Sweep time = auto couple, Trace mode = max hold, Allow trace to fully stabilize. Use the peak marker function to determine the maximum power level.
6. Measure and record the results in the test report.
7. The Measured power density (dBm)/ 100kHz is a reference level and used as 20dBc down limit line for Conducted Band Edges and Conducted Spurious Emission.

#### 3.3.4 Test Setup

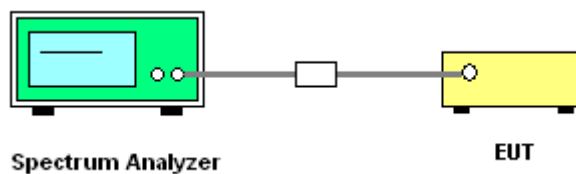

#### 3.3.5 Test Result of Power Spectral Density

Please refer to Appendix A.



### 3.3.6 Test Result of Power Spectral Density Plots (100kHz)

<1Mbps>

PSD 100kHz Plot on Channel 00

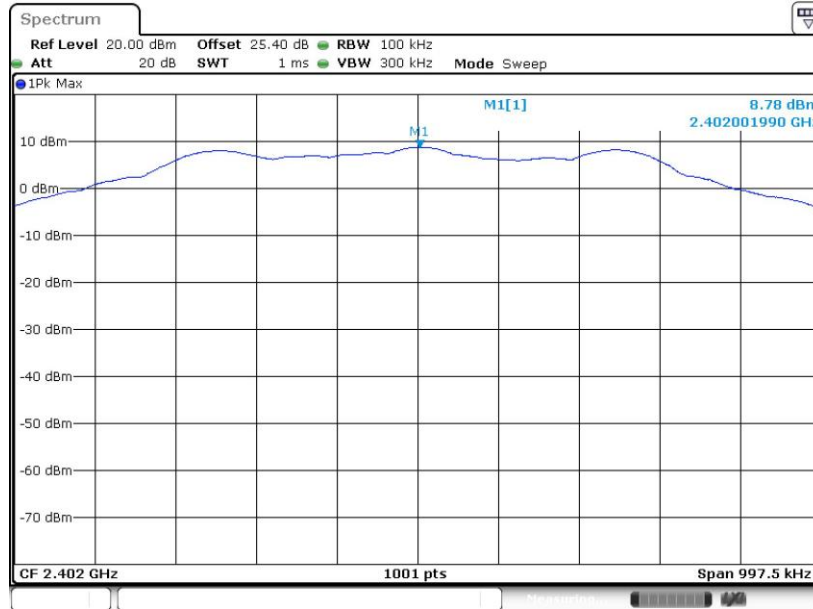

Date: 10.OCT.2018 01:06:36

PSD 100kHz Plot on Channel 19

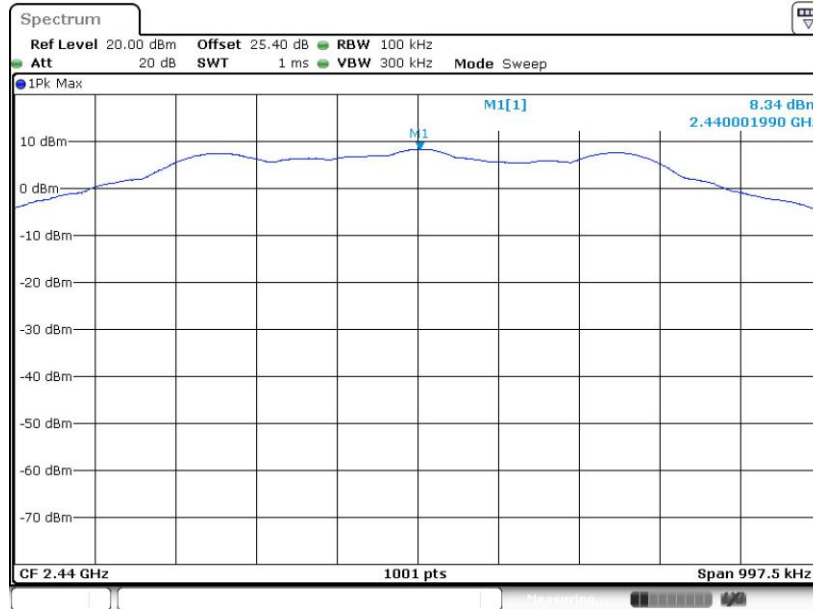

Date: 10.OCT.2018 01:04:32



PSD 100kHz Plot on Channel 39

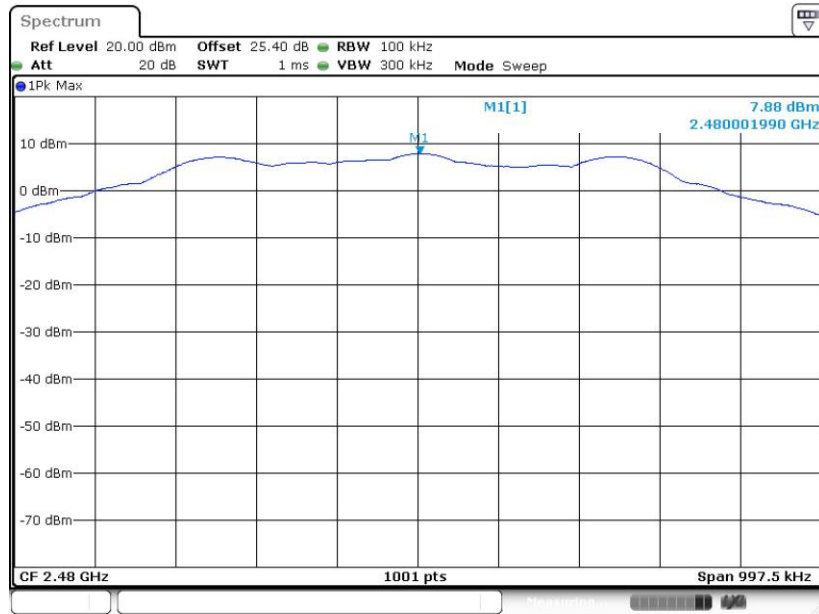

Date: 10.OCT.2018 01:02:14

<2Mbps>

PSD 100kHz Plot on Channel 00

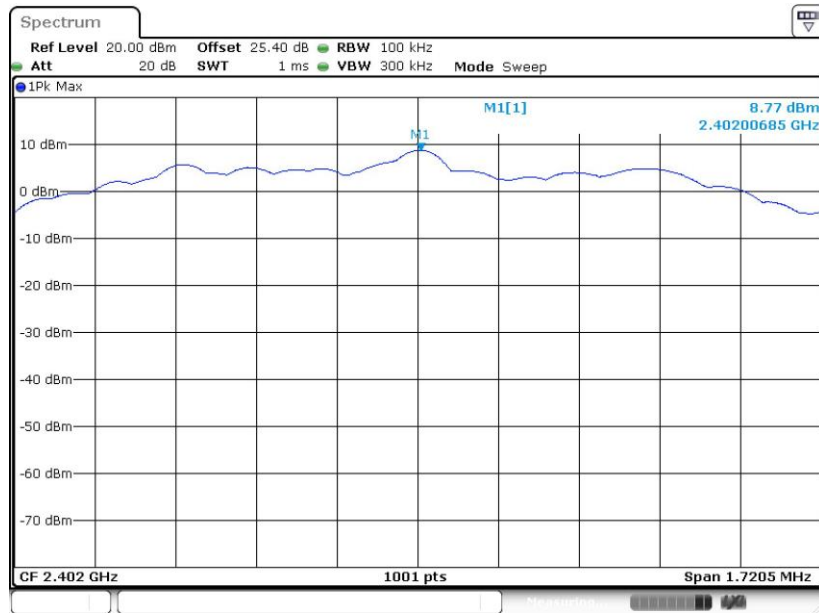

Date: 10.OCT.2018 00:49:42



PSD 100kHz Plot on Channel 19

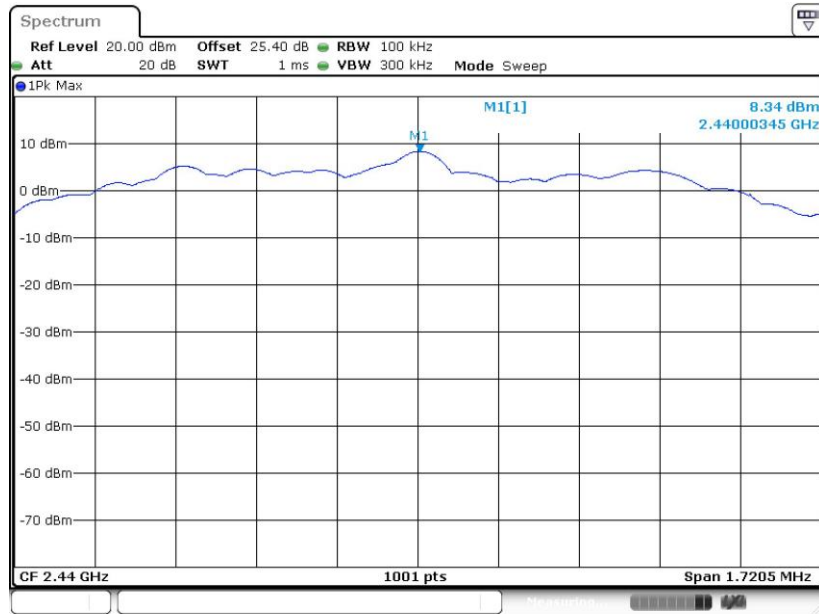

Date: 10.OCT.2018 00:53:57

PSD 100kHz Plot on Channel 39

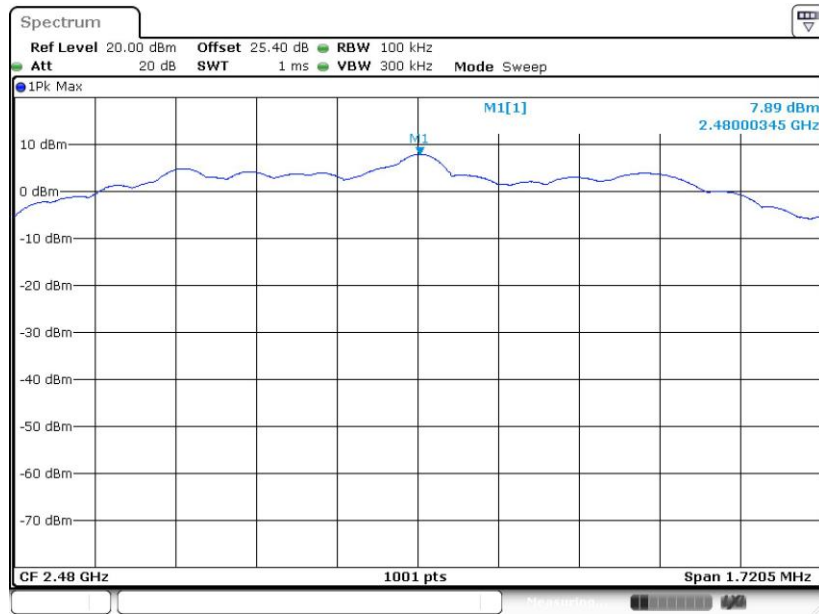

Date: 10.OCT.2018 00:59:19



### 3.3.7 Test Result of Power Spectral Density Plots (3kHz)

<1Mbps>

PSD 3kHz Plot on Channel 00

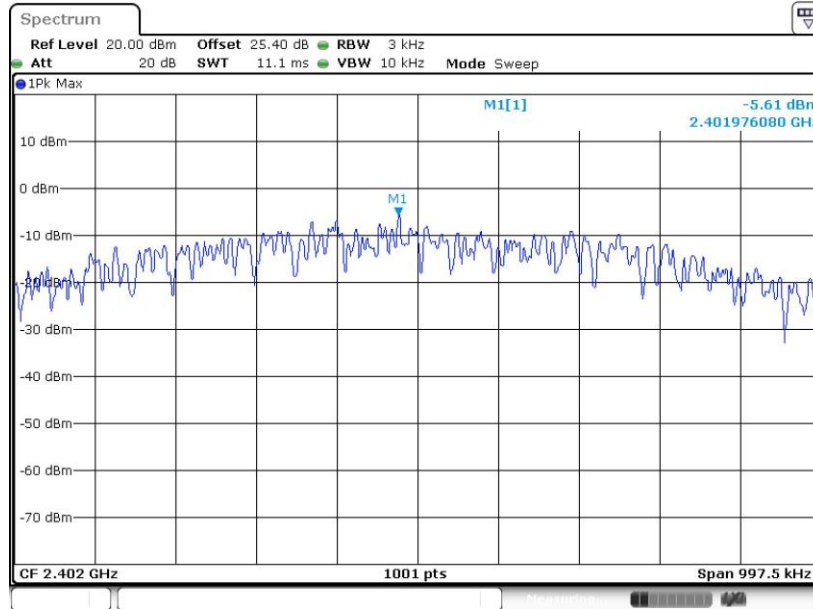

Date: 10.OCT.2018 01:06:23

PSD 3kHz Plot on Channel 19

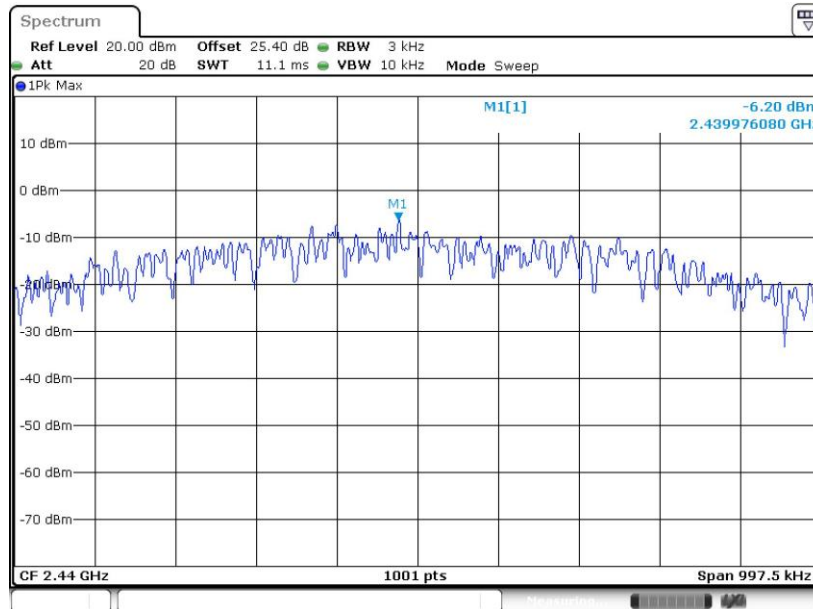

Date: 10.OCT.2018 01:04:19



PSD 3kHz Plot on Channel 39

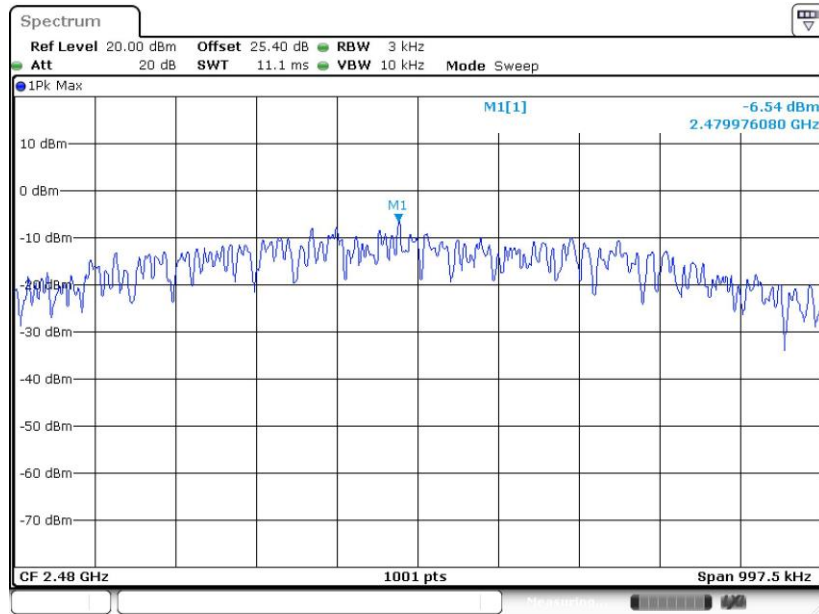

Date: 10.OCT.2018 01:02:01

<2Mbps>

PSD 3kHz Plot on Channel 00

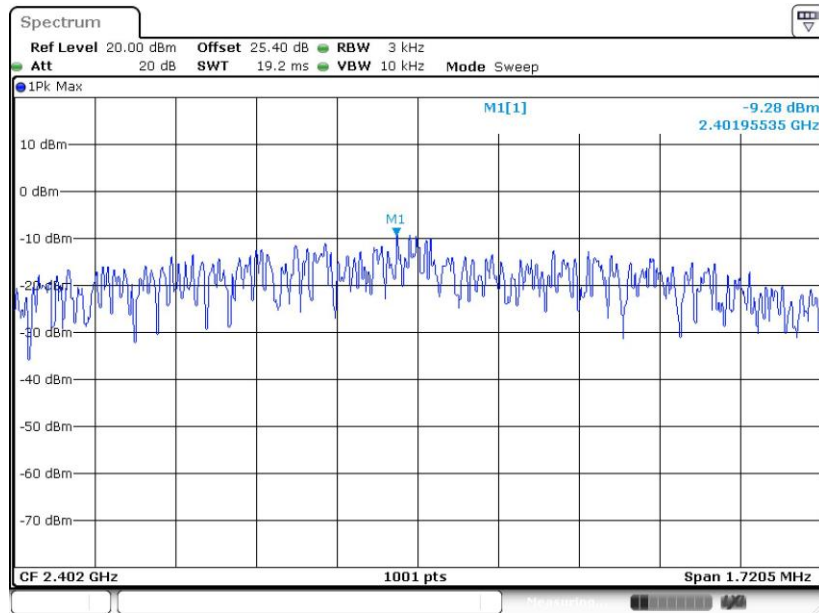

Date: 10.OCT.2018 00:49:05





PSD 3kHz Plot on Channel 19

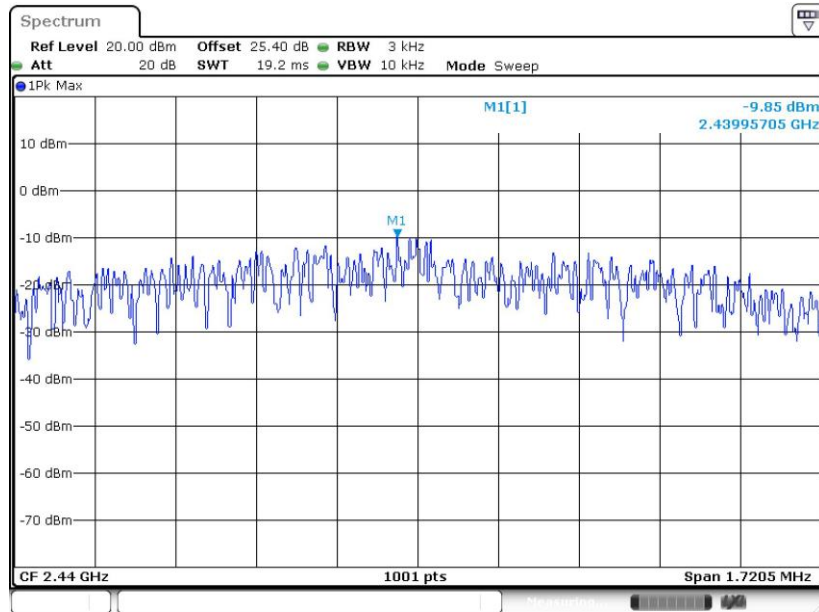

Date: 10.OCT.2018 00:52:34

PSD 3kHz Plot on Channel 39

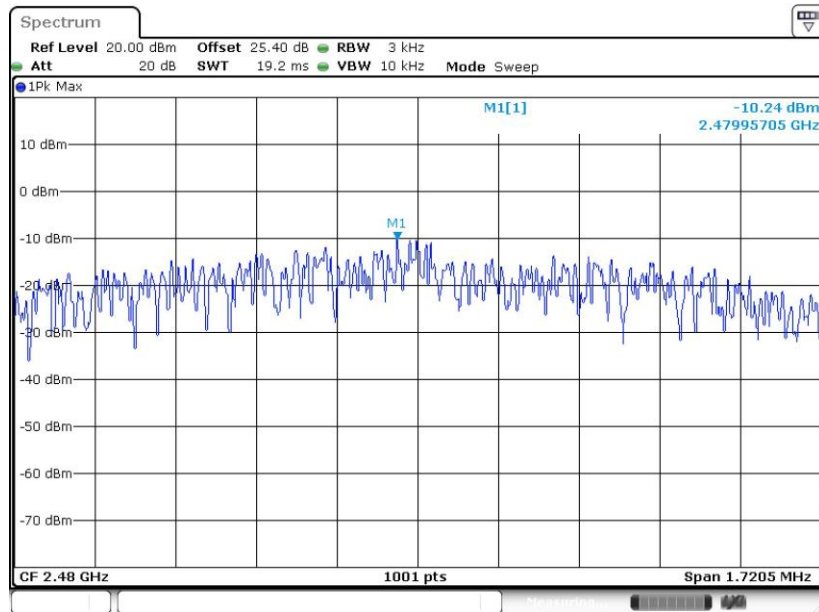

Date: 10.OCT.2018 00:59:08

## 3.4 Conducted Band Edges and Spurious Emission Measurement

### 3.4.1 Limit of Conducted Band Edges and Spurious Emission

All harmonics/spurious must be at least 20 dB down from the highest emission level within the authorized band.

### 3.4.2 Measuring Instruments

See list of measuring equipment of this test report.

### 3.4.3 Test Procedure

1. The testing follows the ANSI C63.10 Section 11.11.3 Emission level measurement.
2. The RF output of EUT was connected to the spectrum analyzer by RF cable and attenuator. The path loss was compensated to the results for each measurement.
3. Set to the maximum power setting and enable the EUT transmit continuously.
4. Set RBW = 100 kHz, VBW=300 kHz, Peak Detector. Unwanted Emissions measured in any 100 kHz bandwidth outside of the authorized frequency band shall be attenuated by at least 20 dB relative to the maximum in-band peak PSD level in 100 kHz when maximum peak conducted output power procedure is used. If the transmitter complies with the conducted power limits based on the use of RMS averaging over a time interval, the attenuation required under this paragraph shall be 30 dB instead of 20 dB.
5. Measure and record the results in the test report.
6. The RF fundamental frequency should be excluded against the limit line in the operating frequency band.

### 3.4.4 Test Setup

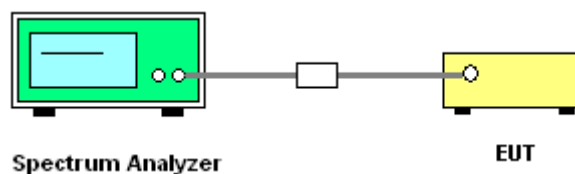



### 3.4.5 Test Result of Conducted Band Edges Plots

<1Mbps>

Low Band Edge Plot on Channel 00

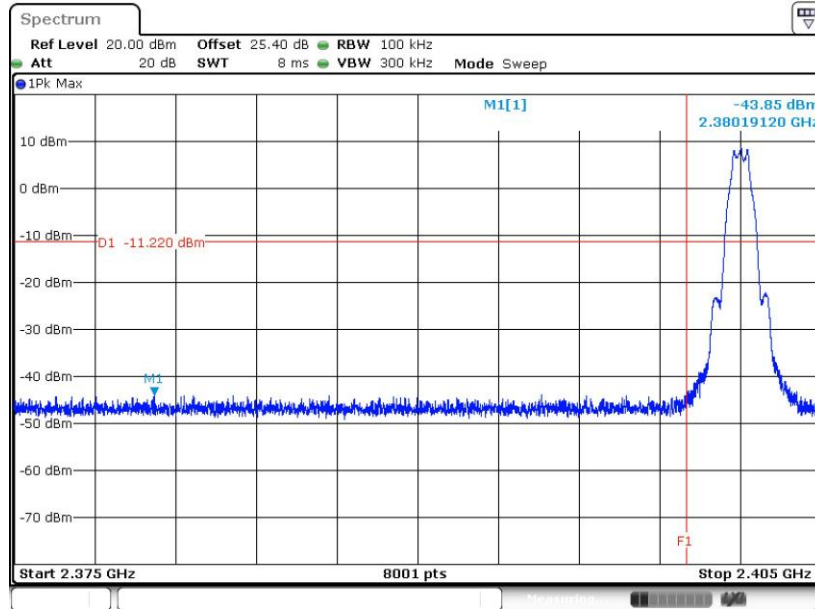

Date: 10.OCT.2018 01:06:51

High Band Edge Plot on Channel 39

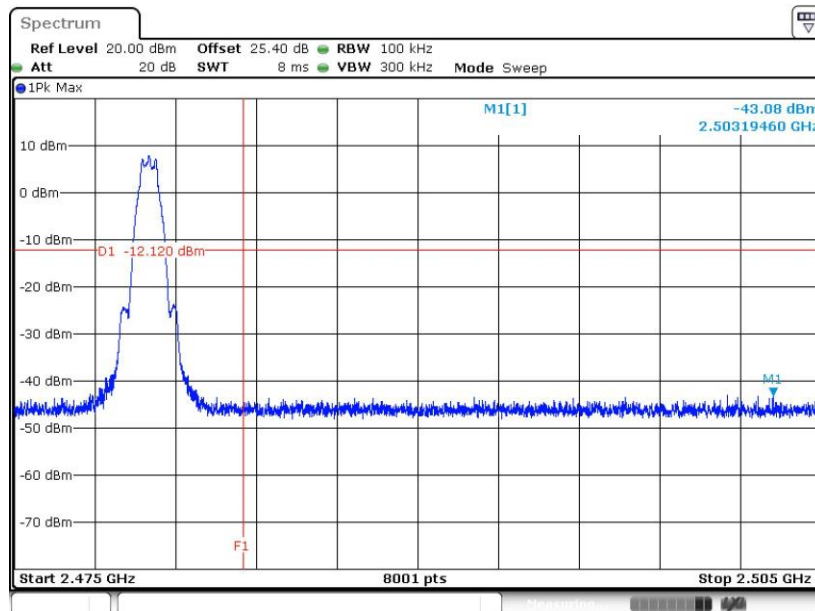

Date: 10.OCT.2018 01:02:28



<2Mbps>

Low Band Edge Plot on Channel 00

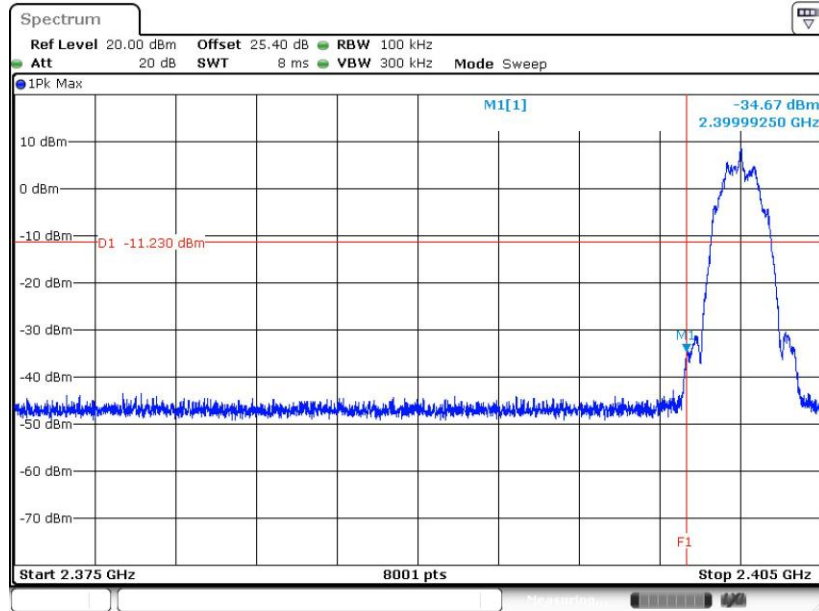

Date: 10.OCT.2018 00:49:56

High Band Edge Plot on Channel 39

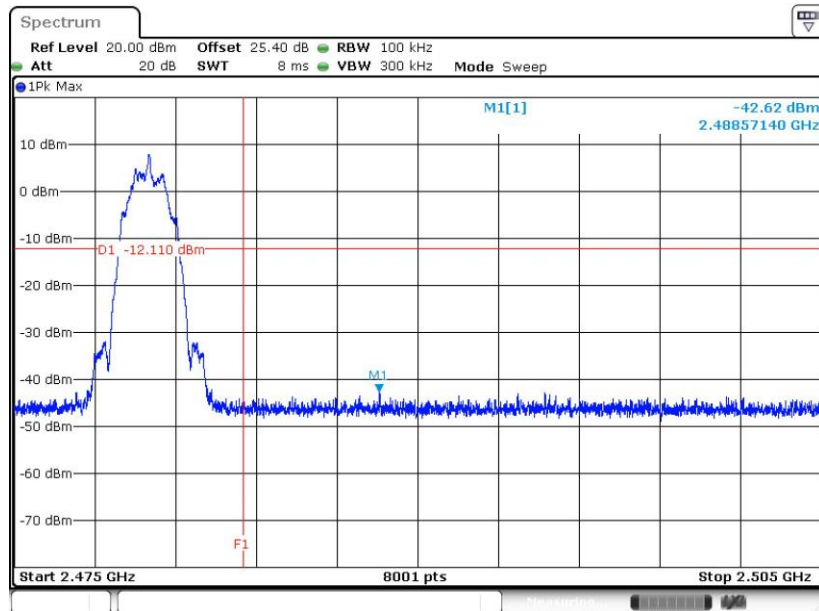

Date: 10.OCT.2018 00:59:32



### 3.4.6 Test Result of Conducted Spurious Emission Plots

#### Conducted Spurious Emission Plot on Bluetooth LE 1Mbps GFSK Channel 00

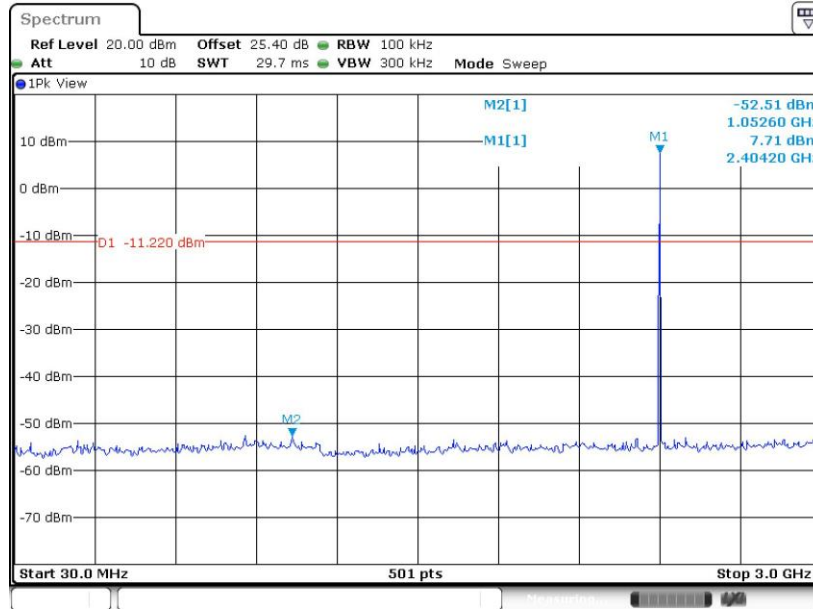

Date: 10.OCT.2018 01:07:15

#### Conducted Spurious Emission Plot on Bluetooth LE 1Mbps GFSK Channel 00

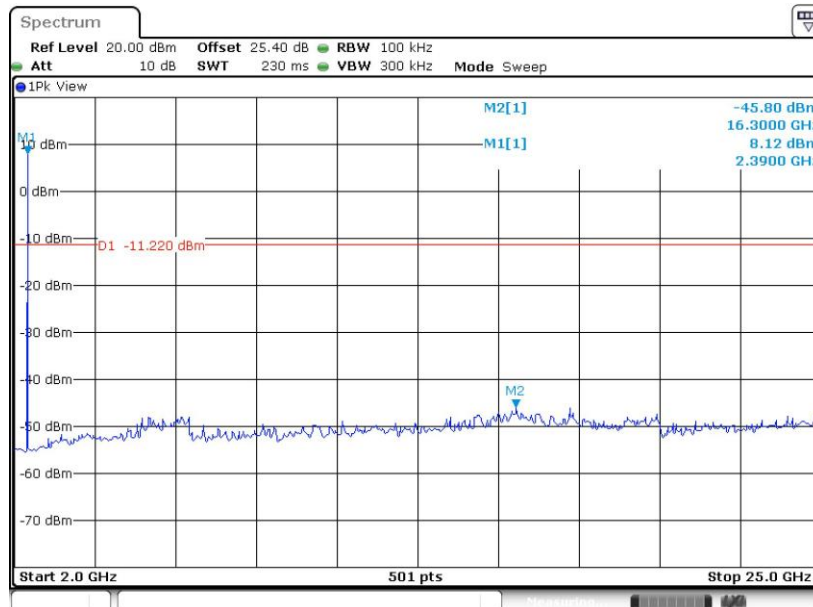

Date: 10.OCT.2018 01:07:27



Conducted Spurious Emission Plot on Bluetooth LE 1Mbps  
GFSK Channel 19

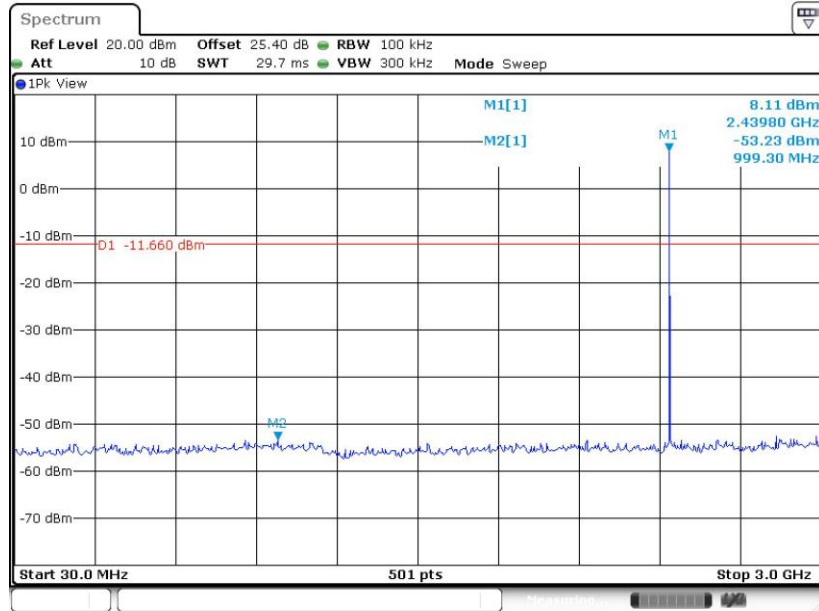

Date: 10.OCT.2018 01:04:48

Conducted Spurious Emission Plot on Bluetooth LE 1Mbps  
GFSK Channel 19

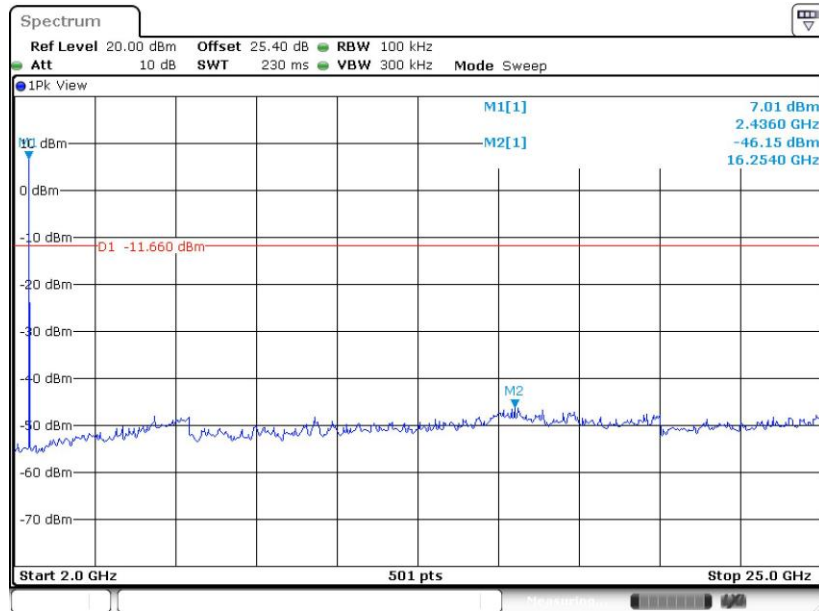

Date: 10.OCT.2018 01:05:01



### Conducted Spurious Emission Plot on Bluetooth LE 1Mbps GFSK Channel 39

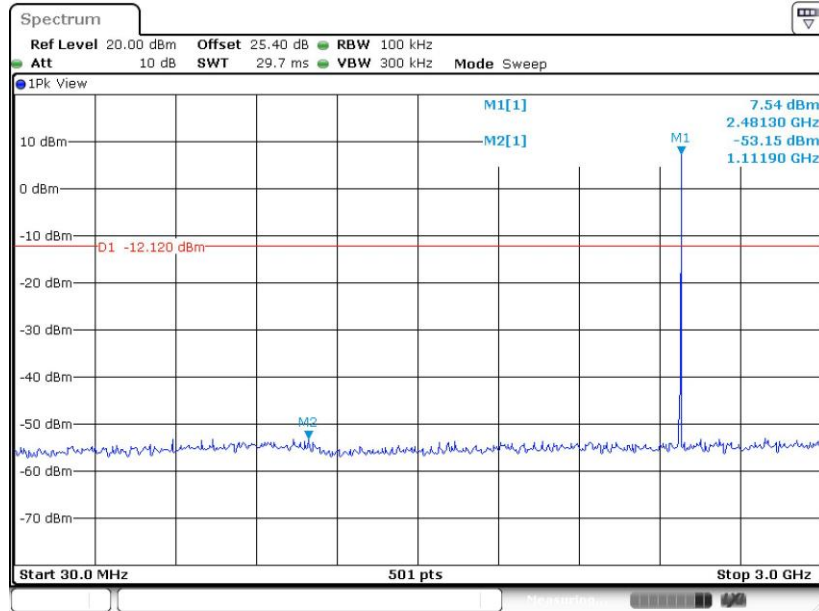

Date: 10.OCT.2018 01:02:58

### Conducted Spurious Emission Plot on Bluetooth LE 1Mbps GFSK Channel 39

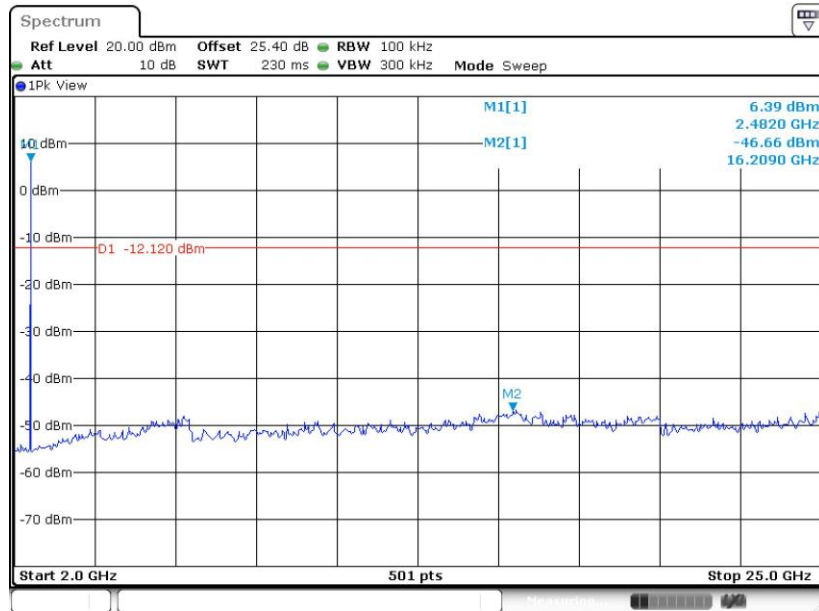

Date: 10.OCT.2018 01:03:11



### Conducted Spurious Emission Plot on Bluetooth LE 2Mbps GFSK Channel 00

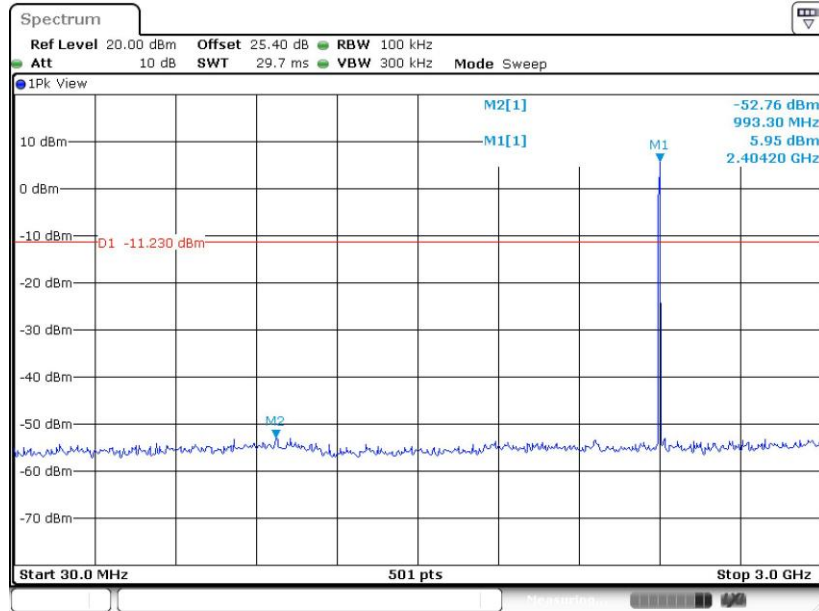

Date: 10.OCT.2018 00:50:39

### Conducted Spurious Emission Plot on Bluetooth LE 2Mbps GFSK Channel 00

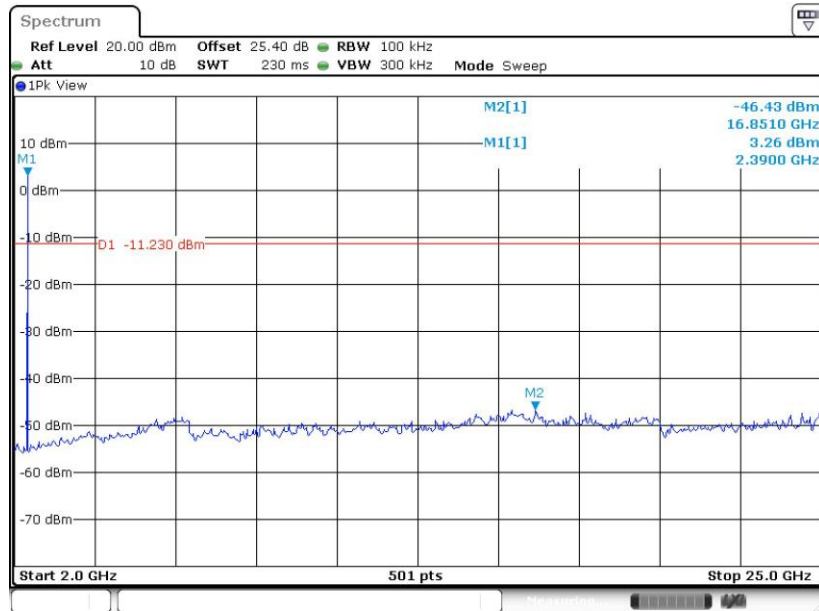

Date: 10.OCT.2018 00:50:58





### Conducted Spurious Emission Plot on Bluetooth LE 2Mbps GFSK Channel 19

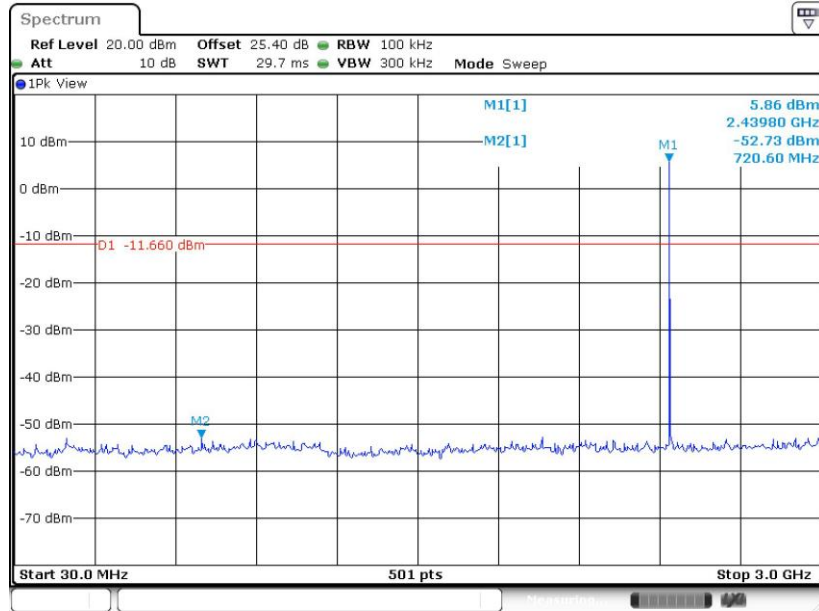

Date: 10.OCT.2018 00:57:18

### Conducted Spurious Emission Plot on Bluetooth LE 2Mbps GFSK Channel 19

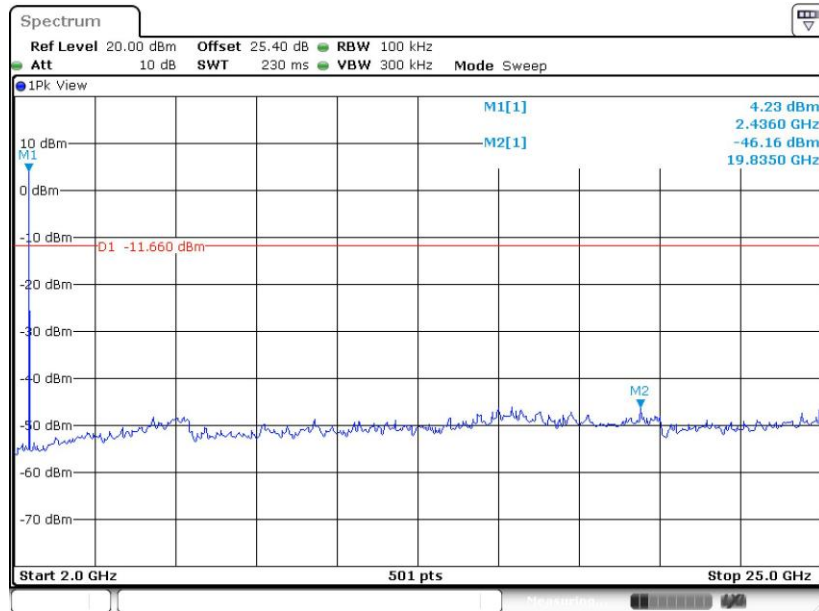

Date: 10.OCT.2018 00:57:30



### Conducted Spurious Emission Plot on Bluetooth LE 2Mbps GFSK Channel 39

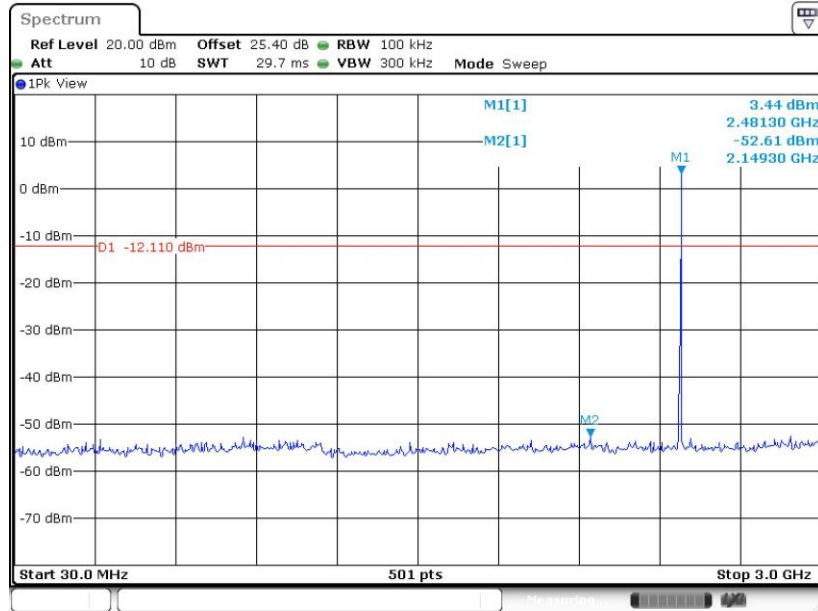

Date: 10.OCT.2018 00:59:46

### Conducted Spurious Emission Plot on Bluetooth LE 2Mbps GFSK Channel 39

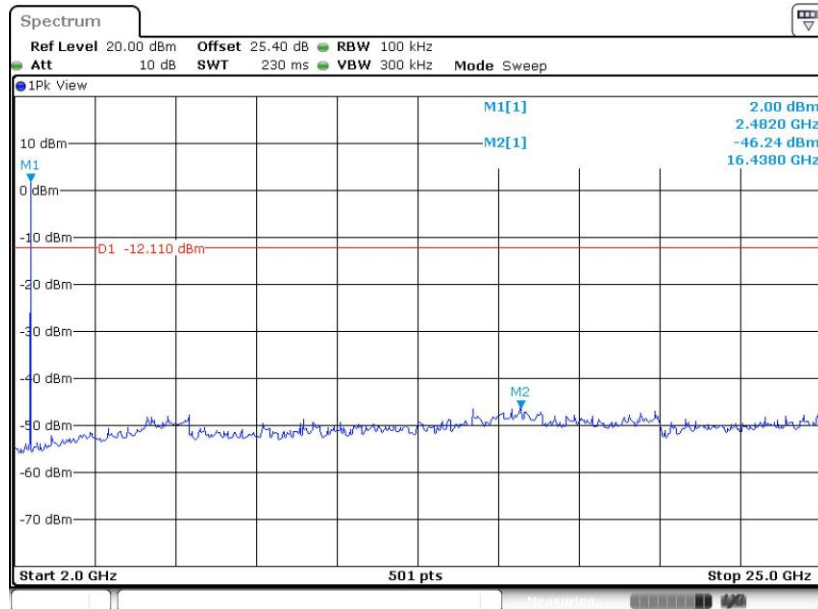

Date: 10.OCT.2018 00:59:59



### 3.5 Radiated Band Edges and Spurious Emission Measurement

#### 3.5.1 Limit of Radiated Band Edges and Spurious Emission

In any 100 kHz bandwidth outside the intentional radiator frequency band, all harmonics/spurious must be at least 20 dB below the highest emission level within the authorized band. If the output power of this device was measured by spectrum analyzer, the attenuation under this paragraph shall be 30 dB instead of 20 dB. In addition, radiated emissions which fall in the restricted bands must also comply with the limits as below.

Frequency (MHz)	Field Strength (microvolts/meter)	Measurement Distance (meters)
0.009 – 0.490	2400/F(kHz)	300
0.490 – 1.705	24000/F(kHz)	30
1.705 – 30.0	30	30
30 – 88	100	3
88 – 216	150	3
216 - 960	200	3
Above 960	500	3

#### 3.5.2 Measuring Instruments

See list of measuring equipment of this test report.



### 3.5.3 Test Procedures

1. The testing follows the ANSI C63.10 Section 11.12.1 Radiated emission measurements.
2. The EUT was arranged to its worst case and then tune the antenna tower (from 1 m to 4 m) and turntable (from 0 degree to 360 degrees) to find the maximum reading. A pre-amp and a high pass filter are used for the test in order to get better signal level.
3. The EUT was placed on a turntable with 0.8 meter for frequency below 1GHz and 1.5 meter for frequency above 1GHz respectively above ground.
4. The EUT was set 3 meters from the interference receiving antenna, which was mounted on the top of a variable height antenna tower.
5. Corrected Reading: Antenna Factor + Cable Loss + Read Level - Preamp Factor = Level
6. For testing below 1GHz, if the emission level of the EUT in peak mode was 3 dB lower than the limit specified, then peak values of EUT will be reported, otherwise, the emissions will be repeated one by one using the CISPR quasi-peak method and reported.
7. For testing above 1GHz, the emission level of the EUT in peak mode was 20dB lower than average limit (that means the emission level in average mode also complies with the limit in average mode), then peak values of EUT will be reported, otherwise, the emissions will be measured in average mode again and reported.
8. Use the following spectrum analyzer settings:
  - (1) Span shall wide enough to fully capture the emission being measured;
  - (2) Set RBW=100 kHz for  $f < 1$  GHz;  $VBW \geq RBW$ ; Sweep = auto; Detector function = peak; Trace = max hold;
  - (3) Set RBW = 1 MHz, VBW= 3MHz for  $f \geq 1$  GHz for peak measurement.  
For average measurement:
    - $VBW = 10$  Hz, when duty cycle is no less than 98 percent.
    - $VBW \geq 1/T$ , when duty cycle is less than 98 percent where T is the minimum transmission duration over which the transmitter is on and is transmitting at its maximum power control level for the tested mode of operation.

### 3.5.4 Test Setup

For radiated emissions below 30MHz

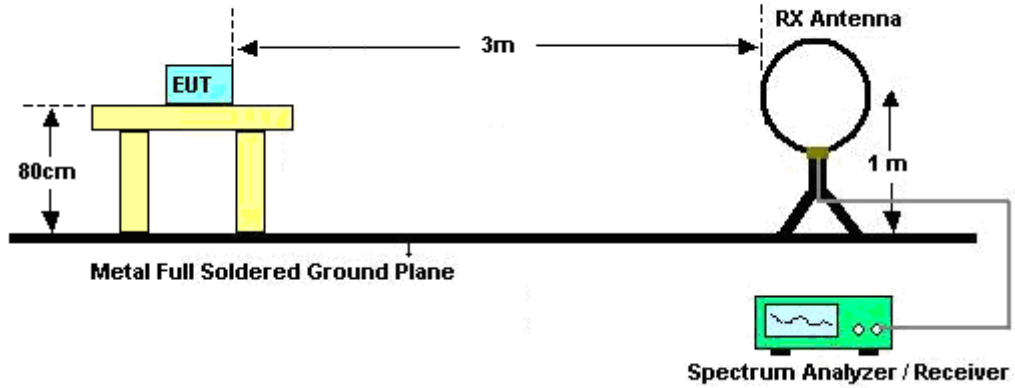

For radiated emissions from 30MHz to 1GHz

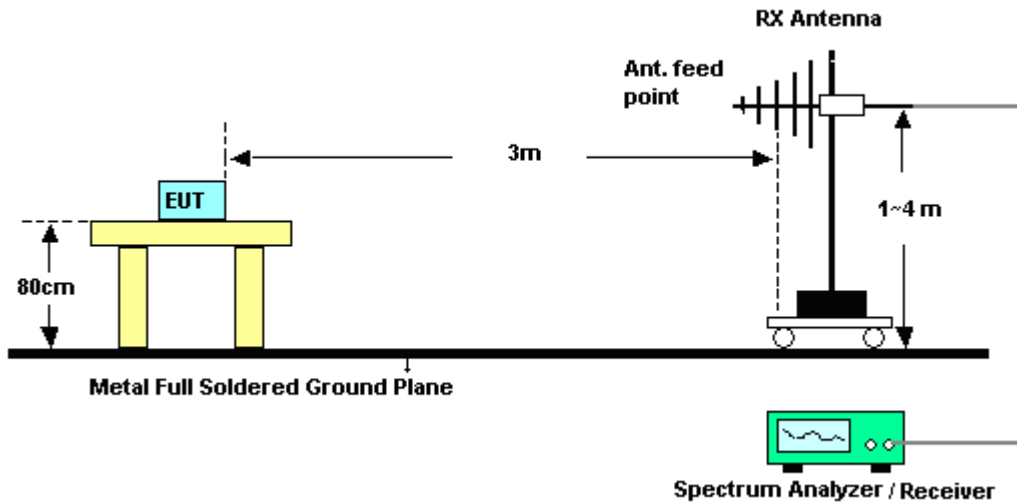

For radiated emissions above 1GHz

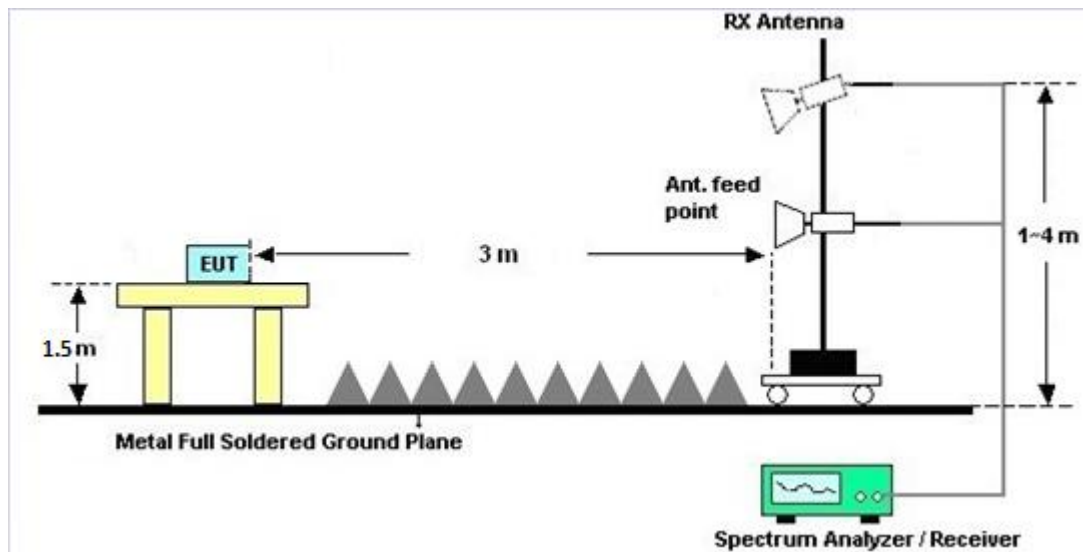

### 3.5.5 Test Results of Radiated Spurious Emissions (9 kHz ~ 30 MHz)

The low frequency, which started from 9 kHz to 30MHz, was pre-scanned and the result which was 20dB lower than the limit line was not reported.

There is a comparison data of both open-field test site and alternative test site - semi-Anechoic chamber according to 414788 D01 Radiated Test Site v01r01, and the result came out very similar.

### 3.5.6 Test Result of Radiated Spurious at Band Edges

Please refer to Appendix C and D.

### 3.5.7 Duty Cycle

Please refer to Appendix E.

### 3.5.8 Test Result of Radiated Spurious Emission (30MHz ~ 10th Harmonic)

Please refer to Appendix C and D.



### 3.6 AC Conducted Emission Measurement

#### 3.6.1 Limit of AC Conducted Emission

For equipment that is designed to be connected to the public utility (AC) power line, the radio frequency voltage that is conducted back onto the AC power line on any frequency or frequencies within the band 150 kHz to 30 MHz shall not exceed the limits in the following table.

Frequency of emission (MHz)	Conducted limit (dB $\mu$ V)	
	Quasi-peak	Average
0.15-0.5	66 to 56*	56 to 46*
0.5-5	56	46
5-30	60	50

\*Decreases with the logarithm of the frequency.

#### 3.6.2 Measuring Instruments

See list of measuring equipment of this test report.

#### 3.6.3 Test Procedures

1. The EUT was placed 0.4 meter from the conducting wall of the shielding room was kept at least 80 centimeters from any other grounded conducting surface.
2. Connect EUT to the power mains through a line impedance stabilization network (LISN).
3. All the support units are connecting to the other LISN.
4. The LISN provides 50 ohm coupling impedance for the measuring instrument.
5. The FCC states that a 50 ohm, 50 microhenry LISN should be used.
6. Both sides of AC line were checked for maximum conducted interference.
7. The frequency range from 150 kHz to 30 MHz was searched.
8. Set the test-receiver system to Peak Detect Function and specified bandwidth (IF Bandwidth = 9kHz) with Maximum Hold Mode. Then measurement is also conducted by Average Detector and Quasi-Peak Detector Function respectively.

### 3.6.4 Test Setup

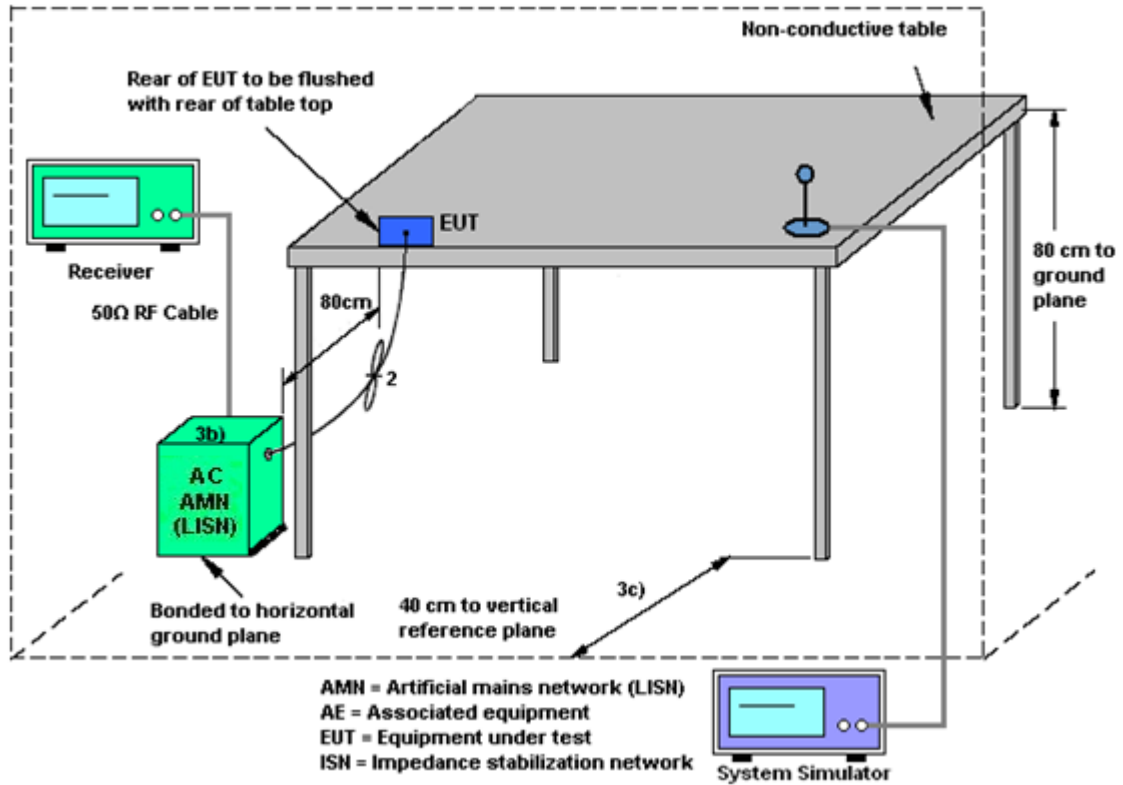

### 3.6.5 Test Result of AC Conducted Emission

Please refer to Appendix B.





## **3.7 Antenna Requirements**

### **3.7.1 Standard Applicable**

If directional gain of transmitting antennas is greater than 6dBi, the power shall be reduced by the same level in dB comparing to gain minus 6dBi. The use of a permanently attached antenna or of an antenna that uses a unique coupling to the intentional radiator shall be considered sufficient to comply with the rule.

### **3.7.2 Antenna Anti-Replacement Construction**

An embedded-in antenna design is used.

### **3.7.3 Antenna Gain**

The antenna peak gain of EUT is less than 6 dBi. Therefore, it is not necessary to reduce maximum peak output power limit.



## 4 List of Measuring Equipment

Instrument	Manufacturer	Model No.	Serial No.	Characteristics	Calibration Date	Test Date	Due Date	Remark
Power Meter	Agilent	E4416A	GB41292344	N/A	Dec. 20, 2017	Oct. 05, 2018~ Oct. 10, 2018	Dec. 19, 2018	Conducted (TH05-HY)
Power Sensor	Agilent	E9327A	US40441548	50MHz~18GHz	Dec. 20, 2017	Oct. 05, 2018~ Oct. 10, 2018	Dec. 19, 2018	Conducted (TH05-HY)
Signal Analyzer	Rohde & Schwarz	FSV40	101397	10Hz~40GHz	Nov. 07, 2017	Oct. 05, 2018~ Oct. 10, 2018	Nov. 06, 2018	Conducted (TH05-HY)
Switch Box & RF Cable	Burgeon	ETF-058	EC1300484	N/A	Mar. 01, 2018	Oct. 05, 2018~ Oct. 10, 2018	Feb. 28, 2019	Conducted (TH05-HY)
Hygrometer	Testo	DTM-303A	TP157075	N/A	Mar. 06, 2018	Oct. 05, 2018~ Oct. 10, 2018	Mar. 05, 2019	Conducted (TH05-HY)
RF Cable	HUBER + SUHNER	SUCOFLEX 104	MY84209521	1GHz~26GHz	Dec. 01, 2017	Oct. 05, 2018~ Oct. 10, 2018	Nov. 30, 2018	Conducted (TH05-HY)
AC Power Source	ChainTek	APC-1000W	N/A	N/A	N/A	Dec. 05, 2018	N/A	Conduction (CO05-HY)
EMI Test Receiver	Rohde & Schwarz	ESR3	102388	9KHz~3.6GHz	Nov. 12, 2018	Dec. 05, 2018	Nov. 11, 2019	Conduction (CO05-HY)
LISN	Rohde & Schwarz	ENV216	100080	9kHz~30MHz	Nov. 14, 2018	Dec. 05, 2018	Nov. 13, 2019	Conduction (CO05-HY)
LF Cable	HUBER + SUHNER	RG-214/U	LF01	N/A	Jan. 03, 2018	Dec. 05, 2018	Jan. 02, 2019	Conduction (CO05-HY)
Test Software	Rohde & Schwarz	EMC32 V10.30	N/A	N/A	N/A	Dec. 05, 2018	N/A	Conduction (CO05-HY)
Pulse Limiter	Rohde & Schwarz	ESH3-Z2	100851	N/A	Jan. 03, 2018	Dec. 05, 2018	Jan. 02, 2019	Conduction (CO05-HY)
Hygrometer	Testo	608-H1	34913912	N/A	Mar. 06, 2018	Dec. 05, 2018	Mar. 05, 2019	Conduction (CO05-HY)
Loop Antenna	TESEQ	HLA 6120	31244	9 kHz~30 MHz	May 29, 2018	Dec. 05, 2018~ Dec. 25, 2018	May 28, 2019	Radiation (03CH07-HY)
Bilog Antenna	TESEQ	CBL 6111D&N-6-06	35414&AT-N0602	30MHz to 1GHz	Oct. 13, 2018	Dec. 05, 2018~ Dec. 25, 2018	Oct. 12, 2019	Radiation (03CH07-HY)
Horn Antenna	ESCO	3117	00211469	1GHz~18GHz	Apr. 06, 2018	Dec. 05, 2018~ Dec. 25, 2018	Apr. 05, 2019	Radiation (03CH07-HY)
SHF-EHF Horn Antenna	SCHWARZBECK	BBHA 9170	BBHA9170576	18GHz ~ 40GHz	May 08, 2018	Dec. 05, 2018~ Dec. 25, 2018	May 07, 2019	Radiation (03CH07-HY)
EMI Test Receiver	Agilent	N9038A (MXE)	MY53290053	20Hz to 26.5GHz	Jan. 16, 2018	Dec. 05, 2018~ Dec. 25, 2018	Jan. 15, 2019	Radiation (03CH07-HY)
Spectrum Analyzer	Agilent	E4446A	MY50180136	3Hz~44GHz	Apr. 25, 2018	Dec. 05, 2018~ Dec. 25, 2018	Apr. 24, 2019	Radiation (03CH07-HY)



Instrument	Manufacturer	Model No.	Serial No.	Characteristics	Calibration Date	Test Date	Due Date	Remark
Preamplifier	MITEQ	AMF-7D-0010 1800-30-10P	1590075	1GHz ~ 18GHz	Apr. 25, 2018	Dec. 05, 2018~ Dec. 25, 2018	Apr. 24, 2019	Radiation (03CH07-HY)
Preamplifier	COM-POWER	PA-103A	161241	10MHz-1GHz	May 21, 2018	Dec. 05, 2018~ Dec. 25, 2018	May 20, 2019	Radiation (03CH07-HY)
Preamplifier	Agilent	8449B	3008A02362	1GHz~ 26.5GHz	Nov. 02, 2018	Dec. 05, 2018~ Dec. 25, 2018	Nov. 01, 2019	Radiation (03CH07-HY)
Preamplifier	Agilent	8449B	3008A01917	1GHz~26.5GHz	Apr. 23, 2018	Dec. 05, 2018~ Dec. 25, 2018	Apr. 22, 2019	Radiation (03CH07-HY)
Amplifier	MITEQ	TTA1840-35- HG	1871923	18GHz~40GHz, VSWR : 2.5:1 max	Jul. 16, 2018	Dec. 05, 2018~ Dec. 25, 2018	Jul. 15, 2019	Radiation (03CH07-HY)
Hygrometer	TECPEL	HTC-2	1	N/A	May 12, 2018	Dec. 05, 2018~ Dec. 25, 2018	May 11, 2019	Radiation (03CH07-HY)
RF Cable	HUBER + SUHNER	SUCOFLEX 104	MY24971/4,M Y28655/4	9KHz~30MHz	Jan. 02, 2018	Dec. 05, 2018~ Dec. 25, 2018	Jan. 01, 2019	Radiation (03CH07-HY)
RF Cable	HUBER + SUHNER	SUCOFLEX 104	MY28655/4, MY24971/4, MY15682/4	30MHz~1GHz	Feb. 27, 2018	Dec. 05, 2018~ Dec. 25, 2018	Feb. 26, 2019	Radiation (03CH07-HY)
RF Cable	HUBER + SUHNER	SUCOFLEX 104	MY28655/4, MY24971/4, MY15682/4	1GHz~18GHz	Feb. 27, 2018	Dec. 05, 2018~ Dec. 25, 2018	Feb. 26, 2019	Radiation (03CH07-HY)
RF Cable	HUBER + SUHNER	SF102/2*11S K252	MY4278/2	9kHz~40GHz	May 17, 2018	Dec. 05, 2018~ Dec. 25, 2018	May 16, 2019	Radiation (03CH07-HY)
Filter	Wainwright	WLKS1200-1 2SS	SN2	1.2GHz Low Pass	Mar. 21, 2018	Dec. 05, 2018~ Dec. 25, 2018	Mar. 20, 2019	Radiation (03CH07-HY)
Filter	Wainwright	WHKX12-270 0-3000-18000 -60ST	SN2	3GHz High Pass	Mar. 21, 2018	Dec. 05, 2018~ Dec. 25, 2018	Mar. 20, 2019	Radiation (03CH07-HY)
Controller	ChainTek	Chaintek 3000	N/A	Control Turn table	N/A	Dec. 05, 2018~ Dec. 25, 2018	N/A	Radiation (03CH07-HY)
Controller	Max-Full	MF7802	MF78020836 8	Control Ant Mast	N/A	Dec. 05, 2018~ Dec. 25, 2018	N/A	Radiation (03CH07-HY)
Antenna Mast	Max-Full	MFA520BS	N/A	1m~4m	N/A	Dec. 05, 2018~ Dec. 25, 2018	N/A	Radiation (03CH07-HY)
Turn Table	ChainTek	Chaintek 3000	N/A	0~360 Degree	N/A	Dec. 05, 2018~ Dec. 25, 2018	N/A	Radiation (03CH07-HY)
Software	Audix	E3 6.2009-8-24	RK-001042	N/A	N/A	Dec. 05, 2018~ Dec. 25, 2018	N/A	Radiation (03CH07-HY)



## 5 Uncertainty of Evaluation

### Uncertainty of Conducted Emission Measurement (150 kHz ~ 30 MHz)

Measuring Uncertainty for a Level of Confidence of 95% ( $U = 2Uc(y)$ )	2.20
---	------

### Uncertainty of Radiated Emission Measurement (30 MHz ~ 1000 MHz)

Measuring Uncertainty for a Level of Confidence of 95% ( $U = 2Uc(y)$ )	5.70
---	------

### Uncertainty of Radiated Emission Measurement (1000 MHz ~ 18000 MHz)

Measuring Uncertainty for a Level of Confidence of 95% ( $U = 2Uc(y)$ )	5.50
---	------

### Uncertainty of Radiated Emission Measurement (18000 MHz ~ 40000 MHz)

Measuring Uncertainty for a Level of Confidence of 95% ( $U = 2Uc(y)$ )	5.20
---	------

**Appendix A. Test Result of Conducted Test Items**

Test Engineer:	Shiming Liu / Kai Liao	Temperature:	21~25	°C
Test Date:	2018/10/5 ~ 2018/10/10	Relative Humidity:	51~54	%

&lt;1Mbps&gt;

**TEST RESULTS DATA**  
**6dB and 99% Occupied Bandwidth**

Mod.	Data Rate	NTX	CH.	Freq. (MHz)	99% Occupied BW (MHz)	6dB BW (MHz)	6dB BW Limit (MHz)	Pass/Fail
BLE	1Mbps	1	0	2402	1.023	0.665	0.50	Pass
BLE	1Mbps	1	19	2440	1.025	0.665	0.50	Pass
BLE	1Mbps	1	39	2480	1.025	0.665	0.50	Pass

**TEST RESULTS DATA**  
**Peak Power Table**

Mod.	Data Rate	NTX	CH.	Freq. (MHz)	Peak Conducted Power (dBm)	Conducted Power Limit (dBm)	DG (dBi)	EIRP Power (dBm)	EIRP Power Limit (dBm)	Pass /Fail
BLE	1Mbps	1	0	2402	9.79	30.00	-0.60	9.19	36.00	Pass
BLE	1Mbps	1	19	2440	9.43	30.00	-0.60	8.83	36.00	Pass
BLE	1Mbps	1	39	2480	9.00	30.00	-0.60	8.40	36.00	Pass

**TEST RESULTS DATA**  
**Average Power Table**  
**(Reporting Only)**

Mod.	Data Rate	NTX	CH.	Freq. (MHz)	Duty Factor (dB)	Average Conducted Power (dBm)
BLE	1Mbps	1	0	2402	2.05	9.49
BLE	1Mbps	1	19	2440	2.05	9.00
BLE	1Mbps	1	39	2480	2.05	8.60

**TEST RESULTS DATA**  
**Peak Power Density**

Mod.	Data Rate	NTX	CH.	Freq. (MHz)	Peak PSD (dBm /100kHz)	Peak PSD (dBm /3kHz)	DG (dBi)	Peak PSD Limit (dBm /3kHz)	Pass/Fail
BLE	1Mbps	1	0	2402	8.78	-5.61	-0.60	8.00	Pass
BLE	1Mbps	1	19	2440	8.34	-6.20	-0.60	8.00	Pass
BLE	1Mbps	1	39	2480	7.88	-6.54	-0.60	8.00	Pass

Note: PSD (dBm/ 100kHz) is a reference level used for Conducted Band Edges and Conducted Spurious Emission 20dBc limit.

Test Engineer:	Shiming Liu / Kai Liao	Temperature:	21~25	°C
Test Date:	2018/10/5 ~ 2018/10/10	Relative Humidity:	51~54	%

&lt;2Mbps&gt;

**TEST RESULTS DATA**  
**6dB and 99% Occupied Bandwidth**

Mod.	Data Rate	NTX	CH.	Freq. (MHz)	99% Occupied BW (MHz)	6dB BW (MHz)	6dB BW Limit (MHz)	Pass/Fail
BLE5.0	2Mbps	1	0	2402	2.030	1.147	0.50	Pass
BLE5.0	2Mbps	1	19	2440	2.026	1.147	0.50	Pass
BLE5.0	2Mbps	1	39	2480	2.034	1.147	0.50	Pass

**TEST RESULTS DATA**  
**Peak Power Table**

Mod.	Data Rate	NTX	CH.	Freq. (MHz)	Peak Conducted Power (dBm)	Conducted Power Limit (dBm)	DG (dBi)	EIRP Power (dBm)	EIRP Power Limit (dBm)	Pass /Fail
BLE5.0	2Mbps	1	0	2402	9.99	30.00	-0.60	9.39	36.00	Pass
BLE5.0	2Mbps	1	19	2440	9.56	30.00	-0.60	8.96	36.00	Pass
BLE5.0	2Mbps	1	39	2480	9.19	30.00	-0.60	8.59	36.00	Pass

**TEST RESULTS DATA**  
**Average Power Table**  
**(Reporting Only)**

Mod.	Data Rate	NTX	CH.	Freq. (MHz)	Duty Factor (dB)	Average Conducted Power (dBm)
BLE5.0	2Mbps	1	0	2402	4.84	9.46
BLE5.0	2Mbps	1	19	2440	4.84	8.99
BLE5.0	2Mbps	1	39	2480	4.84	8.62

**TEST RESULTS DATA**  
**Peak Power Density**

Mod.	Data Rate	NTX	CH.	Freq. (MHz)	Peak PSD (dBm /100kHz)	Peak PSD (dBm /3kHz)	DG (dBi)	Peak PSD Limit (dBm /3kHz)	Pass/Fail
BLE5.0	2Mbps	1	0	2402	8.77	-9.28	-0.60	8.00	Pass
BLE5.0	2Mbps	1	19	2440	8.34	-9.85	-0.60	8.00	Pass
BLE5.0	2Mbps	1	39	2480	7.89	-10.24	-0.60	8.00	Pass

Note: PSD (dBm/ 100kHz) is a reference level used for Conducted Band Edges and Conducted Spurious Emission 20dBc limit.



## Appendix B. AC Conducted Emission Test Results

Test Engineer :	Jimmy Chang	Temperature :	22~23°C
		Relative Humidity :	55~57%

# EUT Information

Report NO : 891148-01  
 Test Mode : Mode 1  
 Test Voltage : 120Vac/60Hz  
 Phase : Line

Full Spectrum

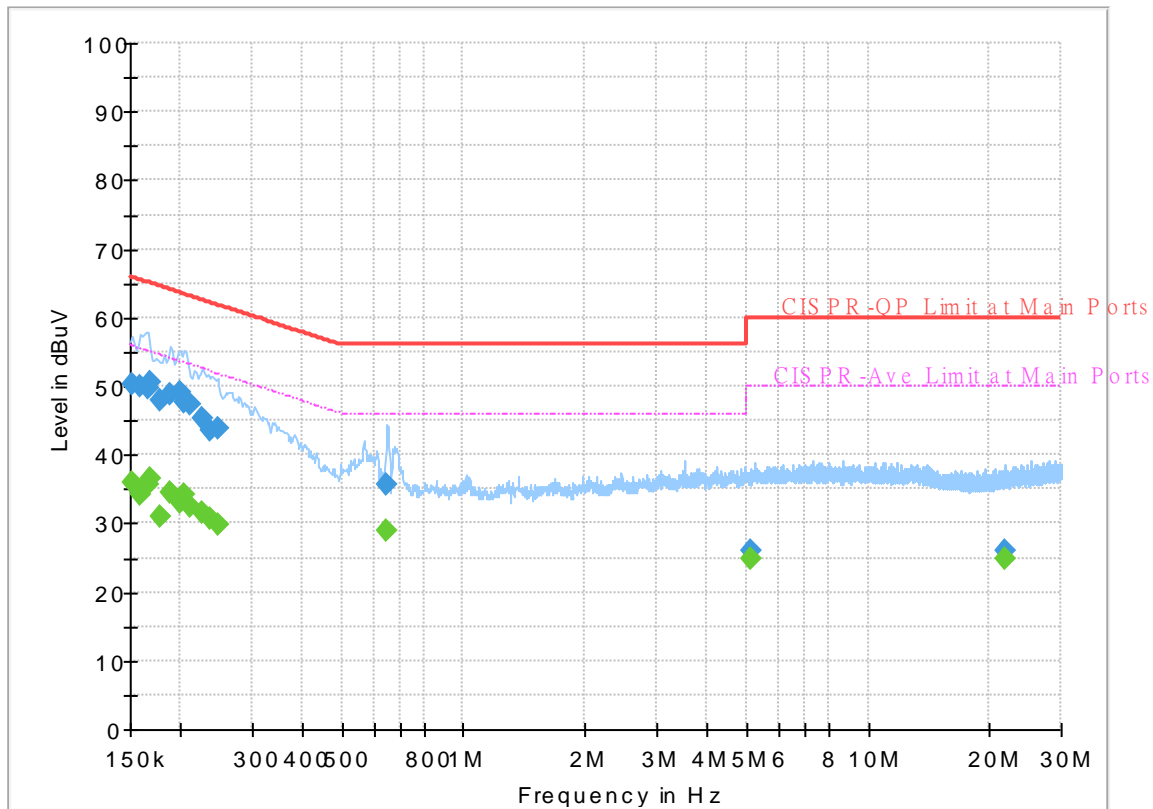

## Final\_Result

Frequency (MHz)	QuasiPeak (dBuV)	CAverage (dBuV)	Limit (dBuV)	Margin (dB)	Line	Filter	Corr. (dB)
0.152250	---	35.87	55.88	20.01	L1	OFF	19.5
0.152250	50.42	---	65.88	15.46	L1	OFF	19.5
0.159000	---	34.31	55.52	21.21	L1	OFF	19.5
0.159000	50.05	---	65.52	15.47	L1	OFF	19.5
0.165750	---	35.76	55.17	19.41	L1	OFF	19.5
0.165750	49.62	---	65.17	15.55	L1	OFF	19.5
0.168000	---	36.52	55.06	18.54	L1	OFF	19.5
0.168000	50.49	---	65.06	14.57	L1	OFF	19.5
0.177000	---	30.90	54.63	23.73	L1	OFF	19.5
0.177000	47.99	---	64.63	16.64	L1	OFF	19.5
0.188250	---	34.39	54.11	19.72	L1	OFF	19.5
0.188250	48.72	---	64.11	15.39	L1	OFF	19.5
0.199500	---	33.18	53.63	20.45	L1	OFF	19.5
0.199500	49.12	---	63.63	14.51	L1	OFF	19.5
0.204000	---	34.08	53.45	19.37	L1	OFF	19.5
0.204000	47.57	---	63.45	15.88	L1	OFF	19.5
0.210750	---	32.35	53.18	20.83	L1	OFF	19.5
0.210750	47.27	---	63.18	15.91	L1	OFF	19.5
0.226500	---	31.58	52.58	21.00	L1	OFF	19.5
0.226500	45.25	---	62.58	17.33	L1	OFF	19.5
0.237750	---	30.58	52.17	21.59	L1	OFF	19.5



0.237750	43.55	---	62.17	18.62	L1	OFF	19.5
0.249000	---	29.82	51.79	21.97	L1	OFF	19.5
0.249000	43.77	---	61.79	18.02	L1	OFF	19.5
0.647250	---	29.08	46.00	16.92	L1	OFF	19.6
0.647250	35.74	---	56.00	20.26	L1	OFF	19.6
5.129250	---	24.97	50.00	25.03	L1	OFF	19.7
5.129250	26.12	---	60.00	33.88	L1	OFF	19.7
21.878250	---	24.72	50.00	25.28	L1	OFF	20.3
21.878250	25.88	---	60.00	34.12	L1	OFF	20.3

# EUT Information

Report NO : 891148-01  
 Test Mode : Mode 1  
 Test Voltage : 120Vac/60Hz  
 Phase : Neutral

Full Spectrum

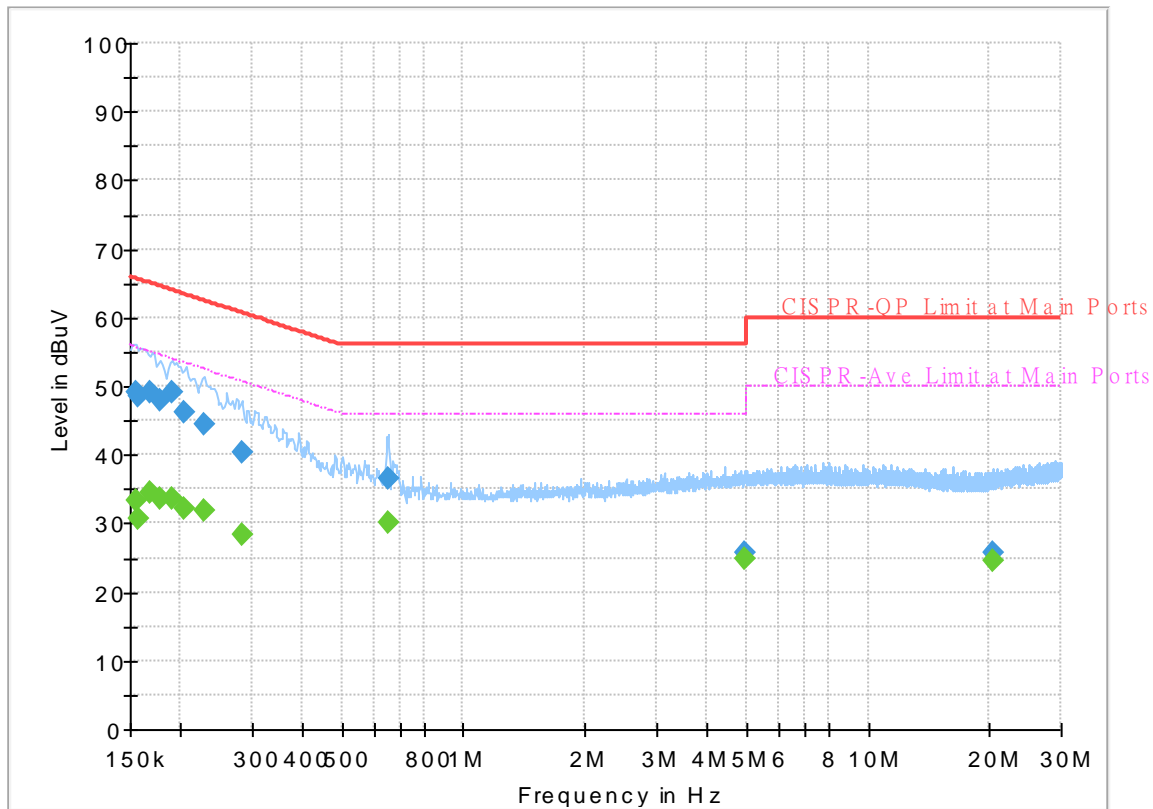

## Final\_Result

Frequency (MHz)	QuasiPeak (dBuV)	CAverage (dBuV)	Limit (dBuV)	Margin (dB)	Line	Filter	Corr. (dB)
0.154500	---	33.38	55.75	22.37	N	OFF	19.5
0.154500	49.17	---	65.75	16.58	N	OFF	19.5
0.156750	---	30.74	55.63	24.89	N	OFF	19.5
0.156750	48.59	---	65.63	17.04	N	OFF	19.5
0.168000	---	34.64	55.06	20.42	N	OFF	19.5
0.168000	49.19	---	65.06	15.87	N	OFF	19.5
0.177000	---	33.48	54.63	21.15	N	OFF	19.5
0.177000	48.09	---	64.63	16.54	N	OFF	19.5
0.190500	---	33.54	54.02	20.48	N	OFF	19.5
0.190500	49.12	---	64.02	14.90	N	OFF	19.5
0.204000	---	32.15	53.45	21.30	N	OFF	19.5
0.204000	46.18	---	63.45	17.27	N	OFF	19.5
0.228750	---	31.79	52.50	20.71	N	OFF	19.5
0.228750	44.37	---	62.50	18.13	N	OFF	19.5
0.285000	---	28.26	50.67	22.41	N	OFF	19.5
0.285000	40.36	---	60.67	20.31	N	OFF	19.5
0.651750	---	30.06	46.00	15.94	N	OFF	19.6
0.651750	36.68	---	56.00	19.32	N	OFF	19.6
4.962750	---	24.83	46.00	21.17	N	OFF	19.7
4.962750	25.63	---	56.00	30.37	N	OFF	19.7
20.307750	---	24.55	50.00	25.45	N	OFF	20.3

20.307750	25.74	---	60.00	34.26	N	OFF	20.3
-----------	-------	-----	-------	-------	---	-----	------



### Appendix C. Radiated Spurious Emission

Test Engineer :	Jack Cheng, Lance Chiang, and Peter Liao	Temperature :	22~24°C
		Relative Humidity :	52~60%

<For Sample 1>

<Adapter 1>

2.4GHz 2400~2483.5MHz

BLE 1Mbps (Band Edge @ 3m)

BLE	Note	Frequency	Level	Over	Limit	Read	Antenna	Path	Preamp	Ant	Table	Peak	Pol.	
		( MHz )	( dBμV/m )	( dB )	Limit	Level	Factor	Loss	Factor	Pos	Pos	Avg.		
					Line	( dBμV )	( dB/m )	( dB )	( dB )	( cm )	( deg )	( P/A )	( H/V )	
BLE CH 00 2402MHz		2345.385	54.81	-19.19	74	40.48	31.9	17.37	34.94	313	122	P	H	
		2381.295	45.62	-8.38	54	31.15	31.97	17.44	34.94	313	122	A	H	
	*	2402	104.25	-	-	89.76	32	17.44	34.95	313	122	P	H	
	*	2402	103.7	-	-	89.21	32	17.44	34.95	313	122	A	H	
													H	
														H
			2328.27	54.93	-19.07	74	40.75	31.8	17.31	34.93	105	82	P	V
			2316.195	45.43	-8.57	54	31.35	31.7	17.31	34.93	105	82	A	V
	*		2402	103.56	-	-	89.07	32	17.44	34.95	105	82	P	V
	*		2402	103.05	-	-	88.56	32	17.44	34.95	105	82	A	V
														V
														V



<b>BLE CH 19 2440MHz</b>		2370.9	54.6	-19.4	74	40.19	31.97	17.38	34.94	300	126	P	H
		2377.06	45.43	-8.57	54	31.02	31.97	17.38	34.94	300	126	A	H
	*	2440	103.77	-	-	89.03	32.2	17.5	34.96	300	126	P	H
	*	2440	103.13	-	-	88.39	32.2	17.5	34.96	300	126	A	H
		2486.7	54.27	-19.73	74	39.41	32.27	17.56	34.97	300	126	P	H
		2497.9	45.84	-8.16	54	30.96	32.3	17.56	34.98	300	126	A	H
		2346.54	54.58	-19.42	74	40.25	31.9	17.37	34.94	140	82	P	V
		2336.04	45.67	-8.33	54	31.39	31.9	17.31	34.93	140	82	A	V
	*	2440	104.04	-	-	89.3	32.2	17.5	34.96	140	82	P	V
	*	2440	103.53	-	-	88.79	32.2	17.5	34.96	140	82	A	V
		2485.37	54.57	-19.43	74	39.71	32.27	17.56	34.97	140	82	P	V
		2499.3	45.8	-8.2	54	30.92	32.3	17.56	34.98	140	82	A	V
	<b>BLE CH 39 2480MHz</b>	*	2480	101.74	-	-	86.88	32.27	17.56	34.97	297	126	P
*		2480	101.02	-	-	86.16	32.27	17.56	34.97	297	126	A	H
		2487.8	54.89	-19.11	74	40	32.3	17.56	34.97	297	126	P	H
		2495.16	45.9	-8.1	54	31.02	32.3	17.56	34.98	297	126	A	H
													H
													H
*		2480	102.01	-	-	87.15	32.27	17.56	34.97	102	83	P	V
*		2480	101.43	-	-	86.57	32.27	17.56	34.97	102	83	A	V
		2487.28	55.38	-18.62	74	40.52	32.27	17.56	34.97	102	83	P	V
		2493.96	45.94	-8.06	54	31.06	32.3	17.56	34.98	102	83	A	V
												V	
												V	
<b>Remark</b>	1. No other spurious found. 2. All results are PASS against Peak and Average limit line.												



2.4GHz 2400~2483.5MHz  
BLE 1Mbps (Harmonic @ 3m)

BLE	Note	Frequency	Level	Over	Limit	Read	Antenna	Path	Preamp	Ant	Table	Peak	Pol.
		( MHz )	( dBμV/m )	( dB )	Limit	Level	Factor	Loss	Factor	Pos	Pos	Avg.	
					Line	( dBμV )	( dB/m )	( dB )	( dB )	( cm )	( deg )	( P/A )	( H/V )
BLE CH 00 2402MHz		4804	42.13	-31.87	74	56.68	33.9	10.93	59.38	100	0	P	H
													H
													H
													H
		4804	42.4	-31.6	74	56.95	33.9	10.93	59.38	100	0	P	V
													V
													V
BLE CH 19 2440MHz		4880	43.09	-30.91	74	57.3	34	11.03	59.24	100	0	P	H
		7320	43.21	-30.79	74	52.01	35.7	13.66	58.16	100	0	P	H
													H
													H
		4880	42.49	-31.51	74	56.7	34	11.03	59.24	100	0	P	V
		7320	43.49	-30.51	74	52.29	35.7	13.66	58.16	100	0	P	V
													V
BLE CH 39 2480MHz		4960	43.64	-30.36	74	57.47	34.1	11.14	59.07	100	0	P	H
		7440	43.81	-30.19	74	52.65	35.7	13.79	58.33	100	0	P	H
													H
													H
		4960	42.65	-31.35	74	56.48	34.1	11.14	59.07	100	0	P	V
		7440	44.31	-29.69	74	53.15	35.7	13.79	58.33	100	0	P	V
													V
Remark	1. No other spurious found. 2. All results are PASS against Peak and Average limit line.												



Emission below 1GHz

2.4GHz BLE (LF)

BLE	Note	Frequency	Level	Over	Limit	Read	Antenna	Path	Preamp	Ant	Table	Peak	Pol.	
		( MHz )	( dBμV/m )	( dB )	( dBμV/m )	( dBμV )	( dB/m )	( dB )	( dB )	( cm )	( deg )	( P/A )	( H/V )	
2.4GHz BLE LF		30.27	23.83	-16.17	40	28.08	24.6	1.33	30.18	-	-	P	H	
		155.28	21.43	-22.07	43.5	32.38	16.81	2.25	30.01	-	-	P	H	
		295.41	24.55	-21.45	46	32.55	19.08	2.86	29.94	-	-	P	H	
		569.5	26.05	-19.95	46	26.45	25.66	3.81	29.87	-	-	P	H	
		799.8	29.67	-16.33	46	26.45	27.96	4.6	29.34	-	-	P	H	
		952.4	32.65	-13.35	46	25.65	30.49	5.05	28.54	100	0	P	H	
													H	
													H	
													H	
													H	
													H	
													H	
			30	31.56	-8.44	40	35.81	24.6	1.33	30.18	100	0	P	V
			67.8	29.97	-10.03	40	46.25	12.14	1.71	30.13	-	-	P	V
			102.36	18.85	-24.65	43.5	30.64	16.25	2.04	30.08	-	-	P	V
			631.8	28.24	-17.76	46	27.97	25.92	4.14	29.79	-	-	P	V
			776	31.24	-14.76	46	28.24	27.95	4.46	29.41	-	-	P	V
			967.1	32.58	-21.42	54	25.09	30.87	5.06	28.44	-	-	P	V
														V
														V
													V	
													V	
													V	
													V	
Remark	1. No other spurious found. 2. All results are PASS against limit line.													



2.4GHz 2400~2483.5MHz

BLE 2Mbps (Band Edge @ 3m)

BLE	Note	Frequency	Level	Over	Limit	Read	Antenna	Path	Preamp	Ant	Table	Peak	Pol.	
		( MHz )	( dBµV/m )	( dB )	( dBµV/m )	( dBµV )	( dB/m )	( dB )	( dB )	( cm )	( deg )	( P/A )	( H/V )	
BLE CH 00 2402MHz		2320.29	55.47	-18.53	74	41.29	31.8	17.31	34.93	313	135	P	H	
		2364.18	47.17	-6.83	54	32.8	31.93	17.38	34.94	313	135	A	H	
	*	2402	103.01	-	-	88.52	32	17.44	34.95	313	135	P	H	
	*	2402	101.8	-	-	87.31	32	17.44	34.95	313	135	A	H	
													H	
													H	
			2389.695	54.49	-19.51	74	39.99	32	17.44	34.94	107	82	P	V
			2321.97	47.15	-6.85	54	32.97	31.8	17.31	34.93	107	82	A	V
	*		2402	103.83	-	-	89.34	32	17.44	34.95	107	82	P	V
	*		2402	102.6	-	-	88.11	32	17.44	34.95	107	82	A	V
													V	
													V	
BLE CH 19 2440MHz		2333.24	54.75	-19.25	74	40.57	31.8	17.31	34.93	300	133	P	H	
		2357.46	47.18	-6.82	54	32.81	31.93	17.38	34.94	300	133	A	H	
	*	2440	102.87	-	-	88.13	32.2	17.5	34.96	300	133	P	H	
	*	2440	101.45	-	-	86.71	32.2	17.5	34.96	300	133	A	H	
			2496.36	54.64	-19.36	74	39.76	32.3	17.56	34.98	300	133	P	H
			2497.62	47.29	-6.71	54	32.41	32.3	17.56	34.98	300	133	A	H
			2328.62	54.55	-19.45	74	40.37	31.8	17.31	34.93	141	82	P	V
			2388.54	47.18	-6.82	54	32.68	32	17.44	34.94	141	82	A	V
	*		2440	103.82	-	-	89.08	32.2	17.5	34.96	141	82	P	V
	*		2440	102.55	-	-	87.81	32.2	17.5	34.96	141	82	A	V
			2492.51	55.24	-18.76	74	40.36	32.3	17.56	34.98	141	82	P	V
			2497.69	47.57	-6.43	54	32.69	32.3	17.56	34.98	141	82	A	V





<b>BLE CH 39 2480MHz</b>	*	2480	101.26	-	-	86.4	32.27	17.56	34.97	329	133	P	H
	*	2480	100.05	-	-	85.19	32.27	17.56	34.97	329	133	A	H
		2483.56	55.09	-18.91	74	40.23	32.27	17.56	34.97	329	133	P	H
		2497.44	47.49	-6.51	54	32.61	32.3	17.56	34.98	329	133	A	H
													H
													H
	*	2480	102.42	-	-	87.56	32.27	17.56	34.97	100	83	P	V
	*	2480	101.2	-	-	86.34	32.27	17.56	34.97	100	83	A	V
		2483.56	55.68	-18.32	74	40.82	32.27	17.56	34.97	100	83	P	V
		2486.68	47.27	-6.73	54	32.41	32.27	17.56	34.97	100	83	A	V
													V
													V
<b>Remark</b>	1. No other spurious found. 2. All results are PASS against Peak and Average limit line.												



2.4GHz 2400~2483.5MHz  
BLE 2Mbps (Harmonic @ 3m)

BLE	Note	Frequency	Level	Over	Limit	Read	Antenna	Path	Preamp	Ant	Table	Peak	Pol.	
		( MHz )	( dBμV/m )	( dB )	Line	( dBμV )	( dB/m )	( dB )	( dB )	( cm )	( deg )	Avg.	(H/V)	
BLE CH 00 2402MHz		4804	42.7	-31.3	74	57.25	33.9	10.93	59.38	100	0	P	H	
													H	
													H	
													H	
		4804	42.16	-31.84	74	56.71	33.9	10.93	59.38	100	0	P	V	
														V
														V
BLE CH 19 2440MHz		4880	43.35	-30.65	74	57.56	34	11.03	59.24	100	0	P	H	
		7320	43	-31	74	51.8	35.7	13.66	58.16	100	0	P	H	
													H	
													H	
		4880	43.24	-30.76	74	57.45	34	11.03	59.24	100	0	P	V	
		7320	43.54	-30.46	74	52.34	35.7	13.66	58.16	100	0	P	V	
														V
BLE CH 39 2480MHz		4960	44.53	-29.47	74	58.36	34.1	11.14	59.07	100	0	P	H	
		7440	43.24	-30.76	74	52.08	35.7	13.79	58.33	100	0	P	H	
													H	
													H	
		4960	42.87	-31.13	74	56.7	34.1	11.14	59.07	100	0	P	V	
		7440	43.88	-30.12	74	52.72	35.7	13.79	58.33	100	0	P	V	
														V
Remark	1. No other spurious found. 2. All results are PASS against Peak and Average limit line.													



Emission below 1GHz

2.4GHz BLE (LF)

BLE	Note	Frequency	Level	Over	Limit	Read	Antenna	Path	Preamp	Ant	Table	Peak	Pol.	
		( MHz )	( dBμV/m )	( dB )	( dBμV/m )	( dBμV )	( dB/m )	( dB )	( dB )	( cm )	( deg )	( P/A )	( H/V )	
2.4GHz BLE LF		30.27	22.09	-17.91	40	26.34	24.6	1.33	30.18	100	0	P	H	
		155.82	20.95	-22.55	43.5	31.95	16.76	2.25	30.01	-	-	P	H	
		285.69	24.59	-21.41	46	32.8	18.87	2.86	29.94	-	-	P	H	
		305.6	26.4	-19.6	46	34.15	19.23	2.96	29.94	-	-	P	H	
		764.8	29.59	-16.41	46	26.7	27.88	4.46	29.45	-	-	P	H	
		964.3	32.66	-21.34	54	25.18	30.88	5.06	28.46	-	-	P	H	
														H
														H
														H
														H
														H
														H
			30	32.55	-7.45	40	36.8	24.6	1.33	30.18	100	0	P	V
			67.8	22.72	-17.28	40	39	12.14	1.71	30.13	-	-	P	V
			133.95	17.81	-25.69	43.5	28.43	17.41	2.01	30.04	-	-	P	V
			567.4	25.99	-20.01	46	26.35	25.7	3.81	29.87	-	-	P	V
			840.4	30.14	-15.86	46	26.05	28.51	4.74	29.16	-	-	P	V
			970.6	32.67	-21.33	54	25.17	30.86	5.06	28.42	-	-	P	V
														V
														V
													V	
													V	
													V	
													V	
Remark	1. No other spurious found. 2. All results are PASS against limit line.													



<For Sample 1>

<Adapter 2>

2.4GHz 2400~2483.5MHz

BLE 2Mbps (Band Edge @ 3m)

BLE	Note	Frequency	Level	Over	Limit	Read	Antenna	Path	Preamp	Ant	Table	Peak	Pol.
		( MHz )	( dBμV/m )	( dB )	( dBμV/m )	( dBμV )	( dB/m )	( dB )	( dB )	( cm )	( deg )	( P/A )	( H/V )
BLE CH 19 2440MHz		2356.9	55.41	-18.59	74	41.05	31.93	17.37	34.94	299	130	P	H
		2343.88	47.79	-6.21	54	33.46	31.9	17.37	34.94	299	130	A	H
	*	2440	102.97	-	-	88.23	32.2	17.5	34.96	299	130	P	H
	*	2440	101.55	-	-	86.81	32.2	17.5	34.96	299	130	A	H
		2488.52	54.64	-19.36	74	39.75	32.3	17.56	34.97	299	130	P	H
		2497.62	47.29	-6.71	54	32.41	32.3	17.56	34.98	299	130	A	H
		2316.3	55.31	-18.69	74	41.23	31.7	17.31	34.93	140	80	P	V
		2388.54	47.18	-6.82	54	32.68	32	17.44	34.94	140	80	A	V
	*	2440	103.7	-	-	88.96	32.2	17.5	34.96	140	80	P	V
	*	2440	102.57	-	-	87.83	32.2	17.5	34.96	140	80	A	V
		2487.4	55.26	-18.74	74	40.4	32.27	17.56	34.97	140	80	P	V
		2497.76	47.26	-6.74	54	32.38	32.3	17.56	34.98	140	80	A	V
Remark	1. No other spurious found. 2. All results are PASS against Peak and Average limit line.												



2.4GHz 2400~2483.5MHz  
BLE 2Mbps (Harmonic @ 3m)

BLE	Note	Frequency	Level	Over	Limit	Read	Antenna	Path	Preamp	Ant	Table	Peak	Pol.	
		( MHz )	( dBμV/m )	( dB )	Limit	Level	Factor	Loss	Factor	Pos	Pos	Avg.		
					Line	( dBμV )	( dB/m )	( dB )	( dB )	( cm )	( deg )	( P/A )	( H/V )	
BLE CH 19 2440MHz		4880	42.18	-31.82	74	56.39	34	11.03	59.24	100	0	P	H	
		7320	44.26	-29.74	74	53.06	35.7	13.66	58.16	100	0	P	H	
													H	
													H	
		4880	43.11	-30.89	74	57.32	34	11.03	59.24	100	0	P	V	
		7320	43.27	-30.73	74	52.07	35.7	13.66	58.16	100	0	P	V	
														V
														V
Remark	1. No other spurious found. 2. All results are PASS against Peak and Average limit line.													



Emission below 1GHz

2.4GHz BLE (LF)

BLE	Note	Frequency	Level	Over	Limit	Read	Antenna	Path	Preamp	Ant	Table	Peak	Pol.		
		( MHz )	( dBμV/m )	( dB )	( dBμV/m )	( dBμV )	( dB/m )	( dB )	( dB )	( cm )	( deg )	( P/A )	( H/V )		
2.4GHz BLE LF		30.54	23.21	-16.79	40	27.97	24.09	1.33	30.18	-	-	P	H		
		163.38	26.82	-16.68	43.5	38.42	16.15	2.25	30	-	-	P	H		
		290.55	27.44	-18.56	46	35.55	18.97	2.86	29.94	-	-	P	H		
		873.3	32.65	-13.35	46	27.84	28.95	4.88	29.02	-	-	P	H		
		925.1	33.25	-12.75	46	27.68	29.33	4.97	28.73	-	-	P	H		
		955.2	34.33	-11.67	46	27.16	30.64	5.05	28.52	100	0	P	H		
														H	
															H
															H
															H
															H
															H
			30	34.9	-5.1	40	39.15	24.6	1.33	30.18	100	0	P	V	
			146.91	24.77	-18.73	43.5	35.4	17.15	2.24	30.02	-	-	P	V	
			258.96	24.45	-21.55	46	32.35	19.42	2.63	29.95	-	-	P	V	
			721.4	33.23	-12.77	46	31.62	26.83	4.36	29.58	-	-	P	V	
			933.5	33.59	-12.41	46	27.7	29.59	4.97	28.67	-	-	P	V	
			958	34.32	-11.68	46	26.97	30.8	5.05	28.5	-	-	P	V	
															V
															V
														V	
														V	
														V	
Remark	1. No other spurious found. 2. All results are PASS against limit line.														



<For Sample 2>

<Adapter 1>

2.4GHz 2400~2483.5MHz

BLE 2Mbps (Band Edge @ 3m)

BLE	Note	Frequency	Level	Over	Limit	Read	Antenna	Path	Preamp	Ant	Table	Peak	Pol.
		( MHz )	( dBμV/m )	( dB )	( dBμV/m )	( dBμV )	( dB/m )	( dB )	( dB )	( cm )	( deg )	( P/A )	( H/V )
BLE CH 19 2440MHz		2352.28	54.49	-19.51	74	40.13	31.93	17.37	34.94	307	107	P	H
		2372.02	46.97	-7.03	54	32.56	31.97	17.38	34.94	307	107	A	H
	*	2440	102.76	-	-	88.02	32.2	17.5	34.96	307	107	P	H
	*	2440	101.46	-	-	86.72	32.2	17.5	34.96	307	107	A	H
		2496.5	54.86	-19.14	74	39.98	32.3	17.56	34.98	307	107	P	H
		2489.92	47.23	-6.77	54	32.34	32.3	17.56	34.97	307	107	A	H
		2332.26	54.22	-19.78	74	40.04	31.8	17.31	34.93	348	55	P	V
		2357.6	46.86	-7.14	54	32.49	31.93	17.38	34.94	348	55	A	V
	*	2440	100.78	-	-	86.04	32.2	17.5	34.96	348	55	P	V
	*	2440	99.4	-	-	84.66	32.2	17.5	34.96	348	55	A	V
		2486.07	54.76	-19.24	74	39.9	32.27	17.56	34.97	348	55	P	V
		2493.7	47.08	-6.92	54	32.2	32.3	17.56	34.98	348	55	A	V
Remark	1. No other spurious found. 2. All results are PASS against Peak and Average limit line.												



2.4GHz 2400~2483.5MHz  
BLE 2Mbps (Harmonic @ 3m)

BLE	Note	Frequency	Level	Over	Limit	Read	Antenna	Path	Preamp	Ant	Table	Peak	Pol.	
		( MHz )	( dBμV/m )	( dB )	( dBμV/m )	( dBμV )	( dB/m )	( dB )	( dB )	( cm )	( deg )	( P/A )	( H/V )	
BLE CH 19 2440MHz		4880	42.16	-31.84	74	56.37	34	11.03	59.24	100	0	P	H	
		7320	42.98	-31.02	74	51.78	35.7	13.66	58.16	100	0	P	H	
													H	
													H	
		4880	43.09	-30.91	74	57.3	34	11.03	59.24	100	0	P	V	
		7320	43.28	-30.72	74	52.08	35.7	13.66	58.16	100	0	P	V	
														V
														V
Remark	1. No other spurious found. 2. All results are PASS against Peak and Average limit line.													





Emission below 1GHz

2.4GHz BLE (LF)

BLE	Note	Frequency	Level	Over	Limit	Read	Antenna	Path	Preamp	Ant	Table	Peak	Pol.	
		( MHz )	( dBμV/m )	( dB )	( dBμV/m )	( dBμV )	( dB/m )	( dB )	( dB )	( cm )	( deg )	( P/A )	( H/V )	
2.4GHz BLE LF		30.27	28.81	-11.19	40	33.06	24.6	1.33	30.18	100	0	P	H	
		48.09	25.37	-14.63	40	39.11	15.07	1.34	30.15			P	H	
		163.38	31.02	-12.48	43.5	42.62	16.15	2.25	30			P	H	
		776	31.22	-14.78	46	28.22	27.95	4.46	29.41			P	H	
		854.4	32.01	-13.99	46	27.49	28.88	4.74	29.1			P	H	
		953.1	33.8	-12.2	46	26.75	30.54	5.05	28.54			P	H	
														H
														H
														H
														H
														H
														H
			30	32.16	-7.84	40	36.41	24.6	1.33	30.18	100	0	P	V
			35.13	29.09	-10.91	40	35.88	22.06	1.33	30.18			P	V
			161.76	26.87	-16.63	43.5	38.27	16.36	2.25	30.01			P	V
			785.8	30.79	-15.21	46	27.6	27.97	4.6	29.38			P	V
			879.6	32.39	-13.61	46	27.59	28.9	4.89	28.99			P	V
			951	34.07	-11.93	46	27.18	30.39	5.05	28.55			P	V
														V
														V
													V	
													V	
													V	
													V	
Remark	1. No other spurious found. 2. All results are PASS against limit line.													



**Note symbol**

*	<b>Fundamental Frequency</b> which can be ignored. However, the level of any unwanted emissions shall not exceed the level of the fundamental frequency.
!	Test result is <b>over limit</b> line.
P/A	<b>Peak</b> or <b>Average</b>
H/V	<b>Horizontal</b> or <b>Vertical</b>



A calculation example for radiated spurious emission is shown as below:

BLE	Note	Frequency	Level	Over	Limit	Read	Antenna	Path	Preamp	Ant	Table	Peak	Pol.
		( MHz )	( dBμV/m )	( dB )	Line	Level	Factor	Loss	Factor	Pos	Pos	Avg.	
					( dBμV/m )	( dBμV )	( dB/m )	( dB )	( dB )	( cm )	( deg )	( P/A )	( H/V )
BLE CH 00 2402MHz		2390	55.45	-18.55	74	54.51	32.22	4.58	35.86	103	308	P	H
		2390	43.54	-10.46	54	42.6	32.22	4.58	35.86	103	308	A	H

- Path Loss(dB) = Cable loss(dB) + Filter loss(dB) + Attenuator loss(dB)
- Level(dBμV/m) =  
Antenna Factor(dB/m) + Path Loss(dB) + Read Level(dBμV) - Preamp Factor(dB)
- Over Limit(dB) = Level(dBμV/m) – Limit Line(dBμV/m)

**For Peak Limit @ 2390MHz:**

- Level(dBμV/m)  
= Antenna Factor(dB/m) + Path Loss(dB) + Read Level(dBμV) - Preamp Factor(dB)  
= 32.22(dB/m) + 4.58(dB) + 54.51(dBμV) – 35.86 (dB)  
= 55.45 (dBμV/m)
- Over Limit(dB)  
= Level(dBμV/m) – Limit Line(dBμV/m)  
= 55.45(dBμV/m) – 74(dBμV/m)  
= -18.55(dB)

**For Average Limit @ 2390MHz:**

- Level(dBμV/m)  
= Antenna Factor(dB/m) + Path Loss(dB) + Read Level(dBμV) - Preamp Factor(dB)  
= 32.22(dB/m) + 4.58(dB) + 42.6(dBμV) – 35.86 (dB)  
= 43.54 (dBμV/m)
- Over Limit(dB)  
= Level(dBμV/m) – Limit Line(dBμV/m)  
= 43.54(dBμV/m) – 54(dBμV/m)  
= -10.46(dB)

Both peak and average measured complies with the limit line, so test result is "PASS".



## Appendix D. Radiated Spurious Emission Plots

Test Engineer :	Jack Cheng, Lance Chiang, and Peter Liao	Temperature :	22~24°C
		Relative Humidity :	52~60%

### Note symbol

-L	Low channel location
-R	High channel location



<For Sample 1>

<Adapter 1>

2.4GHz 2400~2483.5MHz

BLE 1Mbps (Band Edge @ 3m)

BLE	2.4GHz 2400~2483.5MHz Band Edge @ 3m	
	BLE CH00 2402MHz	
	Horizontal	Fundamental
Peak	<p>Site : 03CH07-HY Condition : PEAK_BE_74 3m HF_ANT_00211469 HORIZONTAL</p>	<p>Site : 03CH07-HY Condition : PEAK_74 3m HF_ANT_00211469 HORIZONTAL</p>
Avg.	<p>Site : 03CH07-HY Condition : AVG_BE_54 3m HF_ANT_00211469 HORIZONTAL</p>	<p>Site : 03CH07-HY Condition : AVG_54 3m HF_ANT_00211469 HORIZONTAL</p>



BLE	2.4GHz 2400~2483.5MHz Band Edge @ 3m	
	BLE CH00 2402MHz	
	Vertical	Fundamental
Peak	<p>Level (dBu/m)</p> <p>Date: 2018-12-11</p> <p>Site : 03CH07-HY Condition : PEAK_BE_74 3m HF_ANT_00211469 VERTICAL</p> <p>Frequency (MHz)</p>	<p>Level (dBu/m)</p> <p>Date: 2018-12-11</p> <p>Site : 03CH07-HY Condition : PEAK_74 3m HF_ANT_00211469 VERTICAL</p> <p>Frequency (MHz)</p>
Avg.	<p>Level (dBu/m)</p> <p>Date: 2018-12-11</p> <p>Site : 03CH07-HY Condition : AVG_BE_54 3m HF_ANT_00211469 VERTICAL</p> <p>Frequency (MHz)</p>	<p>Level (dBu/m)</p> <p>Date: 2018-12-11</p> <p>Site : 03CH07-HY Condition : AVG_54 3m HF_ANT_00211469 VERTICAL</p> <p>Frequency (MHz)</p>



BLE	2.4GHz 2400~2483.5MHz Band Edge @ 3m	
	BLE CH19 2440MHz - L	
	Horizontal	Fundamental
Peak	<p>Site : 03CH07-HY Condition : PEAK_BE_74 3m HF_ANT_00211469 HORIZONTAL</p>	<p>Site : 03CH07-HY Condition : PEAK_74 3m HF_ANT_00211469 HORIZONTAL</p>
Avg.	<p>Site : 03CH07-HY Condition : AVG_BE_54 3m HF_ANT_00211469 HORIZONTAL</p>	<p>Site : 03CH07-HY Condition : AVG_54 3m HF_ANT_00211469 HORIZONTAL</p>

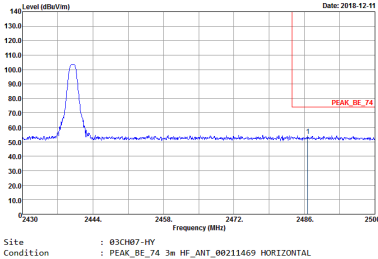
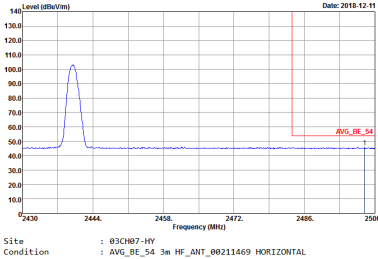

BLE	2.4GHz 2400~2483.5MHz Band Edge @ 3m	
	BLE CH19 2440MHz - R	
	Horizontal	Fundamental
Peak	 <p>Site : 03CH07-HY Condition : PEAK_BE_74 3m HF_ANT_00211469 HORIZONTAL</p>	Left blank
Avg.	 <p>Site : 03CH07-HY Condition : AVG_BE_54 3m HF_ANT_00211469 HORIZONTAL</p>	Left blank



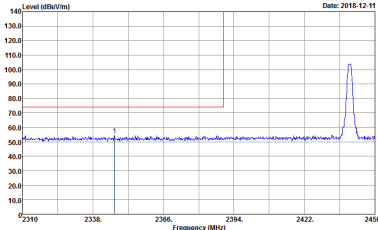
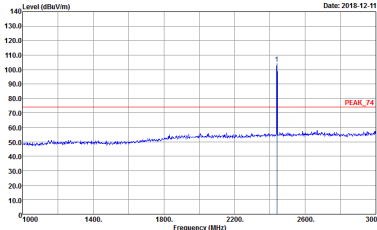
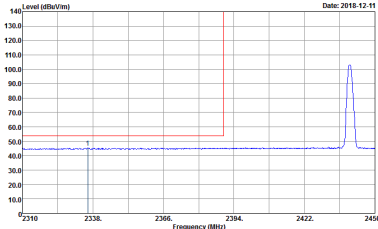
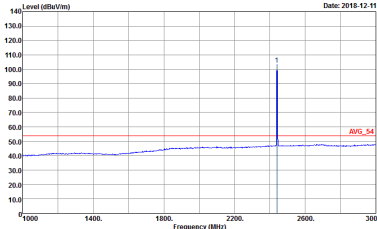

BLE	2.4GHz 2400~2483.5MHz Band Edge @ 3m	
BLE CH19 2440MHz - L		
Vertical		Fundamental
Peak	 <p>Level (dBu/m) vs Frequency (MHz) plot showing a peak at approximately 2440 MHz. The y-axis ranges from 10.0 to 140.0 dBu/m, and the x-axis ranges from 2310 to 2450 MHz. A red line indicates the peak level at approximately 105 dBu/m.</p> <p>Site : 03CH07-HY Condition : PEAK_BE_74 3m HF_ANT_00211469 VERTICAL</p>	 <p>Level (dBu/m) vs Frequency (MHz) plot showing a peak at approximately 2440 MHz. The y-axis ranges from 10.0 to 140.0 dBu/m, and the x-axis ranges from 1000 to 3000 MHz. A red line indicates the peak level at approximately 75 dBu/m, labeled as PEAK_74.</p> <p>Site : 03CH07-HY Condition : PEAK_74 3m HF_ANT_00211469 VERTICAL</p>
Avg.	 <p>Level (dBu/m) vs Frequency (MHz) plot showing the average level. The y-axis ranges from 10.0 to 140.0 dBu/m, and the x-axis ranges from 2310 to 2450 MHz. A red line indicates the average level at approximately 50 dBu/m.</p> <p>Site : 03CH07-HY Condition : AVG_BE_54 3m HF_ANT_00211469 VERTICAL</p>	 <p>Level (dBu/m) vs Frequency (MHz) plot showing the average level. The y-axis ranges from 10.0 to 140.0 dBu/m, and the x-axis ranges from 1000 to 3000 MHz. A red line indicates the average level at approximately 50 dBu/m, labeled as AVG_54.</p> <p>Site : 03CH07-HY Condition : AVG_54 3m HF_ANT_00211469 VERTICAL</p>



BLE	2.4GHz 2400~2483.5MHz Band Edge @ 3m	
	BLE CH19 2440MHz - R	
	Vertical	Fundamental
<p><b>Peak</b></p>		<p>Left blank</p>
<p><b>Avg.</b></p>		<p>Left blank</p>

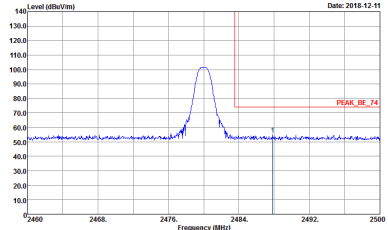
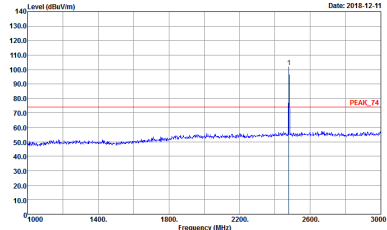
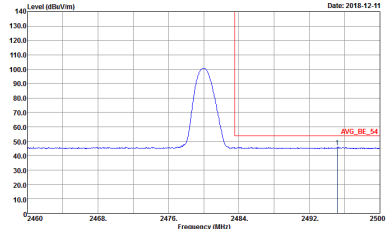
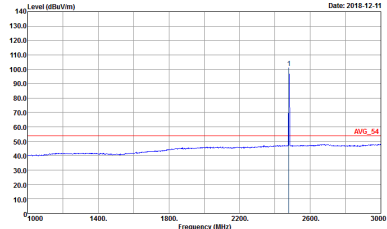

BLE	2.4GHz 2400~2483.5MHz Band Edge @ 3m	
BLE CH39 2480MHz		
Horizontal		Fundamental
Peak	 <p>Site : 03CH07-HY Condition : PEAK_BE_74 3m HF_ANT_00211469 HORIZONTAL</p>	 <p>Site : 03CH07-HY Condition : PEAK_74 3m HF_ANT_00211469 HORIZONTAL</p>
Avg.	 <p>Site : 03CH07-HY Condition : AVG_BE_54 3m HF_ANT_00211469 HORIZONTAL</p>	 <p>Site : 03CH07-HY Condition : AVG_54 3m HF_ANT_00211469 HORIZONTAL</p>

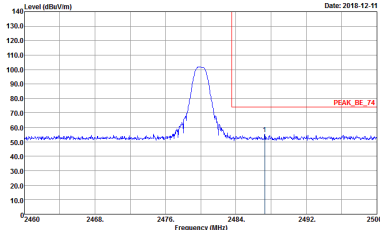
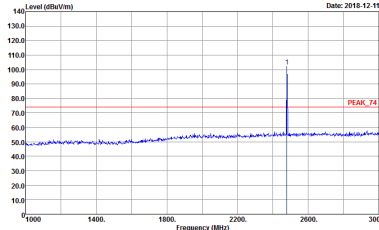
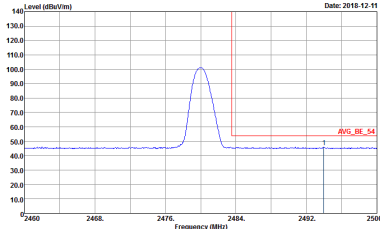
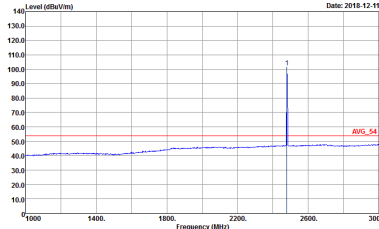

BLE	2.4GHz 2400~2483.5MHz Band Edge @ 3m	
BLE CH39 2480MHz		
	Vertical	Fundamental
Peak	 <p>Level (dBu/m) vs Frequency (MHz) plot showing a peak at 2480 MHz. The peak level is approximately 105 dBu/m. The plot is titled 'Date: 2018-12-11'. A red line indicates the peak level, labeled 'PEAK_BE_74'.</p> <p>Site : 03CH07-HY Condition : PEAK_BE_74 3m HF_ANT_00211469 VERTICAL</p>	 <p>Level (dBu/m) vs Frequency (MHz) plot showing a peak at 2480 MHz. The peak level is approximately 105 dBu/m. The plot is titled 'Date: 2018-12-11'. A red line indicates the peak level, labeled 'PEAK_F4'.</p> <p>Site : 03CH07-HY Condition : PEAK_F4 3m HF_ANT_00211469 VERTICAL</p>
Avg.	 <p>Level (dBu/m) vs Frequency (MHz) plot showing the average level at 2480 MHz. The average level is approximately 55 dBu/m. The plot is titled 'Date: 2018-12-11'. A red line indicates the average level, labeled 'AVG_BE_54'.</p> <p>Site : 03CH07-HY Condition : AVG_BE_54 3m HF_ANT_00211469 VERTICAL</p>	 <p>Level (dBu/m) vs Frequency (MHz) plot showing the average level at 2480 MHz. The average level is approximately 55 dBu/m. The plot is titled 'Date: 2018-12-11'. A red line indicates the average level, labeled 'AVG_F4'.</p> <p>Site : 03CH07-HY Condition : AVG_F4 3m HF_ANT_00211469 VERTICAL</p>



2.4GHz 2400~2483.5MHz

BLE 1Mbps (Harmonic @ 3m)

BLE	2.4GHz 2400~2483.5MHz Harmonic @ 3m	
	BLE CH00 2402MHz	
	Horizontal	Vertical
<b>Peak</b> <b>Avg.</b>	<p>Site : 03CH07-HY Condition : PEAK_74 3m SHF-EHF_131029 HORIZONTAL</p>	<p>Site : 03CH07-HY Condition : PEAK_74 3m SHF-EHF_131029 VERTICAL</p>

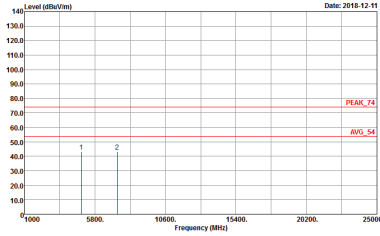
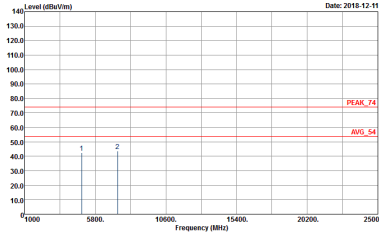

BLE	2.4GHz 2400~2483.5MHz Harmonic @ 3m	
	BLE CH19 2440MHz	
	Horizontal	Vertical
Peak Avg.	 <p>Site : 03CH07-HY Condition : PEAK_74 3m SHF-EHF_131029 HORIZONTAL</p>	 <p>Site : 03CH07-HY Condition : PEAK_74 3m SHF-EHF_131029 VERTICAL</p>

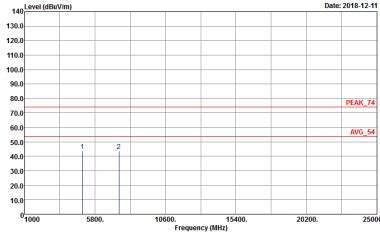
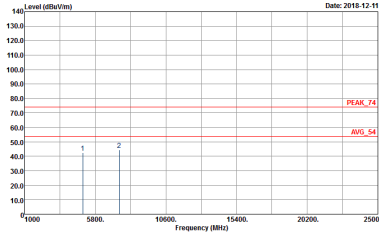

BLE	2.4GHz 2400~2483.5MHz Harmonic @ 3m	
	BLE CH39 2480MHz	
	Horizontal	Vertical
Peak	 <p>Site : 03CH07-HY Condition : PEAK_74 3m SHF-EHF_131029 HORIZONTAL</p>	 <p>Site : 03CH07-HY Condition : PEAK_74 3m SHF-EHF_131029 VERTICAL</p>



Emission below 1GHz

2.4GHz BLE (LF)

BLE	2.4GHz 2400~2483.5MHz	
BLE LF		
Horizontal		Vertical
QP / Peak	<p>Site : 03CH07-HY Condition : QP 3m LF-ANT-35419(G) HORIZONTAL</p>	<p>Site : 03CH07-HY Condition : QP 3m LF-ANT-35419(G) VERTICAL</p>





2.4GHz 2400~2483.5MHz

BLE 2Mbps (Band Edge @ 3m)

BLE	2.4GHz 2400~2483.5MHz Band Edge @ 3m	
BLE CH00 2402MHz		
Horizontal		Fundamental
Peak		
Avg.		

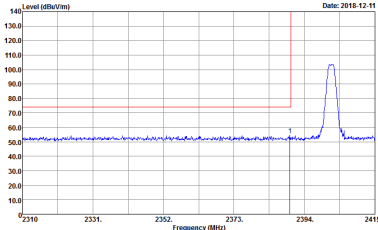
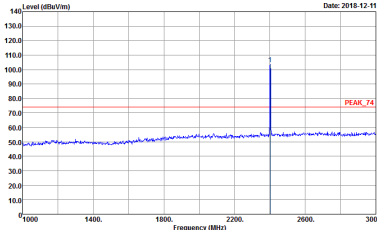
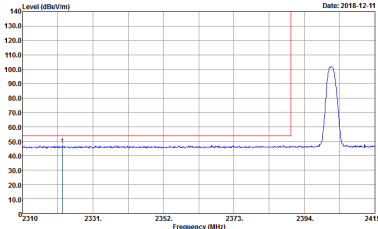
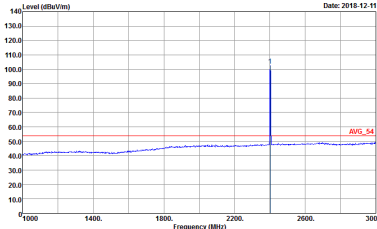

BLE	2.4GHz 2400~2483.5MHz Band Edge @ 3m	
BLE CH00 2402MHz		
Vertical		Fundamental
Peak	 <p>Level (dBu/m) vs Frequency (MHz) plot showing a peak at 2394 MHz. The y-axis ranges from 10.0 to 140.0 dBu/m, and the x-axis ranges from 2310 to 2415 MHz. A red vertical line marks the peak at 2394 MHz.</p> <p>Site : 03CH07-HY Condition : PEAK_BE_74 3m HF_ANT_00211469 VERTICAL</p>	 <p>Level (dBu/m) vs Frequency (MHz) plot showing a peak at 2402 MHz. The y-axis ranges from 10.0 to 140.0 dBu/m, and the x-axis ranges from 1000 to 3000 MHz. A red vertical line marks the peak at 2402 MHz, labeled 'PEAK_74'.</p> <p>Site : 03CH07-HY Condition : PEAK_74 3m HF_ANT_00211469 VERTICAL</p>
Avg.	 <p>Level (dBu/m) vs Frequency (MHz) plot showing the average spectrum. The y-axis ranges from 10.0 to 140.0 dBu/m, and the x-axis ranges from 2310 to 2415 MHz. A red vertical line marks the peak at 2394 MHz.</p> <p>Site : 03CH07-HY Condition : AVG_BE_54 3m HF_ANT_00211469 VERTICAL</p>	 <p>Level (dBu/m) vs Frequency (MHz) plot showing the average spectrum. The y-axis ranges from 10.0 to 140.0 dBu/m, and the x-axis ranges from 1000 to 3000 MHz. A red vertical line marks the peak at 2402 MHz, labeled 'AVG_54'.</p> <p>Site : 03CH07-HY Condition : AVG_54 3m HF_ANT_00211469 VERTICAL</p>



BLE	2.4GHz 2400~2483.5MHz Band Edge @ 3m	
	BLE CH19 2440MHz - L	
	Horizontal	Fundamental
Peak	<p>Site : 03CH07-HY Condition : PEAK_BE_74 3m HF_ANT_00211469 HORIZONTAL</p>	<p>Site : 03CH07-HY Condition : PEAK_74 3m HF_ANT_00211469 HORIZONTAL</p>
Avg.	<p>Site : 03CH07-HY Condition : AVG_BE_54 3m HF_ANT_00211469 HORIZONTAL</p>	<p>Site : 03CH07-HY Condition : AVG_54 3m HF_ANT_00211469 HORIZONTAL</p>

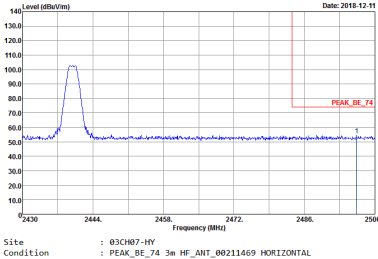
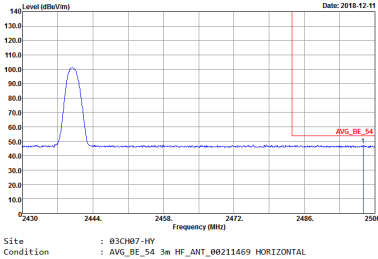

BLE	2.4GHz 2400~2483.5MHz Band Edge @ 3m	
	BLE CH19 2440MHz - R	
	Horizontal	Fundamental
Peak	 <p>Site : 03CH07-HY Condition : PEAK_BE_74 3m HF_ANT_00211469 HORIZONTAL</p>	Left blank
Avg.	 <p>Site : 03CH07-HY Condition : AVG_BE_54 3m HF_ANT_00211469 HORIZONTAL</p>	Left blank

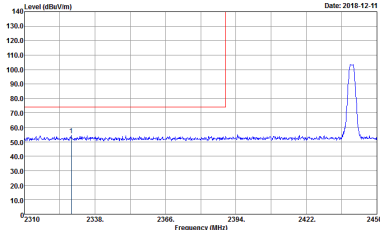
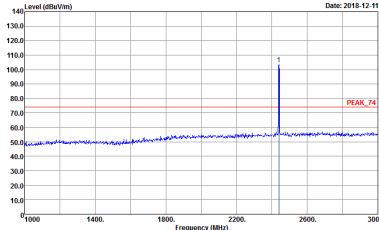
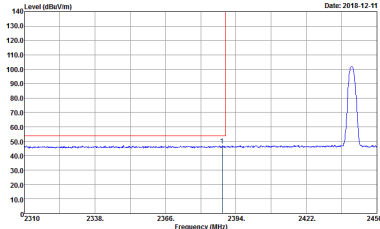
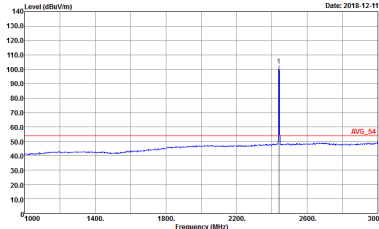

BLE	2.4GHz 2400~2483.5MHz Band Edge @ 3m	
BLE CH19 2440MHz - L		
Vertical		Fundamental
Peak	 <p>Level (dBu/m) vs Frequency (MHz) plot showing a peak at approximately 2440 MHz. The y-axis ranges from 10.0 to 140.0 dBu/m, and the x-axis ranges from 2310 to 2450 MHz. A red vertical line marks the peak at 2440 MHz.</p> <p>Site : 03CH07-HY Condition : PEAK_BE_74 3m HF_ANT_00211469 VERTICAL</p>	 <p>Level (dBu/m) vs Frequency (MHz) plot showing a peak at approximately 2440 MHz. The y-axis ranges from 10.0 to 140.0 dBu/m, and the x-axis ranges from 1000 to 3000 MHz. A red vertical line marks the peak at 2440 MHz, labeled 'PEAK_74'.</p> <p>Site : 03CH07-HY Condition : PEAK_74 3m HF_ANT_00211469 VERTICAL</p>
Avg.	 <p>Level (dBu/m) vs Frequency (MHz) plot showing the average spectrum. The y-axis ranges from 10.0 to 140.0 dBu/m, and the x-axis ranges from 2310 to 2450 MHz. A red vertical line marks the peak at 2440 MHz.</p> <p>Site : 03CH07-HY Condition : AVG_BE_54 3m HF_ANT_00211469 VERTICAL</p>	 <p>Level (dBu/m) vs Frequency (MHz) plot showing the average spectrum. The y-axis ranges from 10.0 to 140.0 dBu/m, and the x-axis ranges from 1000 to 3000 MHz. A red vertical line marks the peak at 2440 MHz, labeled 'AVG_54'.</p> <p>Site : 03CH07-HY Condition : AVG_54 3m HF_ANT_00211469 VERTICAL</p>



BLE	2.4GHz 2400~2483.5MHz Band Edge @ 3m	
	BLE CH19 2440MHz - R	
	Vertical	Fundamental
<p><b>Peak</b></p>	<p>Site : 03CH07-HY Condition : PEAK_BE_74 3m HF_ANT_00211469 VERTICAL</p>	<p>Left blank</p>
<p><b>Avg.</b></p>	<p>Site : 03CH07-HY Condition : AVG_BE_54 3m HF_ANT_00211469 VERTICAL</p>	<p>Left blank</p>

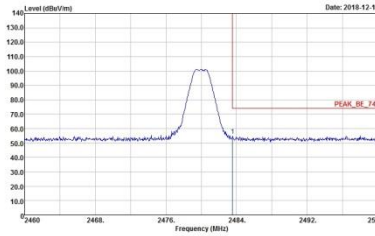
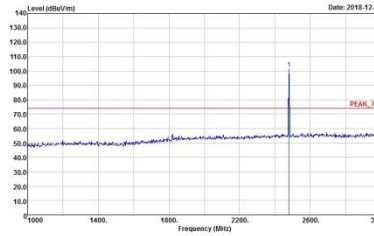
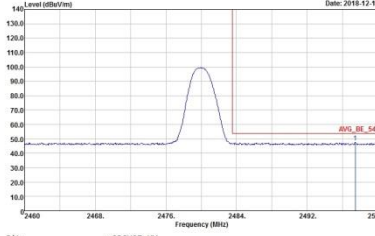
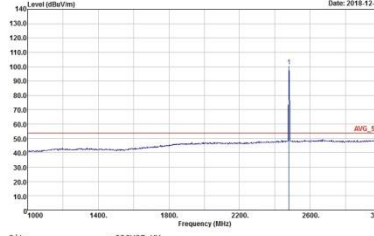

BLE	2.4GHz 2400~2483.5MHz Band Edge @ 3m	
BLE CH39 2480MHz		
	Horizontal	Fundamental
<b>Peak</b>	 <p>Level (dBuV/m) vs Frequency (MHz) plot showing a peak at 2480 MHz. The y-axis ranges from 10.0 to 140.0 dBuV/m, and the x-axis ranges from 2480 to 2500 MHz. A red vertical line marks the peak at 2480 MHz, labeled 'PEAK_BE_74'. The plot shows a signal centered at 2480 MHz with a bandwidth of approximately 10 MHz. The background noise floor is around 50 dBuV/m.</p> <p>Site : 03CH07-HY Condition : PEAK_BE_74 3m HF_ANT_00211469 HORIZONTAL</p>	 <p>Level (dBuV/m) vs Frequency (MHz) plot showing a sharp peak at 2480 MHz. The y-axis ranges from 10.0 to 140.0 dBuV/m, and the x-axis ranges from 1000 to 3000 MHz. A red vertical line marks the peak at 2480 MHz, labeled 'PEAK_74'. The plot shows a very narrow peak at 2480 MHz with a bandwidth of approximately 1 MHz. The background noise floor is around 50 dBuV/m.</p> <p>Site : 03CH07-HY Condition : PEAK_74 3m HF_ANT_00211469 HORIZONTAL</p>
<b>Avg.</b>	 <p>Level (dBuV/m) vs Frequency (MHz) plot showing an averaged peak at 2480 MHz. The y-axis ranges from 10.0 to 140.0 dBuV/m, and the x-axis ranges from 2480 to 2500 MHz. A red vertical line marks the peak at 2480 MHz, labeled 'AVG_BE_54'. The plot shows a broader peak at 2480 MHz with a bandwidth of approximately 10 MHz. The background noise floor is around 50 dBuV/m.</p> <p>Site : 03CH07-HY Condition : AVG_BE_54 3m HF_ANT_00211469 HORIZONTAL</p>	 <p>Level (dBuV/m) vs Frequency (MHz) plot showing an averaged sharp peak at 2480 MHz. The y-axis ranges from 10.0 to 140.0 dBuV/m, and the x-axis ranges from 1000 to 3000 MHz. A red vertical line marks the peak at 2480 MHz, labeled 'AVG_54'. The plot shows a very narrow peak at 2480 MHz with a bandwidth of approximately 1 MHz. The background noise floor is around 50 dBuV/m.</p> <p>Site : 03CH07-HY Condition : AVG_54 3m HF_ANT_00211469 HORIZONTAL</p>



BLE	2.4GHz 2400~2483.5MHz Band Edge @ 3m	
BLE CH39 2480MHz		
	Vertical	Fundamental
Peak	<p>Site : 03CH07-HY Condition : PEAK BE 74 3m HF ANT 00211469 VERTICAL</p>	<p>Site : 03CH07-HY Condition : PEAK_74 3m HF_ANT_00211469 VERTICAL</p>
Avg.	<p>Site : 03CH07-HY Condition : AVG BE 54 3m HF ANT 00211469 VERTICAL</p>	<p>Site : 03CH07-HY Condition : AVG 54 3m HF ANT 00211469 VERTICAL</p>





2.4GHz 2400~2483.5MHz

BLE 2Mbps (Harmonic @ 3m)

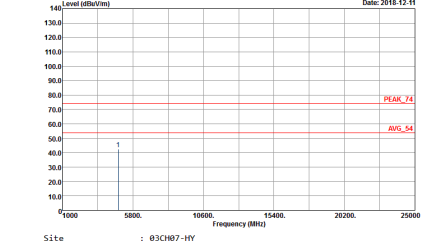
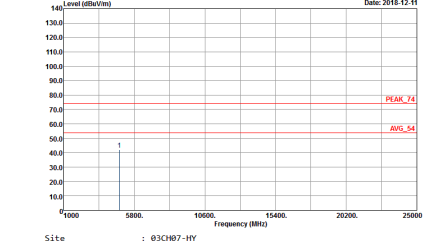
BLE	2.4GHz 2400~2483.5MHz Harmonic @ 3m	
	BLE CH00 2402MHz	
	Horizontal	Vertical
<b>Peak</b> <b>Avg.</b>	 <p>Site : 03CH07-HY Condition : PEAK_74 3m SHF-EHF_131029 HORIZONTAL</p>	 <p>Site : 03CH07-HY Condition : PEAK_74 3m SHF-EHF_131029 VERTICAL</p>

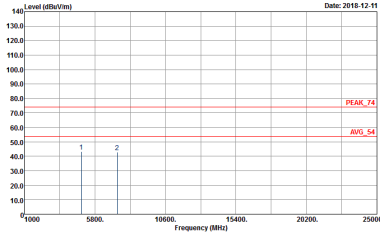
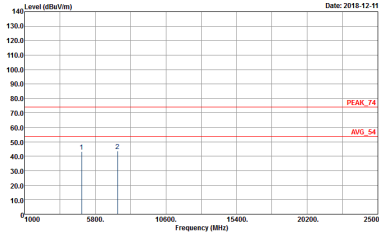

BLE	2.4GHz 2400~2483.5MHz Harmonic @ 3m	
	BLE CH19 2440MHz	
	Horizontal	Vertical
Peak Avg.	 <p>Site : 03CH07-HY Condition : PEAK_74 3m SHF-EHF_131029 HORIZONTAL</p>	 <p>Site : 03CH07-HY Condition : PEAK_74 3m SHF-EHF_131029 VERTICAL</p>

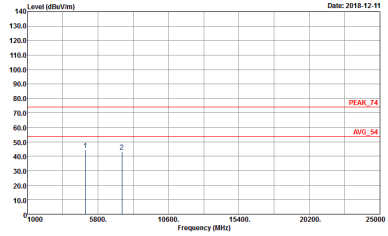
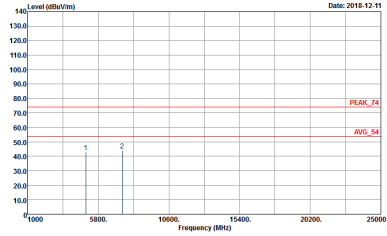

BLE	2.4GHz 2400~2483.5MHz Harmonic @ 3m	
	BLE CH39 2480MHz	
	Horizontal	Vertical
Peak	 <p>Site : 03CH07-HY Condition : PEAK_74 3m SHF-EHF_131029 HORIZONTAL</p>	 <p>Site : 03CH07-HY Condition : PEAK_74 3m SHF-EHF_131029 VERTICAL</p>



Emission below 1GHz

2.4GHz BLE (LF)

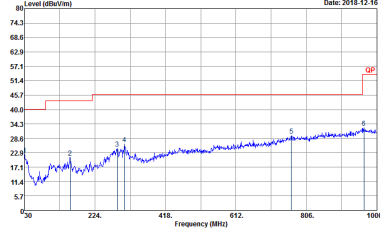
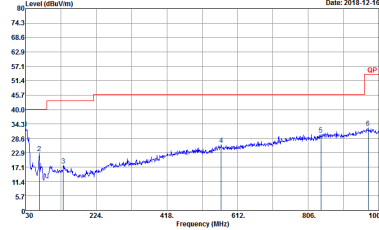
BLE	2.4GHz 2400~2483.5MHz	
	BLE LF	
	Horizontal	Vertical
QP / Peak	 <p>Site : 03CH07-HY Condition : QP 3m LF-ANT-35419(6) HORIZONTAL</p>	 <p>Site : 03CH07-HY Condition : QP 3m LF-ANT-35419(6) VERTICAL</p>



<For Sample 1>

<Adapter 2>

2.4GHz 2400~2483.5MHz

BLE 2Mbps (Band Edge @ 3m)

BLE	2.4GHz 2400~2483.5MHz Band Edge @ 3m	
BLE CH19 2440MHz - L		
Horizontal		Fundamental
Peak		
Avg.		



BLE	2.4GHz 2400~2483.5MHz Band Edge @ 3m	
	BLE CH19 2440MHz - R	
	Horizontal	Fundamental
<p><b>Peak</b></p>		<p>Left blank</p>
<p><b>Avg.</b></p>		<p>Left blank</p>

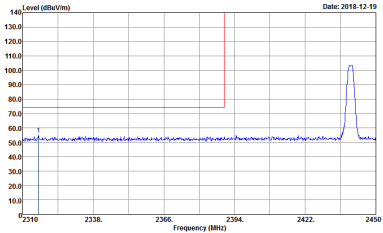
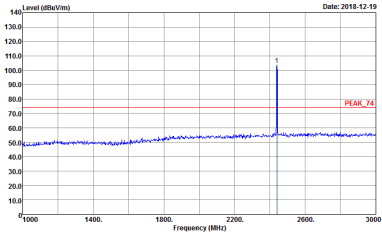
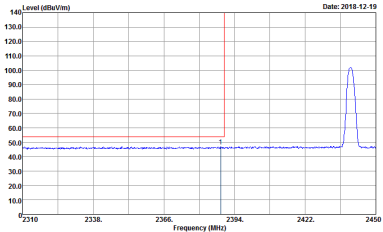
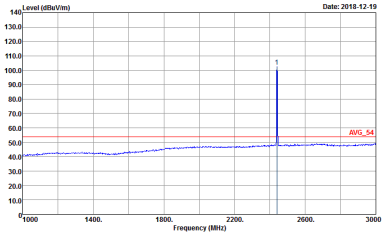

BLE	2.4GHz 2400~2483.5MHz Band Edge @ 3m	
BLE CH19 2440MHz - L		
Vertical		Fundamental
Peak	 <p>Level (dBu/m) vs Frequency (MHz) plot showing a peak at approximately 2440 MHz. The y-axis ranges from 10.0 to 140.0 dBu/m, and the x-axis ranges from 2310 to 2450 MHz. A red vertical line marks the peak frequency.</p> <p>Site : 03CH07-HY Condition : PEAK_BE_74 3m HF_ANT_00211469 VERTICAL</p>	 <p>Level (dBu/m) vs Frequency (MHz) plot showing a peak at approximately 2440 MHz. The y-axis ranges from 10.0 to 140.0 dBu/m, and the x-axis ranges from 1000 to 3000 MHz. A red vertical line marks the peak frequency, labeled 'PEAK_74'.</p> <p>Site : 03CH07-HY Condition : PEAK_74 3m HF_ANT_00211469 VERTICAL</p>
Avg.	 <p>Level (dBu/m) vs Frequency (MHz) plot showing the average level. The y-axis ranges from 10.0 to 140.0 dBu/m, and the x-axis ranges from 2310 to 2450 MHz. A red vertical line marks the peak frequency.</p> <p>Site : 03CH07-HY Condition : AVG_BE_54 3m HF_ANT_00211469 VERTICAL</p>	 <p>Level (dBu/m) vs Frequency (MHz) plot showing the average level. The y-axis ranges from 10.0 to 140.0 dBu/m, and the x-axis ranges from 1000 to 3000 MHz. A red vertical line marks the peak frequency, labeled 'AVG_54'.</p> <p>Site : 03CH07-HY Condition : AVG_54 3m HF_ANT_00211469 VERTICAL</p>



BLE	2.4GHz 2400~2483.5MHz Band Edge @ 3m	
	BLE CH19 2440MHz - R	
	Vertical	Fundamental
Peak		Left blank
Avg.		Left blank



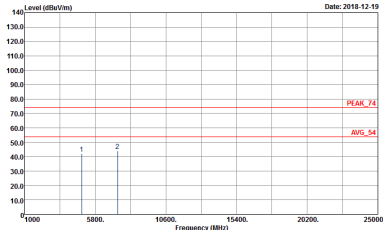
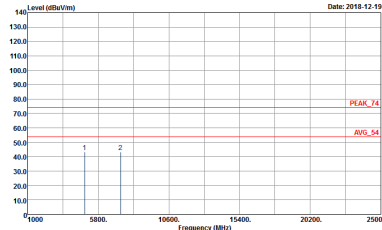

2.4GHz 2400~2483.5MHz  
BLE 2Mbps (Harmonic @ 3m)

BLE	2.4GHz 2400~2483.5MHz Harmonic @ 3m	
	BLE CH19 2440MHz	
	Horizontal	Vertical
<p><b>Peak</b> <b>Avg.</b></p>	 <p>Site : 03CH07-HY Condition : PEAK_74 3m SHF-EHF_131029 HORIZONTAL</p>	 <p>Site : 03CH07-HY Condition : PEAK_74 3m SHF-EHF_131029 VERTICAL</p>



Emission below 1GHz

2.4GHz BLE (LF)

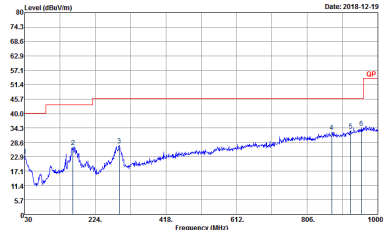
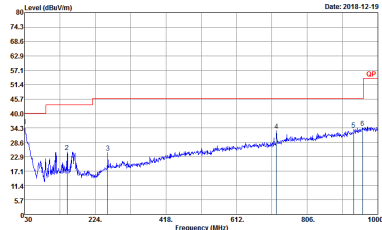
<b>BLE</b>	<b>2.4GHz 2400~2483.5MHz</b>	
	<b>BLE LF</b>	
	<b>Horizontal</b>	<b>Vertical</b>
<b>QP / Peak</b>	 <p>Site : 03CH07-HY Condition : QP 3m LF-ANT-35419(5) HORIZONTAL</p>	 <p>Site : 03CH07-HY Condition : QP 3m LF-ANT-35419(6) VERTICAL</p>



<For Sample 2>

<Adapter 1>

2.4GHz 2400~2483.5MHz

BLE 2Mbps (Band Edge @ 3m)

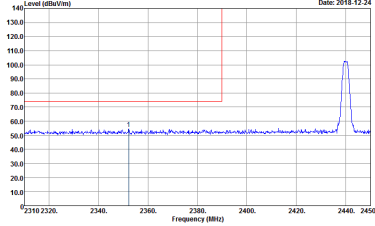
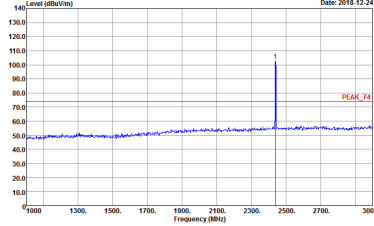
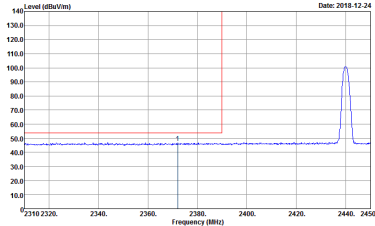
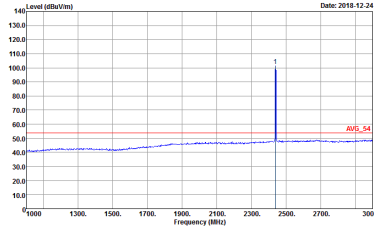
BLE	2.4GHz 2400~2483.5MHz Band Edge @ 3m	
BLE CH19 2440MHz - L		
Horizontal		Fundamental
Peak	 <p>Date: 2018-12-24</p> <p>Site : 03CH07-HY            Condition : PEAK_BE_74 3m HF_ANT_00211469 HORIZONTAL            RBW:1000.000kHz VBW:3000.000kHz SWT:Auto            Detector : Peak            Project : 891148-01            Mode : 2</p>	 <p>Date: 2018-12-24</p> <p>Site : 03CH07-HY            Condition : PEAK_74 3m HF_ANT_00211469 HORIZONTAL            RBW:1000.000kHz VBW:3000.000kHz SWT:Auto            Detector : Peak            Project : 891148-01            Mode : 2</p>
Avg.	 <p>Date: 2018-12-24</p> <p>Site : 03CH07-HY            Condition : AVG_BE_54 3m HF_ANT_00211469 HORIZONTAL            RBW:1000.000kHz VBW:10.000kHz SWT:Auto            Detector : Peak            Project : 891148-01            Mode : 2</p>	 <p>Date: 2018-12-24</p> <p>Site : 03CH07-HY            Condition : AVG_54 3m HF_ANT_00211469 HORIZONTAL            RBW:1000.000kHz VBW:10.000kHz SWT:Auto            Detector : Peak            Project : 891148-01            Mode : 2</p>

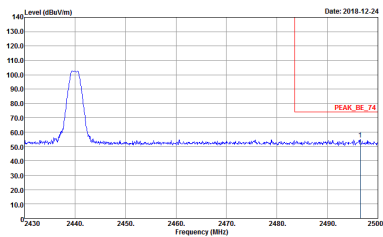
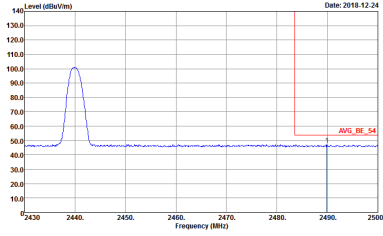

BLE	2.4GHz 2400~2483.5MHz Band Edge @ 3m	
BLE CH19 2440MHz - R		
Horizontal		Fundamental
<p><b>Peak</b></p>	 <p>Site : 03CH07-HY            Condition : PEAK_BE_74 3m HF_ANT_00211469 HORIZONTAL            Detector : Peak            Project : 891148-01            Mode : 2</p>	<p>Left blank</p>
<p><b>Avg.</b></p>	 <p>Site : 03CH07-HY            Condition : AVG_BE_54 3m HF_ANT_00211469 HORIZONTAL            Detector : Peak            Project : 891148-01            Mode : 2</p>	<p>Left blank</p>

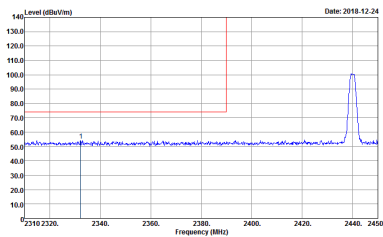
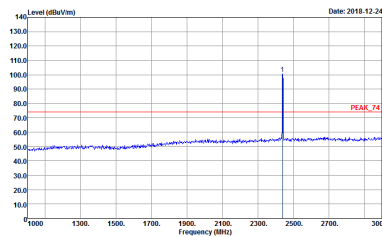
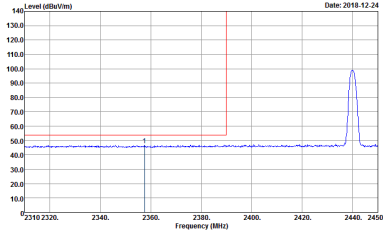
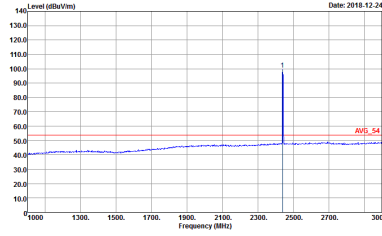

BLE	2.4GHz 2400~2483.5MHz Band Edge @ 3m	
BLE CH19 2440MHz - L		
Vertical		Fundamental
Peak	 <p>Level (dBm/100kHz) vs Frequency (MHz) plot showing a peak at 2440 MHz. The y-axis ranges from 10.0 to 140.0 dBm/100kHz, and the x-axis ranges from 2310 to 2450 MHz. A red line indicates the peak level at approximately 100 dBm/100kHz.</p> <p>Site : 03CH07-HY            Condition : PEAK_BE_74 3m HF_ANT_00211469 VERTICAL            RBW:1000.000kHz VBW:3000.000kHz SWT:Auto            Detector : Peak            Project : 891148-01            Mode : 2</p>	 <p>Level (dBm/100kHz) vs Frequency (MHz) plot showing a peak at 2440 MHz. The y-axis ranges from 10.0 to 140.0 dBm/100kHz, and the x-axis ranges from 1900 to 3000 MHz. A red line indicates the peak level at approximately 74 dBm/100kHz, labeled 'PEAK_74'.</p> <p>Site : 03CH07-HY            Condition : PEAK_74 3m HF_ANT_00211469 VERTICAL            RBW:1000.000kHz VBW:3000.000kHz SWT:Auto            Detector : Peak            Project : 891148-01            Mode : 2</p>
Avg.	 <p>Level (dBm/100kHz) vs Frequency (MHz) plot showing an average level at 2440 MHz. The y-axis ranges from 10.0 to 140.0 dBm/100kHz, and the x-axis ranges from 2310 to 2450 MHz. A red line indicates the average level at approximately 54 dBm/100kHz.</p> <p>Site : 03CH07-HY            Condition : AVG_BE_54 3m HF_ANT_00211469 VERTICAL            RBW:1000.000kHz VBW:10.000kHz SWT:Auto            Detector : Peak            Project : 891148-01            Mode : 2</p>	 <p>Level (dBm/100kHz) vs Frequency (MHz) plot showing an average level at 2440 MHz. The y-axis ranges from 10.0 to 140.0 dBm/100kHz, and the x-axis ranges from 1900 to 3000 MHz. A red line indicates the average level at approximately 54 dBm/100kHz, labeled 'AVG_54'.</p> <p>Site : 03CH07-HY            Condition : AVG_54 3m HF_ANT_00211469 VERTICAL            RBW:1000.000kHz VBW:10.000kHz SWT:Auto            Detector : Peak            Project : 891148-01            Mode : 2</p>

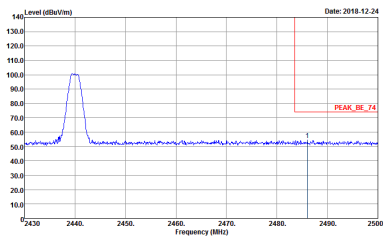
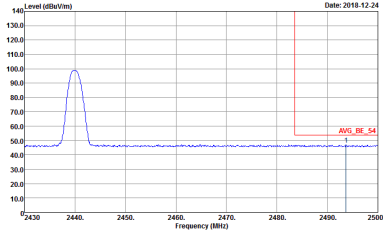

BLE	2.4GHz 2400~2483.5MHz Band Edge @ 3m	
BLE CH19 2440MHz - R		
Vertical		Fundamental
<p><b>Peak</b></p>	 <p>Site : 03CH07-HY            Condition : PEAK_BE_74 3m HF_ANT_00211469 VERTICAL            Detector : Peak            Project : 891148-01            Mode : 2</p>	<p>Left blank</p>
<p><b>Avg.</b></p>	 <p>Site : 03CH07-HY            Condition : AVG_BE_54 3m HF_ANT_00211469 VERTICAL            Detector : Peak            Project : 891148-01            Mode : 2</p>	<p>Left blank</p>

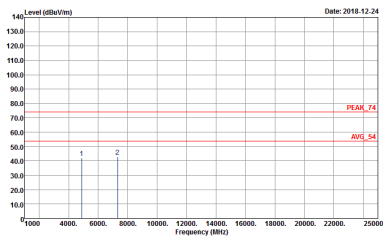
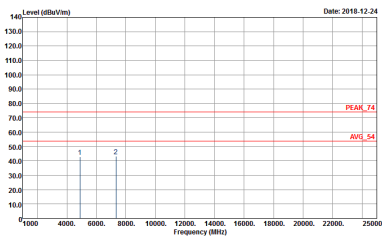

2.4GHz 2400~2483.5MHz  
BLE 2Mbps (Harmonic @ 3m)

BLE	2.4GHz 2400~2483.5MHz Harmonic @ 3m	
	BLE CH19 2440MHz	
	Horizontal	Vertical
<p>Peak Avg.</p>	 <p>Site : 03CH07-0Y Condition : PEAK_74 3m SHF-EHF_131029 HORIZONTAL Detector : Peak Project : 891148-01 Mode : 2</p>	 <p>Site : 03CH07-0Y Condition : PEAK_74 3m SHF-EHF_131029 VERTICAL Detector : Peak Project : 891148-01 Mode : 2</p>



Emission below 1GHz

2.4GHz BLE (LF)

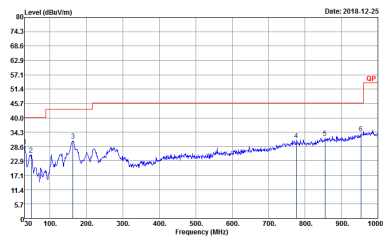
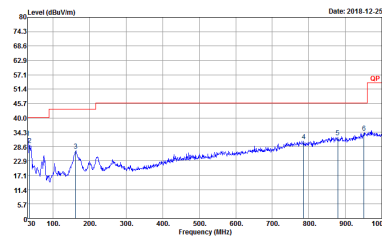
BLE	2.4GHz 2400~2483.5MHz	
	BLE LF	
	Horizontal	Vertical
QP / Peak	 <p>Site : 03CH07-11Y  Condition : QP-3m LF-ANT-35419(6) HORIZONTAL  Detector : Peak  Project : 891148-01  Mode : S</p>	 <p>Site : 03CH07-11Y  Condition : QP-3m LF-ANT-35419(6) VERTICAL  Detector : Peak  Project : 891148-01  Mode : S</p>





## **Appendix E. Duty Cycle Plots**

<b>Band</b>	<b>Duty Cycle(%)</b>	<b>T(us)</b>	<b>1/T(kHz)</b>	<b>VBW Setting</b>	<b>Duty Factor(dB)</b>
Bluetooth – LE for 1Mbps	62.4	390	2.56	3kHz	2.05
Bluetooth – LE for 2Mbps	32.8	205	4.88	10kHz	4.84



**Bluetooth – LE for 1Mbps**

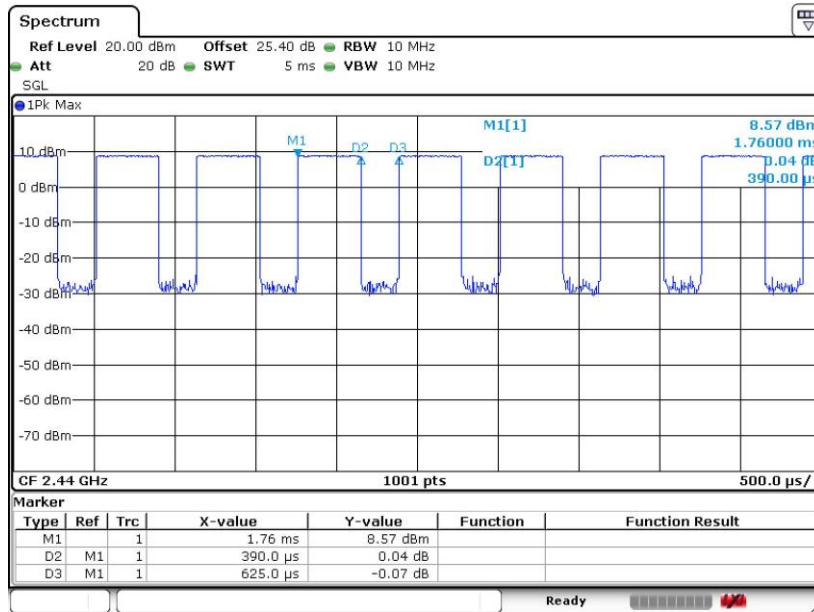

Date: 10.OCT.2018 00:39:45

**Bluetooth – LE for 2Mbps**

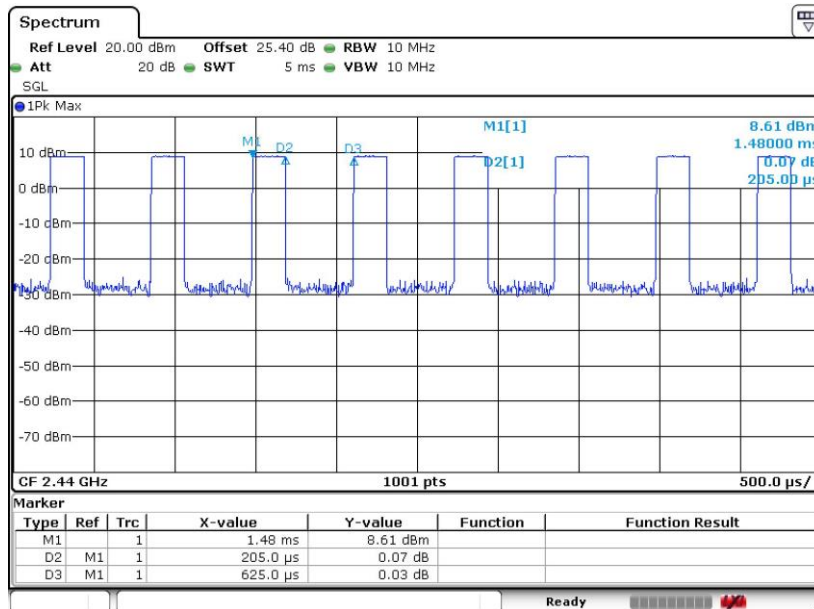

Date: 10.OCT.2018 00:38:12

—————THE END—————