

FCC Test Report

Report No.: RF181001C14-5

FCC ID: A4RG020F

Model Name: G020F

Received Date: Oct. 01, 2018

Test Date: Nov. 10, 2018

Issued Date: Dec. 24, 2018

Applicant: Google LLC

Address: 1600 Amphitheatre Parkway, Mountain View, CA 94043, USA

Issued By: Bureau Veritas Consumer Products Services (H.K.) Ltd., Taoyuan Branch

Lab Address: No. 47-2, 14th Ling, Chia Pau Vil., Lin Kou Dist., New Taipei City, Taiwan (R.O.C.)

Test Location: No. 19, Hwa Ya 2nd Rd., Wen Hwa Vil., Kwei Shan Dist., Taoyuan City 33383, TAIWAN (R.O.C.)

**FCC Registration /
Designation Number:** 788550 / TW0003



This report is for your exclusive use. Any copying or replication of this report to or for any other person or entity, or use of our name or trademark, is permitted only with our prior written permission. This report sets forth our findings solely with respect to the test samples identified herein. The results set forth in this report are not indicative or representative of the quality or characteristics of the lot from which a test sample was taken or any similar or identical product specifically and expressly noted. Our report includes all of the tests requested by you and the results thereof based upon the information that you provided to us. You have 60 days from date of issuance of this report to notify us of any material error or omission caused by our negligence, provided, however, that such notice shall be in writing and shall specifically address the issue you wish to raise. A failure to raise such issue within the prescribed time shall constitute your unqualified acceptance of the completeness of this report, the tests conducted and the correctness of the report contents. Unless specific mention, the uncertainty of measurement has been explicitly taken into account to declare the compliance or non-compliance to the specification. The report must not be used by the client to claim product certification, approval, or endorsement by TAF or any government agencies.

Table of Contents

Release Control Record	3
1 Certificate of Conformity	4
2 Summary of Test Results	5
2.1 Measurement Uncertainty.....	5
2.2 Modification Record.....	5
3 General Information	6
3.1 General Description of EUT.....	6
3.2 Description of Test Modes.....	6
3.2.1 Test Mode Applicability and Tested Channel Deta.....	7
3.3 Description of Support Units.....	8
3.3.1 Configuration of System under Test.....	8
3.4 General Description of Applied Standards.....	8
4 Test Types and Results	9
4.1 Radiated Emission Measurement.....	9
4.1.1 Limits of Radiated Emission Measurement.....	9
4.1.2 Test Instruments.....	10
4.1.3 Test Procedures.....	11
4.1.4 Deviation from Test Standard.....	11
4.1.5 Test Set Up.....	12
4.1.6 EUT Operating Conditions.....	12
4.1.7 Test Results.....	13
4.2 Conducted Emission Measurement.....	21
4.2.1 Limits of Conducted Emission Measurement.....	21
4.2.2 Test Instruments.....	21
4.2.3 Test Procedures.....	22
4.2.4 Deviation from Test Standard.....	22
4.2.5 Test Setup.....	22
4.2.6 EUT Operating Conditions.....	22
4.2.7 Test Results.....	23
4.3 Frequency Stability.....	25
4.3.1 Limits of Frequency Stability Measurement.....	25
4.3.2 Test Setup.....	25
4.3.3 Test Instruments.....	25
4.3.4 Test Procedure.....	25
4.3.5 Deviation from Test Standard.....	26
4.3.6 EUT Operating Conditions.....	26
4.3.7 Test Result.....	26
4.4 20dB Bandwidth.....	27
4.4.1 Limits of 20dB Bandwidth Measurement.....	27
4.4.2 Test Setup.....	27
4.4.3 Test Instruments.....	27
4.4.4 Test Procedures.....	27
4.4.5 Deviation from Test Standard.....	27
4.4.6 EUT Operating Conditions.....	27
4.4.7 Test Results.....	28
5 Pictures of Test Arrangements	29
Appendix – Information of the Testing Laboratories	30

Release Control Record

Issue No.	Description	Date Issued
RF181001C14-5	Original release	Dec. 24, 2018

1 Certificate of Conformity

Product: Smartphone

Model Name: G020F

Sample Status: Identical Prototype

Applicant: Google LLC

Test Date: Nov. 10, 2018

Standards: 47 CFR FCC Part 15, Subpart C (Section 15.225)
47 CFR FCC Part 15, Subpart C (Section 15.215)
ANSI C63.10:2013

The above equipment has been tested by **Bureau Veritas Consumer Products Services (H.K.) Ltd., Taoyuan Branch**, and found compliance with the requirement of the above standards. The test record, data evaluation & Equipment Under Test (EUT) configurations represented herein are true and accurate accounts of the measurements of the sample's RF characteristics under the conditions specified in this report.

Prepared by : Pettie Chen , **Date:** Dec. 24, 2018
Pettie Chen / Senior Specialist

Approved by : Bruce Chen , **Date:** Dec. 24, 2018
Bruce Chen / Project Engineer

2 Summary of Test Results

47 CFR FCC Part 15, Subpart C (Section 15.225, 15.215)			
FCC Clause	Test Item	Result	Remarks
15.207	Conducted emission test	Pass	Meet the requirement of limit. Minimum passing margin is -8.75dB at 1.03366MHz
15.225 (a)	The field strength of any emissions within the band 13.553-13.567 MHz	Pass	Meet the requirement of limit. Minimum passing margin is -68.4dB at 13.56MHz.
15.225 (b)	The field strength of any emissions within the bands 13.410-13.553 MHz and 13.567-13.710 MHz	Pass	Meet the requirement of limit.
15.225 (c)	The field strength of any emissions within the bands 13.110-13.410 MHz and 13.710-14.010 MHz	Pass	Meet the requirement of limit.
15.225 (d)	The field strength of any emissions appearing outside of the 13.110-14.010 MHz band	Pass	Meet the requirement of limit. Minimum passing margin is -5.9dB at 86.28MHz.
15.225 (e)	The frequency tolerance	Pass	Meet the requirement of limit.
15.215 (c)	20dB Bandwidth	Pass	Meet the requirement of limit.

2.1 Measurement Uncertainty

Where relevant, the following measurement uncertainty levels have been estimated for tests performed on the EUT as specified in CISPR 16-4-2:

Measurement	Frequency	Expanded Uncertainty (k=2) (\pm)
Conducted Emissions at mains ports	150kHz ~ 30MHz	2.94 dB
Radiated Emissions up to 1 GHz	9kHz ~ 30MHz	2.38 dB
	30MHz ~ 1GHz	5.54 dB

2.2 Modification Record

There were no modifications required for compliance.

3 General Information

3.1 General Description of EUT

Product	Smartphone
Model Name	G020F
Sample Status	Identical Prototype
Power Supply Rating	3.85Vdc (Battery) 5Vdc or 9Vdc (Adapter) 5Vdc (Host equipment)
Modulation Type	ASK
Data Rate	Type A: 106 kbit/s Type B: 106 kbit/s Type F: 212 kbit/s, 424 kbit/s Type V: 848 kbit/s
Operating Frequency	13.56MHz
Field Strength	15.6dBuV/m
Antenna Type	Loop Antenna
Accessory Device	Refer to Note as below
Data Cable Supplied	Refer to Note as below

Note:

1. There're 2 configurations for the EUT listed as below.
 - Main Sample: EUT + Battery 1
 - 2nd Sample: EUT + Battery 2
 After pre-tested with the EUT, only the worst configuration (main sample) was chosen for the final test.
2. The EUT accessories list refers to EUT Photo.pdf.

3.2 Description of Test Modes

1 channel is provided to this EUT

Channel	Freq. (MHz)
1	13.56

3.2.1 Test Mode Applicability and Tested Channel Data

EUT Configure Mode	Applicable to				Description
	RE	PLC	FS	EB	
-	√	√	√	√	-

Where RE: Radiated Emission
 FS: Frequency Stability
 PLC: Power Line Conducted Emission
 EB: 20dB Bandwidth measurement

Note:

1. The EUT had been pre-tested on the positioned of each 3 axis. The worst case was found when positioned on **Y-plane**.
2. The EUT had been pre-tested on low, middle, high data rate. The worst case was found when data rate was low. Therefore, Type A was chosen for final test.

Radiated Emission Test:

- Pre-Scan has been conducted to determine the worst-case mode from all possible combinations between available modulations, data rates and antenna ports (if EUT with antenna diversity architecture).
- Following channel(s) was (were) selected for the final test as listed below.

EUT Configure Mode	Available Channel	Tested Channel	Modulation Type
-	1	1	ASK

Power Line Conducted Emission Test:

- Pre-Scan has been conducted to determine the worst-case mode from all possible combinations between available modulations, data rates and antenna ports (if EUT with antenna diversity architecture).
- Following channel(s) was (were) selected for the final test as listed below.

EUT Configure Mode	Available Channel	Tested Channel	Modulation Type
-	1	1	ASK

Frequency Stability:

- Pre-Scan has been conducted to determine the worst-case mode from all possible combinations between available modulations, data rates and antenna ports (if EUT with antenna diversity architecture).
- Following channel(s) was (were) selected for the final test as listed below.

EUT Configure Mode	Available Channel	Tested Channel	Modulation Type
-	1	1	ASK

20dB Bandwidth:

- Pre-Scan has been conducted to determine the worst-case mode from all possible combinations between available modulations, data rates and antenna ports (if EUT with antenna diversity architecture).
- Following channel(s) was (were) selected for the final test as listed below.

EUT Configure Mode	Available Channel	Tested Channel	Modulation Type
-	1	1	ASK

Test Condition:

Applicable to	Environmental Conditions	Input Power	Tested by
RE	22 deg. C, 64% RH	120Vac, 60Hz	Adair Peng
PLC	22 deg. C, 66% RH	120Vac, 60Hz	Adair Peng
FS	22 deg. C, 66% RH	120Vac, 60Hz	Adair Peng
BW	22 deg. C, 66% RH	120Vac, 60Hz	Adair Peng

3.3 Description of Support Units

The EUT has been tested as an independent unit.

3.3.1 Configuration of System under Test

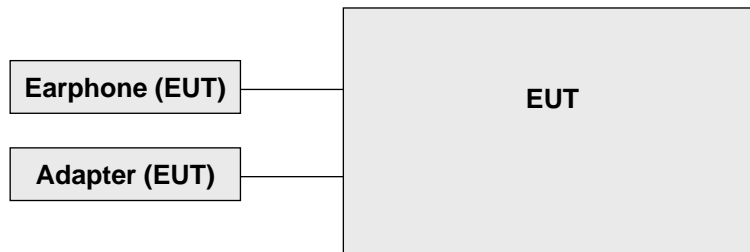

3.4 General Description of Applied Standards

The EUT is a RF Product. According to the specifications of the manufacturer, it must comply with the requirements of the following standards:

FCC Part 15, Subpart C (15.225)

FCC Part 15, Subpart C (15.215)

KDB 414788 D01 Radiated Test Site v01r01

ANSI C63.10-2013

All test items have been performed and recorded as per the above standards.

4 Test Types and Results

4.1 Radiated Emission Measurement

4.1.1 Limits of Radiated Emission Measurement

The field strength of any emissions within the band 13.553-13.567 MHz shall not exceed 15,848 microvolts/meter at 30 meters.

Within the bands 13.410-13.553 MHz and 13.567-13.710 MHz, the field strength of any emissions shall not exceed 334 microvolts/meter at 30 meters.

Within the bands 13.110-13.410 MHz and 13.710-14.010 MHz the field strength of any emissions shall not exceed 106 microvolts/meter at 30 meters.

The field strength of any emissions appearing outside of the 13.110-14.010 MHz band shall not exceed the general radiated emission limits in § 15.209.

Frequencies (MHz)	Field Strength (microvolts/meter)	Measurement Distance (meters)
0.009 ~ 0.490	2400/F(kHz)	300
0.490 ~ 1.705	24000/F(kHz)	30
1.705 ~ 30.0	30	30
30 ~ 88	100	3
88 ~ 216	150	3
216 ~ 960	200	3
Above 960	500	3

Note:

1. The lower limit shall apply at the transition frequencies.
2. Emission level (dBuV/m) = 20 log Emission level (uV/m).
3. For frequencies above 1000MHz, the field strength limits are based on average detector, however, the peak field strength of any emission shall not exceed the maximum permitted average limits, specified above by more than 20dB under any condition of modulation.

4.1.2 Test Instruments

Description & Manufacturer	Model No.	Serial No.	Cal. Date	Cal. Due
Test Receiver ROHDE & SCHWARZ	ESIB7	100187	May 29, 2018	May 28, 2019
Spectrum Analyzer ROHDE & SCHWARZ	FSP40	100041	Dec. 12, 2017	Dec. 11, 2018
BILOG Antenna SCHWARZBECK	VULB9168	9168-171	Dec. 11, 2017	Dec. 10, 2018
HORN Antenna SCHWARZBECK	9120D	209	Nov. 01, 2018	Oct. 31, 2019
HORN Antenna SCHWARZBECK	BBHA 9170	BBHA9170241	Dec. 01, 2017	Nov. 30, 2018
Loop Antenna TESEQ	HLA 6121	45745	Jun. 14, 2018	Jun. 13, 2019
Preamplifier Agilent (Below 1GHz)	8447D	2944A10738	Aug. 21, 2018	Aug. 20, 2019
Preamplifier Agilent (Above 1GHz)	8449B	3008A02465	Apr. 03, 2018	Apr. 02, 2019
RF signal cable HUBER+SUHNER	SUCOFLEX 104	Cable-CH3-03 (223653/4)	Aug. 21, 2018	Aug. 20, 2019
RF signal cable HUBER+SUHNER& EMCI	SUCOFLEX 104&EMC104-SM-S M-8000	Cable-CH3-03 (309224+170907)	Aug. 21, 2018	Aug. 20, 2019
Software BV ADT	ADT_Radiated_ V7.6.15.9.5	NA	NA	NA
Antenna Tower inn-co GmbH	MA 4000	013303	NA	NA
Antenna Tower Controller BV ADT	AT100	AT93021702	NA	NA
Turn Table BV ADT	TT100	TT93021702	NA	NA
Turn Table Controller BV ADT	SC100	SC93021702	NA	NA
Boresight Antenna Fixture	FBA-01	FBA-SIP01	NA	NA

- Note:
1. The calibration interval of the above test instruments is 12 months and the calibrations are traceable to NML/ROC and NIST/USA.
 2. The test was performed in HwaYa Chamber 3.
 3. The horn antenna and preamplifier (model: 8449B) are used only for the measurement of emission frequency above 1GHz if tested.
 4. The FCC Designation Number is TW0003. The number will be varied with the Lab location and scope as attached.
 5. The IC Site Registration No. is 7450F-3.

4.1.3 Test Procedures

For Radiated emission below 30MHz

- a. The EUT was placed on the top of a rotating table 0.8 meters above the ground at a 3 meter chamber room. The table was rotated 360 degrees to determine the position of the highest radiation.
- b. The EUT was set 3 meters away from the interference-receiving antenna, which was mounted on the top of a variable-height antenna tower.
- c. Parallel, perpendicular, and ground-parallel orientations of the antenna are set to make the measurement.
- d. For each suspected emission, the EUT was arranged to its worst case and the rotatable table was turned from 0 degrees to 360 degrees to find the maximum reading.
- e. The test-receiver system was set to Quasi-Peak Detect Function and Specified Bandwidth with Maximum Hold Mode.

Note:

1. The resolution bandwidth and video bandwidth of test receiver/spectrum analyzer is 9kHz at frequency below 30MHz.

For Radiated emission above 30MHz

- a. The EUT was placed on the top of a rotating table 0.8 meters (for 30MHz ~ 1GHz) / 1.5 meters (for above 1GHz) above the ground at 3 meter chamber room for test. The table was rotated 360 degrees to determine the position of the highest radiation.
- b. The EUT was set 3 meters away from the interference-receiving antenna, which was mounted on the top of a variable-height antenna tower.
- c. The height of antenna is varied from one meter to four meters above the ground to determine the maximum value of the field strength. Both horizontal and vertical polarizations of the antenna are set to make the measurement.
- d. For each suspected emission, the EUT was arranged to its worst case and then the antenna was tuned to heights from 1 meter to 4 meters and the rotatable table was turned from 0 degrees to 360 degrees to find the maximum reading.
- e. The test-receiver system was set to quasi-peak detect function and specified bandwidth with maximum hold mode when the test frequency is below 1 GHz.
- f. The test-receiver system was set to peak and average detect function and specified bandwidth with maximum hold mode when the test frequency is above 1 GHz. If the peak reading value also meets average limit, measurement with the average detector is unnecessary.

Note:

1. The resolution bandwidth and video bandwidth of test receiver/spectrum analyzer is 120kHz for Quasi-peak detection (QP) at frequency below 1GHz.
2. The resolution bandwidth of test receiver/spectrum analyzer is 1 MHz and the video bandwidth is 3 MHz for Peak detection (PK) at frequency above 1GHz.
3. The resolution bandwidth of test receiver/spectrum analyzer is 1MHz and the video bandwidth is $\geq 1/T$ (Duty cycle < 98%) or 10Hz (Duty cycle $\geq 98\%$) for Average detection (AV) at frequency above 1GHz.
4. All modes of operation were investigated and the worst-case emissions are reported.

4.1.4 Deviation from Test Standard

No deviation.

4.1.5 Test Set Up

For Radiated emission below 30MHz

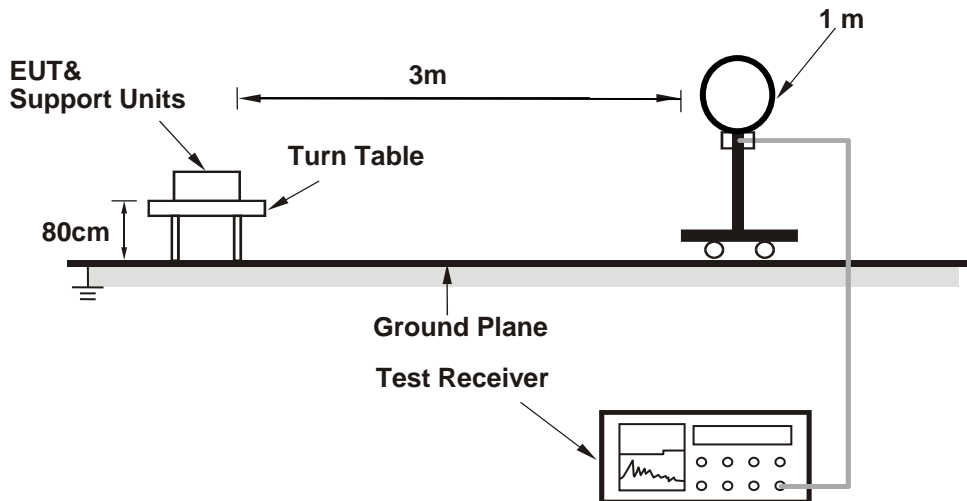

For Radiated emission 30MHz to 1GHz

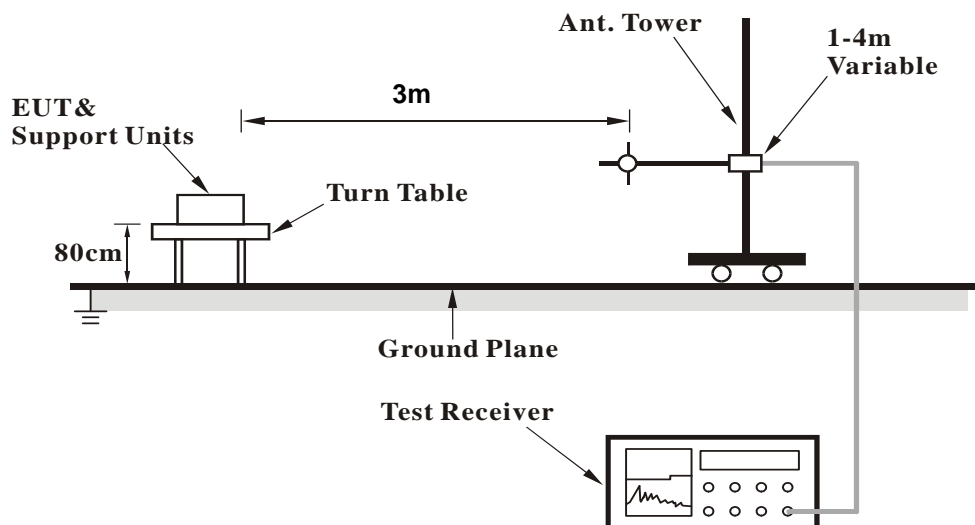

For the actual test configuration, please refer to the attached file (Test Setup Photo).

KDB 414788 OATS and Chamber Correlation Justification

- Based on FCC 15.31 (f) (2): measurements may be performed at a distance closer than that specified in regulations; however, an attempt should be made to avoid making measurements in the near field.
- Open-field site and chamber correlation testing had been performed and chamber measured test result is the worst case test result.

4.1.6 EUT Operating Conditions

- Set the EUT under transmission condition continuously at specific channel frequency.

4.1.7 Test Results

EUT Test Condition		Measurement Detail	
Channel	Channel 1	Frequency Range	13.553 ~ 13.567MHz
Input Power	120Vac, 60Hz	Detector Function	Quasi-Peak
Environmental Conditions	22 deg. C, 66% RH	Tested By	Adair Peng

Antenna Polarity & Test Distance: Loop Antenna Open At 3m								
No.	Freq. (MHz)	Emission Level (dBuV/m)	Limit (dBuV/m)	Margin (dB)	Antenna Height (m)	Table Angle (Degree)	Raw Value (dBuV)	Correction Factor (dB/m)
1	*13.56	55.6 QP	124.0 QP	-68.4	1.00	167	33.8	21.8

Remarks:

1. Emission Level(dBuV/m) = Raw Value(dBuV) + Correction Factor(dB/m)
2. Correction Factor(dB/m) = Antenna Factor(dB/m) + Cable Factor(dB) – Pre-Amplifier Factor(dB)
3. The other emission levels were very low against the limit.
4. Margin value = Emission Level – Limit value
5. “ * ” : Fundamental frequency
6. Above limits have been translated by the formula

The measured field strength was extrapolated to distance 30 meters, using the formula that the limit of field strength varies as the inverse distance square (40dB per decade of distance)

Example:

$$\begin{aligned}
 13.56\text{MHz} &= 15848\mu\text{V/m} && 30\text{m} \\
 &= 84\text{dBuV/m} && 30\text{m} \\
 &= 84+20\log(30/3)^2 && 3\text{m} \\
 &= 124\text{dBuV/m}
 \end{aligned}$$

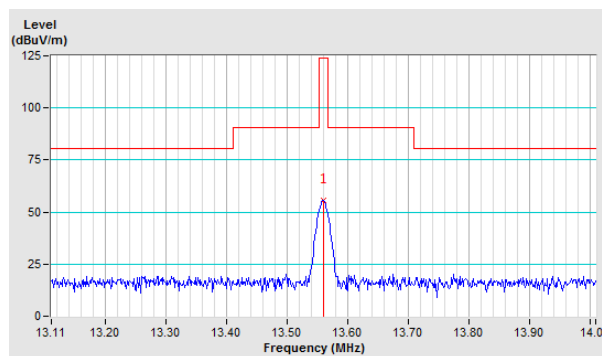

Antenna Polarity & Test Distance: Loop Antenna Open At 30m				
No.	Freq. (MHz)	Emission Level (dBuV/m)	Limit (dBuV/m)	Margin (dB)
1	*13.56	15.6 QP	84.0 QP	-68.4

Remarks: Emission Level at 30m = Emission Level at 3m + 20log(3/30)²

EUT Test Condition		Measurement Detail	
Channel	Channel 1	Frequency Range	13.553 ~ 13.567MHz
Input Power	120Vac, 60Hz	Detector Function	Quasi-Peak
Environmental Conditions	22 deg. C, 66% RH	Tested By	Adair Peng

Antenna Polarity & Test Distance: Loop Antenna Close At 3m								
No.	Freq. (MHz)	Emission Level (dBuV/m)	Limit (dBuV/m)	Margin (dB)	Antenna Height (m)	Table Angle (Degree)	Raw Value (dBuV)	Correction Factor (dB/m)
1	*13.56	52.7 QP	124.0 QP	-71.3	1.00	250	30.9	21.8

Remarks:

1. Emission Level(dBuV/m) = Raw Value(dBuV) + Correction Factor(dB/m)
2. Correction Factor(dB/m) = Antenna Factor(dB/m) + Cable Factor(dB) – Pre-Amplifier Factor(dB)
3. The other emission levels were very low against the limit.
4. Margin value = Emission Level – Limit value
5. “ * ” : Fundamental frequency
6. Above limits have been translated by the formula

The measured field strength was extrapolated to distance 30 meters, using the formula that the limit of field strength varies as the inverse distance square (40dB per decade of distance)

Example:

$$\begin{aligned}
 13.56\text{MHz} &= 15848\text{uV/m} && 30\text{m} \\
 &= 84\text{dBuV/m} && 30\text{m} \\
 &= 84+20\log(30/3)^2 && 3\text{m} \\
 &= 124\text{dBuV/m}
 \end{aligned}$$

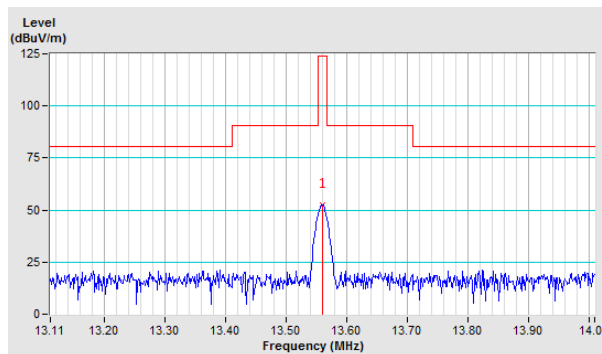

Antenna Polarity & Test Distance: Loop Antenna Open At 30m				
No.	Freq. (MHz)	Emission Level (dBuV/m)	Limit (dBuV/m)	Margin (dB)
1	*13.56	12.7 QP	84.0 QP	-71.3

Remarks: Emission Level at 30m = Emission Level at 3m + 20log(3/30)²

EUT Test Condition		Measurement Detail	
Channel	Channel 1	Frequency Range	13.553 ~ 13.567MHz
Input Power	120Vac, 60Hz	Detector Function	Quasi-Peak
Environmental Conditions	22 deg. C, 66% RH	Tested By	Adair Peng

Antenna Polarity & Test Distance: Loop Antenna Ground-Parallel At 3m								
No.	Freq. (MHz)	Emission Level (dBuV/m)	Limit (dBuV/m)	Margin (dB)	Antenna Height (m)	Table Angle (Degree)	Raw Value (dBuV)	Correction Factor (dB/m)
1	*13.56	51.4 QP	124.0 QP	-72.6	1.00	151	29.6	21.8

Remarks:

1. Emission Level(dBuV/m) = Raw Value(dBuV) + Correction Factor(dB/m)
2. Correction Factor(dB/m) = Antenna Factor(dB/m) + Cable Factor(dB) – Pre-Amplifier Factor(dB)
3. The other emission levels were very low against the limit.
4. Margin value = Emission Level – Limit value
5. “ * ” : Fundamental frequency
6. Above limits have been translated by the formula

The measured field strength was extrapolated to distance 30 meters, using the formula that the limit of field strength varies as the inverse distance square (40dB per decade of distance)

Example:

$$\begin{aligned}
 13.56\text{MHz} &= 15848\mu\text{V/m} && 30\text{m} \\
 &= 84\text{dBuV/m} && 30\text{m} \\
 &= 84+20\log(30/3)^2 && 3\text{m} \\
 &= 124\text{dBuV/m}
 \end{aligned}$$

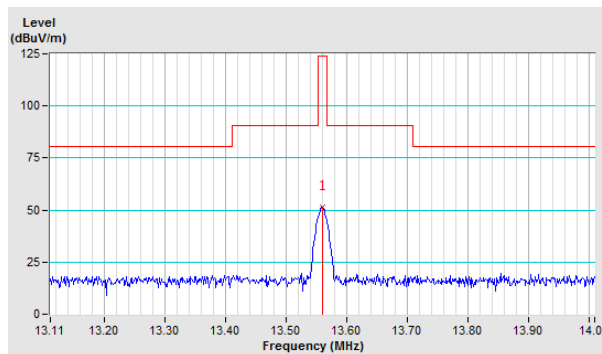

Antenna Polarity & Test Distance: Loop Antenna Open At 30m				
No.	Freq. (MHz)	Emission Level (dBuV/m)	Limit (dBuV/m)	Margin (dB)
1	*13.56	11.4 QP	84.0 QP	-72.6

Remarks: Emission Level at 30m = Emission Level at 3m + 20log(3/30)²

EUT Test Condition		Measurement Detail	
Channel	Channel 1	Frequency Range	Below 30MHz
Input Power	120Vac, 60Hz	Detector Function	Quasi-Peak
Environmental Conditions	22 deg. C, 66% RH	Tested By	Adair Peng

Antenna Polarity & Test Distance: Loop Antenna Open At 3m								
No.	Freq. (MHz)	Emission Level (dBuV/m)	Limit (dBuV/m)	Margin (dB)	Antenna Height (m)	Table Angle (Degree)	Raw Value (dBuV)	Correction Factor (dB/m)
1	3.23	43.7 QP	69.5 QP	-25.8	1.00	2	24.1	19.6
2	9.62	35.7 QP	69.5 QP	-33.8	1.00	133	14.0	21.7
3	14.62	35.6 QP	69.5 QP	-33.9	1.00	172	13.8	21.8
4	19.47	42.5 QP	69.5 QP	-27.0	1.00	309	20.7	21.8
5	25.96	41.7 QP	69.5 QP	-27.8	1.00	338	19.6	22.1
6	27.12	39.5 QP	69.5 QP	-30.0	1.00	117	17.4	22.1

Remarks:

1. Emission Level(dBuV/m) = Raw Value(dBuV) + Correction Factor(dB/m)
2. Correction Factor(dB/m) = Antenna Factor(dB/m) + Cable Factor(dB)
3. The other emission levels were very low against the limit.
4. Margin value = Emission Level – Limit value

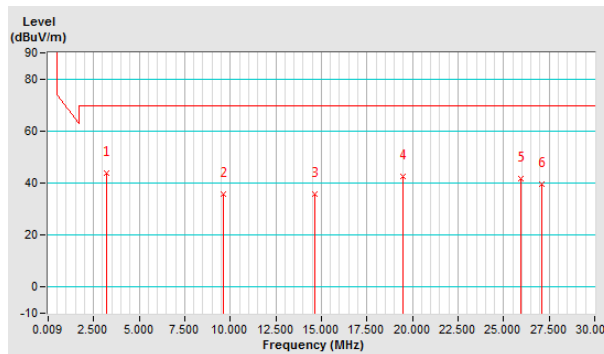

Antenna Polarity & Test Distance: Loop Antenna Open At 30m				
No.	Freq. (MHz)	Emission Level (dBuV/m)	Limit (dBuV/m)	Margin (dB)
1	3.23	3.7 QP	29.5 QP	-25.8
2	9.62	-4.3 QP	29.5 QP	-33.8
3	14.62	-4.4 QP	29.5 QP	-33.9
4	19.47	2.5 QP	29.5 QP	-27.0
5	25.96	1.7 QP	29.5 QP	-27.8
6	27.12	-0.5 QP	29.5 QP	-30.0

Remarks: Emission Level at 30m = Emission Level at 3m + 20log(3/30)²

EUT Test Condition		Measurement Detail	
Channel	Channel 1	Frequency Range	Below 30MHz
Input Power	120Vac, 60Hz	Detector Function	Quasi-Peak
Environmental Conditions	22 deg. C, 66% RH	Tested By	Adair Peng

Antenna Polarity & Test Distance: Loop Antenna Close At 3m								
No.	Freq. (MHz)	Emission Level (dBuV/m)	Limit (dBuV/m)	Margin (dB)	Antenna Height (m)	Table Angle (Degree)	Raw Value (dBuV)	Correction Factor (dB/m)
1	3.23	39.7 QP	69.5 QP	-29.8	1.00	350	20.1	19.6
2	7.94	35.0 QP	69.5 QP	-34.5	1.00	207	13.7	21.3
3	10.82	36.8 QP	69.5 QP	-32.7	1.00	355	15.0	21.8
4	15.68	35.5 QP	69.5 QP	-34.0	1.00	302	13.7	21.8
5	19.71	36.5 QP	69.5 QP	-33.0	1.00	1	14.7	21.8
6	27.12	34.2 QP	69.5 QP	-35.3	1.00	8	12.1	22.1

Remarks:

1. Emission Level(dBuV/m) = Raw Value(dBuV) + Correction Factor(dB/m)
2. Correction Factor(dB/m) = Antenna Factor(dB/m) + Cable Factor(dB) – Pre-Amplifier Factor(dB)
3. The other emission levels were very low against the limit.
4. Margin value = Emission Level – Limit value

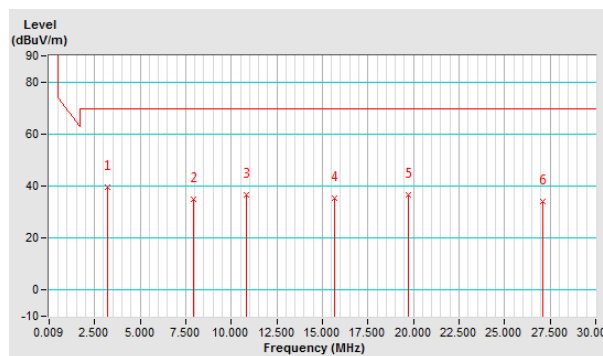

Antenna Polarity & Test Distance: Loop Antenna Close At 30m				
No.	Freq. (MHz)	Emission Level (dBuV/m)	Limit (dBuV/m)	Margin (dB)
1	3.23	-0.3 QP	29.5 QP	-29.8
2	7.94	-5.0 QP	29.5 QP	-34.5
3	10.82	-3.2 QP	29.5 QP	-32.7
4	15.68	-4.5 QP	29.5 QP	-34.0
5	19.71	-3.5 QP	29.5 QP	-33.0
6	27.12	-5.8 QP	29.5 QP	-35.3

Remarks: Emission Level at 30m = Emission Level at 3m + 20log(3/30)²

EUT Test Condition		Measurement Detail	
Channel	Channel 1	Frequency Range	Below 30MHz
Input Power	120Vac, 60Hz	Detector Function	Quasi-Peak
Environmental Conditions	22 deg. C, 66% RH	Tested By	Adair Peng

Antenna Polarity & Test Distance: Loop Antenna Ground-Parallel At 3m								
No.	Freq. (MHz)	Emission Level (dBuV/m)	Limit (dBuV/m)	Margin (dB)	Antenna Height (m)	Table Angle (Degree)	Raw Value (dBuV)	Correction Factor (dB/m)
1	3.23	40.8 QP	69.5 QP	-28.7	1.00	128	21.2	19.6
2	7.36	35.8 QP	69.5 QP	-33.7	1.00	6	14.7	21.1
3	11.50	35.6 QP	69.5 QP	-33.9	1.00	61	13.8	21.8
4	16.93	35.2 QP	69.5 QP	-34.3	1.00	338	13.4	21.8
5	20.15	34.5 QP	69.5 QP	-35.0	1.00	282	12.6	21.9
6	27.12	37.1 QP	69.5 QP	-32.4	1.00	334	15.0	22.1

Remarks:

1. Emission Level(dBuV/m) = Raw Value(dBuV) + Correction Factor(dB/m)
2. Correction Factor(dB/m) = Antenna Factor(dB/m) + Cable Factor(dB) – Pre-Amplifier Factor(dB)
3. The other emission levels were very low against the limit.
4. Margin value = Emission Level – Limit value

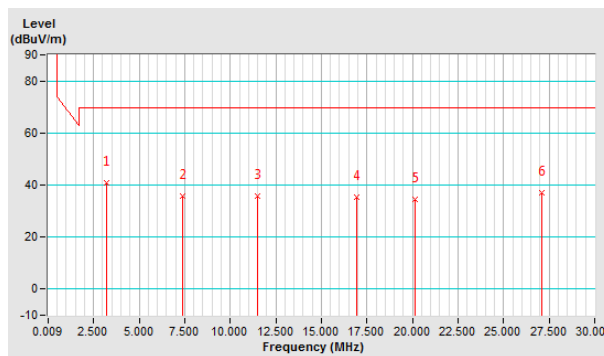

Antenna Polarity & Test Distance: Loop Antenna Ground-Parallel At 30m				
No.	Freq. (MHz)	Emission Level (dBuV/m)	Limit (dBuV/m)	Margin (dB)
1	3.23	0.8 QP	29.5 QP	-28.7
2	7.36	-4.2 QP	29.5 QP	-33.7
3	11.50	-4.4 QP	29.5 QP	-33.9
4	16.93	-4.8 QP	29.5 QP	-34.3
5	20.15	-5.5 QP	29.5 QP	-35.0
6	27.12	-2.9 QP	29.5 QP	-32.4

Remarks: Emission Level at 30m = Emission Level at 3m + 20log(3/30)²

EUT Test Condition		Measurement Detail	
Channel	Channel 1	Frequency Range	Below 1000MHz
Input Power	120Vac, 60Hz	Detector Function	Quasi-Peak
Environmental Conditions	22 deg. C, 66% RH	Tested By	Adair Peng

Antenna Polarity & Test Distance: Horizontal At 3m								
No.	Freq. (MHz)	Emission Level (dBuV/m)	Limit (dBuV/m)	Margin (dB)	Antenna Height (m)	Table Angle (Degree)	Raw Value (dBuV)	Correction Factor (dB/m)
1	57.12	25.6 QP	40.0	-14.4	1.50 H	307	35.2	-9.6
2	94.06	25.0 QP	43.5	-18.5	1.50 H	154	39.5	-14.5
3	175.72	34.3 QP	43.5	-9.2	1.50 H	244	44.0	-9.7
4	374.04	22.7 QP	46.0	-23.3	1.00 H	262	28.6	-5.9
5	490.70	25.0 QP	46.0	-21.0	1.50 H	279	28.7	-3.7
6	626.80	28.0 QP	46.0	-18.0	1.00 H	69	28.5	-0.5

Remarks:

1. Emission Level(dBuV/m) = Raw Value(dBuV) + Correction Factor(dB/m)
2. Correction Factor(dB/m) = Antenna Factor(dB/m) + Cable Factor(dB) – Pre-Amplifier Factor(dB)
3. The other emission levels were very low against the limit.
4. Margin value = Emission Level – Limit value

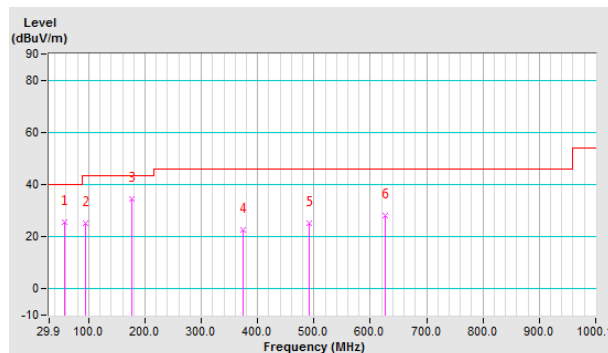

EUT Test Condition		Measurement Detail	
Channel	Channel 1	Frequency Range	Below 1000MHz
Input Power	120Vac, 60Hz	Detector Function	Quasi-Peak
Environmental Conditions	22 deg. C, 66% RH	Tested By	Adair Peng

Antenna Polarity & Test Distance: Vertical At 3m								
No.	Freq. (MHz)	Emission Level (dBuV/m)	Limit (dBuV/m)	Margin (dB)	Antenna Height (m)	Table Angle (Degree)	Raw Value (dBuV)	Correction Factor (dB/m)
1	86.28	34.1 QP	40.0	-5.9	1.49 V	46	48.7	-14.6
2	175.72	26.3 QP	43.5	-17.2	1.00 V	6	36.0	-9.7
3	210.72	26.8 QP	43.5	-16.7	1.00 V	3	38.5	-11.7
4	374.04	22.3 QP	46.0	-23.7	2.00 V	157	28.2	-5.9
5	517.92	25.4 QP	46.0	-20.6	1.49 V	275	28.6	-3.2
6	727.90	31.7 QP	46.0	-14.3	1.00 V	22	30.5	1.2

Remarks:

1. Emission Level(dBuV/m) = Raw Value(dBuV) + Correction Factor(dB/m)
2. Correction Factor(dB/m) = Antenna Factor(dB/m) + Cable Factor(dB) – Pre-Amplifier Factor(dB)
3. The other emission levels were very low against the limit.
4. Margin value = Emission Level – Limit value

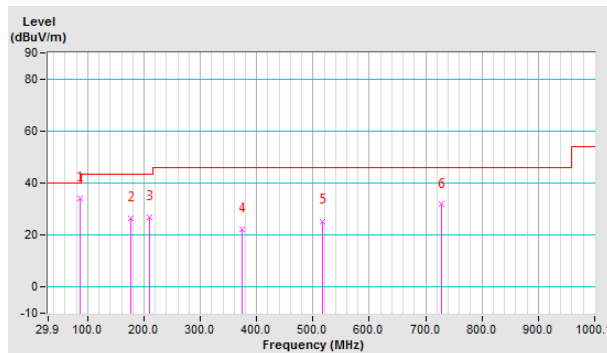

4.2 Conducted Emission Measurement

4.2.1 Limits of Conducted Emission Measurement

Frequency (MHz)	Conducted Limit (dBuV)	
	Quasi-peak	Average
0.15 - 0.5	66 - 56	56 - 46
0.50 - 5.0	56	46
5.0 - 30.0	60	50

Note: 1. The lower limit shall apply at the transition frequencies.

2. The limit decreases in line with the logarithm of the frequency in the range of 0.15 to 0.50MHz.

4.2.2 Test Instruments

Description & Manufacturer	Model No.	Serial No.	Cal. Date	Cal. Due
Test Receiver ROHDE & SCHWARZ	ESCS30	100291	Sep. 03, 2018	Sep. 02, 2019
RF signal cable Woken	5D-FB	Cable-cond1-01	Sep. 05, 2018	Sep. 04, 2019
LISN ROHDE & SCHWARZ (EUT)	ENV216	101826	Feb. 26, 2018	Feb. 25, 2019
LISN ROHDE & SCHWARZ (Peripheral)	ESH3-Z5	100311	Aug. 19, 2018	Aug. 18, 2019
Software ADT	BV ADT_Cond_ V7.3.7.4	NA	NA	NA

Note: 1. The calibration interval of the above test instruments is 12 months and the calibrations are traceable to NML/ROC and NIST/USA.

2. The test was performed in HwaYa Shielded Room 1.

3. The VCCI Site Registration No. is C-2040.

4.2.3 Test Procedures

- The EUT was placed 0.4 meters from the conducting wall of the shielded room with EUT being connected to the power mains through a line impedance stabilization network (LISN). Other support units were connected to the power mains through another LISN. The two LISNs provide 50 ohm/ 50uH of coupling impedance for the measuring instrument.
- Both lines of the power mains connected to the EUT were checked for maximum conducted interference.
- The frequency range from 150kHz to 30MHz was searched. Emission levels under (Limit - 20dB) was not recorded.

Note: The resolution bandwidth and video bandwidth of test receiver is 9kHz for quasi-peak detection (QP) and average detection (AV) at frequency 0.15MHz-30MHz.

4.2.4 Deviation from Test Standard

No deviation.

4.2.5 Test Setup

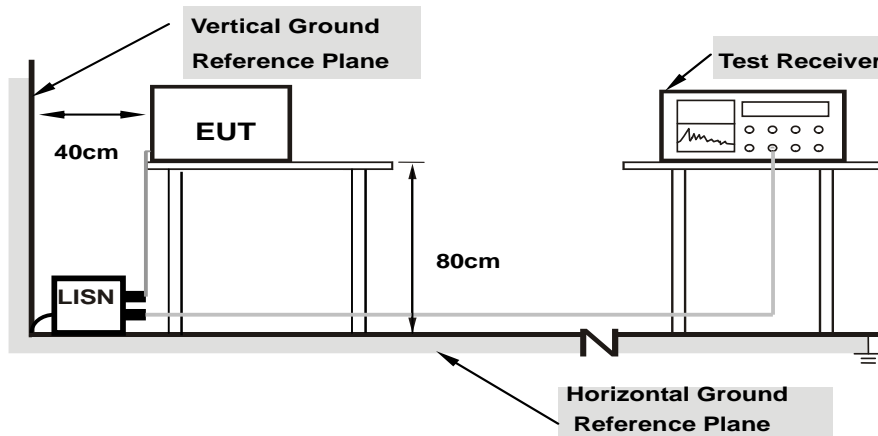

Note: 1.Support units were connected to second LISN.

For the actual test configuration, please refer to the attached file (Test Setup Photo).

4.2.6 EUT Operating Conditions

Same as 4.1.6.

4.2.7 Test Results

Phase	Line (L)	Detector Function	Quasi-Peak (QP) / Average (AV)
-------	----------	-------------------	--------------------------------

No	Freq. [MHz]	Corr. Factor (dB)	Reading Value [dB (uV)]		Emission Level [dB (uV)]		Limit [dB (uV)]		Margin (dB)	
			Q.P.	AV.	Q.P.	AV.	Q.P.	AV.	Q.P.	AV.
			1	0.17744	9.72	27.09	3.66	36.81	13.38	64.60
2	0.22038	9.72	24.40	5.16	34.12	14.88	62.80	52.80	-28.68	-37.92
3	0.65439	9.72	34.41	13.71	44.13	23.43	56.00	46.00	-11.87	-22.57
4	1.04148	9.68	37.51	20.29	47.19	29.97	56.00	46.00	-8.81	-16.03
5	8.63861	9.86	16.32	10.19	26.18	20.05	60.00	50.00	-33.82	-29.95
6	13.55739	9.91	35.08	29.97	44.99	39.88	60.00	50.00	-15.01	-10.12

Remarks:

1. Q.P. and AV. are abbreviations of quasi-peak and average individually.
2. The emission levels of other frequencies were very low against the limit.
3. Margin value = Emission level - Limit value
4. Correction factor = Insertion loss + Cable loss
5. Emission Level = Correction Factor + Reading Value.

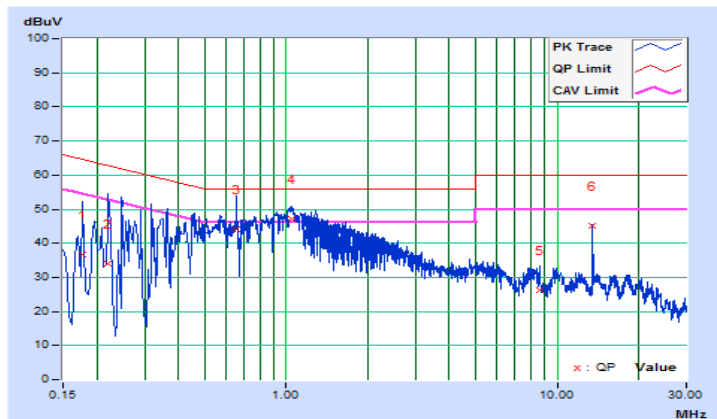

Phase	Neutral (N)	Detector Function	Quasi-Peak (QP) / Average (AV)
-------	-------------	-------------------	--------------------------------

No	Freq. [MHz]	Corr. Factor (dB)	Reading Value [dB (uV)]		Emission Level [dB (uV)]		Limit [dB (uV)]		Margin (dB)	
			Q.P.	AV.	Q.P.	AV.	Q.P.	AV.	Q.P.	AV.
			1	0.23211	9.73	34.54	9.29	44.27	19.02	62.37
2	0.28685	9.74	35.79	12.88	45.53	22.62	60.62	50.62	-15.09	-28.00
3	1.03366	9.72	37.53	18.63	47.25	28.35	56.00	46.00	-8.75	-17.65
4	4.64259	9.82	22.34	12.02	32.16	21.84	56.00	46.00	-23.84	-24.16
5	8.45484	9.88	21.57	10.70	31.45	20.58	60.00	50.00	-28.55	-29.42
6	13.56130	9.98	23.94	18.44	33.92	28.42	60.00	50.00	-26.08	-21.58

Remarks:

1. Q.P. and AV. are abbreviations of quasi-peak and average individually.
2. The emission levels of other frequencies were very low against the limit.
3. Margin value = Emission level - Limit value
4. Correction factor = Insertion loss + Cable loss
5. Emission Level = Correction Factor + Reading Value.

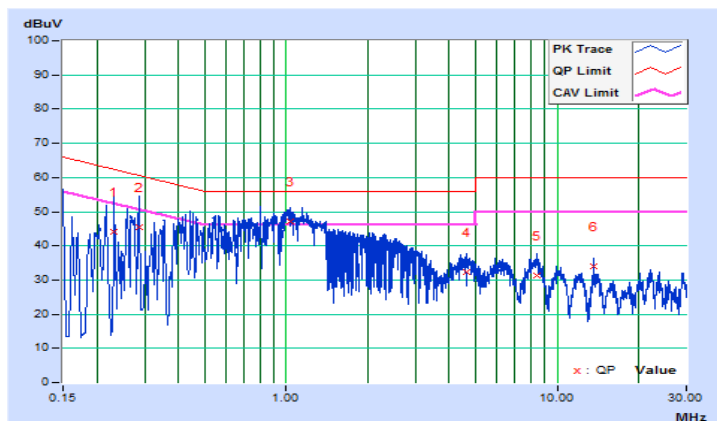

4.3 Frequency Stability

4.3.1 Limits of Frequency Stability Measurement

The frequency tolerance of the carrier signal shall be maintained within +/- 0.01% of the operating frequency over a temperature variation of -20 degrees to 50 degrees C at normal supply voltage, and for a variation in the primary supply voltage from 85% to 115% of the rated supply voltage at a temperature of 20 degrees C.

4.3.2 Test Setup

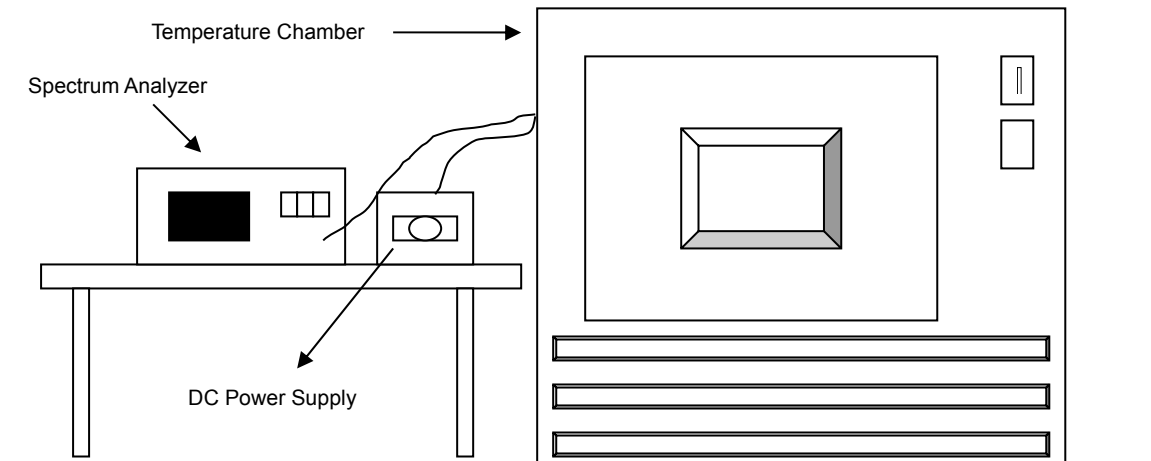

4.3.3 Test Instruments

Description & Manufacturer	Model No.	Serial No.	Cal. Date	Cal. Due
Spectrum Analyzer ROHDE & SCHWARZ	FSP40	100039	Jun. 11, 2018	Jun. 10, 2019
WIT Standard Temperature And Humidity Chamber	TH-4S-C	W981030	Jun. 04, 2018	Jun. 03, 2019
Digital Multimeter Fluke	87-III	70360742	Jun. 29, 2018	Jun. 28, 2019
DC Power Supply Topward	6603D	700637	NA	NA

Note: 1. The calibration interval of the above test instruments is 12 months and the calibrations are traceable to NML/ROC and NIST/USA.

4.3.4 Test Procedure

- The EUT was placed inside the environmental test chamber and powered by nominal DC voltage.
- Turned the EUT on and coupled its output to a spectrum analyzer.
- Turned the EUT off and set the chamber to the highest temperature specified.
- Allowed sufficient time (approximately 30 min) for the temperature of the chamber to stabilize then turned the EUT on and measured the operating frequency after 2, 5, and 10 minutes.
- Repeated step 2 and 3 with the temperature chamber set to the lowest temperature.
- The test chamber was allowed to stabilize at +20 degree C for a minimum of 30 minutes. The supply voltage was then adjusted on the EUT from 85% to 115% and the frequency record.

4.3.5 Deviation from Test Standard

No deviation.

4.3.6 EUT Operating Conditions

Same as Item 4.1.6.

4.3.7 Test Result

Frequency Stability Versus Temp.									
TEMP. (°C)	Power Supply (Vdc)	0 Minute		2 Minute		5 Minute		10 Minute	
		Measured Frequency	Frequency Drift	Measured Frequency	Frequency Drift	Measured Frequency	Frequency Drift	Measured Frequency	Frequency Drift
		(MHz)	%	(MHz)	%	(MHz)	%	(MHz)	%
55	3.85	13.56006	0.00044	13.56005	0.00037	13.56005	0.00037	13.56005	0.00037
50	3.85	13.55999	-0.00007	13.55999	-0.00007	13.55999	-0.00007	13.55999	-0.00007
40	3.85	13.55997	-0.00022	13.55997	-0.00022	13.55997	-0.00022	13.55997	-0.00022
30	3.85	13.55993	-0.00052	13.55994	-0.00044	13.55994	-0.00044	13.55994	-0.00044
20	3.85	13.55995	-0.00037	13.55996	-0.00029	13.55995	-0.00037	13.55996	-0.00029
10	3.85	13.55996	-0.00029	13.55995	-0.00037	13.55997	-0.00022	13.55996	-0.00029
0	3.85	13.56002	0.00015	13.56003	0.00022	13.56003	0.00022	13.56002	0.00015
-10	3.85	13.56002	0.00015	13.56002	0.00015	13.56002	0.00015	13.56002	0.00015

Frequency Stability Versus Voltage									
TEMP. (°C)	Power Supply (Vdc)	0 Minute		2 Minute		5 Minute		10 Minute	
		Measured Frequency	Frequency Drift	Measured Frequency	Frequency Drift	Measured Frequency	Frequency Drift	Measured Frequency	Frequency Drift
		(MHz)	%	(MHz)	%	(MHz)	%	(MHz)	%
20	4.4	13.55993	-0.00052	13.55994	-0.00044	13.55994	-0.00044	13.55994	-0.00044
	3.85	13.55993	-0.00052	13.55994	-0.00044	13.55994	-0.00044	13.55994	-0.00044
	3.6	13.55993	-0.00052	13.55994	-0.00044	13.55994	-0.00044	13.55994	-0.00044

4.4 20dB Bandwidth

4.4.1 Limits of 20dB Bandwidth Measurement

The 20dB bandwidth shall be specified in operating frequency band.

4.4.2 Test Setup

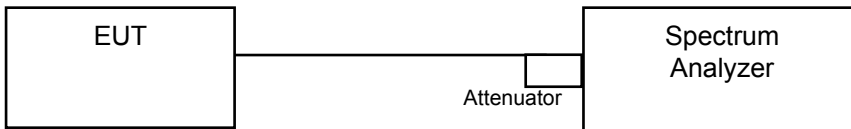

4.4.3 Test Instruments

Description & Manufacturer	Model No.	Serial No.	Cal. Date	Cal. Due
SPECTRUM ANALYZER R&S	FSP40	100041	Dec 12, 2017	Dec 11, 2018

Note: 1. The calibration interval of the above test instruments is 12 months and the calibrations are traceable to NML/ROC and NIST/USA.

4.4.4 Test Procedures

The bandwidth of the fundamental frequency was measured by spectrum analyzer with 1kHz RBW and 3kHz VBW. The 20dB bandwidth is defined as the total spectrum the power of which is higher than peak power minus 20dB.

4.4.5 Deviation from Test Standard

No deviation.

4.4.6 EUT Operating Conditions

Same as Item 4.1.6.

4.4.7 Test Results

20dBc point (Low)	20dBc point (High)	Operating frequency band (MHz)	Pass / Fail
13.558557692	13.561153846	13.553~13.567	Pass

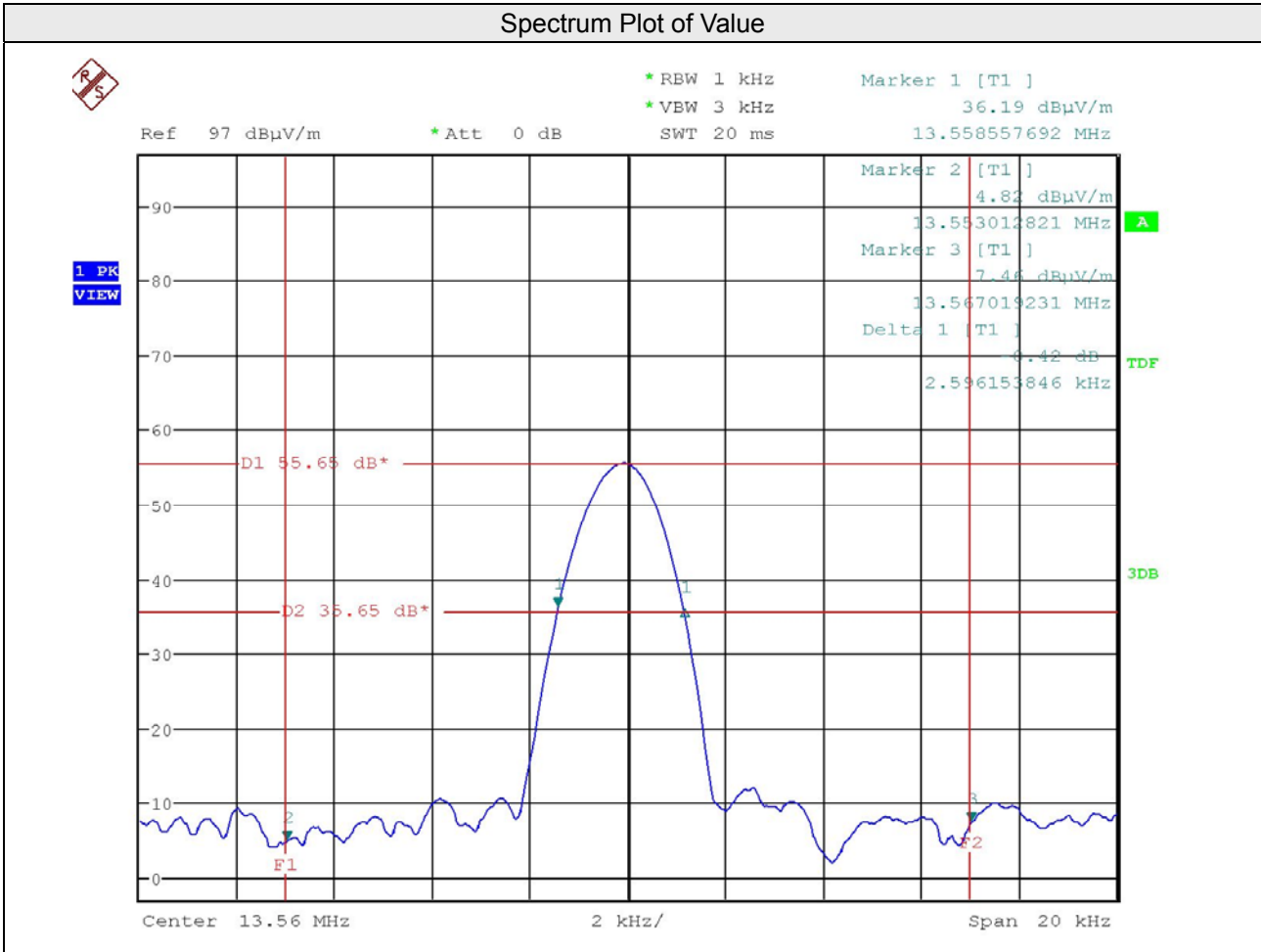

5 Pictures of Test Arrangements

Please refer to the attached file (Test Setup Photo).

Appendix – Information of the Testing Laboratories

We, Bureau Veritas Consumer Products Services (H.K.) Ltd., Taoyuan Branch, were founded in 1988 to provide our best service in EMC, Radio, Telecom and Safety consultation. Our laboratories are FCC recognized accredited test firms and accredited and approved according to ISO/IEC 17025.

If you have any comments, please feel free to contact us at the following:

Linko EMC/RF Lab

Tel: 886-2-26052180

Fax: 886-2-26051924

Hsin Chu EMC/RF/Telecom Lab

Tel: 886-3-6668565

Fax: 886-3-6668323

Hwa Ya EMC/RF/Safety Lab

Tel: 886-3-3183232

Fax: 886-3-3270892

Email: service.adt@tw.bureauveritas.com

Web Site: www.bureauveritas-adt.com

The address and road map of all our labs can be found in our web site also.

--- END ---