

## FCC Test Report

### (PART 27)

**Report No.:** RF180920C22-10

**FCC ID:** A4RG020C

**Model Name:** G020C

**Received Date:** Sep. 21, 2018

**Test Date:** Oct. 06, 2018 ~ Dec. 24, 2018

**Issued Date:** Dec. 27, 2018

**Applicant:** Google LLC

**Address:** 1600 Amphitheatre Parkway, Mountain View, CA 94043, USA

**Issued By:** Bureau Veritas Consumer Products Services (H.K.) Ltd., Taoyuan Branch

**Lab Address:** No. 47-2, 14th Ling, Chia Pau Vil., Lin Kou Dist., New Taipei City, Taiwan  
( R.O.C )

**Test Location (1):** No. 19, Hwa Ya 2nd Rd, Wen Hwa Vil, Kwei Shan Dist., Taoyuan City  
33383, Taiwan (R.O.C)

**FCC Registration /  
Designation Number:** 788550 / TW0003



This report is for your exclusive use. Any copying or replication of this report to or for any other person or entity, or use of our name or trademark, is permitted only with our prior written permission. This report sets forth our findings solely with respect to the test samples identified herein. The results set forth in this report are not indicative or representative of the quality or characteristics of the lot from which a test sample was taken or any similar or identical product unless specifically and expressly noted. Our report includes all of the tests requested by you and the results thereof based upon the information that you provided to us. You have 60 days from date of issuance of this report to notify us of any material error or omission caused by our negligence, provided, however, that such notice shall be in writing and shall specifically address the issue you wish to raise. A failure to raise such issue within the prescribed time shall constitute your unqualified acceptance of the completeness of this report, the tests conducted and the correctness of the report contents. Unless specific mention, the uncertainty of measurement has been explicitly taken into account to declare the compliance or non-compliance to the specification. The report must not be used by the client to claim product certification, approval, or endorsement by TAF or any government agencies

## Table of Contents

<b>Release Control Record</b> .....	<b>4</b>
<b>1 Certificate of Conformity</b> .....	<b>5</b>
<b>2 Summary of Test Results</b> .....	<b>6</b>
2.1 Measurement Uncertainty .....	6
2.2 Test Site and Instruments .....	7
<b>3 General Information</b> .....	<b>9</b>
3.1 General Description of EUT .....	9
3.2 Configuration of System under Test .....	11
3.2.1 Description of Support Units .....	11
3.3 Test Mode Applicability and Tested Channel Detail .....	12
3.4 EUT Operating Conditions .....	15
3.5 General Description of Applied Standards .....	15
<b>4 Test Types and Results</b> .....	<b>16</b>
4.1 Output Power Measurement .....	16
4.1.1 Limits of Output Power Measurement .....	16
4.1.2 Test Procedures .....	16
4.1.3 Test Setup .....	17
4.1.4 Test Results .....	18
4.2 Modulation Characteristics Measurement .....	38
4.2.1 Limits of Modulation Characteristics .....	38
4.2.2 Test Setup .....	38
4.2.3 Test Procedure .....	38
4.2.4 Test Results .....	39
4.3 Frequency Stability Measurement .....	43
4.3.1 Limits of Frequency Stability Measurement .....	43
4.3.2 Test Procedure .....	43
4.3.3 Test Setup .....	43
4.3.4 Test Results .....	44
4.4 Occupied Bandwidth Measurement .....	60
4.4.1 Limits of Occupied Bandwidth Measurement .....	60
4.4.2 Test Procedure .....	60
4.4.3 Test Setup .....	60
4.4.4 Test Results .....	61
4.5 Out-of-Band Emissions Measurement .....	77
4.5.1 Limits of Out-of-Band Emissions Measurement .....	77
4.5.2 Test Setup .....	77
4.5.3 Test Procedures .....	77
4.5.4 Test Results .....	78
4.6 Peak to Average Ratio .....	126
4.6.1 Limits of Peak to Average Ratio Measurement .....	126
4.6.2 Test Setup .....	126
4.6.3 Test Procedures .....	126
4.6.4 Test Results .....	127
4.7 Conducted Spurious Emissions .....	135
4.7.1 Limits of Conducted Spurious Emissions Measurement .....	135
4.7.2 Test Setup .....	135
4.7.3 Test Procedure .....	135
4.7.4 Test Results .....	136
4.8 Radiated Emission Measurement .....	184
4.8.1 Limits of Radiated Emission Measurement .....	184
4.8.2 Test Procedure .....	184
4.8.3 Deviation from Test Standard .....	184
4.8.4 Test Setup .....	185

4.8.5 Test Results .....	186
<b>5 Pictures of Test Arrangements.....</b>	<b>234</b>
<b>Appendix – Information on the Testing Laboratories .....</b>	<b>235</b>

### Release Control Record

Issue No.	Description	Date Issued
RF180920C22-10	Original Release	Dec. 27, 2018

## 1 Certificate of Conformity

**Product:** Smartphone  
**Model Name:** G020C  
**Sample Status:** Identical Prototype  
**Applicant:** Google LLC  
**Test Date:** Oct. 06, 2018 ~ Dec. 24, 2018  
**Standards:** FCC Part 27, Subpart C, M

The above equipment has been tested by **Bureau Veritas Consumer Products Services (H.K.) Ltd., Taoyuan Branch**, and found compliance with the requirement of the above standards. The test record, data evaluation & Equipment Under Test (EUT) configurations represented herein are true and accurate accounts of the measurements of the sample's RF characteristics under the conditions specified in this report.

**Prepared by :** , **Date:** Dec. 27, 2018  
Ivonne Wu / Supervisor

**Approved by :** , **Date:** Dec. 27, 2018  
Dylan Chiou / Project Engineer

## 2 Summary of Test Results

Applied Standard: FCC Part 27 & Part 2			
FCC Clause	Test Item	Result	Remarks
2.1046 27.50(h)(2)	Equivalent Isotropic Radiated Power	Pass	Meet the requirement of limit.
2.1047	Modulation Characteristics	Pass	Meet the requirement.
2.1055 27.54	Frequency Stability	Pass	Meet the requirement of limit.
2.1049 27.53(m)(6)	Occupied Bandwidth	Pass	Meet the requirement of limit.
--	Peak to Average Ratio	Pass	Meet the requirement of limit.
2.1051 27.53(m)(4)(6)	Out-of-Band Emissions Measurements	Pass	Meet the requirement of limit.
2.1051 27.53(m)(4)(6)	Conducted Spurious Emissions	Pass	Meet the requirement of limit.
2.1053 27.53(m)(4)(6)	Radiated Spurious Emissions	Pass	Meet the requirement of limit. Minimum passing margin is -12.62 dB at 8040.00 MHz.

### 2.1 Measurement Uncertainty

Where relevant, the following measurement uncertainty levels have been estimated for tests performed on the EUT as specified in CISPR 16-4-2:

Measurement	Frequency	Expanded Uncertainty (k=2) ( $\pm$ )
Radiated Emissions up to 1 GHz	30 MHz ~ 200 MHz	2.93 dB
	200 MHz ~ 1000 MHz	2.95 dB
Radiated Emissions above 1 GHz	1 GHz ~ 18 GHz	2.26 dB
	18 GHz ~ 40 GHz	1.94 dB

## 2.2 Test Site and Instruments

Description & Manufacturer	Model No.	Serial No.	Date of Calibration	Due Date of Calibration
Test Receiver Agilent	N9038A	MY51210203	Mar. 16, 2018	Mar. 15, 2019
Spectrum Analyzer Keysight	N9010A	MY56070348	Sep. 06, 2018	Sep. 05, 2019
Spectrum Analyzer ROHDE & SCHWARZ	FSU43	101261	Jan. 11, 2018	Jan. 10, 2019
HORN Antenna SCHWARZBECK	BBHA 9120D	9120D-969	Dec. 12, 2017	Dec. 11, 2018
			Nov. 25, 2018	Nov. 24, 2019
HORN Antenna SCHWARZBECK	BBHA 9170	148	Dec. 13, 2017	Dec. 12, 2018
			Nov. 25, 2018	Nov. 24, 2019
BILOG Antenna SCHWARZBECK	VULB 9168	9168-472	Dec. 06, 2017	Dec. 05, 2018
			Nov. 23, 2018	Nov. 22, 2019
Fixed Attenuator Mini-Circuits	MDCS18N-10	MDCS18N-10-01	Apr. 16, 2018	Apr. 15, 2019
MXG Vector signal generator Agilent	N5182B	MY53052658	May 24, 2018	May 23, 2019
Preamplifier EMCI	EMC 184045	980116	Oct. 12, 2018	Oct. 11, 2019
Preamplifier EMCI	EMC 012645	980115	Oct. 12, 2018	Oct. 11, 2019
Preamplifier EMCI	EMC 330H	980112	Oct. 12, 2018	Oct. 11, 2019
RF Coaxial Cable HUBER+SUHNNER	EMC104-SM-SM-800 0&3000	140811+170717	Oct. 12, 2018	Oct. 11, 2019
RF Coaxial Cable HUBER+SUHNNER	SUCOFLEX 104	EMC104-SM-SM-1 000(140807)	Oct. 12, 2018	Oct. 11, 2019
RF Coaxial Cable WOKEN	8D-FB	Cable-Ch10-01	Oct. 12, 2018	Oct. 11, 2019
Boresight Antenna Fixture	FBA-01	FBA-SIP01	NA	NA
Software BV ADT	E3 6.120103	NA	NA	NA
Antenna Tower MF	MFA-440H	NA	NA	NA
Turn Table MF	MFT-201SS	NA	NA	NA
Antenna Tower & Turn Table Controller MF	MF-7802	NA	NA	NA
Communications Tester-Wireless Agilent	8960 Series 10	MY53201073	Jun. 28, 2017	Jun. 27, 2019
Radio Communication Analyzer Anritsu	MT8820C	6201300640	Aug. 16, 2017	Aug. 15, 2019
Temperature & Humidity Chamber	GTH-120-40-CP-AR	MAA1306-019	Sep. 05, 2018	Sep. 04, 2019
DC Power Supply Topward	33010D	807748	NA	NA

- Note:
1. The calibration interval of the above test instruments is 12 / 24 months and the calibrations are traceable to NML/ROC and NIST/USA.
  2. The test was performed in HwaYa Chamber 10.
  3. The horn antenna and preamplifier (model: EMC 184045) are used only for the measurement of emission frequency above 1 GHz if tested.
  4. The IC Site Registration No. is 7450F-10.



### 3 General Information

#### 3.1 General Description of EUT

<b>Product</b>	Smartphone		
<b>Model Name</b>	G020C		
<b>Status of EUT</b>	Identical Prototype		
<b>Power Supply Rating</b>	3.85 Vdc (Li-ion battery) 5.0 Vdc or 9 Vdc (adapter) 5.0 Vdc (host equipment)		
<b>Modulation Type</b>	QPSK, 16QAM, 64QAM		
<b>Frequency Range</b>	LTE Band 7 (Channel Bandwidth: 5 MHz)	2502.5 ~ 2567.5 MHz	
	LTE Band 7 (Channel Bandwidth: 10 MHz)	2505 ~ 2565 MHz	
	LTE Band 7 (Channel Bandwidth: 15 MHz)	2507.5 ~ 2562.5 MHz	
	LTE Band 7 (Channel Bandwidth: 20 MHz)	2510 ~ 2560 MHz	
	LTE Band 38 (Channel Bandwidth: 5 MHz)	2572.5 ~ 2617.5 MHz	
	LTE Band 38 (Channel Bandwidth: 10 MHz)	2575.0 ~ 2615.0 MHz	
	LTE Band 38 (Channel Bandwidth: 15 MHz)	2577.5 ~ 2612.5 MHz	
	LTE Band 38 (Channel Bandwidth: 20 MHz)	2580.0 ~ 2610.0 MHz	
	LTE Band 41 (Channel Bandwidth: 5 MHz)	2498.5 ~ 2687.5 MHz	
	LTE Band 41 (Channel Bandwidth: 10 MHz)	2501.0 ~ 2685.0 MHz	
	LTE Band 41 (Channel Bandwidth: 15 MHz)	2503.5 ~ 2682.5 MHz	
	LTE Band 41 (Channel Bandwidth: 20 MHz)	2506.0 ~ 2680.0 MHz	
	<b>Max. EIRP Power</b>	LTE Band 7 (Channel Bandwidth: 5 MHz)	138.68 mW
LTE Band 7 (Channel Bandwidth: 10 MHz)		148.25 mW	
LTE Band 7 (Channel Bandwidth: 15 MHz)		158.49 mW	
LTE Band 7 (Channel Bandwidth: 20 MHz)		167.11 mW	
LTE Band 38 (Channel Bandwidth: 5 MHz)		203.70 mW	
LTE Band 38 (Channel Bandwidth: 10 MHz)		215.28 mW	
LTE Band 38 (Channel Bandwidth: 15 MHz)		229.09 mW	
LTE Band 38 (Channel Bandwidth: 20 MHz)		242.66 mW	
Power Class 2			
LTE Band 41 (Channel Bandwidth: 5 MHz)		200.45 mW	
LTE Band 41 (Channel Bandwidth: 10 MHz)		214.29 mW	
LTE Band 41 (Channel Bandwidth: 15 MHz)		227.51 mW	
LTE Band 41 (Channel Bandwidth: 20 MHz)		237.14 mW	
Power Class 3			
LTE Band 41 (Channel Bandwidth: 5 MHz)		127.35 mW	
LTE Band 41 (Channel Bandwidth: 10 MHz)		136.77 mW	
LTE Band 41 (Channel Bandwidth: 15 MHz)		144.21 mW	
LTE Band 41 (Channel Bandwidth: 20 MHz)	153.11 mW		

<b>Emission Designator</b>	LTE Band 7 (Channel Bandwidth: 5 MHz)	4M50W7D
	LTE Band 7 (Channel Bandwidth: 10 MHz)	8M98W7D
	LTE Band 7 (Channel Bandwidth: 15 MHz)	13M5G7D
	LTE Band 7 (Channel Bandwidth: 20 MHz)	17M9W7D
	LTE Band 38 (Channel Bandwidth: 5 MHz)	4M50G7D
	LTE Band 38 (Channel Bandwidth: 10 MHz)	8M97W7D
	LTE Band 38 (Channel Bandwidth: 15 MHz)	13M4G7D
	LTE Band 38 (Channel Bandwidth: 20 MHz)	17M9W7D
	Power Class 2	
	LTE Band 41 (Channel Bandwidth: 5 MHz)	4M50W7D
	LTE Band 41 (Channel Bandwidth: 10 MHz)	8M97W7D
	LTE Band 41 (Channel Bandwidth: 15 MHz)	13M4G7D
	LTE Band 41 (Channel Bandwidth: 20 MHz)	17M9W7D
	Power Class 3	
	LTE Band 41 (Channel Bandwidth: 5 MHz)	4M50W7D
	LTE Band 41 (Channel Bandwidth: 10 MHz)	8M97W7D
LTE Band 41 (Channel Bandwidth: 15 MHz)	13M4G7D	
LTE Band 41 (Channel Bandwidth: 20 MHz)	17M9W7D	
<b>Antenna Type</b>	PIFA Antenna	
<b>Antenna Gain</b>	LTE 7	0.6 dBi gain
	LTE 38	0.6 dBi gain
	LTE 41	-2 dBi gain
<b>Accessory Device</b>	Refer to Note as below	
<b>Data Cable Supplied</b>	Refer to Note as below	

Note:

1. There're 2 configurations for the EUT listed as below.

Main Sample: EUT + Battery 1

2<sup>nd</sup> Sample: EUT + Battery 2

✧ After pre-tested with the EUT, only the worst configuration (main sample) was chosen for the final test.

2. The EUT's accessories list refers to Ext. Pho.

3. The above EUT information is declared by manufacturer and for more detailed features description, please refers to the manufacturer's specifications or user's manual.

### 3.2 Configuration of System under Test

#### <Radiated Emission Test>

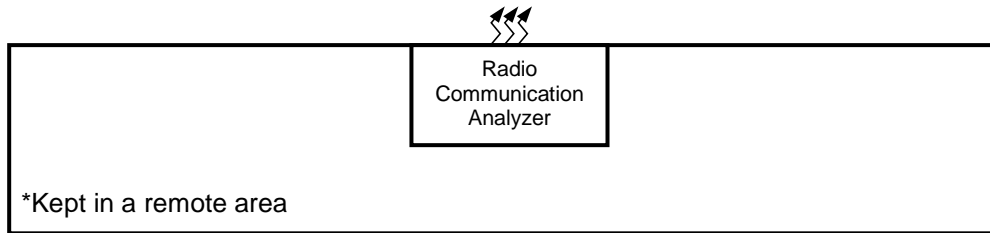
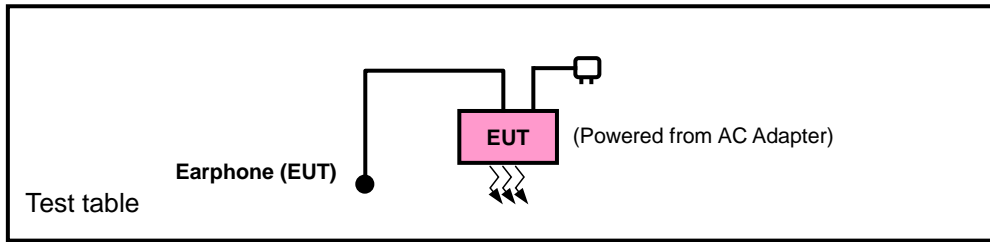

#### <E.I.R.P. Test>

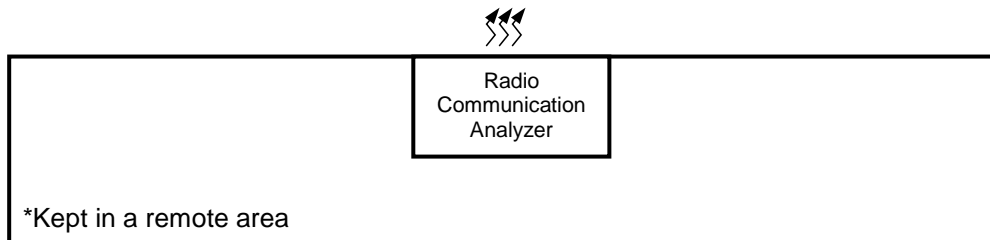
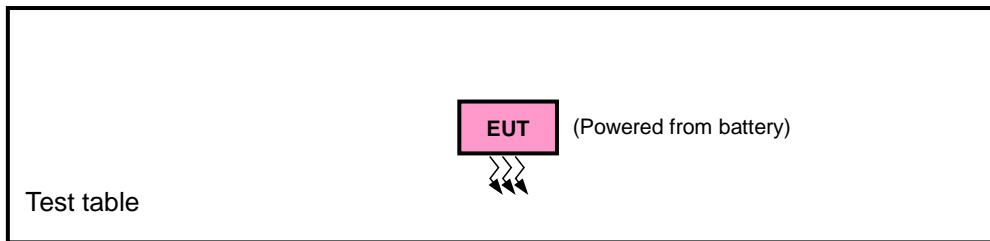

#### 3.2.1 Description of Support Units

The EUT has been tested as an independent unit together with other necessary accessories or support units.

### 3.3 Test Mode Applicability and Tested Channel Detail

Pre-Scan has been conducted to determine the worst-case mode from all possible combinations between available modulations, data rates, XYZ axis, and antenna ports.

The worst case was found when positioned as the table below. Following channel(s) was (were) selected for the final test as listed below:

Band	EIRP	Radiated Emission
LTE Band 7	X-plane	Z-axis
LTE Band 38	X-plane	Z-axis
LTE Band 41	X-plane	Z-axis

#### LTE Band 7

EUT Configure Mode	Test Item	Available Channel	Tested Channel	Channel Bandwidth	Modulation	Mode
-	EIRP	20775 to 21425	20775, 21100, 21425	5 MHz	QPSK, 16QAM, 64QAM	1 RB / 0 RB Offset
		20800 to 21400	20800, 21100, 21400	10 MHz	QPSK, 16QAM, 64QAM	1 RB / 0 RB Offset
		20825 to 21375	20825, 21100, 21375	15 MHz	QPSK, 16QAM, 64QAM	1 RB / 0 RB Offset
		20850 to 21350	20850, 21100 21350	20 MHz	QPSK, 16QAM, 64QAM	1 RB / 0 RB Offset
-	Modulation Characteristics	20800 to 21400	21110	10 MHz	QPSK, 16QAM, 64QAM	50 RB / 0 RB Offset
-	Frequency Stability	20775 to 21425	20775, 21425	5 MHz	QPSK	1 RB / 0 RB Offset
		20800 to 21400	20800, 21400	10 MHz	QPSK	1 RB / 0 RB Offset
		20825 to 21375	20825, 21375	15 MHz	QPSK	1 RB / 0 RB Offset
		20850 to 21350	20850, 21350	20 MHz	QPSK	1 RB / 0 RB Offset
-	Occupied Bandwidth	20775 to 21425	20775, 21100, 21425	5 MHz	QPSK, 16QAM, 64QAM	25 RB / 0 RB Offset
		20800 to 21400	20800, 21100, 21400	10 MHz	QPSK, 16QAM, 64QAM	50 RB / 0 RB Offset
		20825 to 21375	20825, 21100, 21375	15 MHz	QPSK, 16QAM, 64QAM	75 RB / 0 RB Offset
		20850 to 21350	20850, 21100 21350	20 MHz	QPSK, 16QAM, 64QAM	100 RB / 0 RB Offset
-	Peak to Average Ratio	20775 to 21425	20775, 21100, 21425	5 MHz	QPSK, 16QAM, 64QAM	1 RB / 0 RB Offset
		20800 to 21400	20800, 21100, 21400	10 MHz	QPSK, 16QAM, 64QAM	1 RB / 0 RB Offset
		20825 to 21375	20825, 21100, 21375	15 MHz	QPSK, 16QAM, 64QAM	1 RB / 0 RB Offset
		20850 to 21350	20850, 21100 21350	20 MHz	QPSK, 16QAM, 64QAM	1 RB / 0 RB Offset
-	Out-of-Band Emissions	20775 to 21425	20775, 21425	5 MHz	QPSK, 16QAM, 64QAM	25 RB / 0 RB Offset
		20800 to 21400	20800, 21400	10 MHz	QPSK, 16QAM, 64QAM	50 RB / 0 RB Offset
		20825 to 21375	20825, 21375	15 MHz	QPSK, 16QAM, 64QAM	75 RB / 0 RB Offset
		20850 to 21350	20850, 21350	20 MHz	QPSK, 16QAM, 64QAM	100 RB / 0 RB Offset
-	Conducted Emission	20775 to 21425	20775, 21100, 21425	5 MHz	QPSK	1 RB / 0 RB Offset
		20800 to 21400	20800, 21100, 21400	10 MHz	QPSK	1 RB / 0 RB Offset
		20825 to 21375	20825, 21100, 21375	15 MHz	QPSK	1 RB / 0 RB Offset
		20850 to 21350	20850, 21100 21350	20 MHz	QPSK	1 RB / 0 RB Offset

EUT Configure Mode	Test Item	Available Channel	Tested Channel	Channel Bandwidth	Modulation	Mode
-	Radiated Emission	20775 to 21425	20775, 21100, 21425	5 MHz	QPSK	1 RB / 0 RB Offset
		20850 to 21350	20850, 21100 21350	20 MHz	QPSK	1 RB / 0 RB Offset

**Note:** This device was tested under all bandwidths, RB configurations and modulations. The worst case was found in QPSK modulation.

### LTE Band 38

EUT Configure Mode	Test Item	Available Channel	Tested Channel	Channel Bandwidth	Modulation	Mode
-	EIRP	37775 to 38225	37775, 38000, 38225	5 MHz	QPSK, 16QAM, 64QAM	1 RB / 24 RB Offset
		37800 to 38200	37800, 38000, 38200	10 MHz	QPSK, 16QAM, 64QAM	1 RB / 49 RB Offset
		37825 to 38175	37825, 38000, 38175	15 MHz	QPSK, 16QAM, 64QAM	1 RB / 74 RB Offset
		37850 to 38150	37850, 38000, 38150	20 MHz	QPSK, 16QAM, 64QAM	1 RB / 99 RB Offset
-	Modulation Characteristics	37850 to 38150	37850	20 MHz	QPSK, 16QAM, 64QAM	25 RB / 0 RB Offset
-	Frequency Stability	37775 to 38225	37775, 38225	5 MHz	QPSK	1 RB / 0 RB Offset
		37800 to 38200	37800, 38200	10 MHz	QPSK	1 RB / 0 RB Offset
		37825 to 38175	37825, 38175	15 MHz	QPSK	1 RB / 0 RB Offset
		37850 to 38150	37850, 38150	20 MHz	QPSK	1 RB / 0 RB Offset
-	Occupied Bandwidth	37775 to 38225	37775, 38000, 38225	5 MHz	QPSK, 16QAM, 64QAM	25 RB / 0 RB Offset
		37800 to 38200	37800, 38000, 38200	10 MHz	QPSK, 16QAM, 64QAM	50 RB / 0 RB Offset
		37825 to 38175	37825, 38000, 38175	15 MHz	QPSK, 16QAM, 64QAM	75 RB / 0 RB Offset
		37850 to 38150	37850, 38000, 38150	20 MHz	QPSK, 16QAM, 64QAM	100 RB / 0 RB Offset
-	Peak to Average Ratio	37775 to 38225	37775, 38000, 38225	5 MHz	QPSK, 16QAM, 64QAM	1 RB / 0 RB Offset
		37800 to 38200	37800, 38000, 38200	10 MHz	QPSK, 16QAM, 64QAM	1 RB / 0 RB Offset
		37825 to 38175	37825, 38000, 38175	15 MHz	QPSK, 16QAM, 64QAM	1 RB / 0 RB Offset
		37850 to 38150	37850, 38000, 38150	20 MHz	QPSK, 16QAM, 64QAM	1 RB / 0 RB Offset
-	Out-of-Band Emissions	37775 to 38225	37775, 38225	5 MHz	QPSK, 16QAM, 64QAM	25 RB / 0 RB Offset
		37800 to 38200	37800, 38200	10 MHz	QPSK, 16QAM, 64QAM	50 RB / 0 RB Offset
		37825 to 38175	37825, 38175	15 MHz	QPSK, 16QAM, 64QAM	75 RB / 0 RB Offset
		37850 to 38150	37850, 38150	20 MHz	QPSK, 16QAM, 64QAM	100 RB / 0 RB Offset
-	Conducted Emission	37775 to 38225	37775, 38000, 38225	5 MHz	QPSK	1 RB / 24 RB Offset
		37800 to 38200	37800, 38000, 38200	10 MHz	QPSK	1 RB / 49 RB Offset
		37825 to 38175	37825, 38000, 38175	15 MHz	QPSK	1 RB / 74 RB Offset
		37850 to 38150	37850, 38000, 38150	20 MHz	QPSK	1 RB / 99 RB Offset
-	Radiated Emission	37775 to 38225	37775, 38000, 38225	5 MHz	QPSK	1 RB / 24 RB Offset
		37850 to 38150	37850, 38000, 38150	20 MHz	QPSK	1 RB / 99 RB Offset

**Note:** This device was tested under all bandwidths, RB configurations and modulations. The worst case was found in QPSK modulation.

### LTE Band 41

EUT Configure Mode	Test Item	Available Channel	Tested Channel	Channel Bandwidth	Modulation	Mode
-	EIRP	39675 to 41565	39675, 40620, 41565	5 MHz	QPSK, 16QAM, 64QAM	1 RB / 0 RB Offset
		39700 to 41540	39700, 40620, 41540	10 MHz	QPSK, 16QAM, 64QAM	1 RB / 0 RB Offset
		39725 to 41515	39725, 40620, 41515	15 MHz	QPSK, 16QAM, 64QAM	1 RB / 0 RB Offset
		39750 to 41490	39750, 40620, 41490	20 MHz	QPSK, 16QAM, 64QAM	1 RB / 0 RB Offset
-	Modulation Characteristics	39750 to 41490	39750	20 MHz	QPSK, 16QAM, 64QAM	25 RB / 0 RB Offset
-	Frequency Stability	39675 to 41565	39675, 41565	5 MHz	QPSK	1 RB / 0 RB Offset
		39700 to 41540	39700, 41540	10 MHz	QPSK	1 RB / 0 RB Offset
		39725 to 41515	39725, 41515	15 MHz	QPSK	1 RB / 0 RB Offset
		39750 to 41490	39750, 41490	20 MHz	QPSK	1 RB / 0 RB Offset
-	Occupied Bandwidth	39675 to 41565	39675, 40620, 41565	5 MHz	QPSK, 16QAM, 64QAM	25 RB / 0 RB Offset
		39700 to 41540	39700, 40620, 41540	10 MHz	QPSK, 16QAM, 64QAM	50 RB / 0 RB Offset
		39725 to 41515	39725, 40620, 41515	15 MHz	QPSK, 16QAM, 64QAM	75 RB / 0 RB Offset
		39750 to 41490	39750, 40620, 41490	20 MHz	QPSK, 16QAM, 64QAM	100 RB / 0 RB Offset
-	Peak to Average Ratio	39675 to 41565	39675, 40620, 41565	5 MHz	QPSK, 16QAM, 64QAM	1 RB / 0 RB Offset
		39700 to 41540	39700, 40620, 41540	10 MHz	QPSK, 16QAM, 64QAM	1 RB / 0 RB Offset
		39725 to 41515	39725, 40620, 41515	15 MHz	QPSK, 16QAM, 64QAM	1 RB / 0 RB Offset
		39750 to 41490	39750, 40620, 41490	20 MHz	QPSK, 16QAM, 64QAM	1 RB / 0 RB Offset
-	Out-of-Band Emissions	39675 to 41565	39675, 41565	5 MHz	QPSK, 16QAM, 64QAM	25 RB / 0 RB Offset
		39700 to 41540	39700, 41540	10 MHz	QPSK, 16QAM, 64QAM	50 RB / 0 RB Offset
		39725 to 41515	39725, 41515	15 MHz	QPSK, 16QAM, 64QAM	75 RB / 0 RB Offset
		39750 to 41490	39750, 41490	20 MHz	QPSK, 16QAM, 64QAM	100 RB / 0 RB Offset
-	Conducted Emission	39675 to 41565	39675, 40620, 41565	5 MHz	QPSK	1 RB / 0 RB Offset
		39700 to 41540	39700, 40620, 41540	10 MHz	QPSK	1 RB / 0 RB Offset
		39725 to 41515	39725, 40620, 41515	15 MHz	QPSK	1 RB / 0 RB Offset
		39750 to 41490	39750, 40620, 41490	20 MHz	QPSK	1 RB / 0 RB Offset
-	Radiated Emission	39675 to 41565	39675, 40620, 41565	5 MHz	QPSK	1 RB / 0 RB Offset
		39750 to 41490	39750, 40620, 41490	20 MHz	QPSK	1 RB / 0 RB Offset

**Note:** This device was tested under all bandwidths, RB configurations and modulations. The worst case was found in QPSK modulation.

**Test Condition:**

Test Item	Environmental Conditions	Input Power	Tested By
EIRP	25 deg. C, 65 % RH	3.85 Vdc	Thomas Wei
Modulation Characteristics	25 deg. C, 65 % RH	3.85 Vdc	Wayne Lin
Frequency Stability	25 deg. C, 65 % RH	3.85 Vdc	Wayne Lin
Occupied Bandwidth	25 deg. C, 65 % RH	3.85 Vdc	Wayne Lin
Out-of-Band Emissions	25 deg. C, 65 % RH	3.85 Vdc	Wayne Lin
Peak to Average Ratio	25 deg. C, 65 % RH	3.85 Vdc	Wayne Lin
Conducted Emission	25 deg. C, 65 % RH	3.85 Vdc	Wayne Lin
Radiated Emission	25 deg. C, 65 % RH	120 Vac, 60 Hz	Thomas Wei

**3.4 EUT Operating Conditions**

The EUT makes a call to the communication simulator. The communication simulator station system controlled a EUT to export maximum output power under transmission mode and specific channel frequency

**3.5 General Description of Applied Standards**

The EUT is a RF Product. According to the specifications of the manufacturer, it must comply with the requirements of the following standards:

**FCC 47 CFR Part 2**

**FCC 47 CFR Part 27**

**KDB 971168 D01 Power Meas License Digital Systems v03r01**

**ANSI/TIA/EIA-603-E 2016**

**ANSI 63.26-2015**

**Note:** All test items have been performed and recorded as per the above standards.

## 4 Test Types and Results

### 4.1 Output Power Measurement

#### 4.1.1 Limits of Output Power Measurement

The radiated peak output power shall be according to the specific rule Part 27.50(h)(2) that “Mobile stations are limited to 2.0 watts EIRP. All user stations are limited to 2 watts transmitter output power” and 27.50(i) specific that “Peak transmit power must be measure over any interval of continuous transmission using instrumentation calibration in terms of rms-equivalent voltage.”

#### 4.1.2 Test Procedures

##### **EIRP Measurement:**

- a. All measurements were done at low, middle and high operational frequency range. RBW and VBW is 10 MHz for LTE mode.
- b. Substitution method is used for E.I.R.P measurement. In the semi-anechoic chamber, EUT placed on the 0.8 m (below or equal 1 GHz) and/or 1.5 m (above 1 GHz) height of Turn Table, rotated the table around 360 degrees to search the maximum radiation power and receiver antenna shall be rotated vertical and horizontal polarization and moved height from 1 m to 4 m to find the maximum polar radiated power. The “Read Value” is the spectrum reading the maximum power value.
- c. The substitution horn antenna is substituted for EUT at the same position and signals generator export the CW signal to the substitution antenna via a tx cable. Rotated the Turn Table and moved receiving antenna to find the maximum radiation power. Adjust output power level of S.G to get a Value of spectrum reading equal to “Read Value“ of step b. Record the power level of S.G.
- d.  $EIRP = \text{Output power level of S.G} - \text{TX cable loss} + \text{Antenna gain of substitution horn}.$

##### **Conducted Power Measurement:**

- a. The EUT was set up for the maximum power with LTE link data modulation and link up with simulator.
- b. Set the EUT to transmit under low, middle and high channel and record the power level shown on simulator.



4.1.3 Test Setup

**EIRP / ERP Measurement:  
<Radiated Emission below or equal 1 GHz>**

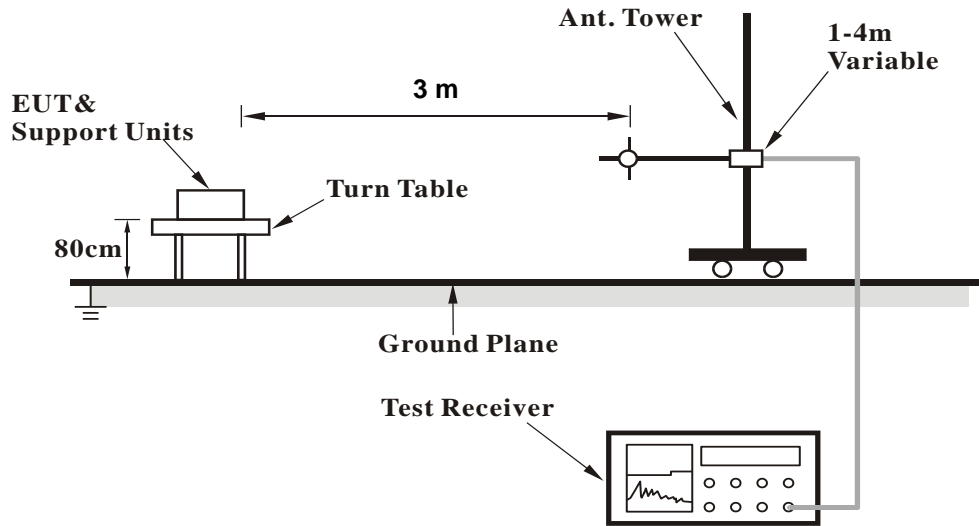

**<Radiated Emission above 1 GHz>**

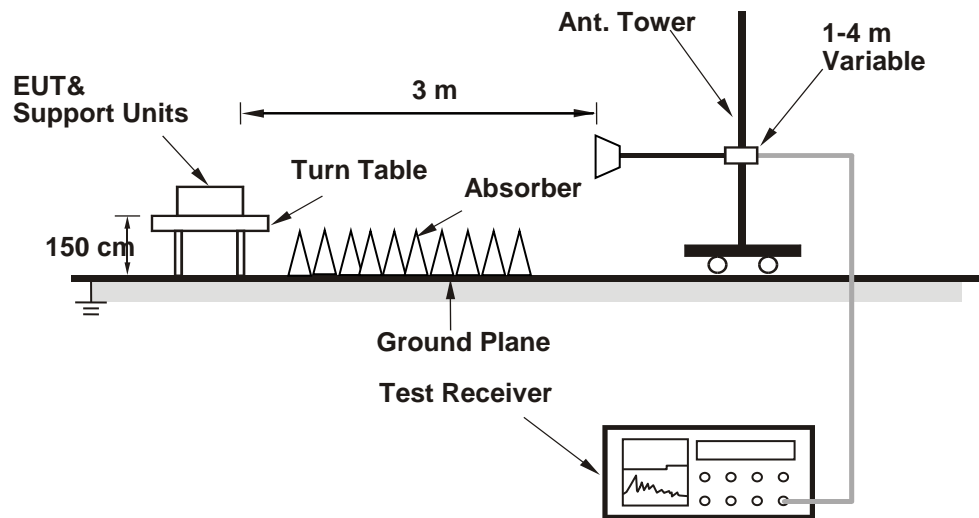

For the actual test configuration, please refer to the attached file (Test Setup Photo).

**Conducted Power Measurement:**



#### 4.1.4 Test Results

The worst configuration mode is presented in the report as below. Please refer to SAR test report for more detail test mode.

Band		TX Antenna	WLAN Function	Body-Worn/Hotspot
LTE	B7	Ant 2	WLAN-Off	Body-Worn/Hotspot
	B38	Ant 2	WLAN-Off	Body-Worn/Hotspot
	B41	Ant 2	WLAN-Off	Body-Worn/Hotspot

#### Conducted Output Power (dBm)

LTE Band 7																	
Body-Worn / Hotspot																	
Ant-2																	
BW	MCS Index	RB Size	RB Offset	Low	Mid	High	3GPP MPR (dB)	BW	MCS Index	RB Size	RB Offset	Low	Mid	High	3GPP MPR (dB)		
				20850	21100	21350						20825	21100	21375			
		Channel	2510.0	2535.0	2560.0	Channel	2507.5			2535.0	2562.5						
		Frequency (MHz)							Frequency (MHz)								
20M	QPSK	1	0	23.45	23.41	23.38	0	15M	QPSK	1	0	23.34	23.30	23.27	0		
		1	50	23.37	23.33	23.30	0			1	37	23.26	23.22	23.19	0		
		1	99	23.42	23.38	23.35	0			1	74	23.31	23.27	23.24	0		
		50	0	22.53	22.49	22.46	1			36	0	22.42	22.38	22.35	1		
		50	25	22.47	22.43	22.40	1			36	19	22.36	22.32	22.29	1		
		50	50	22.50	22.46	22.43	1			36	39	22.39	22.35	22.32	1		
		100	0	22.51	22.47	22.44	1			75	0	22.40	22.36	22.33	1		
	16QAM	1	0	22.42	22.38	22.35	1		16QAM	1	0	22.31	22.27	22.24	1		
		1	50	22.34	22.30	22.27	1			1	37	22.23	22.19	22.16	1		
		1	99	22.39	22.35	22.32	1			1	74	22.28	22.24	22.21	1		
		50	0	21.50	21.46	21.43	2			36	0	21.39	21.35	21.32	2		
		50	25	21.44	21.40	21.37	2			36	19	21.33	21.29	21.26	2		
		50	50	21.47	21.43	21.40	2			36	39	21.36	21.32	21.29	2		
		100	0	21.48	21.44	21.41	2			75	0	21.37	21.33	21.30	2		
	64QAM	1	0	21.41	21.37	21.34	2		64QAM	1	0	21.30	21.26	21.23	2		
		1	50	21.33	21.29	21.26	2			1	37	21.22	21.18	21.15	2		
		1	99	21.38	21.34	21.31	2			1	74	21.27	21.23	21.20	2		
		50	0	20.49	20.45	20.42	3			36	0	20.38	20.34	20.31	3		
		50	25	20.43	20.39	20.36	3			36	19	20.32	20.28	20.25	3		
		50	50	20.46	20.42	20.39	3			36	39	20.35	20.31	20.28	3		
		100	0	20.47	20.43	20.40	3			75	0	20.36	20.32	20.29	3		
	10M	QPSK	1	0	23.26	23.22	23.19		0	5M	QPSK	1	0	23.17	23.13	23.10	0
			1	24	23.18	23.14	23.11		0			1	12	23.09	23.05	23.02	0
			1	49	23.23	23.19	23.16		0			1	24	23.14	23.10	23.07	0
25			0	22.34	22.30	22.27	1	12	0			22.25	22.21	22.18	1		
25			12	22.28	22.24	22.21	1	12	6			22.19	22.15	22.12	1		
25			25	22.31	22.27	22.24	1	12	13			22.22	22.18	22.15	1		
50			0	22.32	22.28	22.25	1	25	0			22.23	22.19	22.16	1		
16QAM		1	0	22.23	22.19	22.16	1	16QAM	1		0	22.14	22.10	22.07	1		
		1	24	22.15	22.11	22.08	1		1		12	22.06	22.02	21.99	1		
		1	49	22.20	22.16	22.13	1		1		24	22.11	22.07	22.04	1		
		25	0	21.31	21.27	21.24	2		12		0	21.22	21.18	21.15	2		
		25	12	21.25	21.21	21.18	2		12		6	21.16	21.12	21.09	2		
		25	25	21.28	21.24	21.21	2		12		13	21.19	21.15	21.12	2		
		50	0	21.29	21.25	21.22	2		25		0	21.20	21.16	21.13	2		
64QAM		1	0	21.22	21.18	21.15	2	64QAM	1		0	21.13	21.09	21.06	2		
		1	24	21.14	21.10	21.07	2		1		12	21.05	21.01	20.98	2		
		1	49	21.19	21.15	21.12	2		1		24	21.10	21.06	21.03	2		
		25	0	20.30	20.26	20.23	3		12		0	20.21	20.17	20.14	3		
		25	12	20.24	20.20	20.17	3		12		6	20.15	20.11	20.08	3		
		25	25	20.27	20.23	20.20	3		12		13	20.18	20.14	20.11	3		
		50	0	20.28	20.24	20.21	3		25		0	20.19	20.15	20.12	3		

LTE Band 38

Body-Worn / Hotspot

Ant-2

BW	MCS Index	RB Size	RB Offset	Low	Mid	High	3GPP MPR (dB)	BW	MCS Index	RB Size	RB Offset	Low	Mid	High	3GPP MPR (dB)		
				37850	38000	38150						37825	38000	38175			
				Channel	2580.0	2595.0						2610.0	Channel	2577.5		2595.0	2612.5
				Frequency (MHz)				Frequency (MHz)									
20M	QPSK	1	0	24.61	24.62	24.58	0	15M	QPSK	1	0	24.53	24.54	24.50	0		
		1	50	24.65	24.66	24.62	0			1	37	24.57	24.58	24.54	0		
		1	99	24.68	24.69	24.65	0			1	74	24.60	24.61	24.57	0		
		50	0	23.60	23.61	23.57	1			36	0	23.52	23.53	23.49	1		
		50	25	23.65	23.66	23.62	1			36	19	23.57	23.58	23.54	1		
		50	50	23.67	23.68	23.64	1			36	39	23.59	23.60	23.56	1		
	16QAM	100	0	23.64	23.65	23.61	1		75	0	23.56	23.57	23.53	1			
		1	0	23.59	23.60	23.56	1		16QAM	1	0	23.51	23.52	23.48	1		
		1	50	23.63	23.64	23.60	1			1	37	23.55	23.56	23.52	1		
		1	99	23.66	23.67	23.63	1			1	74	23.58	23.59	23.55	1		
		50	0	22.58	22.59	22.55	2			36	0	22.50	22.51	22.47	2		
		50	25	22.63	22.64	22.60	2			36	19	22.55	22.56	22.52	2		
	50	50	22.65	22.66	22.62	2	36			39	22.57	22.58	22.54	2			
	64QAM	100	0	22.62	22.63	22.59	2		75	0	22.54	22.55	22.51	2			
		1	0	22.61	22.62	22.58	2		64QAM	1	0	22.53	22.54	22.50	2		
		1	50	22.65	22.66	22.62	2			1	37	22.57	22.58	22.54	2		
		1	99	22.68	22.69	22.65	2			1	74	22.60	22.61	22.57	2		
		50	0	21.60	21.61	21.57	3			36	0	21.52	21.53	21.49	3		
		50	25	21.65	21.66	21.62	3			36	19	21.57	21.58	21.54	3		
	50	50	21.67	21.68	21.64	3	36			39	21.59	21.60	21.56	3			
	10M	QPSK	100	0	21.64	21.65	21.61		3	75	0	21.56	21.57	21.53	3		
			1	0	24.47	24.48	24.44		0	5M	QPSK	1	0	24.40	24.41	24.37	0
			1	24	24.51	24.52	24.48		0			1	12	24.44	24.45	24.41	0
			1	49	24.54	24.55	24.51		0			1	24	24.47	24.48	24.44	0
25			0	23.46	23.47	23.43	1	12	0			23.39	23.40	23.36	1		
25			12	23.51	23.52	23.48	1	12	6			23.44	23.45	23.41	1		
25		25	23.53	23.54	23.50	1	12	13	23.46			23.47	23.43	1			
16QAM		50	0	23.50	23.51	23.47	1	25	0		23.43	23.44	23.40	1			
		1	0	23.45	23.46	23.42	1	16QAM	1		0	23.38	23.39	23.35	1		
		1	24	23.49	23.50	23.46	1		1		12	23.42	23.43	23.39	1		
		1	49	23.52	23.53	23.49	1		1		24	23.45	23.46	23.42	1		
		25	0	22.44	22.45	22.41	2		12		0	22.37	22.38	22.34	2		
		25	12	22.49	22.50	22.46	2		12		6	22.42	22.43	22.39	2		
25		25	22.51	22.52	22.48	2	12		13		22.44	22.45	22.41	2			
64QAM		50	0	22.48	22.49	22.45	2	25	0		22.41	22.42	22.38	2			
		1	0	22.47	22.48	22.44	2	64QAM	1		0	22.40	22.41	22.37	2		
		1	24	22.51	22.52	22.48	2		1		12	22.44	22.45	22.41	2		
		1	49	22.54	22.55	22.51	2		1		24	22.47	22.48	22.44	2		
		25	0	21.46	21.47	21.43	3		12		0	21.39	21.40	21.36	3		
		25	12	21.51	21.52	21.48	3		12		6	21.44	21.45	21.41	3		
25		25	21.53	21.54	21.50	3	12		13		21.46	21.47	21.43	3			
50		0	21.50	21.51	21.47	3	25	0	21.43		21.44	21.40	3				

**LTE Band 41 (Power Class 2)  
Body-Worn / Hotspot**

**Ant-2**

BW	MCS Index	RB Size	RB Offset	Low	Mid	High	3GPP MPR (dB)	BW	MCS Index	RB Size	RB Offset	Low	Mid	High	3GPP MPR (dB)				
				Channel	39750	40620						41490	Channel	39725		40620	41515		
				Frequency (MHz)	2506.0	2593.0						2680.0	Frequency (MHz)	2503.5		2593.0	2682.5		
20M	QPSK	1	0	25.67	25.56	25.58	0	15M	QPSK	1	0	25.70	25.51	25.53	0				
		1	50	25.64	25.53	25.55	0			1	37	25.67	25.48	25.50	0				
		1	99	25.62	25.51	25.53	0			1	74	25.65	25.46	25.48	0				
		50	0	24.69	24.58	24.60	1			36	0	24.72	24.53	24.55	1				
		50	25	24.67	24.56	24.58	1			36	19	24.70	24.51	24.53	1				
		50	50	24.64	24.53	24.55	1			36	39	24.67	24.48	24.50	1				
		100	0	24.66	24.55	24.57	1			75	0	24.69	24.50	24.52	1				
	16QAM	1	0	24.73	24.54	24.56	1		16QAM	1	0	24.68	24.49	24.51	1				
		1	50	24.70	24.51	24.53	1			1	37	24.65	24.46	24.48	1				
		1	99	24.68	24.49	24.51	1			1	74	24.63	24.44	24.46	1				
		50	0	23.75	23.56	23.58	2			36	0	23.70	23.51	23.53	2				
		50	25	23.73	23.54	23.56	2			36	19	23.68	23.49	23.51	2				
		50	50	23.70	23.51	23.53	2			36	39	23.65	23.46	23.48	2				
		100	0	23.72	23.53	23.55	2			75	0	23.67	23.48	23.50	2				
	64QAM	1	0	23.70	23.51	23.53	2		64QAM	1	0	23.65	23.46	23.48	2				
		1	50	23.67	23.48	23.50	2			1	37	23.62	23.43	23.45	2				
		1	99	23.65	23.46	23.48	2			1	74	23.60	23.41	23.43	2				
		50	0	22.72	22.53	22.55	3			36	0	22.67	22.48	22.50	3				
		50	25	22.70	22.51	22.53	3			36	19	22.65	22.46	22.48	3				
		50	50	22.67	22.48	22.50	3			36	39	22.62	22.43	22.45	3				
		100	0	22.69	22.50	22.52	3			75	0	22.64	22.45	22.47	3				
	BW	MCS Index	RB Size	RB Offset	Low	Mid	High		3GPP MPR (dB)	BW	MCS Index	RB Size	RB Offset	Low	Mid	High	3GPP MPR (dB)		
					Channel	39700	40620							41540	Channel	39675		40620	41565
					Frequency (MHz)	2501.0	2593.0							2685.0	Frequency (MHz)	2498.5		2593.0	2687.5
10M	QPSK	1	0	25.67	25.48	25.50	0	5M	QPSK	1	0	25.63	25.44	25.46	0				
		1	24	25.64	25.45	25.47	0			1	12	25.60	25.41	25.43	0				
		1	49	25.62	25.43	25.45	0			1	24	25.58	25.39	25.41	0				
		25	0	24.69	24.50	24.52	1			12	0	24.65	24.46	24.48	1				
		25	12	24.67	24.48	24.50	1			12	6	24.63	24.44	24.46	1				
		25	25	24.64	24.45	24.47	1			12	13	24.60	24.41	24.43	1				
		50	0	24.66	24.47	24.49	1			25	0	24.62	24.43	24.45	1				
	16QAM	1	0	24.65	24.46	24.48	1		16QAM	1	0	24.61	24.42	24.44	1				
		1	24	24.62	24.43	24.45	1			1	12	24.58	24.39	24.41	1				
		1	49	24.60	24.41	24.43	1			1	24	24.56	24.37	24.39	1				
		25	0	23.67	23.48	23.50	2			12	0	23.63	23.44	23.46	2				
		25	12	23.65	23.46	23.48	2			12	6	23.61	23.42	23.44	2				
		25	25	23.62	23.43	23.45	2			12	13	23.58	23.39	23.41	2				
		50	0	23.64	23.45	23.47	2			25	0	23.60	23.41	23.43	2				
	64QAM	1	0	23.62	23.43	23.45	2		64QAM	1	0	23.58	23.39	23.41	2				
		1	24	23.59	23.40	23.42	2			1	12	23.55	23.36	23.38	2				
		1	49	23.57	23.38	23.40	2			1	24	23.53	23.34	23.36	2				
		25	0	22.64	22.45	22.47	3			12	0	22.60	22.41	22.43	3				
		25	12	22.62	22.43	22.45	3			12	6	22.58	22.39	22.41	3				
		25	25	22.59	22.40	22.42	3			12	13	22.55	22.36	22.38	3				
		50	0	22.61	22.42	22.44	3			25	0	22.57	22.38	22.40	3				

**LTE Band 41 (Power Class 3)  
Body-Worn / Hotspot**

**Ant-2**

BW	MCS Index	RB Size	RB Offset	Low	Mid	High	3GPP MPR (dB)	BW	MCS Index	RB Size	RB Offset	Low	Mid	High	3GPP MPR (dB)		
				Channel	39750	40620						41490	Channel	39725		40620	41515
				Frequency (MHz)	2506.0	2593.0						2680.0	Frequency (MHz)	2503.5		2593.0	2682.5
20M	QPSK	1	0	23.94	23.98	23.87	0	15M	QPSK	1	0	23.88	23.93	23.74	0		
		1	50	23.90	23.89	23.84	0			1	37	23.88	23.81	23.85	0		
		1	99	23.92	23.91	23.85	0			1	74	23.83	23.89	23.86	0		
		50	0	22.98	22.97	22.93	1			36	0	22.88	22.93	22.86	1		
		50	25	22.95	22.94	22.90	1			36	19	22.93	22.85	22.90	1		
		50	50	22.96	22.95	22.91	1			36	39	22.88	22.93	22.91	1		
		100	0	22.94	22.93	22.89	1			75	0	22.85	22.89	22.81	1		
	16QAM	1	0	22.85	22.91	22.84	1		16QAM	1	0	22.92	22.94	22.81	1		
		1	50	22.90	22.79	22.77	1			1	37	22.89	22.87	22.82	1		
		1	99	22.84	22.88	22.85	1			1	74	22.90	22.88	22.86	1		
		50	0	21.92	21.92	21.88	2			36	0	21.95	21.93	21.86	2		
		50	25	21.93	21.85	21.85	2			36	19	21.92	21.94	21.88	2		
		50	50	21.96	21.91	21.86	2			36	39	21.93	21.87	21.84	2		
		100	0	21.85	21.89	21.81	2			75	0	21.88	21.92	21.80	2		
	64QAM	1	0	21.89	21.96	21.78	2		64QAM	1	0	21.86	21.93	21.79	2		
		1	50	21.90	21.82	21.81	2			1	37	21.81	21.86	21.85	2		
		1	99	21.90	21.87	21.85	2			1	74	21.88	21.82	21.83	2		
		50	0	20.89	20.95	20.88	3			36	0	20.90	20.95	20.92	3		
		50	25	20.89	20.91	20.80	3			36	19	20.92	20.94	20.86	3		
		50	50	20.93	20.93	20.81	3			36	39	20.89	20.85	20.85	3		
		100	0	20.88	20.89	20.89	3			75	0	20.94	20.93	20.80	3		
	10M	QPSK	1	0	23.87	23.90	23.74		0	5M	QPSK	1	0	23.83	23.81	23.79	0
			1	24	23.78	23.74	23.77		0			1	12	23.75	23.82	23.73	0
			1	49	23.82	23.82	23.71		0			1	24	23.83	23.82	23.78	0
25			0	22.93	22.78	22.80	1	12	0			22.83	22.85	22.82	1		
25			12	22.82	22.82	22.74	1	12	6			22.82	22.81	22.77	1		
25			25	22.87	22.86	22.73	1	12	13			22.89	22.84	22.83	1		
50			0	22.78	22.83	22.81	1	25	0			22.79	22.81	22.80	1		
16QAM		1	0	22.84	22.87	22.76	1	16QAM	1		0	22.86	22.82	22.69	1		
		1	24	22.80	22.77	22.82	1		1		12	22.82	22.88	22.67	1		
		1	49	22.80	22.83	22.75	1		1		24	22.78	22.86	22.79	1		
		25	0	21.89	21.78	21.86	2		12		0	21.89	21.79	21.90	2		
		25	12	21.86	21.88	21.76	2		12		6	21.81	21.86	21.72	2		
		25	25	21.80	21.80	21.74	2		12		13	21.81	21.93	21.84	2		
		50	0	21.80	21.93	21.79	2		25		0	21.86	21.86	21.75	2		
64QAM		1	0	21.92	21.86	21.73	2	64QAM	1		0	21.84	21.90	21.74	2		
		1	24	21.81	21.81	21.74	2		1		12	21.76	21.84	21.67	2		
		1	49	21.79	21.90	21.72	2		1		24	21.83	21.80	21.78	2		
		25	0	20.95	20.84	20.80	3		12		0	20.85	20.83	20.90	3		
		25	12	20.81	20.80	20.82	3		12		6	20.82	20.89	20.78	3		
		25	25	20.81	20.84	20.76	3		12		13	20.87	20.92	20.75	3		
		50	0	20.76	20.92	20.77	3		25		0	20.79	20.80	20.81	3		

**EIRP Power (dBm)**

LTE Band 7							
Channel Bandwidth: 5 MHz / QPSK							
Plane	Channel	Frequency (MHz)	Reading (dBm)	Correction Factor (dB)	EIRP (dBm)	EIRP (mW)	Polarization (H/V)
X	20775	2502.5	-17.32	38.52	21.20	131.83	H
	21100	2535.0	-16.98	38.36	21.38	137.40	
	21425	2567.5	-17.16	38.58	21.42	138.68	
	20775	2502.5	-25.38	38.92	13.54	22.59	V
	21100	2535.0	-25.42	39.26	13.84	24.21	
	21425	2567.5	-25.22	39.22	14.00	25.12	
Channel Bandwidth: 5 MHz / 16QAM							
X	20775	2502.5	-18.34	38.52	20.18	104.23	H
	21100	2535.0	-18.00	38.36	20.36	108.64	
	21425	2567.5	-18.18	38.58	20.40	109.65	
	20775	2502.5	-26.40	38.92	12.52	17.86	V
	21100	2535.0	-26.44	39.26	12.82	19.14	
	21425	2567.5	-26.24	39.22	12.98	19.86	
Channel Bandwidth: 5 MHz / 64QAM							
X	20775	2502.5	-19.32	38.52	19.20	83.18	H
	21100	2535.0	-18.98	38.36	19.38	86.70	
	21425	2567.5	-19.16	38.58	19.42	87.50	
	20775	2502.5	-27.38	38.92	11.54	14.26	V
	21100	2535.0	-27.42	39.26	11.84	15.28	
	21425	2567.5	-27.22	39.22	12.00	15.85	

Note: EIRP (dBm) = Reading (dBm) + Correction Factor (dB)

LTE Band 7							
Channel Bandwidth: 10 MHz / QPSK							
Plane	Channel	Frequency (MHz)	Reading (dBm)	Correction Factor (dB)	EIRP (dBm)	EIRP (mW)	Polarization (H/V)
X	20800	2505.0	-17.16	38.65	21.49	140.93	H
	21100	2535.0	-16.69	38.36	21.67	146.89	
	21400	2565.0	-16.78	38.49	21.71	148.25	
	20800	2505.0	-25.01	38.84	13.83	24.15	V
	21100	2535.0	-25.13	39.26	14.13	25.88	
	21400	2565.0	-24.81	39.10	14.29	26.85	
Channel Bandwidth: 10 MHz / 16QAM							
X	20800	2505.0	-18.19	38.65	20.46	111.17	H
	21100	2535.0	-17.72	38.36	20.64	115.88	
	21400	2565.0	-17.81	38.49	20.68	116.95	
	20800	2505.0	-26.04	38.84	12.80	19.05	V
	21100	2535.0	-26.16	39.26	13.10	20.42	
	21400	2565.0	-25.84	39.10	13.26	21.18	
Channel Bandwidth: 10 MHz / 64QAM							
X	20800	2505.0	-19.28	38.65	19.37	86.50	H
	21100	2535.0	-18.81	38.36	19.55	90.16	
	21400	2565.0	-18.90	38.49	19.59	90.99	
	20800	2505.0	-27.13	38.84	11.71	14.83	V
	21100	2535.0	-27.25	39.26	12.01	15.89	
	21400	2565.0	-26.93	39.10	12.17	16.48	

Note: EIRP (dBm) = Reading (dBm) + Correction Factor (dB)

LTE Band 7							
Channel Bandwidth: 15 MHz / QPSK							
Plane	Channel	Frequency (MHz)	Reading (dBm)	Correction Factor (dB)	EIRP (dBm)	EIRP (mW)	Polarization (H/V)
X	20825	2507.5	-16.74	38.52	21.78	150.66	H
	21100	2535.0	-16.40	38.36	21.96	157.04	
	21375	2562.5	-16.58	38.58	22.00	158.49	
	20825	2507.5	-24.80	38.92	14.12	25.82	V
	21100	2535.0	-24.84	39.26	14.42	27.67	
	21375	2562.5	-24.64	39.22	14.58	28.71	
Channel Bandwidth: 15 MHz / 16QAM							
X	20825	2507.5	-17.73	38.52	20.79	119.95	H
	21100	2535.0	-17.39	38.36	20.97	125.03	
	21375	2562.5	-17.57	38.58	21.01	126.18	
	20825	2507.5	-25.79	38.92	13.13	20.56	V
	21100	2535.0	-25.83	39.26	13.43	22.03	
	21375	2562.5	-25.63	39.22	13.59	22.86	
Channel Bandwidth: 15 MHz / 64QAM							
X	20825	2507.5	-18.72	38.52	19.80	95.50	H
	21100	2535.0	-18.38	38.36	19.98	99.54	
	21375	2562.5	-18.56	38.58	20.02	100.46	
	20825	2507.5	-26.78	38.92	12.14	16.37	V
	21100	2535.0	-26.82	39.26	12.44	17.54	
	21375	2562.5	-26.62	39.22	12.60	18.20	

Note: EIRP (dBm) = Reading (dBm) + Correction Factor (dB)



LTE Band 7							
Channel Bandwidth: 20 MHz / QPSK							
Plane	Channel	Frequency (MHz)	Reading (dBm)	Correction Factor (dB)	EIRP (dBm)	EIRP (mW)	Polarization (H/V)
X	20850	2510.0	-16.51	38.52	22.01	158.85	H
	21100	2535.0	-16.17	38.36	22.19	165.58	
	21350	2560.0	-16.35	38.58	22.23	167.11	
	20850	2510.0	-24.57	38.92	14.35	27.23	V
	21100	2535.0	-24.61	39.26	14.65	29.17	
	21350	2560.0	-24.41	39.22	14.81	30.27	
Channel Bandwidth: 20 MHz / 16QAM							
X	20850	2510.0	-17.53	38.52	20.99	125.60	H
	21100	2535.0	-17.19	38.36	21.17	130.92	
	21350	2560.0	-17.37	38.58	21.21	132.13	
	20850	2510.0	-25.59	38.92	13.33	21.53	V
	21100	2535.0	-25.63	39.26	13.63	23.07	
	21350	2560.0	-25.43	39.22	13.79	23.93	
Channel Bandwidth: 20 MHz / 64QAM							
X	20850	2510.0	-18.55	38.52	19.97	99.31	H
	21100	2535.0	-18.21	38.36	20.15	103.51	
	21350	2560.0	-18.39	38.58	20.19	104.47	
	20850	2510.0	-26.61	38.92	12.31	17.02	V
	21100	2535.0	-26.65	39.26	12.61	18.24	
	21350	2560.0	-26.45	39.22	12.77	18.92	

Note: EIRP (dBm) = Reading (dBm) + Correction Factor (dB)

LTE Band 38							
Channel Bandwidth: 5 MHz / QPSK							
Plane	Channel	Frequency (MHz)	Reading (dBm)	Correction Factor (dB)	EIRP (dBm)	EIRP (mW)	Polarization (H/V)
X	37775	2572.5	-15.90	38.99	23.09	203.70	H
	38000	2595.0	-15.18	38.17	22.99	199.07	
	38225	2617.5	-15.52	38.55	23.03	200.91	
	37775	2572.5	-24.18	39.27	15.09	32.28	V
	38000	2595.0	-23.92	38.68	14.76	29.92	
	38225	2617.5	-23.62	38.55	14.93	31.12	
Channel Bandwidth: 5 MHz / 16QAM							
X	37775	2572.5	-16.95	38.99	22.04	159.96	H
	38000	2595.0	-16.23	38.17	21.94	156.31	
	38225	2617.5	-16.57	38.55	21.98	157.76	
	37775	2572.5	-25.23	39.27	14.04	25.35	V
	38000	2595.0	-24.97	38.68	13.71	23.50	
	38225	2617.5	-24.67	38.55	13.88	24.43	
Channel Bandwidth: 5 MHz / 64QAM							
X	37775	2572.5	-18.21	38.99	20.78	119.67	H
	38000	2595.0	-17.49	38.17	20.68	116.95	
	38225	2617.5	-17.83	38.55	20.72	118.03	
	37775	2572.5	-26.49	39.27	12.78	18.97	V
	38000	2595.0	-26.23	38.68	12.45	17.58	
	38225	2617.5	-25.93	38.55	12.62	18.28	

Note: EIRP (dBm) = Reading (dBm) + Correction Factor (dB)

LTE Band 38							
Channel Bandwidth: 10 MHz / QPSK							
Plane	Channel	Frequency (MHz)	Reading (dBm)	Correction Factor (dB)	EIRP (dBm)	EIRP (mW)	Polarization (H/V)
X	37800	2575.0	-15.65	38.98	23.33	215.28	H
	38000	2595.0	-14.94	38.17	23.23	210.38	
	38200	2615.0	-15.18	38.45	23.27	212.32	
	37800	2575.0	-23.71	39.04	15.33	34.12	V
	38000	2595.0	-23.68	38.68	15.00	31.62	
	38200	2615.0	-23.43	38.60	15.17	32.89	
Channel Bandwidth: 10 MHz / 16QAM							
X	37800	2575.0	-16.63	38.98	22.35	171.79	H
	38000	2595.0	-15.92	38.17	22.25	167.88	
	38200	2615.0	-16.16	38.45	22.29	169.43	
	37800	2575.0	-24.69	39.04	14.35	27.23	V
	38000	2595.0	-24.66	38.68	14.02	25.23	
	38200	2615.0	-24.41	38.60	14.19	26.24	
Channel Bandwidth: 10 MHz / 64QAM							
X	37800	2575.0	-17.93	38.98	21.05	127.35	H
	38000	2595.0	-17.22	38.17	20.95	124.45	
	38200	2615.0	-17.46	38.45	20.99	125.60	
	37800	2575.0	-25.99	39.04	13.05	20.18	V
	38000	2595.0	-25.96	38.68	12.72	18.71	
	38200	2615.0	-25.71	38.60	12.89	19.45	

Note: EIRP (dBm) = Reading (dBm) + Correction Factor (dB)

LTE Band 38							
Channel Bandwidth: 15 MHz / QPSK							
Plane	Channel	Frequency (MHz)	Reading (dBm)	Correction Factor (dB)	EIRP (dBm)	EIRP (mW)	Polarization (H/V)
X	37825	2577.5	-15.49	39.09	23.60	229.09	H
	38000	2595.0	-14.67	38.17	23.50	223.87	
	38175	2612.5	-14.98	38.52	23.54	225.94	
	37825	2577.5	-23.44	39.04	15.60	36.31	V
	38000	2595.0	-23.41	38.68	15.27	33.65	
	38175	2612.5	-23.22	38.66	15.44	34.99	
Channel Bandwidth: 15 MHz / 16QAM							
X	37825	2577.5	-16.51	39.09	22.58	181.13	H
	38000	2595.0	-15.69	38.17	22.48	177.01	
	38175	2612.5	-16.00	38.52	22.52	178.65	
	37825	2577.5	-24.46	39.04	14.58	28.71	V
	38000	2595.0	-24.43	38.68	14.25	26.61	
	38175	2612.5	-24.24	38.66	14.42	27.67	
Channel Bandwidth: 15 MHz / 64QAM							
X	37825	2577.5	-17.53	39.09	21.56	143.22	H
	38000	2595.0	-16.71	38.17	21.46	139.96	
	38175	2612.5	-17.02	38.52	21.50	141.25	
	37825	2577.5	-25.48	39.04	13.56	22.70	V
	38000	2595.0	-25.45	38.68	13.23	21.04	
	38175	2612.5	-25.26	38.66	13.40	21.88	

Note: EIRP (dBm) = Reading (dBm) + Correction Factor (dB)

LTE Band 38							
Channel Bandwidth: 20 MHz / QPSK							
Plane	Channel	Frequency (MHz)	Reading (dBm)	Correction Factor (dB)	EIRP (dBm)	EIRP (mW)	Polarization (H/V)
X	37850	2580.0	-15.41	39.26	23.85	242.66	H
	38000	2595.0	-14.42	38.17	23.75	237.14	
	38150	2610.0	-14.92	38.71	23.79	239.33	
	37850	2580.0	-23.48	39.33	15.85	38.46	V
	38000	2595.0	-23.16	38.68	15.52	35.65	
	38150	2610.0	-23.07	38.76	15.69	37.07	
Channel Bandwidth: 20 MHz / 16QAM							
X	37850	2580.0	-16.43	39.26	22.83	191.87	H
	38000	2595.0	-15.44	38.17	22.73	187.50	
	38150	2610.0	-15.94	38.71	22.77	189.23	
	37850	2580.0	-24.50	39.33	14.83	30.41	V
	38000	2595.0	-24.18	38.68	14.50	28.18	
	38150	2610.0	-24.09	38.76	14.67	29.31	
Channel Bandwidth: 20 MHz / 64QAM							
X	37850	2580.0	-17.45	39.26	21.81	151.71	H
	38000	2595.0	-16.46	38.17	21.71	148.25	
	38150	2610.0	-16.96	38.71	21.75	149.62	
	37850	2580.0	-25.52	39.33	13.81	24.04	V
	38000	2595.0	-25.20	38.68	13.48	22.28	
	38150	2610.0	-25.11	38.76	13.65	23.17	

Note: EIRP (dBm) = Reading (dBm) + Correction Factor (dB)

<POWER CLASS 2>

LTE Band 41							
Channel Bandwidth: 5 MHz / QPSK							
Plane	Channel	Frequency (MHz)	Reading (dBm)	Correction Factor (dB)	EIRP (dBm)	EIRP (mW)	Polarization (H/V)
X	39675	2498.5	-16.06	38.99	22.93	196.34	H
	40620	2593.0	-15.15	38.17	23.02	200.45	
	41565	2687.5	-15.67	38.55	22.88	194.09	
	39675	2498.5	-22.51	39.27	16.76	47.42	V
	40620	2593.0	-21.88	38.68	16.80	47.86	
	41565	2687.5	-21.84	38.55	16.71	46.88	
Channel Bandwidth: 5 MHz / 16QAM							
X	39675	2498.5	-17.11	38.99	21.88	154.17	H
	40620	2593.0	-16.16	38.17	22.01	158.85	
	41565	2687.5	-16.70	38.55	21.85	153.11	
	39675	2498.5	-23.55	39.27	15.72	37.33	V
	40620	2593.0	-22.86	38.68	15.82	38.19	
	41565	2687.5	-22.91	38.55	15.64	36.64	
Channel Bandwidth: 5 MHz / 64QAM							
X	39675	2498.5	-17.94	38.99	21.05	127.35	H
	40620	2593.0	-17.10	38.17	21.07	127.94	
	41565	2687.5	-17.67	38.55	20.88	122.46	
	39675	2498.5	-24.46	39.27	14.81	30.27	V
	40620	2593.0	-23.86	38.68	14.82	30.34	
	41565	2687.5	-23.89	38.55	14.66	29.24	

Note: EIRP (dBm) = Reading (dBm) + Correction Factor (dB)

LTE Band 41							
Channel Bandwidth: 10 MHz / QPSK							
Plane	Channel	Frequency (MHz)	Reading (dBm)	Correction Factor (dB)	EIRP (dBm)	EIRP (mW)	Polarization (H/V)
X	39700	2501.0	-15.74	38.98	23.24	210.86	H
	40620	2593.0	-14.86	38.17	23.31	214.29	
	41540	2685.0	-15.17	38.45	23.28	212.81	
	39700	2501.0	-22.00	39.04	17.04	50.58	V
	40620	2593.0	-21.57	38.68	17.11	51.40	
	41540	2685.0	-21.57	38.60	17.03	50.47	
Channel Bandwidth: 10 MHz / 16QAM							
X	39700	2501.0	-16.83	38.98	22.15	164.06	H
	40620	2593.0	-15.83	38.17	22.34	171.40	
	41540	2685.0	-16.29	38.45	22.16	164.44	
	39700	2501.0	-23.00	39.04	16.04	40.18	V
	40620	2593.0	-22.61	38.68	16.07	40.46	
	41540	2685.0	-22.65	38.60	15.95	39.36	
Channel Bandwidth: 10 MHz / 64QAM							
X	39700	2501.0	-17.83	38.98	21.15	130.32	H
	40620	2593.0	-16.89	38.17	21.28	134.28	
	41540	2685.0	-17.30	38.45	21.15	130.32	
	39700	2501.0	-23.91	39.04	15.13	32.58	V
	40620	2593.0	-23.51	38.68	15.17	32.89	
	41540	2685.0	-23.55	38.60	15.05	31.99	

Note: EIRP (dBm) = Reading (dBm) + Correction Factor (dB)

LTE Band 41							
Channel Bandwidth: 15 MHz / QPSK							
Plane	Channel	Frequency (MHz)	Reading (dBm)	Correction Factor (dB)	EIRP (dBm)	EIRP (mW)	Polarization (H/V)
X	39725	2503.5	-15.54	39.09	23.55	226.46	H
	40620	2593.0	-14.60	38.17	23.57	227.51	
	41515	2682.5	-15.15	38.52	23.37	217.27	
	39725	2503.5	-21.76	39.04	17.28	53.46	V
	40620	2593.0	-21.37	38.68	17.31	53.83	
	41515	2682.5	-21.42	38.66	17.24	52.97	
Channel Bandwidth: 15 MHz / 16QAM							
X	39725	2503.5	-16.58	39.09	22.51	178.24	H
	40620	2593.0	-15.54	38.17	22.63	183.23	
	41515	2682.5	-16.07	38.52	22.45	175.79	
	39725	2503.5	-22.67	39.04	16.37	43.35	V
	40620	2593.0	-22.37	38.68	16.31	42.76	
	41515	2682.5	-22.44	38.66	16.22	41.88	
Channel Bandwidth: 15 MHz / 64QAM							
X	39725	2503.5	-17.54	39.09	21.55	142.89	H
	40620	2593.0	-16.63	38.17	21.54	142.56	
	41515	2682.5	-17.19	38.52	21.33	135.83	
	39725	2503.5	-23.73	39.04	15.31	33.96	V
	40620	2593.0	-23.31	38.68	15.37	34.43	
	41515	2682.5	-23.37	38.66	15.29	33.81	

Note: EIRP (dBm) = Reading (dBm) + Correction Factor (dB)



LTE Band 41							
Channel Bandwidth: 20 MHz / QPSK							
Plane	Channel	Frequency (MHz)	Reading (dBm)	Correction Factor (dB)	EIRP (dBm)	EIRP (mW)	Polarization (H/V)
X	39750	2506.0	-15.55	39.26	23.71	234.96	H
	40620	2593.0	-14.42	38.17	23.75	237.14	
	41490	2680.0	-15.03	38.71	23.68	233.35	
	39750	2506.0	-21.78	39.33	17.55	56.89	V
	40620	2593.0	-21.09	38.68	17.59	57.41	
	41490	2680.0	-21.32	38.76	17.44	55.46	
Channel Bandwidth: 20 MHz / 16QAM							
X	39750	2506.0	-16.55	39.26	22.71	186.64	H
	40620	2593.0	-15.33	38.17	22.84	192.31	
	41490	2680.0	-15.96	38.71	22.75	188.36	
	39750	2506.0	-22.79	39.33	16.54	45.08	V
	40620	2593.0	-22.03	38.68	16.65	46.24	
	41490	2680.0	-22.23	38.76	16.53	44.98	
Channel Bandwidth: 20 MHz / 64QAM							
X	39750	2506.0	-17.58	39.26	21.68	147.23	H
	40620	2593.0	-16.43	38.17	21.74	149.28	
	41490	2680.0	-17.05	38.71	21.66	146.55	
	39750	2506.0	-23.82	39.33	15.51	35.56	V
	40620	2593.0	-23.01	38.68	15.67	36.90	
	41490	2680.0	-23.39	38.76	15.37	34.43	

Note: EIRP (dBm) = Reading (dBm) + Correction Factor (dB)

<POWER CLASS 3>

LTE Band 41							
Channel Bandwidth: 5 MHz / QPSK							
Plane	Channel	Frequency (MHz)	Reading (dBm)	Correction Factor (dB)	EIRP (dBm)	EIRP (mW)	Polarization (H/V)
X	39675	2498.5	-18.04	38.99	20.95	124.45	H
	40620	2593.0	-17.12	38.17	21.05	127.35	
	41565	2687.5	-17.64	38.55	20.91	123.31	
	39675	2498.5	-24.49	39.27	14.78	30.06	V
	40620	2593.0	-23.86	38.68	14.82	30.34	
	41565	2687.5	-23.86	38.55	14.69	29.44	
Channel Bandwidth: 5 MHz / 16QAM							
X	39675	2498.5	-19.06	38.99	19.93	98.40	H
	40620	2593.0	-18.14	38.17	20.03	100.69	
	41565	2687.5	-18.66	38.55	19.89	97.50	
	39675	2498.5	-25.51	39.27	13.76	23.77	V
	40620	2593.0	-24.88	38.68	13.80	23.99	
	41565	2687.5	-24.88	38.55	13.67	23.28	
Channel Bandwidth: 5 MHz / 64QAM							
X	39675	2498.5	-19.98	38.99	19.01	79.62	H
	40620	2593.0	-19.06	38.17	19.11	81.47	
	41565	2687.5	-19.58	38.55	18.97	78.89	
	39675	2498.5	-26.43	39.27	12.84	19.23	V
	40620	2593.0	-25.80	38.68	12.88	19.41	
	41565	2687.5	-25.80	38.55	12.75	18.84	

Note: EIRP (dBm) = Reading (dBm) + Correction Factor (dB)

LTE Band 41							
Channel Bandwidth: 10 MHz / QPSK							
Plane	Channel	Frequency (MHz)	Reading (dBm)	Correction Factor (dB)	EIRP (dBm)	EIRP (mW)	Polarization (H/V)
X	39700	2501.0	-17.72	38.98	21.26	133.66	H
	40620	2593.0	-16.81	38.17	21.36	136.77	
	41540	2685.0	-17.23	38.45	21.22	132.43	
	39700	2501.0	-23.95	39.04	15.09	32.28	V
	40620	2593.0	-23.55	38.68	15.13	32.58	
	41540	2685.0	-23.60	38.60	15.00	31.62	
Channel Bandwidth: 10 MHz / 16QAM							
X	39700	2501.0	-18.79	38.98	20.19	104.47	H
	40620	2593.0	-17.88	38.17	20.29	106.91	
	41540	2685.0	-18.30	38.45	20.15	103.51	
	39700	2501.0	-25.02	39.04	14.02	25.23	V
	40620	2593.0	-24.62	38.68	14.06	25.47	
	41540	2685.0	-24.67	38.60	13.93	24.72	
Channel Bandwidth: 10 MHz / 64QAM							
X	39700	2501.0	-19.71	38.98	19.27	84.53	H
	40620	2593.0	-18.80	38.17	19.37	86.50	
	41540	2685.0	-19.22	38.45	19.23	83.75	
	39700	2501.0	-25.94	39.04	13.10	20.42	V
	40620	2593.0	-25.54	38.68	13.14	20.61	
	41540	2685.0	-25.59	38.60	13.01	20.00	

Note: EIRP (dBm) = Reading (dBm) + Correction Factor (dB)

LTE Band 41							
Channel Bandwidth: 15 MHz / QPSK							
Plane	Channel	Frequency (MHz)	Reading (dBm)	Correction Factor (dB)	EIRP (dBm)	EIRP (mW)	Polarization (H/V)
X	39725	2503.5	-17.60	39.09	21.49	140.93	H
	40620	2593.0	-16.58	38.17	21.59	144.21	
	41515	2682.5	-17.07	38.52	21.45	139.64	
	39725	2503.5	-23.72	39.04	15.32	34.04	V
	40620	2593.0	-23.32	38.68	15.36	34.36	
	41515	2682.5	-23.43	38.66	15.23	33.34	
Channel Bandwidth: 15 MHz / 16QAM							
X	39725	2503.5	-18.59	39.09	20.50	112.20	H
	40620	2593.0	-17.57	38.17	20.60	114.82	
	41515	2682.5	-18.06	38.52	20.46	111.17	
	39725	2503.5	-24.71	39.04	14.33	27.10	V
	40620	2593.0	-24.31	38.68	14.37	27.35	
	41515	2682.5	-24.42	38.66	14.24	26.55	
Channel Bandwidth: 15 MHz / 64QAM							
X	39725	2503.5	-19.57	39.09	19.52	89.54	H
	40620	2593.0	-18.55	38.17	19.62	91.62	
	41515	2682.5	-19.04	38.52	19.48	88.72	
	39725	2503.5	-25.69	39.04	13.35	21.63	V
	40620	2593.0	-25.29	38.68	13.39	21.83	
	41515	2682.5	-25.40	38.66	13.26	21.18	

Note: EIRP (dBm) = Reading (dBm) + Correction Factor (dB)

LTE Band 41							
Channel Bandwidth: 20 MHz / QPSK							
Plane	Channel	Frequency (MHz)	Reading (dBm)	Correction Factor (dB)	EIRP (dBm)	EIRP (mW)	Polarization (H/V)
X	39750	2506.0	-17.51	39.26	21.75	149.62	H
	40620	2593.0	-16.32	38.17	21.85	153.11	
	41490	2680.0	-17.00	38.71	21.71	148.25	
	39750	2506.0	-23.75	39.33	15.58	36.14	V
	40620	2593.0	-23.06	38.68	15.62	36.48	
	41490	2680.0	-23.27	38.76	15.49	35.40	
Channel Bandwidth: 20 MHz / 16QAM							
X	39750	2506.0	-18.50	39.26	20.76	119.12	H
	40620	2593.0	-17.31	38.17	20.86	121.90	
	41490	2680.0	-17.99	38.71	20.72	118.03	
	39750	2506.0	-24.74	39.33	14.59	28.77	V
	40620	2593.0	-24.05	38.68	14.63	29.04	
	41490	2680.0	-24.26	38.76	14.50	28.18	
Channel Bandwidth: 20 MHz / 64QAM							
X	39750	2506.0	-19.51	39.26	19.75	94.41	H
	40620	2593.0	-18.32	38.17	19.85	96.61	
	41490	2680.0	-19.00	38.71	19.71	93.54	
	39750	2506.0	-25.75	39.33	13.58	22.80	V
	40620	2593.0	-25.06	38.68	13.62	23.01	
	41490	2680.0	-25.27	38.76	13.49	22.34	

Note: EIRP (dBm) = Reading (dBm) + Correction Factor (dB)

## 4.2 Modulation Characteristics Measurement

### 4.2.1 Limits of Modulation Characteristics

N/A

### 4.2.2 Test Setup



### 4.2.3 Test Procedure

Connect the EUT to Communication Simulator via the antenna connector. The frequency band is set as EUT supported Modulation and Channels, the EUT output is matched with 50 ohm load, the waveform quality and constellation of the EUT was tested.

### 4.2.4 Test Results

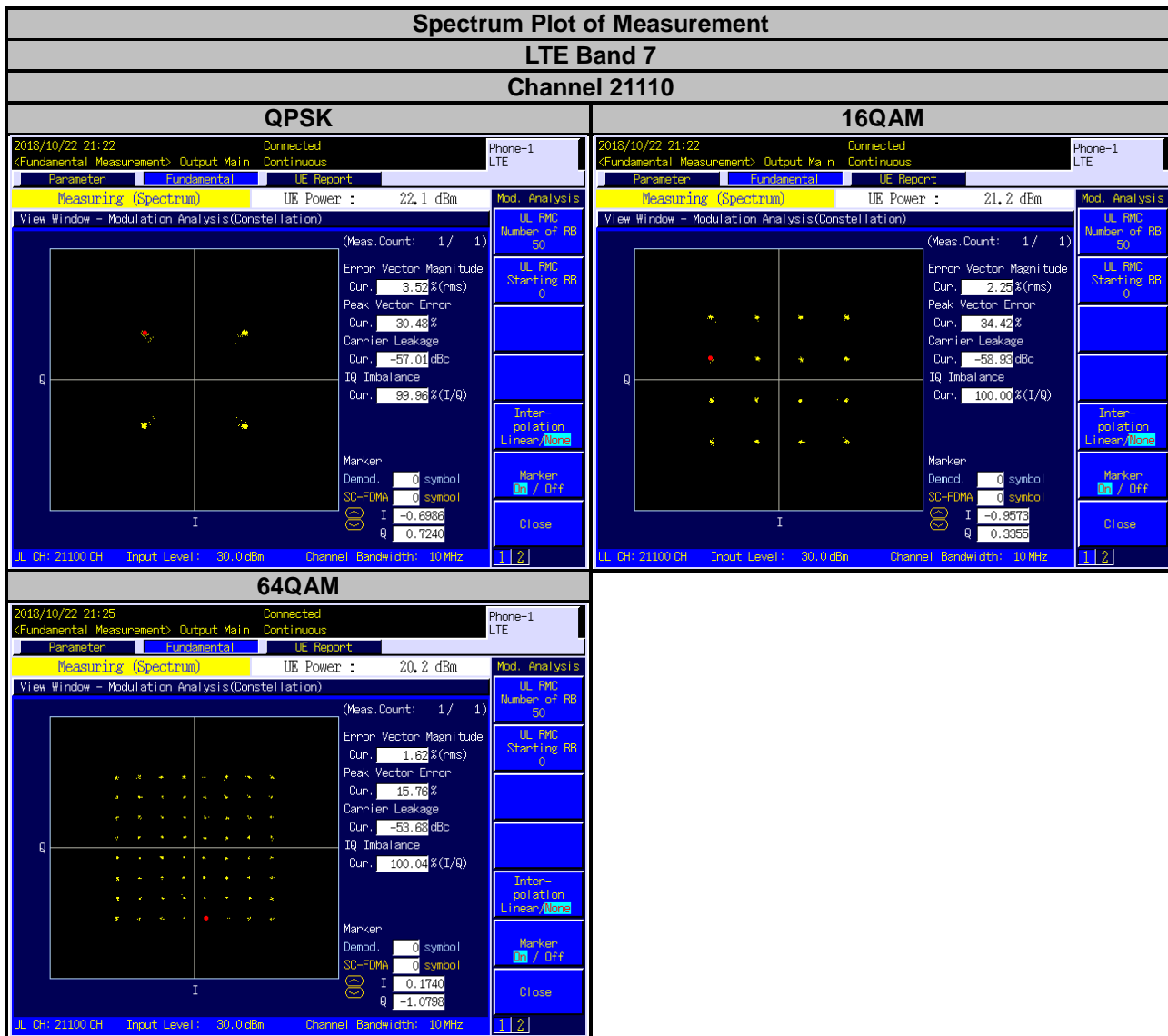

### Spectrum Plot of Measurement

#### LTE Band 38

#### Channel 37850

#### QPSK

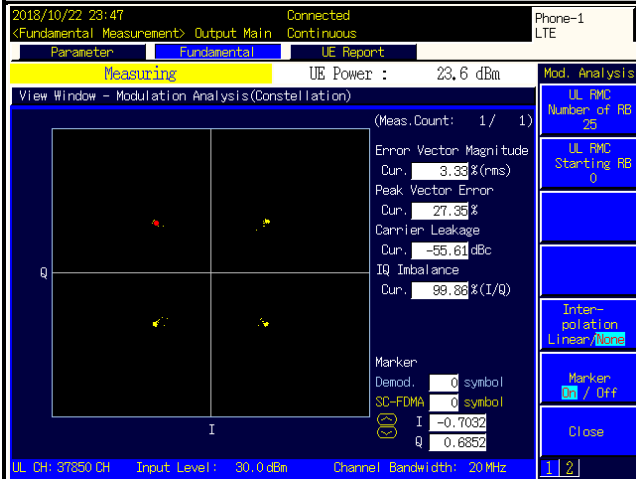

#### 16QAM

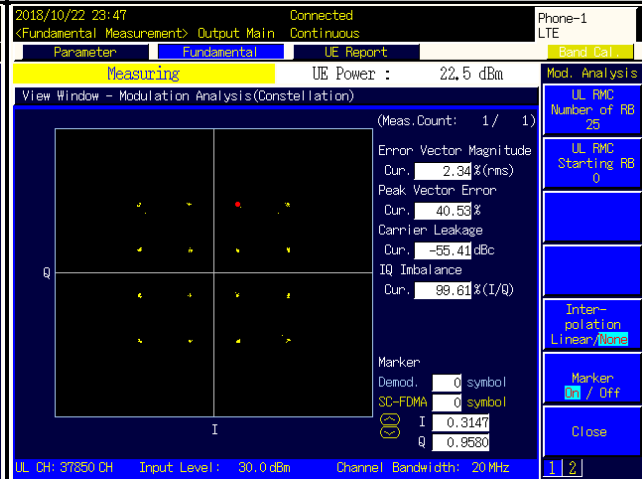

#### 64QAM

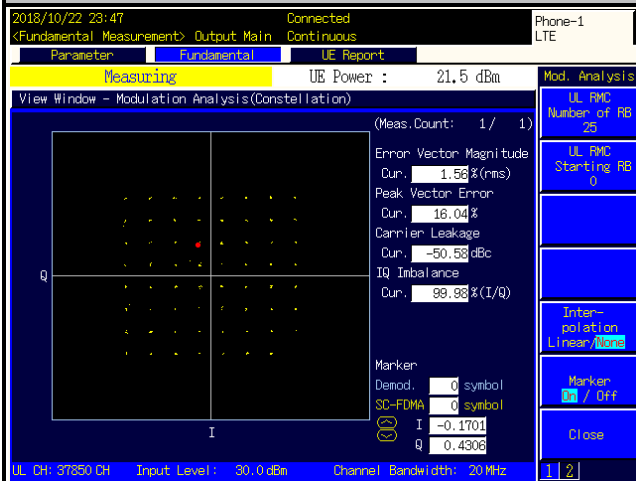



**Spectrum Plot of Measurement**  
**LTE Band 41 (Power Class 2)**  
**Channel 39750**

**QPSK**

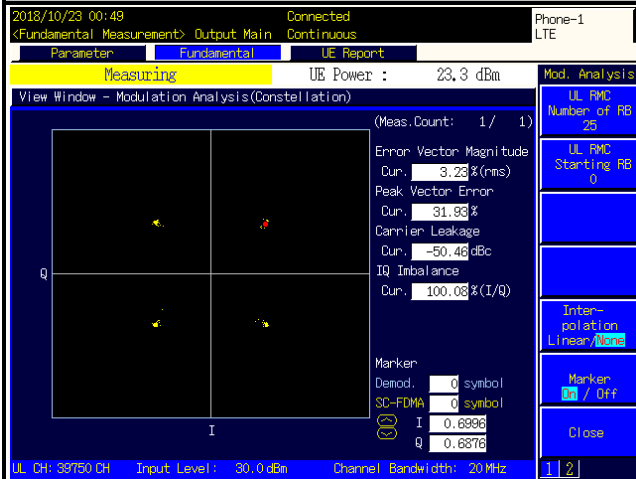

**16QAM**

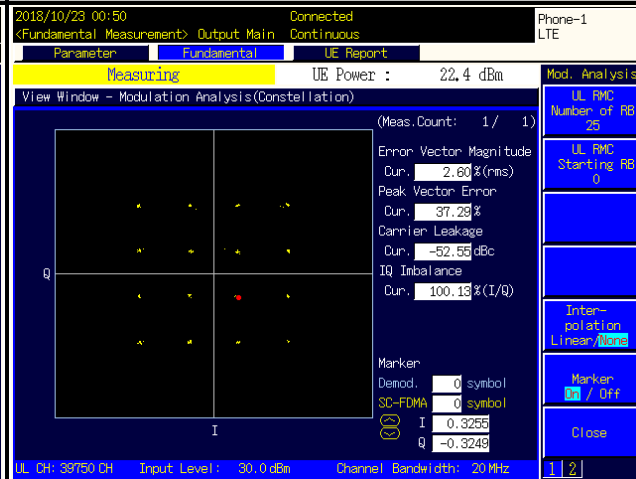

**64QAM**

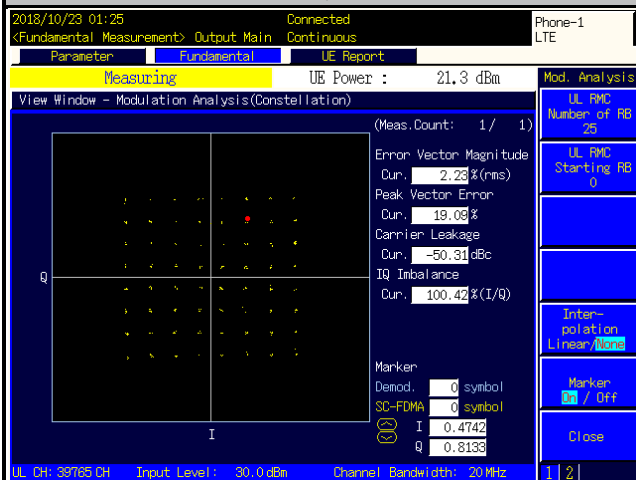

**Spectrum Plot of Measurement**  
**LTE Band 41 (Power Class 3)**  
**Channel 39750**

**QPSK**

**16QAM**

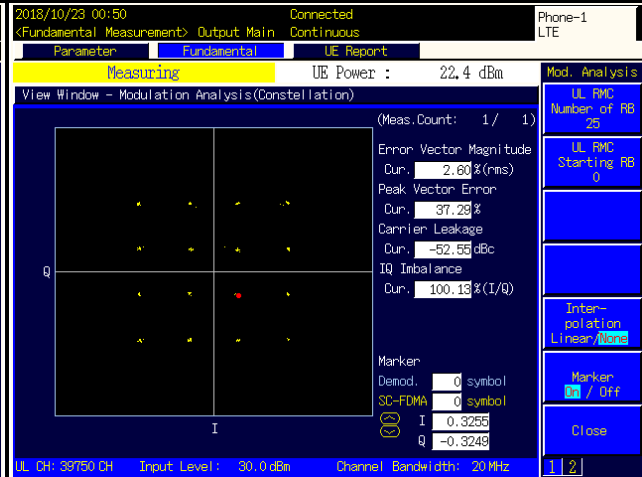
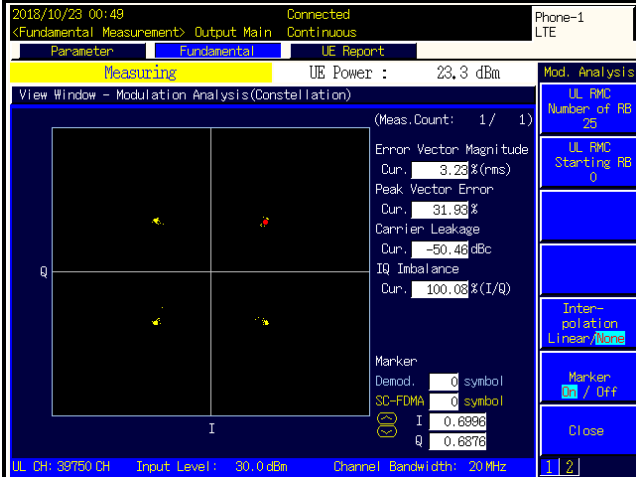

**64QAM**

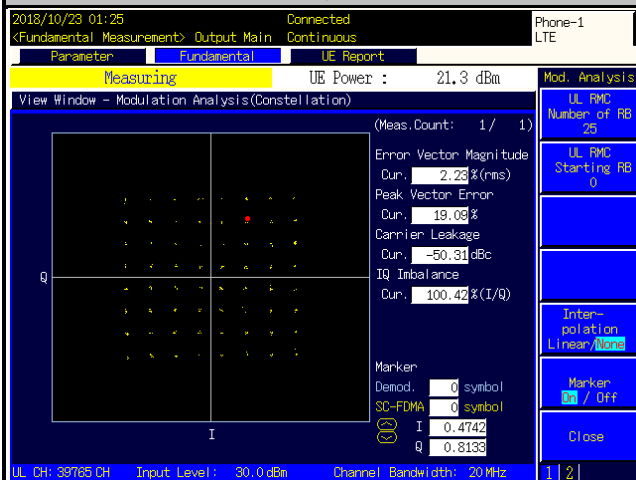

### 4.3 Frequency Stability Measurement

#### 4.3.1 Limits of Frequency Stability Measurement

According to the FCC part 2.1055 shall be tested the frequency stability. The rule is defined that "The frequency stability shall be sufficient to ensure that the fundamental emission stays within the authorized frequency block." The test extreme voltage is according to the 2.1055(d)(1) Vary primary supply voltage from 85 to 115 percent of the nominal value for other than hand carried battery equipment and the extreme temperature rule is comply with specification of EUT  $-30^{\circ}\text{C} \sim 50^{\circ}\text{C}$ .

#### 4.3.2 Test Procedure

- Device is placed at the oven room. The oven room could control the temperatures and humidity. Power warm up is at least 15 min and power applied should perform before recording frequency error.
- EUT is connected the external power supply to control the DC input power. The test voltage range is from minimum to maximum working voltage. Each step shall be record the frequency error rate.
- The temperature range step is 10 degrees in this test items. All temperature levels shall be hold the  $\pm 0.5^{\circ}\text{C}$  during the measurement testing. The each temperature step shall be at least 0.5 hours, consider the EUT could be test under the stability condition.

**NOTE:** The frequency error was recorded frequency error from the communication simulator.

#### 4.3.3 Test Setup

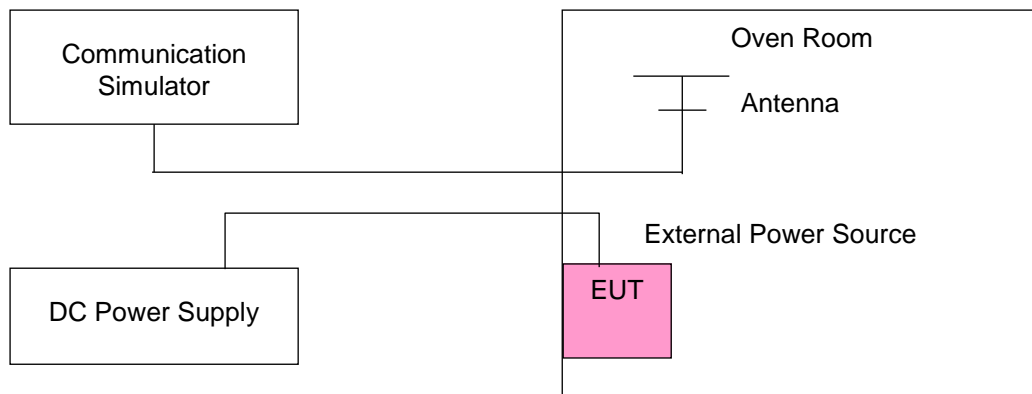

#### 4.3.4 Test Results

##### Frequency Error vs. Voltage

Voltage (Volts)	LTE Band 7			
	Channel Bandwidth: 5 MHz			
	Low Channel		High Channel	
	Frequency (MHz)	Frequency Error (ppm)	Frequency (MHz)	Frequency Error (ppm)
3.85	2502.500004	0.0015	2567.500001	0.0004
3.6	2502.500003	0.0011	2567.500003	0.0013
4.4	2502.500003	0.0010	2567.500002	0.0007

**Note:** The applicant defined the normal working voltage of the battery is from 3.6 Vdc to 4.4 Vdc.

##### Frequency Error vs. Temperature

Temp. (°C)	LTE Band 7			
	Channel Bandwidth: 5 MHz			
	Low Channel		High Channel	
	Frequency (MHz)	Frequency Error (ppm)	Frequency (MHz)	Frequency Error (ppm)
-30	2502.500002	0.0007	2567.500001	0.0004
-20	2502.500004	0.0015	2567.500003	0.0010
-10	2502.500004	0.0014	2567.500001	0.0005
0	2502.500002	0.0010	2567.500003	0.0010
10	2502.500003	0.0013	2567.500002	0.0007
20	2502.499997	-0.0013	2567.499999	-0.0005
30	2502.499997	-0.0012	2567.499998	-0.0008
40	2502.499997	-0.0011	2567.499997	-0.0012
50	2502.499997	-0.0014	2567.499998	-0.0007
55	2502.499997	-0.0012	2567.499996	-0.0014

Frequency Error vs. Voltage

Voltage (Volts)	LTE Band 7			
	Channel Bandwidth: 10 MHz			
	Low Channel		High Channel	
	Frequency (MHz)	Frequency Error (ppm)	Frequency (MHz)	Frequency Error (ppm)
3.85	2505.000003	0.0012	2565.000003	0.0012
3.6	2505.000001	0.0005	2565.000001	0.0005
4.4	2505.000004	0.0016	2565.000001	0.0004

**Note:** The applicant defined the normal working voltage of the battery is from 3.6 Vdc to 4.4 Vdc.

Frequency Error vs. Temperature

Temp. (°C)	LTE Band 7			
	Channel Bandwidth: 10 MHz			
	Low Channel		High Channel	
	Frequency (MHz)	Frequency Error (ppm)	Frequency (MHz)	Frequency Error (ppm)
-30	2505.000001	0.0005	2565.000003	0.0013
-20	2505.000004	0.0016	2565.000004	0.0015
-10	2505.000004	0.0016	2565.000001	0.0004
0	2505.000002	0.0009	2565.000003	0.0012
10	2505.000004	0.0015	2565.000002	0.0009
20	2504.999996	-0.0015	2564.999998	-0.0007
30	2504.999999	-0.0006	2564.999999	-0.0005
40	2504.999997	-0.0011	2564.999999	-0.0005
50	2504.999997	-0.0010	2564.999999	-0.0005
55	2504.999997	-0.0012	2564.999998	-0.0009

## Frequency Error vs. Voltage

Voltage (Volts)	LTE Band 7			
	Channel Bandwidth: 15 MHz			
	Low Channel		High Channel	
	Frequency (MHz)	Frequency Error (ppm)	Frequency (MHz)	Frequency Error (ppm)
3.85	2507.500004	0.0015	2562.500003	0.0012
3.6	2507.500003	0.0011	2562.500003	0.0011
4.4	2507.500003	0.0012	2562.500002	0.0006

**Note:** The applicant defined the normal working voltage of the battery is from 3.6 Vdc to 4.4 Vdc.

## Frequency Error vs. Temperature

Temp. (°C)	LTE Band 7			
	Channel Bandwidth: 15 MHz			
	Low Channel		High Channel	
	Frequency (MHz)	Frequency Error (ppm)	Frequency (MHz)	Frequency Error (ppm)
-30	2507.500004	0.0016	2562.500004	0.0014
-20	2507.500002	0.0010	2562.500004	0.0016
-10	2507.500001	0.0004	2562.500002	0.0006
0	2507.500003	0.0013	2562.500002	0.0009
10	2507.500001	0.0004	2562.500003	0.0012
20	2507.499996	-0.0015	2562.499999	-0.0004
30	2507.499997	-0.0010	2562.499997	-0.0012
40	2507.499996	-0.0015	2562.499997	-0.0012
50	2507.499996	-0.0015	2562.499997	-0.0012
55	2507.499998	-0.0008	2562.499998	-0.0007

Frequency Error vs. Voltage

Voltage (Volts)	LTE Band 7			
	Channel Bandwidth: 20 MHz			
	Low Channel		High Channel	
	Frequency (MHz)	Frequency Error (ppm)	Frequency (MHz)	Frequency Error (ppm)
3.85	2510.000002	0.0008	2560.000003	0.0013
3.6	2510.000002	0.0006	2560.000004	0.0015
4.4	2510.000002	0.0006	2560.000002	0.0006

**Note:** The applicant defined the normal working voltage of the battery is from 3.6 Vdc to 4.4 Vdc.

Frequency Error vs. Temperature

Temp. (°C)	LTE Band 7			
	Channel Bandwidth: 20 MHz			
	Low Channel		High Channel	
	Frequency (MHz)	Frequency Error (ppm)	Frequency (MHz)	Frequency Error (ppm)
-30	2510.000002	0.0006	2560.000003	0.0010
-20	2510.000002	0.0008	2560.000004	0.0014
-10	2510.000004	0.0015	2560.000002	0.0009
0	2510.000001	0.0005	2560.000003	0.0010
10	2510.000001	0.0004	2560.000004	0.0014
20	2509.999998	-0.0010	2559.999999	-0.0005
30	2509.999999	-0.0006	2559.999996	-0.0015
40	2509.999998	-0.0008	2559.999997	-0.0012
50	2509.999997	-0.0010	2559.999998	-0.0009
55	2509.999997	-0.0012	2559.999997	-0.0013

## Frequency Error vs. Voltage

Voltage (Volts)	LTE Band 38			
	Channel Bandwidth: 5 MHz			
	Low Channel		High Channel	
	Frequency (MHz)	Frequency Error (ppm)	Frequency (MHz)	Frequency Error (ppm)
3.85	2572.500003	0.0013	2617.500002	0.0007
3.6	2572.500001	0.0004	2617.500004	0.0015
4.4	2572.500004	0.0015	2617.500004	0.0015

**Note:** The applicant defined the normal working voltage of the battery is from 3.6 Vdc to 4.4 Vdc.

## Frequency Error vs. Temperature

Temp. (°C)	LTE Band 38			
	Channel Bandwidth: 5 MHz			
	Low Channel		High Channel	
	Frequency (MHz)	Frequency Error (ppm)	Frequency (MHz)	Frequency Error (ppm)
-30	2572.500002	0.0007	2617.500001	0.0004
-20	2572.500002	0.0009	2617.500003	0.0011
-10	2572.500003	0.0011	2617.500003	0.0011
0	2572.500001	0.0004	2617.500002	0.0006
10	2572.500003	0.0010	2617.500003	0.0011
20	2572.499996	-0.0014	2617.499999	-0.0005
30	2572.499997	-0.0011	2617.499998	-0.0006
40	2572.499999	-0.0004	2617.499998	-0.0008
50	2572.499998	-0.0007	2617.499999	-0.0005
55	2572.499999	-0.0005	2617.499997	-0.0011



## Frequency Error vs. Voltage

Voltage (Volts)	LTE Band 38			
	Channel Bandwidth: 10 MHz			
	Low Channel		High Channel	
	Frequency (MHz)	Frequency Error (ppm)	Frequency (MHz)	Frequency Error (ppm)
3.85	2575.000003	0.0010	2615.000002	0.0006
3.6	2575.000001	0.0005	2615.000002	0.0007
4.4	2575.000003	0.0011	2615.000003	0.0013

**Note:** The applicant defined the normal working voltage of the battery is from 3.6 Vdc to 4.4 Vdc.

## Frequency Error vs. Temperature

Temp. (°C)	LTE Band 38			
	Channel Bandwidth: 10 MHz			
	Low Channel		High Channel	
	Frequency (MHz)	Frequency Error (ppm)	Frequency (MHz)	Frequency Error (ppm)
-30	2575.000003	0.0011	2615.000001	0.0004
-20	2575.000003	0.0010	2615.000001	0.0005
-10	2575.000001	0.0005	2615.000002	0.0007
0	2575.000003	0.0012	2615.000002	0.0007
10	2575.000004	0.0015	2615.000003	0.0011
20	2574.999998	-0.0010	2614.999999	-0.0005
30	2574.999998	-0.0009	2614.999998	-0.0010
40	2574.999997	-0.0010	2614.999997	-0.0010
50	2574.999996	-0.0016	2614.999998	-0.0009
55	2574.999997	-0.0011	2614.999999	-0.0005

## Frequency Error vs. Voltage

Voltage (Volts)	LTE Band 38			
	Channel Bandwidth: 15 MHz			
	Low Channel		High Channel	
	Frequency (MHz)	Frequency Error (ppm)	Frequency (MHz)	Frequency Error (ppm)
3.85	2577.500003	0.0012	2612.500003	0.0012
3.6	2577.500003	0.0011	2612.500002	0.0007
4.4	2577.500003	0.0010	2612.500002	0.0009

**Note:** The applicant defined the normal working voltage of the battery is from 3.6 Vdc to 4.4 Vdc.

## Frequency Error vs. Temperature

Temp. (°C)	LTE Band 38			
	Channel Bandwidth: 15 MHz			
	Low Channel		High Channel	
	Frequency (MHz)	Frequency Error (ppm)	Frequency (MHz)	Frequency Error (ppm)
-30	2577.500001	0.0005	2612.500003	0.0010
-20	2577.500003	0.0013	2612.500003	0.0013
-10	2577.500003	0.0013	2612.500002	0.0006
0	2577.500002	0.0006	2612.500002	0.0006
10	2577.500002	0.0006	2612.500004	0.0015
20	2577.499998	-0.0008	2612.499997	-0.0013
30	2577.499998	-0.0007	2612.499998	-0.0010
40	2577.499998	-0.0010	2612.499997	-0.0013
50	2577.499997	-0.0012	2612.499999	-0.0005
55	2577.499998	-0.0009	2612.499997	-0.0012

Frequency Error vs. Voltage

Voltage (Volts)	LTE Band 38			
	Channel Bandwidth: 20 MHz			
	Low Channel		High Channel	
	Frequency (MHz)	Frequency Error (ppm)	Frequency (MHz)	Frequency Error (ppm)
3.85	2580.000004	0.0015	2610.000002	0.0006
3.6	2580.000003	0.0012	2610.000001	0.0005
4.4	2580.000004	0.0014	2610.000000	0.0007

**Note:** The applicant defined the normal working voltage of the battery is from 3.6 Vdc to 4.4 Vdc.

Frequency Error vs. Temperature

Temp. (°C)	LTE Band 38			
	Channel Bandwidth: 20 MHz			
	Low Channel		High Channel	
	Frequency (MHz)	Frequency Error (ppm)	Frequency (MHz)	Frequency Error (ppm)
-30	2580.000002	0.0006	2610.000003	0.0010
-20	2580.000001	0.0005	2610.000001	0.0004
-10	2580.000004	0.0016	2610.000002	0.0007
0	2580.000002	0.0006	2610.000002	0.0008
10	2580.000001	0.0005	2610.000003	0.0011
20	2579.999996	-0.0015	2609.999998	-0.0010
30	2579.999997	-0.0013	2609.999998	-0.0009
40	2579.999999	-0.0005	2609.999997	-0.0012
50	2579.999999	-0.0005	2609.999999	-0.0006
55	2579.999997	-0.0012	2609.999999	-0.0005

<Power Class 2>

Frequency Error vs. Voltage

Voltage (Volts)	LTE Band 41			
	Channel Bandwidth: 5 MHz			
	Low Channel		High Channel	
	Frequency (MHz)	Frequency Error (ppm)	Frequency (MHz)	Frequency Error (ppm)
3.85	2498.500003	0.0011	2687.500001	0.0004
3.6	2498.500004	0.0014	2687.500002	0.0009
4.4	2498.500003	0.0010	2687.500001	0.0005

**Note:** The applicant defined the normal working voltage of the battery is from 3.6 Vdc to 4.4 Vdc.

Frequency Error vs. Temperature

Temp. (°C)	LTE Band 41			
	Channel Bandwidth: 5 MHz			
	Low Channel		High Channel	
	Frequency (MHz)	Frequency Error (ppm)	Frequency (MHz)	Frequency Error (ppm)
-30	2498.500003	0.0013	2687.500002	0.0009
-20	2498.500003	0.0012	2687.500001	0.0005
-10	2498.500002	0.0006	2687.500004	0.0013
0	2498.500003	0.0012	2687.500002	0.0006
10	2498.500003	0.0011	2687.500002	0.0009
20	2498.499999	-0.0004	2687.499996	-0.0013
30	2498.499998	-0.0007	2687.499998	-0.0007
40	2498.499999	-0.0005	2687.499998	-0.0007
50	2498.499998	-0.0008	2687.499996	-0.0014
55	2498.499997	-0.0012	2687.499999	-0.0005

Frequency Error vs. Voltage

Voltage (Volts)	LTE Band 41			
	Channel Bandwidth: 10 MHz			
	Low Channel		High Channel	
	Frequency (MHz)	Frequency Error (ppm)	Frequency (MHz)	Frequency Error (ppm)
3.85	2501.000002	0.0006	2685.000003	0.0010
3.6	2501.000001	0.0005	2685.000003	0.0010
4.4	2501.000003	0.0010	2685.000003	0.0010

**Note:** The applicant defined the normal working voltage of the battery is from 3.6 Vdc to 4.4 Vdc.

Frequency Error vs. Temperature

Temp. (°C)	LTE Band 41			
	Channel Bandwidth: 10 MHz			
	Low Channel		High Channel	
	Frequency (MHz)	Frequency Error (ppm)	Frequency (MHz)	Frequency Error (ppm)
-30	2501.000002	0.0006	2685.000001	0.0005
-20	2501.000001	0.0005	2685.000002	0.0008
-10	2501.000003	0.0010	2685.000004	0.0013
0	2501.000002	0.0008	2685.000004	0.0014
10	2501.000004	0.0015	2685.000002	0.0009
20	2500.999997	-0.0012	2684.999997	-0.0013
30	2500.999999	-0.0006	2684.999999	-0.0006
40	2500.999999	-0.0006	2684.999998	-0.0008
50	2500.999997	-0.0014	2684.999998	-0.0007
55	2500.999997	-0.0013	2684.999997	-0.0012

Frequency Error vs. Voltage

Voltage (Volts)	LTE Band 41			
	Channel Bandwidth: 15 MHz			
	Low Channel		High Channel	
	Frequency (MHz)	Frequency Error (ppm)	Frequency (MHz)	Frequency Error (ppm)
3.85	2503.500002	0.0006	2682.500003	0.0010
3.6	2503.500004	0.0014	2682.500004	0.0015
4.4	2503.500003	0.0013	2682.500003	0.0009

**Note:** The applicant defined the normal working voltage of the battery is from 3.6 Vdc to 4.4 Vdc.

Frequency Error vs. Temperature

Temp. (°C)	LTE Band 41			
	Channel Bandwidth: 15 MHz			
	Low Channel		High Channel	
	Frequency (MHz)	Frequency Error (ppm)	Frequency (MHz)	Frequency Error (ppm)
-30	2503.500002	0.0009	2682.500002	0.0009
-20	2503.500004	0.0016	2682.500004	0.0014
-10	2503.500001	0.0004	2682.500002	0.0007
0	2503.500002	0.0008	2682.500001	0.0004
10	2503.500004	0.0016	2682.500003	0.0010
20	2503.499999	-0.0004	2682.499996	-0.0014
30	2503.499997	-0.0013	2682.499996	-0.0014
40	2503.499999	-0.0005	2682.499999	-0.0005
50	2503.499999	-0.0006	2682.499997	-0.0012
55	2503.499999	-0.0005	2682.499997	-0.0010

Frequency Error vs. Voltage

Voltage (Volts)	LTE Band 41			
	Channel Bandwidth: 20 MHz			
	Low Channel		High Channel	
	Frequency (MHz)	Frequency Error (ppm)	Frequency (MHz)	Frequency Error (ppm)
3.85	2506.000002	0.0009	2680.000003	0.0009
3.6	2506.000004	0.0014	2680.000004	0.0014
4.4	2506.000003	0.0010	2680.000003	0.0010

**Note:** The applicant defined the normal working voltage of the battery is from 3.6 Vdc to 4.4 Vdc.

Frequency Error vs. Temperature

Temp. (°C)	LTE Band 41			
	Channel Bandwidth: 20 MHz			
	Low Channel		High Channel	
	Frequency (MHz)	Frequency Error (ppm)	Frequency (MHz)	Frequency Error (ppm)
-30	2506.000002	0.0008	2680.000004	0.0015
-20	2506.000003	0.0014	2680.000002	0.0008
-10	2506.000001	0.0005	2680.000002	0.0009
0	2506.000003	0.0014	2680.000001	0.0004
10	2506.000003	0.0012	2680.000004	0.0013
20	2505.999997	-0.0010	2679.999997	-0.0011
30	2505.999996	-0.0016	2679.999998	-0.0007
40	2505.999997	-0.0010	2679.999999	-0.0004
50	2505.999997	-0.0012	2679.999998	-0.0006
55	2505.999999	-0.0005	2679.999996	-0.0014

### <Power Class 3>

#### Frequency Error vs. Voltage

Voltage (Volts)	LTE Band 41			
	Channel Bandwidth: 5 MHz			
	Low Channel		High Channel	
	Frequency (MHz)	Frequency Error (ppm)	Frequency (MHz)	Frequency Error (ppm)
3.85	2498.500003	0.0013	2687.500004	0.0013
3.6	2498.500001	0.0006	2687.500002	0.0006
4.4	2498.500002	0.0009	2687.500003	0.0011

**Note:** The applicant defined the normal working voltage of the battery is from 3.6 Vdc to 4.4 Vdc.

#### Frequency Error vs. Temperature

Temp. (°C)	LTE Band 41			
	Channel Bandwidth: 5 MHz			
	Low Channel		High Channel	
	Frequency (MHz)	Frequency Error (ppm)	Frequency (MHz)	Frequency Error (ppm)
-30	2498.500004	0.0015	2687.500003	0.0012
-20	2498.500003	0.0013	2687.500002	0.0009
-10	2498.500002	0.0007	2687.500003	0.0012
0	2498.500003	0.0012	2687.500003	0.0012
10	2498.500002	0.0006	2687.500003	0.0010
20	2498.499996	-0.0016	2687.499998	-0.0006
30	2498.499999	-0.0005	2687.499999	-0.0005
40	2498.499997	-0.0011	2687.499997	-0.0011
50	2498.499998	-0.0008	2687.499996	-0.0015
55	2498.499996	-0.0015	2687.499996	-0.0014



Frequency Error vs. Voltage

Voltage (Volts)	LTE Band 41			
	Channel Bandwidth: 10 MHz			
	Low Channel		High Channel	
	Frequency (MHz)	Frequency Error (ppm)	Frequency (MHz)	Frequency Error (ppm)
3.85	2501.000003	0.0012	2685.000002	0.0008
3.6	2501.000001	0.0005	2685.000001	0.0005
4.4	2501.000001	0.0004	2685.000004	0.0015

**Note:** The applicant defined the normal working voltage of the battery is from 3.6 Vdc to 4.4 Vdc.

Frequency Error vs. Temperature

Temp. (°C)	LTE Band 41			
	Channel Bandwidth: 10 MHz			
	Low Channel		High Channel	
	Frequency (MHz)	Frequency Error (ppm)	Frequency (MHz)	Frequency Error (ppm)
-30	2501.000003	0.0013	2685.000003	0.0011
-20	2501.000002	0.0009	2685.000001	0.0005
-10	2501.000003	0.0012	2685.000001	0.0004
0	2501.000002	0.0006	2685.000003	0.0010
10	2501.000002	0.0008	2685.000001	0.0004
20	2500.999998	-0.0008	2684.999996	-0.0014
30	2500.999999	-0.0006	2684.999996	-0.0015
40	2500.999996	-0.0016	2684.999997	-0.0010
50	2500.999999	-0.0004	2684.999998	-0.0009
55	2500.999997	-0.0010	2684.999999	-0.0005

## Frequency Error vs. Voltage

Voltage (Volts)	LTE Band 41			
	Channel Bandwidth: 15 MHz			
	Low Channel		High Channel	
	Frequency (MHz)	Frequency Error (ppm)	Frequency (MHz)	Frequency Error (ppm)
3.85	2503.500004	0.0015	2682.500003	0.0012
3.6	2503.500002	0.0008	2682.500004	0.0013
4.4	2503.500001	0.0004	2682.500001	0.0004

**Note:** The applicant defined the normal working voltage of the battery is from 3.6 Vdc to 4.4 Vdc.

## Frequency Error vs. Temperature

Temp. (°C)	LTE Band 41			
	Channel Bandwidth: 15 MHz			
	Low Channel		High Channel	
	Frequency (MHz)	Frequency Error (ppm)	Frequency (MHz)	Frequency Error (ppm)
-30	2503.500003	0.0010	2682.500004	0.0013
-20	2503.500002	0.0006	2682.500003	0.0012
-10	2503.500002	0.0007	2682.500003	0.0012
0	2503.500004	0.0015	2682.500003	0.0011
10	2503.500003	0.0013	2682.500002	0.0009
20	2503.499997	-0.0012	2682.499997	-0.0011
30	2503.499999	-0.0006	2682.499998	-0.0007
40	2503.499997	-0.0011	2682.499998	-0.0006
50	2503.499997	-0.0012	2682.499996	-0.0014
55	2503.499998	-0.0007	2682.499998	-0.0006

## Frequency Error vs. Voltage

Voltage (Volts)	LTE Band 41			
	Channel Bandwidth: 20 MHz			
	Low Channel		High Channel	
	Frequency (MHz)	Frequency Error (ppm)	Frequency (MHz)	Frequency Error (ppm)
3.85	2506.000004	0.002	2680.000002	0.0009
3.6	2506.000002	0.001	2680.000001	0.0004
4.4	2506.000003	0.001	2680.000002	0.0006

**Note:** The applicant defined the normal working voltage of the battery is from 3.6 Vdc to 4.4 Vdc.

## Frequency Error vs. Temperature

Temp. (°C)	LTE Band 41			
	Channel Bandwidth: 20 MHz			
	Low Channel		High Channel	
	Frequency (MHz)	Frequency Error (ppm)	Frequency (MHz)	Frequency Error (ppm)
-30	2506.000002	0.001	2680.000003	0.0011
-20	2506.000002	0.001	2680.000003	0.0010
-10	2506.000002	0.001	2680.000004	0.0015
0	2506.000003	0.001	2680.000002	0.0006
10	2506.000003	0.001	2680.000002	0.0006
20	2505.999996	-0.002	2679.999999	-0.0006
30	2505.999997	-0.001	2679.999996	-0.0013
40	2505.999997	-0.001	2679.999997	-0.0012
50	2505.999997	-0.001	2679.999997	-0.0011
55	2505.999998	-0.001	2679.999998	-0.0008

#### 4.4 Occupied Bandwidth Measurement

##### 4.4.1 Limits of Occupied Bandwidth Measurement

The width of a frequency band such that, below the lower and above the upper frequency limits, the mean powers emitted are each equal to a specified percentage 0.5 % of the total mean power of a given emission.

##### 4.4.2 Test Procedure

- The conducted occupied bandwidth used the power splitter via EUT RF power connector between simulation base station and spectrum analyzer.
- Use OBW measurement function of Spectrum analyzer to measure 99 % occupied bandwidth.

##### 4.4.3 Test Setup

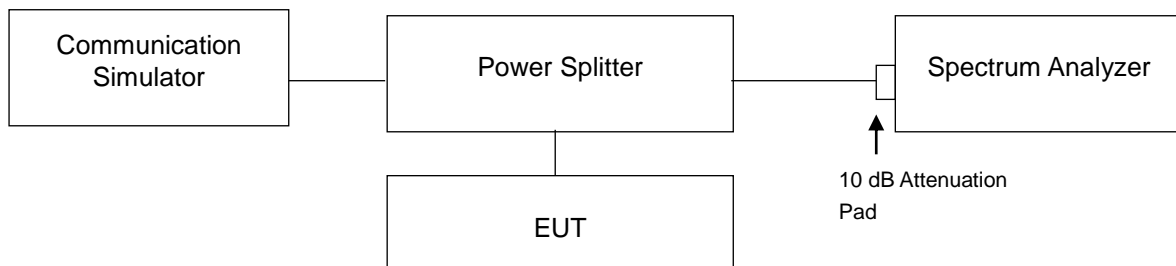

#### 4.4.4 Test Results

#### <99 % Occupied Bandwidth>

LTE Band 7									
Channel Bandwidth: 5 MHz					Channel Bandwidth: 10 MHz				
Channel	Frequency (MHz)	99 % Occupied Bandwidth (MHz)			Channel	Frequency (MHz)	99 % Occupied Bandwidth (MHz)		
		QPSK	16QAM	64QAM			QPSK	16QAM	64QAM
20775	2502.5	4.4890	4.4938	4.5005	20800	2505.0	8.9615	8.9677	8.9627
21100	2535.0	4.4880	4.4923	4.5023	21100	2535.0	8.9653	8.9658	8.9743
21425	2567.5	4.4905	4.4951	4.5007	21400	2565.0	8.9701	8.9717	8.9775

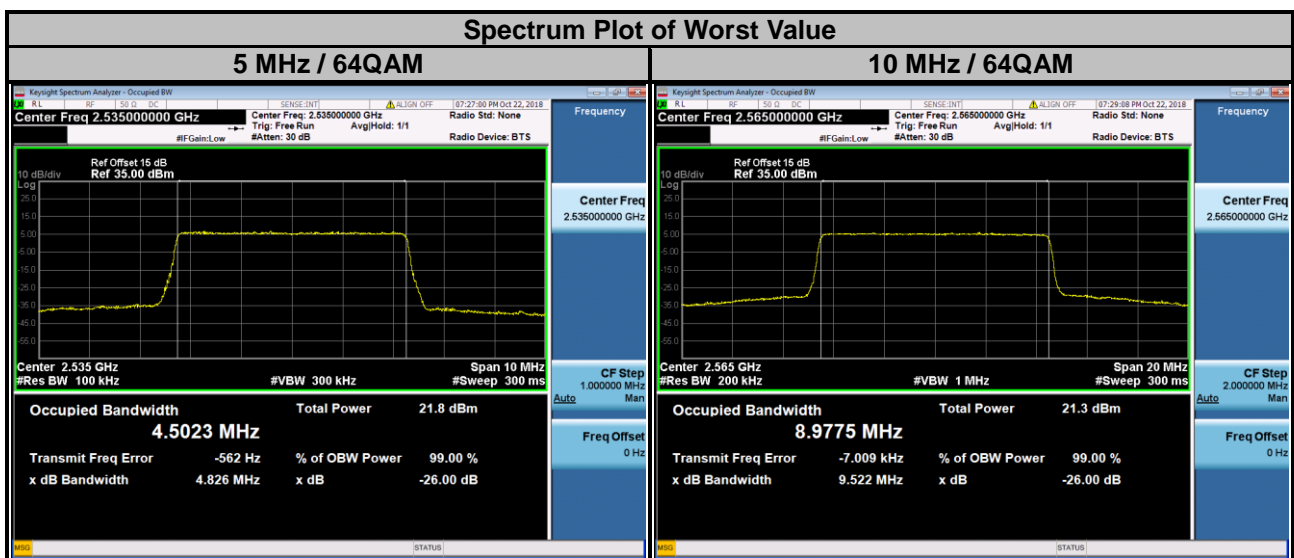

### LTE Band 7

Channel Bandwidth: 15 MHz					Channel Bandwidth: 20 MHz				
Channel	Frequency (MHz)	99 % Occupied Bandwidth (MHz)			Channel	Frequency (MHz)	99 % Occupied Bandwidth (MHz)		
		QPSK	16QAM	64QAM			QPSK	16QAM	64QAM
20825	2507.5	13.447	13.431	13.429	20850	2510.0	17.912	17.936	17.926
21100	2535.0	13.444	13.431	13.428	21100	2535.0	17.906	17.923	17.919
21375	2562.5	13.453	13.441	13.437	21350	2560.0	17.914	17.941	17.930

### Spectrum Plot of Worst Value



LTE Band 38									
Channel Bandwidth: 5 MHz					Channel Bandwidth: 10 MHz				
Channel	Frequency (MHz)	99 % Occupied Bandwidth (MHz)			Channel	Frequency (MHz)	99 % Occupied Bandwidth (MHz)		
		QPSK	16QAM	64QAM			QPSK	16QAM	64QAM
37775	2572.5	4.4914	4.4915	4.5021	37800	2575.0	8.9581	8.9734	8.9629
38000	2595.0	4.4908	4.4910	4.5025	38000	2595.0	8.9533	8.9603	8.9654
38225	2617.5	4.4917	4.4917	4.4987	38200	2615.0	8.9578	8.9665	8.9666

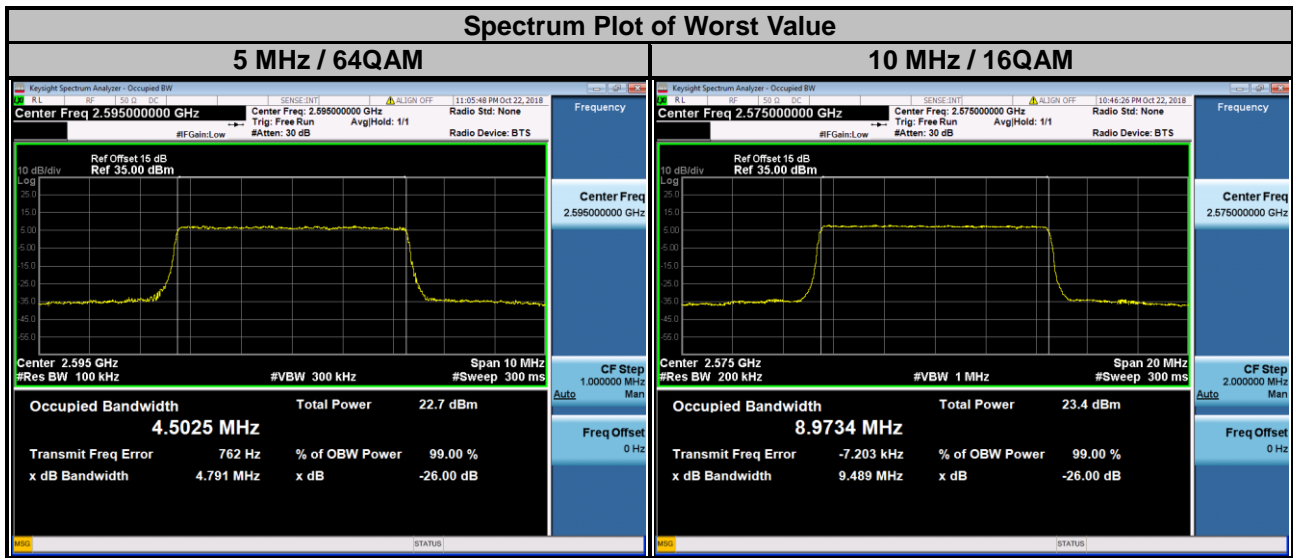

### LTE Band 38

Channel Bandwidth: 15 MHz					Channel Bandwidth: 20 MHz				
Channel	Frequency (MHz)	99 % Occupied Bandwidth (MHz)			Channel	Frequency (MHz)	99 % Occupied Bandwidth (MHz)		
		QPSK	16QAM	64QAM			QPSK	16QAM	64QAM
37825	2577.5	13.446	13.437	13.440	37850	2580.0	17.914	17.919	17.921
38000	2595.0	13.449	13.440	13.433	38000	2595.0	17.908	17.916	17.921
38175	2612.5	13.445	13.435	13.441	38150	2610.0	17.912	17.913	17.927

### Spectrum Plot of Worst Value

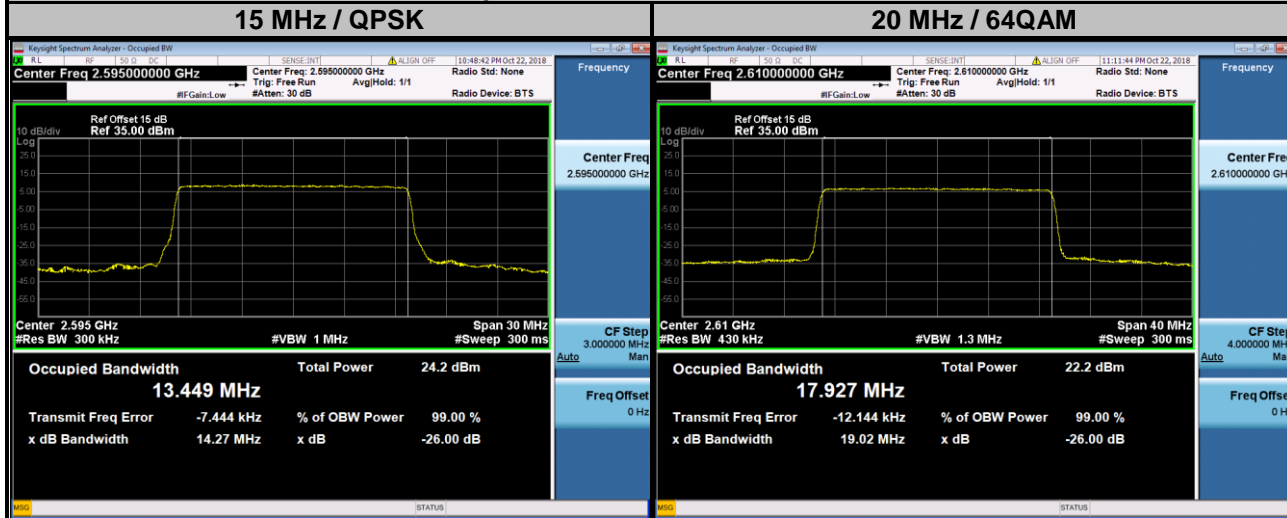



### LTE Band 41 (Power Class 2)

Channel Bandwidth: 5 MHz					Channel Bandwidth: 10 MHz				
Channel	Frequency (MHz)	99 % Occupied Bandwidth (MHz)			Channel	Frequency (MHz)	99 % Occupied Bandwidth (MHz)		
		QPSK	16QAM	64QAM			QPSK	16QAM	64QAM
39675	2498.5	4.4946	4.4918	4.5017	39700	2501.0	8.9491	8.9640	8.9662
40620	2593.0	4.4921	4.4905	4.4989	40620	2593.0	8.9525	8.9603	8.9614
41565	2687.5	4.4939	4.4907	4.4996	41540	2685.0	8.9548	8.9662	8.9625

### Spectrum Plot of Worst Value

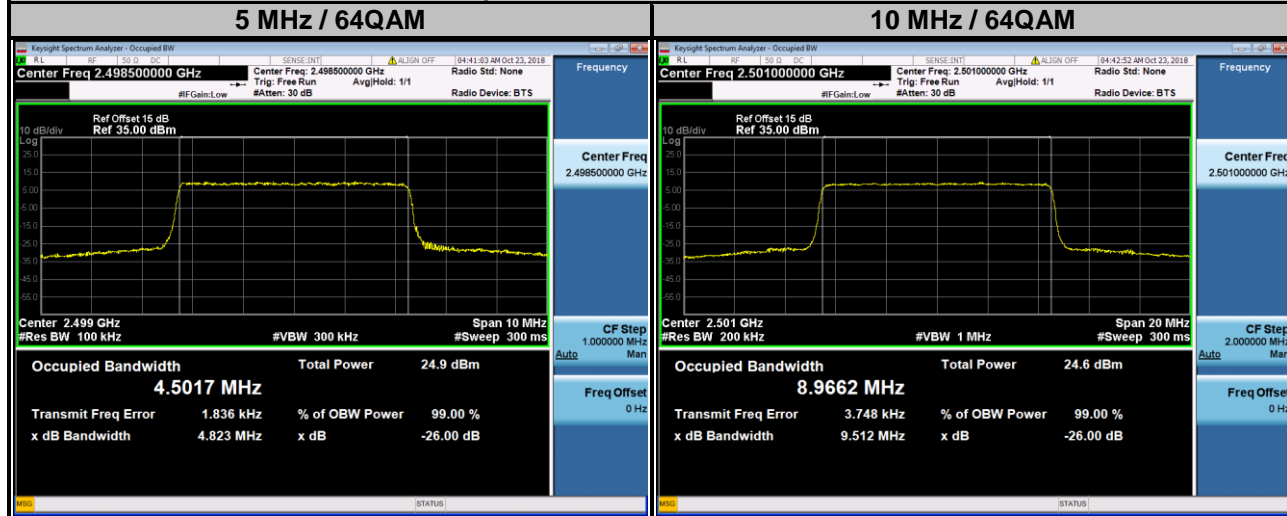

### LTE Band 41 (Power Class 2)

Channel Bandwidth: 15 MHz					Channel Bandwidth: 20 MHz				
Channel	Frequency (MHz)	99 % Occupied Bandwidth (MHz)			Channel	Frequency (MHz)	99 % Occupied Bandwidth (MHz)		
		QPSK	16QAM	64QAM			QPSK	16QAM	64QAM
39725	2503.5	13.437	13.420	13.432	39750	2506.0	17.902	17.898	17.917
40620	2593.0	13.443	13.426	13.440	40620	2593.0	17.906	17.901	17.917
41515	2682.5	13.437	13.426	13.434	41490	2680.0	17.865	17.859	17.877

### Spectrum Plot of Worst Value

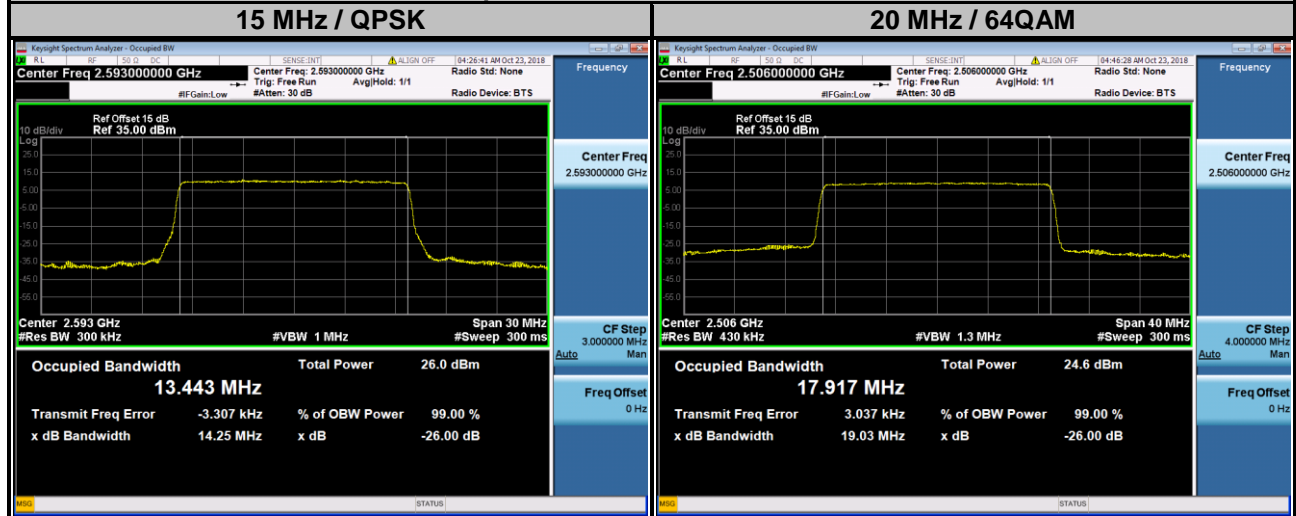

### LTE Band 41 (Power Class 3)

Channel Bandwidth: 5 MHz					Channel Bandwidth: 10 MHz				
Channel	Frequency (MHz)	99 % Occupied Bandwidth (MHz)			Channel	Frequency (MHz)	99 % Occupied Bandwidth (MHz)		
		QPSK	16QAM	64QAM			QPSK	16QAM	64QAM
39675	2498.5	4.4922	4.4894	4.5010	39700	2501.0	8.9557	8.9677	8.9623
40620	2593.0	4.4904	4.4924	4.4996	40620	2593.0	8.9511	8.9667	8.9639
41565	2687.5	4.4926	4.4929	4.5006	41540	2685.0	8.9541	8.9670	8.9582

### Spectrum Plot of Worst Value

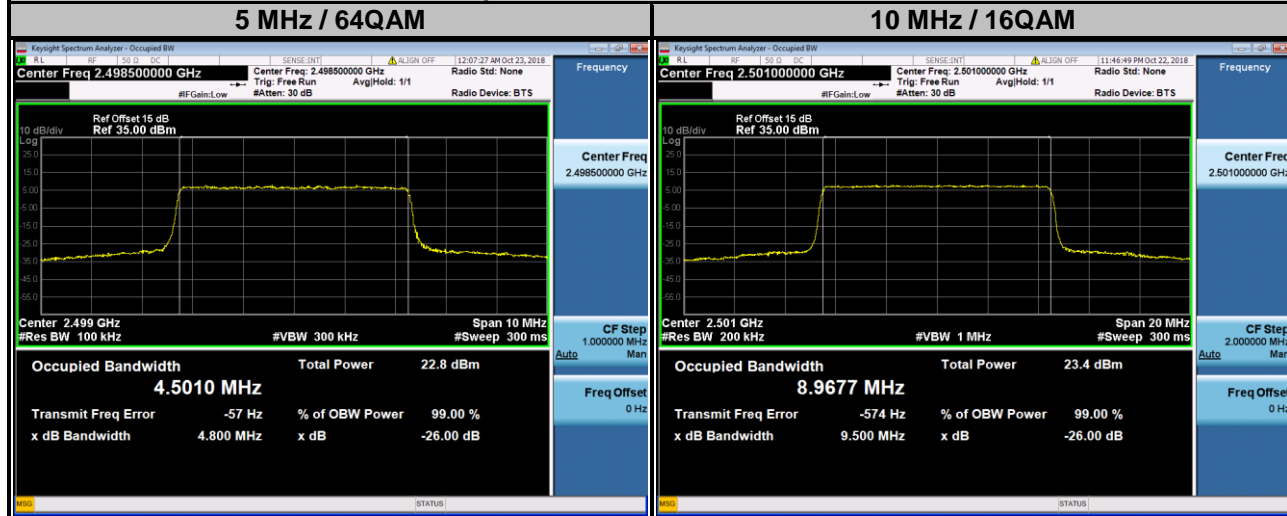

### LTE Band 41 (Power Class 3)

Channel Bandwidth: 15 MHz					Channel Bandwidth: 20 MHz				
Channel	Frequency (MHz)	99 % Occupied Bandwidth (MHz)			Channel	Frequency (MHz)	99 % Occupied Bandwidth (MHz)		
		QPSK	16QAM	64QAM			QPSK	16QAM	64QAM
39725	2503.5	13.440	13.429	13.430	39750	2506.0	17.897	17.896	17.915
40620	2593.0	13.439	13.420	13.426	40620	2593.0	17.898	17.902	17.913
41515	2682.5	13.441	13.427	13.426	41490	2680.0	17.865	17.852	17.875

### Spectrum Plot of Worst Value



<26 dB Bandwidth>

LTE Band 7									
Channel Bandwidth: 5 MHz					Channel Bandwidth: 10 MHz				
Channel	Frequency (MHz)	26 dB Bandwidth (MHz)			Channel	Frequency (MHz)	26 dB Bandwidth (MHz)		
		QPSK	16QAM	64QAM			QPSK	16QAM	64QAM
20775	2502.5	4.819	4.798	4.822	20800	2505.0	9.517	9.523	9.523
21100	2535.0	4.810	4.816	4.826	21100	2535.0	9.524	9.517	9.527
21425	2567.5	4.825	4.826	4.863	21400	2565.0	9.530	9.518	9.522

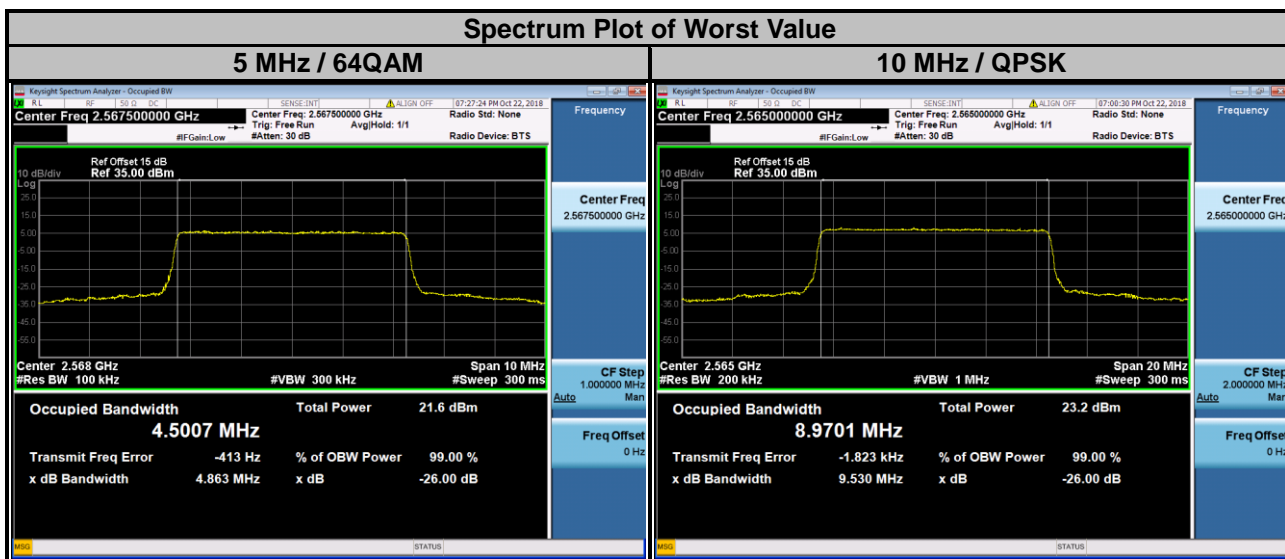

LTE Band 7									
Channel Bandwidth: 15 MHz					Channel Bandwidth: 20 MHz				
Channel	Frequency (MHz)	26 dB Bandwidth (MHz)			Channel	Frequency (MHz)	26 dB Bandwidth (MHz)		
		QPSK	16QAM	64QAM			QPSK	16QAM	64QAM
20825	2507.5	14.28	14.26	14.24	20850	2510.0	19.07	19.03	19.02
21100	2535.0	14.27	14.24	14.24	21100	2535.0	19.04	19.00	19.02
21375	2562.5	14.26	14.26	14.26	21350	2560.0	19.04	19.03	19.03

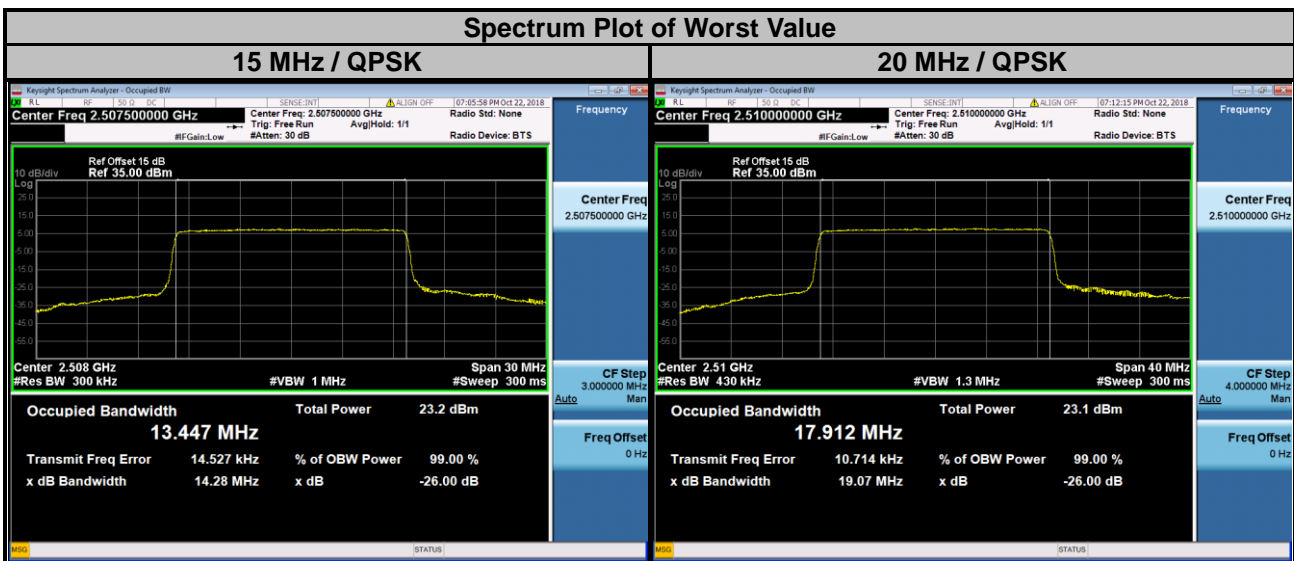

LTE Band 38									
Channel Bandwidth: 5 MHz					Channel Bandwidth: 10 MHz				
Channel	Frequency (MHz)	26 dB Bandwidth (MHz)			Channel	Frequency (MHz)	26 dB Bandwidth (MHz)		
		QPSK	16QAM	64QAM			QPSK	16QAM	64QAM
37775	2572.5	4.820	4.800	4.806	37800	2575.0	9.496	9.489	9.510
38000	2595.0	4.826	4.793	4.791	38000	2595.0	9.499	9.493	9.517
38225	2617.5	4.829	4.792	4.816	38200	2615.0	9.500	9.508	9.525

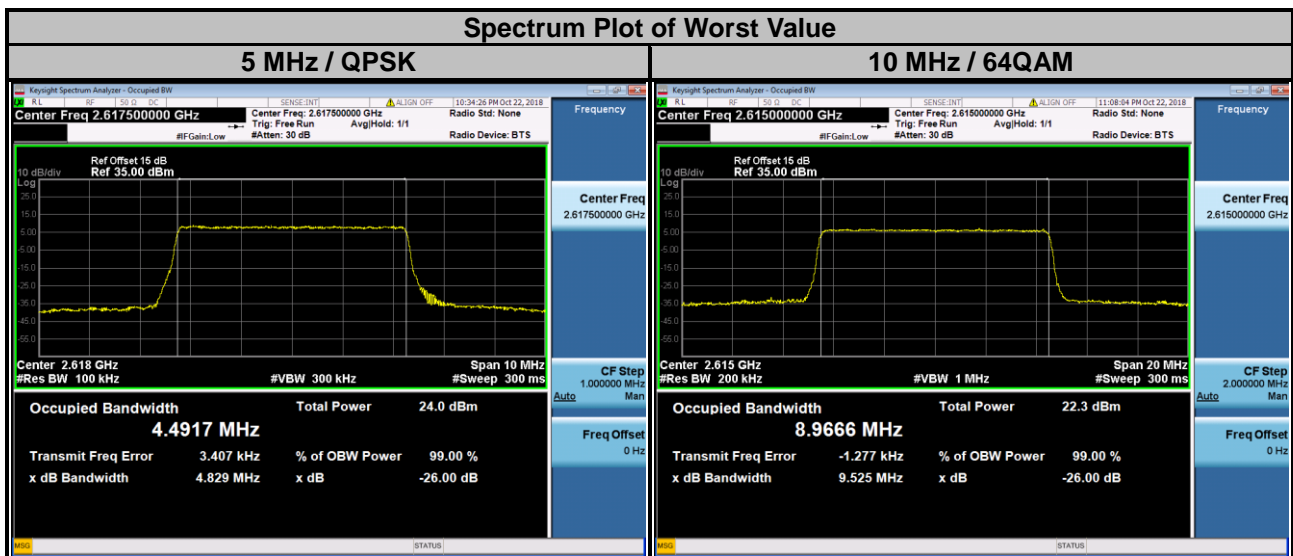

LTE Band 38									
Channel Bandwidth: 15 MHz					Channel Bandwidth: 20 MHz				
Channel	Frequency (MHz)	26 dB Bandwidth (MHz)			Channel	Frequency (MHz)	26 dB Bandwidth (MHz)		
		QPSK	16QAM	64QAM			QPSK	16QAM	64QAM
37825	2577.5	14.26	14.23	14.26	37850	2580.0	19.03	19.02	19.03
38000	2595.0	14.27	14.24	14.26	38000	2595.0	19.05	19.01	19.03
38175	2612.5	14.27	14.23	14.26	38150	2610.0	19.05	19.02	19.02

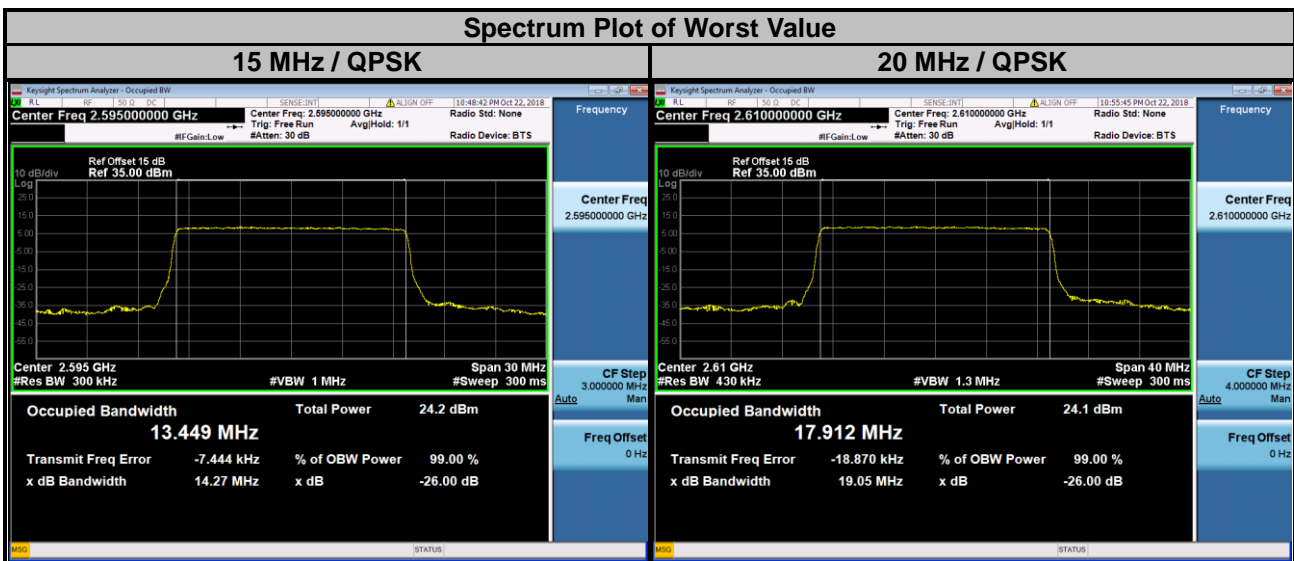



### LTE Band 41 (Power Class 2)

Channel Bandwidth: 5 MHz					Channel Bandwidth: 10 MHz				
Channel	Frequency (MHz)	26 dB Bandwidth (MHz)			Channel	Frequency (MHz)	26 dB Bandwidth (MHz)		
		QPSK	16QAM	64QAM			QPSK	16QAM	64QAM
39675	2498.5	4.821	4.801	4.823	39700	2501.0	9.493	9.503	9.512
40620	2593.0	4.813	4.802	4.790	40620	2593.0	9.506	9.508	9.510
41565	2687.5	4.833	4.805	4.798	41540	2685.0	9.499	9.502	9.506

### Spectrum Plot of Worst Value

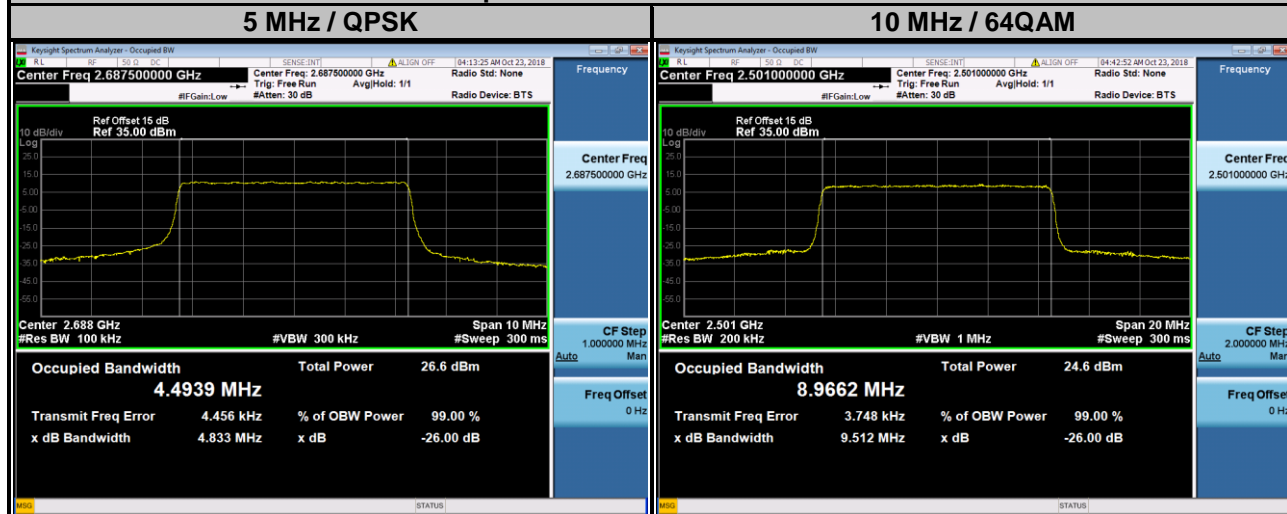

### LTE Band 41 (Power Class 2)

Channel Bandwidth: 15 MHz					Channel Bandwidth: 20 MHz				
Channel	Frequency (MHz)	26 dB Bandwidth (MHz)			Channel	Frequency (MHz)	26 dB Bandwidth (MHz)		
		QPSK	16QAM	64QAM			QPSK	16QAM	64QAM
39725	2503.5	14.28	14.25	14.22	39750	2506.0	19.02	19.02	19.03
40620	2593.0	14.25	14.23	14.22	40620	2593.0	19.04	19.02	19.02
41515	2682.5	14.25	14.23	14.23	41490	2680.0	19.00	18.98	19.01

### Spectrum Plot of Worst Value

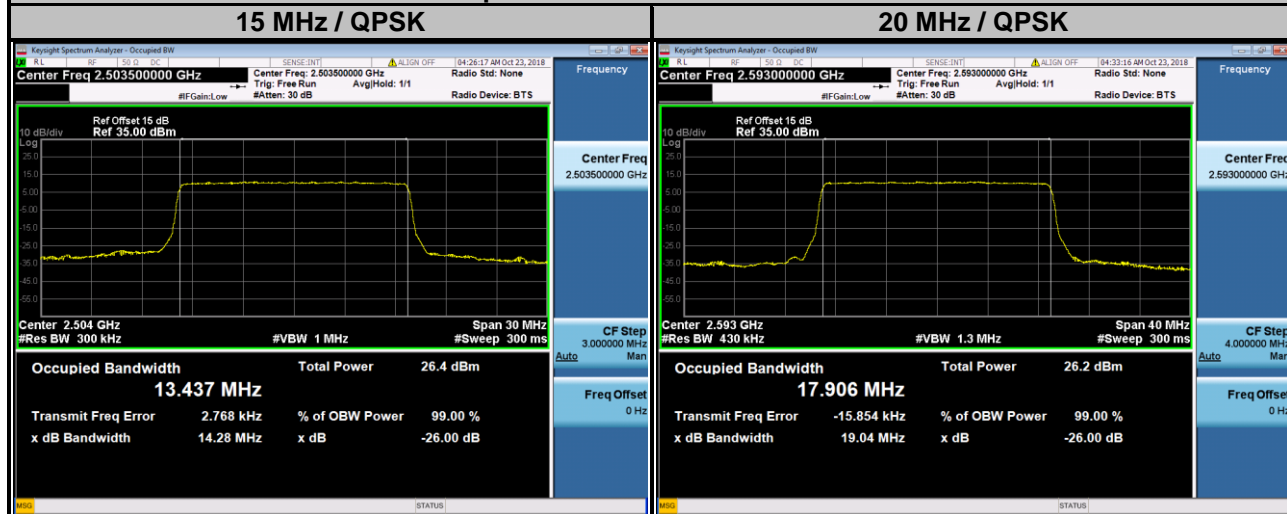

### LTE Band 41 (Power Class 3)

Channel Bandwidth: 5 MHz					Channel Bandwidth: 10 MHz				
Channel	Frequency (MHz)	26 dB Bandwidth (MHz)			Channel	Frequency (MHz)	26 dB Bandwidth (MHz)		
		QPSK	16QAM	64QAM			QPSK	16QAM	64QAM
39675	2498.5	4.828	4.798	4.800	39700	2501.0	9.491	9.500	9.498
40620	2593.0	4.808	4.782	4.804	40620	2593.0	9.498	9.502	9.498
41565	2687.5	4.809	4.788	4.811	41540	2685.0	9.500	9.506	9.521

### Spectrum Plot of Worst Value



### LTE Band 41 (Power Class 3)

Channel Bandwidth: 15 MHz					Channel Bandwidth: 20 MHz				
Channel	Frequency (MHz)	26 dB Bandwidth (MHz)			Channel	Frequency (MHz)	26 dB Bandwidth (MHz)		
		QPSK	16QAM	64QAM			QPSK	16QAM	64QAM
39725	2503.5	14.30	14.23	14.23	39750	2506.0	19.03	19.01	19.02
40620	2593.0	14.26	14.23	14.23	40620	2593.0	19.02	19.01	19.02
41515	2682.5	14.27	14.25	14.24	41490	2680.0	19.00	18.99	18.99

### Spectrum Plot of Worst Value

