

FCC Test Report

(PART 24)

Report No.: RF181001C08-8

FCC ID: A4RG020B

Model Name: G020B

Received Date: Oct. 01, 2018

Test Date: Oct. 23, 2018 ~ Nov. 01, 2018

Issued Date: Dec. 27, 2018

Applicant: Google LLC

Address: 1600 Amphitheatre Parkway, Mountain View, CA 94043,USA

Issued By: Bureau Veritas Consumer Products Services (H.K.) Ltd., Taoyuan Branch

Lab Address: No. 47-2, 14th Ling, Chia Pau Vil., Lin Kou Dist., New Taipei City, Taiwan
(R.O.C)

Test Location (1): No. 19, Hwa Ya 2nd Rd, Wen Hwa Vil, Kwei Shan Dist., Taoyuan City
33383, Taiwan (R.O.C)

**FCC Registration /
Designation Number:** 788550 / TW0003



This report is for your exclusive use. Any copying or replication of this report to or for any other person or entity, or use of our name or trademark, is permitted only with our prior written permission. This report sets forth our findings solely with respect to the test samples identified herein. The results set forth in this report are not indicative or representative of the quality or characteristics of the lot from which a test sample was taken or any similar or identical product unless specifically and expressly noted. Our report includes all of the tests requested by you and the results thereof based upon the information that you provided to us. You have 60 days from date of issuance of this report to notify us of any material error or omission caused by our negligence, provided, however, that such notice shall be in writing and shall specifically address the issue you wish to raise. A failure to raise such issue within the prescribed time shall constitute your unqualified acceptance of the completeness of this report, the tests conducted and the correctness of the report contents. Unless specific mention, the uncertainty of measurement has been explicitly taken into account to declare the compliance or non-compliance to the specification. The report must not be used by the client to claim product certification, approval, or endorsement by TAF or any government agencies.

Table of Contents

Release Control Record	4
1 Certificate of Conformity	5
2 Summary of Test Results	6
2.1 Measurement Uncertainty	6
2.2 Test Site and Instruments	7
3 General Information	9
3.1 General Description of EUT	9
3.2 Configuration of System under Test	11
3.2.1 Description of Support Units	11
3.3 Test Mode Applicability and Tested Channel Detail	12
3.4 EUT Operating Conditions	18
3.5 General Description of Applied Standards	18
4 Test Types and Results	19
4.1 Output Power Measurement	19
4.1.1 Limits of Output Power Measurement	19
4.1.2 Test Procedures	19
4.1.3 Test Setup	20
4.1.4 Test Results	21
4.2 Modulation Characteristics Measurement	38
4.2.1 Limits of Modulation Characteristics	38
4.2.2 Test Setup	38
4.2.3 Test Procedure	38
4.2.4 Test Results	39
4.3 Frequency Stability Measurement	42
4.3.1 Limits of Frequency Stability Measurement	42
4.3.2 Test Procedure	42
4.3.3 Test Setup	42
4.3.4 Test Results	43
4.4 Occupied Bandwidth Measurement	59
4.4.1 Test Procedure	59
4.4.2 Test Setup	59
4.4.3 Test Result	60
4.5 Band Edge Measurement	74
4.5.1 Limits of Band Edge Measurement	74
4.5.2 Test Setup	74
4.5.3 Test Procedures	74
4.5.4 Test Results	75
4.6 Peak to Average Ratio	89
4.6.1 Limits of Peak to Average Ratio Measurement	89
4.6.2 Test Setup	89
4.6.3 Test Procedures	89
4.6.4 Test Results	90
4.7 Conducted Spurious Emissions	97
4.7.1 Limits of Conducted Spurious Emissions Measurement	97
4.7.2 Test Setup	97
4.7.3 Test Procedure	97
4.7.4 Test Results	98
4.8 Radiated Emission Measurement	146
4.8.1 Limits of Radiated Emission Measurement	146
4.8.2 Test Procedure	146
4.8.3 Deviation from Test Standard	146
4.8.4 Test Setup	147
4.8.5 Test Results	148

5 Pictures of Test Arrangements.....	208
Appendix – Information on the Testing Laboratories	209

Release Control Record

Issue No.	Description	Date Issued
RF181001C08-8	Original Release	Dec. 27, 2018

1 Certificate of Conformity

Product: Smartphone

Model Name: G020B

Sample Status: Identical Prototype

Applicant: Google LLC

Test Date: Oct. 23, 2018 ~ Nov. 01, 2018

Standards: FCC Part 24, Subpart E

The above equipment has been tested by **Bureau Veritas Consumer Products Services (H.K.) Ltd., Taoyuan Branch**, and found compliance with the requirement of the above standards. The test record, data evaluation & Equipment Under Test (EUT) configurations represented herein are true and accurate accounts of the measurements of the sample's RF characteristics under the conditions specified in this report.

Prepared by : , **Date:** Dec. 27, 2018
Ivonne Wu / Supervisor

Approved by : , **Date:** Dec. 27, 2018
Dylan Chiou / Project Engineer

2 Summary of Test Results

Applied Standard: FCC Part 24 & Part 2			
FCC Clause	Test Item	Result	Remarks
2.1046 24.232	Effective Isotropic Radiated Power	Pass	Meet the requirement of limit.
2.1047	Modulation Characteristics	Pass	Meet the requirement.
2.1046 24.232(d)	Peak to Average Ratio	Pass	Meet the requirement of limit.
2.1055 24.235	Frequency Stability	Pass	Meet the requirement of limit.
2.1049 24.238(b)	Occupied Bandwidth	Pass	Meet the requirement of limit.
24.238(a)	Band Edge Measurements	Pass	Meet the requirement of limit.
2.1051 24.238	Conducted Spurious Emissions	Pass	Meet the requirement of limit.
2.1053 24.238	Radiated Spurious Emissions	Pass	Meet the requirement of limit. Minimum passing margin is -28.71 dB at 30.97 MHz.

2.1 Measurement Uncertainty

Where relevant, the following measurement uncertainty levels have been estimated for tests performed on the EUT as specified in CISPR 16-4-2:

Measurement	Frequency	Expanded Uncertainty (k=2) (±)
Radiated Emissions up to 1 GHz	30 MHz ~ 200 MHz	2.93 dB
	200 MHz ~ 1000 MHz	2.95 dB
Radiated Emissions above 1 GHz	1 GHz ~ 18 GHz	2.26 dB
	18 GHz ~ 40 GHz	1.94 dB

2.2 Test Site and Instruments

Description & Manufacturer	Model No.	Serial No.	Date of Calibration	Due Date of Calibration
Test Receiver Agilent	N9038A	MY51210203	Mar. 16, 2018	Mar. 15, 2019
Spectrum Analyzer Keysight	N9010A	MY56070348	Sep. 06, 2018	Sep. 05, 2019
Spectrum Analyzer ROHDE & SCHWARZ	FSU43	101261	Jan. 11, 2018	Jan. 10, 2019
Spectrum Analyzer ROHDE & SCHWARZ	FSW26	102023	Oct. 11, 2018	Oct. 10, 2019
HORN Antenna SCHWARZBECK	BBHA 9120D	9120D-969	Dec. 12, 2017	Dec. 11, 2018
HORN Antenna SCHWARZBECK	BBHA 9170	148	Dec. 13, 2017	Dec. 12, 2018
BILOG Antenna SCHWARZBECK	VULB 9168	9168-472	Dec. 06, 2017	Dec. 05, 2018
Fixed Attenuator Mini-Circuits	MDCS18N-10	MDCS18N-10-01	Apr. 16, 2018	Apr. 15, 2019
MXG Vector signal generator Agilent	N5182B	MY53052658	May 24, 2018	May 23, 2019
Preamplifier EMCI	EMC 184045	980116	Oct. 12, 2018	Oct. 11, 2019
Preamplifier EMCI	EMC 012645	980115	Oct. 12, 2018	Oct. 11, 2019
Preamplifier EMCI	EMC 330H	980112	Oct. 12, 2018	Oct. 11, 2019
RF Coaxial Cable HUBER+SUHNNER	EMC104-SM-SM-800 0&3000	140811+170717	Oct. 12, 2018	Oct. 11, 2019
RF Coaxial Cable HUBER+SUHNNER	SUCOFLEX 104	EMC104-SM-SM-1 000(140807)	Oct. 12, 2018	Oct. 11, 2019
RF Coaxial Cable WOKEN	8D-FB	Cable-Ch10-01	Oct. 12, 2018	Oct. 11, 2019
Boresight Antenna Fixture	FBA-01	FBA-SIP01	NA	NA
Software BV ADT	E3 6.120103	NA	NA	NA
Antenna Tower MF	MFA-440H	NA	NA	NA
Turn Table MF	MFT-201SS	NA	NA	NA
Antenna Tower & Turn Table Controller MF	MF-7802	NA	NA	NA
Universal Radio Communication Tester R&S	CMU200	123112	Dec. 28, 2017	Dec. 27, 2018
Radio Communication Analyzer Anritsu	MT8820C	6201300640	Aug. 16, 2017	Aug. 15, 2019
Temperature & Humidity Chamber	GTH-120-40-CP-AR	MAA1306-019	Sep. 05, 2018	Sep. 04, 2019
DC Power Supply Topward	33010D	807748	NA	NA

- Note:
1. The calibration interval of the above test instruments is 12 / 24 months and the calibrations are traceable to NML/ROC and NIST/USA.
 2. The test was performed in HwaYa Chamber 10.
 3. The horn antenna and preamplifier (model: EMC 184045) are used only for the measurement of emission frequency above 1 GHz if tested.
 4. The IC Site Registration No. is 7450F-10.

3 General Information

3.1 General Description of EUT

Product	Smartphone	
Model Name	G020B	
Status of EUT	Identical Prototype	
Power Supply Rating	3.85 Vdc (Li-ion battery) 5.0 Vdc or 9 Vdc (adapter) 5.0 Vdc (host equipment)	
Modulation Type	GSM/GPRS	GMSK
	EDGE	GMSK, 8PSK
	WCDMA	QPSK
	CDMA	QPSK, OQPSK, HPSK
	LTE	QPSK, 16QAM, 64QAM
Frequency Range	GSM/GPRS/EDGE	1850.2 ~ 1909.8 MHz
	WCDMA	1852.4 ~ 1907.6 MHz
	CDMA	1851.25 ~ 1908.75 MHz
	LTE Band 2 (Channel Bandwidth: 1.4 MHz)	1850.7 ~ 1909.3 MHz
	LTE Band 2 (Channel Bandwidth: 3 MHz)	1851.5 ~ 1908.5 MHz
	LTE Band 2 (Channel Bandwidth: 5 MHz)	1852.5 ~ 1907.5 MHz
	LTE Band 2 (Channel Bandwidth: 10 MHz)	1855.0 ~ 1905.0 MHz
	LTE Band 2 (Channel Bandwidth: 15 MHz)	1857.5 ~ 1902.5 MHz
	LTE Band 2 (Channel Bandwidth: 20 MHz)	1860.0 ~ 1900.0 MHz
	LTE Band 25 (Channel Bandwidth: 1.4 MHz)	1850.7 ~ 1914.3 MHz
	LTE Band 25 (Channel Bandwidth: 3 MHz)	1851.5 ~ 1913.5 MHz
	LTE Band 25 (Channel Bandwidth: 5 MHz)	1852.5 ~ 1912.5 MHz
	LTE Band 25 (Channel Bandwidth: 10 MHz)	1855.0 ~ 1910.0 MHz
	LTE Band 25 (Channel Bandwidth: 15 MHz)	1857.5 ~ 1907.5 MHz
	LTE Band 25 (Channel Bandwidth: 20 MHz)	1860.0 ~ 1905.0 MHz

Max. EIRP Power	GSM/GPRS	591.56 mW
	EDGE	234.96 mW
	WCDMA	159.22 mW
	CDMA	155.60 mW
	LTE Band 2 (Channel Bandwidth: 1.4 MHz)	112.20 mW
	LTE Band 2 (Channel Bandwidth: 3 MHz)	118.30 mW
	LTE Band 2 (Channel Bandwidth: 5 MHz)	125.03 mW
	LTE Band 2 (Channel Bandwidth: 10 MHz)	131.52 mW
	LTE Band 2 (Channel Bandwidth: 15 MHz)	138.68 mW
	LTE Band 2 (Channel Bandwidth: 20 MHz)	145.55 mW
	LTE Band 25 (Channel Bandwidth: 1.4 MHz)	141.25 mW
	LTE Band 25 (Channel Bandwidth: 3 MHz)	148.94 mW
	LTE Band 25 (Channel Bandwidth: 5 MHz)	157.40 mW
	LTE Band 25 (Channel Bandwidth: 10 MHz)	165.96 mW
	LTE Band 25 (Channel Bandwidth: 15 MHz)	174.58 mW
LTE Band 25 (Channel Bandwidth: 20 MHz)	183.23 mW	
Emission Designator	GSM/GPRS	247KGXW
	EDGE	246KG7W
	WCDMA	4M16F9W
	CDMA	1M28F9W
	LTE Band 2 (Channel Bandwidth: 1.4 MHz)	1M09W7D
	LTE Band 2 (Channel Bandwidth: 3 MHz)	2M70G7D
	LTE Band 2 (Channel Bandwidth: 5 MHz)	4M50W7D
	LTE Band 2 (Channel Bandwidth: 10 MHz)	8M98W7D
	LTE Band 2 (Channel Bandwidth: 15 MHz)	13M5G7D
	LTE Band 2 (Channel Bandwidth: 20 MHz)	18M0W7D
	LTE Band 25 (Channel Bandwidth: 1.4 MHz)	1M09W7D
	LTE Band 25 (Channel Bandwidth: 3 MHz)	2M70G7D
	LTE Band 25 (Channel Bandwidth: 5 MHz)	4M50W7D
	LTE Band 25 (Channel Bandwidth: 10 MHz)	8M97W7D
	LTE Band 25 (Channel Bandwidth: 15 MHz)	13M5G7D
LTE Band 25 (Channel Bandwidth: 20 MHz)	18M0W7D	
Antenna Type	PIFA Antenna with -1 dBi gain	
Accessory Device	Refer to Note as below	
Data Cable Supplied	Refer to Note as below	

Note:

- There're 2 configurations for the EUT listed as below.
 Main Sample: EUT + Battery 1
 2nd Sample: EUT + Battery 2
 ✧ After pre-tested with the EUT, only the worst configuration (main sample) was chosen for the final test.
- The EUT's accessories list refers to Ext. Pho.
- The above EUT information is declared by manufacturer and for more detailed features description, please refers to the manufacturer's specifications or user's manual.

3.2 Configuration of System under Test

<Radiated Emission Test>

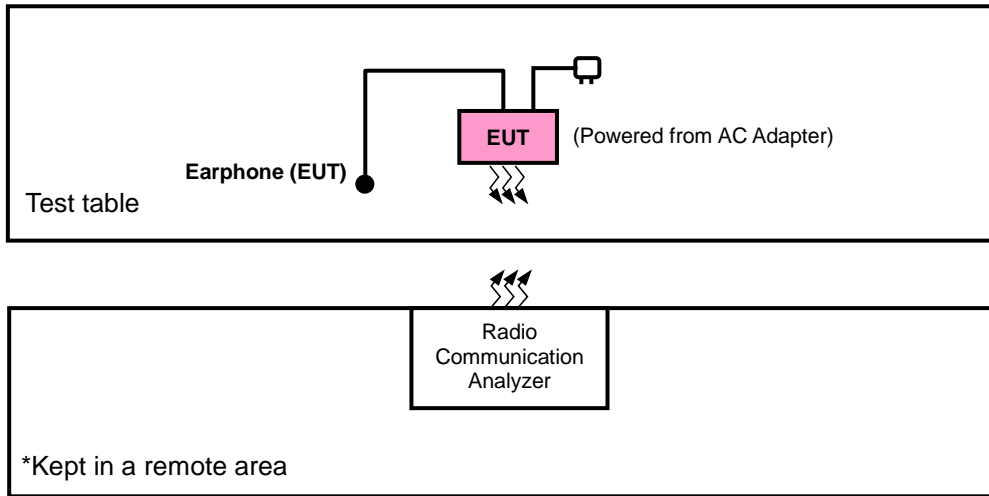

<E.I.R.P. Test>

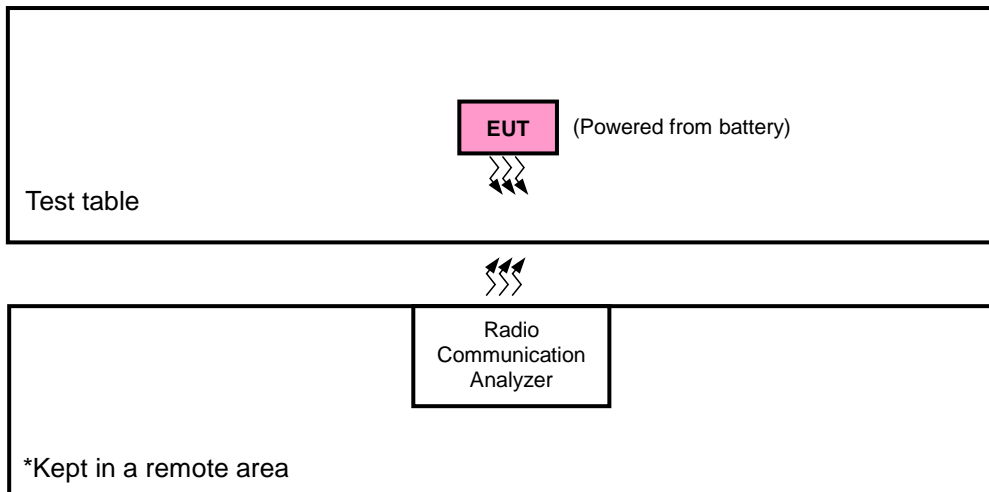

3.2.1 Description of Support Units

The EUT has been tested as an independent unit together with other necessary accessories or support units.

3.3 Test Mode Applicability and Tested Channel Detail

Pre-Scan has been conducted to determine the worst-case mode from all possible combinations between available modulations, data rates, XYZ axis, and antenna ports.

The worst case was found when positioned as the table below. Following channel(s) was (were) selected for the final test as listed below:

Band	EIRP	Radiated Emission
GSM	X-plane	X-axis
EDGE	X-plane	X-axis
WCDMA	X-plane	X-axis
CDMA	X-plane	X-axis
LTE Band 2	X-plane	X-axis
LTE Band 25	X-plane	X-axis

GSM

EUT Configure Mode	Test Item	Available Channel	Tested Channel	Mode
-	EIRP	512 to 810	512, 661, 810	GSM, EDGE
-	Modulation Characteristics	512 to 810	661	GSM, EDGE
-	Frequency Stability	512 to 810	512, 810	GSM, EDGE
-	Occupied Bandwidth	512 to 810	512, 661, 810	GSM, EDGE
-	Band Edge	512 to 810	512, 810	GSM, EDGE
-	Peak to Average Ratio	512 to 810	512, 661, 810	GSM, EDGE
-	Conducted Emission	512 to 810	512, 661, 810	GSM, EDGE
-	Radiated Emission	512 to 810	512, 661, 810	GSM, EDGE

WCDMA

EUT Configure Mode	Test Item	Available Channel	Tested Channel	Mode
-	EIRP	9262 to 9538	9262, 9400, 9538	WCDMA
-	Modulation Characteristics	9262 to 9538	9400	WCDMA
-	Frequency Stability	9262 to 9538	9262, 9538	WCDMA
-	Occupied Bandwidth	9262 to 9538	9262, 9400, 9538	WCDMA
-	Band Edge	9262 to 9538	9262, 9538	WCDMA
-	Peak to Average Ratio	9262 to 9538	9262, 9400, 9538	WCDMA
-	Conducted Emission	9262 to 9538	9262, 9400, 9538	WCDMA
-	Radiated Emission	9262 to 9538	9262, 9400, 9538	WCDMA

CDMA

EUT Configure Mode	Test Item	Available Channel	Tested Channel	Mode
-	ERP	25 to 1175	25, 600, 1175	1xRTT
-	Modulation Characteristics	25 to 1175	600	1xRTT
-	Frequency Stability	25 to 1175	25, 1175	1xRTT
-	Occupied Bandwidth	25 to 1175	25, 600, 1175	1xRTT
-	Band Edge	25 to 1175	25, 600, 1175	1xRTT
-	Peak to Average Ratio	25 to 1175	25, 1175	1xRTT
-	Conducted Emission	25 to 1175	25, 600, 1175	1xRTT
-	Radiated Emission	25 to 1175	25, 600, 1175	1xRTT

LTE Band 2

EUT Configure Mode	Test Item	Available Channel	Tested Channel	Channel Bandwidth	Modulation	Mode
-	EIRP	18607 to 19193	18607, 18900, 19193	1.4 MHz	QPSK, 16QAM, 64QAM	1 RB / 0 RB Offset
		18615 to 19185	18615, 18900, 19185	3 MHz	QPSK, 16QAM, 64QAM	1 RB / 0 RB Offset
		18625 to 19175	18625, 18900, 19175	5 MHz	QPSK, 16QAM, 64QAM	1 RB / 0 RB Offset
		18650 to 19150	18650, 18900, 19150	10 MHz	QPSK, 16QAM, 64QAM	1 RB / 0 RB Offset
		18675 to 19125	18675, 18900, 19125	15 MHz	QPSK, 16QAM, 64QAM	1 RB / 0 RB Offset
		18700 to 19100	18700, 18900, 19100	20 MHz	QPSK, 16QAM, 64QAM	1 RB / 0 RB Offset
-	Modulation Characteristics	18650 to 19150	18900	10 MHz	QPSK, 16QAM, 64QAM	50 RB / 0 RB Offset
-	Frequency Stability	18607 to 19193	18607, 19193	1.4 MHz	QPSK	1 RB / 0 RB Offset
		18615 to 19185	18615, 19185	3 MHz	QPSK	1 RB / 0 RB Offset
		18625 to 19175	18625, 19175	5 MHz	QPSK	1 RB / 0 RB Offset
		18650 to 19150	18650, 19150	10 MHz	QPSK	1 RB / 0 RB Offset
		18675 to 19125	18675, 19125	15 MHz	QPSK	1 RB / 0 RB Offset
		18700 to 19100	18700, 19100	20 MHz	QPSK	1 RB / 0 RB Offset
-	Occupied Bandwidth	18607 to 19193	18607, 18900, 19193	1.4 MHz	QPSK, 16QAM, 64QAM	6 RB / 0 RB Offset
		18615 to 19185	18615, 18900, 19185	3 MHz	QPSK, 16QAM, 64QAM	15 RB / 0 RB Offset
		18625 to 19175	18625, 18900, 19175	5 MHz	QPSK, 16QAM, 64QAM	25 RB / 0 RB Offset
		18650 to 19150	18650, 18900, 19150	10 MHz	QPSK, 16QAM, 64QAM	50 RB / 0 RB Offset
		18675 to 19125	18675, 18900, 19125	15 MHz	QPSK, 16QAM, 64QAM	75 RB / 0 RB Offset
		18700 to 19100	18700, 18900, 19100	20 MHz	QPSK, 16QAM, 64QAM	100 RB / 0 RB Offset
-	Peak to Average Ratio	18607 to 19193	18607, 18900, 19193	1.4 MHz	QPSK, 16QAM, 64QAM	1 RB / 0 RB Offset
		18615 to 19185	18615, 18900, 19185	3 MHz	QPSK, 16QAM, 64QAM	1 RB / 0 RB Offset
		18625 to 19175	18625, 18900, 19175	5 MHz	QPSK, 16QAM, 64QAM	1 RB / 0 RB Offset
		18650 to 19150	18650, 18900, 19150	10 MHz	QPSK, 16QAM, 64QAM	1 RB / 0 RB Offset
		18675 to 19125	18675, 18900, 19125	15 MHz	QPSK, 16QAM, 64QAM	1 RB / 0 RB Offset
		18700 to 19100	18700, 18900, 19100	20 MHz	QPSK, 16QAM, 64QAM	1 RB / 0 RB Offset

EUT Configure Mode	Test Item	Available Channel	Tested Channel	Channel Bandwidth	Modulation	Mode		
-	Band Edge	18607 to 19193	18607	1.4 MHz	QPSK	1 RB / 0 RB Offset 6 RB / 0 RB Offset		
			19193	1.4 MHz	QPSK	1 RB / 5 RB Offset 6 RB / 0 RB Offset		
		18615 to 19185	18615	3 MHz	QPSK	1 RB / 0 RB Offset 15 RB / 0 RB Offset		
			19185	3 MHz	QPSK	1 RB / 14 RB Offset 15 RB / 0 RB Offset		
		18625 to 19175	18625	5 MHz	QPSK	1 RB / 0 RB Offset 25 RB / 0 RB Offset		
			19175	5 MHz	QPSK	1 RB / 24 RB Offset 25 RB / 0 RB Offset		
		18650 to 19150	18650	10 MHz	QPSK	1 RB / 0 RB Offset 50 RB / 0 RB Offset		
			19150	10 MHz	QPSK	1 RB / 49 RB Offset 50 RB / 0 RB Offset		
		18675 to 19125	18675	15 MHz	QPSK	1 RB / 0 RB Offset 75 RB / 0 RB Offset		
			19125	15 MHz	QPSK	1 RB / 74 RB Offset 75 RB / 0 RB Offset		
		18700 to 19100	18700	20 MHz	QPSK	1 RB / 0 RB Offset 100 RB / 0 RB Offset		
			19100	20 MHz	QPSK	1 RB / 99 RB Offset 100 RB / 0 RB Offset		
		-	Conducted Emission	18607 to 19193	18607, 18900, 19193	1.4 MHz	QPSK	1 RB / 0 RB Offset
				18615 to 19185	18615, 18900, 19185	3 MHz	QPSK	1 RB / 0 RB Offset
				18625 to 19175	18625, 18900, 19175	5 MHz	QPSK	1 RB / 0 RB Offset
				18650 to 19150	18650, 18900, 19150	10 MHz	QPSK	1 RB / 0 RB Offset
18675 to 19125	18675, 18900, 19125			15 MHz	QPSK	1 RB / 0 RB Offset		
18700 to 19100	18700, 18900, 19100			20 MHz	QPSK	1 RB / 0 RB Offset		
-	Radiated Emission	18607 to 19193	18607, 18900, 19193	1.4 MHz	QPSK	1 RB / 0 RB Offset		
		18625 to 19175	18625, 18900, 19175	5 MHz	QPSK	1 RB / 0 RB Offset		
		18700 to 19100	18700, 18900, 19100	20 MHz	QPSK	1 RB / 0 RB Offset		

Note: This device was tested under all bandwidths, RB configurations and modulations. The worst case was found in QPSK modulation.

LTE Band 25

EUT Configure Mode	Test Item	Available Channel	Tested Channel	Channel Bandwidth	Modulation	Mode
-	EIRP	26047 to 26683	26047, 26365, 26683	1.4 MHz	QPSK, 16QAM, 64QAM	1 RB / 2 RB Offset
		26055 to 26675	26055, 26365, 26675	3 MHz	QPSK, 16QAM, 64QAM	1 RB / 7 RB Offset
		26065 to 26665	26065, 26365, 26665	5 MHz	QPSK, 16QAM, 64QAM	1 RB / 12 RB Offset
		26090 to 26640	26090, 26365, 26640	10 MHz	QPSK, 16QAM, 64QAM	1 RB / 24 RB Offset
		26115 to 26615	26115, 26365, 26615	15 MHz	QPSK, 16QAM, 64QAM	1 RB / 37 RB Offset
		26140 to 26590	26140, 26365, 26590	20 MHz	QPSK, 16QAM, 64QAM	1 RB / 50 RB Offset
-	Modulation Characteristics	26140 to 26590	26140	20 MHz	QPSK, 16QAM, 64QAM	50 RB / 0 RB Offset
-	Frequency Stability	26047 to 26683	26047, 26683	1.4 MHz	QPSK	1 RB / 0 RB Offset
		26055 to 26675	26055, 26675	3 MHz	QPSK	1 RB / 0 RB Offset
		26065 to 26665	26065, 26665	5 MHz	QPSK	1 RB / 0 RB Offset
		26090 to 26640	26090, 26640	10 MHz	QPSK	1 RB / 0 RB Offset
		26115 to 26615	26115, 26615	15 MHz	QPSK	1 RB / 0 RB Offset
		26140 to 26590	26140, 26590	20 MHz	QPSK	1 RB / 0 RB Offset
-	Occupied Bandwidth	26047 to 26683	26047, 26365, 26683	1.4 MHz	QPSK, 16QAM, 64QAM	6 RB / 0 RB Offset
		26055 to 26675	26055, 26365, 26675	3 MHz	QPSK, 16QAM, 64QAM	15 RB / 0 RB Offset
		26065 to 26665	26065, 26365, 26665	5 MHz	QPSK, 16QAM, 64QAM	25 RB / 0 RB Offset
		26090 to 26640	26090, 26365, 26640	10 MHz	QPSK, 16QAM, 64QAM	50 RB / 0 RB Offset
		26115 to 26615	26115, 26365, 26615	15 MHz	QPSK, 16QAM, 64QAM	75 RB / 0 RB Offset
		26140 to 26590	26140, 26365, 26590	20 MHz	QPSK, 16QAM, 64QAM	100 RB / 0 RB Offset
-	Peak to Average Ratio	26047 to 26683	26047, 26365, 26683	1.4 MHz	QPSK, 16QAM, 64QAM	1 RB / 0 RB Offset
		26055 to 26675	26055, 26365, 26675	3 MHz	QPSK, 16QAM, 64QAM	1 RB / 0 RB Offset
		26065 to 26665	26065, 26365, 26665	5 MHz	QPSK, 16QAM, 64QAM	1 RB / 0 RB Offset
		26090 to 26640	26090, 26365, 26640	10 MHz	QPSK, 16QAM, 64QAM	1 RB / 0 RB Offset
		26115 to 26615	26115, 26365, 26615	15 MHz	QPSK, 16QAM, 64QAM	1 RB / 0 RB Offset
		26140 to 26590	26140, 26365, 26590	20 MHz	QPSK, 16QAM, 64QAM	1 RB / 0 RB Offset

EUT Configure Mode	Test Item	Available Channel	Tested Channel	Channel Bandwidth	Modulation	Mode		
-	Band Edge	26047 to 26683	26047	1.4 MHz	QPSK	1 RB / 0 RB Offset		
			26683	1.4 MHz		6 RB / 0 RB Offset		
		26055 to 26675	26055	3 MHz	QPSK	1 RB / 5 RB Offset		
			26675	3 MHz		6 RB / 0 RB Offset		
		26065 to 26665	26065	5 MHz	QPSK	1 RB / 0 RB Offset		
			26665	5 MHz		1 RB / 24 RB Offset		
		26090 to 26640	26090	10 MHz	QPSK	25 RB / 0 RB Offset		
			26640	10 MHz		1 RB / 49 RB Offset		
		26115 to 26615	26115	15 MHz	QPSK	50 RB / 0 RB Offset		
			26615	15 MHz		1 RB / 74 RB Offset		
		26140 to 26590	26140	20 MHz	QPSK	75 RB / 0 RB Offset		
			26590	20 MHz		1 RB / 99 RB Offset		
		-	Conducted Emission	26047 to 26683	26047, 26365, 26683	1.4 MHz	QPSK	100 RB / 0 RB Offset
				26055 to 26675	26055, 26365, 26675	3 MHz		1 RB / 2 RB Offset
				26065 to 26665	26065, 26365, 26665	5 MHz		1 RB / 7 RB Offset
				26090 to 26640	26090, 26365, 26640	10 MHz		1 RB / 12 RB Offset
				26115 to 26615	26115, 26365, 26615	15 MHz		1 RB / 24 RB Offset
				26140 to 26590	26140, 26365, 26590	20 MHz		1 RB / 37 RB Offset
-	Radiated Emission	18607 to 19193	18607, 18900, 19193	1.4 MHz	QPSK	1 RB / 50 RB Offset		
		18625 to 19175	18625, 18900, 19175	5 MHz		1 RB / 2 RB Offset		
		18700 to 19100	18700, 18900, 19100	20 MHz		1 RB / 12 RB Offset		

Note: This device was tested under all bandwidths, RB configurations and modulations. The worst case was found in QPSK modulation.

Test Condition:

Test Item	Environmental Conditions	Input Power	Tested By
EIRP	26 deg. C, 58 % RH	3.85 Vdc	Thomas Wei
Modulation Characteristics	26 deg. C, 58 % RH	3.85 Vdc	Wayne Lin
Frequency Stability	26 deg. C, 58 % RH	3.85 Vdc	Wayne Lin
Occupied Bandwidth	26 deg. C, 58 % RH	3.85 Vdc	Wayne Lin
Band Edge	26 deg. C, 58 % RH	3.85 Vdc	Wayne Lin
Peak to Average Ratio	26 deg. C, 58 % RH	3.85 Vdc	Wayne Lin
Conducted Emission	26 deg. C, 58 % RH	3.85 Vdc	Wayne Lin
Radiated Emission	25 deg. C, 65 % RH	120 Vac, 60 Hz	Thomas Wei

3.4 EUT Operating Conditions

The EUT makes a call to the communication simulator. The communication simulator station system controlled a EUT to export maximum output power under transmission mode and specific channel frequency

3.5 General Description of Applied Standards

The EUT is a RF Product. According to the specifications of the manufacturer, it must comply with the requirements of the following standards:

FCC 47 CFR Part 2

FCC 47 CFR Part 24

KDB 971168 D01 Power Meas License Digital Systems v03r01

ANSI/TIA/EIA-603-E 2016

ANSI 63.26-2015

NOTE: All test items have been performed and recorded as per the above standards.

4 Test Types and Results

4.1 Output Power Measurement

4.1.1 Limits of Output Power Measurement

Mobile / Portable station are limited to 2 watts e.i.r.p.

4.1.2 Test Procedures

EIRP / ERP Measurement:

- a. All measurements were done at low, middle and high operational frequency range. RBW and VBW is 1 MHz for GSM, GPRS & EDGE, 5 MHz for WCDMA and CDMA, and 10 MHz for LTE mode.
- b. Substitution method is used for E.I.R.P measurement. In the semi-anechoic chamber, EUT placed on the 0.8 m (below or equal 1 GHz) and/or 1.5 m (above 1 GHz) height of Turn Table, rotated the table around 360 degrees to search the maximum radiation power and receiver antenna shall be rotated vertical and horizontal polarization and moved height from 1 m to 4 m to find the maximum polar radiated power. The "Read Value" is the spectrum reading the maximum power value.
- c. The substitution horn antenna is substituted for EUT at the same position and signals generator export the CW signal to the substitution antenna via a tx cable. Rotated the Turn Table and moved receiving antenna to find the maximum radiation power. Adjust output power level of S.G to get a Value of spectrum reading equal to "Read Value" of step b. Record the power level of S.G.
- d. $EIRP = \text{Output power level of S.G} - \text{TX cable loss} + \text{Antenna gain of substitution horn}$. E.R.P power can be calculated form E.I.R.P power by subtracting the gain of dipole, $E.R.P \text{ power} = E.I.R.P \text{ power} - 2.15 \text{ dB}$.

Conducted Power Measurement:

The EUT was set up for the maximum power with GSM, GPRS, EDGE, WCDMA, CDMA, and LTE link data modulation and link up with simulator. Set the EUT to transmit under low, middle and high channel and record the power level shown on simulator.

4.1.3 Test Setup

EIRP / ERP Measurement:

<Radiated Emission below or equal 1 GHz>

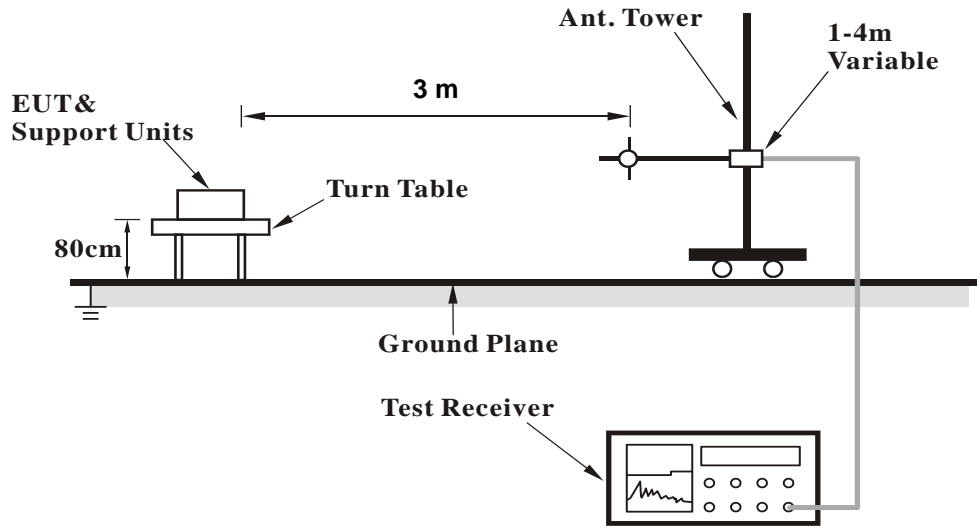

<Radiated Emission above 1 GHz>

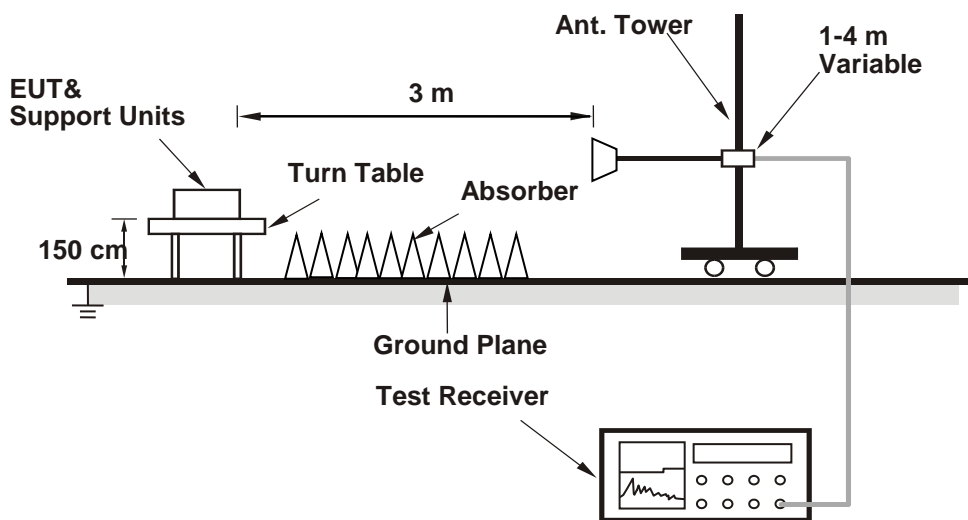

For the actual test configuration, please refer to the attached file (Test Setup Photo).

Conducted Power Measurement:

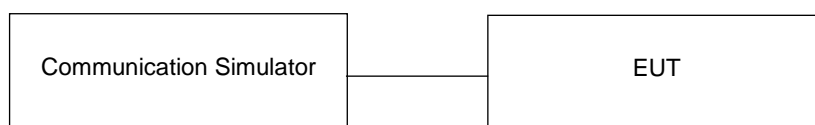

4.1.4 Test Results

The worst configuration mode is presented in the report as below. Please refer to SAR test report for more detail test mode.

Band		TX Antenna	WLAN Function	Body-Worn/Hotspot
GSM	1900	Ant 0	WLAN-Off	Body-Worn/Hotspot
WCDMA	B2	Ant 0	WLAN-Off	Body-Worn/Hotspot
CDMA	BC1	Ant 0	WLAN-Off	Body-Worn/Hotspot
LTE	B2	Ant 0	WLAN-Off	Body-Worn/Hotspot
	B25	Ant 0	WLAN-Off	Body-Worn/Hotspot

Conducted Output Power (dBm)

Band	GSM1900		
	Body-Worn / Hotspot		
Mode	Ant-0		
Tx Antenna	Ant-0		
Channel	512	661	810
Frequency (MHz)	1850.2	1880.0	1909.8
GSM (GMSK, 1Tx-slot)	30.35	30.37	30.17
GPRS (GMSK, 1Tx-slot)	30.32	30.34	30.14
GPRS (GMSK, 2Tx-slot)	28.56	28.58	28.38
GPRS (GMSK, 3Tx-slot)	26.33	26.35	26.15
GPRS (GMSK, 4Tx-slot)	25.61	25.63	25.51
DTM (GMSK, 2Tx-slot)	28.11	28.13	28.02
DTM (GMSK, 3Tx-slot)	25.91	25.93	25.73
EDGE (8PSK, 1Tx-slot)	25.92	25.94	25.74
EDGE (8PSK, 2Tx-slot)	24.61	24.59	24.57
EDGE (8PSK, 3Tx-slot)	23.64	23.66	23.46
EDGE (8PSK, 4Tx-slot)	22.62	22.64	22.44
DTM (8PSK, 2Tx-slot)	24.55	24.38	24.49
DTM (8PSK, 3Tx-slot)	23.59	23.61	23.41

Band	WCDMA II		
Mode	Body-Worn / Hotspot		
Tx Antenna	Ant-0		
Channel	9262	9400	9538
Frequency (MHz)	1852.4	1880.0	1907.6
RMC 12.2K	24.83	24.79	24.87
HSDPA Subtest-1	23.87	23.83	23.91
HSDPA Subtest-2	23.85	23.81	23.89
HSDPA Subtest-3	23.40	23.36	23.44
HSDPA Subtest-4	23.38	23.34	23.42
DC-HSDPA Subtest-1	23.79	23.75	23.83
DC-HSDPA Subtest-2	23.77	23.73	23.81
DC-HSDPA Subtest-3	23.32	23.28	23.36
DC-HSDPA Subtest-4	23.30	23.26	23.34
HSUPA Subtest-1	23.79	23.75	23.83
HSUPA Subtest-2	21.68	21.64	21.72
HSUPA Subtest-3	22.75	22.71	22.79
HSUPA Subtest-4	21.71	21.67	21.75
HSUPA Subtest-5	23.76	23.72	23.80

Band	CDMA BC1		
Mode	Body-Worn / Hotspot		
Tx Antenna	Ant-0		
Channel	25	600	1175
Frequency (MHz)	1851.25	1880	1908.75
RC1+SO55	24.24	24.14	24.39
RC3+SO55	24.11	24.01	24.26
RC3+SO32 (+F-SCH)	24.14	24.04	24.29
RC3+SO32 (+SCH)	24.12	24.02	24.27
RTAP 153.6	24.21	24.11	24.36
RETAP 4096	24.18	24.08	24.33

LTE Band 2
Body-Worn / Hotspot
Ant-0

BW	MCS Index	RB Size	RB Offset	Low	Mid	High	3GPP MPR (dB)	BW	MCS Index	RB Size	RB Offset	Low	Mid	High	3GPP MPR (dB)		
				18700	18900	19100						18675	18900	19125			
				Channel	1860.0	1880.0						1900.0	Channel	1857.5		1880.0	1902.5
		Frequency (MHz)							Frequency (MHz)								
20M	QPSK	1	0	24.73	24.75	24.76	0	15M	QPSK	1	0	24.64	24.66	24.67	0		
		1	50	24.69	24.71	24.72	0			1	37	24.60	24.62	24.63	0		
		1	99	24.67	24.69	24.70	0			1	74	24.58	24.60	24.61	0		
		50	0	23.79	23.81	23.82	1			36	0	23.70	23.72	23.73	1		
		50	25	23.77	23.79	23.80	1			36	19	23.68	23.70	23.71	1		
		50	50	23.71	23.73	23.74	1			36	39	23.62	23.64	23.65	1		
		100	0	23.73	23.75	23.76	1			75	0	23.64	23.66	23.67	1		
	16QAM	1	0	23.71	23.73	23.74	1		16QAM	1	0	23.62	23.64	23.65	1		
		1	50	23.67	23.69	23.70	1			1	37	23.58	23.60	23.61	1		
		1	99	23.65	23.67	23.68	1			1	74	23.56	23.58	23.59	1		
		50	0	22.77	22.79	22.80	2			36	0	22.68	22.70	22.71	2		
		50	25	22.75	22.77	22.78	2			36	19	22.66	22.68	22.69	2		
		50	50	22.69	22.71	22.72	2			36	39	22.60	22.62	22.63	2		
		100	0	22.71	22.73	22.74	2			75	0	22.62	22.64	22.65	2		
	64QAM	1	0	22.72	22.74	22.75	2		64QAM	1	0	22.63	22.65	22.66	2		
		1	50	22.68	22.70	22.71	2			1	37	22.59	22.61	22.62	2		
		1	99	22.66	22.68	22.69	2			1	74	22.57	22.59	22.60	2		
		50	0	21.78	21.80	21.81	3			36	0	21.69	21.71	21.72	3		
		50	25	21.76	21.78	21.79	3			36	19	21.67	21.69	21.70	3		
		50	50	21.70	21.72	21.73	3			36	39	21.61	21.63	21.64	3		
		100	0	21.72	21.74	21.75	3			75	0	21.63	21.65	21.66	3		
	10M	QPSK	1	0	24.61	24.63	24.64		0	5M	QPSK	1	0	24.68	24.70	24.71	0
			1	24	24.57	24.59	24.60		0			1	12	24.64	24.66	24.67	0
			1	49	24.55	24.57	24.58		0			1	24	24.62	24.64	24.65	0
25			0	23.67	23.69	23.70	1	12	0			23.74	23.76	23.77	1		
25			12	23.65	23.67	23.68	1	12	6			23.72	23.74	23.75	1		
25			25	23.59	23.61	23.62	1	12	13			23.66	23.68	23.69	1		
50			0	23.61	23.63	23.64	1	25	0			23.68	23.70	23.71	1		
16QAM		1	0	23.59	23.61	23.62	1	16QAM	1		0	23.66	23.68	23.69	1		
		1	24	23.55	23.57	23.58	1		1		12	23.62	23.64	23.65	1		
		1	49	23.53	23.55	23.56	1		1		24	23.60	23.62	23.63	1		
		25	0	22.65	22.67	22.68	2		12		0	22.72	22.74	22.75	2		
		25	12	22.63	22.65	22.66	2		12		6	22.70	22.72	22.73	2		
		25	25	22.57	22.59	22.60	2		12		13	22.64	22.66	22.67	2		
		50	0	22.59	22.61	22.62	2		25		0	22.66	22.68	22.69	2		
64QAM		1	0	22.60	22.62	22.63	2	64QAM	1		0	22.67	22.69	22.70	2		
		1	24	22.56	22.58	22.59	2		1		12	22.63	22.65	22.66	2		
		1	49	22.54	22.56	22.57	2		1		24	22.61	22.63	22.64	2		
		25	0	21.66	21.68	21.69	3		12		0	21.73	21.75	21.76	3		
		25	12	21.64	21.66	21.67	3		12		6	21.71	21.73	21.74	3		
		25	25	21.58	21.60	21.61	3		12		13	21.65	21.67	21.68	3		
		50	0	21.60	21.62	21.63	3		25		0	21.67	21.69	21.70	3		
3M		QPSK	1	0	24.60	24.62	24.63	0	1.4M		QPSK	1	0	24.57	24.59	24.60	0
			1	7	24.56	24.58	24.59	0				1	2	24.53	24.55	24.56	0
			1	14	24.54	24.56	24.57	0				1	5	24.51	24.53	24.54	0
	8		0	23.66	23.68	23.69	1	3		0		24.52	24.54	24.55	0		
	8		3	23.64	23.66	23.67	1	3		1		24.50	24.52	24.53	0		
	8		7	23.58	23.60	23.61	1	3		3		24.44	24.46	24.47	0		
	15		0	23.60	23.62	23.63	1	6		0		23.57	23.59	23.60	1		
	16QAM	1	0	23.58	23.60	23.61	1	16QAM		1	0	23.55	23.57	23.58	1		
		1	7	23.54	23.56	23.57	1			1	2	23.51	23.53	23.54	1		
		1	14	23.52	23.54	23.55	1			1	5	23.49	23.51	23.52	1		
		8	0	22.64	22.66	22.67	2			3	0	23.50	23.52	23.53	1		
		8	3	22.62	22.64	22.65	2			3	1	23.48	23.50	23.51	1		
		8	7	22.56	22.58	22.59	2			3	3	23.42	23.44	23.45	1		
		15	0	22.58	22.60	22.61	2			6	0	22.55	22.57	22.58	2		
	64QAM	1	0	22.59	22.61	22.62	2	64QAM		1	0	22.56	22.58	22.59	2		
		1	7	22.55	22.57	22.58	2			1	2	22.52	22.54	22.55	2		
		1	14	22.53	22.55	22.56	2			1	5	22.50	22.52	22.53	2		
		8	0	21.65	21.67	21.68	3			3	0	22.51	22.53	22.54	2		
		8	3	21.63	21.65	21.66	3			3	1	22.49	22.51	22.52	2		
		8	7	21.57	21.59	21.60	3			3	3	22.43	22.45	22.46	2		
		15	0	21.59	21.61	21.62	3			6	0	21.56	21.58	21.59	3		

LTE Band 25
Body-Worn / Hotspot
Ant-0

BW	MCS Index	RB Size	RB Offset	Low	Mid	High	3GPP MPR (dB)	BW	MCS Index	RB Size	RB Offset	Low	Mid	High	3GPP MPR (dB)		
				Channel	26140	26365						26590	Channel	26115		26365	26615
				Frequency (MHz)	1860.0	1882.5						1905.0	Frequency (MHz)	1857.5		1882.5	1907.5
20M	QPSK	1	0	24.75	24.49	24.72	0	15M	QPSK	1	0	24.72	24.46	24.69	0		
		1	50	25.11	24.85	25.08	0			1	37	25.08	24.82	25.05	0		
		1	99	24.99	24.73	24.96	0			1	74	24.96	24.70	24.93	0		
		50	0	24.04	23.78	24.01	1			36	0	24.01	23.75	23.98	1		
		50	25	24.14	23.88	24.11	1			36	19	24.11	23.85	24.08	1		
		50	50	24.09	23.83	24.06	1			36	39	24.06	23.80	24.03	1		
	100	0	24.11	23.85	24.08	1	75		0	24.08	23.82	24.05	1				
	16QAM	1	0	23.72	23.46	23.69	1		16QAM	1	0	23.69	23.43	23.66	1		
		1	50	24.08	23.82	24.05	1			1	37	24.05	23.79	24.02	1		
		1	99	23.96	23.70	23.93	1			1	74	23.93	23.67	23.90	1		
		50	0	23.01	22.75	22.98	2			36	0	22.98	22.72	22.95	2		
		50	25	23.11	22.85	23.08	2			36	19	23.08	22.82	23.05	2		
		50	50	23.06	22.80	23.03	2			36	39	23.03	22.77	23.00	2		
	100	0	23.08	22.82	23.05	2	75		0	23.05	22.79	23.02	2				
	64QAM	1	0	22.74	22.48	22.71	2		64QAM	1	0	22.71	22.45	22.68	2		
		1	50	23.10	22.84	23.07	2			1	37	23.07	22.81	23.04	2		
		1	99	22.98	22.72	22.95	2			1	74	22.95	22.69	22.92	2		
		50	0	22.03	21.77	22.00	3			36	0	22.00	21.74	21.97	3		
50		25	22.13	21.87	22.10	3	36	19		22.10	21.84	22.07	3				
50		50	22.08	21.82	22.05	3	36	39		22.05	21.79	22.02	3				
100	0	22.10	21.84	22.07	3	75	0	22.07	21.81	22.04	3						
10M	QPSK	1	0	24.66	24.40	24.63	0	5M	QPSK	1	0	24.64	24.38	24.61	0		
		1	24	25.02	24.76	24.99	0			1	12	25.00	24.74	24.97	0		
		1	49	24.90	24.64	24.87	0			1	24	24.88	24.62	24.85	0		
		25	0	23.95	23.69	23.92	1			12	0	23.93	23.67	23.90	1		
		25	12	24.05	23.79	24.02	1			12	6	24.03	23.77	24.00	1		
		25	25	24.00	23.74	23.97	1			12	13	23.98	23.72	23.95	1		
	50	0	24.02	23.76	23.99	1	25		0	24.00	23.74	23.97	1				
	16QAM	1	0	23.63	23.37	23.60	1		16QAM	1	0	23.61	23.35	23.58	1		
		1	24	23.99	23.73	23.96	1			1	12	23.97	23.71	23.94	1		
		1	49	23.87	23.61	23.84	1			1	24	23.85	23.59	23.82	1		
		25	0	22.92	22.66	22.89	2			12	0	22.90	22.64	22.87	2		
		25	12	23.02	22.76	22.99	2			12	6	23.00	22.74	22.97	2		
		25	25	22.97	22.71	22.94	2			12	13	22.95	22.69	22.92	2		
	50	0	22.99	22.73	22.96	2	25		0	22.97	22.71	22.94	2				
	64QAM	1	0	22.65	22.39	22.62	2		64QAM	1	0	22.63	22.37	22.60	2		
		1	24	23.01	22.75	22.98	2			1	12	22.99	22.73	22.96	2		
		1	49	22.89	22.63	22.86	2			1	24	22.87	22.61	22.84	2		
		25	0	21.94	21.68	21.91	3			12	0	21.92	21.66	21.89	3		
25		12	22.04	21.78	22.01	3	12	6		22.02	21.76	21.99	3				
25		25	21.99	21.73	21.96	3	12	13		21.97	21.71	21.94	3				
50	0	22.01	21.75	21.98	3	25	0	21.99	21.73	21.96	3						
3M	QPSK	1	0	24.68	24.42	24.65	0	1.4M	QPSK	1	0	24.62	24.36	24.59	0		
		1	7	25.04	24.78	25.01	0			1	2	24.98	24.72	24.95	0		
		1	14	24.92	24.66	24.89	0			1	5	24.86	24.60	24.83	0		
		8	0	23.97	23.71	23.94	1			3	0	24.54	24.28	24.51	0		
		8	3	24.07	23.81	24.04	1			3	1	24.64	24.38	24.61	0		
		8	7	24.02	23.76	23.99	1			3	3	24.59	24.33	24.56	0		
	15	0	24.04	23.78	24.01	1	6		0	23.98	23.72	23.95	1				
	16QAM	1	0	23.65	23.39	23.62	1		16QAM	1	0	23.59	23.33	23.56	1		
		1	7	24.01	23.75	23.98	1			1	2	23.95	23.69	23.92	1		
		1	14	23.89	23.63	23.86	1			1	5	23.83	23.57	23.80	1		
		8	0	22.94	22.68	22.91	2			3	0	23.51	23.25	23.48	1		
		8	3	23.04	22.78	23.01	2			3	1	23.61	23.35	23.58	1		
		8	7	22.99	22.73	22.96	2			3	3	23.56	23.30	23.53	1		
	15	0	23.01	22.75	22.98	2	6		0	22.95	22.69	22.92	2				
	64QAM	1	0	22.67	22.41	22.64	2		64QAM	1	0	22.61	22.35	22.58	2		
		1	7	23.03	22.77	23.00	2			1	2	22.97	22.71	22.94	2		
		1	14	22.91	22.65	22.88	2			1	5	22.85	22.59	22.82	2		
		8	0	21.96	21.70	21.93	3			3	0	22.53	22.27	22.50	2		
8		3	22.06	21.80	22.03	3	3	1		22.63	22.37	22.60	2				
8		7	22.01	21.75	21.98	3	3	3		22.58	22.32	22.55	2				
15	0	22.03	21.77	22.00	3	6	0	21.97	21.71	21.94	3						

EIRP Power (dBm)

GSM							
Plane	Channel	Frequency (MHz)	Reading (dBm)	Correction Factor (dB)	EIRP (dBm)	EIRP (mW)	Polarization (H/V)
X	512	1850.2	-8.98	36.57	27.59	574.12	H
	661	1880.0	-9.84	37.22	27.38	547.02	
	810	1909.8	-9.46	37.18	27.72	591.56	
	512	1850.2	-17.64	37.65	20.01	100.23	V
	661	1880.0	-17.80	37.58	19.78	95.06	
	810	1909.8	-17.23	37.48	20.25	105.93	

Note: EIRP (dBm) = Reading (dBm) + Correction Factor (dB)

EDGE							
Plane	Channel	Frequency (MHz)	Reading (dBm)	Correction Factor (dB)	EIRP (dBm)	EIRP (mW)	Polarization (H/V)
X	512	1850.2	-13.14	36.57	23.43	220.29	H
	661	1880.0	-13.97	37.22	23.25	211.35	
	810	1909.8	-13.47	37.18	23.71	234.96	
	512	1850.2	-20.30	37.65	17.35	54.33	V
	661	1880.0	-20.57	37.58	17.01	50.23	
	810	1909.8	-19.83	37.48	17.65	58.21	

Note: EIRP (dBm) = Reading (dBm) + Correction Factor (dB)

WCDMA							
Plane	Channel	Frequency (MHz)	Reading (dBm)	Correction Factor (dB)	EIRP (dBm)	EIRP (mW)	Polarization (H/V)
X	9262	1852.4	-14.64	36.57	21.93	155.96	H
	9400	1880.0	-15.37	37.22	21.85	153.11	
	9538	1907.6	-15.16	37.18	22.02	159.22	
	9262	1852.4	-19.22	37.65	18.43	69.66	V
	9400	1880.0	-19.33	37.58	18.25	66.83	
	9538	1907.6	-18.86	37.48	18.62	72.78	

Note: EIRP (dBm) = Reading (dBm) + Correction Factor (dB)

CDMA							
Plane	Channel	Frequency (MHz)	Reading (dBm)	Correction Factor (dB)	EIRP (dBm)	EIRP (mW)	Polarization (H/V)
X	25	1851.25	-14.99	36.57	21.58	143.88	H
	600	1880.00	-15.47	37.22	21.75	149.62	
	1175	1908.75	-15.26	37.18	21.92	155.60	
	25	1851.25	-22.54	37.65	15.11	32.43	V
	600	1880.00	-22.27	37.58	15.31	33.96	
	1175	1908.75	-21.96	37.48	15.52	35.65	

Note: EIRP (dBm) = Reading (dBm) + Correction Factor (dB)

LTE Band 2							
Channel Bandwidth: 1.4 MHz / QPSK							
Plane	Channel	Frequency (MHz)	Reading (dBm)	Correction Factor (dB)	EIRP (dBm)	EIRP (mW)	Polarization (H/V)
X	18607	1850.7	-16.31	36.57	20.26	106.17	H
	18900	1880.0	-16.83	37.22	20.39	109.40	
	19193	1909.3	-16.68	37.18	20.50	112.20	
	18607	1850.7	-22.77	37.65	14.88	30.76	V
	18900	1880.0	-22.43	37.58	15.15	32.73	
	19193	1909.3	-22.09	37.48	15.39	34.59	
Channel Bandwidth: 1.4 MHz / 16QAM							
X	18607	1850.7	-17.34	36.57	19.23	83.75	H
	18900	1880.0	-17.86	37.22	19.36	86.30	
	19193	1909.3	-17.71	37.18	19.47	88.51	
	18607	1850.7	-23.80	37.65	13.85	24.27	V
	18900	1880.0	-23.46	37.58	14.12	25.82	
	19193	1909.3	-23.12	37.48	14.36	27.29	
Channel Bandwidth: 1.4 MHz / 64QAM							
X	18607	1850.7	-18.35	36.57	18.22	66.37	H
	18900	1880.0	-18.87	37.22	18.35	68.39	
	19193	1909.3	-18.72	37.18	18.46	70.15	
	18607	1850.7	-24.81	37.65	12.84	19.23	V
	18900	1880.0	-24.47	37.58	13.11	20.46	
	19193	1909.3	-24.13	37.48	13.35	21.63	

Note: EIRP (dBm) = Reading (dBm) + Correction Factor (dB)

LTE Band 2							
Channel Bandwidth: 3 MHz / QPSK							
Plane	Channel	Frequency (MHz)	Reading (dBm)	Correction Factor (dB)	EIRP (dBm)	EIRP (mW)	Polarization (H/V)
X	18615	1851.5	-16.08	36.57	20.49	111.94	H
	18900	1880.0	-16.60	37.22	20.62	115.35	
	19185	1908.5	-16.45	37.18	20.73	118.30	
	18615	1851.5	-22.54	37.65	15.11	32.43	V
	18900	1880.0	-22.20	37.58	15.38	34.51	
	19185	1908.5	-21.86	37.48	15.62	36.48	
Channel Bandwidth: 3 MHz / 16QAM							
X	18615	1851.5	-17.12	36.57	19.45	88.10	H
	18900	1880.0	-17.64	37.22	19.58	90.78	
	19185	1908.5	-17.49	37.18	19.69	93.11	
	18615	1851.5	-23.58	37.65	14.07	25.53	V
	18900	1880.0	-23.24	37.58	14.34	27.16	
	19185	1908.5	-22.90	37.48	14.58	28.71	
Channel Bandwidth: 3 MHz / 64QAM							
X	18615	1851.5	-18.11	36.57	18.46	70.15	H
	18900	1880.0	-18.63	37.22	18.59	72.28	
	19185	1908.5	-18.48	37.18	18.70	74.13	
	18615	1851.5	-24.57	37.65	13.08	20.32	V
	18900	1880.0	-24.23	37.58	13.35	21.63	
	19185	1908.5	-23.89	37.48	13.59	22.86	

Note: EIRP (dBm) = Reading (dBm) + Correction Factor (dB)

LTE Band 2							
Channel Bandwidth: 5 MHz / QPSK							
Plane	Channel	Frequency (MHz)	Reading (dBm)	Correction Factor (dB)	EIRP (dBm)	EIRP (mW)	Polarization (H/V)
X	18625	1852.5	-15.84	36.57	20.73	118.30	H
	18900	1880.0	-16.36	37.22	20.86	121.90	
	19175	1907.5	-16.21	37.18	20.97	125.03	
	18625	1852.5	-22.30	37.65	15.35	34.28	V
	18900	1880.0	-21.96	37.58	15.62	36.48	
	19175	1907.5	-21.62	37.48	15.86	38.55	
Channel Bandwidth: 5 MHz / 16QAM							
X	18625	1852.5	-16.89	36.57	19.68	92.90	H
	18900	1880.0	-17.41	37.22	19.81	95.72	
	19175	1907.5	-17.26	37.18	19.92	98.17	
	18625	1852.5	-23.35	37.65	14.30	26.92	V
	18900	1880.0	-23.01	37.58	14.57	28.64	
	19175	1907.5	-22.67	37.48	14.81	30.27	
Channel Bandwidth: 5 MHz / 64QAM							
X	18625	1852.5	-17.88	36.57	18.69	73.96	H
	18900	1880.0	-18.40	37.22	18.82	76.21	
	19175	1907.5	-18.25	37.18	18.93	78.16	
	18625	1852.5	-24.34	37.65	13.31	21.43	V
	18900	1880.0	-24.00	37.58	13.58	22.80	
	19175	1907.5	-23.66	37.48	13.82	24.10	

Note: EIRP (dBm) = Reading (dBm) + Correction Factor (dB)

LTE Band 2							
Channel Bandwidth: 10 MHz / QPSK							
Plane	Channel	Frequency (MHz)	Reading (dBm)	Correction Factor (dB)	EIRP (dBm)	EIRP (mW)	Polarization (H/V)
X	18650	1855.0	-15.62	36.57	20.95	124.45	H
	18900	1880.0	-16.14	37.22	21.08	128.23	
	19150	1905.0	-15.99	37.18	21.19	131.52	
	18650	1855.0	-22.08	37.65	15.57	36.06	V
	18900	1880.0	-21.74	37.58	15.84	38.37	
	19150	1905.0	-21.40	37.48	16.08	40.55	
Channel Bandwidth: 10 MHz / 16QAM							
X	18650	1855.0	-16.65	36.57	19.92	98.17	H
	18900	1880.0	-17.17	37.22	20.05	101.16	
	19150	1905.0	-17.02	37.18	20.16	103.75	
	18650	1855.0	-23.11	37.65	14.54	28.44	V
	18900	1880.0	-22.77	37.58	14.81	30.27	
	19150	1905.0	-22.43	37.48	15.05	31.99	
Channel Bandwidth: 10 MHz / 64QAM							
X	18650	1855.0	-17.63	36.57	18.94	78.34	H
	18900	1880.0	-18.15	37.22	19.07	80.72	
	19150	1905.0	-18.00	37.18	19.18	82.79	
	18650	1855.0	-24.09	37.65	13.56	22.70	V
	18900	1880.0	-23.75	37.58	13.83	24.15	
	19150	1905.0	-23.41	37.48	14.07	25.53	

Note: EIRP (dBm) = Reading (dBm) + Correction Factor (dB)

LTE Band 2							
Channel Bandwidth: 15 MHz / QPSK							
Plane	Channel	Frequency (MHz)	Reading (dBm)	Correction Factor (dB)	EIRP (dBm)	EIRP (mW)	Polarization (H/V)
X	18675	1857.5	-15.39	36.57	21.18	131.22	H
	18900	1880.0	-15.91	37.22	21.31	135.21	
	19125	1902.5	-15.76	37.18	21.42	138.68	
	18675	1857.5	-21.85	37.65	15.80	38.02	V
	18900	1880.0	-21.51	37.58	16.07	40.46	
	19125	1902.5	-21.17	37.48	16.31	42.76	
Channel Bandwidth: 15 MHz / 16QAM							
X	18675	1857.5	-16.43	36.57	20.14	103.28	H
	18900	1880.0	-16.95	37.22	20.27	106.41	
	19125	1902.5	-16.80	37.18	20.38	109.14	
	18675	1857.5	-22.89	37.65	14.76	29.92	V
	18900	1880.0	-22.55	37.58	15.03	31.84	
	19125	1902.5	-22.21	37.48	15.27	33.65	
Channel Bandwidth: 15 MHz / 64QAM							
X	18675	1857.5	-17.40	36.57	19.17	82.60	H
	18900	1880.0	-17.92	37.22	19.30	85.11	
	19125	1902.5	-17.77	37.18	19.41	87.30	
	18675	1857.5	-23.86	37.65	13.79	23.93	V
	18900	1880.0	-23.52	37.58	14.06	25.47	
	19125	1902.5	-23.18	37.48	14.30	26.92	

Note: EIRP (dBm) = Reading (dBm) + Correction Factor (dB)

LTE Band 2							
Channel Bandwidth: 20 MHz / QPSK							
Plane	Channel	Frequency (MHz)	Reading (dBm)	Correction Factor (dB)	EIRP (dBm)	EIRP (mW)	Polarization (H/V)
X	18700	1860.0	-15.18	36.57	21.39	137.72	H
	18900	1880.0	-15.70	37.22	21.52	141.91	
	19100	1900.0	-15.55	37.18	21.63	145.55	
	18700	1860.0	-21.64	37.65	16.01	39.90	V
	18900	1880.0	-21.30	37.58	16.28	42.46	
	19100	1900.0	-20.96	37.48	16.52	44.87	
Channel Bandwidth: 20 MHz / 16QAM							
X	18700	1860.0	-16.20	36.57	20.37	108.89	H
	18900	1880.0	-16.72	37.22	20.50	112.20	
	19100	1900.0	-16.57	37.18	20.61	115.08	
	18700	1860.0	-22.66	37.65	14.99	31.55	V
	18900	1880.0	-22.32	37.58	15.26	33.57	
	19100	1900.0	-21.98	37.48	15.50	35.48	
Channel Bandwidth: 20 MHz / 64QAM							
X	18700	1860.0	-17.19	36.57	19.38	86.70	H
	18900	1880.0	-17.71	37.22	19.51	89.33	
	19100	1900.0	-17.56	37.18	19.62	91.62	
	18700	1860.0	-23.65	37.65	14.00	25.12	V
	18900	1880.0	-23.31	37.58	14.27	26.73	
	19100	1900.0	-22.97	37.48	14.51	28.25	

Note: EIRP (dBm) = Reading (dBm) + Correction Factor (dB)

LTE Band 25							
Channel Bandwidth: 1.4 MHz / QPSK							
Plane	Channel	Frequency (MHz)	Reading (dBm)	Correction Factor (dB)	EIRP (dBm)	EIRP (mW)	Polarization (H/V)
X	26047	1850.7	-15.07	36.57	21.50	141.25	H
	26365	1882.5	-16.20	37.22	21.02	126.47	
	26683	1914.3	-17.94	39.09	21.15	130.32	
	26047	1850.7	-20.36	37.65	17.29	53.58	V
	26365	1882.5	-20.86	37.58	16.72	46.99	
	26683	1914.3	-20.92	37.92	17.00	50.12	
Channel Bandwidth: 1.4 MHz / 16QAM							
X	26047	1850.7	-16.11	36.57	20.46	111.17	H
	26365	1882.5	-17.24	37.22	19.98	99.54	
	26683	1914.3	-18.98	39.09	20.11	102.57	
	26047	1850.7	-21.40	37.65	16.25	42.17	V
	26365	1882.5	-21.90	37.58	15.68	36.98	
	26683	1914.3	-21.96	37.92	15.96	39.45	
Channel Bandwidth: 1.4 MHz / 64QAM							
X	26047	1850.7	-17.17	36.57	19.40	87.10	H
	26365	1882.5	-18.30	37.22	18.92	77.98	
	26683	1914.3	-20.04	39.09	19.05	80.35	
	26047	1850.7	-22.46	37.65	15.19	33.04	V
	26365	1882.5	-22.96	37.58	14.62	28.97	
	26683	1914.3	-23.02	37.92	14.90	30.90	

Note: EIRP (dBm) = Reading (dBm) + Correction Factor (dB)

LTE Band 25							
Channel Bandwidth: 3 MHz / QPSK							
Plane	Channel	Frequency (MHz)	Reading (dBm)	Correction Factor (dB)	EIRP (dBm)	EIRP (mW)	Polarization (H/V)
X	26055	1851.5	-14.84	36.57	21.73	148.94	H
	26365	1882.5	-15.97	37.22	21.25	133.35	
	26675	1913.5	-17.73	39.11	21.38	137.40	
	26055	1851.5	-20.13	37.65	17.52	56.49	V
	26365	1882.5	-20.63	37.58	16.95	49.55	
	26675	1913.5	-20.70	37.93	17.23	52.84	
Channel Bandwidth: 3 MHz / 16QAM							
X	26055	1851.5	-15.87	36.57	20.70	117.49	H
	26365	1882.5	-17.00	37.22	20.22	105.20	
	26675	1913.5	-18.76	39.11	20.35	108.39	
	26055	1851.5	-21.16	37.65	16.49	44.57	V
	26365	1882.5	-21.66	37.58	15.92	39.08	
	26675	1913.5	-21.73	37.93	16.20	41.69	
Channel Bandwidth: 3 MHz / 64QAM							
X	26055	1851.5	-16.92	36.57	19.65	92.26	H
	26365	1882.5	-18.05	37.22	19.17	82.60	
	26675	1913.5	-19.81	39.11	19.30	85.11	
	26055	1851.5	-22.21	37.65	15.44	34.99	V
	26365	1882.5	-22.71	37.58	14.87	30.69	
	26675	1913.5	-22.78	37.93	15.15	32.73	

Note: EIRP (dBm) = Reading (dBm) + Correction Factor (dB)

LTE Band 25							
Channel Bandwidth: 5 MHz / QPSK							
Plane	Channel	Frequency (MHz)	Reading (dBm)	Correction Factor (dB)	EIRP (dBm)	EIRP (mW)	Polarization (H/V)
X	26065	1852.5	-14.60	36.57	21.97	157.40	H
	26365	1882.5	-15.73	37.22	21.49	140.93	
	26665	1912.5	-16.49	38.11	21.62	145.21	
	26065	1852.5	-19.89	37.65	17.76	59.70	V
	26365	1882.5	-20.39	37.58	17.19	52.36	
	26665	1912.5	-20.49	37.96	17.47	55.85	
Channel Bandwidth: 5 MHz / 16QAM							
X	26065	1852.5	-15.64	36.57	20.93	123.88	H
	26365	1882.5	-16.77	37.22	20.45	110.92	
	26665	1912.5	-17.53	38.11	20.58	114.29	
	26065	1852.5	-20.93	37.65	16.72	46.99	V
	26365	1882.5	-21.43	37.58	16.15	41.21	
	26665	1912.5	-21.53	37.96	16.43	43.95	
Channel Bandwidth: 5 MHz / 64QAM							
X	26065	1852.5	-16.68	36.57	19.89	97.50	H
	26365	1882.5	-17.81	37.22	19.41	87.30	
	26665	1912.5	-18.57	38.11	19.54	89.95	
	26065	1852.5	-21.97	37.65	15.68	36.98	V
	26365	1882.5	-22.47	37.58	15.11	32.43	
	26665	1912.5	-22.57	37.96	15.39	34.59	

Note: EIRP (dBm) = Reading (dBm) + Correction Factor (dB)

LTE Band 25							
Channel Bandwidth: 10 MHz / QPSK							
Plane	Channel	Frequency (MHz)	Reading (dBm)	Correction Factor (dB)	EIRP (dBm)	EIRP (mW)	Polarization (H/V)
X	26090	1855.0	-14.37	36.57	22.20	165.96	H
	26365	1882.5	-15.50	37.22	21.72	148.59	
	26640	1910.0	-16.34	38.19	21.85	153.11	
	26090	1855.0	-19.66	37.65	17.99	62.95	V
	26365	1882.5	-20.16	37.58	17.42	55.21	
	26640	1910.0	-20.45	38.15	17.70	58.88	
Channel Bandwidth: 10 MHz / 16QAM							
X	26090	1855.0	-15.42	36.57	21.15	130.32	H
	26365	1882.5	-16.55	37.22	20.67	116.68	
	26640	1910.0	-17.39	38.19	20.80	120.23	
	26090	1855.0	-20.71	37.65	16.94	49.43	V
	26365	1882.5	-21.21	37.58	16.37	43.35	
	26640	1910.0	-21.50	38.15	16.65	46.24	
Channel Bandwidth: 10 MHz / 64QAM							
X	26090	1855.0	-16.46	36.57	20.11	102.57	H
	26365	1882.5	-17.59	37.22	19.63	91.83	
	26640	1910.0	-18.43	38.19	19.76	94.62	
	26090	1855.0	-21.75	37.65	15.90	38.90	V
	26365	1882.5	-22.25	37.58	15.33	34.12	
	26640	1910.0	-22.54	38.15	15.61	36.39	

Note: EIRP (dBm) = Reading (dBm) + Correction Factor (dB)

LTE Band 25							
Channel Bandwidth: 15 MHz / QPSK							
Plane	Channel	Frequency (MHz)	Reading (dBm)	Correction Factor (dB)	EIRP (dBm)	EIRP (mW)	Polarization (H/V)
X	26115	1857.5	-14.15	36.57	22.42	174.58	H
	26365	1882.5	-15.28	37.22	21.94	156.31	
	26615	1907.5	-16.16	38.23	22.07	161.06	
	26115	1857.5	-19.44	37.65	18.21	66.22	V
	26365	1882.5	-19.94	37.58	17.64	58.08	
	26615	1907.5	-20.30	38.22	17.92	61.94	
Channel Bandwidth: 15 MHz / 16QAM							
X	26115	1857.5	-15.18	36.57	21.39	137.72	H
	26365	1882.5	-16.31	37.22	20.91	123.31	
	26615	1907.5	-17.19	38.23	21.04	127.06	
	26115	1857.5	-20.47	37.65	17.18	52.24	V
	26365	1882.5	-20.97	37.58	16.61	45.81	
	26615	1907.5	-21.33	38.22	16.89	48.87	
Channel Bandwidth: 15 MHz / 64QAM							
X	26115	1857.5	-16.23	36.57	20.34	108.14	H
	26365	1882.5	-17.36	37.22	19.86	96.83	
	26615	1907.5	-18.24	38.23	19.99	99.77	
	26115	1857.5	-21.52	37.65	16.13	41.02	V
	26365	1882.5	-22.02	37.58	15.56	35.97	
	26615	1907.5	-22.38	38.22	15.84	38.37	

Note: EIRP (dBm) = Reading (dBm) + Correction Factor (dB)

LTE Band 25							
Channel Bandwidth: 20 MHz / QPSK							
Plane	Channel	Frequency (MHz)	Reading (dBm)	Correction Factor (dB)	EIRP (dBm)	EIRP (mW)	Polarization (H/V)
X	26140	1860.0	-13.94	36.57	22.63	183.23	H
	26365	1882.5	-15.07	37.22	22.15	164.06	
	26590	1905.0	-16.44	38.72	22.28	169.04	
	26140	1860.0	-19.23	37.65	18.42	69.50	V
	26365	1882.5	-19.73	37.58	17.85	60.95	
	26590	1905.0	-19.43	37.56	18.13	65.01	
Channel Bandwidth: 20 MHz / 16QAM							
X	26140	1860.0	-14.95	36.57	21.62	145.21	H
	26365	1882.5	-16.08	37.22	21.14	130.02	
	26590	1905.0	-17.45	38.72	21.27	133.97	
	26140	1860.0	-20.24	37.65	17.41	55.08	V
	26365	1882.5	-20.74	37.58	16.84	48.31	
	26590	1905.0	-20.44	37.56	17.12	51.52	
Channel Bandwidth: 20 MHz / 64QAM							
X	26140	1860.0	-16.00	36.57	20.57	114.02	H
	26365	1882.5	-17.13	37.22	20.09	102.09	
	26590	1905.0	-18.50	38.72	20.22	105.20	
	26140	1860.0	-21.29	37.65	16.36	43.25	V
	26365	1882.5	-21.79	37.58	15.79	37.93	
	26590	1905.0	-21.49	37.56	16.07	40.46	

Note: EIRP (dBm) = Reading (dBm) + Correction Factor (dB)

4.2 Modulation Characteristics Measurement

4.2.1 Limits of Modulation Characteristics

N/A

4.2.2 Test Setup



4.2.3 Test Procedure

Connect the EUT to Communication Simulator via the antenna connector. The frequency band is set as EUT supported Modulation and Channels, the EUT output is matched with 50 ohm load, the waveform quality and constellation of the EUT was tested.

4.2.4 Test Results

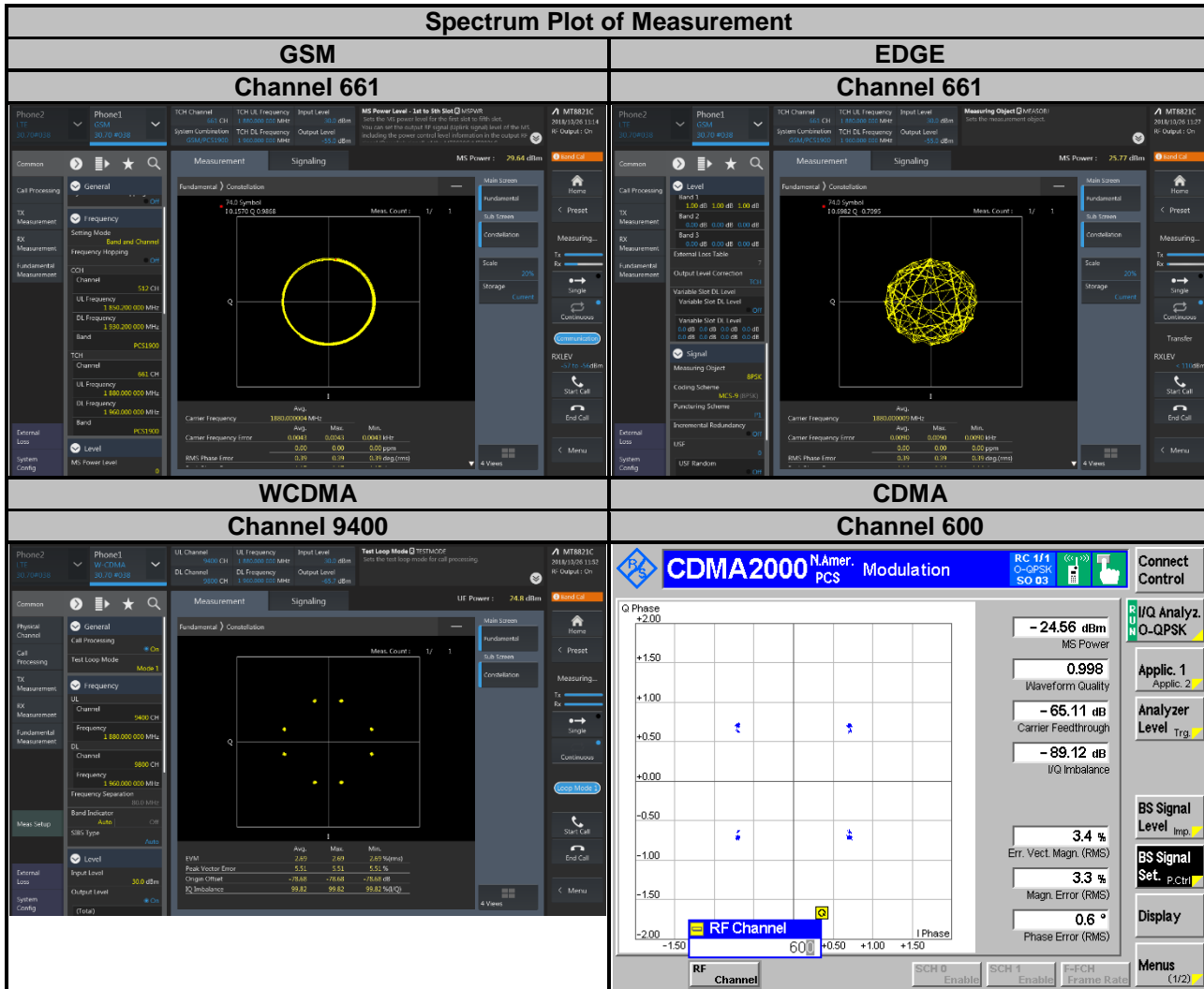

Spectrum Plot of Measurement

LTE Band 2

Channel 18900

QPSK

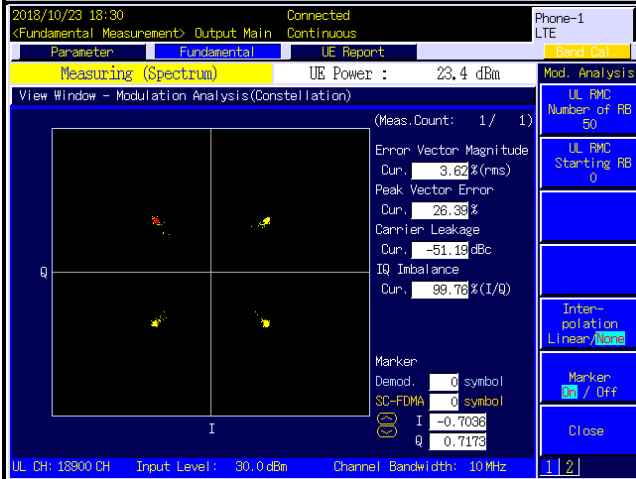

16QAM

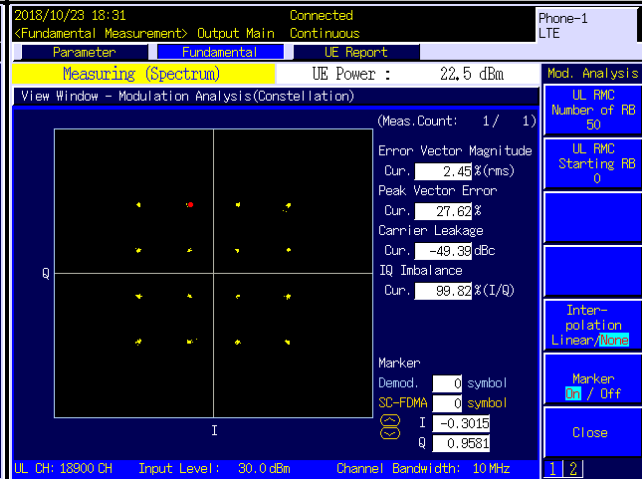

64QAM

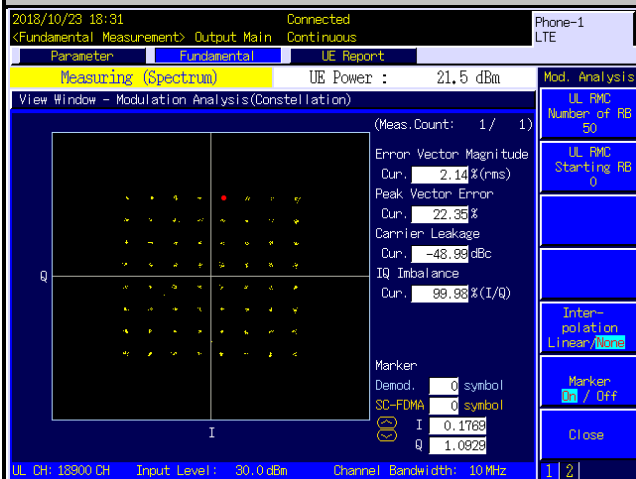

Spectrum Plot of Measurement
LTE Band 25
Channel 26140

QPSK

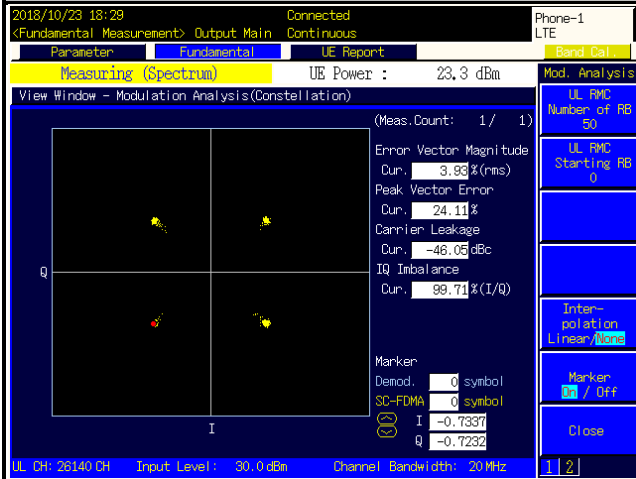

16QAM

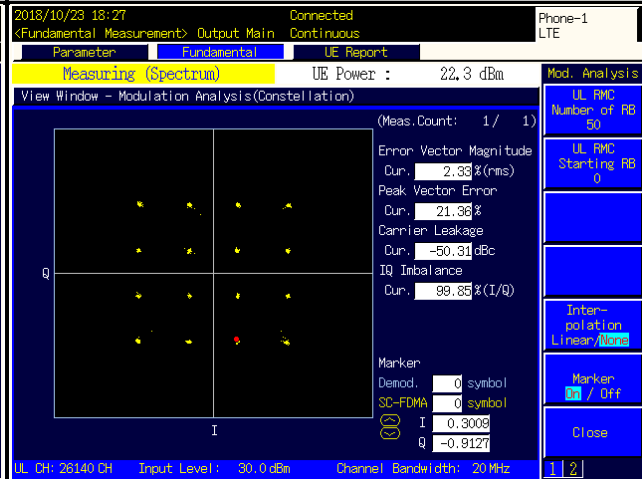

64QAM

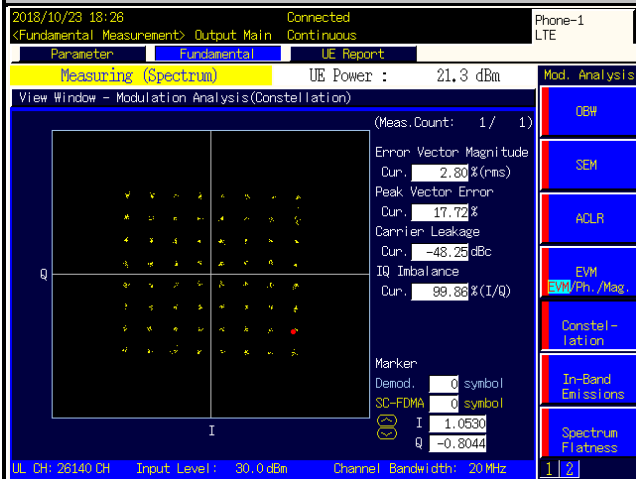

4.3 Frequency Stability Measurement

4.3.1 Limits of Frequency Stability Measurement

The frequency stability shall be sufficient to ensure that the fundamental emission stays within the authorized frequency block.

4.3.2 Test Procedure

- Device is placed at the oven room. The oven room could control the temperatures and humidity. Power warm up is at least 15 min and power applied should perform before recording frequency error.
- EUT is connected the external power supply to control the DC input power. The test voltage range is from minimum to maximum working voltage. Each step shall be record the frequency error rate.
- The temperature range step is 10 degrees in this test items. All temperature levels shall be hold the ± 0.5 °C during the measurement testing. The each temperature step shall be at least 0.5 hours, consider the EUT could be test under the stability condition.

NOTE: The frequency error was recorded frequency error from the communication simulator.

4.3.3 Test Setup

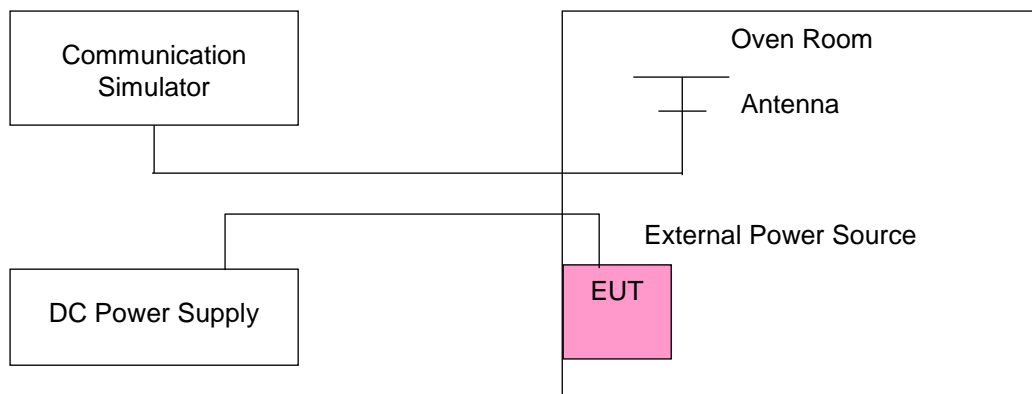

4.3.4 Test Results

Frequency Error vs. Voltage

Voltage (Volts)	GSM			
	Low Channel		High Channel	
	Frequency (MHz)	Frequency Error (ppm)	Frequency (MHz)	Frequency Error (ppm)
3.85	1850.200002	0.001	1909.800001	0.001
3.6	1850.200004	0.002	1909.800001	0.001
4.4	1850.200003	0.002	1909.800002	0.001

Note: The applicant defined the normal working voltage of the battery is from 3.6 Vdc to 4.4 Vdc.

Frequency Error vs. Temperature

Temp. (°C)	GSM			
	Low Channel		High Channel	
	Frequency (MHz)	Frequency Error (ppm)	Frequency (MHz)	Frequency Error (ppm)
-30	1850.200002	0.001	1909.800002	0.001
-20	1850.200004	0.002	1909.800002	0.001
-10	1850.200003	0.002	1909.800003	0.002
0	1850.200003	0.002	1909.800002	0.001
10	1850.200002	0.001	1909.800001	0.001
20	1850.199999	-0.001	1909.799998	-0.001
30	1850.199998	-0.001	1909.799997	-0.002
40	1850.199998	-0.001	1909.799997	-0.002
50	1850.199996	-0.002	1909.799998	-0.001
55	1850.199998	-0.001	1909.799997	-0.002

Frequency Error vs. Voltage

Voltage (Volts)	EDGE			
	Low Channel		High Channel	
	Frequency (MHz)	Frequency Error (ppm)	Frequency (MHz)	Frequency Error (ppm)
3.85	1850.200002	0.001	1909.800002	0.001
3.6	1850.200001	0.001	1909.800003	0.002
4.4	1850.200003	0.002	1909.800002	0.001

Note: The applicant defined the normal working voltage of the battery is from 3.6 Vdc to 4.4 Vdc.

Frequency Error vs. Temperature

Temp. (°C)	EDGE			
	Low Channel		High Channel	
	Frequency (MHz)	Frequency Error (ppm)	Frequency (MHz)	Frequency Error (ppm)
-30	1850.200001	0.001	1909.800002	0.001
-20	1850.200003	0.002	1909.800004	0.002
-10	1850.200001	0.001	1909.800002	0.001
0	1850.200001	0.001	1909.800003	0.001
10	1850.200003	0.002	1909.800003	0.002
20	1850.199997	-0.002	1909.799999	-0.001
30	1850.199999	-0.001	1909.799999	-0.001
40	1850.199997	-0.002	1909.799999	-0.001
50	1850.199997	-0.002	1909.799998	-0.001
55	1850.199997	-0.002	1909.799998	-0.001

Frequency Error vs. Voltage

Voltage (Volts)	WCDMA			
	Low Channel		High Channel	
	Frequency (MHz)	Frequency Error (ppm)	Frequency (MHz)	Frequency Error (ppm)
3.85	1852.400003	0.002	1907.600002	0.001
3.6	1852.400001	0.001	1907.600004	0.002
4.4	1852.400004	0.002	1907.600002	0.001

Note: The applicant defined the normal working voltage of the battery is from 3.6 Vdc to 4.4 Vdc.

Frequency Error vs. Temperature

Temp. (°C)	WCDMA			
	Low Channel		High Channel	
	Frequency (MHz)	Frequency Error (ppm)	Frequency (MHz)	Frequency Error (ppm)
-30	1852.400002	0.001	1907.600002	0.001
-20	1852.400001	0.001	1907.600002	0.001
-10	1852.400002	0.001	1907.600003	0.002
0	1852.400001	0.001	1907.600004	0.002
10	1852.400004	0.002	1907.600004	0.002
20	1852.399996	-0.002	1907.599999	-0.001
30	1852.399998	-0.001	1907.599997	-0.002
40	1852.399998	-0.001	1907.599997	-0.001
50	1852.399998	-0.001	1907.599997	-0.001
55	1852.399999	-0.001	1907.599997	-0.002

Frequency Error vs. Voltage

Voltage (Volts)	CDMA			
	Low Channel		High Channel	
	Frequency (MHz)	Frequency Error (ppm)	Frequency (MHz)	Frequency Error (ppm)
3.85	1851.250002	0.001	1908.750004	0.002
3.6	1851.250002	0.001	1908.750002	0.001
4.4	1851.250004	0.002	1908.750001	0.001

Note: The applicant defined the normal working voltage of the battery is from 3.6 Vdc to 4.4 Vdc.

Frequency Error vs. Temperature

Temp. (°C)	CDMA			
	Low Channel		High Channel	
	Frequency (MHz)	Frequency Error (ppm)	Frequency (MHz)	Frequency Error (ppm)
-30	1851.250002	0.001	1908.750003	0.002
-20	1851.250002	0.001	1908.750004	0.002
-10	1851.250003	0.002	1908.750001	0.001
0	1851.250001	0.001	1908.750002	0.001
10	1851.250003	0.002	1908.750004	0.002
20	1851.249998	-0.001	1908.749999	-0.001
30	1851.249998	-0.001	1908.749998	-0.001
40	1851.249997	-0.002	1908.749999	-0.001
50	1851.249997	-0.002	1908.749998	-0.001
55	1851.249998	-0.001	1908.749997	-0.001

Frequency Error vs. Voltage

Voltage (Volts)	LTE Band 2			
	Channel Bandwidth: 1.4 MHz			
	Low Channel		High Channel	
	Frequency (MHz)	Frequency Error (ppm)	Frequency (MHz)	Frequency Error (ppm)
3.85	1850.700001	0.001	1909.300000	0.002
3.6	1850.700001	0.001	1909.300002	0.001
4.4	1850.700001	0.001	1909.300004	0.002

Note: The applicant defined the normal working voltage of the battery is from 3.6 Vdc to 4.4 Vdc.

Frequency Error vs. Temperature

Temp. (°C)	LTE Band 2			
	Channel Bandwidth: 1.4 MHz			
	Low Channel		High Channel	
	Frequency (MHz)	Frequency Error (ppm)	Frequency (MHz)	Frequency Error (ppm)
-30	1850.700003	0.001	1909.300001	0.001
-20	1850.700002	0.001	1909.300004	0.002
-10	1850.700002	0.001	1909.300004	0.002
0	1850.700003	0.002	1909.300002	0.001
10	1850.700003	0.002	1909.300003	0.001
20	1850.699999	-0.001	1909.299999	-0.001
30	1850.699999	-0.001	1909.299999	-0.001
40	1850.699998	-0.001	1909.299997	-0.002
50	1850.699997	-0.002	1909.299999	-0.001
55	1850.699999	-0.001	1909.299999	-0.001

Frequency Error vs. Voltage

Voltage (Volts)	LTE Band 2			
	Channel Bandwidth: 3 MHz			
	Low Channel		High Channel	
	Frequency (MHz)	Frequency Error (ppm)	Frequency (MHz)	Frequency Error (ppm)
3.85	1851.500002	0.001	1907.500002	0.001
3.6	1851.500003	0.002	1907.500001	0.001
4.4	1851.500002	0.001	1907.500002	0.001

Note: The applicant defined the normal working voltage of the battery is from 3.6 Vdc to 4.4 Vdc.

Frequency Error vs. Temperature

Temp. (°C)	LTE Band 2			
	Channel Bandwidth: 3 MHz			
	Low Channel		High Channel	
	Frequency (MHz)	Frequency Error (ppm)	Frequency (MHz)	Frequency Error (ppm)
-30	1851.500002	0.001	1907.500004	0.002
-20	1851.500003	0.002	1907.500002	0.001
-10	1851.500002	0.001	1907.500001	0.001
0	1851.500004	0.002	1907.500003	0.002
10	1851.500003	0.001	1907.500001	0.001
20	1851.499998	-0.001	1907.499998	-0.001
30	1851.499997	-0.002	1907.499999	-0.001
40	1851.499999	-0.001	1907.499997	-0.001
50	1851.499996	-0.002	1907.499997	-0.002
55	1851.499999	-0.001	1907.499997	-0.002

Frequency Error vs. Voltage

Voltage (Volts)	LTE Band 2			
	Channel Bandwidth: 5 MHz			
	Low Channel		High Channel	
	Frequency (MHz)	Frequency Error (ppm)	Frequency (MHz)	Frequency Error (ppm)
3.85	1852.500003	0.001	1907.500003	0.001
3.6	1852.500002	0.001	1907.500004	0.002
4.4	1852.500002	0.001	1907.500001	0.001

Note: The applicant defined the normal working voltage of the battery is from 3.6 Vdc to 4.4 Vdc.

Frequency Error vs. Temperature

Temp. (°C)	LTE Band 2			
	Channel Bandwidth: 5 MHz			
	Low Channel		High Channel	
	Frequency (MHz)	Frequency Error (ppm)	Frequency (MHz)	Frequency Error (ppm)
-30	1852.500003	0.001	1907.500001	0.001
-20	1852.500002	0.001	1907.500001	0.001
-10	1852.500001	0.001	1907.500004	0.002
0	1852.500003	0.002	1907.500002	0.001
10	1852.500003	0.001	1907.500003	0.001
20	1852.499997	-0.002	1907.499999	-0.001
30	1852.499998	-0.001	1907.499997	-0.002
40	1852.499999	-0.001	1907.499997	-0.002
50	1852.499999	-0.001	1907.499997	-0.002
55	1852.499998	-0.001	1907.499996	-0.002

Frequency Error vs. Voltage

Voltage (Volts)	LTE Band 2			
	Channel Bandwidth: 10 MHz			
	Low Channel		High Channel	
	Frequency (MHz)	Frequency Error (ppm)	Frequency (MHz)	Frequency Error (ppm)
3.85	1855.000002	0.001	1905.000001	0.001
3.6	1855.000003	0.001	1905.000002	0.001
4.4	1855.000002	0.001	1905.000004	0.002

Note: The applicant defined the normal working voltage of the battery is from 3.6 Vdc to 4.4 Vdc.

Frequency Error vs. Temperature

Temp. (°C)	LTE Band 2			
	Channel Bandwidth: 10 MHz			
	Low Channel		High Channel	
	Frequency (MHz)	Frequency Error (ppm)	Frequency (MHz)	Frequency Error (ppm)
-30	1855.000004	0.002	1905.000004	0.002
-20	1855.000002	0.001	1905.000004	0.002
-10	1855.000002	0.001	1905.000002	0.001
0	1855.000002	0.001	1905.000001	0.001
10	1855.000001	0.001	1905.000001	0.001
20	1854.999996	-0.002	1904.999997	-0.002
30	1854.999998	-0.001	1904.999997	-0.001
40	1854.999999	-0.001	1904.999998	-0.001
50	1854.999996	-0.002	1904.999997	-0.001
55	1854.999997	-0.002	1904.999998	-0.001

Frequency Error vs. Voltage

Voltage (Volts)	LTE Band 2			
	Channel Bandwidth: 15 MHz			
	Low Channel		High Channel	
	Frequency (MHz)	Frequency Error (ppm)	Frequency (MHz)	Frequency Error (ppm)
3.85	1857.500001	0.001	1902.500003	0.002
3.6	1857.500003	0.002	1902.500001	0.001
4.4	1857.500002	0.001	1902.500004	0.002

Note: The applicant defined the normal working voltage of the battery is from 3.6 Vdc to 4.4 Vdc.

Frequency Error vs. Temperature

Temp. (°C)	LTE Band 2			
	Channel Bandwidth: 15 MHz			
	Low Channel		High Channel	
	Frequency (MHz)	Frequency Error (ppm)	Frequency (MHz)	Frequency Error (ppm)
-30	1857.500001	0.001	1902.500004	0.002
-20	1857.500002	0.001	1902.500003	0.001
-10	1857.500003	0.002	1902.500004	0.002
0	1857.500003	0.002	1902.500003	0.001
10	1857.500004	0.002	1902.500002	0.001
20	1857.499996	-0.002	1902.499998	-0.001
30	1857.499996	-0.002	1902.499998	-0.001
40	1857.499996	-0.002	1902.499998	-0.001
50	1857.499998	-0.001	1902.499998	-0.001
55	1857.499996	-0.002	1902.499997	-0.002

Frequency Error vs. Voltage

Voltage (Volts)	LTE Band 2			
	Channel Bandwidth: 20 MHz			
	Low Channel		High Channel	
	Frequency (MHz)	Frequency Error (ppm)	Frequency (MHz)	Frequency Error (ppm)
3.85	1860.000001	0.001	1900.000003	0.002
3.6	1860.000002	0.001	1900.000003	0.002
4.4	1860.000002	0.001	1900.000004	0.002

Note: The applicant defined the normal working voltage of the battery is from 3.6 Vdc to 4.4 Vdc.

Frequency Error vs. Temperature

Temp. (°C)	LTE Band 2			
	Channel Bandwidth: 20 MHz			
	Low Channel		High Channel	
	Frequency (MHz)	Frequency Error (ppm)	Frequency (MHz)	Frequency Error (ppm)
-30	1860.000002	0.001	1900.000002	0.001
-20	1860.000001	0.001	1900.000002	0.001
-10	1860.000004	0.002	1900.000002	0.001
0	1860.000001	0.001	1900.000002	0.001
10	1860.000002	0.001	1900.000003	0.001
20	1859.999997	-0.001	1899.999996	-0.002
30	1859.999996	-0.002	1899.999997	-0.001
40	1859.999997	-0.001	1899.999997	-0.001
50	1859.999997	-0.002	1899.999997	-0.002
55	1859.999997	-0.002	1899.999998	-0.001

Frequency Error vs. Voltage

Voltage (Volts)	LTE Band 25			
	Channel Bandwidth: 1.4 MHz			
	Low Channel		High Channel	
	Frequency (MHz)	Frequency Error (ppm)	Frequency (MHz)	Frequency Error (ppm)
3.85	1850.700002	0.001	1914.300003	0.001
3.6	1850.700002	0.001	1914.300001	0.001
4.4	1850.700003	0.002	1914.300001	0.001

Note: The applicant defined the normal working voltage of the battery is from 3.6 Vdc to 4.4 Vdc.

Frequency Error vs. Temperature

Temp. (°C)	LTE Band 25			
	Channel Bandwidth: 1.4 MHz			
	Low Channel		High Channel	
	Frequency (MHz)	Frequency Error (ppm)	Frequency (MHz)	Frequency Error (ppm)
-30	1850.700003	0.002	1914.300001	0.001
-20	1850.700003	0.001	1914.300003	0.002
-10	1850.700001	0.001	1914.300004	0.002
0	1850.700003	0.002	1914.300004	0.002
10	1850.700004	0.002	1914.300001	0.001
20	1850.699999	-0.001	1914.299998	-0.001
30	1850.699997	-0.002	1914.299997	-0.002
40	1850.699997	-0.002	1914.299997	-0.002
50	1850.699996	-0.002	1914.299998	-0.001
55	1850.699996	-0.002	1914.299998	-0.001

Frequency Error vs. Voltage

Voltage (Volts)	LTE Band 25			
	Channel Bandwidth: 3 MHz			
	Low Channel		High Channel	
	Frequency (MHz)	Frequency Error (ppm)	Frequency (MHz)	Frequency Error (ppm)
3.85	1851.500003	0.002	1913.500004	0.002
3.6	1851.500004	0.002	1913.500003	0.001
4.4	1851.500002	0.001	1913.500002	0.001

Note: The applicant defined the normal working voltage of the battery is from 3.6 Vdc to 4.4 Vdc.

Frequency Error vs. Temperature

Temp. (°C)	LTE Band 25			
	Channel Bandwidth: 3 MHz			
	Low Channel		High Channel	
	Frequency (MHz)	Frequency Error (ppm)	Frequency (MHz)	Frequency Error (ppm)
-30	1851.500002	0.001	1913.500003	0.002
-20	1851.500003	0.001	1913.500003	0.001
-10	1851.500003	0.002	1913.500002	0.001
0	1851.500004	0.002	1913.500001	0.001
10	1851.500002	0.001	1913.500002	0.001
20	1851.499998	-0.001	1913.499998	-0.001
30	1851.499996	-0.002	1913.499999	-0.001
40	1851.499998	-0.001	1913.499998	-0.001
50	1851.499998	-0.001	1913.499996	-0.002
55	1851.499998	-0.001	1913.499997	-0.002

Frequency Error vs. Voltage

Voltage (Volts)	LTE Band 25			
	Channel Bandwidth: 5 MHz			
	Low Channel		High Channel	
	Frequency (MHz)	Frequency Error (ppm)	Frequency (MHz)	Frequency Error (ppm)
3.85	1852.500003	0.002	1912.500001	0.001
3.6	1852.500001	0.001	1912.500003	0.001
4.4	1852.500003	0.002	1912.500004	0.002

Note: The applicant defined the normal working voltage of the battery is from 3.6 Vdc to 4.4 Vdc.

Frequency Error vs. Temperature

Temp. (°C)	LTE Band 25			
	Channel Bandwidth: 5 MHz			
	Low Channel		High Channel	
	Frequency (MHz)	Frequency Error (ppm)	Frequency (MHz)	Frequency Error (ppm)
-30	1852.500004	0.002	1912.500001	0.001
-20	1852.500003	0.001	1912.500001	0.001
-10	1852.500004	0.002	1912.500001	0.001
0	1852.500003	0.001	1912.500003	0.002
10	1852.500004	0.002	1912.500003	0.002
20	1852.499996	-0.002	1912.499998	-0.001
30	1852.499998	-0.001	1912.499997	-0.002
40	1852.499998	-0.001	1912.499998	-0.001
50	1852.499997	-0.002	1912.499996	-0.002
55	1852.499997	-0.001	1912.499997	-0.001

Frequency Error vs. Voltage

Voltage (Volts)	LTE Band 25			
	Channel Bandwidth: 10 MHz			
	Low Channel		High Channel	
	Frequency (MHz)	Frequency Error (ppm)	Frequency (MHz)	Frequency Error (ppm)
3.85	1855.000002	0.001	1910.000002	0.001
3.6	1855.000003	0.002	1910.000002	0.001
4.4	1855.000003	0.002	1910.000003	0.002

Note: The applicant defined the normal working voltage of the battery is from 3.6 Vdc to 4.4 Vdc.

Frequency Error vs. Temperature

Temp. (°C)	LTE Band 25			
	Channel Bandwidth: 10 MHz			
	Low Channel		High Channel	
	Frequency (MHz)	Frequency Error (ppm)	Frequency (MHz)	Frequency Error (ppm)
-30	1855.000002	0.001	1910.000002	0.001
-20	1855.000004	0.002	1910.000003	0.002
-10	1855.000004	0.002	1910.000003	0.001
0	1855.000001	0.001	1910.000004	0.002
10	1855.000003	0.002	1910.000003	0.002
20	1854.999998	-0.001	1909.999998	-0.001
30	1854.999997	-0.002	1909.999996	-0.002
40	1854.999999	-0.001	1909.999997	-0.002
50	1854.999997	-0.002	1909.999997	-0.001
55	1854.999998	-0.001	1909.999999	-0.001

Frequency Error vs. Voltage

Voltage (Volts)	LTE Band 25			
	Channel Bandwidth: 15 MHz			
	Low Channel		High Channel	
	Frequency (MHz)	Frequency Error (ppm)	Frequency (MHz)	Frequency Error (ppm)
3.85	1857.500001	0.001	1907.500003	0.001
3.6	1857.500004	0.002	1907.500004	0.002
4.4	1857.500003	0.002	1907.500003	0.001

Note: The applicant defined the normal working voltage of the battery is from 3.6 Vdc to 4.4 Vdc.

Frequency Error vs. Temperature

Temp. (°C)	LTE Band 25			
	Channel Bandwidth: 15 MHz			
	Low Channel		High Channel	
	Frequency (MHz)	Frequency Error (ppm)	Frequency (MHz)	Frequency Error (ppm)
-30	1857.500004	0.002	1907.500003	0.002
-20	1857.500003	0.002	1907.500003	0.001
-10	1857.500001	0.001	1907.500004	0.002
0	1857.500004	0.002	1907.500002	0.001
10	1857.500002	0.001	1907.500002	0.001
20	1857.499998	-0.001	1907.499999	-0.001
30	1857.499998	-0.001	1907.499996	-0.002
40	1857.499996	-0.002	1907.499997	-0.002
50	1857.499998	-0.001	1907.499996	-0.002
55	1857.499999	-0.001	1907.499996	-0.002

Frequency Error vs. Voltage

Voltage (Volts)	LTE Band 25			
	Channel Bandwidth: 20 MHz			
	Low Channel		High Channel	
	Frequency (MHz)	Frequency Error (ppm)	Frequency (MHz)	Frequency Error (ppm)
3.85	1860.000001	0.001	1905.000004	0.002
3.6	1860.000004	0.002	1905.000002	0.001
4.4	1860.000003	0.001	1905.000004	0.002

Note: The applicant defined the normal working voltage of the battery is from 3.6 Vdc to 4.4 Vdc.

Frequency Error vs. Temperature

Temp. (°C)	LTE Band 25			
	Channel Bandwidth: 20 MHz			
	Low Channel		High Channel	
	Frequency (MHz)	Frequency Error (ppm)	Frequency (MHz)	Frequency Error (ppm)
-30	1860.000004	0.002	1905.000001	0.001
-20	1860.000002	0.001	1905.000002	0.001
-10	1860.000002	0.001	1905.000002	0.001
0	1860.000004	0.002	1905.000003	0.002
10	1860.000003	0.002	1905.000002	0.001
20	1859.999999	-0.001	1904.999998	-0.001
30	1859.999996	-0.002	1904.999997	-0.001
40	1859.999998	-0.001	1904.999998	-0.001
50	1859.999998	-0.001	1904.999999	-0.001
55	1859.999998	-0.001	1904.999998	-0.001

4.4 Occupied Bandwidth Measurement

4.4.1 Test Procedure

The EUT makes a call to the communication simulator. All measurements were done at low, middle and high operational frequency range. The communication simulator station system controlled a EUT to export maximum output power under transmission mode and specific channel frequency. Use OBW measurement function of Spectrum analyzer to measure 99 % occupied bandwidth.

4.4.2 Test Setup

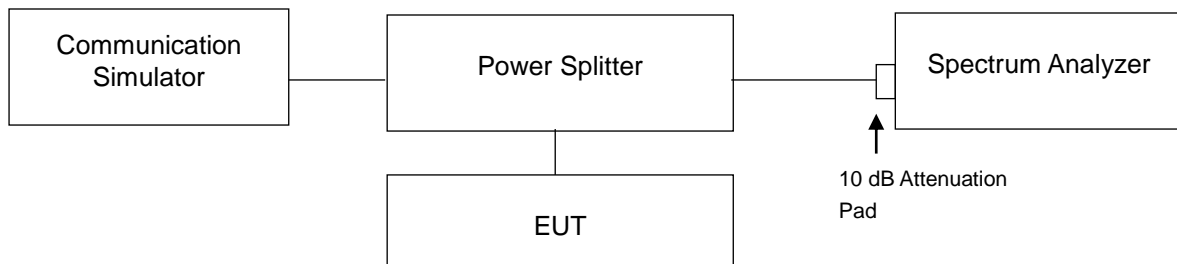

4.4.3 Test Result

<99 % Occupied Bandwidth>

Channel	Frequency (MHz)	99 % Occupied Bandwidth (kHz)		Channel	Frequency (MHz)	99 % Occupied Bandwidth (MHz)
		GSM	EDGE			WCDMA
512	1850.2	245.93	245.20	9262	1852.4	4.1555
661	1880.0	246.70	245.80	9400	1880.0	4.1518
810	1909.8	246.29	244.15	9538	1907.6	4.1548

Channel	Frequency (MHz)	99 % Occupied Bandwidth (MHz)
		CDMA
25	1851.25	1.2770
600	1880.00	1.2736
1175	1908.75	1.2756

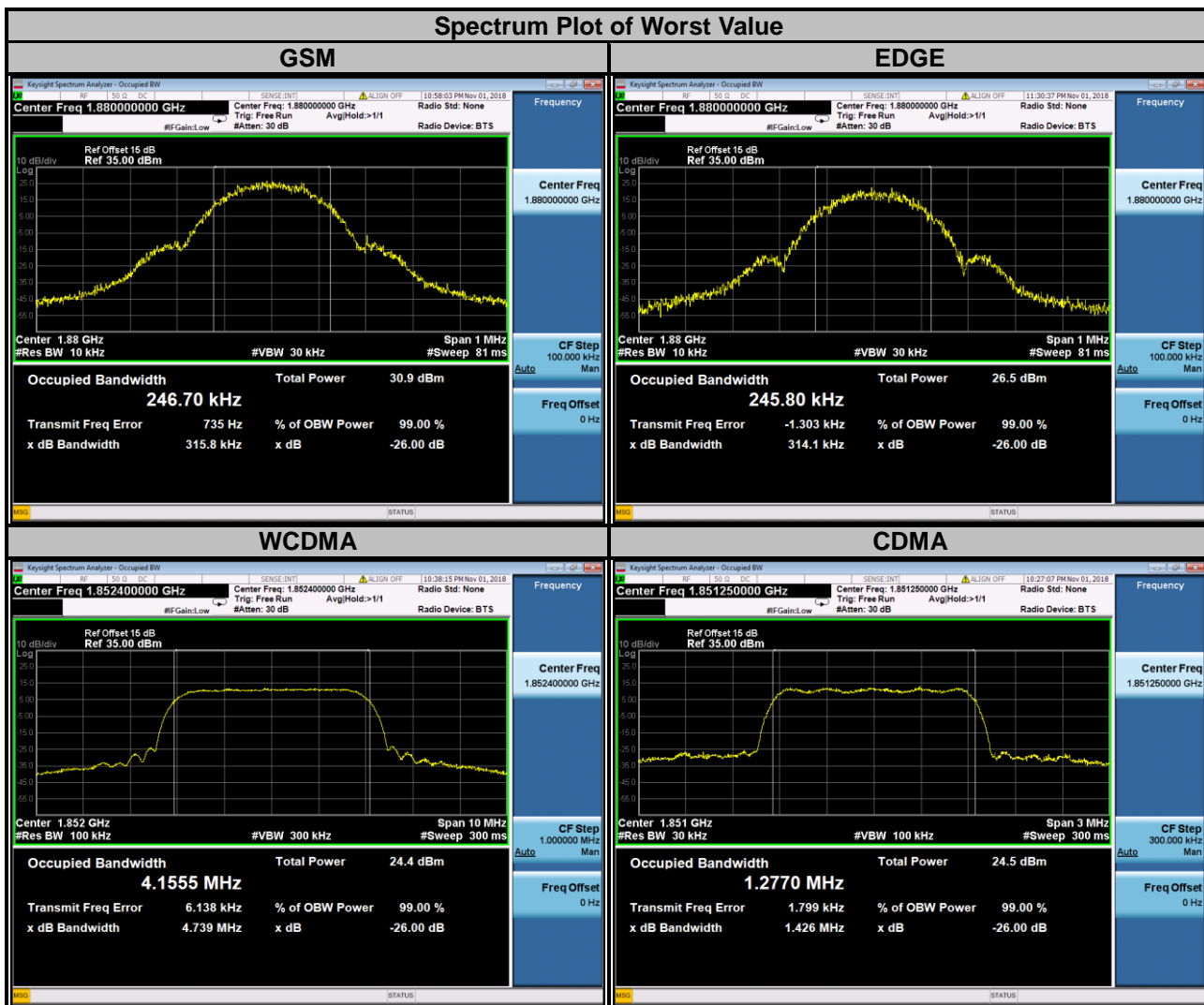

LTE Band 2									
Channel Bandwidth: 1.4 MHz					Channel Bandwidth: 3 MHz				
Channel	Frequency (MHz)	99 % Occupied Bandwidth (MHz)			Channel	Frequency (MHz)	99 % Occupied Bandwidth (MHz)		
		QPSK	16QAM	64QAM			QPSK	16QAM	64QAM
18607	1850.7	1.0867	1.0910	1.0883	18615	1851.5	2.6999	2.6963	2.6985
18900	1880.0	1.0864	1.0874	1.0893	18900	1880.0	2.7006	2.6970	2.6971
19193	1909.3	1.0874	1.0895	1.0891	19185	1908.5	2.7000	2.6975	2.6978

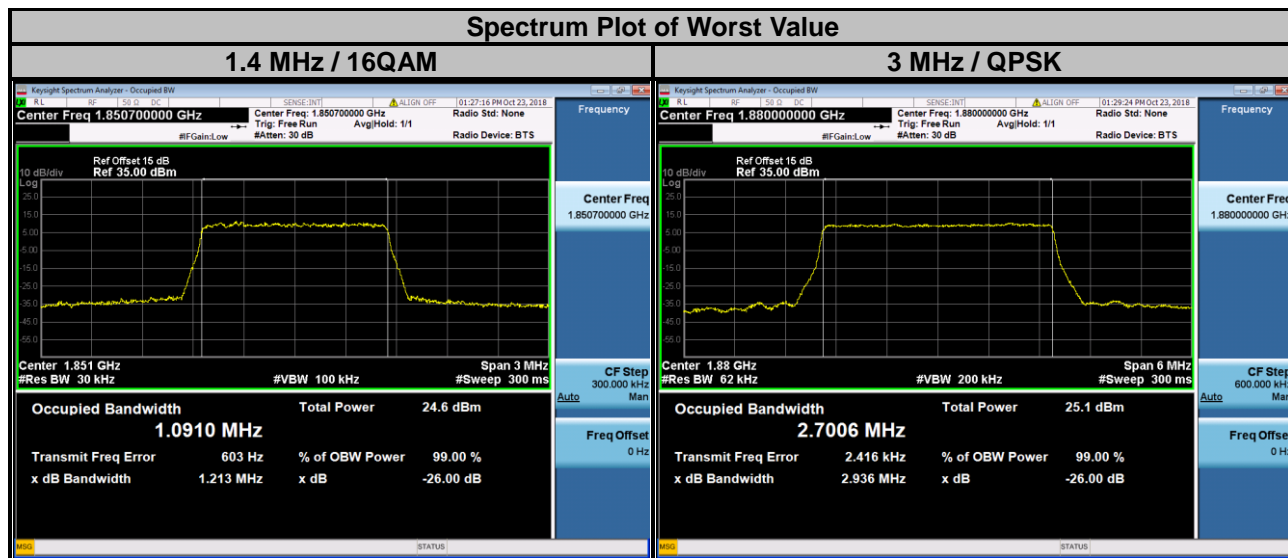

LTE Band 2									
Channel Bandwidth: 5 MHz					Channel Bandwidth: 10 MHz				
Channel	Frequency (MHz)	99 % Occupied Bandwidth (MHz)			Channel	Frequency (MHz)	99 % Occupied Bandwidth (MHz)		
		QPSK	16QAM	64QAM			QPSK	16QAM	64QAM
18625	1852.5	4.4898	4.4943	4.5049	18650	1855.0	8.9642	8.9707	8.9770
18900	1880.0	4.4915	4.4923	4.4985	18900	1880.0	8.9697	8.9778	8.9777
19175	1907.5	4.4912	4.4931	4.5007	19150	1905.0	8.9684	8.9720	8.9753

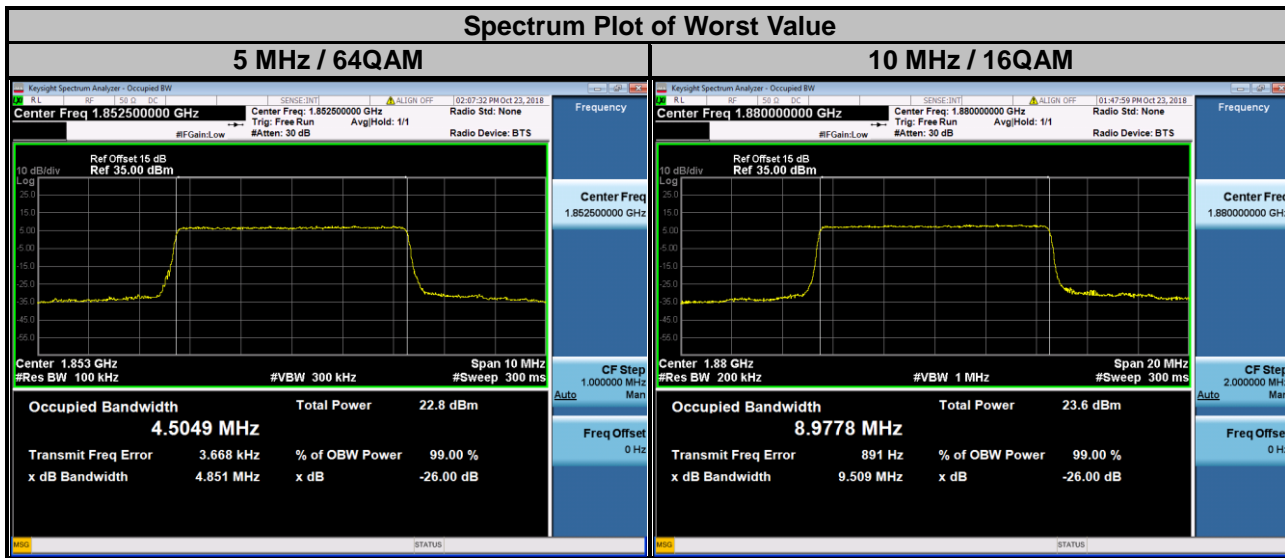

LTE Band 2

Channel Bandwidth: 15 MHz					Channel Bandwidth: 20 MHz				
Channel	Frequency (MHz)	99 % Occupied Bandwidth (MHz)			Channel	Frequency (MHz)	99 % Occupied Bandwidth (MHz)		
		QPSK	16QAM	64QAM			QPSK	16QAM	64QAM
18675	1857.5	13.439	13.438	13.435	18700	1860.0	17.907	17.934	17.928
18900	1880.0	13.464	13.452	13.450	18900	1880.0	17.943	17.965	17.962
19125	1902.5	13.463	13.456	13.455	19100	1900.0	17.939	17.962	17.957

Spectrum Plot of Worst Value

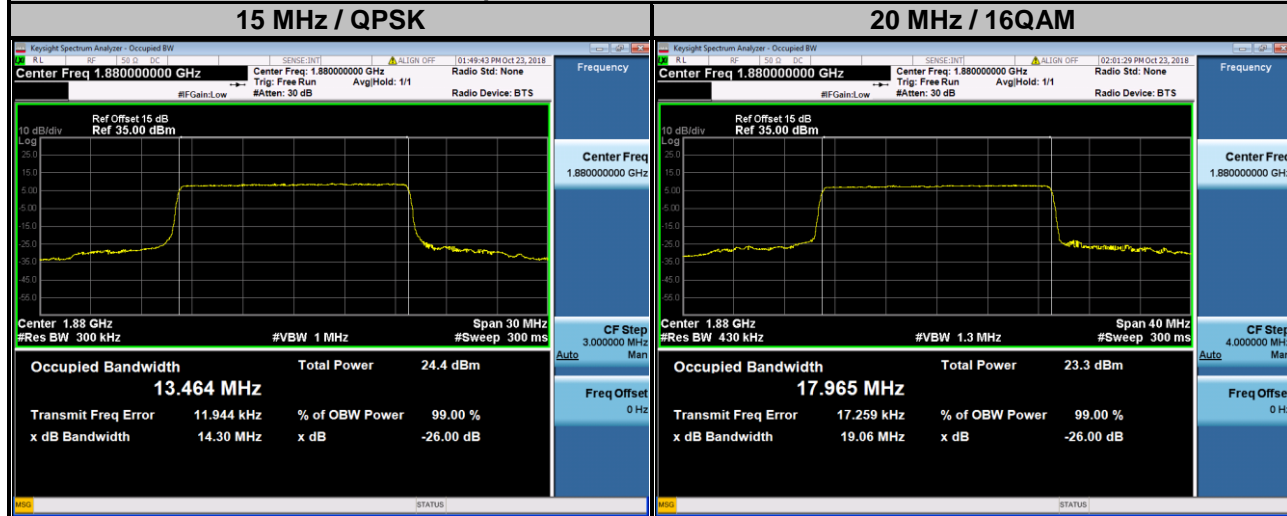

LTE Band 25

Channel Bandwidth: 1.4 MHz					Channel Bandwidth: 3 MHz				
Channel	Frequency (MHz)	99 % Occupied Bandwidth (MHz)			Channel	Frequency (MHz)	99 % Occupied Bandwidth (MHz)		
		QPSK	16QAM	64QAM			QPSK	16QAM	64QAM
26047	1850.7	1.0864	1.0897	1.0879	26055	1851.5	2.7002	2.6969	2.6992
26365	1882.5	1.0852	1.0890	1.0866	26365	1882.5	2.7012	2.6988	2.6984
26683	1914.3	1.0870	1.0866	1.0884	26675	1913.5	2.7010	2.6970	2.6978

Spectrum Plot of Worst Value

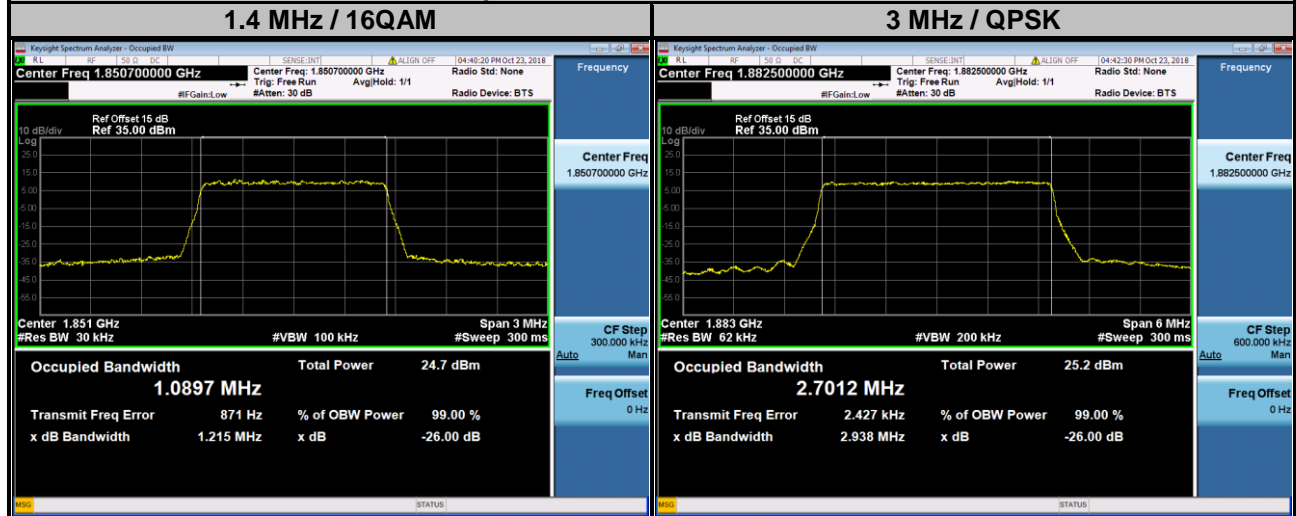

LTE Band 25									
Channel Bandwidth: 5 MHz					Channel Bandwidth: 10 MHz				
Channel	Frequency (MHz)	99 % Occupied Bandwidth (MHz)			Channel	Frequency (MHz)	99 % Occupied Bandwidth (MHz)		
		QPSK	16QAM	64QAM			QPSK	16QAM	64QAM
26065	1852.5	4.4901	4.4914	4.5028	26090	1855.0	8.9644	8.9700	8.9742
26365	1882.5	4.4890	4.4917	4.5030	26365	1882.5	8.9712	8.9743	8.9745
26665	1912.5	4.4911	4.4936	4.5010	26640	1910.0	8.9620	8.9621	8.9663

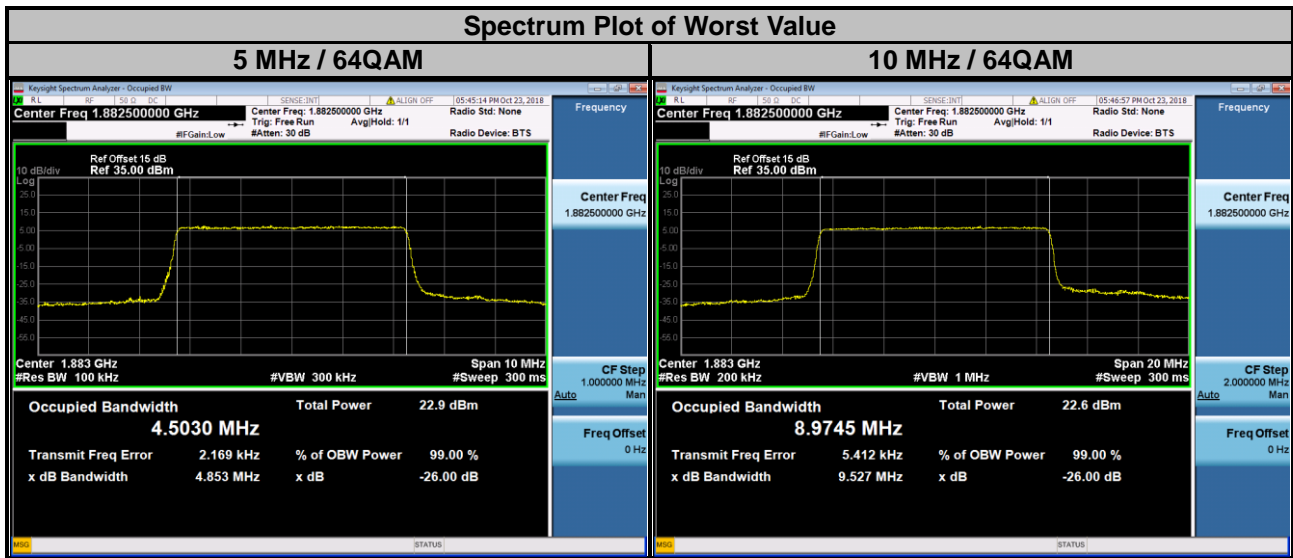

LTE Band 25

Channel Bandwidth: 15 MHz					Channel Bandwidth: 20 MHz				
Channel	Frequency (MHz)	99 % Occupied Bandwidth (MHz)			Channel	Frequency (MHz)	99 % Occupied Bandwidth (MHz)		
		QPSK	16QAM	64QAM			QPSK	16QAM	64QAM
26115	1857.5	13.443	13.435	13.437	26140	1860.0	17.899	17.930	17.924
26365	1882.5	13.460	13.448	13.448	26365	1882.5	17.935	17.956	17.952
26615	1907.5	13.440	13.437	13.438	26590	1905.0	17.943	17.948	17.940

Spectrum Plot of Worst Value

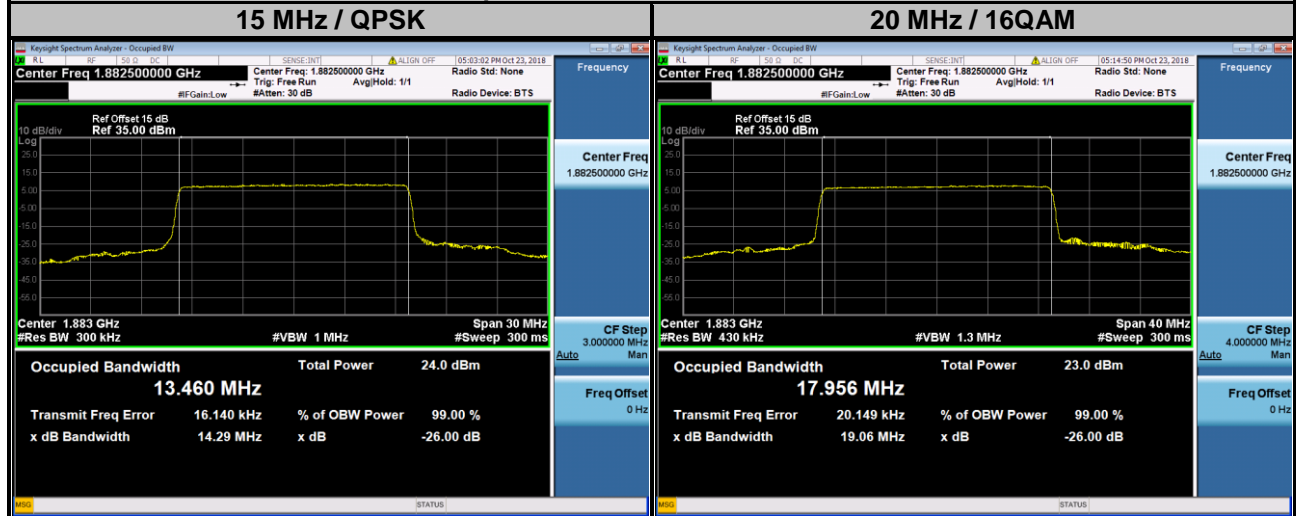

<26 dB Bandwidth>

Channel	Frequency (MHz)	26 dB Bandwidth (kHz)		Channel	Frequency (MHz)	26 dB Bandwidth (MHz)
		GSM	EDGE			WCDMA
512	1850.2	314.7	312.2	9262	1852.4	4.739
661	1880.0	315.8	314.1	9400	1880.0	4.735
810	1909.8	311.5	314.1	9538	1907.6	4.732
Channel	Frequency (MHz)	26 dB Bandwidth (MHz)				
		CDMA				
25	1851.25	1.426				
600	1880.00	1.423				
1175	1908.75	1.430				

Spectrum Plot of Worst Value

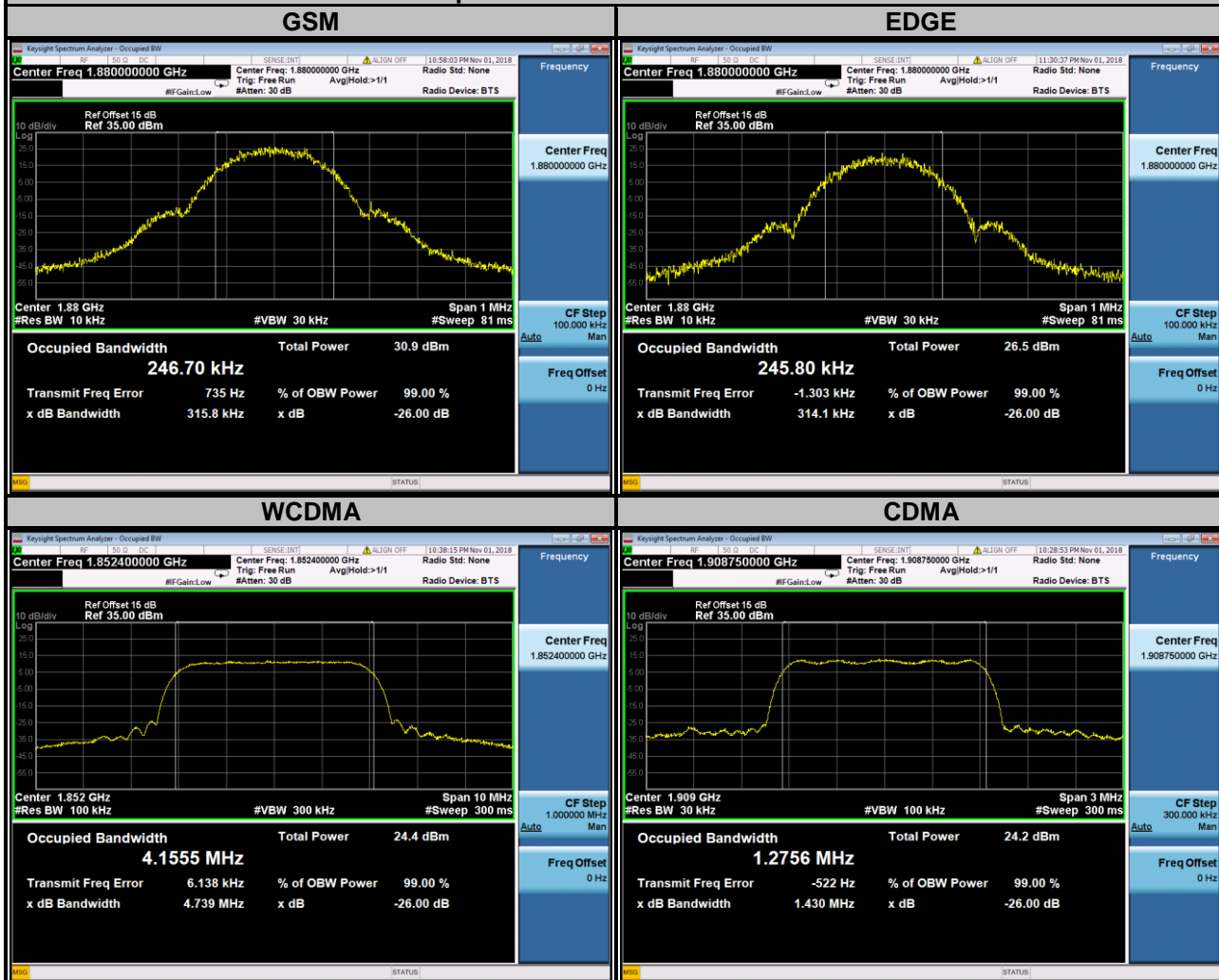

LTE Band 2									
Channel Bandwidth: 1.4 MHz					Channel Bandwidth: 3 MHz				
Channel	Frequency (MHz)	26 dB Bandwidth (MHz)			Channel	Frequency (MHz)	26 dB Bandwidth (MHz)		
		QPSK	16QAM	64QAM			QPSK	16QAM	64QAM
18607	1850.7	1.218	1.213	1.218	18615	1851.5	2.937	2.922	2.918
18900	1880.0	1.219	1.207	1.209	18900	1880.0	2.936	2.922	2.901
19193	1909.3	1.223	1.211	1.217	19185	1908.5	2.930	2.932	2.914

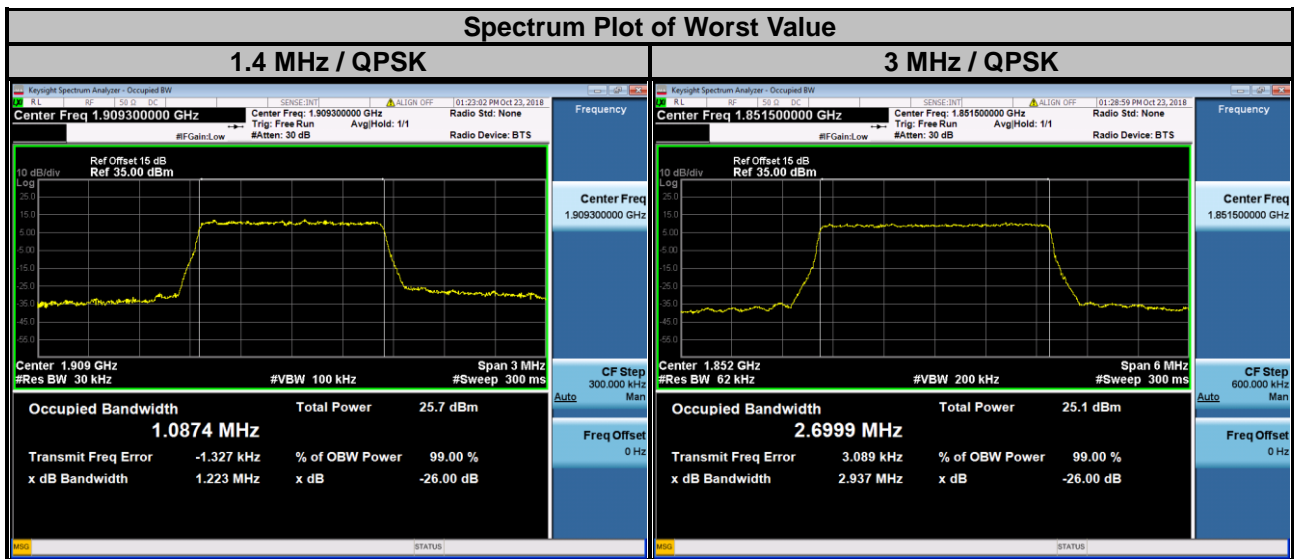

LTE Band 2									
Channel Bandwidth: 5 MHz					Channel Bandwidth: 10 MHz				
Channel	Frequency (MHz)	26 dB Bandwidth (MHz)			Channel	Frequency (MHz)	26 dB Bandwidth (MHz)		
		QPSK	16QAM	64QAM			QPSK	16QAM	64QAM
18625	1852.5	4.823	4.804	4.851	18650	1855.0	9.552	9.521	9.520
18900	1880.0	4.810	4.806	4.838	18900	1880.0	9.527	9.509	9.522
19175	1907.5	4.828	4.804	4.827	19150	1905.0	9.529	9.523	9.525

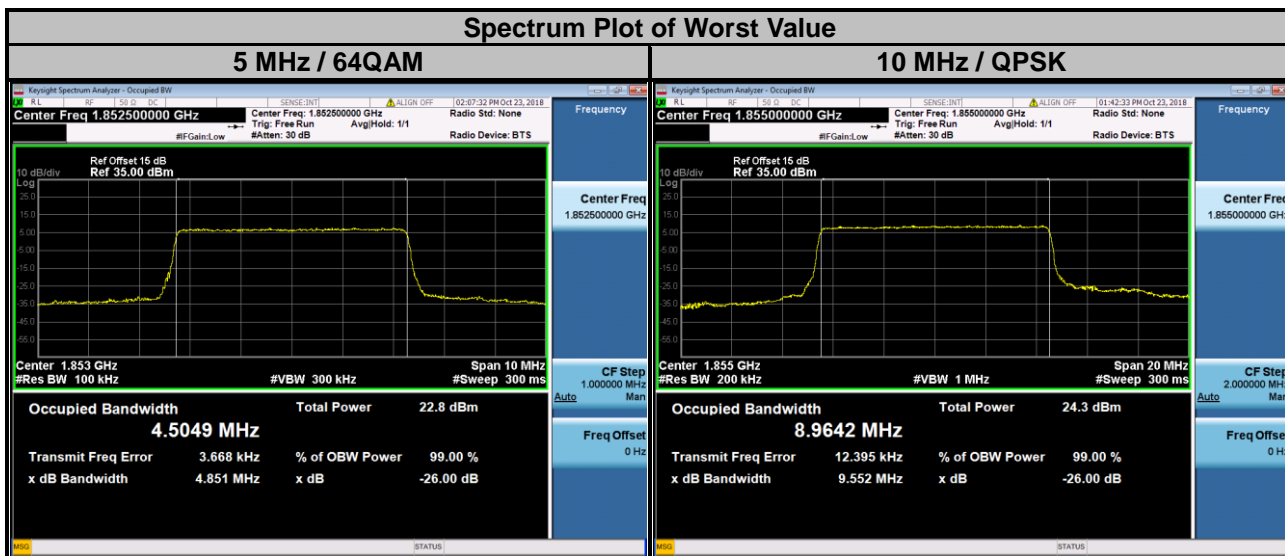

LTE Band 2

Channel Bandwidth: 15 MHz					Channel Bandwidth: 20 MHz				
Channel	Frequency (MHz)	26 dB Bandwidth (MHz)			Channel	Frequency (MHz)	26 dB Bandwidth (MHz)		
		QPSK	16QAM	64QAM			QPSK	16QAM	64QAM
18675	1857.5	14.27	14.25	14.26	18700	1860.0	19.07	19.02	19.03
18900	1880.0	14.30	14.26	14.25	18900	1880.0	19.11	19.06	19.05
19125	1902.5	14.28	14.25	14.26	19100	1900.0	19.10	19.05	19.06

Spectrum Plot of Worst Value

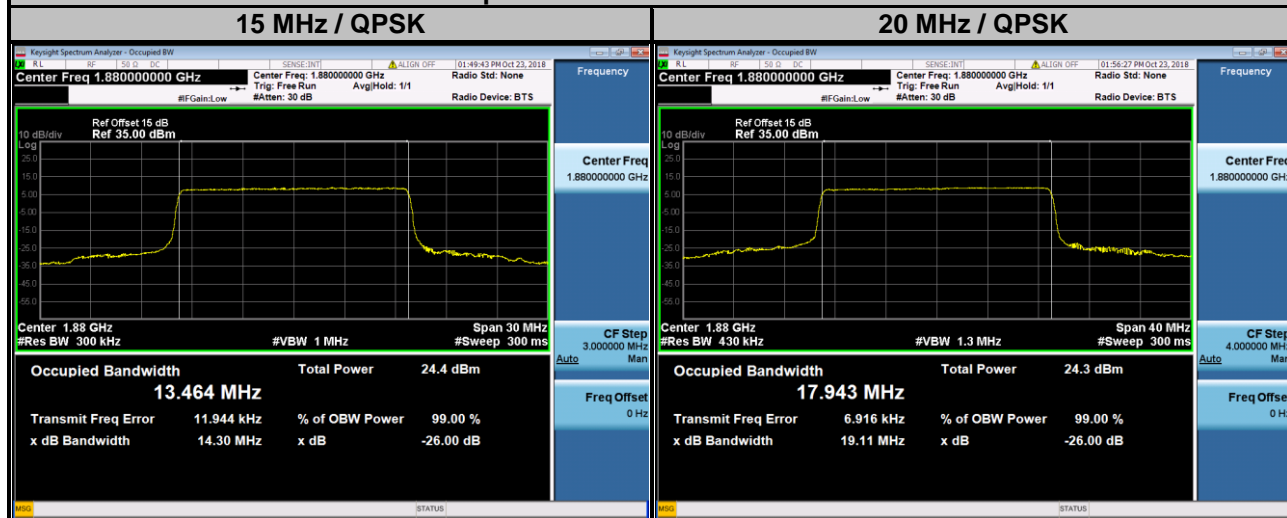

LTE Band 25									
Channel Bandwidth: 1.4 MHz					Channel Bandwidth: 3 MHz				
Channel	Frequency (MHz)	26 dB Bandwidth (MHz)			Channel	Frequency (MHz)	26 dB Bandwidth (MHz)		
		QPSK	16QAM	64QAM			QPSK	16QAM	64QAM
26047	1850.7	1.222	1.215	1.205	26055	1851.5	2.926	2.927	2.904
26365	1882.5	1.225	1.215	1.205	26365	1882.5	2.938	2.938	2.913
26683	1914.3	1.220	1.213	1.207	26675	1913.5	2.929	2.931	2.920

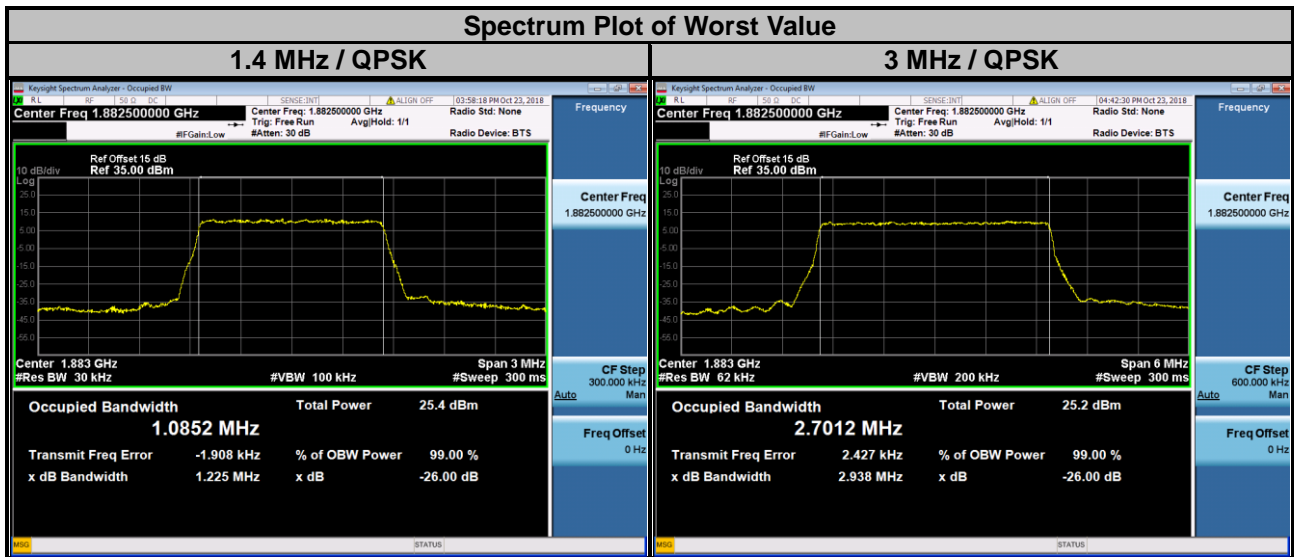

LTE Band 25									
Channel Bandwidth: 5 MHz					Channel Bandwidth: 10 MHz				
Channel	Frequency (MHz)	26 dB Bandwidth (MHz)			Channel	Frequency (MHz)	26 dB Bandwidth (MHz)		
		QPSK	16QAM	64QAM			QPSK	16QAM	64QAM
26065	1852.5	4.826	4.797	4.829	26090	1855.0	9.541	9.518	9.535
26365	1882.5	4.839	4.812	4.853	26365	1882.5	9.539	9.513	9.527
26665	1912.5	4.833	4.812	4.851	26640	1910.0	9.526	9.522	9.529

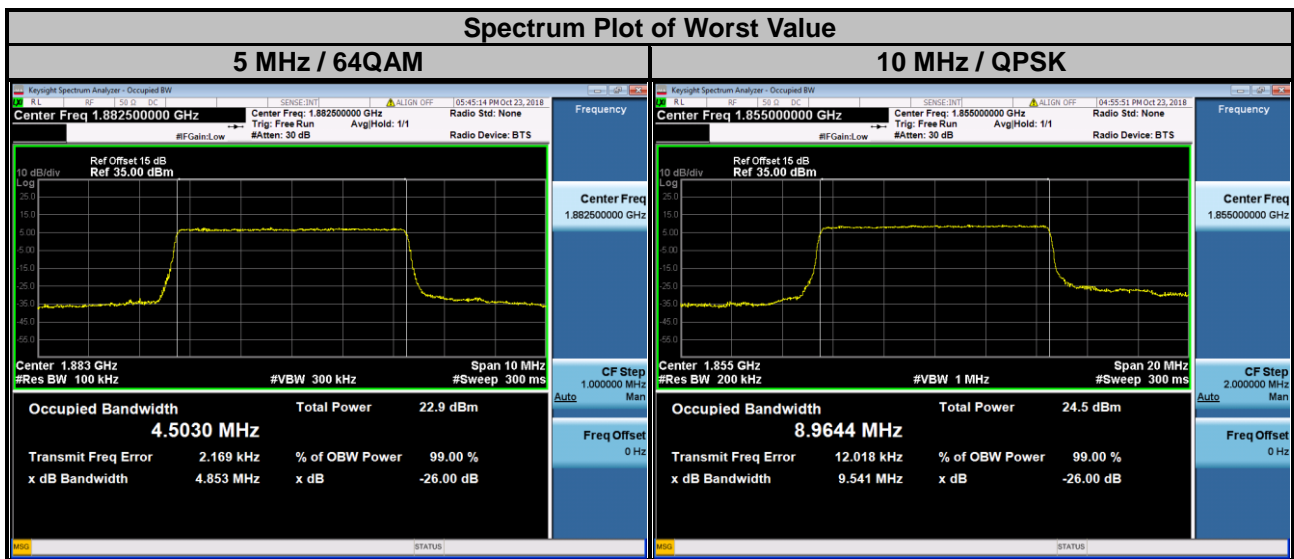

LTE Band 25									
Channel Bandwidth: 15 MHz					Channel Bandwidth: 20 MHz				
Channel	Frequency (MHz)	26 dB Bandwidth (MHz)			Channel	Frequency (MHz)	26 dB Bandwidth (MHz)		
		QPSK	16QAM	64QAM			QPSK	16QAM	64QAM
26115	1857.5	14.27	14.25	14.24	26140	1860.0	19.05	19.03	19.03
26365	1882.5	14.29	14.26	14.25	26365	1882.5	19.11	19.06	19.05
26615	1907.5	14.26	14.24	14.24	26590	1905.0	19.20	19.08	19.05

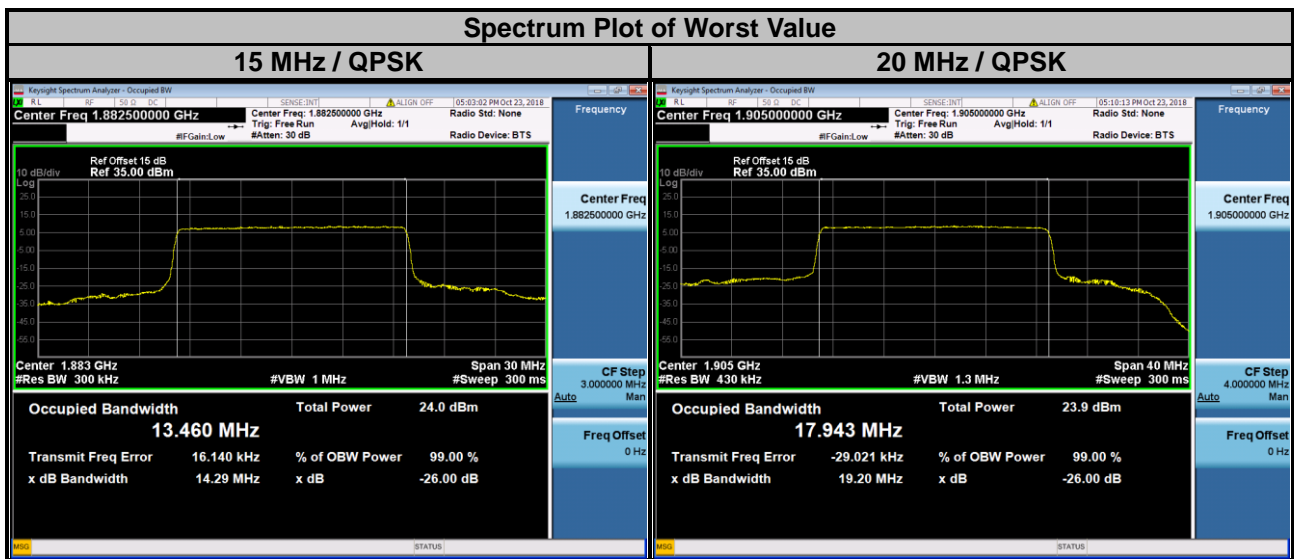

4.5 Band Edge Measurement

4.5.1 Limits of Band Edge Measurement

Power of any emission outside of the authorized operating frequency ranges must be attenuated below the transmitting power (P) by a factor of at least $43 + 10 \log(P)$ dB. In the 1 MHz bands immediately outside and adjacent to the frequency block a resolution bandwidth of at least one percent of the emission bandwidth of the fundamental emission of the transmitter may be employed.

4.5.2 Test Setup

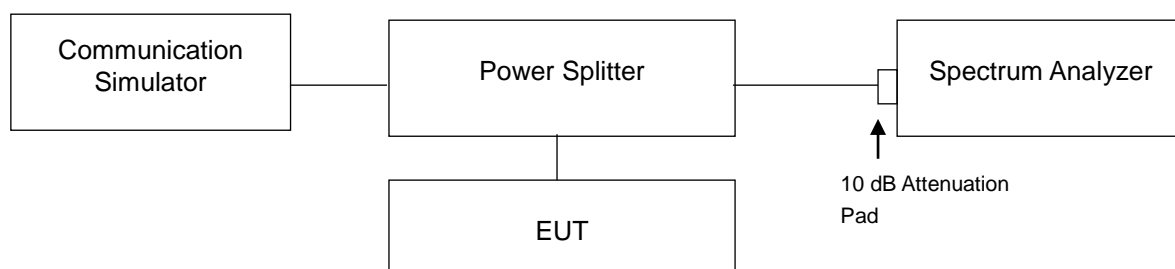

4.5.3 Test Procedures

- All measurements were done at low and high operational frequency range.
- The center frequency of spectrum is the band edge frequency and span is 1 MHz. RB of the spectrum is 10 kHz and VB of the spectrum is 30 kHz (GSM/GPRS/EDGE).
- The center frequency of spectrum is the band edge frequency and span is 5 MHz. RB of the spectrum is 100 kHz and VB of the spectrum is 300 kHz (WCDMA).
- The center frequency of spectrum is the band edge frequency and span is 1 MHz. RB of the spectrum is 13 kHz and VB of the spectrum is 51 kHz (CDMA).
- The center frequency of spectrum is the band edge frequency and span is 1 MHz. RB of the spectrum is 15 kHz and VB of the spectrum is 51 kHz (LTE Bandwidth 1.4 MHz).
- The center frequency of spectrum is the band edge frequency and span is 1 MHz. RB of the spectrum is 30 kHz and VB of the spectrum is 100 kHz (LTE Bandwidth 3 MHz).
- The center frequency of spectrum is the band edge frequency and span is 1 MHz. RB of the spectrum is 62 kHz and VB of the spectrum is 200 kHz (LTE Bandwidth 5 MHz).
- The center frequency of spectrum is the band edge frequency and span is 1 MHz. RB of the spectrum is 100 kHz and VB of the spectrum is 300 kHz (LTE Bandwidth 10 MHz).
- The center frequency of spectrum is the band edge frequency and span is 1 MHz. RB of the spectrum is 150 kHz and VB of the spectrum is 470 kHz (LTE Bandwidth 15 MHz).
- The center frequency of spectrum is the band edge frequency and span is 1 MHz. RB of the spectrum is 200 kHz and VB of the spectrum is 1 MHz (LTE Bandwidth 20 MHz).
- Record the max trace plot into the test report.

4.5.4 Test Results

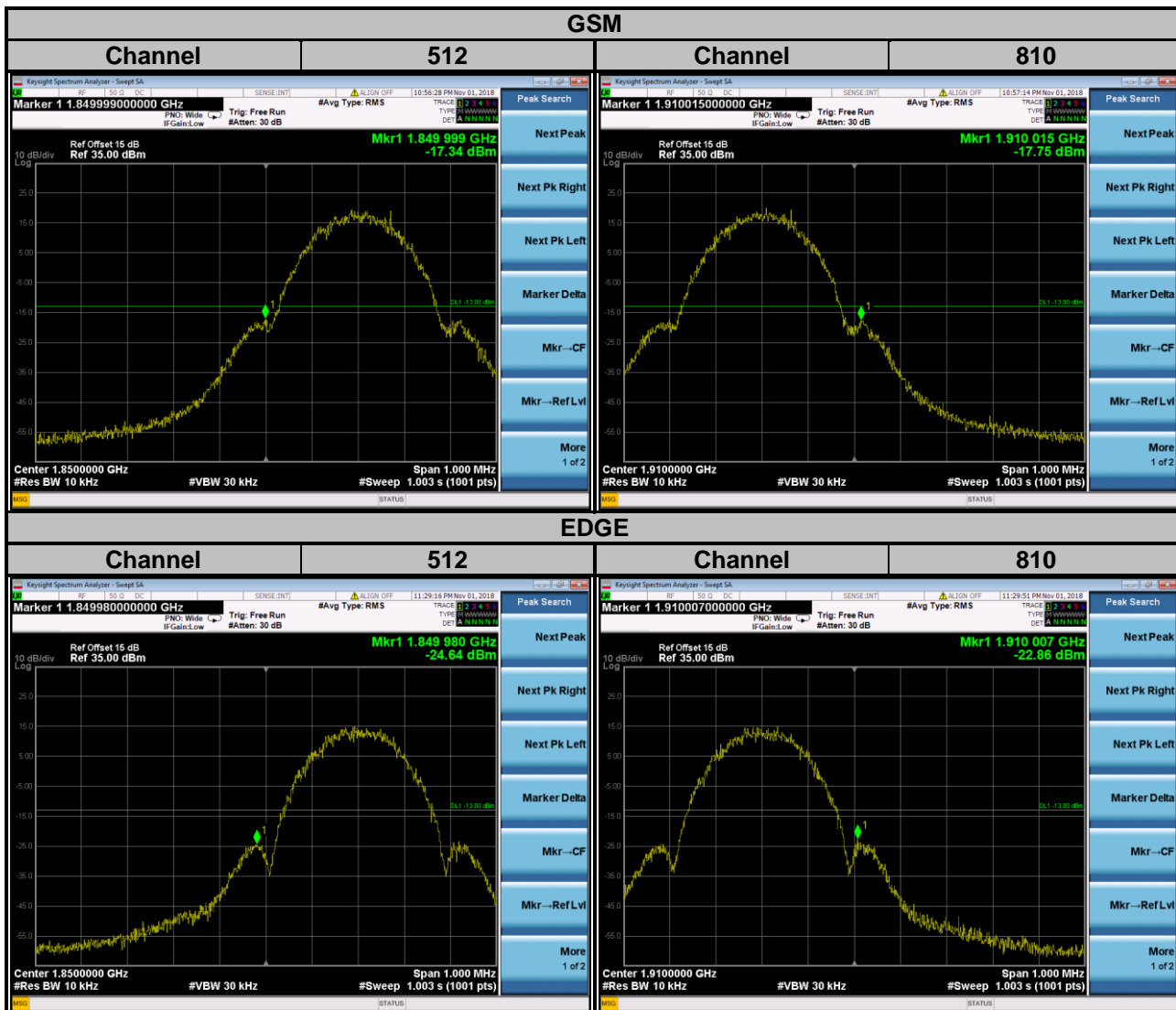

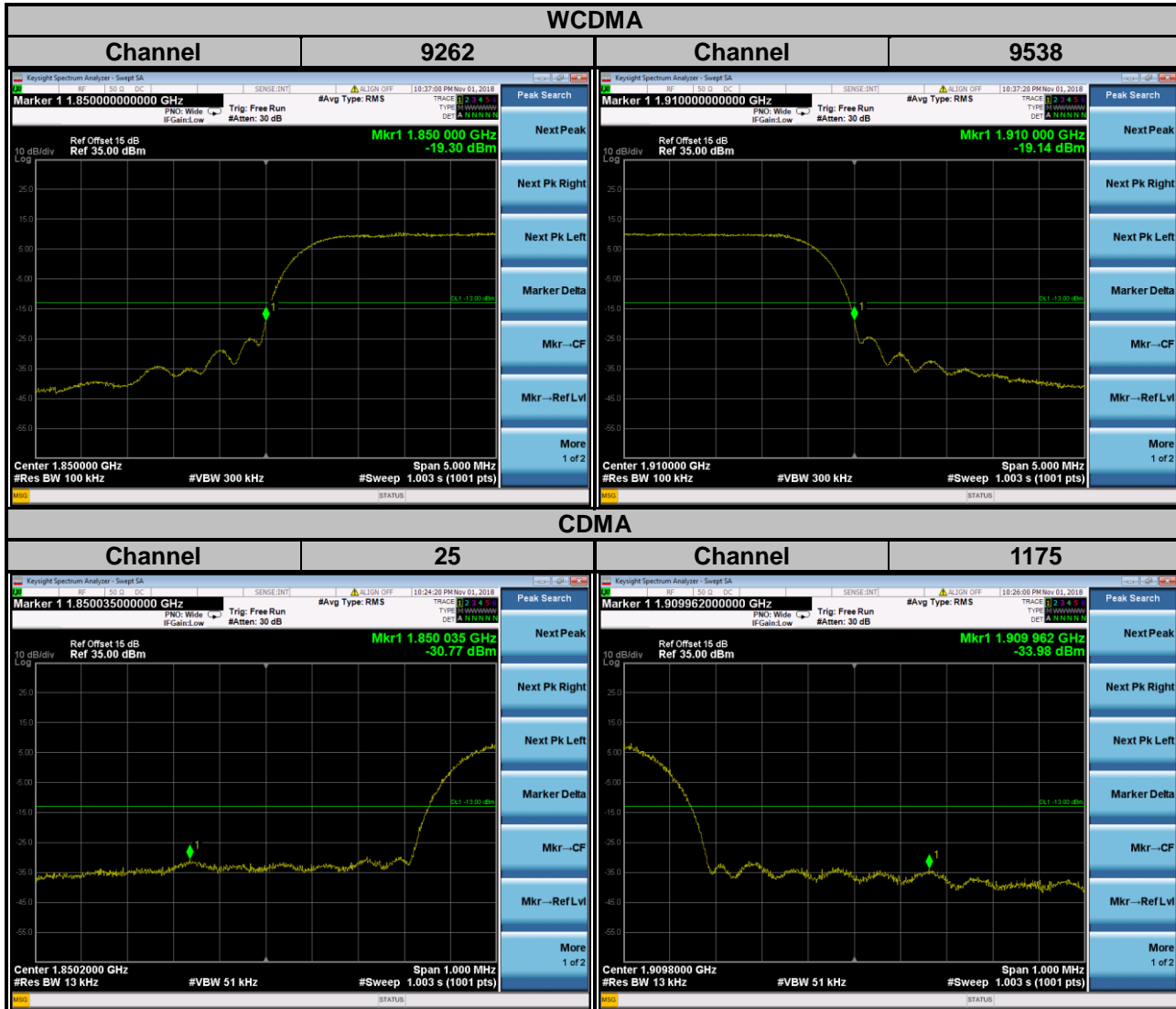

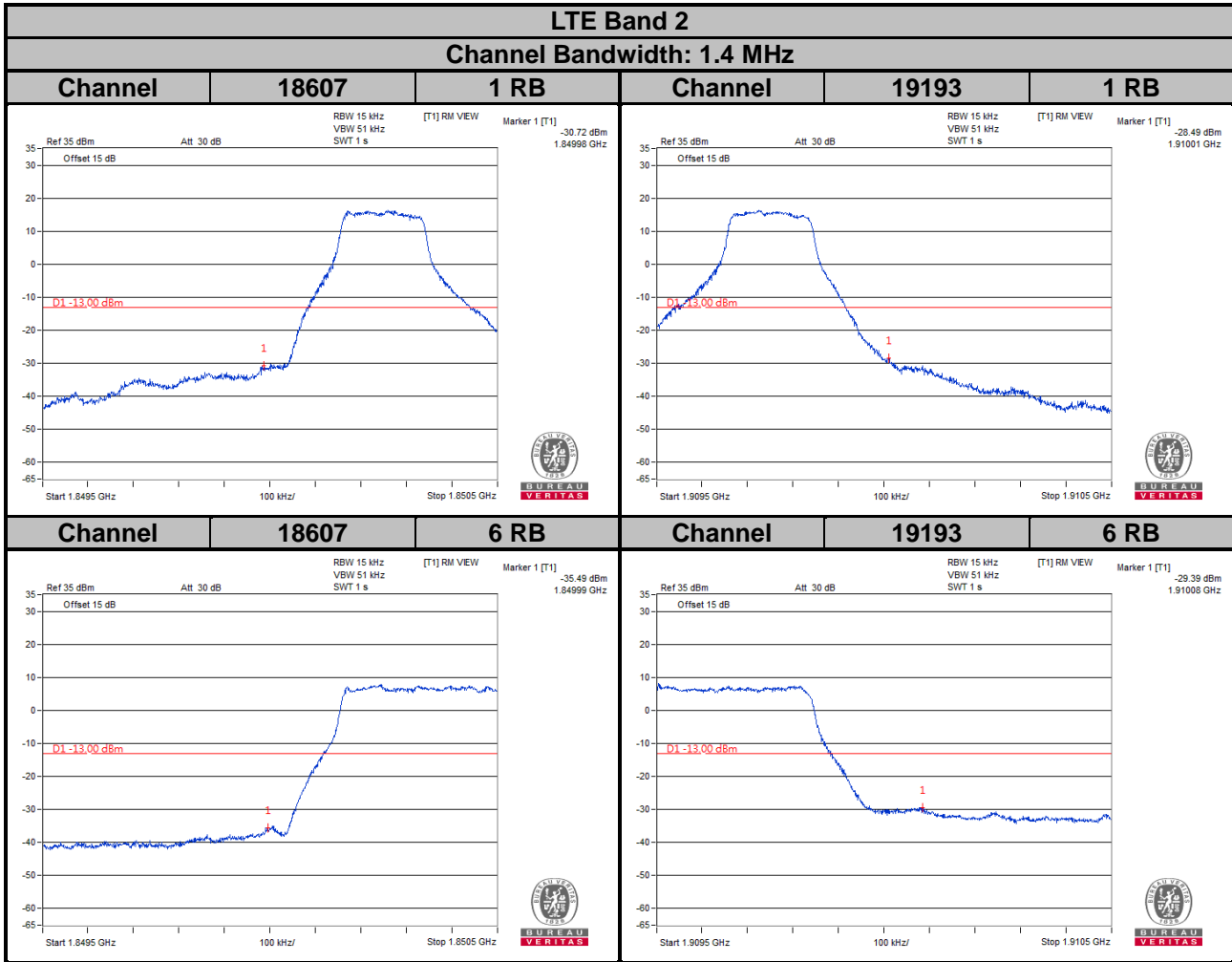

LTE Band 2

Channel Bandwidth: 3 MHz

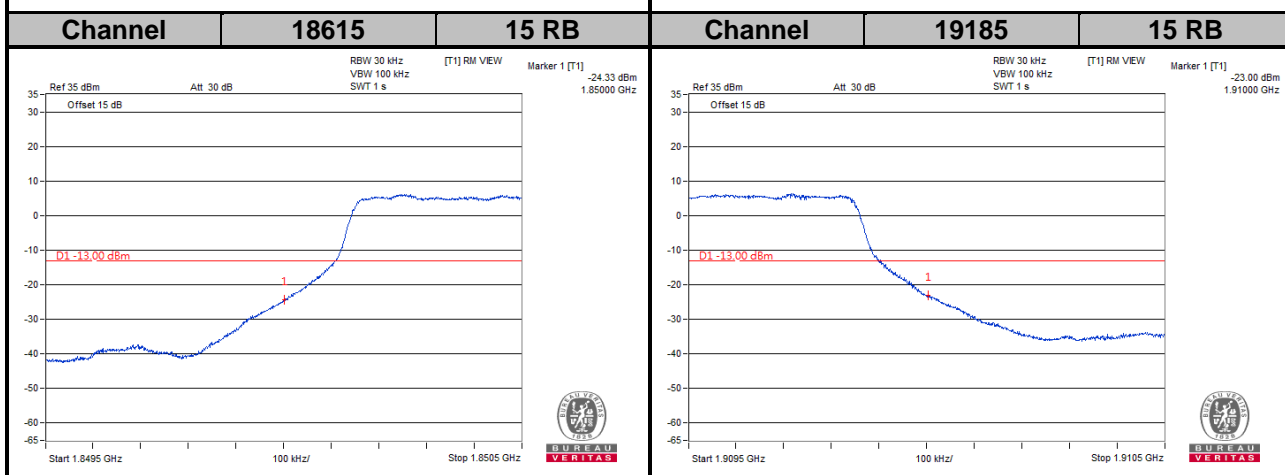
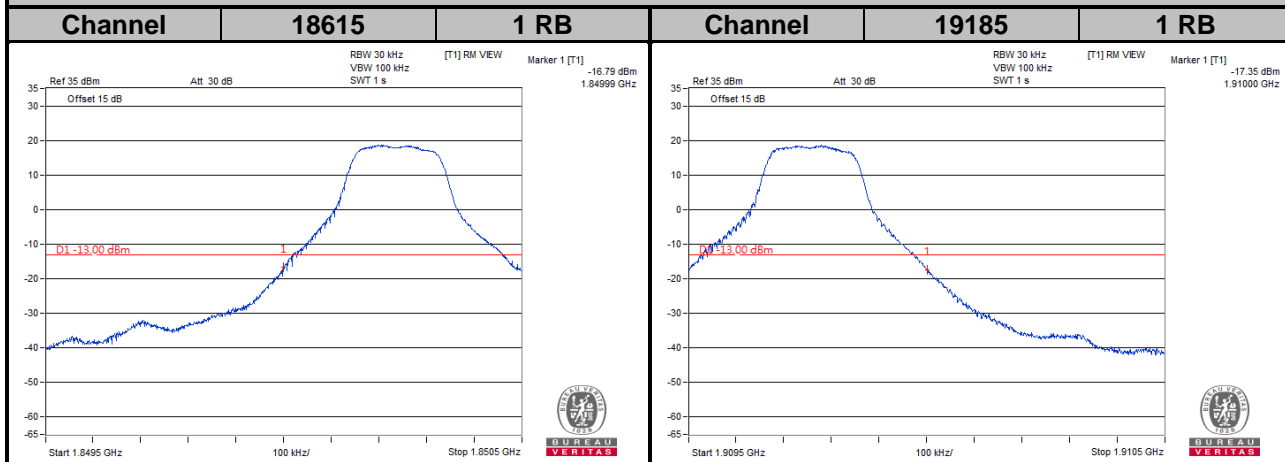

LTE Band 2
Channel Bandwidth: 5 MHz

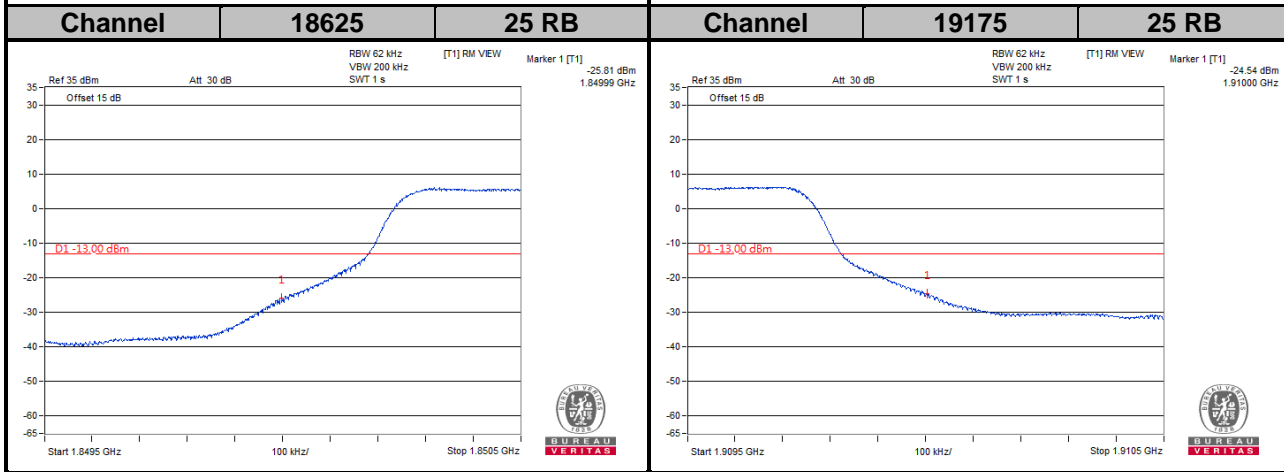
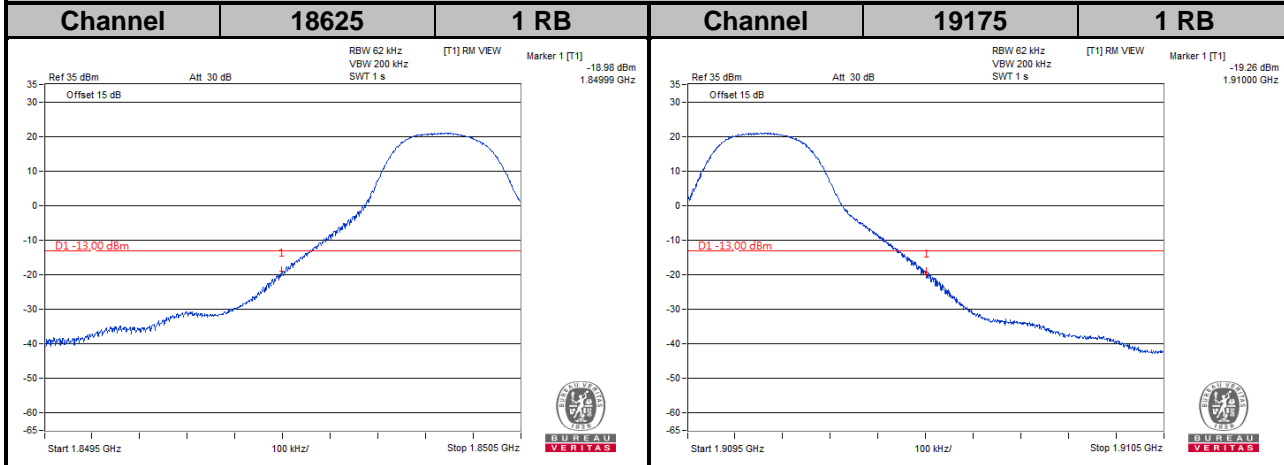

LTE Band 2
Channel Bandwidth: 10 MHz

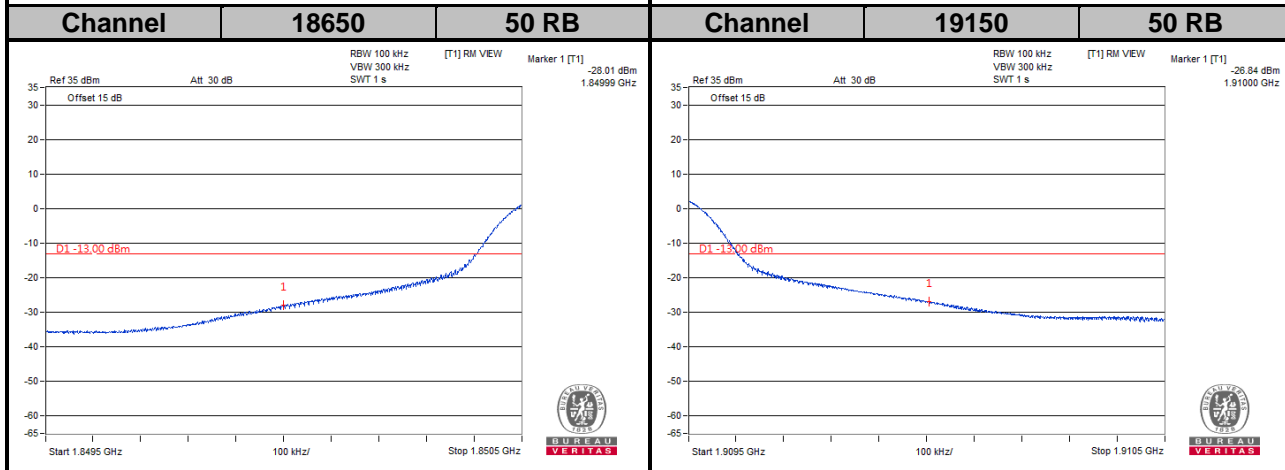
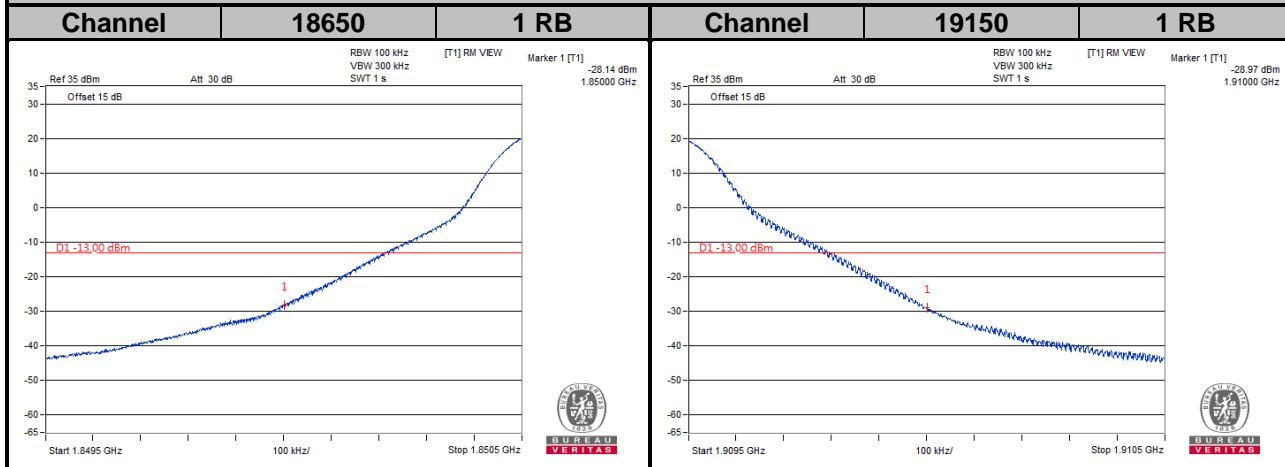

LTE Band 2

Channel Bandwidth: 15 MHz

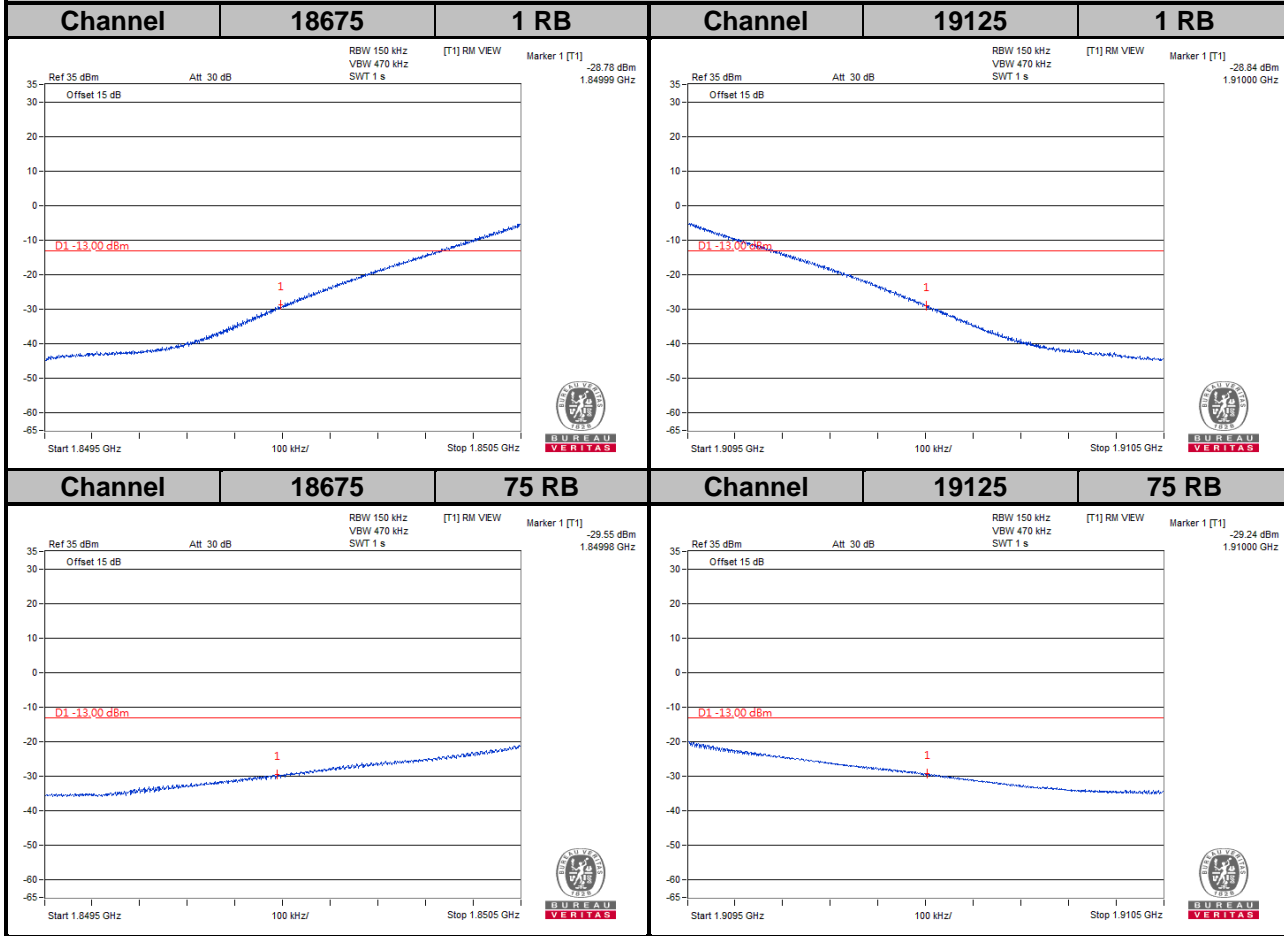

LTE Band 2
Channel Bandwidth: 20 MHz

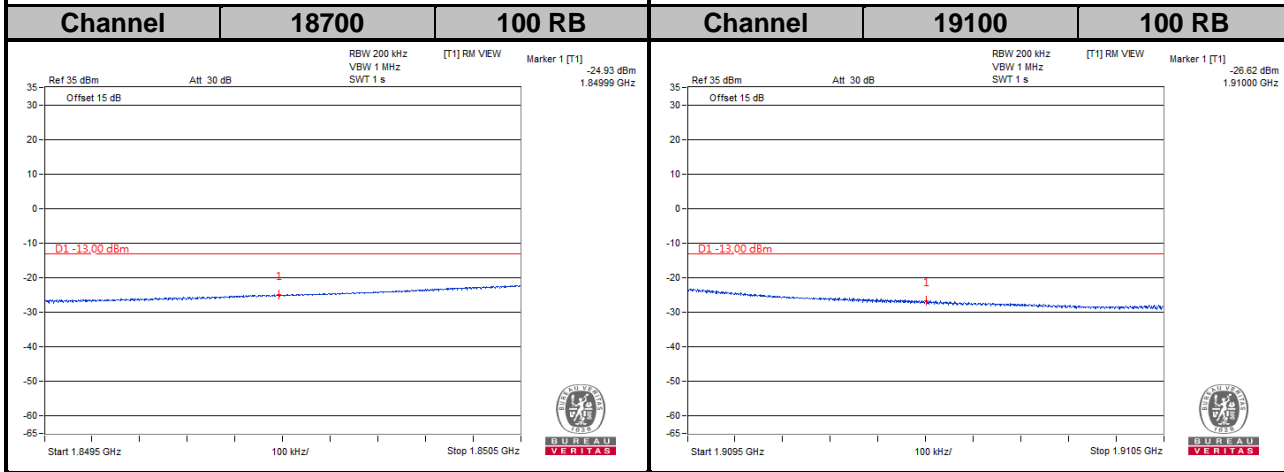
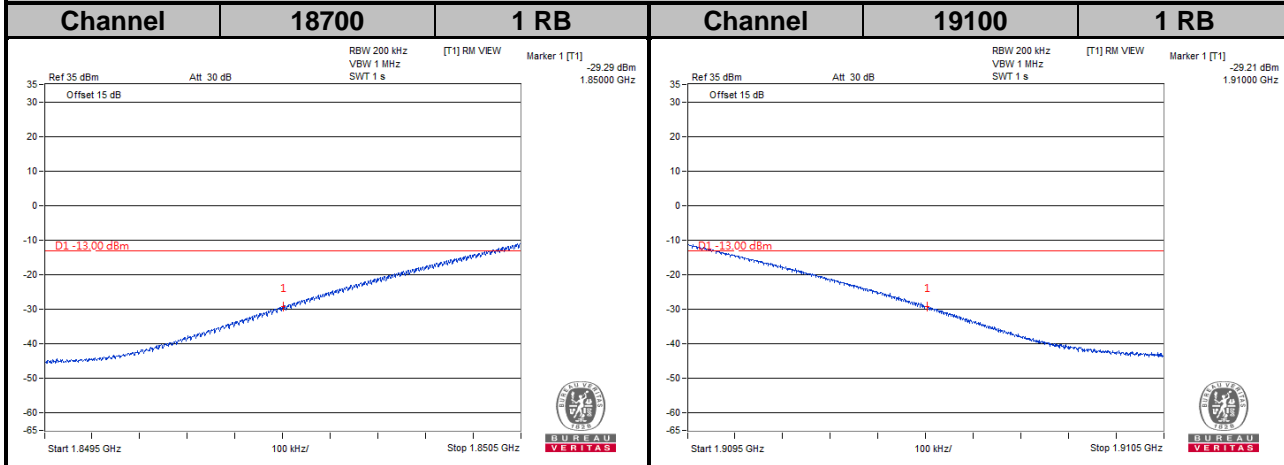

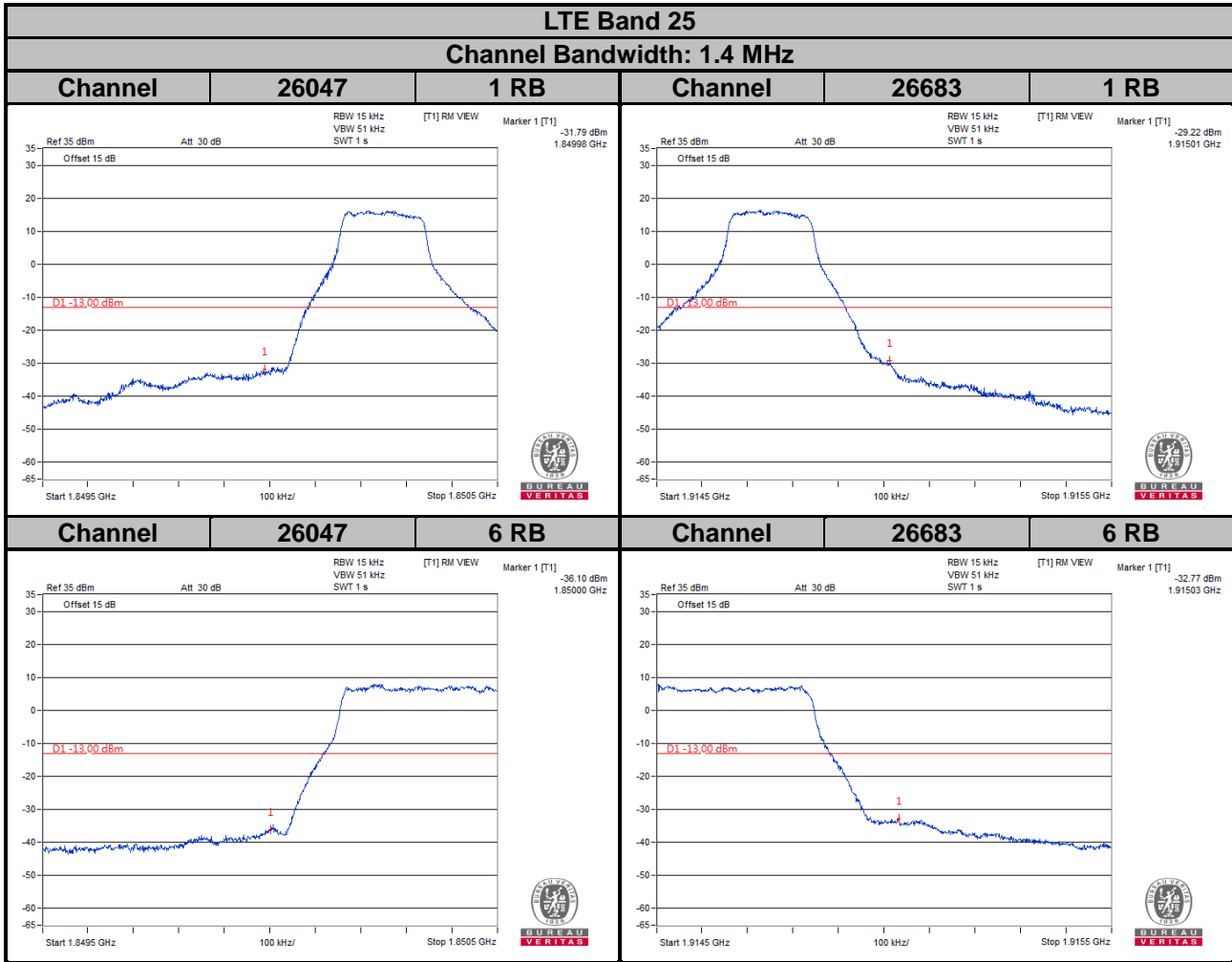

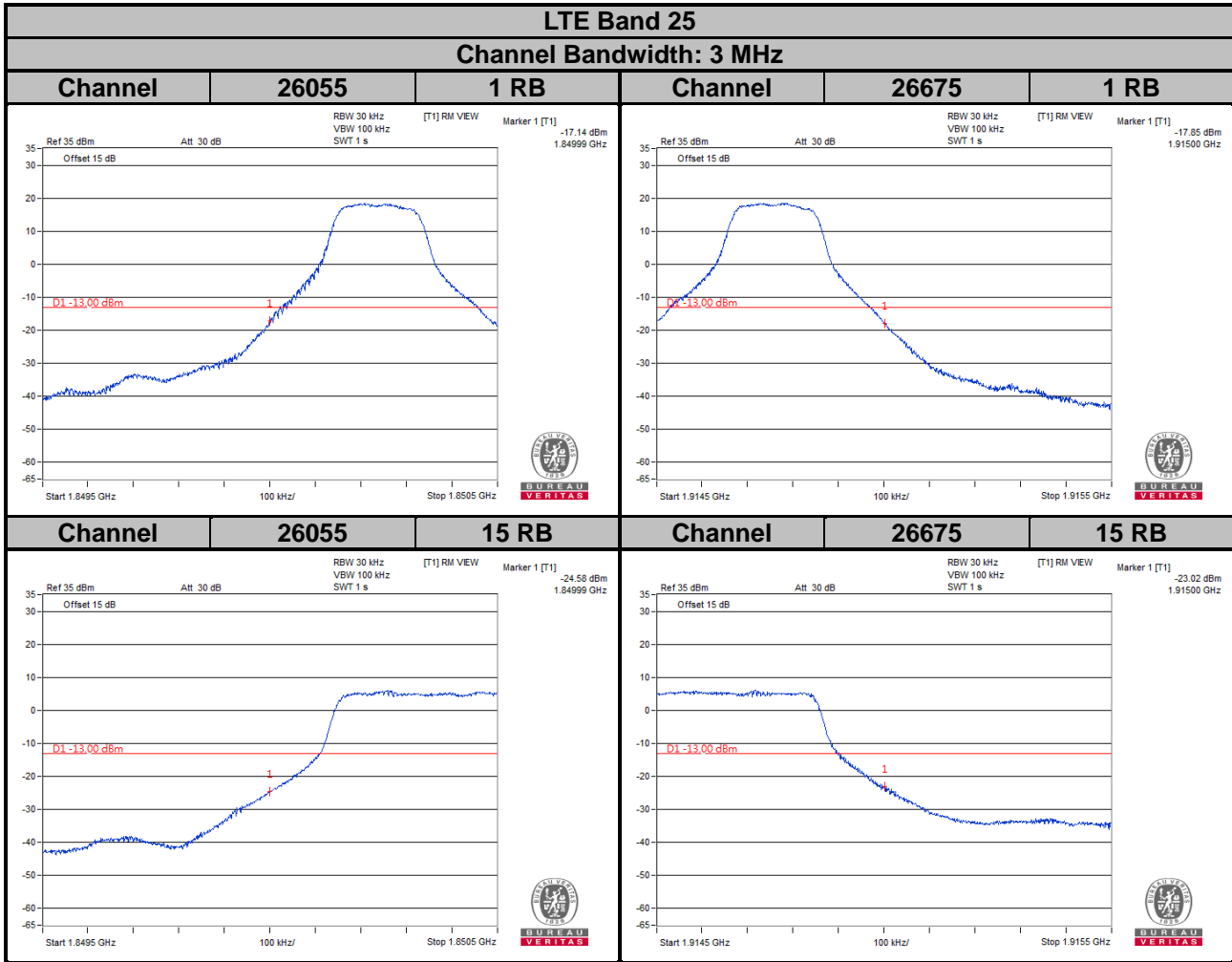

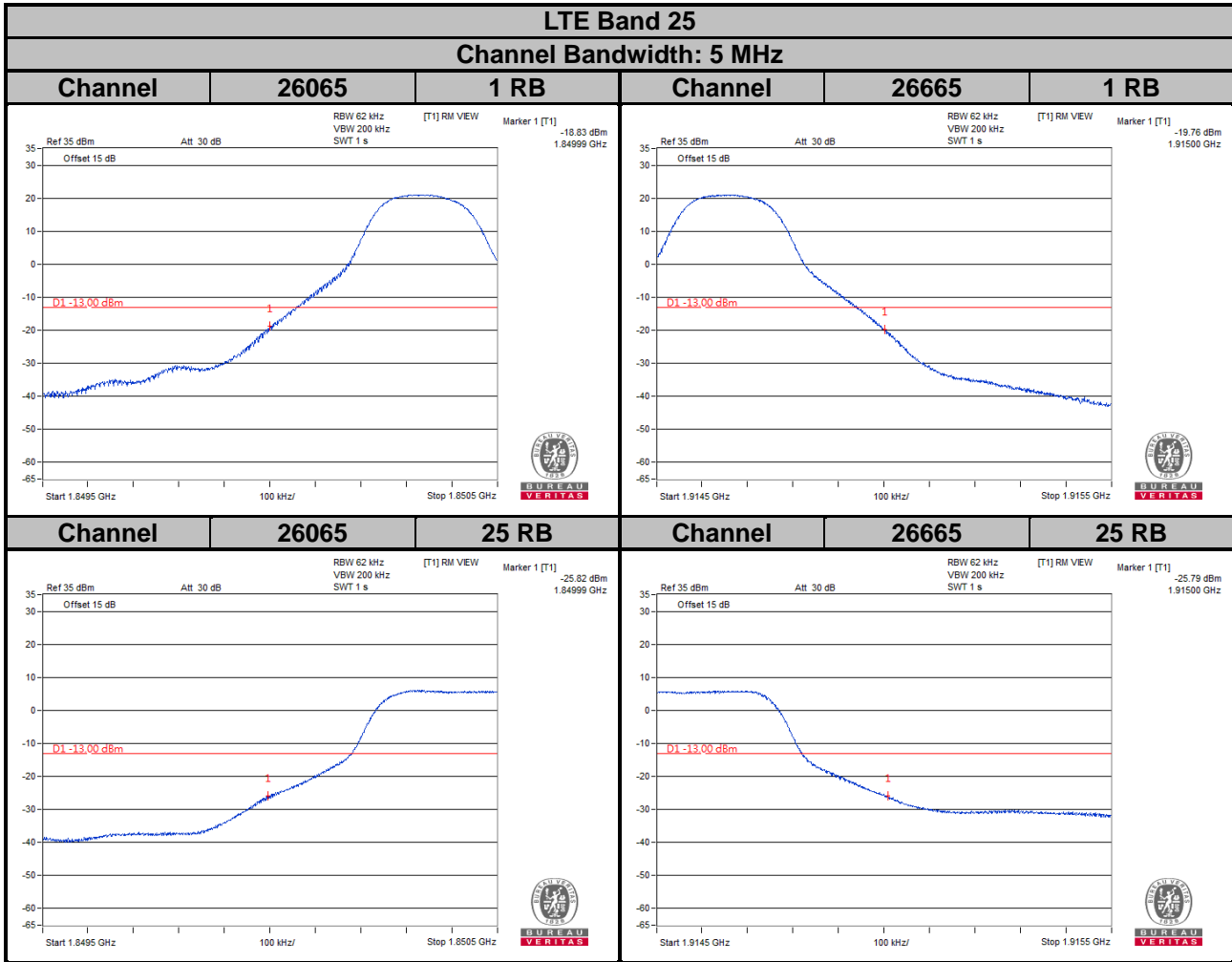

LTE Band 25
Channel Bandwidth: 10 MHz

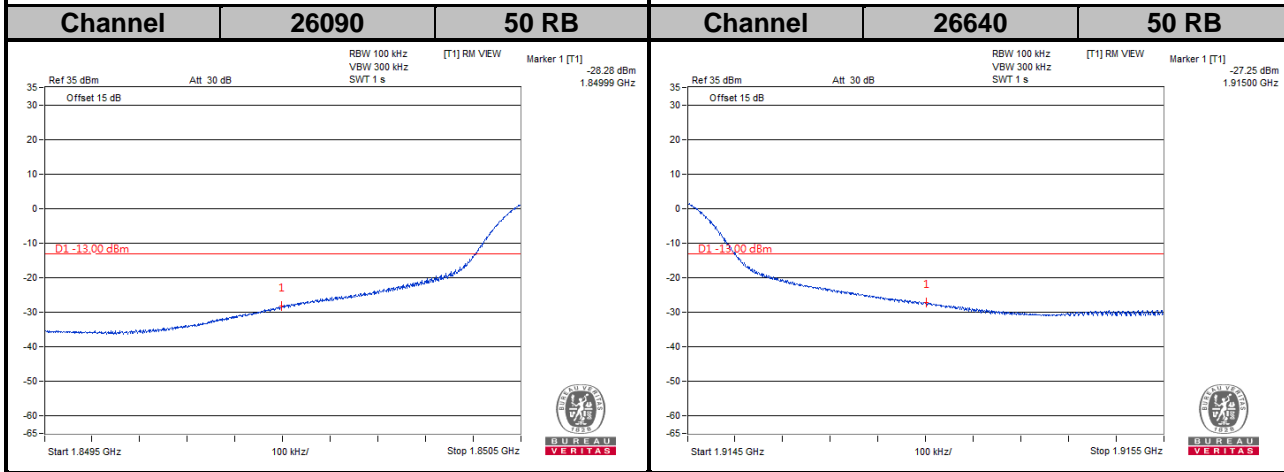
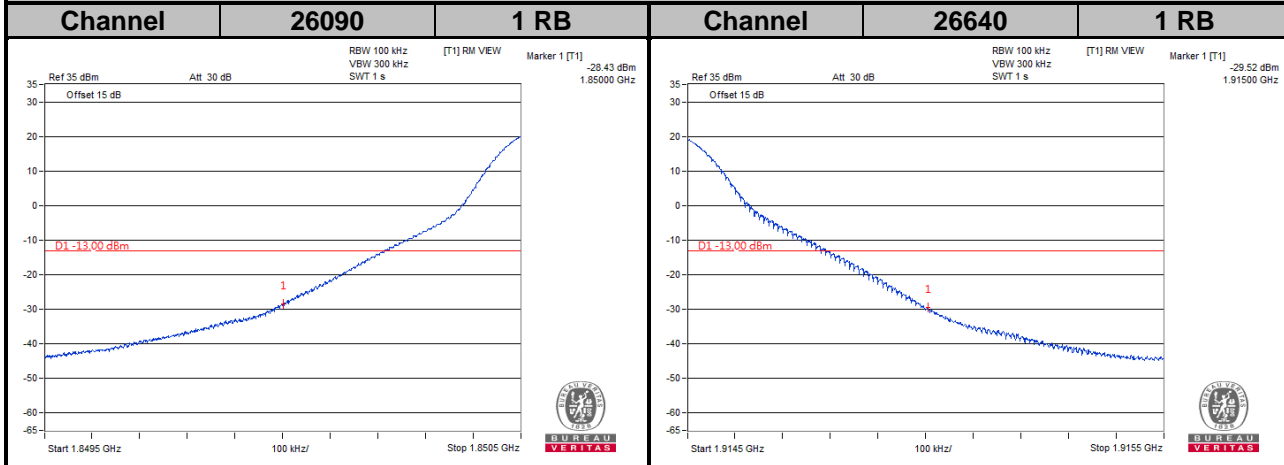

LTE Band 25

Channel Bandwidth: 15 MHz

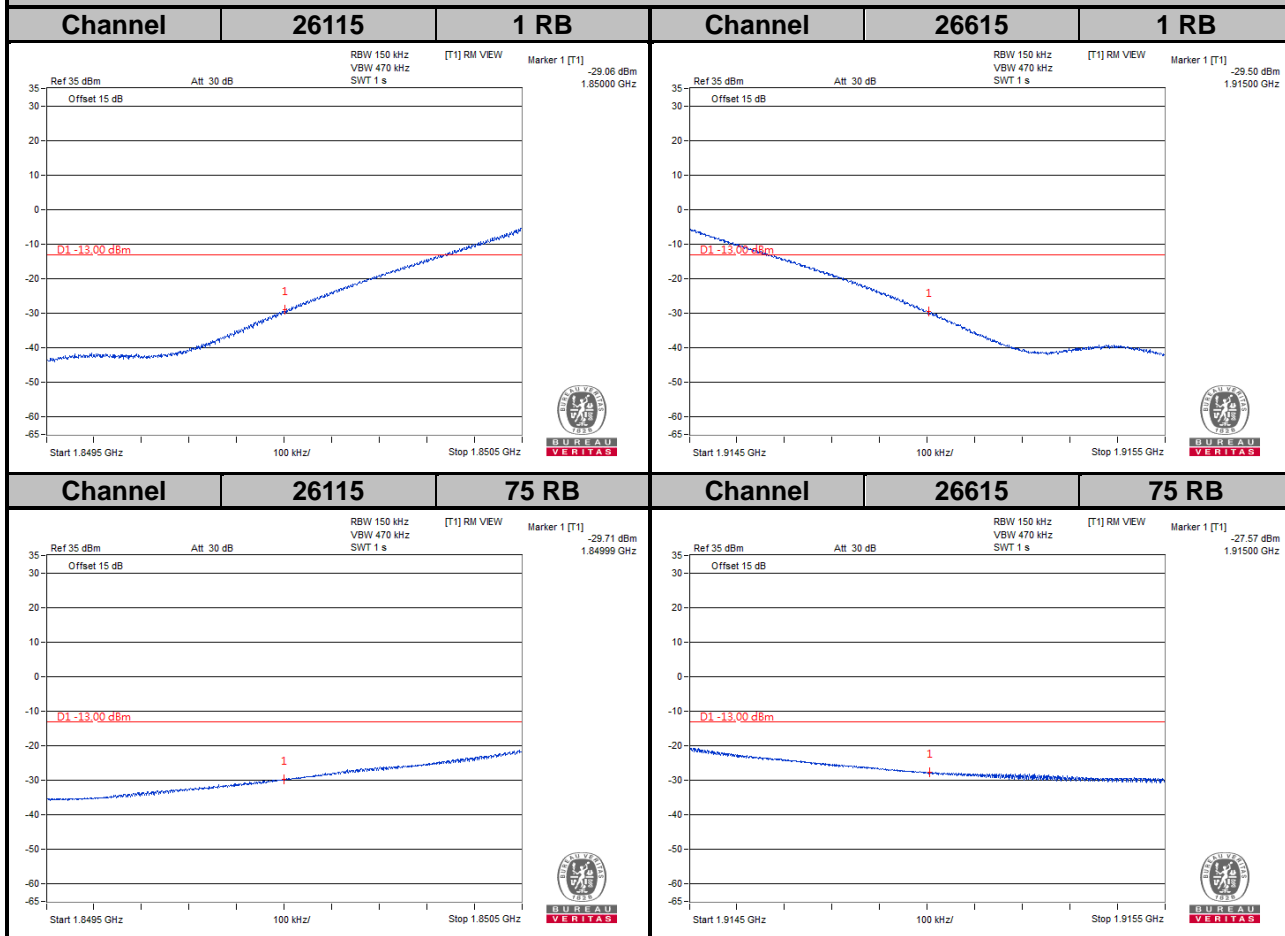

LTE Band 25
Channel Bandwidth: 20 MHz

