

FCC Test Report

(PART 22)

Report No.: RF181001C08-7

FCC ID: A4RG020B

Model Name: G020B

Received Date: Oct. 01, 2018

Test Date: Oct. 23, 2018 ~ Nov. 10, 2018

Issued Date: Dec. 27, 2018

Applicant: Google LLC

Address: 1600 Amphitheatre Parkway, Mountain View, CA 94043, USA

Issued By: Bureau Veritas Consumer Products Services (H.K.) Ltd., Taoyuan Branch

Lab Address: No. 47-2, 14th Ling, Chia Pau Vil., Lin Kou Dist., New Taipei City, Taiwan
(R.O.C)

Test Location (1): No. 19, Hwa Ya 2nd Rd, Wen Hwa Vil, Kwei Shan Dist., Taoyuan City
33383, Taiwan (R.O.C)

**FCC Registration /
Designation Number:** 788550 / TW0003



This report is for your exclusive use. Any copying or replication of this report to or for any other person or entity, or use of our name or trademark, is permitted only with our prior written permission. This report sets forth our findings solely with respect to the test samples identified herein. The results set forth in this report are not indicative or representative of the quality or characteristics of the lot from which a test sample was taken or any similar or identical product unless specifically and expressly noted. Our report includes all of the tests requested by you and the results thereof based upon the information that you provided to us. You have 60 days from date of issuance of this report to notify us of any material error or omission caused by our negligence, provided, however, that such notice shall be in writing and shall specifically address the issue you wish to raise. A failure to raise such issue within the prescribed time shall constitute your unqualified acceptance of the completeness of this report, the tests conducted and the correctness of the report contents. Unless specific mention, the uncertainty of measurement has been explicitly taken into account to declare the compliance or non-compliance to the specification. The report must not be used by the client to claim product certification, approval, or endorsement by TAF or any government agencies

Table of Contents

Release Control Record	4
1 Certificate of Conformity	5
2 Summary of Test Results	6
2.1 Measurement Uncertainty	6
2.2 Test Site and Instruments	7
3 General Information	9
3.1 General Description of EUT	9
3.2 Configuration of System under Test	11
3.2.1 Description of Support Units	11
3.3 Test Mode Applicability and Tested Channel Detail	12
3.4 EUT Operating Conditions	17
3.5 General Description of Applied Standards	18
4 Test Types and Results	19
4.1 Output Power Measurement	19
4.1.1 Limits of Output Power Measurement	19
4.1.2 Test Procedures	19
4.1.3 Test Setup	20
4.1.4 Test Results	21
4.2 Modulation Characteristics Measurement	34
4.2.1 Limits of Modulation Characteristics	34
4.2.2 Test Setup	34
4.2.3 Test Procedure	34
4.2.4 Test Results	35
4.3 Frequency Stability Measurement	38
4.3.1 Limits of Frequency Stability Measurement	38
4.3.2 Test Procedure	38
4.3.3 Test Setup	38
4.3.4 Test Results	39
4.4 Occupied Bandwidth Measurement	52
4.4.1 Test Procedure	52
4.4.2 Test Setup	52
4.4.3 Test Result	53
4.5 Band Edge Measurement	65
4.5.1 Limits of Band Edge Measurement	65
4.5.2 Test Setup	65
4.5.3 Test Procedures	65
4.5.4 Test Results	66
4.6 Peak to Average Ratio	77
4.6.1 Limits of Peak to Average Ratio Measurement	77
4.6.2 Test Setup	77
4.6.3 Test Procedures	77
4.6.4 Test Results	78
4.7 Conducted Spurious Emissions	84
4.7.1 Limits of Conducted Spurious Emissions Measurement	84
4.7.2 Test Setup	84
4.7.3 Test Procedure	84
4.7.4 Test Results	85
4.8 Radiated Emission Measurement	98
4.8.1 Limits of Radiated Emission Measurement	98
4.8.2 Test Procedure	98
4.8.3 Deviation from Test Standard	98
4.8.4 Test Setup	99
4.8.5 Test Results	100

5 Pictures of Test Arrangements.....	160
Appendix – Information on the Testing Laboratories	161

Release Control Record

Issue No.	Description	Date Issued
RF181001C08-7	Original Release	Dec. 27, 2018

1 Certificate of Conformity

Product: Smartphone

Model Name: G020B

Sample Status: Identical Prototype

Applicant: Google LLC

Test Date: Oct. 23, 2018 ~ Nov. 10, 2018

Standards: FCC Part 22, Subpart H

The above equipment has been tested by **Bureau Veritas Consumer Products Services (H.K.) Ltd., Taoyuan Branch**, and found compliance with the requirement of the above standards. The test record, data evaluation & Equipment Under Test (EUT) configurations represented herein are true and accurate accounts of the measurements of the sample's RF characteristics under the conditions specified in this report.

Prepared by : , **Date:** Dec. 27, 2018
Ivonne Wu / Supervisor

Approved by : , **Date:** Dec. 27, 2018
Dylan Chiou / Project Engineer

2 Summary of Test Results

Applied Standard: FCC Part 22 & Part 2			
FCC Clause	Test Item	Result	Remarks
2.1046 22.913 (a)	Effective Radiated Power	Pass	Meet the requirement of limit.
2.1047	Modulation Characteristics	Pass	Meet the requirement.
---	Peak to Average Ratio	Pass	Meet the requirement of limit.
2.1055 22.355	Frequency Stability	Pass	Meet the requirement of limit.
2.1049	Occupied Bandwidth	Pass	Meet the requirement of limit.
22.917	Band Edge Measurements	Pass	Meet the requirement of limit.
2.1051 22.917	Conducted Spurious Emissions	Pass	Meet the requirement of limit.
2.1053 22.917	Radiated Spurious Emissions	Pass	Meet the requirement of limit. Minimum passing margin is -34.13 dB at 40.67 MHz.

2.1 Measurement Uncertainty

Where relevant, the following measurement uncertainty levels have been estimated for tests performed on the EUT as specified in CISPR 16-4-2:

Measurement	Frequency	Expanded Uncertainty (k=2) (\pm)
Radiated Emissions up to 1 GHz	30 MHz ~ 200 MHz	2.93 dB
	200 MHz ~ 1000 MHz	2.95 dB
Radiated Emissions above 1 GHz	1 GHz ~ 18 GHz	2.26 dB
	18 GHz ~ 40 GHz	1.94 dB

2.2 Test Site and Instruments

Description & Manufacturer	Model No.	Serial No.	Date of Calibration	Due Date of Calibration
Test Receiver Agilent	N9038A	MY51210203	Mar. 16, 2018	Mar. 15, 2019
Spectrum Analyzer Keysight	N9010A	MY56070348	Sep. 06, 2018	Sep. 05, 2019
Spectrum Analyzer ROHDE & SCHWARZ	FSU43	101261	Jan. 11, 2018	Jan. 10, 2019
Spectrum Analyzer ROHDE & SCHWARZ	FSW26	102023	Oct. 11, 2018	Oct. 10, 2019
HORN Antenna SCHWARZBECK	BBHA 9120D	9120D-969	Dec. 12, 2017	Dec. 11, 2018
BILOG Antenna SCHWARZBECK	VULB 9168	9168-472	Dec. 06, 2017	Dec. 05, 2018
Fixed Attenuator Mini-Circuits	MDCS18N-10	MDCS18N-10-01	Apr. 16, 2018	Apr. 15, 2019
MXG Vector signal generator Agilent	N5182B	MY53052658	May 24, 2018	May 23, 2019
Preamplifier EMCI	EMC 012645	980115	Oct. 12, 2018	Oct. 11, 2019
Preamplifier EMCI	EMC 330H	980112	Oct. 12, 2018	Oct. 11, 2019
RF Coaxial Cable HUBER+SUHNNER	EMC104-SM-SM-800 0&3000	140811+170717	Oct. 12, 2018	Oct. 11, 2019
RF Coaxial Cable HUBER+SUHNNER	SUCOFLEX 104	EMC104-SM-SM-1 000(140807)	Oct. 12, 2018	Oct. 11, 2019
RF Coaxial Cable WOKEN	8D-FB	Cable-Ch10-01	Oct. 12, 2018	Oct. 11, 2019
Boresight Antenna Fixture	FBA-01	FBA-SIP01	NA	NA
Software BV ADT	E3 6.120103	NA	NA	NA
Antenna Tower MF	MFA-440H	NA	NA	NA
Turn Table MF	MFT-201SS	NA	NA	NA
Antenna Tower & Turn Table Controller MF	MF-7802	NA	NA	NA
Universal Radio Communication Tester R&S	CMU200	123112	Dec. 28, 2017	Dec. 27, 2018
Radio Communication Analyzer Anritsu	MT8820C	6201300640	Aug. 16, 2017	Aug. 15, 2019
Temperature & Humidity Chamber	GTH-120-40-CP-AR	MAA1306-019	Sep. 05, 2018	Sep. 04, 2019
DC Power Supply Topward	33010D	807748	NA	NA

- Note:
1. The calibration interval of the above test instruments is 12 / 24 months and the calibrations are traceable to NML/ROC and NIST/USA.
 2. The test was performed in HwaYa Chamber 10.
 3. The horn antenna and preamplifier (model: EMC 184045) are used only for the measurement of emission frequency above 1 GHz if tested.
 4. The IC Site Registration No. is 7450F-10.

3 General Information

3.1 General Description of EUT

Product	Smartphone	
Model Name	G020B	
Status of EUT	Identical Prototype	
Power Supply Rating	3.85 Vdc (Li-ion battery) 5.0 Vdc or 9 Vdc (adapter) 5.0 Vdc (host equipment)	
Modulation Type	GSM/GPRS	GMSK
	EDGE	GMSK, 8PSK
	WCDMA	QPSK
	CDMA	QPSK, OPQKS, HPSK
	LTE	QPSK, 16QAM, 64QAM
Frequency Range	GSM/GPRS/EDGE	824.2 ~ 848.8 MHz
	WCDMA	826.4 ~ 846.6 MHz
	CDMA	824.7 ~ 848.31 MHz
	LTE 5 (Channel Bandwidth: 1.4 MHz)	824.7 ~ 848.3 MHz
	LTE 5 (Channel Bandwidth: 3 MHz)	825.5 ~ 847.5 MHz
	LTE 5 (Channel Bandwidth: 5 MHz)	826.5 ~ 846.5 MHz
	LTE 5 (Channel Bandwidth: 10 MHz)	829 ~ 844 MHz
	LTE 26 (Channel Bandwidth: 1.4 MHz)	824.7 ~ 848.3 MHz
	LTE 26 (Channel Bandwidth: 3 MHz)	825.5 ~ 847.5 MHz
	LTE 26 (Channel Bandwidth: 5 MHz)	826.5 ~ 846.5 MHz
	LTE 26 (Channel Bandwidth: 10 MHz)	829 ~ 844 MHz
	LTE 26 (Channel Bandwidth: 15 MHz)	831.5 ~ 841.5 MHz
Max. ERP Power	GSM/GPRS	388.15 mW
	EDGE	118.85 mW
	WCDMA	52.84 mW
	CDMA	55.72 mW
	LTE 5 (Channel Bandwidth: 1.4 MHz)	75.34 mW
	LTE 5 (Channel Bandwidth: 3 MHz)	79.98 mW
	LTE 5 (Channel Bandwidth: 5 MHz)	84.33 mW
	LTE 5 (Channel Bandwidth: 10 MHz)	89.33 mW
	LTE 26 (Channel Bandwidth: 1.4 MHz)	48.64 mW
	LTE 26 (Channel Bandwidth: 3 MHz)	51.40 mW
	LTE 26 (Channel Bandwidth: 5 MHz)	54.20 mW
	LTE 26 (Channel Bandwidth: 10 MHz)	57.15 mW
LTE 26 (Channel Bandwidth: 15 MHz)	60.53 mW	

Emission Designator	GSM/GPRS	247KGXW
	EDGE	249KG7W
	WCDMA	4M16F9W
	CDMA	1M28F9W
	LTE 5 (Channel Bandwidth: 1.4 MHz)	1M09W7D
	LTE 5 (Channel Bandwidth: 3 MHz)	2M70G7D
	LTE 5 (Channel Bandwidth: 5 MHz)	4M50W7D
	LTE 5 (Channel Bandwidth: 10 MHz)	8M98W7D
	LTE 26 (Channel Bandwidth: 1.4 MHz)	1M09W7D
	LTE 26 (Channel Bandwidth: 3 MHz)	2M70G7D
	LTE 26 (Channel Bandwidth: 5 MHz)	4M50W7D
	LTE 26 (Channel Bandwidth: 10 MHz)	8M98W7D
	LTE 26 (Channel Bandwidth: 15 MHz)	13M5G7D
	Antenna Type	PIFA Antenna with -4.7 dBi gain
Accessory Device	Refer to Note as below	
Data Cable Supplied	Refer to Note as below	

Note:

- There're 2 configurations for the EUT listed as below.
 Main Sample: EUT + Battery 1
 2nd Sample: EUT + Battery 2
 ✧ After pre-tested with the EUT, only the worst configuration (main sample) was chosen for the final test.
- The EUT's accessories list refers to Ext. Pho.
- The above EUT information is declared by manufacturer and for more detailed features description, please refers to the manufacturer's specifications or user's manual.

3.2 Configuration of System under Test

<Radiated Emission Test>

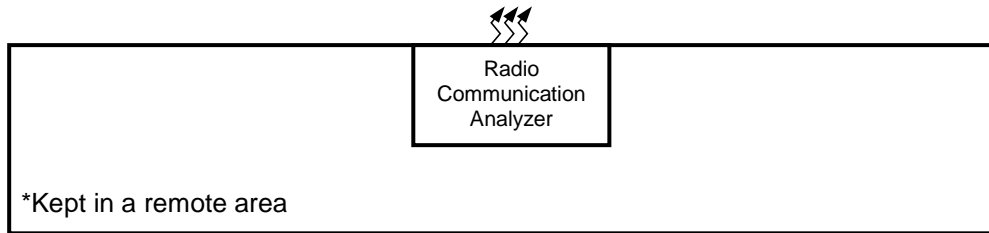
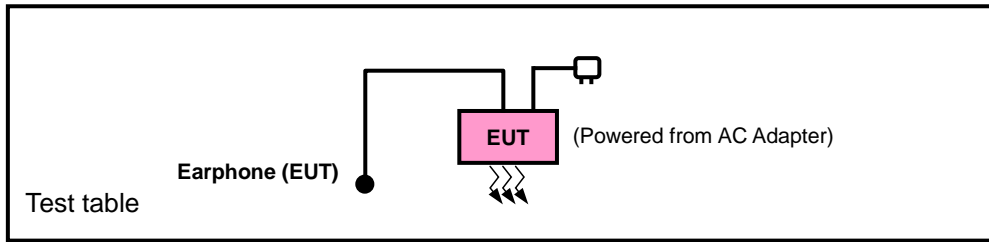

<E.R.P. Test>

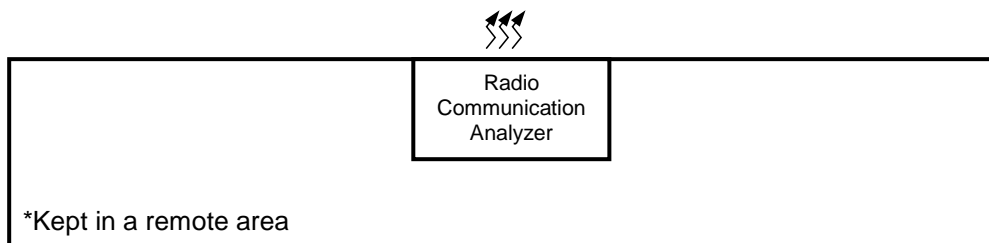
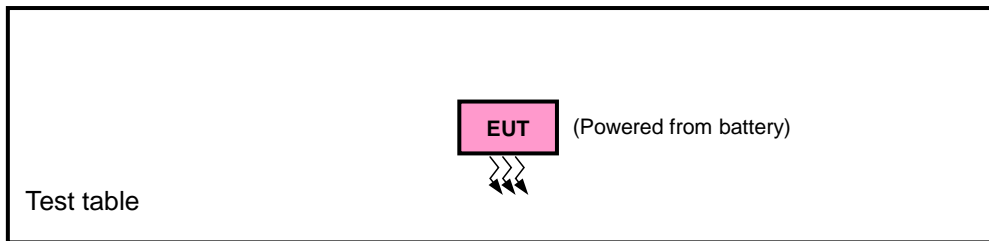

3.2.1 Description of Support Units

The EUT has been tested as an independent unit together with other necessary accessories or support units.

3.3 Test Mode Applicability and Tested Channel Detail

Pre-Scan has been conducted to determine the worst-case mode from all possible combinations between available modulations, data rates, XYZ axis, and antenna ports.

The worst case was found when positioned as the table below. Following channel(s) was (were) selected for the final test as listed below:

Band	ERP	Radiated Emission
GSM	X-plane	Y-axis
EDGE	X-plane	Y-axis
WCDMA	X-plane	Y-axis
CDMA	X-plane	Y-axis
LTE Band 5	X-plane	X-axis
LTE Band 26	X-plane	X-axis

GSM

EUT Configure Mode	Test Item	Available Channel	Tested Channel	Mode
-	ERP	128 to 251	128, 189, 251	GSM, EDGE
-	Modulation Characteristics	128 to 251	189	GSM, EDGE
-	Frequency Stability	128 to 251	128, 251	GSM, EDGE
-	Occupied Bandwidth	128 to 251	128, 189, 251	GSM, EDGE
-	Band Edge	128 to 251	128, 251	GSM, EDGE
-	Peak to Average Ratio	128 to 251	128, 189, 251	GSM, EDGE
-	Conducted Emission	128 to 251	128, 189, 251	GSM, EDGE
-	Radiated Emission	128 to 251	128, 189, 251	GSM, EDGE

WCDMA

EUT Configure Mode	Test Item	Available Channel	Tested Channel	Mode
-	ERP	4132 to 4233	4132, 4182, 4233	WCDMA
-	Modulation Characteristics	4132 to 4233	4182	WCDMA
-	Frequency Stability	4132 to 4233	4132, 4233	WCDMA
-	Occupied Bandwidth	4132 to 4233	4132, 4182, 4233	WCDMA
-	Band Edge	4132 to 4233	4132, 4233	WCDMA
-	Peak to Average Ratio	4132 to 4233	4132, 4182, 4233	WCDMA
-	Conducted Emission	4132 to 4233	4132, 4182, 4233	WCDMA
-	Radiated Emission	4132 to 4233	4132, 4182, 4233	WCDMA

CDMA

EUT Configure Mode	Test Item	Available Channel	Tested Channel	Mode
-	ERP	1013 to 777	1013, 384, 777	1xRTT
-	Modulation Characteristics	1013 to 777	384	1xRTT
-	Frequency Stability	1013 to 777	1013, 777	1xRTT
-	Occupied Bandwidth	1013 to 777	1013, 384, 777	1xRTT
-	Band Edge	1013 to 777	1013, 777	1xRTT
-	Peak to Average Ratio	1013 to 777	1013, 384, 777	1xRTT
-	Conducted Emission	1013 to 777	1013, 384, 777	1xRTT
-	Radiated Emission	1013 to 777	1013, 384, 777	1xRTT

LTE Band 5

EUT Configure Mode	Test Item	Available Channel	Tested Channel	Channel Bandwidth	Modulation	Mode
-	ERP	20407 to 20643	20407, 20525, 20643	1.4 MHz	QPSK, 16QAM, 64QAM	1 RB / 2 RB Offset
		20415 to 20635	20415, 20525, 20635	3 MHz	QPSK, 16QAM, 64QAM	1 RB / 7 RB Offset
		20425 to 20625	20425, 20525, 20625	5 MHz	QPSK, 16QAM, 64QAM	1 RB / 12 RB Offset
		20450 to 20600	20450, 20525, 20600	10 MHz	QPSK, 16QAM, 64QAM	1 RB / 24 RB Offset
-	Modulation Characteristics	20450 to 20600	20525	10 MHz	QPSK, 16QAM, 64QAM	50 RB / 0 RB Offset
-	Frequency Stability	20407 to 20643	20407, 20643	1.4 MHz	QPSK	1 RB / 0 RB Offset
		20415 to 20635	20415, 20635	3 MHz	QPSK	1 RB / 0 RB Offset
		20425 to 20625	20425, 20625	5 MHz	QPSK	1 RB / 0 RB Offset
		20450 to 20600	20450, 20600	10 MHz	QPSK	1 RB / 0 RB Offset
-	Occupied Bandwidth	20407 to 20643	20407, 20525, 20643	1.4 MHz	QPSK, 16QAM, 64QAM	6 RB / 0 RB Offset
		20415 to 20635	20415, 20525, 20635	3 MHz	QPSK, 16QAM, 64QAM	15 RB / 0 RB Offset
		20425 to 20625	20425, 20525, 20625	5 MHz	QPSK, 16QAM, 64QAM	25 RB / 0 RB Offset
		20450 to 20600	20450, 20525, 20600	10 MHz	QPSK, 16QAM, 64QAM	50 RB / 0 RB Offset
-	Band Edge	20407 to 20643	20407	1.4MHz	QPSK	1 RB / 0 RB Offset 6 RB / 0 RB Offset
			20643	1.4MHz	QPSK	1 RB / 5 RB Offset 6 RB / 0 RB Offset
		20415 to 20635	20415	3 MHz	QPSK	1 RB / 0 RB Offset 15 RB / 0 RB Offset
			20635	3 MHz	QPSK	1 RB / 14 RB Offset 15 RB / 0 RB Offset
		20425 to 20625	20425	5 MHz	QPSK	1 RB / 0 RB Offset 25 RB / 0 RB Offset
			20625	5 MHz	QPSK	1 RB / 24 RB Offset 25 RB / 0 RB Offset
		20450 to 20600	20450	10 MHz	QPSK	1 RB / 0 RB Offset 50 RB / 0 RB Offset
			20600	10 MHz	QPSK	1 RB / 49 RB Offset 50 RB / 0 RB Offset

EUT Configure Mode	Test Item	Available Channel	Tested Channel	Channel Bandwidth	Modulation	Mode
-	Peak to Average Ratio	20407 to 20643	20407, 20525, 20643	1.4 MHz	QPSK, 16QAM, 64QAM	1 RB / 0 RB Offset
		20415 to 20635	20415, 20525, 20635	3 MHz	QPSK, 16QAM, 64QAM	1 RB / 0 RB Offset
		20425 to 20625	20425, 20525, 20625	5 MHz	QPSK, 16QAM, 64QAM	1 RB / 0 RB Offset
		20450 to 20600	20450, 20525, 20600	10 MHz	QPSK, 16QAM, 64QAM	1 RB / 0 RB Offset
-	Conducted Emission	20407 to 20643	20407, 20525, 20643	1.4 MHz	QPSK	1 RB / 2 RB Offset
		20415 to 20635	20415, 20525, 20635	3 MHz	QPSK	1 RB / 7 RB Offset
		20425 to 20625	20425, 20525, 20625	5 MHz	QPSK	1 RB / 12 RB Offset
		20450 to 20600	20450, 20525, 20600	10 MHz	QPSK	1 RB / 24 RB Offset
-	Radiated Emission	20407 to 20643	20407, 20525, 20643	1.4 MHz	QPSK	1 RB / 2 RB Offset
		20425 to 20625	20425, 20525, 20625	5 MHz	QPSK	1 RB / 12 RB Offset
		20450 to 20600	20450, 20525, 20600	10 MHz	QPSK	1 RB / 24 RB Offset

Note: This device was tested under all bandwidths, RB configurations and modulations. The worst case was found in QPSK modulation.

LTE Band 26

EUT Configure Mode	Test Item	Available Channel	Tested Channel	Channel Bandwidth	Modulation	Mode
-	ERP	26797 to 27033	26797, 26915, 27033	1.4 MHz	QPSK, 16QAM, 64QAM	1 RB / 2 RB Offset
		26805 to 27025	26805, 26915, 27025	3 MHz	QPSK, 16QAM, 64QAM	1 RB / 7 RB Offset
		26815 to 27015	26815, 26915, 27015	5 MHz	QPSK, 16QAM, 64QAM	1 RB / 12 RB Offset
		26840 to 26990	26840, 26915, 26990	10 MHz	QPSK, 16QAM, 64QAM	1 RB / 24 RB Offset
		26865 to 26965	26865, 26915, 26965	15 MHz	QPSK, 16QAM, 64QAM	1 RB / 37 RB Offset
-	Modulation Characteristics	26840 to 26990	26915	10 MHz	QPSK, 16QAM, 64QAM	50 RB / 0 RB Offset
-	Frequency Stability	26797 to 27033	26797, 27033	1.4 MHz	QPSK	1 RB / 0 RB Offset
		26805 to 27025	26805, 27025	3 MHz	QPSK	1 RB / 0 RB Offset
		26815 to 27015	26815, 27015	5 MHz	QPSK	1 RB / 0 RB Offset
		26840 to 26990	26840, 26990	10 MHz	QPSK	1 RB / 0 RB Offset
		26865 to 26965	26865, 26965	15 MHz	QPSK	1 RB / 0 RB Offset
-	Occupied Bandwidth	26797 to 27033	26797, 26915, 27033	1.4 MHz	QPSK, 16QAM, 64QAM	6 RB / 0 RB Offset
		26805 to 27025	26805, 26915, 27025	3 MHz	QPSK, 16QAM, 64QAM	15 RB / 0 RB Offset
		26815 to 27015	26815, 26915, 27015	5 MHz	QPSK, 16QAM, 64QAM	25 RB / 0 RB Offset
		26840 to 26990	26840, 26915, 26990	10 MHz	QPSK, 16QAM, 64QAM	50 RB / 0 RB Offset
		26865 to 26965	26865, 26915, 26965	15 MHz	QPSK, 16QAM, 64QAM	75 RB / 0 RB Offset
-	Band Edge	26797 to 27033	26797	1.4 MHz	QPSK	1 RB / 0 RB Offset 6 RB / 0 RB Offset
			27033	1.4 MHz	QPSK	1 RB / 5 RB Offset 6 RB / 0 RB Offset
		26805 to 27025	26805	3 MHz	QPSK	1 RB / 0 RB Offset 15 RB / 0 RB Offset
			27025	3 MHz	QPSK	1 RB / 14 RB Offset 15 RB / 0 RB Offset
		26815 to 27015	26815	5 MHz	QPSK	1 RB / 0 RB Offset 25 RB / 0 RB Offset
			27015	5 MHz	QPSK	1 RB / 24 RB Offset 25 RB / 0 RB Offset
		26840 to 26990	26840	10 MHz	QPSK	1 RB / 0 RB Offset 50 RB / 0 RB Offset
			26990	10 MHz	QPSK	1 RB / 49 RB Offset 50 RB / 0 RB Offset
		26865 to 26965	26865	15 MHz	QPSK	1 RB / 0 RB Offset 75 RB / 0 RB Offset
			26965	15 MHz	QPSK	1 RB / 74 RB Offset 75 RB / 0 RB Offset

EUT Configure Mode	Test Item	Available Channel	Tested Channel	Channel Bandwidth	Modulation	Mode
-	Peak to Average Ratio	26797 to 27033	26797, 26915, 27033	1.4 MHz	QPSK, 16QAM, 64QAM	1 RB / 0 RB Offset
		26805 to 27025	26805, 26915, 27025	3 MHz	QPSK, 16QAM, 64QAM	1 RB / 0 RB Offset
		26815 to 27015	26815, 26915, 27015	5 MHz	QPSK, 16QAM, 64QAM	1 RB / 0 RB Offset
		26840 to 26990	26840, 26915, 26990	10 MHz	QPSK, 16QAM, 64QAM	1 RB / 0 RB Offset
		26865 to 26965	26865, 26915, 26965	15 MHz	QPSK, 16QAM, 64QAM	1 RB / 0 RB Offset
-	Conducted Emission	26797 to 27033	26797, 26915, 27033	1.4 MHz	QPSK	1 RB / 2 RB Offset
		26805 to 27025	26805, 26915, 27025	3 MHz	QPSK	1 RB / 7 RB Offset
		26815 to 27015	26815, 26915, 27015	5 MHz	QPSK	1 RB / 12 RB Offset
		26840 to 26990	26840, 26915, 26990	10 MHz	QPSK	1 RB / 24 RB Offset
		26865 to 26965	26865, 26915, 26965	15 MHz	QPSK	1 RB / 37 RB Offset
-	Radiated Emission	26797 to 27033	26797, 26915, 27033	1.4 MHz	QPSK	1 RB / 2 RB Offset
		26815 to 27015	26815, 26915, 27015	5 MHz	QPSK	1 RB / 12 RB Offset
		26865 to 26965	26865, 26915, 26965	15 MHz	QPSK	1 RB / 37 RB Offset

Note: This device was tested under all bandwidths, RB configurations and modulations. The worst case was found in QPSK modulation.

Test Condition:

Test Item	Environmental Conditions	Input Power	Tested By
ERP	25 deg. C, 65 % RH	3.85 Vdc	Thomas Wei
Modulation Characteristics	25 deg. C, 65 % RH	3.85 Vdc	Wayne Lin
Frequency Stability	25 deg. C, 65 % RH	3.85 Vdc	Wayne Lin
Occupied Bandwidth	25 deg. C, 65 % RH	3.85 Vdc	Wayne Lin
Band Edge	25 deg. C, 65 % RH	3.85 Vdc	Wayne Lin
Peak to Average Ratio	25 deg. C, 65 % RH	3.85 Vdc	Wayne Lin
Conducted Emission	25 deg. C, 65 % RH	3.85 Vdc	Wayne Lin
Radiated Emission	25 deg. C, 65 % RH	120 Vac, 60 Hz	Thomas Wei

3.4 EUT Operating Conditions

The EUT makes a call to the communication simulator. The communication simulator station system controlled a EUT to export maximum output power under transmission mode and specific channel frequency.

3.5 General Description of Applied Standards

The EUT is a RF Product. According to the specifications of the manufacturer, it must comply with the requirements of the following standards:

FCC 47 CFR Part 2

FCC 47 CFR Part 22

KDB 971168 D01 Power Meas License Digital Systems v03r01

ANSI/TIA/EIA-603-E 2016

ANSI 63.26-2015

Note: All test items have been performed and recorded as per the above standards.

4 Test Types and Results

4.1 Output Power Measurement

4.1.1 Limits of Output Power Measurement

Mobile / Portable station are limited to 7 watts e.r.p.

4.1.2 Test Procedures

EIRP / ERP Measurement:

- a. All measurements were done at low, middle and high operational frequency range. RBW and VBW is 1 MHz for GSM, GPRS & EDGE, and 5 MHz for WCDMA and CDMA, and 10 MHz for LTE mode.
- b. Substitution method is used for E.I.R.P measurement. In the semi-anechoic chamber, EUT placed on the 0.8 m (below or equal 1 GHz) and/or 1.5 m (above 1 GHz) height of Turn Table, rotated the table around 360 degrees to search the maximum radiation power and receiver antenna shall be rotated vertical and horizontal polarization and moved height from 1 m to 4 m to find the maximum polar radiated power. The "Read Value" is the spectrum reading the maximum power value.
- c. The substitution horn antenna is substituted for EUT at the same position and signals generator export the CW signal to the substitution antenna via a tx cable. Rotated the Turn Table and moved receiving antenna to find the maximum radiation power. Adjust output power level of S.G to get a Value of spectrum reading equal to "Read Value" of step b. Record the power level of S.G.
- d. $EIRP = \text{Output power level of S.G} - \text{TX cable loss} + \text{Antenna gain of substitution horn}$. E.R.P power can be calculated form E.I.R.P power by subtracting the gain of dipole, $E.R.P \text{ power} = E.I.R.P \text{ power} - 2.15 \text{ dB}$.

Conducted Power Measurement:

The EUT was set up for the maximum power with GSM, GPRS, EDGE, WCDMA, CDMA, and LTE link data modulation and link up with simulator. Set the EUT to transmit under low, middle and high channel and record the power level shown on simulator.

4.1.3 Test Setup

EIRP / ERP Measurement:

<Radiated Emission below or equal 1 GHz>

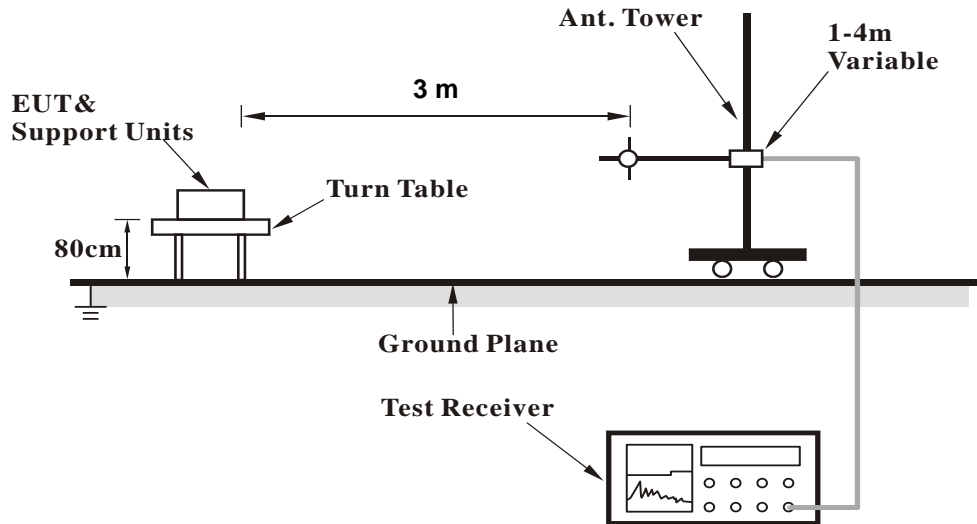

<Radiated Emission above 1 GHz>

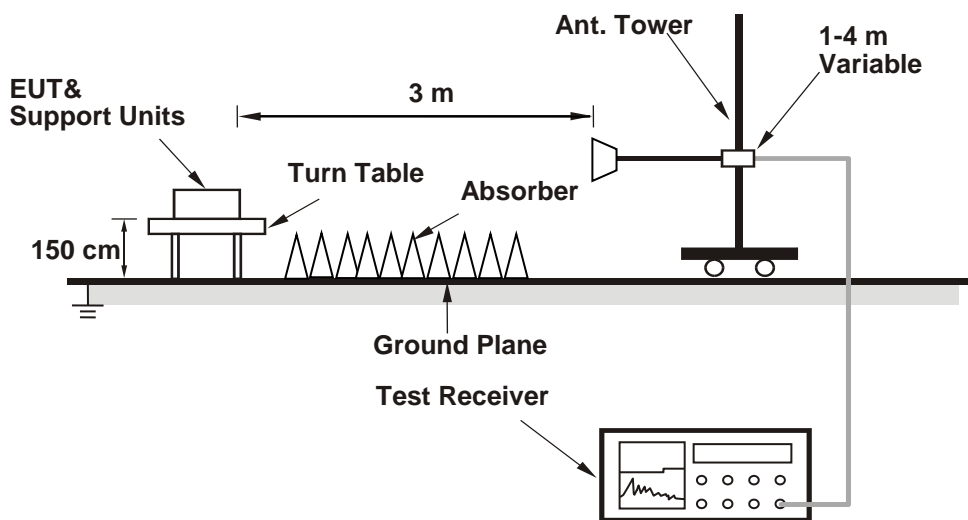

For the actual test configuration, please refer to the attached file (Test Setup Photo).

Conducted Power Measurement:

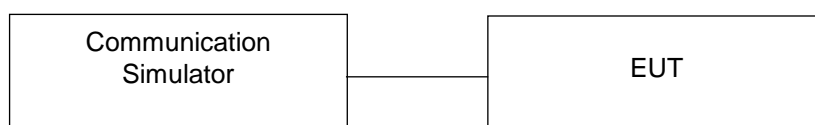

4.1.4 Test Results

The worst configuration mode is presented in the report as below. Please refer to SAR test report for more detail test mode.

Band		TX Antenna	WLAN Function	Body-Worn/Hotspot
GSM	850	Ant 0	WLAN-Off	Body-Worn/Hotspot
WCDMA	B5	Ant 0	WLAN-Off	Body-Worn/Hotspot
CDMA	BC0	Ant 0	WLAN-Off	Body-Worn/Hotspot
LTE	B5	Ant 0	WLAN-Off	Body-Worn/Hotspot
	B26	Ant 0	WLAN-Off	Body-Worn/Hotspot

Conducted Output Power (dBm)

Band	GSM850		
Mode	Body-Worn / Hotspot		
Tx Antenna	Ant-0		
Channel	128	189	251
Frequency (MHz)	824.2	836.4	848.8
GSM (GMSK, 1Tx-slot)	33.12	33.00	32.95
GPRS (GMSK, 1Tx-slot)	33.08	32.96	32.91
GPRS (GMSK, 2Tx-slot)	31.17	31.05	31.00
GPRS (GMSK, 3Tx-slot)	28.84	28.72	28.67
GPRS (GMSK, 4Tx-slot)	27.65	27.53	27.48
DTM (GMSK, 2Tx-slot)	30.97	30.85	30.88
DTM (GMSK, 3Tx-slot)	28.65	28.53	28.48
EDGE (8PSK, 1Tx-slot)	27.22	27.10	27.05
EDGE (8PSK, 2Tx-slot)	25.87	25.84	25.87
EDGE (8PSK, 3Tx-slot)	23.82	23.70	23.65
EDGE (8PSK, 4Tx-slot)	21.87	21.75	21.70
DTM (8PSK, 2Tx-slot)	25.89	25.77	25.88
DTM (8PSK, 3Tx-slot)	23.85	23.73	23.68

Band	WCDMA V		
Mode	Body-Worn / Hotspot		
Tx Antenna	Ant-0		
Channel	4132	4182	4233
Frequency (MHz)	826.4	836.4	846.6
RMC 12.2K	23.63	23.65	23.61
HSDPA Subtest-1	22.64	22.66	22.62
HSDPA Subtest-2	22.63	22.65	22.61
HSDPA Subtest-3	22.15	22.17	22.13
HSDPA Subtest-4	22.13	22.15	22.11
DC-HSDPA Subtest-1	22.55	22.57	22.53
DC-HSDPA Subtest-2	22.54	22.56	22.52
DC-HSDPA Subtest-3	22.06	22.08	22.04
DC-HSDPA Subtest-4	22.04	22.06	22.02
HSUPA Subtest-1	22.63	22.65	22.61
HSUPA Subtest-2	20.67	20.69	20.65
HSUPA Subtest-3	21.71	21.73	21.69
HSUPA Subtest-4	20.59	20.61	20.57
HSUPA Subtest-5	22.69	22.71	22.67

Band	CDMA BC0		
Mode	Body-Worn / Hotspot		
Tx Antenna	Ant-0		
Channel	1013	384	777
Frequency (MHz)	824.70	836.52	848.31
RC1+SO55	24.33	24.39	24.32
RC3+SO55	24.41	24.47	24.34
RC3+SO32(+ F-SCH)	24.36	24.39	24.30
RC3+SO32(+SCH)	24.39	24.42	24.31
RTAP 153.6	24.44	24.48	24.37
RETAP 4096	24.39	24.43	24.32

LTE Band 5																		
Body-Worn / Hotspot																		
Ant-0																		
BW	MCS Index	RB Size	RB Offset	Low	Mid	High	3GPP MPR (dB)	BW	MCS Index	RB Size	RB Offset	Low	Mid	High	3GPP MPR (dB)			
				20450	20525	20600						20425	20525	20625				
				Channel Frequency (MHz)	829.0	836.5						844.0	Channel Frequency (MHz)	826.5		836.5	846.5	
10M	QPSK	1	0	24.62	24.72	24.85	0	5M	QPSK	1	0	24.56	24.66	24.79	0			
		1	24	24.77	24.87	25.00	0			1	12	24.71	24.81	24.94	0			
		1	49	24.66	24.76	24.89	0			1	24	24.60	24.70	24.83	0			
		25	0	23.79	23.89	24.02	1			12	0	23.73	23.83	23.96	1			
		25	12	23.86	23.96	24.09	1			12	6	23.80	23.90	24.03	1			
		25	25	23.83	23.93	24.06	1			12	13	23.77	23.87	24.00	1			
	16QAM	50	0	23.57	23.67	23.80	1		25	0	23.51	23.61	23.74	1				
		1	0	23.64	23.74	23.87	1		16QAM	1	0	23.58	23.68	23.81	1			
		1	24	23.79	23.89	24.02	1			1	12	23.73	23.83	23.96	1			
		1	49	23.68	23.78	23.91	1			1	24	23.62	23.72	23.85	1			
		25	0	22.81	22.91	23.04	2			12	0	22.75	22.85	22.98	2			
		25	12	22.88	22.98	23.11	2			12	6	22.82	22.92	23.05	2			
	25	25	22.85	22.95	23.08	2	12			13	22.79	22.89	23.02	2				
	64QAM	50	0	22.59	22.69	22.82	2		64QAM	25	0	22.53	22.63	22.76	2			
		1	0	22.62	22.72	22.85	2			1	0	22.56	22.66	22.79	2			
		1	24	22.77	22.87	23.00	2			1	12	22.71	22.81	22.94	2			
		1	49	22.66	22.76	22.89	2			1	24	22.60	22.70	22.83	2			
		25	0	21.79	21.89	22.02	3			12	0	21.73	21.83	21.96	3			
		25	12	21.86	21.96	22.09	3			12	6	21.80	21.90	22.03	3			
	3M	QPSK	25	25	21.83	21.93	22.06		3	1.4M	QPSK	12	13	21.77	21.87	22.00	3	
			25	0	21.57	21.67	21.80		3			25	0	21.51	21.61	21.74	3	
			1	0	24.52	24.62	24.75		0			16QAM	1	0	24.48	24.58	24.71	0
			1	7	24.67	24.77	24.90		0				1	2	24.63	24.73	24.86	0
			1	14	24.56	24.66	24.79		0				1	5	24.52	24.62	24.75	0
8			0	23.69	23.79	23.92	1	3	0				24.43	24.53	24.66	0		
8		3	23.76	23.86	23.99	1	3	1	24.50		24.60		24.73	0				
8		7	23.73	23.83	23.96	1	3	3	24.47		24.57		24.70	0				
16QAM		15	0	23.47	23.57	23.70	1	16QAM	6		0	23.43	23.53	23.66	1			
		1	0	23.54	23.64	23.77	1		1		0	23.50	23.60	23.73	1			
		1	7	23.69	23.79	23.92	1		1		2	23.65	23.75	23.88	1			
		1	14	23.58	23.68	23.81	1		1		5	23.54	23.64	23.77	1			
		8	0	22.71	22.81	22.94	2		3		0	23.52	23.62	23.75	1			
		8	3	22.78	22.88	23.01	2		3		1	23.59	23.69	23.82	1			
64QAM		8	7	22.75	22.85	22.98	2	64QAM	3		3	23.56	23.66	23.79	1			
		8	0	22.49	22.59	22.72	2		6		0	22.45	22.55	22.68	2			
		1	0	22.52	22.62	22.75	2		1		0	22.48	22.58	22.71	2			
		1	7	22.67	22.77	22.90	2		1		2	22.63	22.73	22.86	2			
		1	14	22.56	22.66	22.79	2		1		5	22.52	22.62	22.75	2			
		8	0	21.69	21.79	21.92	3		3		0	22.50	22.60	22.73	2			
1.4M		64QAM	8	3	21.76	21.86	21.99	3	64QAM		3	1	22.57	22.67	22.80	2		
			8	7	21.73	21.83	21.96	3			3	3	22.54	22.64	22.77	2		
			15	0	21.47	21.57	21.70	3			6	0	21.43	21.53	21.66	3		

LTE Band 26
Body-Worn / Hotspot
Ant-0

BW	MCS Index	RB Size	RB Offset	Low	Mid	High	3GPP MPR (dB)	BW	MCS Index	RB Size	RB Offset	Low	Mid	High	3GPP MPR (dB)		
				26865	26915	26965						26840	26915	26990			
				Channel Frequency (MHz)	831.5	836.5						841.5	829.0	836.5		844.0	
15M	QPSK	1	0	24.56	24.56	24.79	0	10M	QPSK	1	0	24.48	24.47	24.65	0		
		1	37	24.69	24.66	24.82	0			1	24	24.57	24.56	24.68	0		
		1	74	24.77	24.74	23.99	0			1	49	24.65	24.74	23.85	0		
		36	0	23.63	23.56	23.92	1			25	0	23.61	23.42	23.78	1		
		36	19	23.79	23.73	23.88	1			25	12	23.67	23.69	23.74	1		
		36	39	23.81	23.77	23.77	1			25	25	23.73	23.74	23.63	1		
		75	0	23.73	23.63	23.75	1			50	0	23.63	23.58	23.61	1		
	16QAM	1	0	23.55	23.50	23.75	1		16QAM	1	0	23.53	23.39	23.61	1		
		1	37	23.68	23.59	23.78	1			1	24	23.63	23.57	23.64	1		
		1	74	23.76	23.66	22.95	1			1	49	23.72	23.54	22.81	1		
		36	0	22.62	22.57	22.88	2			25	0	22.52	22.43	22.74	2		
		36	19	22.78	22.76	22.84	2			25	12	22.71	22.62	22.70	2		
		36	39	22.80	22.71	22.73	2			25	25	22.74	22.58	22.59	2		
		75	0	22.72	22.65	22.71	2			50	0	22.62	22.55	22.57	2		
	64QAM	1	0	22.51	22.47	22.69	2		64QAM	1	0	22.37	22.46	22.55	2		
		1	37	22.64	22.61	22.72	2			1	24	22.57	22.51	22.58	2		
		1	74	22.72	22.63	21.89	2			1	49	22.69	22.61	21.75	2		
		36	0	21.58	21.49	21.82	3			25	0	21.48	21.36	21.68	3		
		36	19	21.74	21.66	21.78	3			25	12	21.74	21.55	21.64	3		
		36	39	21.76	21.66	21.67	3			25	25	21.66	21.65	21.53	3		
		75	0	21.68	21.66	21.65	3			50	0	21.66	21.61	21.51	3		
	BW	MCS Index	RB Size	RB Offset	Low	Mid	High		3GPP MPR (dB)	BW	MCS Index	RB Size	RB Offset	Low	Mid	High	3GPP MPR (dB)
					26815	26915	27015							26805	26915	27025	
					Channel Frequency (MHz)	826.5	836.5							846.5	825.5	836.5	
5M	QPSK	1	0	24.37	24.44	24.61	0	3M	QPSK	1	0	24.46	24.62	24.58	1		
		1	12	24.48	24.46	24.64	0			1	7	24.45	24.56	24.61	1		
		1	24	24.58	24.59	23.81	0			1	14	24.69	23.74	23.78	1		
		12	0	23.46	23.28	23.74	1			8	0	23.68	23.67	23.71	3		
		12	6	23.65	23.64	23.70	1			8	3	23.65	23.65	23.67	3		
		12	13	23.73	23.62	23.59	1			8	7	23.65	23.51	23.56	3		
		25	0	23.56	23.44	23.57	1			15	0	23.56	23.56	23.54	6		
	16QAM	1	0	23.48	23.28	23.57	1		16QAM	1	0	23.24	23.56	23.54	1		
		1	12	23.55	23.42	23.60	1			1	7	23.44	23.61	23.57	1		
		1	24	23.61	23.44	22.77	1			1	14	23.40	22.69	22.74	1		
		12	0	22.37	22.37	22.70	2			8	0	22.41	22.59	22.67	2		
		12	6	22.66	22.62	22.66	2			8	3	22.51	22.69	22.63	2		
		12	13	22.72	22.43	22.55	2			8	7	22.44	22.51	22.52	2		
		25	0	22.50	22.41	22.53	2			15	0	22.42	22.52	22.50	2		
	64QAM	1	0	22.29	22.46	22.51	2		64QAM	1	0	22.36	22.42	22.48	2		
		1	12	22.51	22.50	22.54	2			1	7	22.36	22.54	22.51	2		
		1	24	22.60	22.51	21.71	2			1	14	22.61	21.68	21.74	2		
		12	0	21.48	21.30	21.64	3			8	0	21.22	21.65	21.61	3		
		12	6	21.60	21.50	21.60	3			8	3	21.52	21.62	21.57	3		
		12	13	21.64	21.56	21.49	3			8	7	21.58	21.44	21.46	3		
		25	0	21.66	21.60	21.47	3			15	0	21.59	21.44	21.44	3		
	BW	MCS Index	RB Size	RB Offset	Low	Mid	High		3GPP MPR (dB)								
					26797	26915	27033										
					Channel Frequency (MHz)	824.7	836.5										
1.4M	QPSK	1	0	24.39	24.61	24.34	0										
		1	2	24.56	24.60	24.52	0										
		1	5	24.65	23.70	24.50	0										
		3	0	24.38	24.67	24.19	0										
		3	1	24.61	24.59	24.14	0										
		3	3	24.74	24.59	24.11	0										
	6	0	23.51	23.50	23.85	1											
	16QAM	1	0	23.36	23.51	23.36	1										
		1	2	23.47	23.55	23.68	1										
		1	5	23.41	22.66	22.82	1										
		3	0	23.38	23.60	24.06	1										
		3	1	23.60	23.58	24.08	1										
		3	3	23.57	23.56	23.53	1										
	6	0	22.41	22.55	22.87	2											
	64QAM	1	0	22.41	22.48	22.48	2										
		1	2	22.51	22.52	22.80	2										
		1	5	22.60	21.69	22.85	2										
		3	0	22.33	22.60	22.78	2										
		3	1	22.51	22.53	22.96	2										
		3	3	22.63	22.50	23.01	2										
	6	0	21.46	21.43	21.99	3											

ERP Power (dBm)

GSM							
Plane	Channel	Frequency (MHz)	Reading (dBm)	Correction Factor (dB)	ERP (dBm)	ERP (mW)	Polarization (H/V)
X	128	824.2	-4.66	32.62	25.81	381.07	H
	189	836.4	-4.48	32.52	25.89	388.15	
	251	848.8	-4.75	32.65	25.75	375.84	
	128	824.2	-10.93	32.76	19.68	92.90	V
	189	836.4	-10.39	32.39	19.85	96.61	
	251	848.8	-10.78	32.54	19.61	91.41	

Note: ERP (dBm) = Reading (dBm) + Correction Factor (dB) – 2.15

EDGE							
Plane	Channel	Frequency (MHz)	Reading (dBm)	Correction Factor (dB)	ERP (dBm)	ERP (mW)	Polarization (H/V)
X	128	824.2	-9.76	32.62	20.71	117.76	H
	189	836.4	-9.62	32.52	20.75	118.85	
	251	848.8	-9.82	32.65	20.68	116.95	
	128	824.2	-18.60	32.76	12.01	15.89	V
	189	836.4	-17.72	32.39	12.52	17.86	
	251	848.8	-18.54	32.54	11.85	15.31	

Note: ERP (dBm) = Reading (dBm) + Correction Factor (dB) – 2.15

WCDMA							
Plane	Channel	Frequency (MHz)	Reading (dBm)	Correction Factor (dB)	ERP (dBm)	ERP (mW)	Polarization (H/V)
X	4132	826.4	-13.29	32.62	17.18	52.24	H
	4182	836.4	-13.14	32.52	17.23	52.84	
	4233	846.6	-13.39	32.65	17.11	51.40	
	4132	826.4	-19.19	32.76	11.42	13.87	V
	4182	836.4	-18.72	32.39	11.52	14.19	
	4233	846.6	-19.05	32.54	11.34	13.61	

Note: ERP (dBm) = Reading (dBm) + Correction Factor (dB) – 2.15

CDMA							
Plane	Channel	Frequency (MHz)	Reading (dBm)	Correction Factor (dB)	ERP (dBm)	ERP (mW)	Polarization (H/V)
X	1013	824.7	-13.16	32.62	17.31	53.83	H
	384	836.52	-12.91	32.52	17.46	55.72	
	777	848.31	-13.25	32.65	17.25	53.09	
	1013	824.7	-20.30	32.76	10.31	10.74	V
	384	836.52	-19.72	32.39	10.52	11.27	
	777	848.31	-20.24	32.54	10.15	10.35	

Note: ERP (dBm) = Reading (dBm) + Correction Factor (dB) – 2.15

LTE Band 5							
Channel Bandwidth: 1.4 MHz / QPSK							
Plane	Channel	Frequency (MHz)	Reading (dBm)	Correction Factor (dB)	ERP (dBm)	ERP (mW)	Polarization (H/V)
X	20407	824.7	-11.98	32.62	18.49	70.63	H
	20525	836.5	-11.75	32.52	18.62	72.78	
	20643	848.3	-11.73	32.65	18.77	75.34	
	20407	824.7	-19.32	32.76	11.29	13.46	V
	20525	836.5	-18.55	32.39	11.69	14.76	
	20643	848.3	-18.45	32.54	11.94	15.63	
Channel Bandwidth: 1.4 MHz / 16QAM							
X	20407	824.7	-12.98	32.62	17.49	56.10	H
	20525	836.5	-12.75	32.52	17.62	57.81	
	20643	848.3	-12.73	32.65	17.77	59.84	
	20407	824.7	-20.32	32.76	10.29	10.69	V
	20525	836.5	-19.55	32.39	10.69	11.72	
	20643	848.3	-19.45	32.54	10.94	12.42	
Channel Bandwidth: 1.4 MHz / 64QAM							
X	20407	824.7	-13.96	32.62	16.51	44.77	H
	20525	836.5	-13.73	32.52	16.64	46.13	
	20643	848.3	-13.71	32.65	16.79	47.75	
	20407	824.7	-21.30	32.76	9.31	8.53	V
	20525	836.5	-20.53	32.39	9.71	9.35	
	20643	848.3	-20.43	32.54	9.96	9.91	

Note: ERP (dBm) = Reading (dBm) + Correction Factor (dB) – 2.15

LTE Band 5							
Channel Bandwidth: 3 MHz / QPSK							
Plane	Channel	Frequency (MHz)	Reading (dBm)	Correction Factor (dB)	ERP (dBm)	ERP (mW)	Polarization (H/V)
X	20415	825.5	-11.72	32.62	18.75	74.99	H
	20525	836.5	-11.49	32.52	18.88	77.27	
	20635	847.5	-11.47	32.65	19.03	79.98	
	20415	825.5	-19.06	32.76	11.55	14.29	V
	20525	836.5	-18.29	32.39	11.95	15.67	
	20635	847.5	-18.19	32.54	12.20	16.60	
Channel Bandwidth: 3 MHz / 16QAM							
X	20415	825.5	-12.74	32.62	17.73	59.29	H
	20525	836.5	-12.51	32.52	17.86	61.09	
	20635	847.5	-12.49	32.65	18.01	63.24	
	20415	825.5	-20.08	32.76	10.53	11.30	V
	20525	836.5	-19.31	32.39	10.93	12.39	
	20635	847.5	-19.21	32.54	11.18	13.12	
Channel Bandwidth: 3 MHz / 64QAM							
X	20415	825.5	-13.71	32.62	16.76	47.42	H
	20525	836.5	-13.48	32.52	16.89	48.87	
	20635	847.5	-13.46	32.65	17.04	50.58	
	20415	825.5	-21.05	32.76	9.56	9.04	V
	20525	836.5	-20.28	32.39	9.96	9.91	
	20635	847.5	-20.18	32.54	10.21	10.50	

Note: ERP (dBm) = Reading (dBm) + Correction Factor (dB) – 2.15

LTE Band 5							
Channel Bandwidth: 5 MHz / QPSK							
Plane	Channel	Frequency (MHz)	Reading (dBm)	Correction Factor (dB)	ERP (dBm)	ERP (mW)	Polarization (H/V)
X	20425	826.5	-11.49	32.62	18.98	79.07	H
	20525	836.5	-11.26	32.52	19.11	81.47	
	20625	846.5	-11.24	32.65	19.26	84.33	
	20425	826.5	-18.83	32.76	11.78	15.07	V
	20525	836.5	-18.06	32.39	12.18	16.52	
	20625	846.5	-17.96	32.54	12.43	17.50	
Channel Bandwidth: 5 MHz / 16QAM							
X	20425	826.5	-12.51	32.62	17.96	62.52	H
	20525	836.5	-12.28	32.52	18.09	64.42	
	20625	846.5	-12.26	32.65	18.24	66.68	
	20425	826.5	-19.85	32.76	10.76	11.91	V
	20525	836.5	-19.08	32.39	11.16	13.06	
	20625	846.5	-18.98	32.54	11.41	13.84	
Channel Bandwidth: 5 MHz / 64QAM							
X	20425	826.5	-13.48	32.62	16.99	50.00	H
	20525	836.5	-13.25	32.52	17.12	51.52	
	20625	846.5	-13.23	32.65	17.27	53.33	
	20425	826.5	-20.82	32.76	9.79	9.53	V
	20525	836.5	-20.05	32.39	10.19	10.45	
	20625	846.5	-19.95	32.54	10.44	11.07	

Note: ERP (dBm) = Reading (dBm) + Correction Factor (dB) – 2.15

LTE Band 5							
Channel Bandwidth: 10 MHz / QPSK							
Plane	Channel	Frequency (MHz)	Reading (dBm)	Correction Factor (dB)	ERP (dBm)	ERP (mW)	Polarization (H/V)
X	20450	829.0	-11.24	32.62	19.23	83.75	H
	20525	836.5	-11.01	32.52	19.36	86.30	
	20600	844.0	-10.99	32.65	19.51	89.33	
	20450	829.0	-18.58	32.76	12.03	15.96	V
	20525	836.5	-17.81	32.39	12.43	17.50	
	20600	844.0	-17.71	32.54	12.68	18.54	
Channel Bandwidth: 10 MHz / 16QAM							
X	20425	826.5	-12.26	32.62	18.21	66.22	H
	20525	836.5	-12.03	32.52	18.34	68.23	
	20625	846.5	-12.01	32.65	18.49	70.63	
	20425	826.5	-19.60	32.76	11.01	12.62	V
	20525	836.5	-18.83	32.39	11.41	13.84	
	20625	846.5	-18.73	32.54	11.66	14.66	
Channel Bandwidth: 10 MHz / 64QAM							
X	20450	829.0	-13.25	32.62	17.22	52.72	H
	20525	836.5	-13.02	32.52	17.35	54.33	
	20600	844.0	-13.00	32.65	17.50	56.23	
	20450	829.0	-20.59	32.76	10.02	10.05	V
	20525	836.5	-19.82	32.39	10.42	11.02	
	20600	844.0	-19.72	32.54	10.67	11.67	

Note: ERP (dBm) = Reading (dBm) + Correction Factor (dB) – 2.15

LTE Band 26							
Channel Bandwidth: 1.4 MHz / QPSK							
Plane	Channel	Frequency (MHz)	Reading (dBm)	Correction Factor (dB)	ERP (dBm)	ERP (mW)	Polarization (H/V)
X	26797	824.7	-13.77	32.62	16.70	46.77	H
	26915	836.5	-13.87	32.52	16.50	44.67	
	27033	848.3	-13.63	32.65	16.87	48.64	
	26797	824.7	-20.91	32.76	9.70	9.33	V
	26915	836.5	-20.84	32.39	9.40	8.71	
	27033	848.3	-20.36	32.54	10.03	10.07	
Channel Bandwidth: 1.4 MHz / 16QAM							
X	26797	824.7	-14.81	32.62	15.66	36.81	H
	26915	836.5	-14.91	32.52	15.46	35.16	
	27033	848.3	-14.67	32.65	15.83	38.28	
	26797	824.7	-21.95	32.76	8.66	7.35	V
	26915	836.5	-21.88	32.39	8.36	6.85	
	27033	848.3	-21.40	32.54	8.99	7.93	
Channel Bandwidth: 1.4 MHz / 64QAM							
X	26797	824.7	-15.77	32.62	14.70	29.51	H
	26915	836.5	-15.87	32.52	14.50	28.18	
	27033	848.3	-15.63	32.65	14.87	30.69	
	26797	824.7	-22.91	32.76	7.70	5.89	V
	26915	836.5	-22.84	32.39	7.40	5.50	
	27033	848.3	-22.36	32.54	8.03	6.35	

Note: ERP (dBm) = Reading (dBm) + Correction Factor (dB) – 2.15

LTE Band 26							
Channel Bandwidth: 3 MHz / QPSK							
Plane	Channel	Frequency (MHz)	Reading (dBm)	Correction Factor (dB)	ERP (dBm)	ERP (mW)	Polarization (H/V)
X	26805	825.5	-13.53	32.62	16.94	49.43	H
	26915	836.5	-13.63	32.52	16.74	47.21	
	27025	847.5	-13.39	32.65	17.11	51.40	
	26805	825.5	-20.67	32.76	9.94	9.86	V
	26915	836.5	-20.60	32.39	9.64	9.20	
	27025	847.5	-20.12	32.54	10.27	10.64	
Channel Bandwidth: 3 MHz / 16QAM							
X	26805	825.5	-14.56	32.62	15.91	38.99	H
	26915	836.5	-14.66	32.52	15.71	37.24	
	27025	847.5	-14.42	32.65	16.08	40.55	
	26805	825.5	-21.70	32.76	8.91	7.78	V
	26915	836.5	-21.63	32.39	8.61	7.26	
	27025	847.5	-21.15	32.54	9.24	8.39	
Channel Bandwidth: 3 MHz / 64QAM							
X	26805	825.5	-15.54	32.62	14.93	31.12	H
	26915	836.5	-15.64	32.52	14.73	29.72	
	27025	847.5	-15.40	32.65	15.10	32.36	
	26805	825.5	-22.68	32.76	7.93	6.21	V
	26915	836.5	-22.61	32.39	7.63	5.79	
	27025	847.5	-22.13	32.54	8.26	6.70	

Note: ERP (dBm) = Reading (dBm) + Correction Factor (dB) – 2.15

LTE Band 26							
Channel Bandwidth: 5 MHz / QPSK							
Plane	Channel	Frequency (MHz)	Reading (dBm)	Correction Factor (dB)	ERP (dBm)	ERP (mW)	Polarization (H/V)
X	26815	826.5	-13.30	32.62	17.17	52.12	H
	26915	836.5	-13.40	32.52	16.97	49.77	
	27015	846.5	-13.16	32.65	17.34	54.20	
	26815	826.5	-20.44	32.76	10.17	10.40	V
	26919	836.5	-20.37	32.39	9.87	9.71	
	27015	846.5	-19.89	32.54	10.50	11.22	
Channel Bandwidth: 5 MHz / 16QAM							
X	26815	826.5	-14.32	32.62	16.15	41.21	H
	26915	836.5	-14.42	32.52	15.95	39.36	
	27015	846.5	-14.18	32.65	16.32	42.85	
	26815	826.5	-21.46	32.76	9.15	8.22	V
	26919	836.5	-21.39	32.39	8.85	7.67	
	27015	846.5	-20.91	32.54	9.48	8.87	
Channel Bandwidth: 5 MHz / 64QAM							
X	26815	826.5	-15.30	32.62	15.17	32.89	H
	26915	836.5	-15.40	32.52	14.97	31.41	
	27015	846.5	-15.16	32.65	15.34	34.20	
	26815	826.5	-22.44	32.76	8.17	6.56	V
	26919	836.5	-22.37	32.39	7.87	6.12	
	27015	846.5	-21.89	32.54	8.50	7.08	

Note: ERP (dBm) = Reading (dBm) + Correction Factor (dB) – 2.15

LTE Band 26							
Channel Bandwidth: 10 MHz / QPSK							
Plane	Channel	Frequency (MHz)	Reading (dBm)	Correction Factor (dB)	ERP (dBm)	ERP (mW)	Polarization (H/V)
X	26840	829.0	-13.07	32.62	17.40	54.95	H
	26915	836.5	-13.17	32.52	17.20	52.48	
	26990	844.0	-12.93	32.65	17.57	57.15	
	26840	829.0	-20.21	32.76	10.40	10.96	V
	26919	836.5	-20.14	32.39	10.10	10.23	
	26990	844.0	-19.66	32.54	10.73	11.83	
Channel Bandwidth: 10 MHz / 16QAM							
X	26840	829.0	-14.07	32.62	16.40	43.65	H
	26915	836.5	-14.17	32.52	16.20	41.69	
	26990	844.0	-13.93	32.65	16.57	45.39	
	26840	829.0	-21.21	32.76	9.40	8.71	V
	26919	836.5	-21.14	32.39	9.10	8.13	
	26990	844.0	-20.66	32.54	9.73	9.40	
Channel Bandwidth: 10 MHz / 64QAM							
X	26840	829.0	-15.07	32.62	15.40	34.67	H
	26915	836.5	-15.17	32.52	15.20	33.11	
	26990	844.0	-14.93	32.65	15.57	36.06	
	26840	829.0	-22.21	32.76	8.40	6.92	V
	26919	836.5	-22.14	32.39	8.10	6.46	
	26990	844.0	-21.66	32.54	8.73	7.46	

Note: ERP (dBm) = Reading (dBm) + Correction Factor (dB) – 2.15

LTE Band 26							
Channel Bandwidth: 15 MHz / QPSK							
Plane	Channel	Frequency (MHz)	Reading (dBm)	Correction Factor (dB)	ERP (dBm)	ERP (mW)	Polarization (H/V)
X	26865	831.5	-12.82	32.62	17.65	58.21	H
	26915	836.5	-12.92	32.52	17.45	55.59	
	26965	841.5	-12.68	32.65	17.82	60.53	
	26865	831.5	-19.96	32.76	10.65	11.61	V
	26915	836.5	-19.89	32.39	10.35	10.84	
	26965	841.5	-19.41	32.54	10.98	12.53	
Channel Bandwidth: 15 MHz / 16QAM							
X	26865	831.5	-13.84	32.62	16.63	46.03	H
	26915	836.5	-13.94	32.52	16.43	43.95	
	26965	841.5	-13.70	32.65	16.80	47.86	
	26865	831.5	-20.98	32.76	9.63	9.18	V
	26915	836.5	-20.91	32.39	9.33	8.57	
	26965	841.5	-20.43	32.54	9.96	9.91	
Channel Bandwidth: 15 MHz / 64QAM							
X	26865	831.5	-14.83	32.62	15.64	36.64	H
	26915	836.5	-14.93	32.52	15.44	34.99	
	26965	841.5	-14.69	32.65	15.81	38.11	
	26865	831.5	-21.97	32.76	8.64	7.31	V
	26915	836.5	-21.90	32.39	8.34	6.82	
	26965	841.5	-21.42	32.54	8.97	7.89	

Note: ERP (dBm) = Reading (dBm) + Correction Factor (dB) – 2.15

4.2 Modulation Characteristics Measurement

4.2.1 Limits of Modulation Characteristics

N/A

4.2.2 Test Setup



4.2.3 Test Procedure

Connect the EUT to Communication Simulator via the antenna connector. The frequency band is set as EUT supported Modulation and Channels, the EUT output is matched with 50 ohm load, the waveform quality and constellation of the EUT was tested.

4.2.4 Test Results

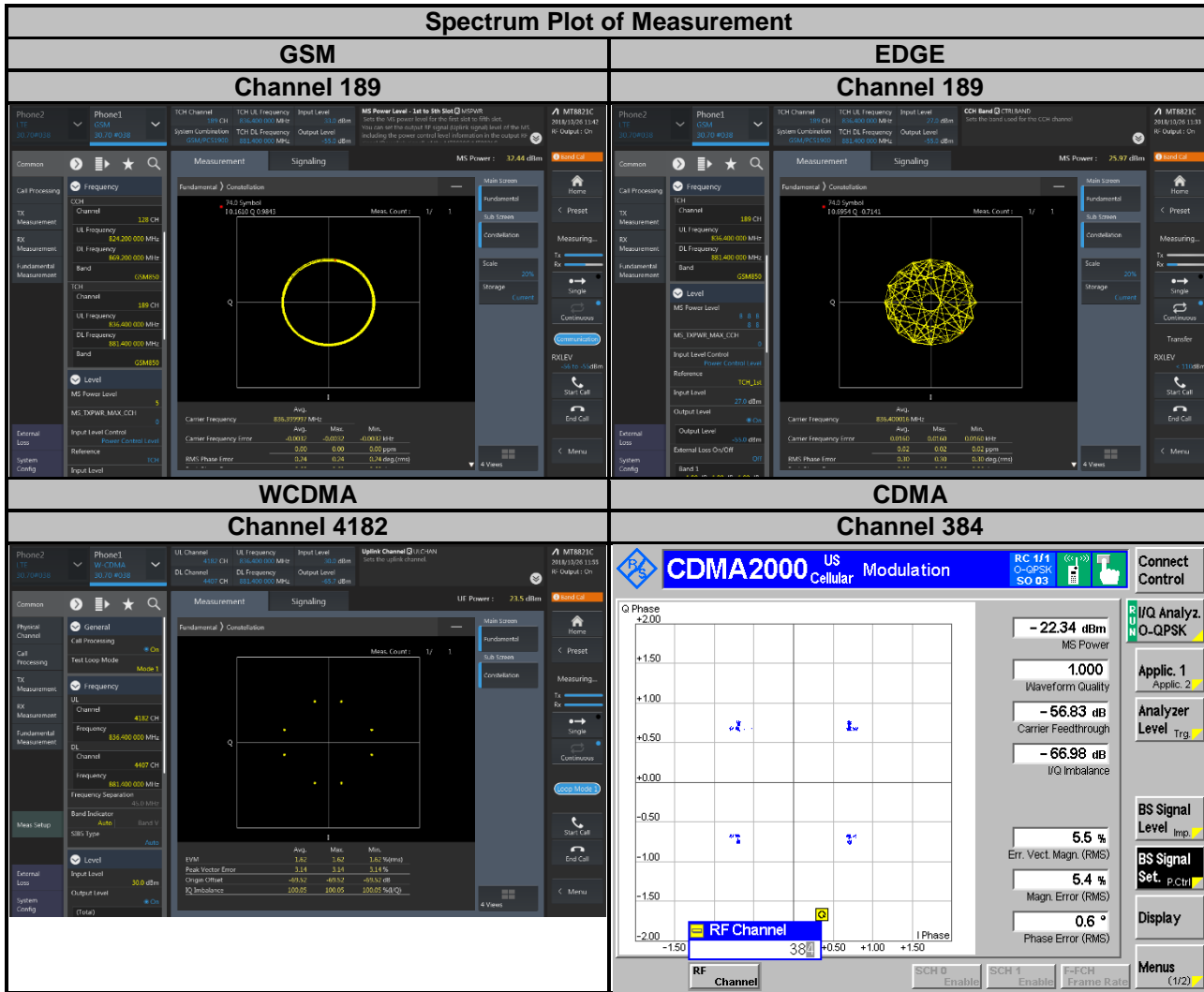

Spectrum Plot of Measurement

LTE Band 5

Channel 20525

QPSK

16QAM

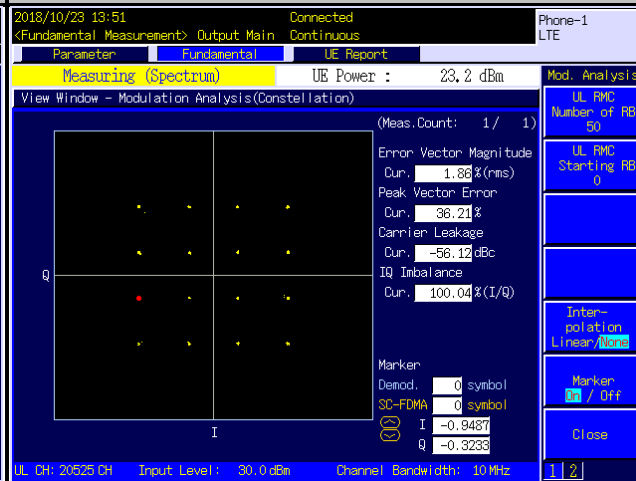
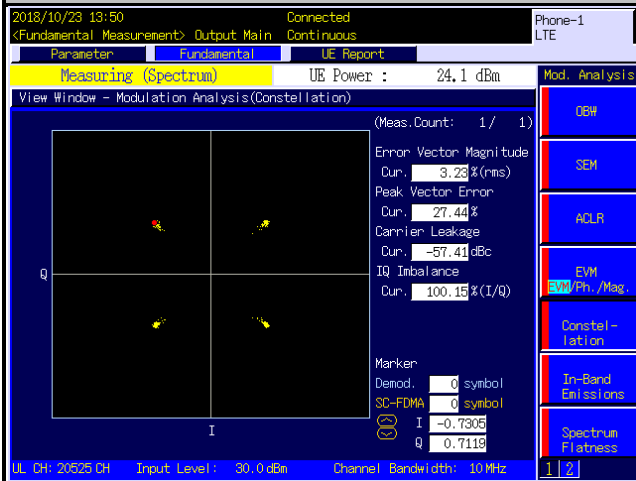

64QAM

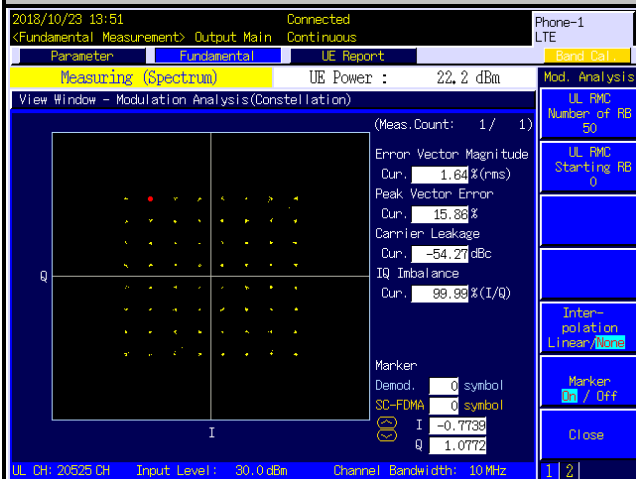

Spectrum Plot of Measurement

LTE Band 26

Channel 26915

QPSK

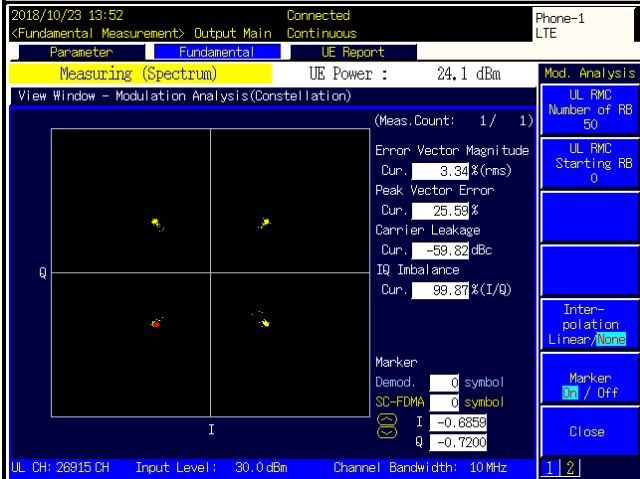

16QAM

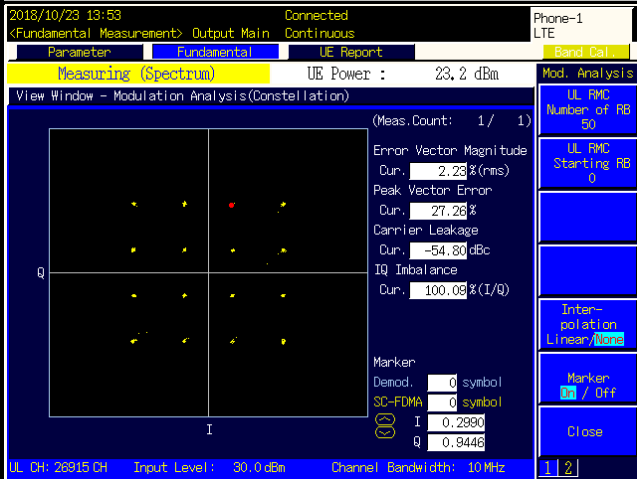

64QAM

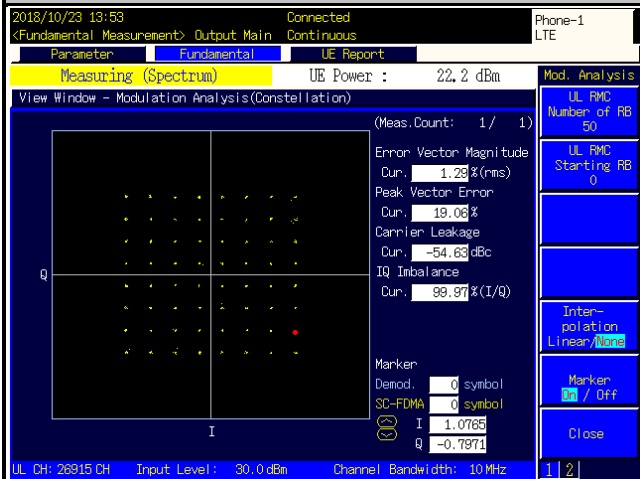

4.3 Frequency Stability Measurement

4.3.1 Limits of Frequency Stability Measurement

1.5 ppm is for base and fixed station. 2.5 ppm is for mobile station.

4.3.2 Test Procedure

- a. Device is placed at the oven room. The oven room could control the temperatures and humidity. Power warm up is at least 15 min and power applied should perform before recording frequency error.
- b. EUT is connected the external power supply to control the DC input power. The test voltage range is from minimum to maximum working voltage. Each step shall be record the frequency error rate.
- c. The temperature range step is 10 degrees in this test items. All temperature levels shall be hold the ± 0.5 °C during the measurement testing. The each temperature step shall be at least 0.5 hours, consider the EUT could be test under the stability condition.

NOTE: The frequency error was recorded frequency error from the communication simulator.

4.3.3 Test Setup

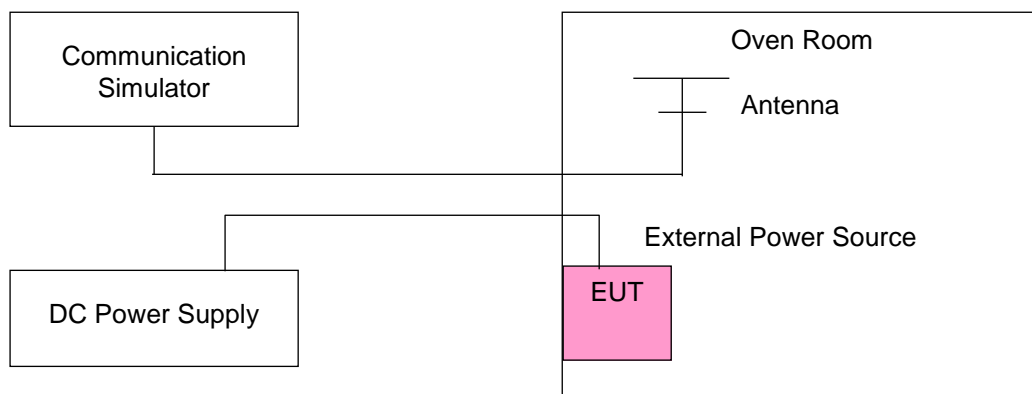

4.3.4 Test Results

Frequency Error vs. Voltage

Voltage (Volts)	GSM				Limit (ppm)
	Low Channel		High Channel		
	Frequency (MHz)	Frequency Error (ppm)	Frequency (MHz)	Frequency Error (ppm)	
3.85	824.200002	0.002	848.800002	0.002	2.5
3.6	824.200003	0.004	848.800004	0.004	2.5
4.4	824.200003	0.004	848.800001	0.001	2.5

Note: The applicant defined the normal working voltage of the battery is from 3.6 Vdc to 4.4 Vdc.

Frequency Error vs. Temperature

Temp. (°C)	GSM				Limit (ppm)
	Low Channel		High Channel		
	Frequency (MHz)	Frequency Error (ppm)	Frequency (MHz)	Frequency Error (ppm)	
-30	824.200003	0.004	848.800002	0.003	2.5
-20	824.200004	0.005	848.800004	0.004	2.5
-10	824.200003	0.004	848.800004	0.004	2.5
0	824.200002	0.002	848.800003	0.004	2.5
10	824.200002	0.003	848.800003	0.004	2.5
20	824.199997	-0.003	848.799996	-0.005	2.5
30	824.199998	-0.002	848.799996	-0.004	2.5
40	824.199998	-0.003	848.799996	-0.004	2.5
50	824.199999	-0.001	848.799997	-0.004	2.5
55	824.199996	-0.004	848.799998	-0.002	2.5

Frequency Error vs. Voltage

Voltage (Volts)	EDGE				Limit (ppm)
	Low Channel		High Channel		
	Frequency (MHz)	Frequency Error (ppm)	Frequency (MHz)	Frequency Error (ppm)	
3.85	824.200002	0.002	848.800002	0.002	2.5
3.6	824.200003	0.004	848.800003	0.004	2.5
4.4	824.200002	0.003	848.800001	0.001	2.5

Note: The applicant defined the normal working voltage of the battery is from 3.6 Vdc to 4.4 Vdc.

Frequency Error vs. Temperature

Temp. (°C)	EDGE				Limit (ppm)
	Low Channel		High Channel		
	Frequency (MHz)	Frequency Error (ppm)	Frequency (MHz)	Frequency Error (ppm)	
-30	824.200003	0.004	848.800003	0.004	2.5
-20	824.200004	0.004	848.800003	0.003	2.5
-10	824.200004	0.005	848.800003	0.004	2.5
0	824.200003	0.004	848.800004	0.005	2.5
10	824.200002	0.002	848.800004	0.004	2.5
20	824.199996	-0.005	848.799999	-0.002	2.5
30	824.199996	-0.005	848.799996	-0.005	2.5
40	824.199996	-0.005	848.799996	-0.005	2.5
50	824.199997	-0.004	848.799997	-0.003	2.5
55	824.199997	-0.004	848.799999	-0.001	2.5

Frequency Error vs. Voltage

Voltage (Volts)	WCDMA				Limit (ppm)
	Low Channel		High Channel		
	Frequency (MHz)	Frequency Error (ppm)	Frequency (MHz)	Frequency Error (ppm)	
3.85	826.400003	0.004	846.600001	0.002	2.5
3.6	826.400001	0.001	846.600003	0.003	2.5
4.4	826.400001	0.001	846.600002	0.002	2.5

Note: The applicant defined the normal working voltage of the battery is from 3.6 Vdc to 4.4 Vdc.

Frequency Error vs. Temperature

Temp. (°C)	WCDMA				Limit (ppm)
	Low Channel		High Channel		
	Frequency (MHz)	Frequency Error (ppm)	Frequency (MHz)	Frequency Error (ppm)	
-30	826.400004	0.004	846.600004	0.004	2.5
-20	826.400002	0.002	846.600003	0.004	2.5
-10	826.400002	0.003	846.600001	0.001	2.5
0	826.400004	0.004	846.600003	0.004	2.5
10	826.400004	0.004	846.600004	0.005	2.5
20	826.399999	-0.002	846.599996	-0.005	2.5
30	826.399999	-0.002	846.599998	-0.003	2.5
40	826.399997	-0.004	846.599998	-0.002	2.5
50	826.399999	-0.001	846.599998	-0.003	2.5
55	826.399999	-0.001	846.599997	-0.003	2.5

Frequency Error vs. Voltage

Voltage (Volts)	CDMA				Limit (ppm)
	Low Channel		High Channel		
	Frequency (MHz)	Frequency Error (ppm)	Frequency (MHz)	Frequency Error (ppm)	
3.85	824.700002	0.002	848.310002	0.002	2.5
3.6	824.700001	0.001	848.310001	0.001	2.5
4.4	824.700003	0.004	848.310004	0.004	2.5

Note: The applicant defined the normal working voltage of the battery is from 3.6 Vdc to 4.4 Vdc.

Frequency Error vs. Temperature

Temp. (°C)	CDMA				Limit (ppm)
	Low Channel		High Channel		
	Frequency (MHz)	Frequency Error (ppm)	Frequency (MHz)	Frequency Error (ppm)	
-30	824.700004	0.005	848.310003	0.003	2.5
-20	824.700004	0.005	848.310002	0.002	2.5
-10	824.700002	0.003	848.310003	0.003	2.5
0	824.700003	0.004	848.310001	0.001	2.5
10	824.700004	0.004	848.310001	0.001	2.5
20	824.699999	-0.001	848.309999	-0.001	2.5
30	824.699998	-0.003	848.309997	-0.004	2.5
40	824.699999	-0.001	848.309996	-0.004	2.5
50	824.699999	-0.001	848.309996	-0.005	2.5
55	824.699998	-0.003	848.309999	-0.001	2.5

Frequency Error vs. Voltage

Voltage (Volts)	LTE Band 5				Limit (ppm)
	Channel Bandwidth: 1.4 MHz				
	Low Channel		High Channel		
	Frequency (MHz)	Frequency Error (ppm)	Frequency (MHz)	Frequency Error (ppm)	
3.85	824.700001	0.001	848.300004	0.004	2.5
3.6	824.700004	0.004	848.300004	0.004	2.5
4.4	824.700003	0.003	848.300003	0.003	2.5

Note: The applicant defined the normal working voltage of the battery is from 3.6 Vdc to 4.4 Vdc.

Frequency Error vs. Temperature

Temp. (°C)	LTE Band 5				Limit (ppm)
	Channel Bandwidth: 1.4 MHz				
	Low Channel		High Channel		
	Frequency (MHz)	Frequency Error (ppm)	Frequency (MHz)	Frequency Error (ppm)	
-30	824.700004	0.005	848.300002	0.002	2.5
-20	824.700002	0.002	848.300003	0.004	2.5
-10	824.700002	0.002	848.300002	0.002	2.5
0	824.700002	0.003	848.300003	0.004	2.5
10	824.700004	0.005	848.300001	0.002	2.5
20	824.699998	-0.003	848.299998	-0.002	2.5
30	824.699996	-0.004	848.299998	-0.003	2.5
40	824.699996	-0.005	848.299998	-0.003	2.5
50	824.699998	-0.003	848.299997	-0.004	2.5
55	824.699996	-0.004	848.299996	-0.004	2.5

Frequency Error vs. Voltage

Voltage (Volts)	LTE Band 5				Limit (ppm)
	Channel Bandwidth: 3 MHz				
	Low Channel		High Channel		
	Frequency (MHz)	Frequency Error (ppm)	Frequency (MHz)	Frequency Error (ppm)	
3.85	825.500003	0.004	847.500002	0.002	2.5
3.6	825.500001	0.001	847.500003	0.004	2.5
4.4	825.500001	0.002	847.500003	0.004	2.5

Note: The applicant defined the normal working voltage of the battery is from 3.6 Vdc to 4.4 Vdc.

Frequency Error vs. Temperature

Temp. (°C)	LTE Band 5				Limit (ppm)
	Channel Bandwidth: 3 MHz				
	Low Channel		High Channel		
	Frequency (MHz)	Frequency Error (ppm)	Frequency (MHz)	Frequency Error (ppm)	
-30	825.500003	0.003	847.500002	0.002	2.5
-20	825.500004	0.005	847.500002	0.002	2.5
-10	825.500003	0.004	847.500003	0.003	2.5
0	825.500003	0.004	847.500003	0.004	2.5
10	825.500001	0.001	847.500001	0.001	2.5
20	825.499997	-0.004	847.499998	-0.002	2.5
30	825.499999	-0.002	847.499999	-0.002	2.5
40	825.499996	-0.005	847.499998	-0.002	2.5
50	825.499997	-0.004	847.499997	-0.003	2.5
55	825.499998	-0.002	847.499997	-0.003	2.5

Frequency Error vs. Voltage

Voltage (Volts)	LTE Band 5				Limit (ppm)
	Channel Bandwidth: 5 MHz				
	Low Channel		High Channel		
	Frequency (MHz)	Frequency Error (ppm)	Frequency (MHz)	Frequency Error (ppm)	
3.85	826.500003	0.004	846.500003	0.003	2.5
3.6	826.500003	0.004	846.500003	0.003	2.5
4.4	826.500002	0.002	846.500002	0.003	2.5

Note: The applicant defined the normal working voltage of the battery is from 3.6 Vdc to 4.4 Vdc.

Frequency Error vs. Temperature

Temp. (°C)	LTE Band 5				Limit (ppm)
	Channel Bandwidth: 5 MHz				
	Low Channel		High Channel		
	Frequency (MHz)	Frequency Error (ppm)	Frequency (MHz)	Frequency Error (ppm)	
-30	826.500003	0.003	846.500001	0.002	2.5
-20	826.500003	0.003	846.500002	0.002	2.5
-10	826.500004	0.004	846.500004	0.004	2.5
0	826.500002	0.003	846.500002	0.002	2.5
10	826.500004	0.004	846.500002	0.002	2.5
20	826.499998	-0.002	846.499998	-0.003	2.5
30	826.499997	-0.003	846.499997	-0.003	2.5
40	826.499997	-0.004	846.499996	-0.004	2.5
50	826.499998	-0.002	846.499998	-0.002	2.5
55	826.499996	-0.005	846.499997	-0.003	2.5

Frequency Error vs. Voltage

Voltage (Volts)	LTE Band 5				Limit (ppm)
	Channel Bandwidth: 10 MHz				
	Low Channel		High Channel		
	Frequency (MHz)	Frequency Error (ppm)	Frequency (MHz)	Frequency Error (ppm)	
3.85	829.000002	0.002	844.000003	0.003	2.5
3.6	829.000003	0.003	844.000004	0.004	2.5
4.4	829.000003	0.003	844.000002	0.002	2.5

Note: The applicant defined the normal working voltage of the battery is from 3.6 Vdc to 4.4 Vdc.

Frequency Error vs. Temperature

Temp. (°C)	LTE Band 5				Limit (ppm)
	Channel Bandwidth: 10 MHz				
	Low Channel		High Channel		
	Frequency (MHz)	Frequency Error (ppm)	Frequency (MHz)	Frequency Error (ppm)	
-30	829.000002	0.002	844.000002	0.003	2.5
-20	829.000002	0.003	844.000003	0.003	2.5
-10	829.000004	0.004	844.000001	0.001	2.5
0	829.000001	0.002	844.000003	0.004	2.5
10	829.000001	0.001	844.000002	0.002	2.5
20	828.999997	-0.004	843.999998	-0.002	2.5
30	828.999997	-0.004	843.999999	-0.001	2.5
40	828.999998	-0.002	843.999998	-0.002	2.5
50	828.999997	-0.004	843.999999	-0.001	2.5
55	828.999996	-0.005	843.999998	-0.002	2.5

Frequency Error vs. Voltage

Voltage (Volts)	LTE Band 26				Limit (ppm)
	Channel Bandwidth: 1.4 MHz				
	Low Channel		High Channel		
	Frequency (MHz)	Frequency Error (ppm)	Frequency (MHz)	Frequency Error (ppm)	
3.85	824.700002	0.002	848.300000	0.004	2.5
3.6	824.700004	0.004	848.300000	0.001	2.5
4.4	824.700002	0.003	848.300000	0.001	2.5

Note: The applicant defined the normal working voltage of the battery is from 3.6 Vdc to 4.4 Vdc.

Frequency Error vs. Temperature

Temp. (°C)	LTE Band 26				Limit (ppm)
	Channel Bandwidth: 1.4 MHz				
	Low Channel		High Channel		
	Frequency (MHz)	Frequency Error (ppm)	Frequency (MHz)	Frequency Error (ppm)	
-30	824.700003	0.004	848.300000	0.003	2.5
-20	824.700003	0.004	848.300000	0.005	2.5
-10	824.700002	0.002	848.300000	0.002	2.5
0	824.700002	0.002	848.300000	0.002	2.5
10	824.700002	0.003	848.300000	0.002	2.5
20	824.699997	-0.004	848.300000	-0.003	2.5
30	824.699996	-0.005	848.300000	-0.005	2.5
40	824.699998	-0.003	848.300000	-0.004	2.5
50	824.699999	-0.002	848.300000	-0.001	2.5
55	824.699996	-0.005	848.300000	-0.004	2.5

Frequency Error vs. Voltage

Voltage (Volts)	LTE Band 26				Limit (ppm)
	Channel Bandwidth: 3 MHz				
	Low Channel		High Channel		
	Frequency (MHz)	Frequency Error (ppm)	Frequency (MHz)	Frequency Error (ppm)	
3.85	825.500003	0.004	847.500000	0.002	2.5
3.6	825.500002	0.003	847.500000	0.003	2.5
4.4	825.500003	0.003	847.500000	0.002	2.5

Note: The applicant defined the normal working voltage of the battery is from 3.6 Vdc to 4.4 Vdc.

Frequency Error vs. Temperature

Temp. (°C)	LTE Band 26				Limit (ppm)
	Channel Bandwidth: 3 MHz				
	Low Channel		High Channel		
	Frequency (MHz)	Frequency Error (ppm)	Frequency (MHz)	Frequency Error (ppm)	
-30	825.500002	0.002	847.500000	0.004	2.5
-20	825.500003	0.004	847.500000	0.002	2.5
-10	825.500003	0.003	847.500000	0.003	2.5
0	825.500004	0.005	847.500000	0.004	2.5
10	825.500002	0.002	847.500000	0.002	2.5
20	825.499997	-0.003	847.500000	-0.003	2.5
30	825.499997	-0.004	847.500000	-0.003	2.5
40	825.499997	-0.003	847.500000	-0.002	2.5
50	825.499999	-0.001	847.500000	-0.003	2.5
55	825.499998	-0.003	847.500000	-0.002	2.5

Frequency Error vs. Voltage

Voltage (Volts)	LTE Band 26				Limit (ppm)
	Channel Bandwidth: 5 MHz				
	Low Channel		High Channel		
	Frequency (MHz)	Frequency Error (ppm)	Frequency (MHz)	Frequency Error (ppm)	
3.85	826.500001	0.002	846.500003	0.004	2.5
3.6	826.500001	0.001	846.500001	0.002	2.5
4.4	826.500002	0.003	846.500002	0.002	2.5

Note: The applicant defined the normal working voltage of the battery is from 3.6 Vdc to 4.4 Vdc.

Frequency Error vs. Temperature

Temp. (°C)	LTE Band 26				Limit (ppm)
	Channel Bandwidth: 5 MHz				
	Low Channel		High Channel		
	Frequency (MHz)	Frequency Error (ppm)	Frequency (MHz)	Frequency Error (ppm)	
-30	826.500003	0.004	846.500003	0.004	2.5
-20	826.500002	0.002	846.500002	0.002	2.5
-10	826.500003	0.003	846.500001	0.001	2.5
0	826.500002	0.002	846.500003	0.004	2.5
10	826.500003	0.004	846.500004	0.005	2.5
20	826.499998	-0.002	846.499999	-0.002	2.5
30	826.499997	-0.004	846.499996	-0.004	2.5
40	826.499998	-0.003	846.499998	-0.003	2.5
50	826.499998	-0.003	846.499997	-0.004	2.5
55	826.499998	-0.003	846.499998	-0.003	2.5

Frequency Error vs. Voltage

Voltage (Volts)	LTE Band 26				Limit (ppm)
	Channel Bandwidth: 10 MHz				
	Low Channel		High Channel		
	Frequency (MHz)	Frequency Error (ppm)	Frequency (MHz)	Frequency Error (ppm)	
3.85	829.000002	0.003	844.000003	0.003	2.5
3.6	829.000004	0.004	844.000004	0.005	2.5
4.4	829.000004	0.004	844.000004	0.004	2.5

Note: The applicant defined the normal working voltage of the battery is from 3.6 Vdc to 4.4 Vdc.

Frequency Error vs. Temperature

Temp. (°C)	LTE Band 26				Limit (ppm)
	Channel Bandwidth: 10 MHz				
	Low Channel		High Channel		
	Frequency (MHz)	Frequency Error (ppm)	Frequency (MHz)	Frequency Error (ppm)	
-30	829.000002	0.002	844.000002	0.002	2.5
-20	829.000004	0.005	844.000002	0.002	2.5
-10	829.000003	0.004	844.000004	0.004	2.5
0	829.000003	0.004	844.000004	0.005	2.5
10	829.000004	0.005	844.000001	0.002	2.5
20	828.999996	-0.005	843.999996	-0.004	2.5
30	828.999996	-0.004	843.999997	-0.004	2.5
40	828.999998	-0.003	843.999999	-0.002	2.5
50	828.999996	-0.004	843.999997	-0.004	2.5
55	828.999998	-0.002	843.999998	-0.002	2.5

Frequency Error vs. Voltage

Voltage (Volts)	LTE Band 26				Limit (ppm)
	Channel Bandwidth: 15 MHz				
	Low Channel		High Channel		
	Frequency (MHz)	Frequency Error (ppm)	Frequency (MHz)	Frequency Error (ppm)	
3.85	831.500004	0.005	841.500002	0.002	2.5
3.6	831.500001	0.001	841.500003	0.004	2.5
4.4	831.500002	0.002	841.500002	0.003	2.5

Note: The applicant defined the normal working voltage of the battery is from 3.6 Vdc to 4.4 Vdc.

Frequency Error vs. Temperature

Temp. (°C)	LTE Band 26				Limit (ppm)
	Channel Bandwidth: 15 MHz				
	Low Channel		High Channel		
	Frequency (MHz)	Frequency Error (ppm)	Frequency (MHz)	Frequency Error (ppm)	
-30	831.500003	0.003	841.500001	0.001	2.5
-20	831.500004	0.004	841.500003	0.004	2.5
-10	831.500003	0.003	841.500003	0.003	2.5
0	831.500002	0.003	841.500002	0.002	2.5
10	831.500003	0.003	841.500004	0.005	2.5
20	831.499998	-0.002	841.499999	-0.002	2.5
30	831.499997	-0.004	841.499996	-0.004	2.5
40	831.499999	-0.002	841.499997	-0.003	2.5
50	831.499998	-0.003	841.499999	-0.001	2.5
55	831.499998	-0.002	841.499997	-0.004	2.5

4.4 Occupied Bandwidth Measurement

4.4.1 Test Procedure

The EUT makes a call to the communication simulator. All measurements were done at low, middle and high operational frequency range. The communication simulator station system controlled a EUT to export maximum output power under transmission mode and specific channel frequency. Use OBW measurement function of Spectrum analyzer to measure 99 % occupied bandwidth.

4.4.2 Test Setup

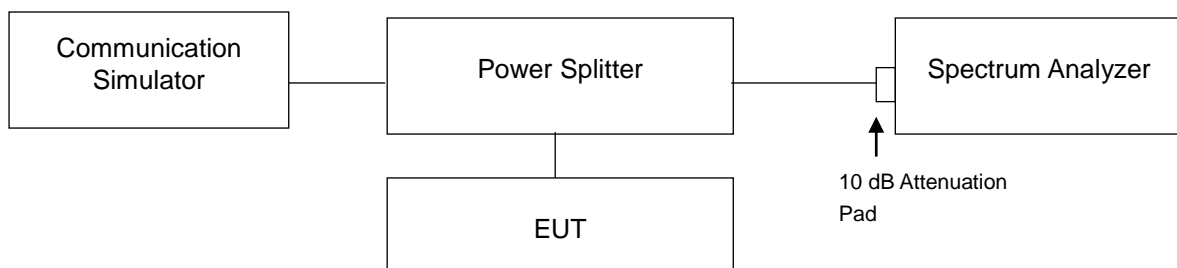

4.4.3 Test Result

<99 % Occupied Bandwidth>

Channel	Frequency (MHz)	99 % Occupied Bandwidth (kHz)		Channel	Frequency (MHz)	99 % Occupied Bandwidth (MHz)
		GSM	EDGE			WCDMA
128	824.2	246.73	247.19	4132	826.4	4.1427
189	836.4	246.60	246.15	4182	836.4	4.1578
251	848.8	245.04	249.24	4233	846.6	4.1606
Channel	Frequency (MHz)	99 % Occupied Bandwidth (MHz)				
		CDMA				
1013	824.70	1.2781				
384	836.52	1.2760				
777	848.31	1.2770				

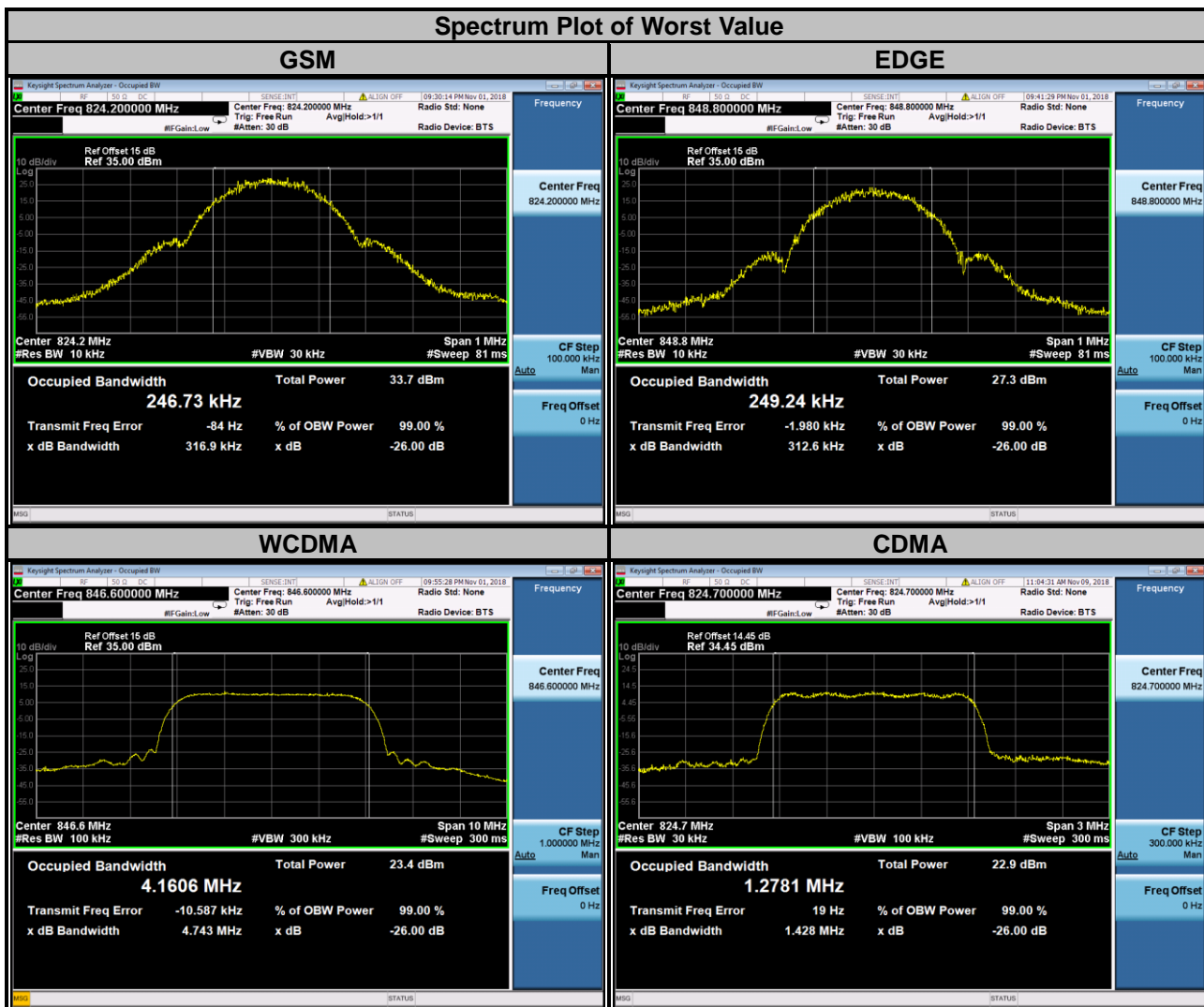

LTE Band 5									
Channel Bandwidth: 1.4 MHz					Channel Bandwidth: 3 MHz				
Channel	Frequency (MHz)	99 % Occupied Bandwidth (MHz)			Channel	Frequency (MHz)	99 % Occupied Bandwidth (MHz)		
		QPSK	16QAM	64QAM			QPSK	16QAM	64QAM
20407	824.7	1.0865	1.0887	1.0877	20415	825.5	2.7004	2.6979	2.6986
20525	836.5	1.0861	1.0892	1.0880	20525	836.5	2.7003	2.6981	2.6996
20643	848.3	1.0868	1.0897	1.0887	20635	847.5	2.6994	2.6964	2.6977

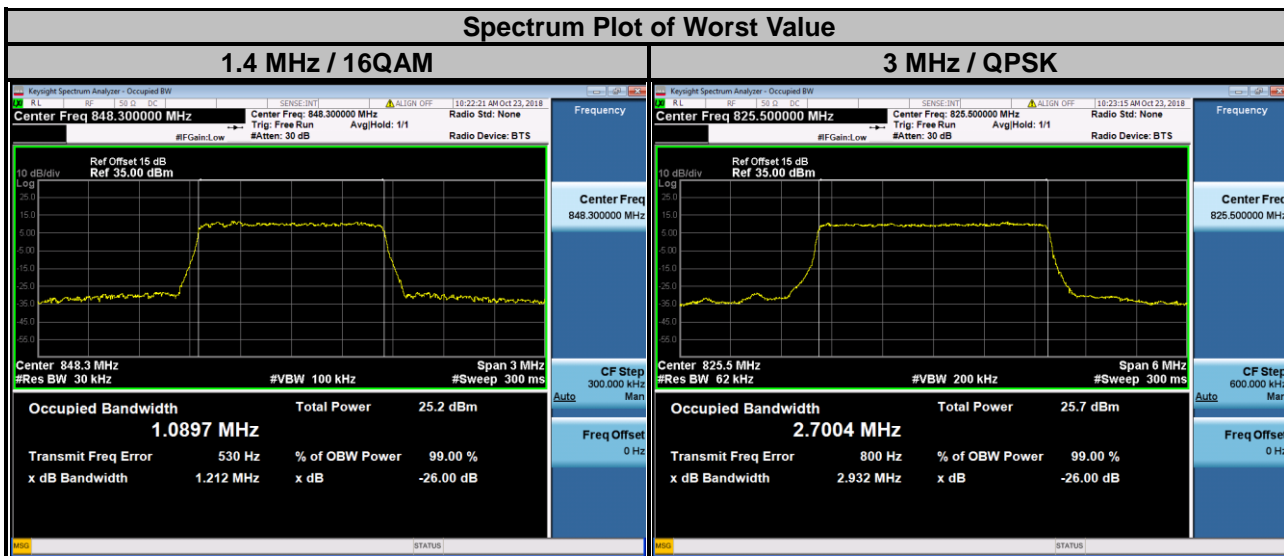

LTE Band 5									
Channel Bandwidth: 5 MHz					Channel Bandwidth: 10 MHz				
Channel	Frequency (MHz)	99 % Occupied Bandwidth (MHz)			Channel	Frequency (MHz)	99 % Occupied Bandwidth (MHz)		
		QPSK	16QAM	64QAM			QPSK	16QAM	64QAM
20425	826.5	4.4928	4.4951	4.5013	20450	829.0	8.9742	8.9754	8.9743
20525	836.5	4.4914	4.4938	4.5047	20525	836.5	8.9742	8.9734	8.9762
20625	846.5	4.4917	4.4936	4.5038	20600	844.0	8.9599	8.9598	8.9667

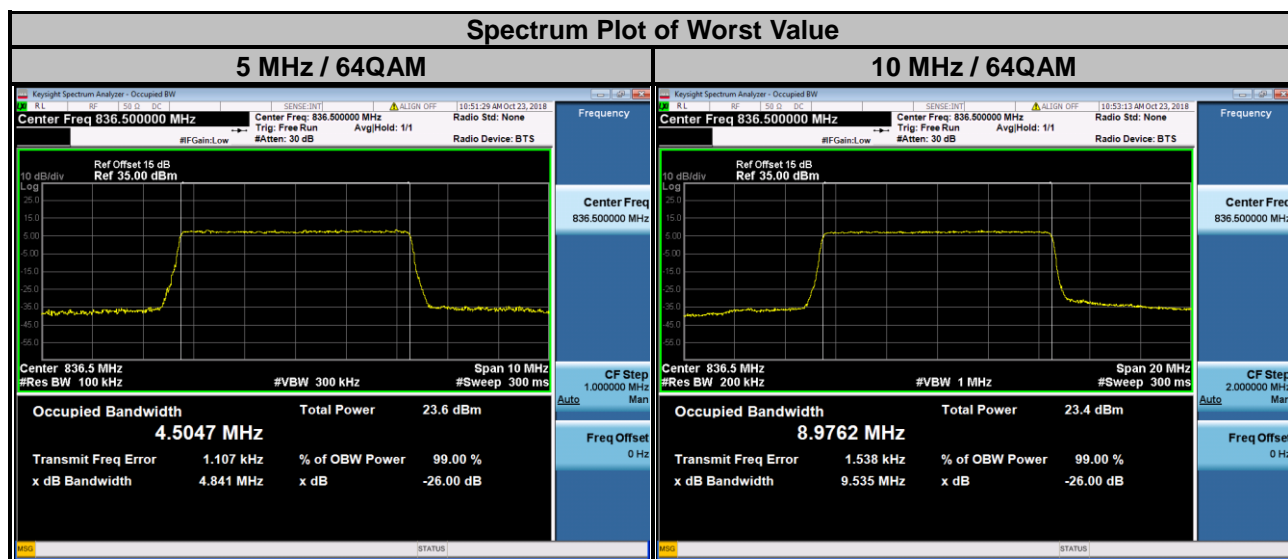

LTE Band 26

Channel Bandwidth: 1.4 MHz					Channel Bandwidth: 3 MHz				
Channel	Frequency (MHz)	99 % Occupied Bandwidth (MHz)			Channel	Frequency (MHz)	99 % Occupied Bandwidth (MHz)		
		QPSK	16QAM	64QAM			QPSK	16QAM	64QAM
26797	824.7	1.0867	1.0860	1.0880	26805	825.5	2.6990	2.6973	2.6981
26915	836.5	1.0856	1.0878	1.0889	26915	836.5	2.7023	2.6968	2.6975
27033	848.3	1.0859	1.0887	1.0887	27025	847.5	2.7017	2.6994	2.6954

Spectrum Plot of Worst Value

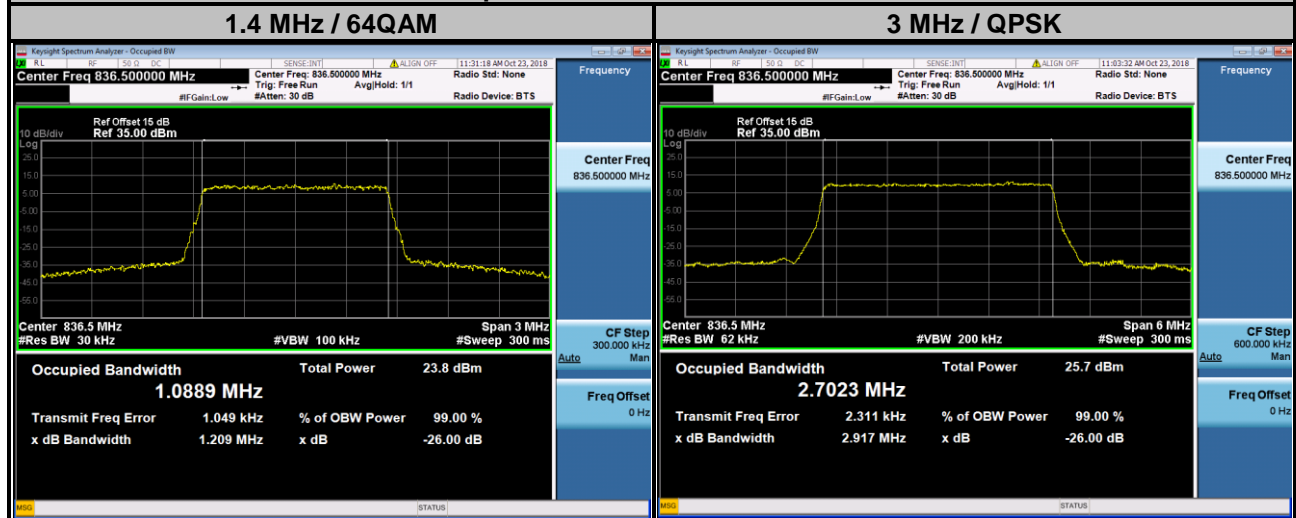

LTE Band 26

Channel Bandwidth: 5 MHz					Channel Bandwidth: 10 MHz				
Channel	Frequency (MHz)	99 % Occupied Bandwidth (MHz)			Channel	Frequency (MHz)	99 % Occupied Bandwidth (MHz)		
		QPSK	16QAM	64QAM			QPSK	16QAM	64QAM
26815	826.5	4.4918	4.4959	4.5003	26840	829.0	8.9688	8.9740	8.9729
26915	836.5	4.4917	4.4930	4.5044	26915	836.5	8.9683	8.9771	8.9807
27015	846.5	4.4918	4.4929	4.5028	26990	844.0	8.9610	8.9617	8.9646

Spectrum Plot of Worst Value

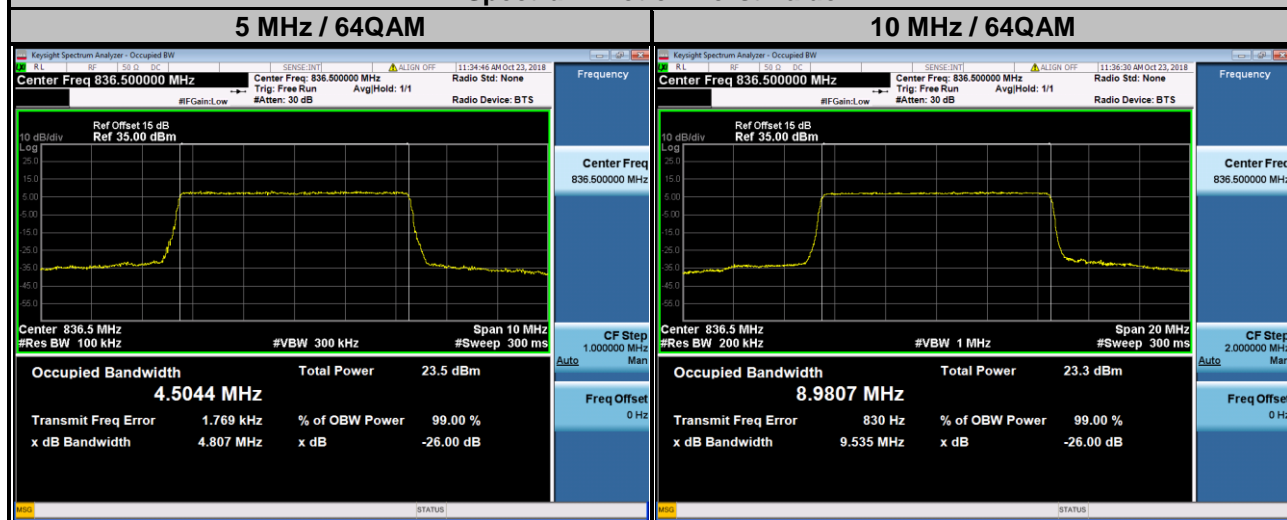

LTE Band 26				
Channel Bandwidth: 15 MHz				
Channel	Frequency (MHz)	99 % Occupied Bandwidth (MHz)		
		QPSK	16QAM	64QAM
26865	831.5	13.467	13.455	13.451
26915	836.5	13.458	13.450	13.444
26965	841.5	13.429	13.423	13.413

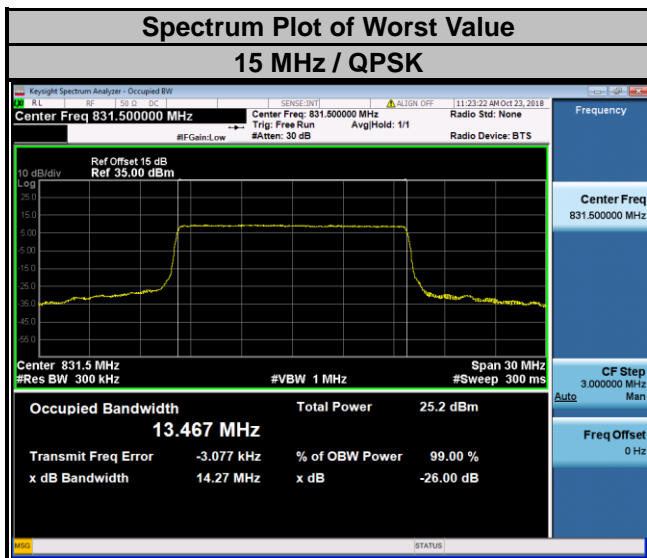

<26 dB Bandwidth>

Channel	Frequency (MHz)	26 dB Bandwidth (kHz)		Channel	Frequency (MHz)	26 dB Bandwidth (MHz)
		GSM	EDGE			WCDMA
128	824.2	316.9	306.8	4132	826.4	4.731
189	836.4	318.8	310.6	4182	836.4	4.745
251	848.8	310.7	312.6	4233	846.6	4.743
Channel	Frequency (MHz)	26 dB Bandwidth (MHz)				
		CDMA				
1013	824.70	1.428				
384	836.52	1.423				
777	848.31	1.427				

Spectrum Plot of Worst Value

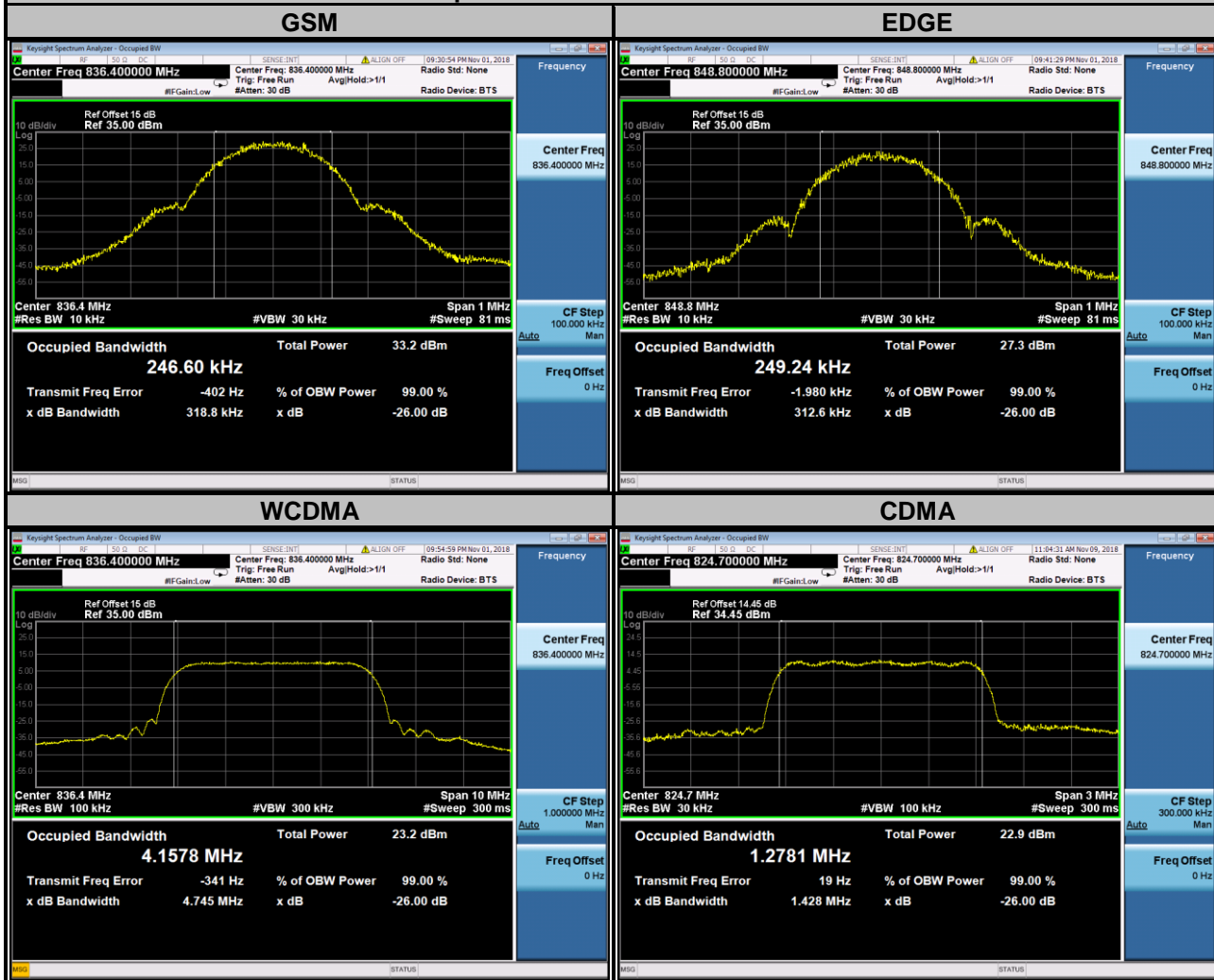

LTE Band 5									
Channel Bandwidth: 1.4 MHz					Channel Bandwidth: 3 MHz				
Channel	Frequency (MHz)	26 dB Bandwidth (MHz)			Channel	Frequency (MHz)	26 dB Bandwidth (MHz)		
		QPSK	16QAM	64QAM			QPSK	16QAM	64QAM
20407	824.7	1.222	1.212	1.214	20415	825.5	2.932	2.931	2.913
20525	836.5	1.219	1.215	1.217	20525	836.5	2.937	2.935	2.906
20643	848.3	1.221	1.212	1.213	20635	847.5	2.932	2.925	2.916

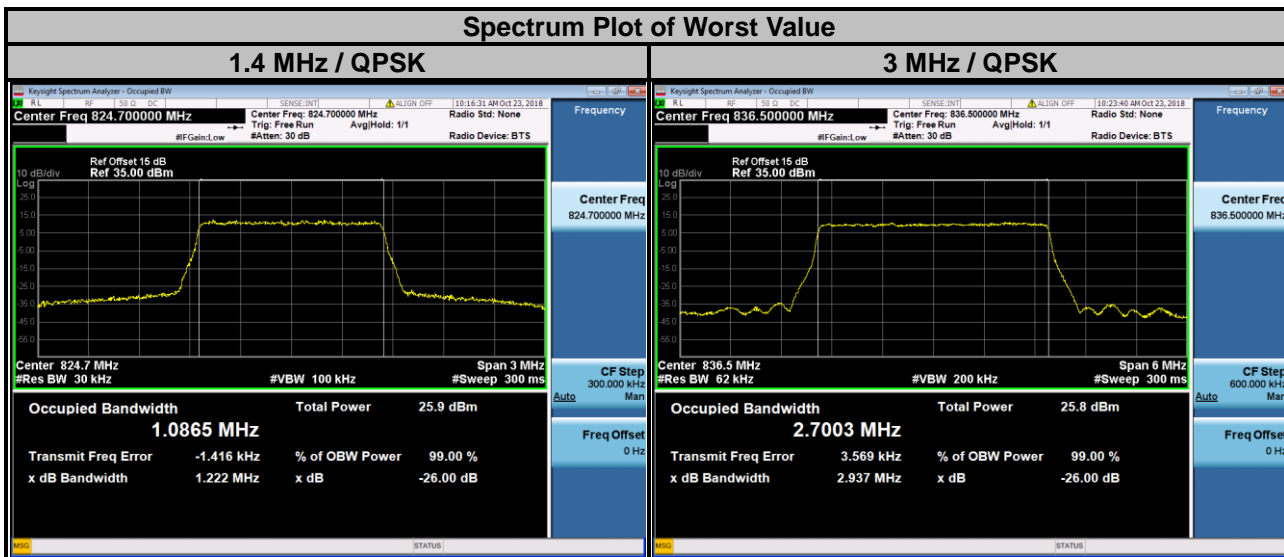

LTE Band 5

Channel Bandwidth: 5 MHz					Channel Bandwidth: 10 MHz				
Channel	Frequency (MHz)	26 dB Bandwidth (MHz)			Channel	Frequency (MHz)	26 dB Bandwidth (MHz)		
		QPSK	16QAM	64QAM			QPSK	16QAM	64QAM
20425	826.5	4.842	4.819	4.818	20450	829.0	9.546	9.511	9.530
20525	836.5	4.833	4.806	4.841	20525	836.5	9.550	9.521	9.535
20625	846.5	4.823	4.809	4.831	20600	844.0	9.517	9.509	9.524

Spectrum Plot of Worst Value



LTE Band 26									
Channel Bandwidth: 1.4 MHz					Channel Bandwidth: 3 MHz				
Channel	Frequency (MHz)	26 dB Bandwidth (MHz)			Channel	Frequency (MHz)	26 dB Bandwidth (MHz)		
		QPSK	16QAM	64QAM			QPSK	16QAM	64QAM
26797	824.7	1.219	1.215	1.215	26805	825.5	2.931	2.921	2.899
26915	836.5	1.224	1.215	1.209	26915	836.5	2.917	2.924	2.905
27033	848.3	1.222	1.222	1.218	27025	847.5	2.926	2.929	2.908

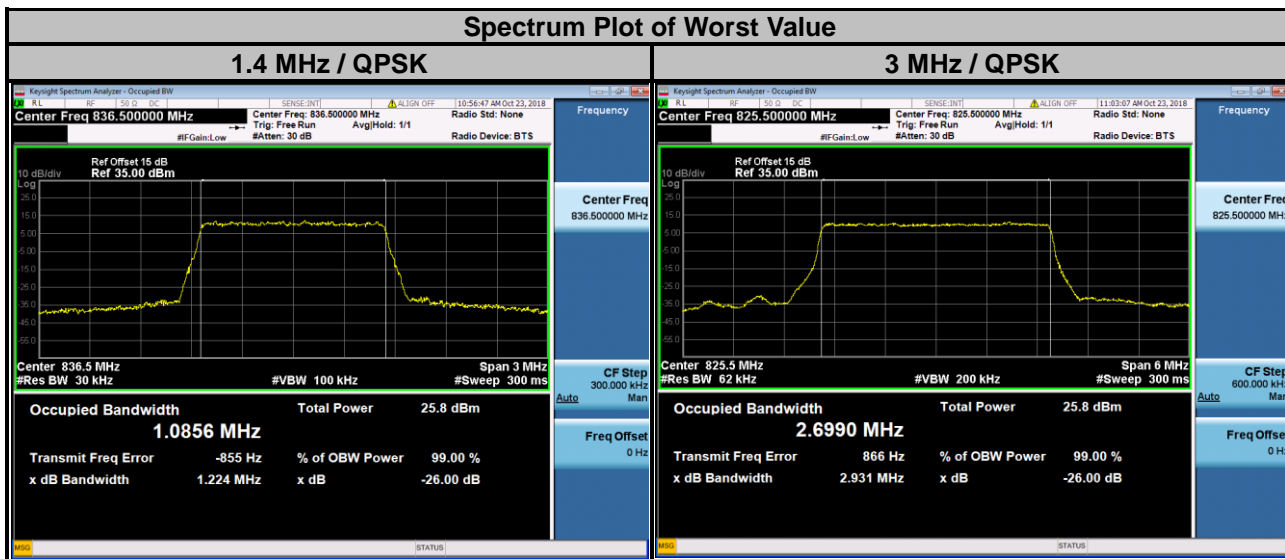

LTE Band 26

Channel Bandwidth: 5 MHz					Channel Bandwidth: 10 MHz				
Channel	Frequency (MHz)	26 dB Bandwidth (MHz)			Channel	Frequency (MHz)	26 dB Bandwidth (MHz)		
		QPSK	16QAM	64QAM			QPSK	16QAM	64QAM
26815	826.5	4.829	4.806	4.829	26840	829.0	9.521	9.517	9.530
26915	836.5	4.832	4.802	4.807	26915	836.5	9.536	9.523	9.535
27015	846.5	4.826	4.808	4.824	26990	844.0	9.518	9.509	9.531

Spectrum Plot of Worst Value

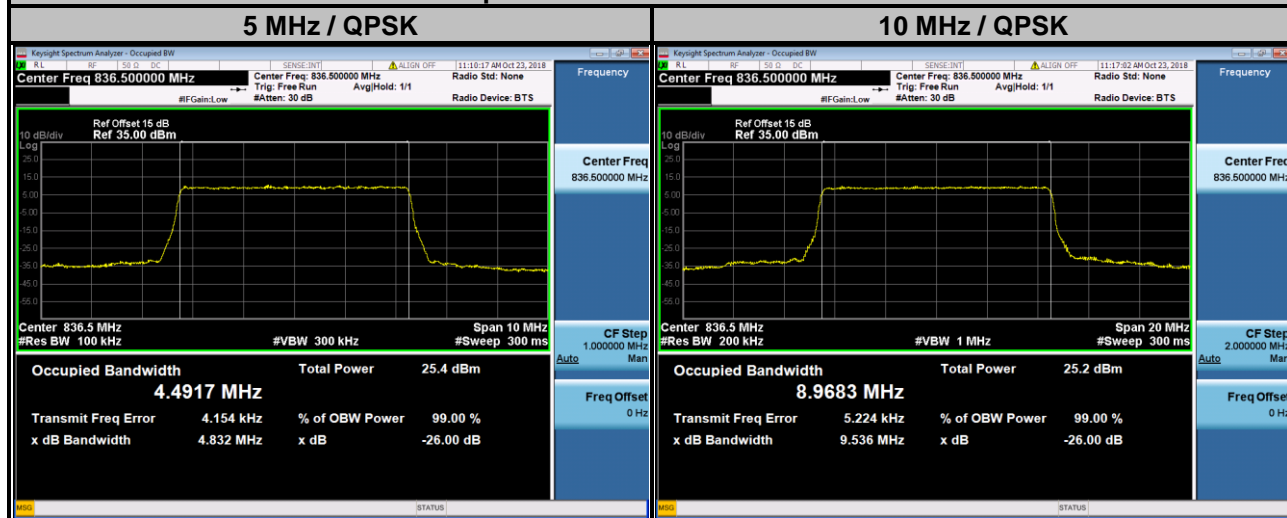

LTE Band 26				
Channel Bandwidth: 15 MHz				
Channel	Frequency (MHz)	26 dB Bandwidth (MHz)		
		QPSK	16QAM	64QAM
26865	831.5	14.27	14.26	14.25
26915	836.5	14.28	14.26	14.25
26965	841.5	14.26	14.23	14.23

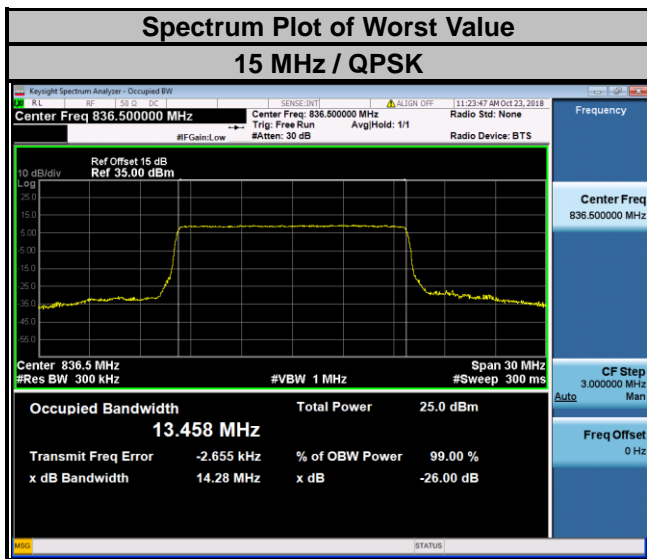

4.5 Band Edge Measurement

4.5.1 Limits of Band Edge Measurement

Power of any emission outside of the authorized operating frequency ranges must be attenuated below the transmitting power (P) by a factor of at least $43 + 10 \log(P)$ dB. In the 1 MHz bands immediately outside and adjacent to the frequency block a resolution bandwidth of at least one percent of the emission bandwidth of the fundamental emission of the transmitter may be employed.

4.5.2 Test Setup

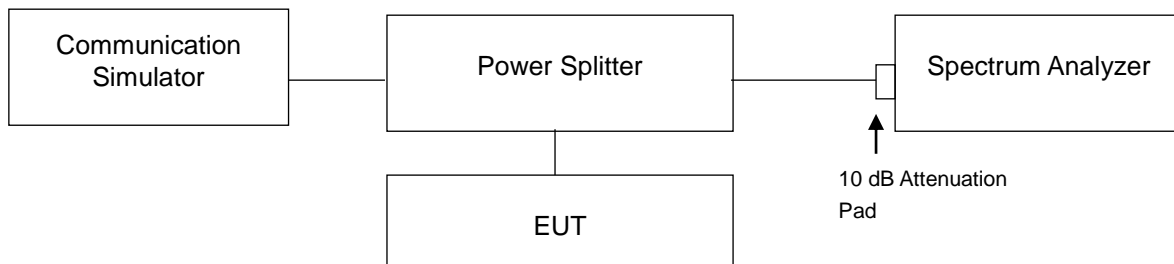

4.5.3 Test Procedures

- a. All measurements were done at low and high operational frequency range.
- b. The center frequency of spectrum is the band edge frequency and span is 1 MHz. RB of the spectrum is 10 kHz and VB of the spectrum is 30 kHz (GSM/GPRS/EDGE).
- c. The center frequency of spectrum is the band edge frequency and span is 5 MHz. RB of the spectrum is 100 kHz and VB of the spectrum is 300 kHz (WCDMA).
- d. The center frequency of spectrum is the band edge frequency and span is 9 MHz. RB of the spectrum is 20 kHz and VB of the spectrum is 62 kHz (CDMA).
- e. The center frequency of spectrum is the band edge frequency and span is 1 MHz. RB of the spectrum is 15 kHz and VB of the spectrum is 51 kHz (LTE Bandwidth 1.4 MHz).
- f. The center frequency of spectrum is the band edge frequency and span is 1 MHz. RB of the spectrum is 30 kHz and VB of the spectrum is 100 kHz (LTE Bandwidth 3 MHz).
- g. The center frequency of spectrum is the band edge frequency and span is 1 MHz. RB of the spectrum is 62 kHz and VB of the spectrum is 200 kHz (LTE Bandwidth 5 MHz).
- h. The center frequency of spectrum is the band edge frequency and span is 1 MHz. RB of the spectrum is 100 kHz and VB of the spectrum is 300 kHz (LTE Bandwidth 10 MHz).
- i. The center frequency of spectrum is the band edge frequency and span is 1 MHz. RB of the spectrum is 150 kHz and VB of the spectrum is 470 kHz (LTE Bandwidth 15 MHz).
- j. Record the max trace plot into the test report.

4.5.4 Test Results

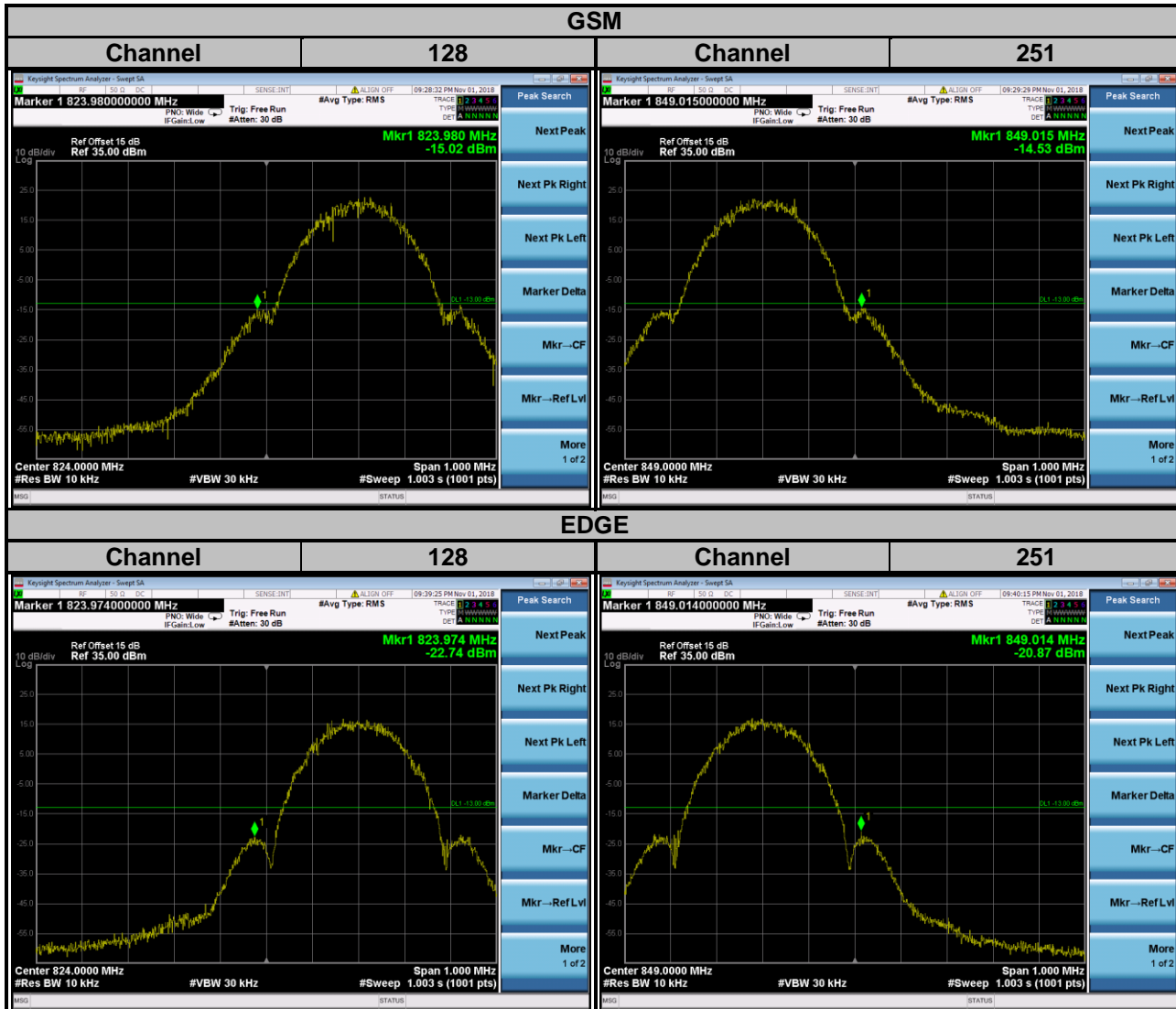

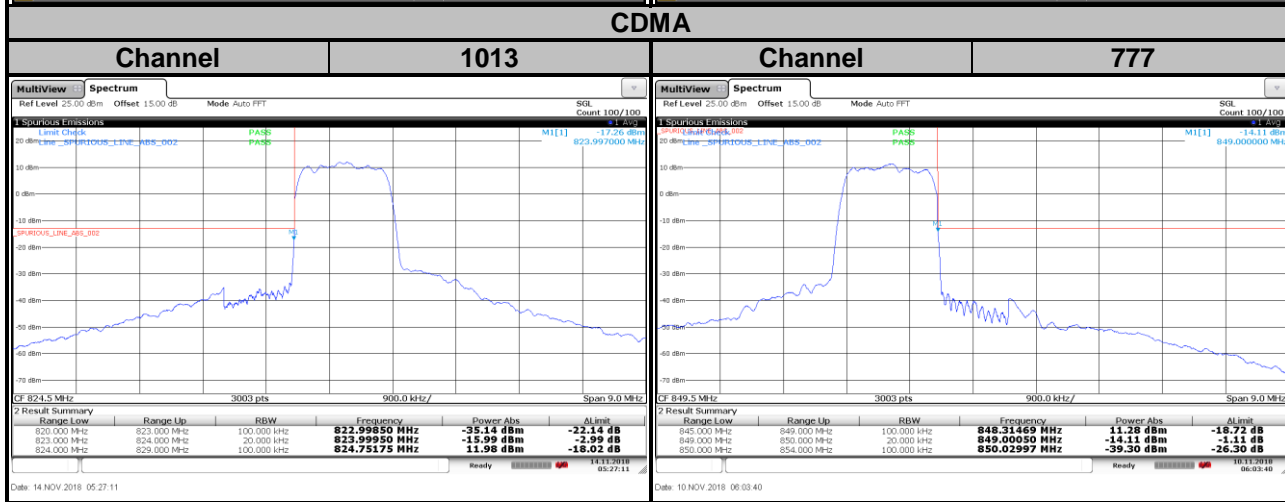
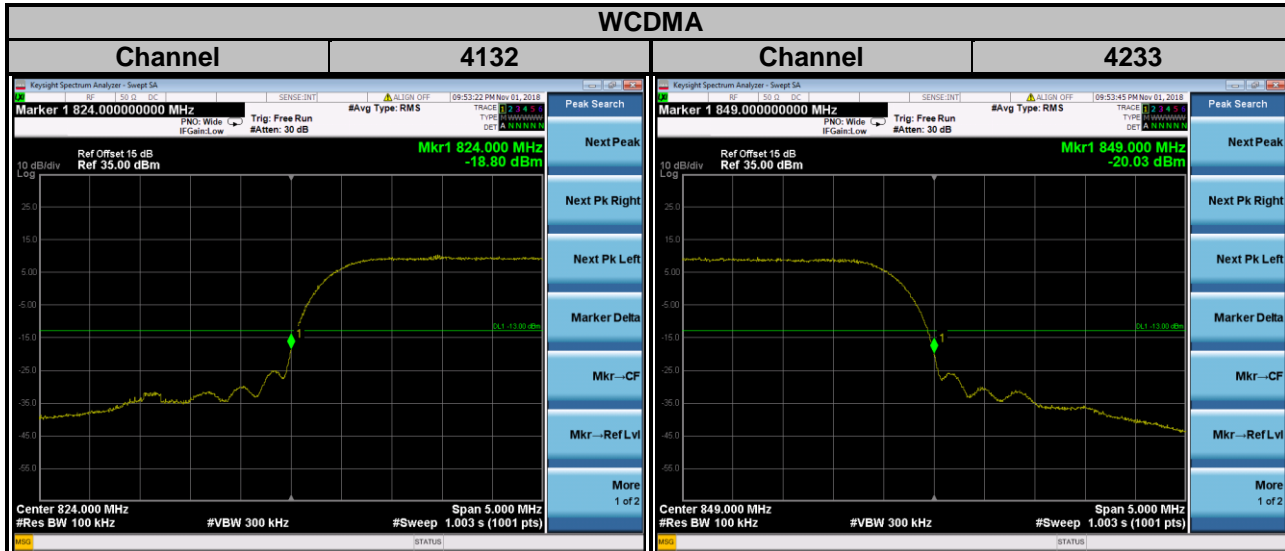

LTE Band 5
Channel Bandwidth: 1.4 MHz

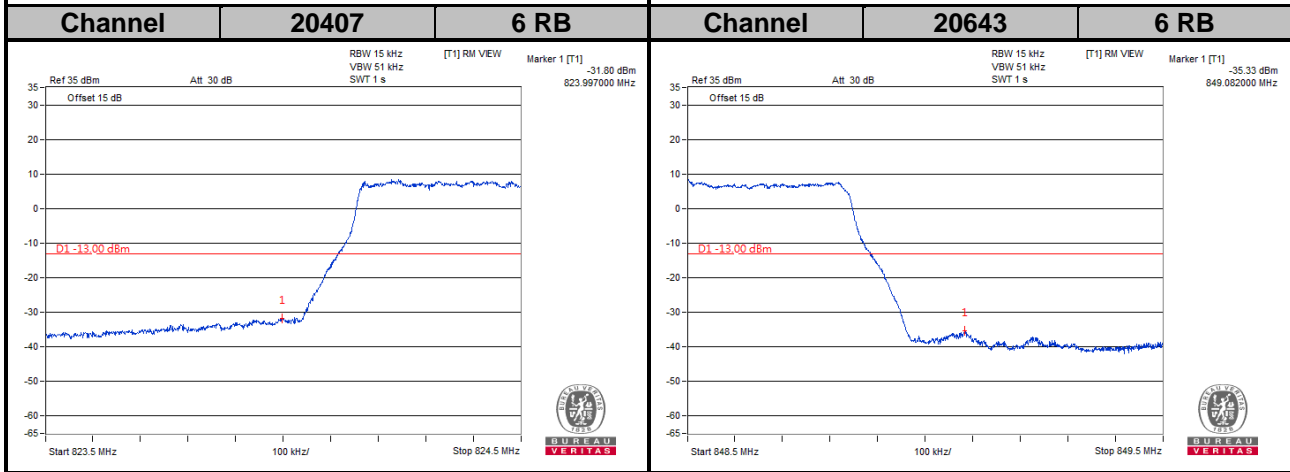
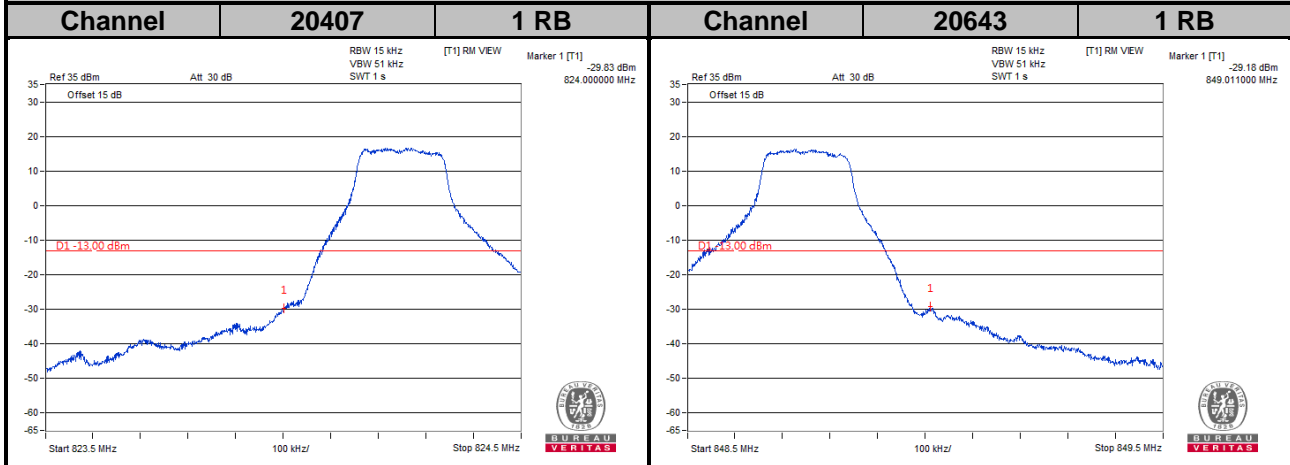

LTE Band 5
Channel Bandwidth: 3 MHz

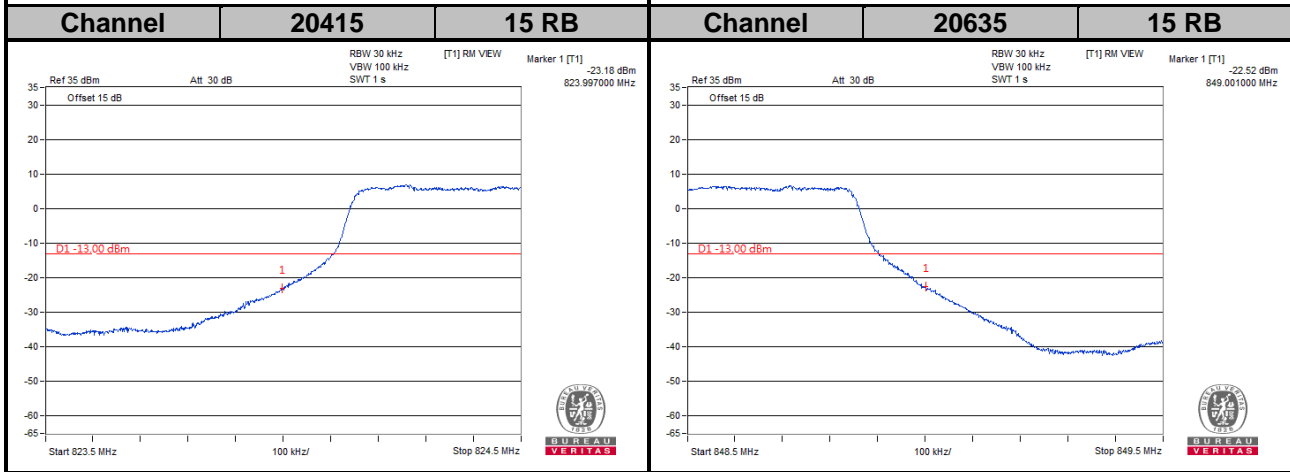
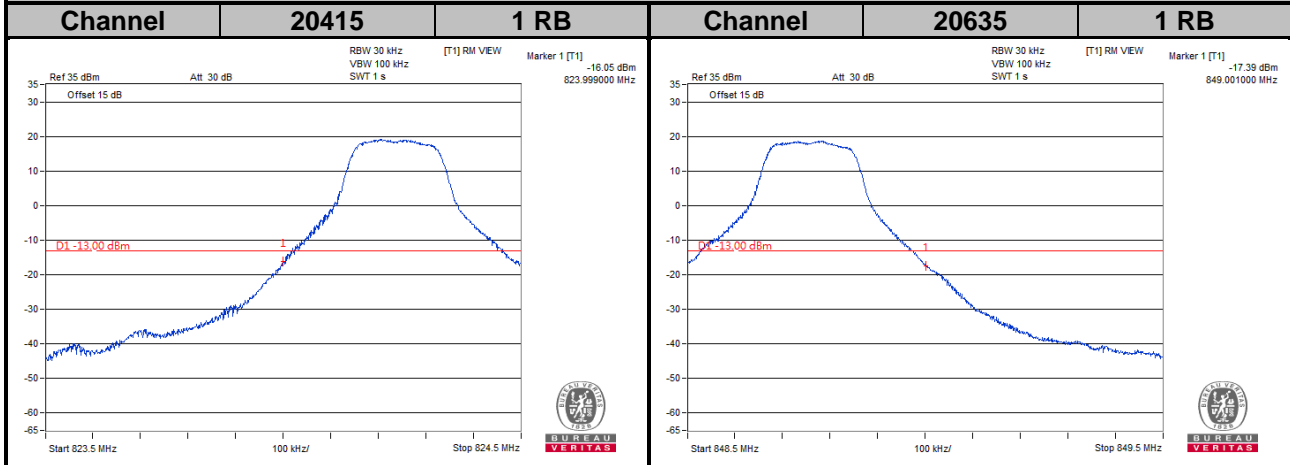

LTE Band 5
Channel Bandwidth: 5 MHz

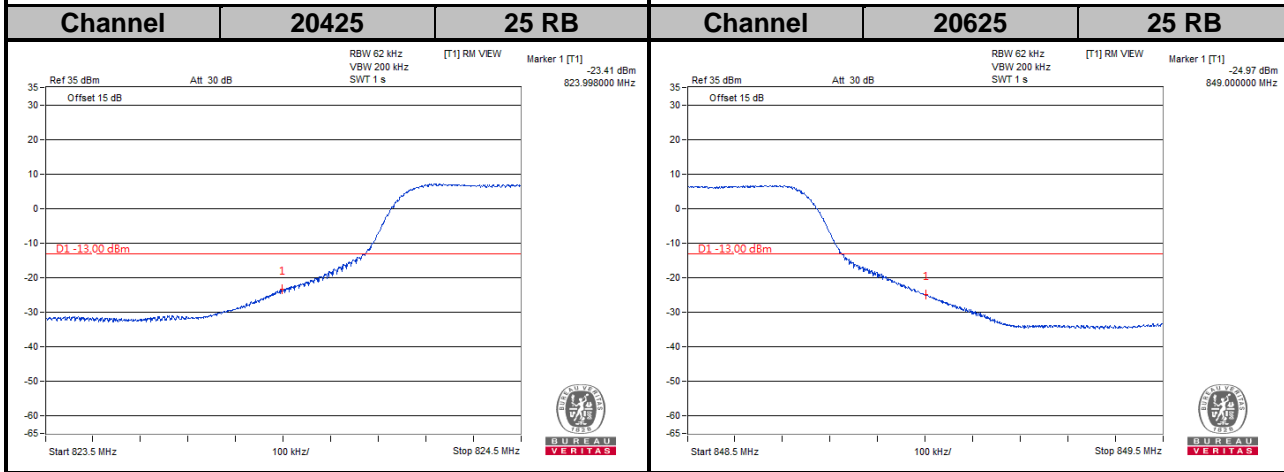
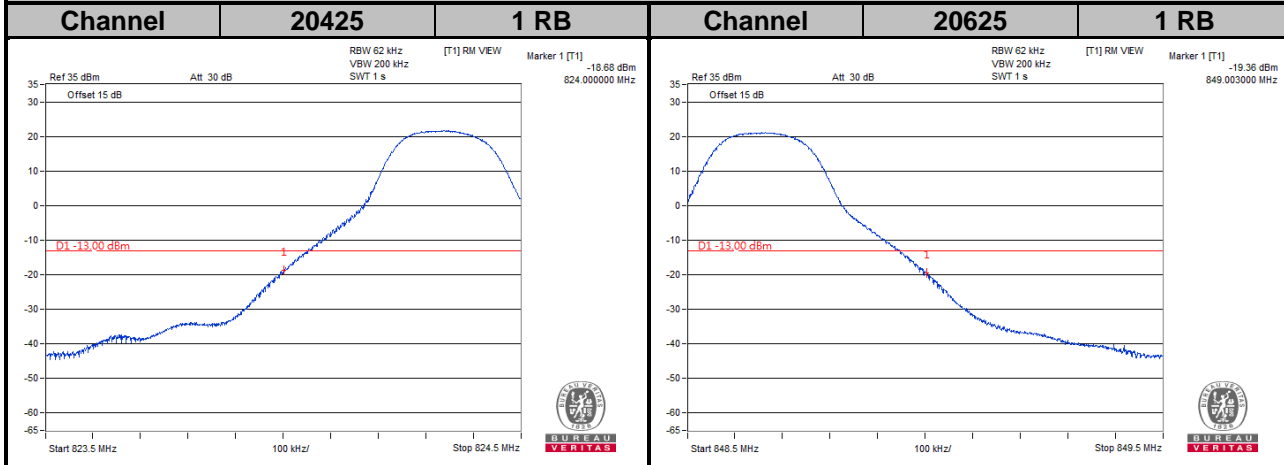

LTE Band 5
Channel Bandwidth: 10 MHz

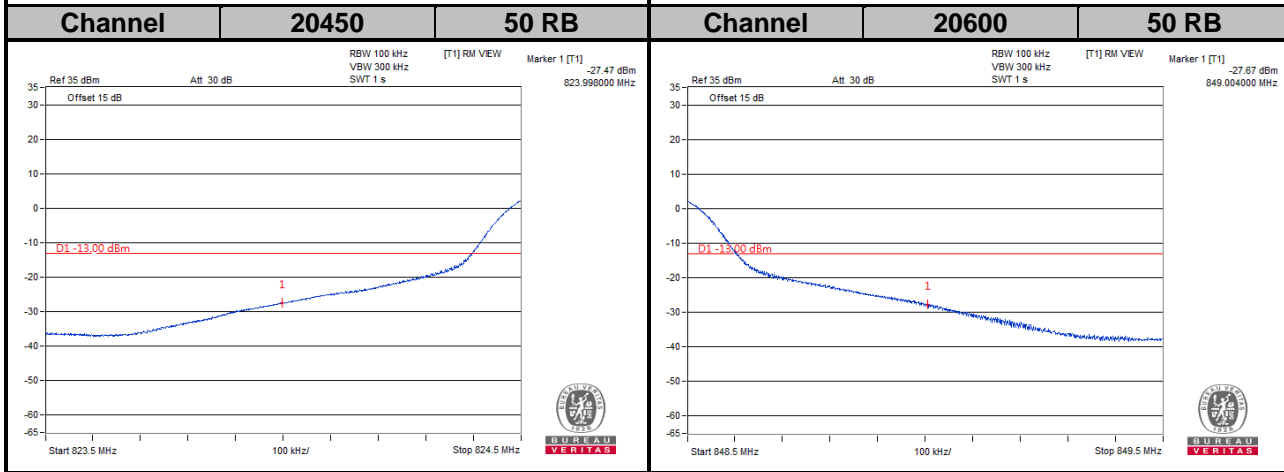
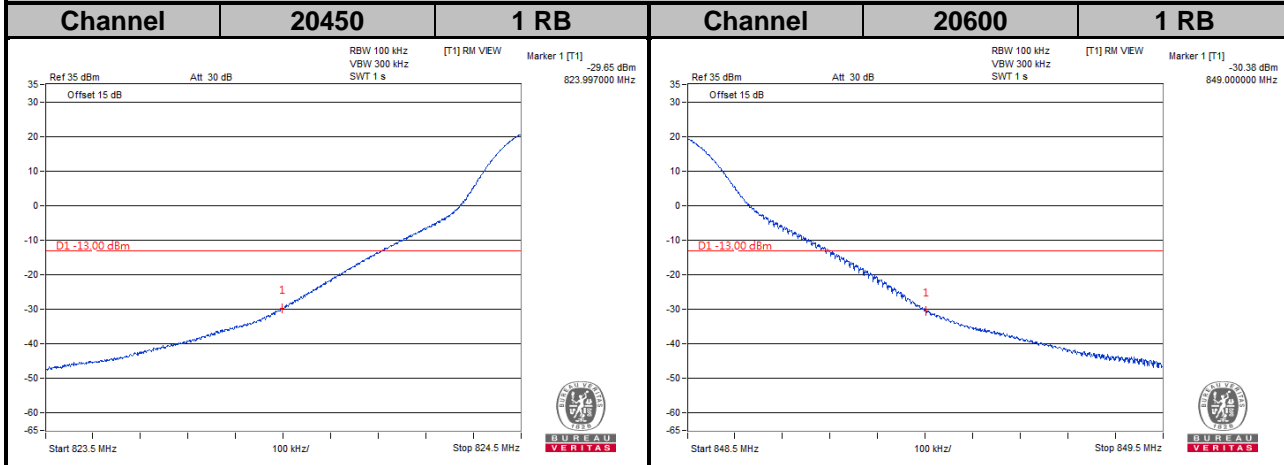

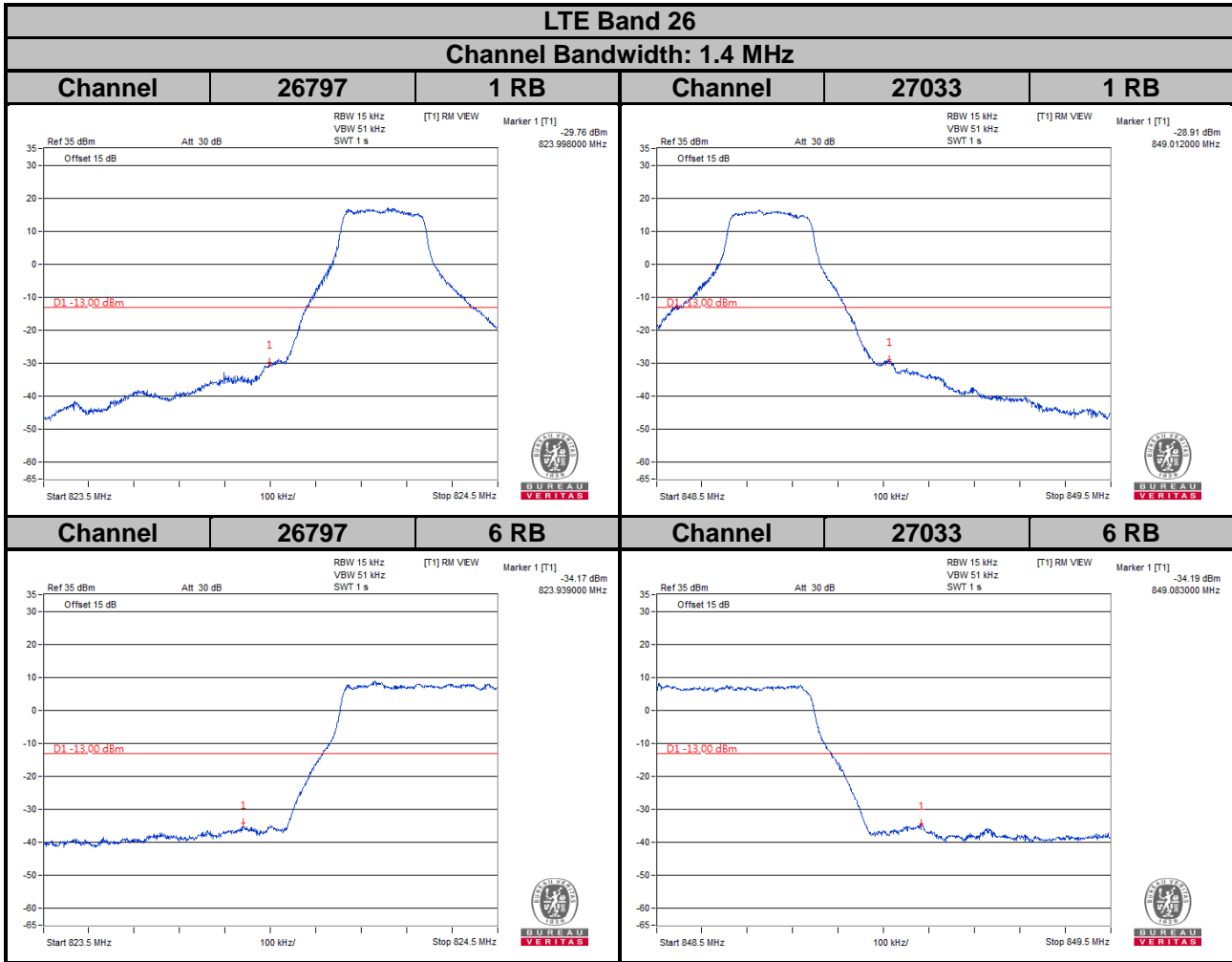

LTE Band 26

Channel Bandwidth: 3 MHz

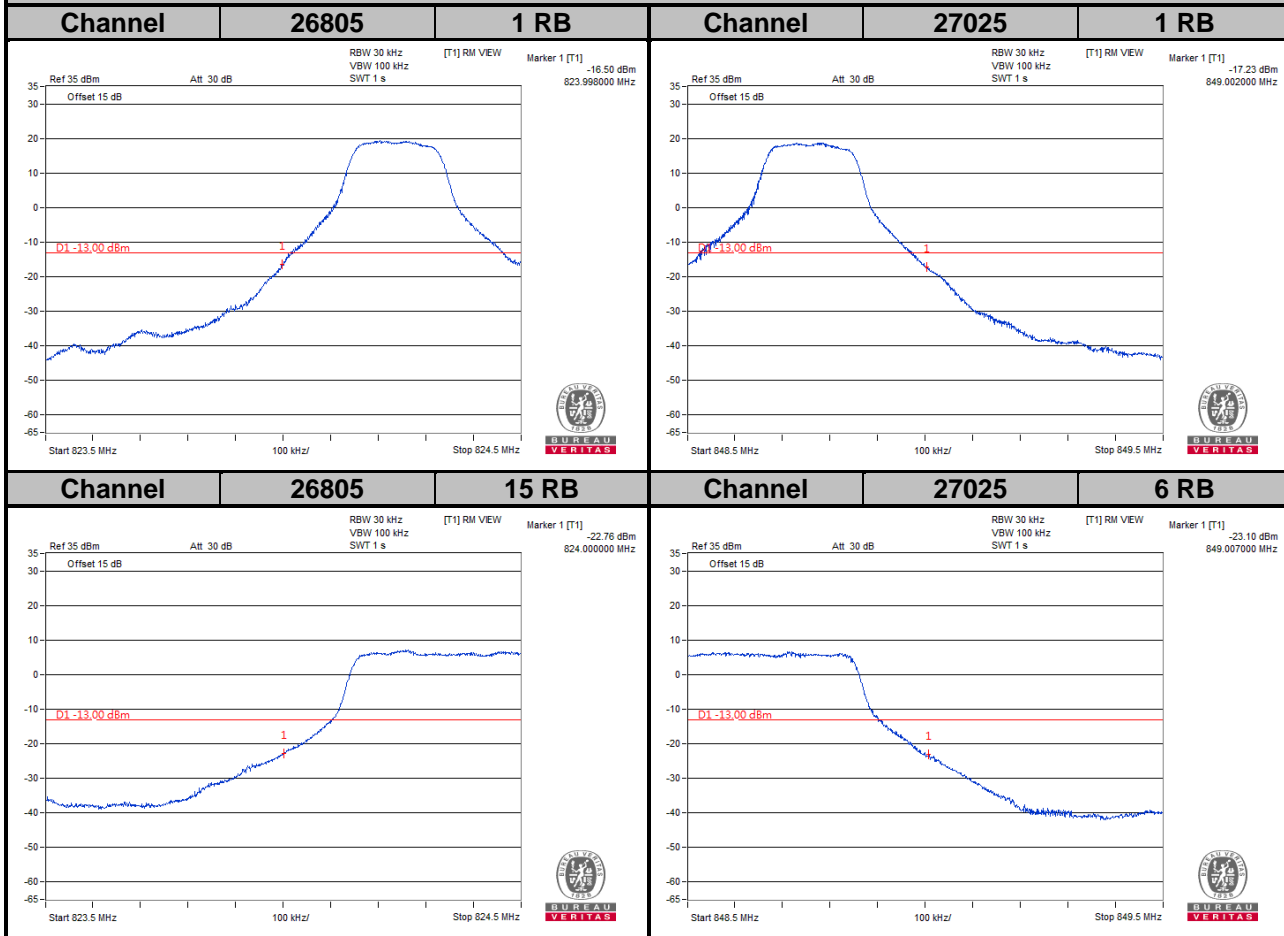

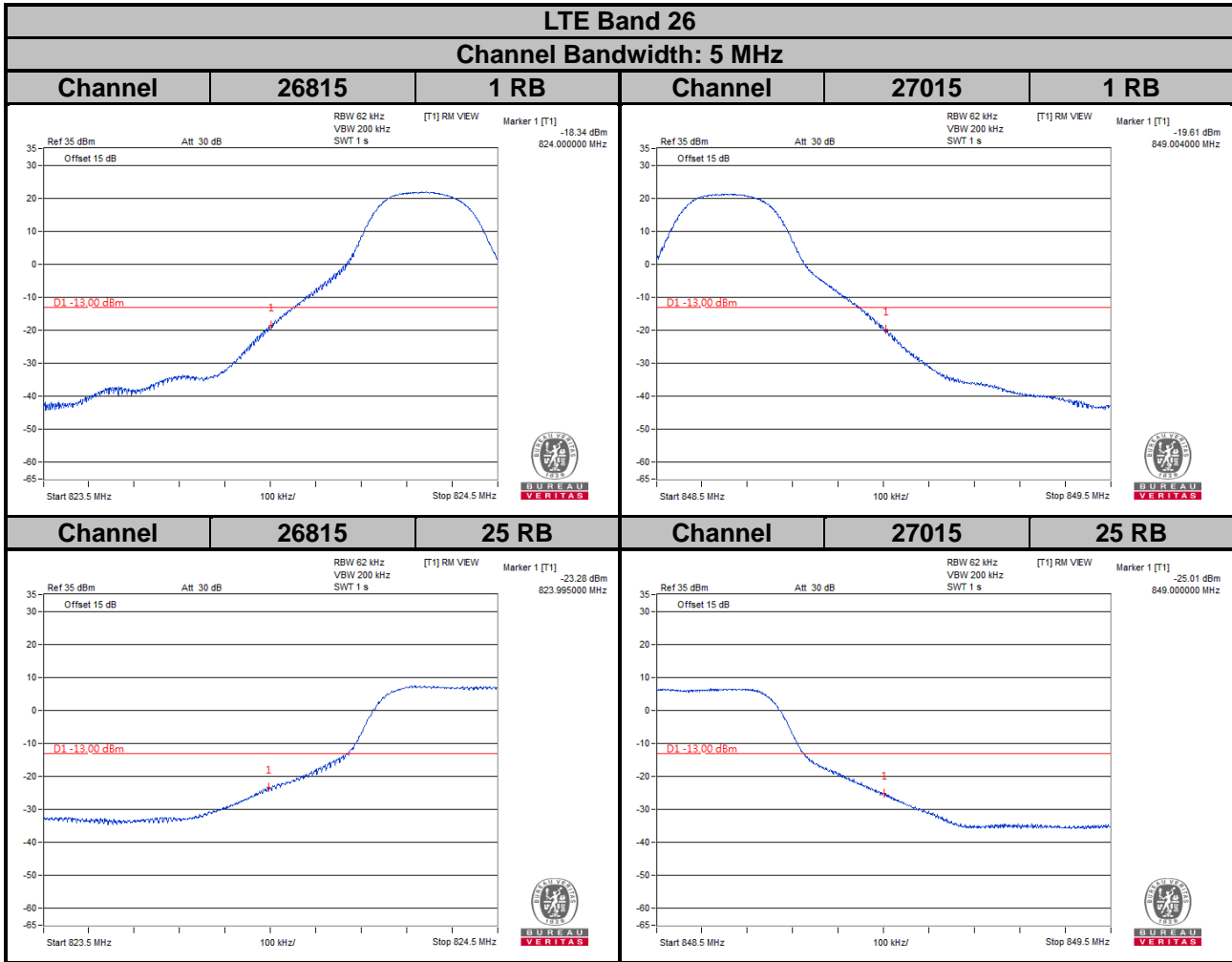

LTE Band 26
Channel Bandwidth: 10 MHz

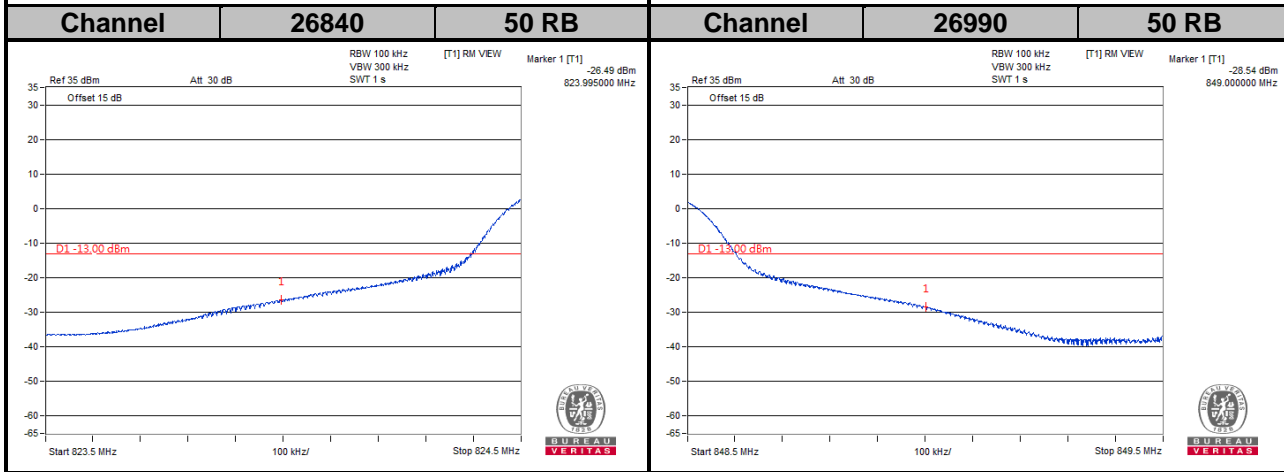
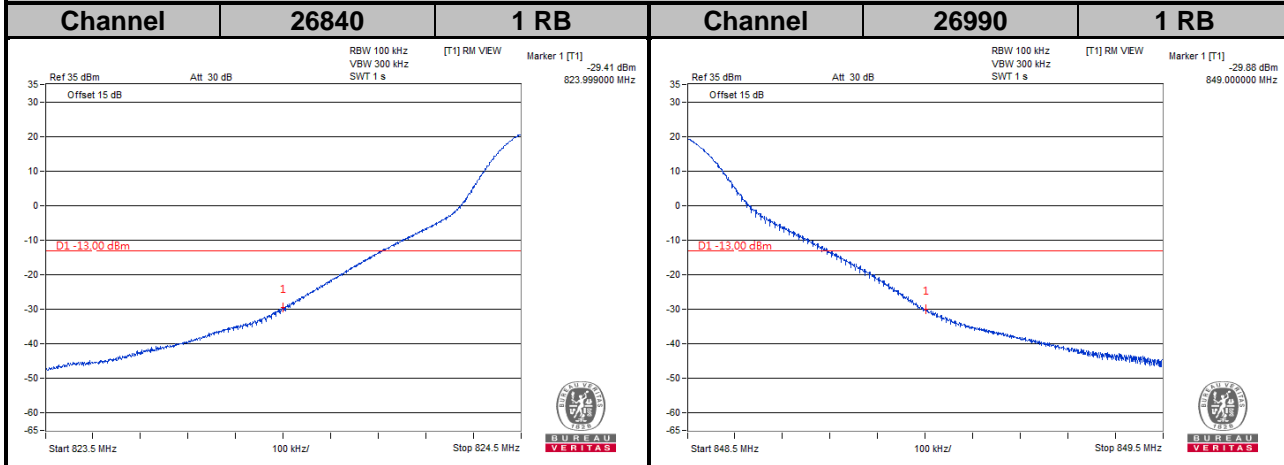

LTE Band 26

Channel Bandwidth: 15 MHz

