

FCC Test Report

Report No.: FD181001C08

FCC ID: A4RG020B

Test Model: G020B

Received Date: Oct. 01, 2018

Test Date: Nov. 07, 2018 ~ Jan. 22, 2019

Issued Date: Jan. 23, 2019

Applicant: Google LLC

Address: 1600 Amphitheatre Parkway Mountain View, CA 94043, USA

Issued By: Bureau Veritas Consumer Products Services (H.K.) Ltd., Taoyuan Branch

Lab Address: No.19, Hwa Ya 2nd Rd., Wen Hwa Vil., Kwei Shan Dist., Taoyuan City
33383, TAIWAN (R.O.C.)

**FCC Registration /
Designation Number:** 328930 / TW1050



This report is for your exclusive use. Any copying or replication of this report to or for any other person or entity, or use of our name or trademark, is permitted only with our prior written permission. This report sets forth our findings solely with respect to the test samples identified herein. The results set forth in this report are not indicative or representative of the quality or characteristics of the lot from which a test sample was taken or any similar or identical product unless specifically and expressly noted. Our report includes all of the tests requested by you and the results thereof based upon the information that you provided to us. You have 60 days from date of issuance of this report to notify us of any material error or omission caused by our negligence, provided, however, that such notice shall be in writing and shall specifically address the issue you wish to raise. A failure to raise such issue within the prescribed time shall constitute your unqualified acceptance of the completeness of this report, the tests conducted and the correctness of the report contents. Unless specific mention, the uncertainty of measurement has been explicitly taken into account to declare the compliance or non-compliance to the specification. The report must not be used by the client to claim product certification, approval, or endorsement by A2LA, or any agency of the U.S. government. The report must not be used by the client to claim product certification, approval, or endorsement by TAF or any government agencies.

Table of Contents

Release Control Record	3
1 Certificate of Conformity	4
2 Summary of Test Results.....	5
2.1 Measurement Uncertainty	5
2.2 Modification Record	5
3 General Information	6
3.1 Features of EUT	6
3.2 General Description of EUT	6
3.3 Operating Modes of EUT and Determination of Worst Case Operating Mode	7
3.4 Test Program Used and Operation Descriptions.....	9
3.5 Primary Clock Frequencies of Internal Source	9
4 Configuration and Connections with EUT	10
4.1 Connection Diagram of EUT and Peripheral Devices	10
4.2 Configuration of Peripheral Devices and Cable Connections	12
5 Conducted Emissions at Mains Ports.....	13
5.1 Limits	13
5.2 Test Instruments	13
5.3 Test Arrangement	14
5.4 Test Results.....	15
6 Radiated Emissions up to 1 GHz	21
6.1 Limits	21
6.2 Test Instruments	22
6.3 Test Arrangement	23
6.4 Test Results.....	24
7 Radiated Emissions above 1 GHz.....	30
7.1 Limits	30
7.2 Test Instruments	31
7.3 Test Arrangement	32
7.4 Test Results.....	33
Appendix – Information on the Testing Laboratories	45

Release Control Record

Issue No.	Description	Date Issued
FD181001C08	Original Release	Jan. 23, 2019

1 Certificate of Conformity

Product: Smartphone
Test Model: G020B
Sample Status: Identical Prototype
Applicant: Google LLC
Test Date: Nov. 07, 2018 ~ Jan. 22, 2019
Standards: 47 CFR FCC Part 15, Subpart B, Class B
ICES-003:2016 Issue 6, Class B
ANSI C63.4:2014

The above equipment has been tested by **Bureau Veritas Consumer Products Services (H.K.) Ltd., Taoyuan Branch**, and found compliance with the requirement of the above standards. The test record, data evaluation & Equipment Under Test (EUT) configurations represented herein are true and accurate accounts of the measurements of the sample's EMC characteristics under the conditions specified in this report.

Prepared by : Gina Liu , **Date:** Jan. 23, 2019
Gina Liu / Specialist

Approved by : Carl Chen , **Date:** Jan. 23, 2019
Carl Chen / Project Engineer

2 Summary of Test Results

47 CFR FCC Part 15, Subpart B / ICES-003:2016 Issue 6, Class B
ANSI C63.4:2014

FCC Clause	ICES-003 Clause	Test Item	Result/Remarks	Verdict
15.107	6.1	AC Power Line Conducted Emissions	Minimum passing Class B margin is -8.06 dB at 0.56625 MHz	Pass
15.109	6.2.1	Radiated Emissions up to 1 GHz	Minimum passing Class B margin is -4.29 dB at 730.38 MHz	Pass
	6.2.2	Radiated Emissions above 1 GHz	Minimum passing Class B margin is -18.71 dB at 3542.35 MHz	Pass

Note: There is no deviation to the applied test methods and requirements covered by the scope of this report.

2.1 Measurement Uncertainty

Where relevant, the following measurement uncertainty levels have been estimated for tests performed on the EUT:

The listed uncertainties are the worst case uncertainty for the entire range of measurement. Please note that the uncertainty values are provided for informational purposes only and are not used in determining the PASS/FAIL results.

Measurement	Frequency	Expanded Uncertainty (k=2) (±)
Conducted Emissions at mains ports	150 kHz ~ 30 MHz	2.44 dB
Radiated Emissions up to 1 GHz	30 MHz ~ 1 GHz	4.70 dB
Radiated Emissions above 1 GHz	Above 1 GHz	2.26 dB

2.2 Modification Record

There were no modifications required for compliance.

3 General Information

3.1 Features of EUT

The tests reported herein were performed according to the method specified by Google LLC, for detailed feature description, please refer to the manufacturer's specifications or user's manual.

3.2 General Description of EUT

Product	Smartphone
Test Model	G020B
Status of EUT	Identical Prototype
Operating Software	Android 9
Power Supply Rating	3.85 Vdc (Battery) 5 Vdc or 9 Vdc (Adapter) 5 Vdc (host equipment)
Accessory Device	Refer to Note as below
Data Cable Supplied	Refer to Note as below

Note:

1. The EUT accessories list refers to EUT Photo.pdf.
2. There're 2 configurations for the EUT listed as below.
Main Sample (A): EUT + Battery 1
2nd Sample (B): EUT + Battery 2

3.3 Operating Modes of EUT and Determination of Worst Case Operating Mode

Test modes are presented in the report as below.

Mode	Sample	Test Condition
		Conducted Emission
1	A	GSM850 Link + BT Link + WLAN (2.4G) Link + GPS & GLONASS Rx + USB Cable 1 + Earphone + NFC On + Adapter 1
2	A	WCDMA1900 Link + BT Link + WLAN (5G) Link + Rear Camera + USB Cable 2 + Earphone + NFC On + Adapter 2
3	A	CDMA BC0 Link + BT Link + WLAN (5G) Link + Front Camera + USB Cable 2 + Earphone + NFC On + Adapter 2
4	A	LTE Band 7 Link + BT Link + WLAN (5G) Link + MPEG4 + USB Cable 2 + Earphone + NFC On + USB Link
5	A	WCDMA1900 Link + BT Link + WLAN (5G) Link + Rear Camera + USB Cable 2 + Earphone + NFC On + Adapter 2 + eSIM
6	B	WCDMA1900 Link + BT Link + WLAN (5G) Link + Rear Camera + USB Cable 2 + Earphone + NFC On + Adapter 2
7	A	CDMA BC10 Link (High Channel) + BT Link + WLAN (5G) Link + Rear Camera + USB Cable 2 + Earphone + NFC On + Adapter 2
8	A	CDMA BC10 Link (Middle Channel) + BT Link + WLAN (5G) Link + Rear Camera + USB Cable 2 + Earphone + NFC On + Adapter 2
9	A	CDMA BC10 Link (Low Channel) + BT Link + WLAN (5G) Link + Rear Camera + USB Cable 2 + Earphone + NFC On + Adapter 2
10	A	LTE Band 12 Link (High Channel) + BT Link + WLAN (5G) Link + Rear Camera + USB Cable 2 + Earphone + NFC On + Adapter 2
11	A	LTE Band 12 Link (Middle Channel) + BT Link + WLAN (5G) Link + Rear Camera + USB Cable 2 + Earphone + NFC On + Adapter 2
12	A	LTE Band 12 Link (Low Channel) + BT Link + WLAN (5G) Link + Rear Camera + USB Cable 2 + Earphone + NFC On + Adapter 2
13	A	LTE Band 13 Link (High Channel) + BT Link + WLAN (5G) Link + Rear Camera + USB Cable 2 + Earphone + NFC On + Adapter 2
14	A	LTE Band 13 Link (Middle Channel) + BT Link + WLAN (5G) Link + Rear Camera + USB Cable 2 + Earphone + NFC On + Adapter 2
15	A	LTE Band 13 Link (Low Channel) + BT Link + WLAN (5G) Link + Rear Camera + USB Cable 2 + Earphone + NFC On + Adapter 2

Mode	Sample	Test Condition
		Radiated Emission
1	A	GSM850 Link + BT Link + WLAN (2.4G) Link + GPS & GLONASS Rx + USB Cable 1 + Earphone + NFC On + Adapter 1
2	A	WCDMA1900 Link + BT Link + WLAN (5G) Link + Rear Camera + USB Cable 2 + Earphone + NFC On + Adapter 2
3	A	CDMA BC0 Link + BT Link + WLAN (2.4G) Link + Front Camera + USB Cable 1 + Earphone + NFC On + USB Link
4	A	LTE Band 7 Link + BT Link + WLAN (2.4G) Link + MPEG4 (Flash Play) + Earphone + NFC On + OTG Dongle + Flash
5	A	GSM850 Link + BT Link + WLAN (2.4G) Link + GPS & GLONASS Rx + USB Cable 1 + Earphone + NFC On + Adapter 1 + eSIM
6	B	GSM850 Link + BT Link + WLAN (2.4G) Link + GPS & GLONASS Rx + USB Cable 1 + Earphone + NFC On + Adapter 1
7	A	CDMA BC10 Link (High Channel) + BT Link + WLAN (2.4G) Link + GPS & GLONASS Rx + USB Cable 1 + Earphone + NFC On + Adapter 1
8	A	CDMA BC10 Link (Middle Channel) + BT Link + WLAN (2.4G) Link + GPS & GLONASS Rx + USB Cable 1 + Earphone + NFC On + Adapter 1
9	A	CDMA BC10 Link (Low Channel) + BT Link + WLAN (2.4G) Link + GPS & GLONASS Rx + USB Cable 1 + Earphone + NFC On + Adapter 1
10	A	LTE Band 12 Link (High Channel) + BT Link + WLAN (2.4G) Link + GPS & GLONASS Rx + USB Cable 1 + Earphone + NFC On + Adapter 1
11	A	LTE Band 12 Link (Middle Channel) + BT Link + WLAN (2.4G) Link + GPS & GLONASS Rx + USB Cable 1 + Earphone + NFC On + Adapter 1
12	A	LTE Band 12 Link (Low Channel) + BT Link + WLAN (2.4G) Link + GPS & GLONASS Rx + USB Cable 1 + Earphone + NFC On + Adapter 1
13	A	LTE Band 13 Link (High Channel) + BT Link + WLAN (2.4G) Link + GPS & GLONASS Rx + USB Cable 1 + Earphone + NFC On + Adapter 1
14	A	LTE Band 13 Link (Middle Channel) + BT Link + WLAN (2.4G) Link + GPS & GLONASS Rx + USB Cable 1 + Earphone + NFC On + Adapter 1
15	A	LTE Band 13 Link (Low Channel) + BT Link + WLAN (2.4G) Link + GPS & GLONASS Rx + USB Cable 1 + Earphone + NFC On + Adapter 1

Remark:

- For cellular band between 30 M ~960 MHz (Including GSM850/WCDMA V/CDMA BC10/LTE Band 5/LTE Band 12/ LTE Band 13 / LTE Band 17/LTE Band26), we chose CDMA BC10, LTE Band 12 and LTE Band 13 to test in Low / Middle / High channels to cover all these bands in this report.
- The EUT had been pre-tested on the positioned of each 3 axis. The worst case was found when positioned on Z-plane.
- The worst case for conducted emission test and radiated emission test are listed as below. Only these modes were presented in the report.

	Conducted Emission	Radiated Emission
Adapter Mode	Mode 2	Mode 1
USB Link Mode	Mode 4	Mode 3
Receiver Mode	Mode 6	Mode 6

3.4 Test Program Used and Operation Descriptions

For Conducted Emission

Mode 2, 6

- a. The EUT linked with Bluetooth earphone.
- b. The NFC function was turned on.
- c. The EUT played camera and sent audio signal to the earphone.
- d. The EUT communicated data with the Radio Communication Analyze and Wireless AP, which acted as communication partners.

Mode 4

- a. The EUT linked with Bluetooth earphone.
- b. The EUT linked with notebook via USB cable.
- c. The NFC function was turned on.
- d. The EUT played MPEG.
- e. The EUT sent audio signal to the earphone.
- f. The EUT communicated data with the Radio Communication Analyzer and Wireless AP, which acted as communication partners.

For Radiated Emission

Mode 1, 6

- a. The EUT linked with Bluetooth earphone.
- b. The NFC function was turned on.
- c. The EUT sent audio signal to the earphone.
- d. The EUT communicated data with the Radio Communication Analyze, GPS simulator and Wireless AP, which acted as communication partners.

Mode 3

- a. The EUT linked with Bluetooth earphone.
- b. The EUT linked with notebook via USB cable.
- c. The NFC function was turned on.
- d. The EUT played camera.
- e. The EUT sent audio signal to the earphone.
- f. The EUT communicated data with the Radio Communication Analyzer and Wireless AP, which acted as communication partners.

3.5 Primary Clock Frequencies of Internal Source

The highest frequency generated or used within the EUT or on which the EUT operates or tunes is 5 GHz, provided by Google LLC, for detailed internal source, please refer to the manufacturer's specifications.

4 Configuration and Connections with EUT

4.1 Connection Diagram of EUT and Peripheral Devices

For Conducted Emission Mode 2, 6

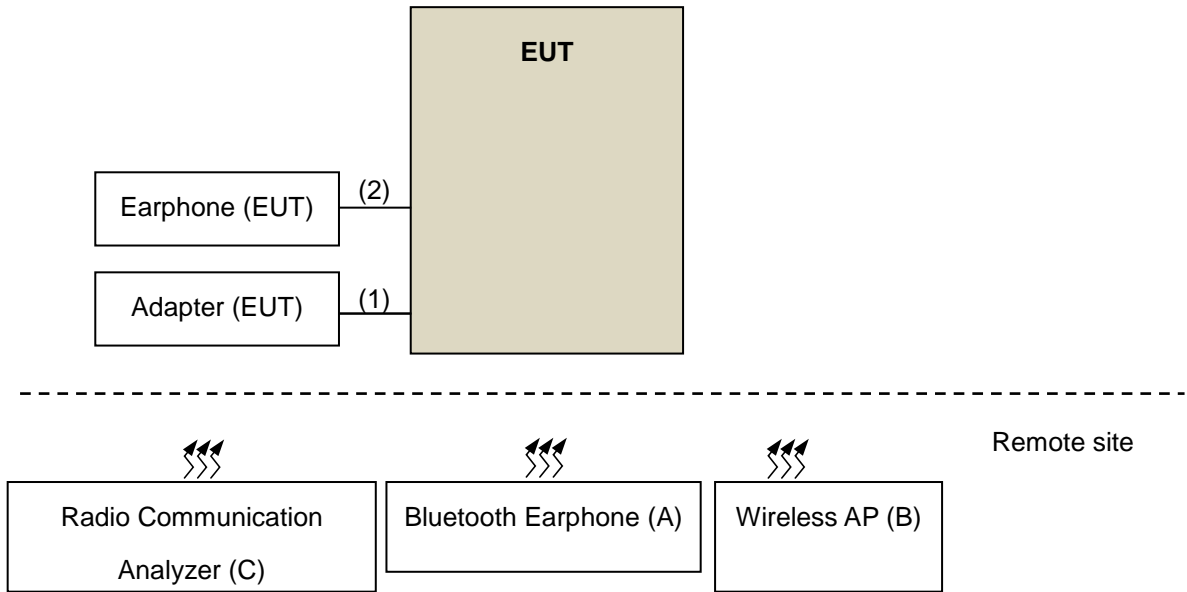

For Conducted Emission Mode 4

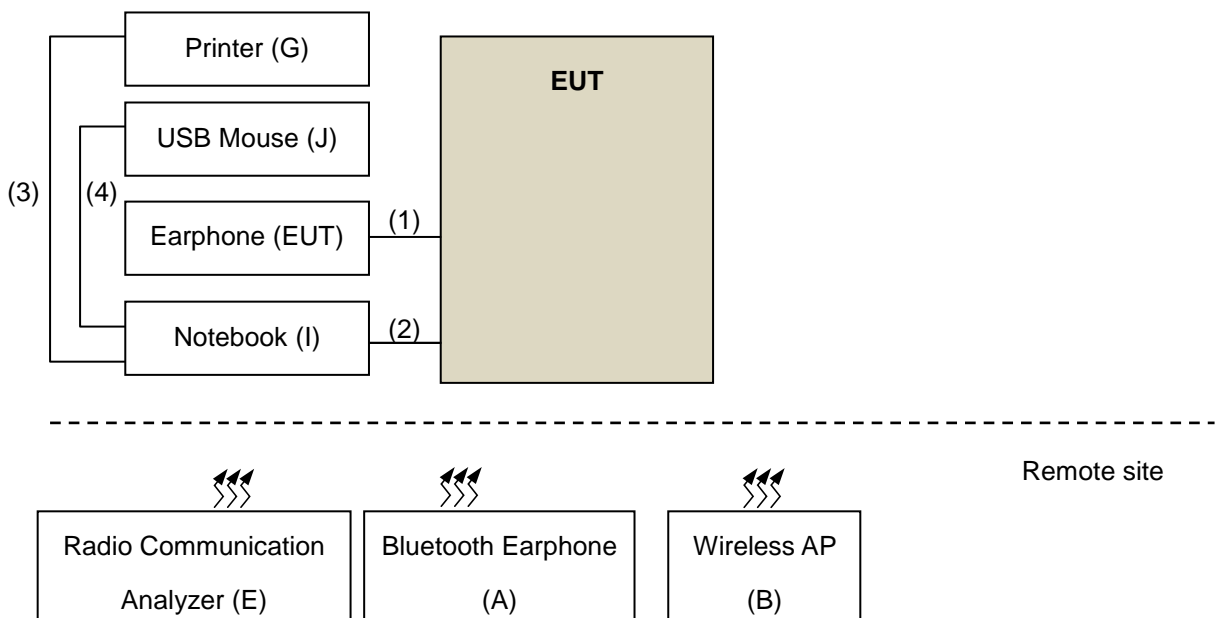

For Radiated Emission Mode 1, 6

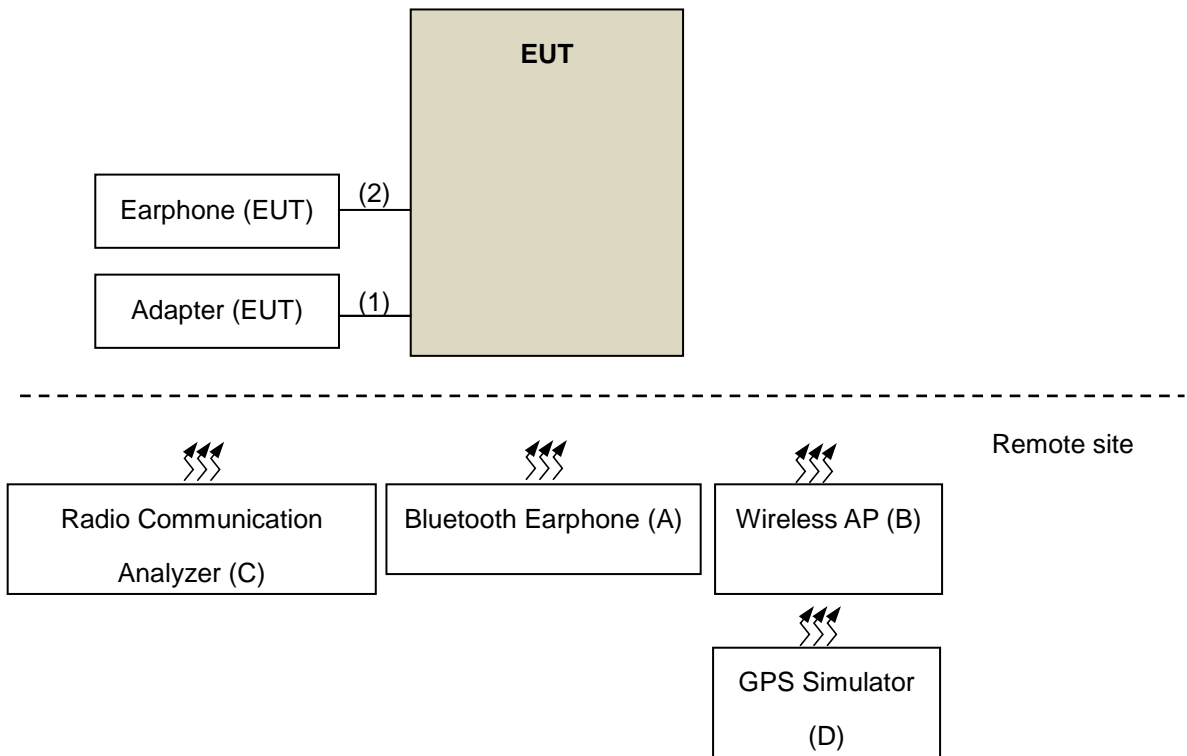

For Radiated Emission Mode 3

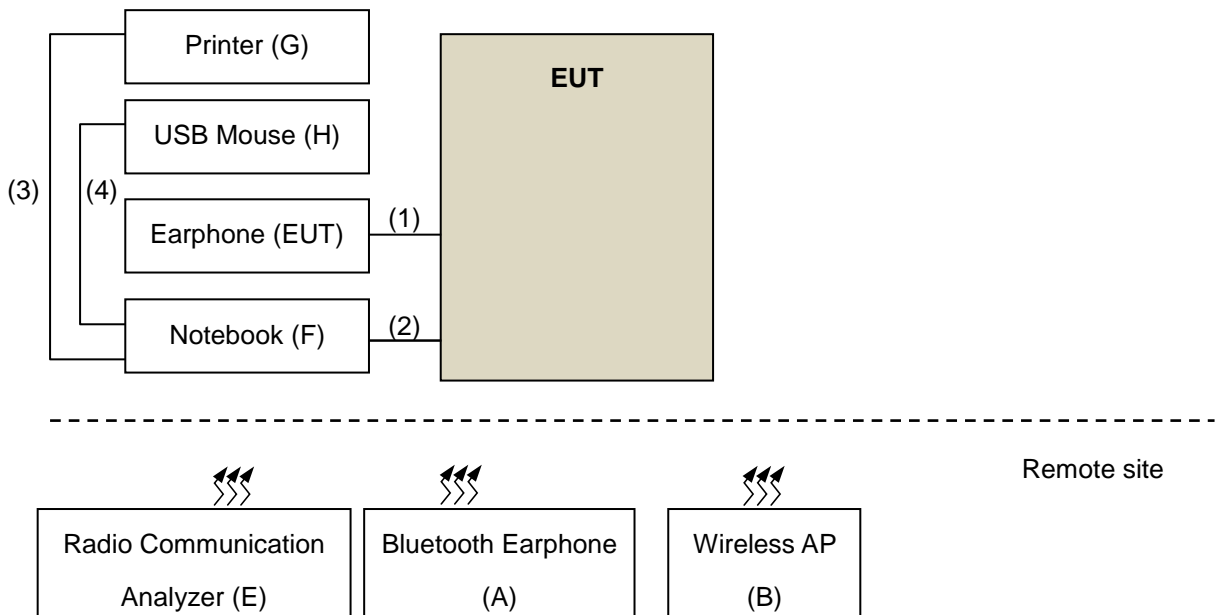

4.2 Configuration of Peripheral Devices and Cable Connections

ID	Product	Brand	Model No.	Serial No.	FCC ID	Remarks
A.	BLUETOOTH EARPHONE	ELECOM	LBT-MPHS400	N/A	N/A	--
B.	Wireless N Dual band Router	D-LINK	DIR-815	PVK21B5000399	KA21R815A1	--
C.	Radio Communication Analyzer	Anritsu	MT8820C	6201010284	N/A	--
D.	GPS simulator	PENDULUM	GSG-54	191121	N/A	--
E.	Radio Communication Analyzer	Anritsu	MT8820C	6201010284	N/A	--
F.	Notebook	DELL	XPS 13-9350	0V5D5A01	N/A	--
G.	USB PRINTER	EPSON	T22	MEEZ070388	N/A	--
H.	USB Mouse	DELL	MOCZUL	CN-049TWY-PRC 00-79E-02FU	N/A	--
I.	Notebook	DELL	E6440	FMLNM32	N/A	--
J.	USB Mouse	DELL	MS111-P	CN-011D3V-7158 1-1CJ-019E	FCC DoC Approved	--

Note:

1. All power cords of the above support units are non-shielded (1.8m).
2. Items A-E acted as communication partners to transfer data.

ID	Descriptions	Qty.	Length (m)	Shielding (Yes/No)	Cores (Qty.)	Remarks
1.	USB Type C Cable	1	0.95	Y	0	Accessory of the EUT
2.	Audio Cable	1	1.12	N	0	Accessory of the EUT
3.	USB Cable	1	1.8	Y	0	
4.	USB Cable	1	1.8	Y	0	

Note: The core(s) is(are) originally attached to the cable(s).

5 Conducted Emissions at Mains Ports

5.1 Limits

Frequency (MHz)	Class A (dBUV)		Class B (dBUV)	
	Quasi-peak	Average	Quasi-peak	Average
0.15 - 0.5	79	66	66 - 56	56 - 46
0.50 - 5.0	73	60	56	46
5.0 - 30.0	73	60	60	50

Notes: 1. The lower limit shall apply at the transition frequencies.
 2. The limit decreases linearly with the logarithm of the frequency in the range of 0.15 to 0.50 MHz.

5.2 Test Instruments

Description & Manufacturer	Model No.	Serial No.	Cal. Date	Cal. Due
Test Receiver ROHDE & SCHWARZ	ESR3	102412	Feb. 08, 2018	Feb. 07, 2019
RF signal cable (with 10dB PAD) Woken	5D-FB	Cable-cond2-01	Sep. 05, 2018	Sep. 04, 2019
LISN/AMN ROHDE & SCHWARZ (EUT)	ESH2-Z5	100100	Feb. 05, 2018	Feb. 04, 2019
LISN/AMN ROHDE & SCHWARZ (Peripheral)	ESH3-Z5	100312	Aug. 13, 2018	Aug. 12, 2019
Software ADT	BV ADT_Cond_ V7.3.7.4	NA	NA	NA

Note: 1. The calibration interval of the above test instruments is 12 months and the calibrations are traceable to NML/ROC and NIST/USA.
 2. The test was performed in HwaYa Shielded Room 2.
 3. The VCCI Site Registration No. is C-2047.

5.3 Test Arrangement

- The EUT was placed 0.4 meters from the conducting wall of the shielded room with EUT being connected to the power mains through a line impedance stabilization network (LISN). Other support units were connected to the power mains through another LISN. The two LISNs provide 50 Ohm/ 50 uH of coupling impedance for the measuring instrument.
- Both lines of the power mains connected to the EUT were checked for maximum conducted interference.
- The test results of conducted emissions at mains ports are recorded of six worst margins for quasi-peak (mandatory) [and average (if necessary)] values against the limits at frequencies of interest unless the margin is 20 dB or greater.

Note: The resolution bandwidth and video bandwidth of test receiver is 9 kHz for quasi-peak detection (QP) and average detection (AV) at frequency 0.15 MHz – 30 MHz.

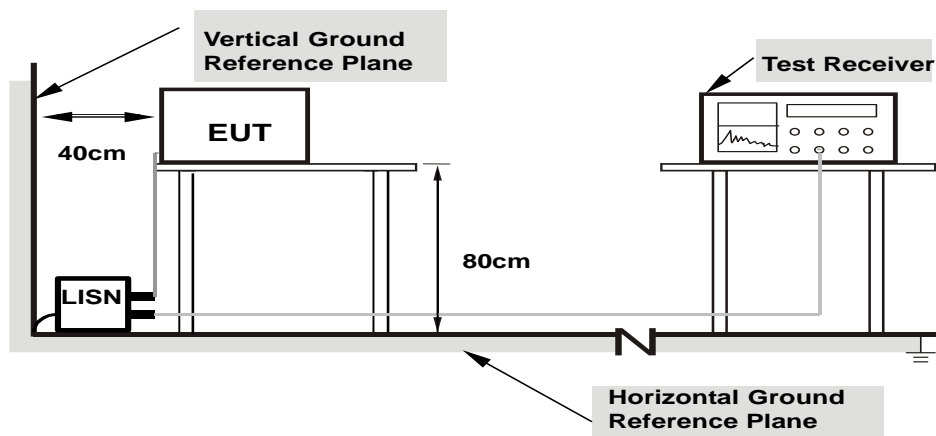

- Note:**
- Support units were connected to second LISN.
 - Both of LISNs (AMN) are 80 cm from EUT and at least 80 cm from other units and other metal planes

5.4 Test Results

Frequency Range	150kHz ~ 30MHz	Detector Function & Resolution Bandwidth	Quasi-Peak (QP) / Average (AV), 9kHz
Input Power	120Vac, 60Hz	Environmental Conditions	23°C, 63%RH
Tested by	Fox Chang	Test Date	2018/11/23
Test Mode	Mode 1		

Phase Of Power : Line (L)										
No	Frequency (MHz)	Correction Factor (dB)	Reading Value (dBuV)		Emission Level (dBuV)		Limit (dBuV)		Margin (dB)	
			Q.P.	AV.	Q.P.	AV.	Q.P.	AV.	Q.P.	AV.
1	0.20518	10.12	26.60	18.02	36.72	28.14	63.40	53.40	-26.68	-25.26
2	0.39911	10.13	24.12	15.14	34.25	25.27	57.87	47.87	-23.62	-22.60
3	0.55371	10.14	35.85	25.04	45.99	35.18	56.00	46.00	-10.01	-10.82
4	0.80772	10.15	29.42	16.25	39.57	26.40	56.00	46.00	-16.43	-19.60
5	1.26600	10.15	22.81	15.38	32.96	25.53	56.00	46.00	-23.04	-20.47
6	1.64330	10.14	22.65	14.21	32.79	24.35	56.00	46.00	-23.21	-21.65

Remarks:

1. Q.P. and AV. are abbreviations of quasi-peak and average individually.
2. The emission levels of other frequencies were very low against the limit.
3. Margin value = Emission level – Limit value
4. Correction factor = Insertion loss + Cable loss
5. Emission Level = Correction Factor + Reading Value

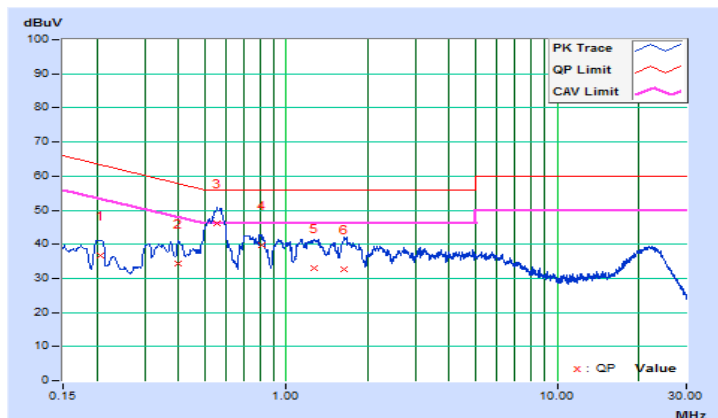

Frequency Range	150kHz ~ 30MHz	Detector Function & Resolution Bandwidth	Quasi-Peak (QP) / Average (AV), 9kHz
Input Power	120Vac, 60Hz	Environmental Conditions	23°C, 63%RH
Tested by	Fox Chang	Test Date	2018/11/23
Test Mode	Mode 1		

Phase Of Power : Neutral (N)										
No	Frequency (MHz)	Correction Factor (dB)	Reading Value (dBuV)		Emission Level (dBuV)		Limit (dBuV)		Margin (dB)	
			Q.P.	AV.	Q.P.	AV.	Q.P.	AV.	Q.P.	AV.
1	0.19983	10.11	26.02	11.69	36.13	21.80	63.62	53.62	-27.49	-31.82
2	0.39911	10.10	26.90	17.07	37.00	27.17	57.87	47.87	-20.87	-20.70
3	0.56625	10.12	35.48	27.82	45.60	37.94	56.00	46.00	-10.40	-8.06
4	0.72103	10.13	29.82	20.00	39.95	30.13	56.00	46.00	-16.05	-15.87
5	0.94200	10.15	27.53	19.03	37.68	29.18	56.00	46.00	-18.32	-16.82
6	1.23559	10.16	25.01	16.47	35.17	26.63	56.00	46.00	-20.83	-19.37

Remarks:

1. Q.P. and AV. are abbreviations of quasi-peak and average individually.
2. The emission levels of other frequencies were very low against the limit.
3. Margin value = Emission level – Limit value
4. Correction factor = Insertion loss + Cable loss
5. Emission Level = Correction Factor + Reading Value

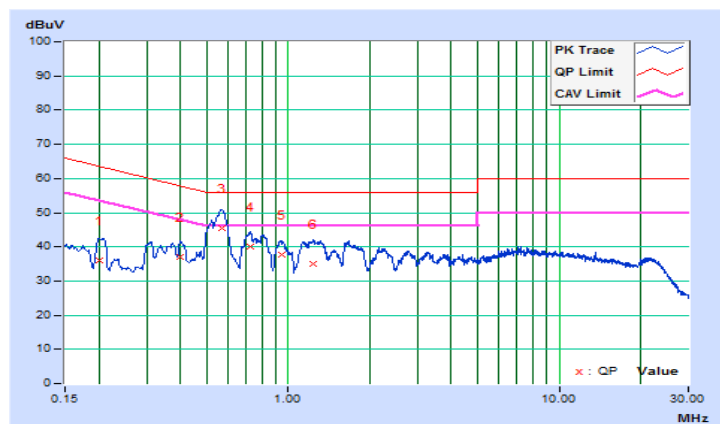

Frequency Range	150kHz ~ 30MHz	Detector Function & Resolution Bandwidth	Quasi-Peak (QP) / Average (AV), 9kHz
Input Power	120Vac, 60Hz	Environmental Conditions	23°C, 66%RH
Tested by	Mick Chou	Test Date	2019/1/21
Test Mode	Mode 4		

Phase Of Power : Line (L)										
No	Frequency (MHz)	Correction Factor (dB)	Reading Value (dBuV)		Emission Level (dBuV)		Limit (dBuV)		Margin (dB)	
			Q.P.	AV.	Q.P.	AV.	Q.P.	AV.	Q.P.	AV.
1	0.15000	10.05	40.96	29.00	51.01	39.05	66.00	56.00	-14.99	-16.95
2	0.17146	10.05	33.79	8.52	43.84	18.57	64.89	54.89	-21.05	-36.32
3	0.24488	10.06	26.46	8.56	36.52	18.62	61.93	51.93	-25.41	-33.31
4	0.48652	10.06	31.04	26.46	41.10	36.52	56.23	46.23	-15.13	-9.71
5	3.52950	10.13	23.50	12.69	33.63	22.82	56.00	46.00	-22.37	-23.18
6	10.06800	10.29	23.27	17.13	33.56	27.42	60.00	50.00	-26.44	-22.58

Remarks:

1. Q.P. and AV. are abbreviations of quasi-peak and average individually.
2. The emission levels of other frequencies were very low against the limit.
3. Margin value = Emission level – Limit value
4. Correction factor = Insertion loss + Cable loss
5. Emission Level = Correction Factor + Reading Value

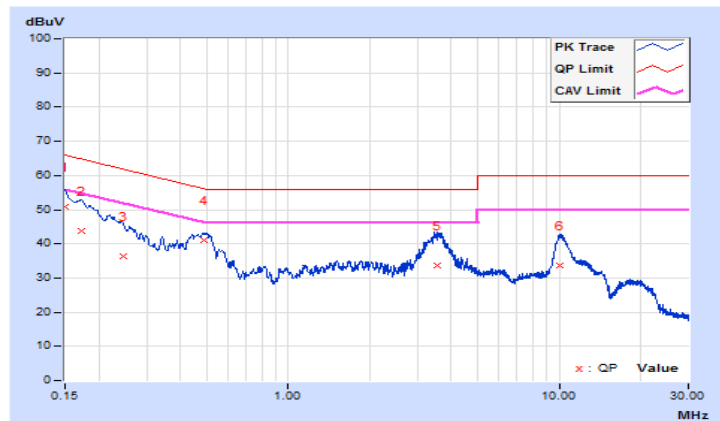

Frequency Range	150kHz ~ 30MHz	Detector Function & Resolution Bandwidth	Quasi-Peak (QP) / Average (AV), 9kHz
Input Power	120Vac, 60Hz	Environmental Conditions	23°C, 66%RH
Tested by	Mick Chou	Test Date	2019/1/21
Test Mode	Mode 4		

Phase Of Power : Neutral (N)										
No	Frequency (MHz)	Correction Factor (dB)	Reading Value (dBuV)		Emission Level (dBuV)		Limit (dBuV)		Margin (dB)	
			Q.P.	AV.	Q.P.	AV.	Q.P.	AV.	Q.P.	AV.
1	0.15000	10.06	40.56	28.05	50.62	38.11	66.00	56.00	-15.38	-17.89
2	0.19500	10.07	32.99	17.41	43.06	27.48	63.82	53.82	-20.76	-26.34
3	0.49298	10.07	31.12	22.15	41.19	32.22	56.12	46.12	-14.93	-13.90
4	1.40775	10.08	18.13	9.88	28.21	19.96	56.00	46.00	-27.79	-26.04
5	3.47775	10.15	24.14	12.17	34.29	22.32	56.00	46.00	-21.71	-23.68
6	10.13400	10.36	19.37	12.93	29.73	23.29	60.00	50.00	-30.27	-26.71

Remarks:

1. Q.P. and AV. are abbreviations of quasi-peak and average individually.
2. The emission levels of other frequencies were very low against the limit.
3. Margin value = Emission level – Limit value
4. Correction factor = Insertion loss + Cable loss
5. Emission Level = Correction Factor + Reading Value

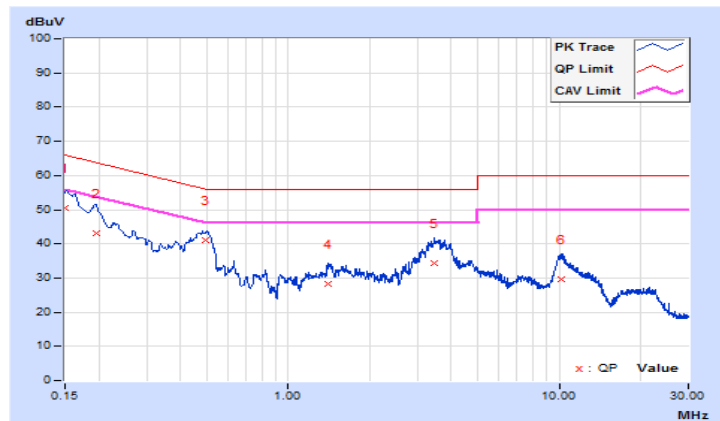

Frequency Range	150kHz ~ 30MHz	Detector Function & Resolution Bandwidth	Quasi-Peak (QP) / Average (AV), 9kHz
Input Power	120Vac, 60Hz	Environmental Conditions	23°C, 62%RH
Tested by	Mick Chou	Test Date	2019/1/19
Test Mode	Mode 6		

Phase Of Power : Line (L)										
No	Frequency (MHz)	Correction Factor (dB)	Reading Value (dBuV)		Emission Level (dBuV)		Limit (dBuV)		Margin (dB)	
			Q.P.	AV.	Q.P.	AV.	Q.P.	AV.	Q.P.	AV.
1	0.15715	10.09	40.92	27.82	51.01	37.91	65.61	55.61	-14.60	-17.70
2	0.23325	10.12	35.09	24.07	45.21	34.19	62.33	52.33	-17.12	-18.14
3	0.31222	10.13	28.21	14.70	38.34	24.83	59.91	49.91	-21.57	-25.08
4	0.47134	10.13	29.14	17.27	39.27	27.40	56.49	46.49	-17.22	-19.09
5	0.62853	10.14	29.40	16.48	39.54	26.62	56.00	46.00	-16.46	-19.38
6	0.71157	10.15	26.20	13.07	36.35	23.22	56.00	46.00	-19.65	-22.78

Remarks:

1. Q.P. and AV. are abbreviations of quasi-peak and average individually.
2. The emission levels of other frequencies were very low against the limit.
3. Margin value = Emission level – Limit value
4. Correction factor = Insertion loss + Cable loss
5. Emission Level = Correction Factor + Reading Value

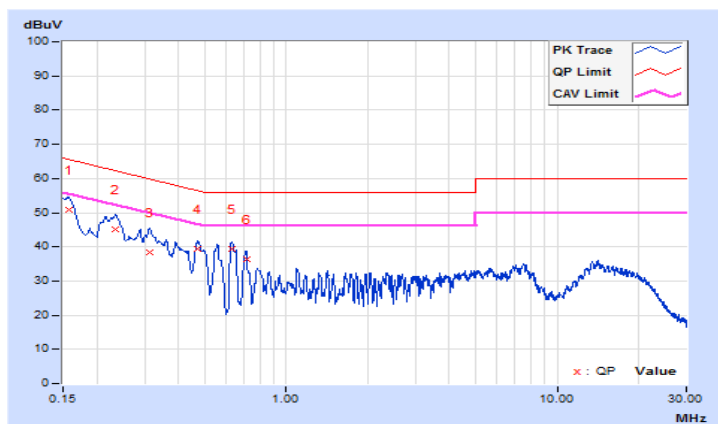

Frequency Range	150kHz ~ 30MHz	Detector Function & Resolution Bandwidth	Quasi-Peak (QP) / Average (AV), 9kHz
Input Power	120Vac, 60Hz	Environmental Conditions	23°C, 62%RH
Tested by	Mick Chou	Test Date	2019/1/19
Test Mode	Mode 6		

Phase Of Power : Neutral (N)										
No	Frequency (MHz)	Correction Factor (dB)	Reading Value (dBuV)		Emission Level (dBuV)		Limit (dBuV)		Margin (dB)	
			Q.P.	AV.	Q.P.	AV.	Q.P.	AV.	Q.P.	AV.
1	0.15900	10.14	40.94	27.16	51.08	37.30	65.52	55.52	-14.44	-18.22
2	0.23600	10.11	35.94	22.70	46.05	32.81	62.24	52.24	-16.19	-19.43
3	0.28725	10.11	31.69	16.68	41.80	26.79	60.60	50.60	-18.80	-23.81
4	0.32550	10.10	25.06	11.72	35.16	21.82	59.57	49.57	-24.41	-27.75
5	0.57075	10.12	29.90	19.66	40.02	29.78	56.00	46.00	-15.98	-16.22
6	0.63186	10.12	27.55	15.58	37.67	25.70	56.00	46.00	-18.33	-20.30

Remarks:

1. Q.P. and AV. are abbreviations of quasi-peak and average individually.
2. The emission levels of other frequencies were very low against the limit.
3. Margin value = Emission level – Limit value
4. Correction factor = Insertion loss + Cable loss
5. Emission Level = Correction Factor + Reading Value

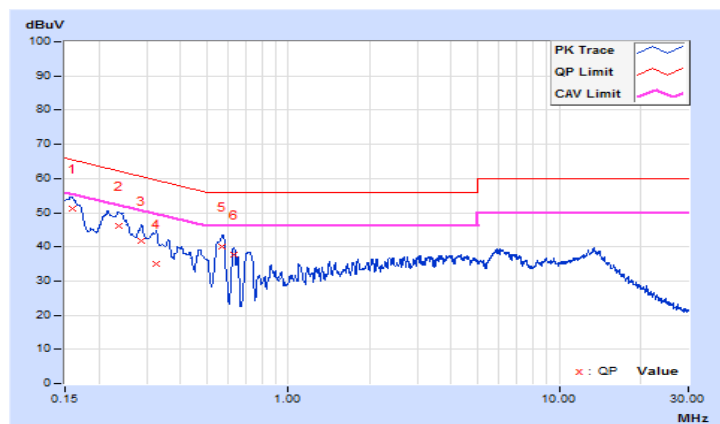

6 Radiated Emissions up to 1 GHz

6.1 Limits

Emissions radiated outside of the specified bands, shall be according to the general radiated limits as following:

Radiated Emissions Limits at 10 meters (dB μ V/m)				
Frequencies (MHz)	FCC 15B / ICES-003, Class A	FCC 15B / ICES-003, Class B	CISPR 22, Class A	CISPR 22, Class B
30-88	39	29.5	40	30
88-216	43.5	33.1		
216-230	46.4	35.6		
230-960			47	37
960-1000	49.5	43.5		

Radiated Emissions Limits at 3 meters (dB μ V/m)				
Frequencies (MHz)	FCC 15B / ICES-003, Class A	FCC 15B / ICES-003, Class B	CISPR 22, Class A	CISPR 22, Class B
30-88	49.5	40	50.5	40.5
88-216	54	43.5		
216-230	56.9	46		
230-960			57.5	47.5
960-1000	60	54		

Notes:

1. The lower limit shall apply at the transition frequencies.
2. Emission level (dB μ V/m) = 20 log Emission level (μ V/m).
3. QP detector shall be applied if not specified.

6.2 Test Instruments

Description & Manufacturer	Model No.	Serial No.	Cal. Date	Cal. Due
Test Receiver ROHDE & SCHWARZ (V)	ESR	101240	Oct. 30, 2018	Oct. 29, 2019
Test Receiver ROHDE & SCHWARZ (H)	ESR7	101471	Mar. 01, 2018	Feb. 28, 2019
BILOG Antenna SCHWARZBECK (V)	VULB9168	9168-148	Nov. 20, 2018	Nov. 19, 2019
BILOG Antenna SCHWARZBECK (H)	VULB9168	9168-156	Nov. 20, 2018	Nov. 19, 2019
Preamplifier Sonoma (V)	310N	352924	Jul. 12, 2018	Jul. 11, 2019
Preamplifier Sonoma (H)	310N	352923	Jul. 12, 2018	Jul. 11, 2019
RF signal cable (with 5dB PAD) Times (V)	LMR-600 (18M) +LMR-400 (7M)	CABLE-CH1 (VER) -01	Oct. 03, 2018	Oct. 02, 2019
RF signal cable (with 5dB PAD) Times (H)	LMR-600 (11.8M) +LMR-400 (7M)	CABLE-CH1 (HOR) -01	Oct. 03, 2018	Oct. 02, 2019
Software BV ADT	BV ADT_Radiated_ V8.7.08	NA	NA	NA
Antenna Tower (V)	MFA-440	9707	NA	NA
Antenna Tower (H)	MFA-440	970705	NA	NA
Turn Table	DS430	50303	NA	NA
Controller (V)	MF7802	074	NA	NA
Controller (H)	MF7802	08093	NA	NA

NOTE: 1. The calibration interval of the above test instruments is 12 months and the calibrations are traceable to NML/ROC and NIST/USA.

2. The test was performed in HwaYa Chamber 1.
3. The IC Site Registration No. is IC 7450F-1.
4. The VCCI Site Registration No. is R-1893.

6.3 Test Arrangement

- The EUT was placed on the top of a rotating table 0.8 meters above the ground at an accredited test facility. The table was rotated 360 degrees to determine the position of the highest radiation.
- The EUT was set 10 meters away from the interference-receiving antenna, which was mounted on the top of a variable-height antenna tower.
- The antenna is a broadband antenna, and its height is varied from one meter to four meters above the ground to determine the maximum value of the field strength. Both horizontal and vertical polarizations of the antenna are set to make the measurement.
- For each suspected emission, the EUT was arranged to its worst case and then the antenna was tuned to heights from 1 meter to 4 meters and the rotatable table was turned from 0 degrees to 360 degrees to find the maximum reading.
- The test-receiver system was set to quasi-peak detect function and specified bandwidth with maximum hold mode when the test frequency is below 1 GHz.

Note: The resolution bandwidth and video bandwidth of test receiver/spectrum analyzer is 120 kHz for quasi-peak detection (QP) at frequency below 1 GHz.

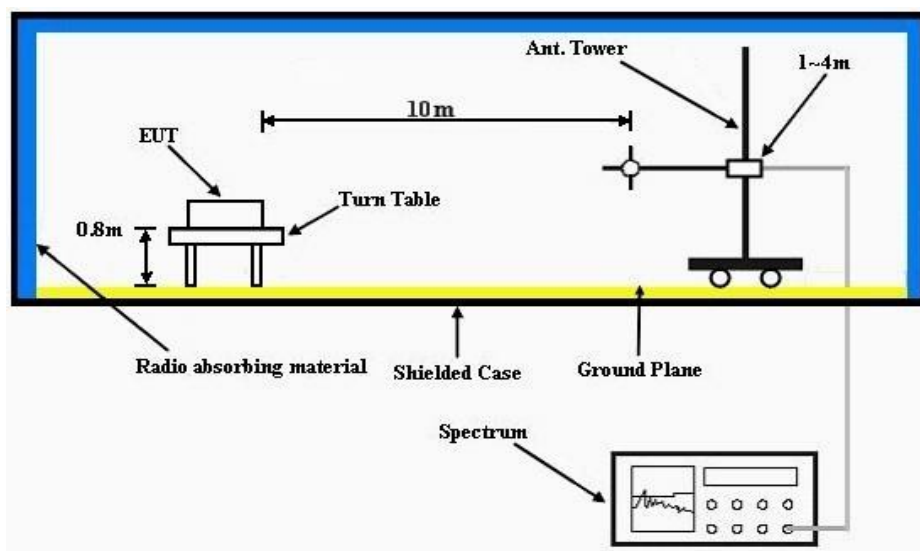

6.4 Test Results

Frequency Range	30MHz ~ 1GHz	Detector Function & Resolution Bandwidth	Quasi-Peak (QP), 120kHz
Test Mode	Mode 1	Environmental Conditions	20°C, 60%RH
Tested by	Pon Tsai	Test Date	2018/11/22

Antenna Polarity & Test Distance : Horizontal at 10 m								
No	Frequency (MHz)	Emission Level (dBuV/m)	Limit (dBuV/m)	Margin (dB)	Antenna Height (m)	Table Angle (Degree)	Raw Value (dBuV)	Correction Factor (dB/m)
1	40.67	18.36 QP	30.00	-11.64	2.50 H	251	32.26	-13.90
2	64.92	16.19 QP	30.00	-13.81	4.00 H	51	30.37	-14.18
3	102.17	16.19 QP	30.00	-13.81	4.00 H	332	32.94	-16.75
4	157.61	21.21 QP	30.00	-8.79	4.00 H	116	33.88	-12.67
5	177.84	18.24 QP	30.00	-11.76	4.00 H	148	31.75	-13.51
6	729.99	27.48 QP	37.00	-9.52	1.50 H	80	29.70	-2.22

Remarks:

1. Emission Level(dBuV/m) = Raw Value(dBuV) + Correction Factor(dB/m)
2. Correction Factor(dB/m) = Antenna Factor (dB/m) + Cable Factor (dB) – Pre-Amplifier Factor (dB)
3. The other emission levels were very low against the limit.
4. Margin value = Emission level – Limit value

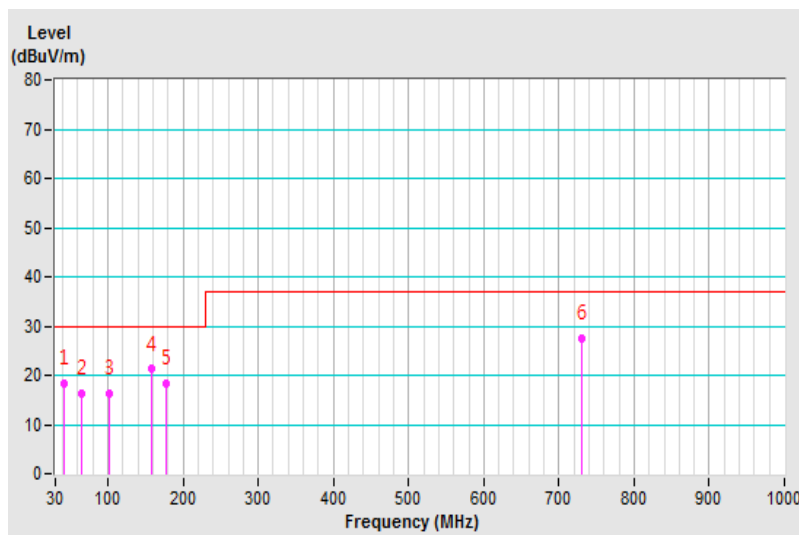

Frequency Range	30MHz ~ 1GHz	Detector Function & Resolution Bandwidth	Quasi-Peak (QP), 120kHz
Test Mode	Mode 1	Environmental Conditions	20°C, 60%RH
Tested by	Pon Tsai	Test Date	2018/11/22

Antenna Polarity & Test Distance : Vertical at 10 m								
No	Frequency (MHz)	Emission Level (dBuV/m)	Limit (dBuV/m)	Margin (dB)	Antenna Height (m)	Table Angle (Degree)	Raw Value (dBuV)	Correction Factor (dB/m)
1	40.67	21.25 QP	30.00	-8.75	3.50 V	7	35.91	-14.66
2	67.78	24.81 QP	30.00	-5.19	3.50 V	43	40.24	-15.43
3	154.65	21.21 QP	30.00	-8.79	1.50 V	272	34.62	-13.41
4	184.24	23.47 QP	30.00	-6.53	1.50 V	226	38.48	-15.01
5	207.91	22.83 QP	30.00	-7.17	1.00 V	28	38.68	-15.85
6	730.38	32.71 QP	37.00	-4.29	1.50 V	49	35.22	-2.51

Remarks:

1. Emission Level(dBuV/m) = Raw Value(dBuV) + Correction Factor(dB/m)
2. Correction Factor(dB/m) = Antenna Factor (dB/m) + Cable Factor (dB) – Pre-Amplifier Factor (dB)
3. The other emission levels were very low against the limit.
4. Margin value = Emission level – Limit value

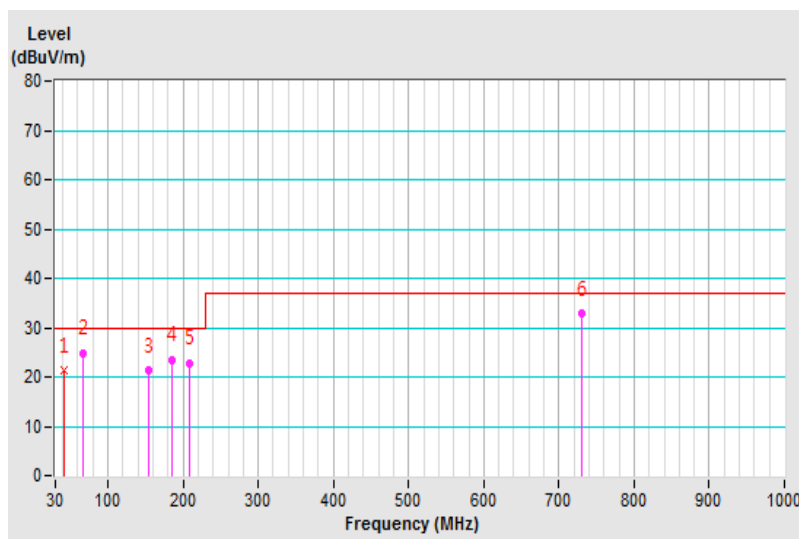

Frequency Range	30MHz ~ 1GHz	Detector Function & Resolution Bandwidth	Quasi-Peak (QP), 120kHz
Test Mode	Mode 3	Environmental Conditions	23°C, 63%RH
Tested by	Ben Huang	Test Date	2019/1/21

Antenna Polarity & Test Distance : Horizontal at 10 m								
No	Frequency (MHz)	Emission Level (dBuV/m)	Limit (dBuV/m)	Margin (dB)	Antenna Height (m)	Table Angle (Degree)	Raw Value (dBuV)	Correction Factor (dB/m)
1	30.78	15.62 QP	30.00	-14.38	3.50 H	347	30.75	-15.13
2	63.52	15.43 QP	30.00	-14.57	2.50 H	17	30.08	-14.65
3	82.04	15.24 QP	30.00	-14.76	3.50 H	308	32.98	-17.74
4	133.36	17.98 QP	30.00	-12.02	3.50 H	14	32.72	-14.74
5	167.36	24.38 QP	30.00	-5.62	3.00 H	163	37.48	-13.10
6	215.96	22.49 QP	30.00	-7.51	3.50 H	269	37.80	-15.31

Remarks:

1. Emission Level(dBuV/m) = Raw Value(dBuV) + Correction Factor(dB/m)
2. Correction Factor(dB/m) = Antenna Factor (dB/m) + Cable Factor (dB) – Pre-Amplifier Factor (dB)
3. The other emission levels were very low against the limit.
4. Margin value = Emission level – Limit value

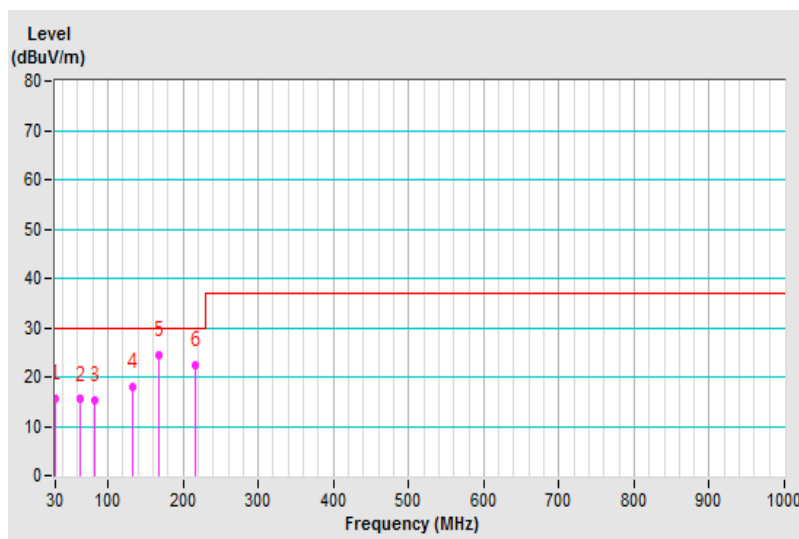

Frequency Range	30MHz ~ 1GHz	Detector Function & Resolution Bandwidth	Quasi-Peak (QP), 120kHz
Test Mode	Mode 3	Environmental Conditions	23°C, 63%RH
Tested by	Ben Huang	Test Date	2019/1/21

Antenna Polarity & Test Distance : Vertical at 10 m								
No	Frequency (MHz)	Emission Level (dBuV/m)	Limit (dBuV/m)	Margin (dB)	Antenna Height (m)	Table Angle (Degree)	Raw Value (dBuV)	Correction Factor (dB/m)
1	30.09	24.25 QP	30.00	-5.75	1.00 V	320	39.56	-15.31
2	43.77	22.07 QP	30.00	-7.93	1.00 V	233	36.50	-14.43
3	90.53	20.98 QP	30.00	-9.02	1.50 V	1	39.33	-18.35
4	134.13	17.49 QP	30.00	-12.51	1.00 V	308	32.49	-15.00
5	167.41	22.57 QP	30.00	-7.43	2.50 V	241	35.97	-13.40
6	215.96	18.74 QP	30.00	-11.26	2.00 V	108	34.64	-15.90

Remarks:

1. Emission Level(dBuV/m) = Raw Value(dBuV) + Correction Factor(dB/m)
2. Correction Factor(dB/m) = Antenna Factor (dB/m) + Cable Factor (dB) – Pre-Amplifier Factor (dB)
3. The other emission levels were very low against the limit.
4. Margin value = Emission level – Limit value

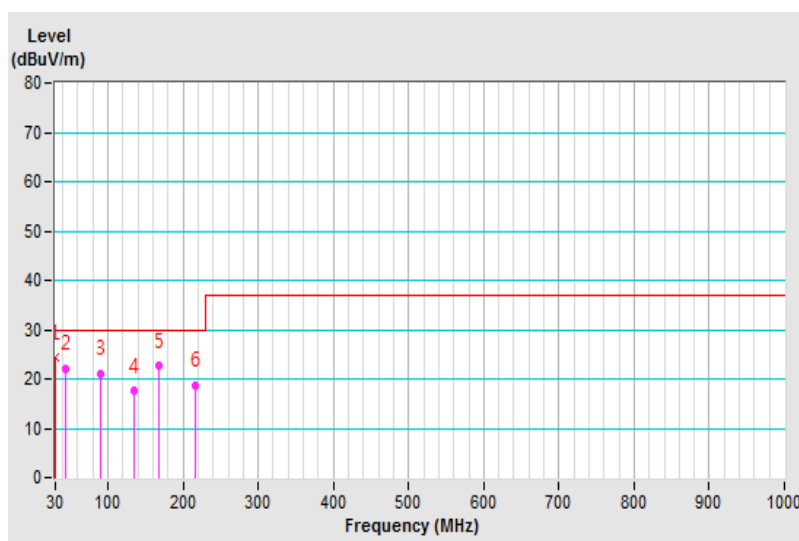

Frequency Range	30MHz ~ 1GHz	Detector Function & Resolution Bandwidth	Quasi-Peak (QP), 120kHz
Test Mode	Mode 6	Environmental Conditions	23°C, 65%RH
Tested by	Jim Lee	Test Date	2019/1/18

Antenna Polarity & Test Distance : Horizontal at 10 m								
No	Frequency (MHz)	Emission Level (dBuV/m)	Limit (dBuV/m)	Margin (dB)	Antenna Height (m)	Table Angle (Degree)	Raw Value (dBuV)	Correction Factor (dB/m)
1	67.77	16.85 QP	30.00	-13.15	4.00 H	197	31.95	-15.10
2	166.57	18.81 QP	30.00	-11.19	2.50 H	158	31.94	-13.13
3	486.60	21.54 QP	37.00	-15.46	1.00 H	144	28.08	-6.54
4	576.53	23.58 QP	37.00	-13.42	3.00 H	16	28.89	-5.31
5	634.78	24.96 QP	37.00	-12.04	3.00 H	82	28.45	-3.49
6	793.19	26.67 QP	37.00	-10.33	4.00 H	166	27.54	-0.87

Remarks:

1. Emission Level(dBuV/m) = Raw Value(dBuV) + Correction Factor(dB/m)
2. Correction Factor(dB/m) = Antenna Factor (dB/m) + Cable Factor (dB) – Pre-Amplifier Factor (dB)
3. The other emission levels were very low against the limit.
4. Margin value = Emission level – Limit value

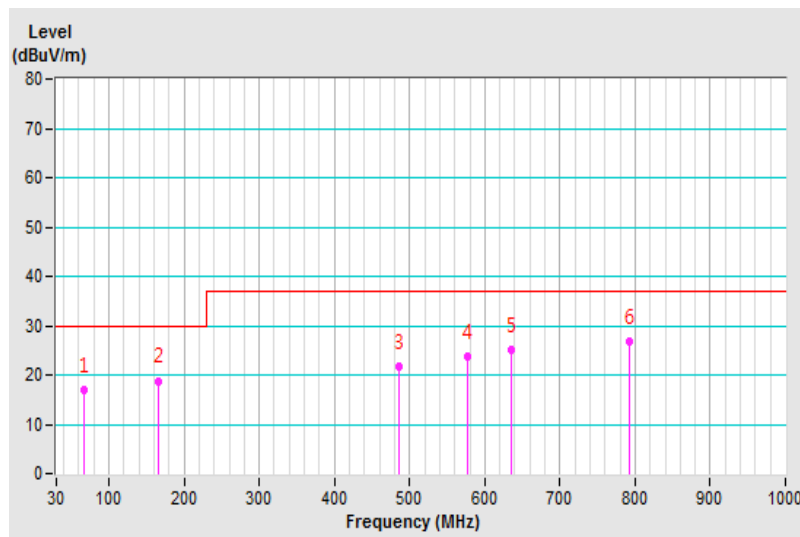

Frequency Range	30MHz ~ 1GHz	Detector Function & Resolution Bandwidth	Quasi-Peak (QP), 120kHz
Test Mode	Mode 6	Environmental Conditions	23°C, 65%RH
Tested by	Jim Lee	Test Date	2019/1/18

Antenna Polarity & Test Distance : Vertical at 10 m								
No	Frequency (MHz)	Emission Level (dBuV/m)	Limit (dBuV/m)	Margin (dB)	Antenna Height (m)	Table Angle (Degree)	Raw Value (dBuV)	Correction Factor (dB/m)
1	40.68	24.39 QP	30.00	-5.61	1.00 V	295	39.04	-14.65
2	67.79	22.04 QP	30.00	-7.96	3.00 V	197	37.47	-15.43
3	183.65	18.19 QP	30.00	-11.81	1.00 V	325	33.11	-14.92
4	405.94	21.01 QP	37.00	-15.99	1.00 V	334	30.06	-9.05
5	499.12	22.00 QP	37.00	-15.00	1.00 V	148	29.03	-7.03
6	627.06	24.83 QP	37.00	-12.17	4.00 V	312	29.14	-4.31

Remarks:

1. Emission Level(dBuV/m) = Raw Value(dBuV) + Correction Factor(dB/m)
2. Correction Factor(dB/m) = Antenna Factor (dB/m) + Cable Factor (dB) – Pre-Amplifier Factor (dB)
3. The other emission levels were very low against the limit.
4. Margin value = Emission level – Limit value

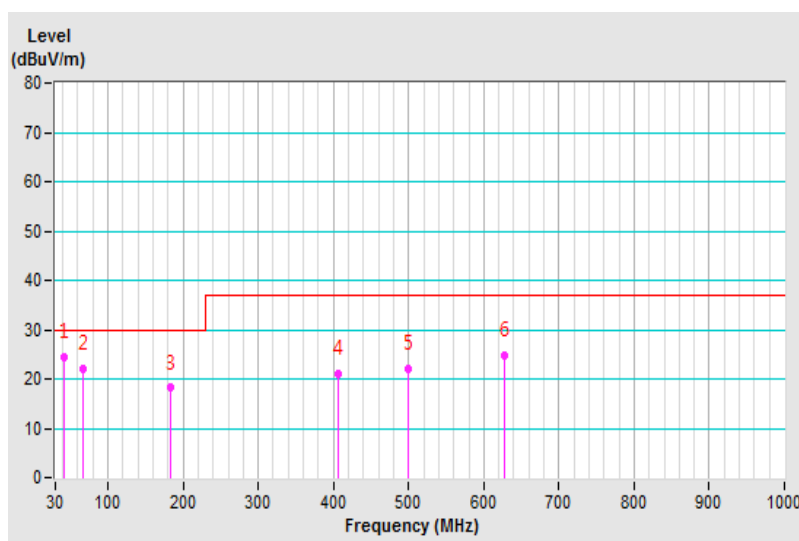

7 Radiated Emissions above 1 GHz

7.1 Limits

Emissions radiated outside of the specified bands, shall be according to the general radiated limits as following:

Radiated Emissions Limits at 10 meters (dB μ V/m)				
Frequencies (MHz)	FCC 15B / ICES-003, Class A	FCC 15B / ICES-003, Class B	CISPR 22, Class A	CISPR 22, Class B
1000-3000	Avg: 49.5	Avg: 43.5	Not defined	Not defined
Above 3000	Peak: 69.5	Peak: 63.5	Not defined	Not defined

Radiated Emissions Limits at 3 meters (dB μ V/m)				
Frequencies (MHz)	FCC 15B / ICES-003, Class A	FCC 15B / ICES-003, Class B	CISPR 22, Class A	CISPR 22, Class B
1000-3000	Avg: 60	Avg: 54	Avg: 56 Peak: 76	Avg: 50 Peak: 70
Above 3000	Peak: 80	Peak: 74	Avg: 60 Peak: 80	Avg: 54 Peak: 74

Notes:

1. The lower limit shall apply at the transition frequencies.
2. Emission level (dB μ V/m) = 20 log Emission level (uV/m).
3. As shown in 15.35(b), for frequencies above 1000 MHz, the field strength limits are based on average detector, however, the peak field strength of any emission shall not exceed the maximum permitted average limits, specified above by more than 20 dB under any condition of modulation.

Radiated Emissions Limits at 1.5 meters (dB μ V/m)		
Frequencies (MHz)	FCC 15B / ICES-003, Class A	FCC 15B / ICES-003, Class B
Above 18000	Avg: 66 Peak: 86	Avg: 60 Peak: 80

Note: Limit@1.5m = Limit@3m + 20log(3/1.5)

Frequency Range (For unintentional radiators)

Highest frequency generated or used in the device or on which the device operates or tunes (MHz)	Upper frequency of measurement range (MHz)
Below 1.705	30
1.705-108	1000
108-500	2000
500-1000	5000
Above 1000	5 th harmonic of the highest frequency or 40 GHz, whichever is lower

7.2 Test Instruments

Description & Manufacturer	Model No.	Serial No.	Cal. Date	Cal. Due
Test Receiver ROHDE & SCHWARZ (Above 1GHz)	ESR7	101471	Mar. 01, 2018	Feb. 28, 2019
Spectrum Analyzer Agilent	E4446A	MY51100039	Sep. 10, 2018	Sep. 09, 2019
RF signal cable (with 5dB PAD) Times	LMR-400 (18M)	CABLE-CH2-01	Apr. 27, 2018	Apr. 26, 2019
HORN Antenna (with 4dB PAD) SCHWARZBECK	BBHA 9120 D	9120D-405	Dec. 01, 2017 Nov. 25, 2018	Nov. 30, 2018 Nov. 24, 2019
Pre-Amplifier Agilent (Above 1GHz)	8449B	3008A01961	Oct. 15, 2018	Oct. 14, 2019
RF Coaxial Cable JUNFLON+EMC	JUNFLON+EMC10 4-SM-SM-6000	Cable-CH2-02(MWX3221308 G003+130710)	Jun. 11, 2018	Jun. 10, 2019
Software BV ADT	BV ADT_Radiated_ V8.7.08	NA	NA	NA
Antenna Tower BV ADT	AT100	AT93021702	NA	NA
Turn Table BV ADT	TT100	TT93021702	NA	NA
Controller BV ADT	SC100	SC93021702	NA	NA
RF Coaxial Cable EMCI	EMC102-KM-KM-1 000	170820	Aug. 28, 2018	Aug. 27, 2019
RF Coaxial Cable EMCI	EMC102-KM-KM-3 000	150929	Aug. 28, 2018	Aug. 27, 2019
Fix tool for Boresight antenna	BAF-01	2	NA	NA
Pre-amplifier (18GHz-40GHz) EMC	EMC184045B	980175	Nov. 14, 2017 Nov. 14, 2018	Nov. 13, 2018 Nov. 13, 2019
HORN Antenna (with 3dB PAD) SCHWARZBECK	BBHA 9170	148	Dec. 13, 2017 Nov. 25, 2018	Dec. 12, 2018 Nov. 24, 2019

- Note: 1. The calibration interval of the above test instruments is 12 months and the calibrations are traceable to NML/ROC and NIST/USA.
2. The test was performed in HwaYa Chamber 2.
3. The horn antenna and preamplifier (model: 8449B) are used only for the measurement of emission frequency above 1GHz if tested.
4. The IC Site Registration No. is IC 7450F-2.
5. The VCCI Site Registration No. is G-10018.

7.3 Test Arrangement

- The EUT was placed on the top of a rotating table 0.8 meters above the ground at an accredited chamber room. The table was rotated 360 degrees to determine the position of the highest radiation.
- The EUT was set 3 meters away from the interference-receiving antenna, which was mounted on the top of a variable-height antenna tower.
- For frequency range 1 GHz ~ 18 GHz, the EUT was set 3 meters away from the interference-receiving antenna, which was mounted on the top of a variable-height antenna tower.
- For frequency range 18 GHz ~ 40 GHz, the EUT was set 1.5 meters away from the interference-receiving antenna, which was mounted on the top of a variable-height antenna tower.
- The height of antenna can be varied from one meter to four meters, the height of adjustment depends on the EUT height and the antenna 3 dB beamwidth both, to detect the maximum value of the field strength. Both horizontal and vertical polarizations of the antenna are set to make the measurement.
- For each suspected emission, the EUT was arranged to its worst case and then the antenna was tuned to heights and the rotatable table was turned from 0 degrees to 360 degrees to find the maximum reading.
- The spectrum analyzer system was set to peak and average detect function and specified bandwidth with maximum hold mode when the test frequency is above 1 GHz.

Note: The resolution bandwidth of test receiver/spectrum analyzer is 1 MHz and video bandwidth is 3 MHz for Peak detection (PK) at frequency above 1 GHz. The resolution bandwidth of test receiver/spectrum analyzer is 1 MHz for Average detection (AV) at frequency above 1 GHz.

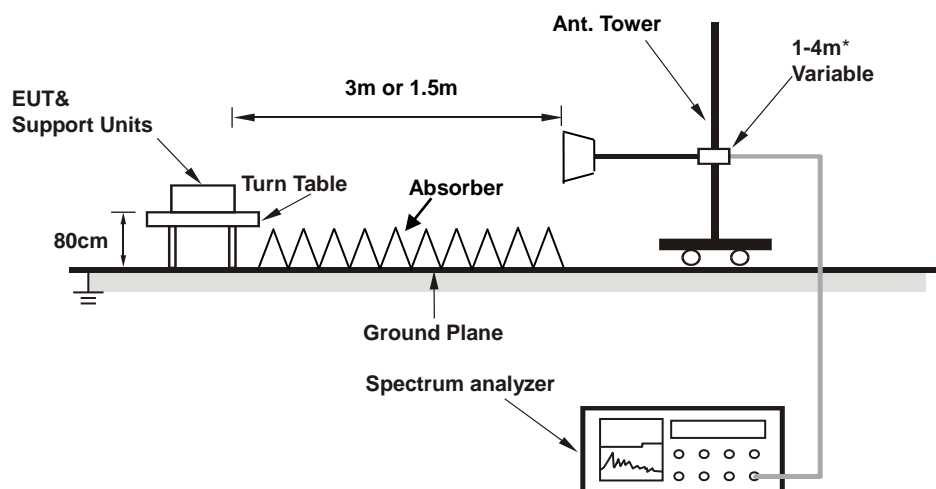

7.4 Test Results

Frequency Range	1GHz ~ 18GHz	Detector Function & Resolution Bandwidth	Peak (PK) / Average (AV), 1MHz
Test Mode	Mode 1	Environmental Conditions	23°C, 63%RH
Tested by	Fox Chang	Test Date	2018/11/7

Antenna Polarity & Test Distance : Horizontal at 3 m								
No	Frequency (MHz)	Emission Level (dBuV/m)	Limit (dBuV/m)	Margin (dB)	Antenna Height (m)	Table Angle (Degree)	Raw Value (dBuV)	Correction Factor (dB/m)
1	1440.82	42.35 PK	74.00	-31.65	1.50 H	225	43.99	-1.64
2	1440.82	28.68 AV	54.00	-25.32	1.50 H	225	30.32	-1.64
3	2633.62	48.34 PK	74.00	-25.66	1.48 H	335	45.51	2.83
4	2633.62	33.57 AV	54.00	-20.43	1.48 H	335	30.74	2.83
5	3013.52	45.46 PK	74.00	-28.54	1.00 H	71	41.39	4.07
6	3013.52	33.71 AV	54.00	-20.29	1.00 H	71	29.64	4.07

Remarks:

1. Emission Level(dBuV/m) = Raw Value(dBuV) + Correction Factor(dB/m)
2. Correction Factor(dB/m) = Antenna Factor (dB/m) + Cable Factor (dB) – Pre-Amplifier Factor (dB)
3. The other emission levels were very low against the limit.
4. Margin value = Emission level – Limit value

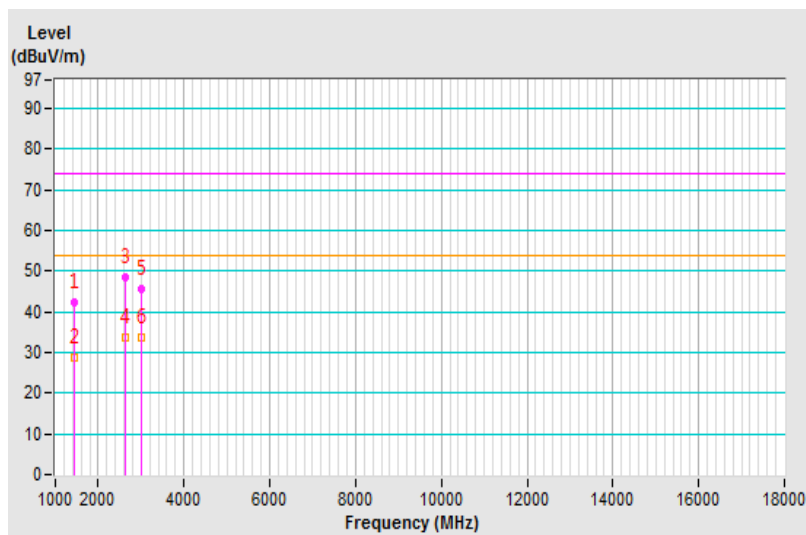

Frequency Range	1GHz ~ 18GHz	Detector Function & Resolution Bandwidth	Peak (PK) / Average (AV), 1MHz
Test Mode	Mode 1	Environmental Conditions	23°C, 63%RH
Tested by	Fox Chang	Test Date	2018/11/7

Antenna Polarity & Test Distance : Vertical at 3 m

No	Frequency (MHz)	Emission Level (dBuV/m)	Limit (dBuV/m)	Margin (dB)	Antenna Height (m)	Table Angle (Degree)	Raw Value (dBuV)	Correction Factor (dB/m)
1	1753.29	42.39 PK	74.00	-31.61	1.14 V	206	43.45	-1.06
2	1753.29	27.40 AV	54.00	-26.60	1.14 V	206	28.46	-1.06
3	3234.29	45.75 PK	74.00	-28.25	1.25 V	83	41.72	4.03
4	3234.29	31.33 AV	54.00	-22.67	1.25 V	83	27.30	4.03
5	4062.21	45.49 PK	74.00	-28.51	1.33 V	326	38.92	6.57
6	4062.21	34.62 AV	54.00	-19.38	1.33 V	326	28.05	6.57

Remarks:

1. Emission Level(dBuV/m) = Raw Value(dBuV) + Correction Factor(dB/m)
2. Correction Factor(dB/m) = Antenna Factor (dB/m) + Cable Factor (dB) – Pre-Amplifier Factor (dB)
3. The other emission levels were very low against the limit.
4. Margin value = Emission level – Limit value

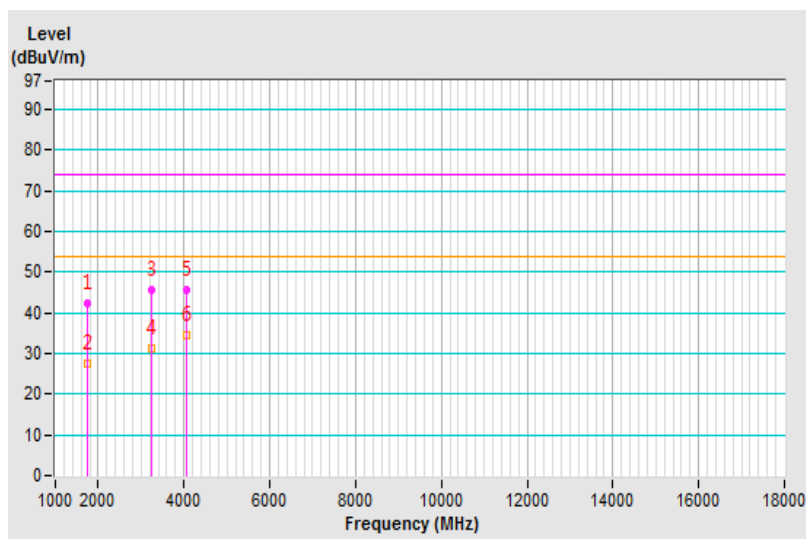

Frequency Range	18GHz ~ 40GHz	Detector Function & Resolution Bandwidth	Peak (PK) / Average (AV), 1MHz
Test Mode	Mode 1	Environmental Conditions	23°C, 63%RH
Tested by	Fox Chang	Test Date	2018/11/7

Antenna Polarity & Test Distance : Horizontal at 1.5 m								
No	Frequency (MHz)	Emission Level (dBuV/m)	Limit (dBuV/m)	Margin (dB)	Antenna Height (m)	Table Angle (Degree)	Raw Value (dBuV)	Correction Factor (dB/m)
1	24103.71	53.96 PK	80.00	-26.04	1.00 H	96	51.48	2.48
2	24103.71	33.58 AV	60.00	-26.42	1.00 H	96	31.10	2.48

Remarks:

1. Emission Level(dBuV/m) = Raw Value(dBuV) + Correction Factor(dB/m)
2. Correction Factor(dB/m) = Antenna Factor (dB/m) + Cable Factor (dB) – Pre-Amplifier Factor (dB)
3. The other emission levels were very low against the limit.
4. Margin value = Emission level – Limit value

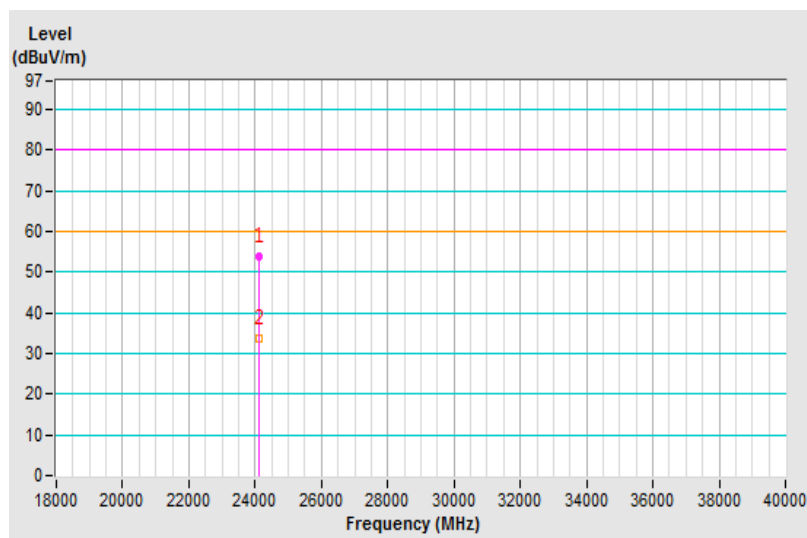

Frequency Range	18GHz ~ 40GHz	Detector Function & Resolution Bandwidth	Peak (PK) / Average (AV), 1MHz
Test Mode	Mode 1	Environmental Conditions	23°C, 63%RH
Tested by	Fox Chang	Test Date	2018/11/7

Antenna Polarity & Test Distance : Vertical at 1.5 m								
No	Frequency (MHz)	Emission Level (dBuV/m)	Limit (dBuV/m)	Margin (dB)	Antenna Height (m)	Table Angle (Degree)	Raw Value (dBuV)	Correction Factor (dB/m)
1	24165.92	55.15 PK	80.00	-24.85	1.00 V	201	52.50	2.65
2	24165.92	34.62 AV	60.00	-25.38	1.00 V	201	31.97	2.65

Remarks:

1. Emission Level(dBuV/m) = Raw Value(dBuV) + Correction Factor(dB/m)
2. Correction Factor(dB/m) = Antenna Factor (dB/m) + Cable Factor (dB) – Pre-Amplifier Factor (dB)
3. The other emission levels were very low against the limit.
4. Margin value = Emission level – Limit value

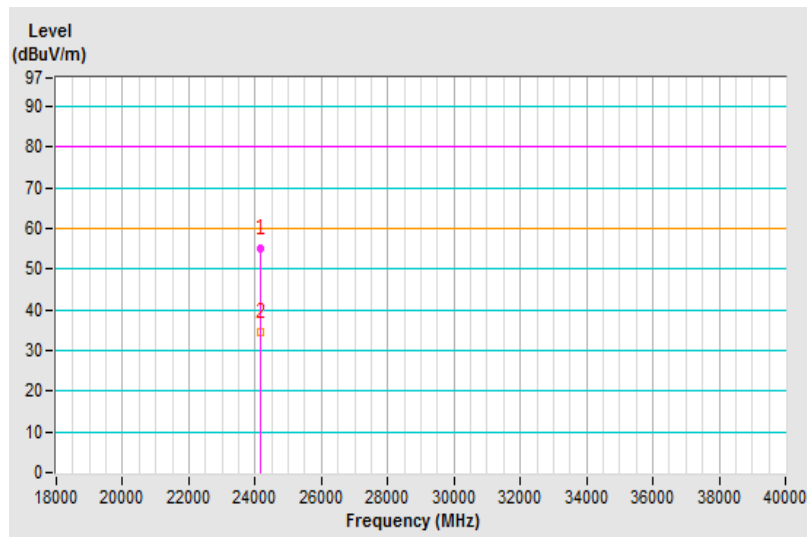

Frequency Range	1GHz ~ 18GHz	Detector Function & Resolution Bandwidth	Peak (PK) / Average (AV), 1MHz
Test Mode	Mode 3	Environmental Conditions	22°C, 63%RH
Tested by	Rolan Zheng	Test Date	2019/1/22

Antenna Polarity & Test Distance : Horizontal at 3 m								
No	Frequency (MHz)	Emission Level (dBuV/m)	Limit (dBuV/m)	Margin (dB)	Antenna Height (m)	Table Angle (Degree)	Raw Value (dBuV)	Correction Factor (dB/m)
1	1314.49	42.71 PK	74.00	-31.29	1.38 H	360	44.14	-1.43
2	1314.49	25.89 AV	54.00	-28.11	1.38 H	360	27.32	-1.43
3	2221.36	44.81 PK	74.00	-29.19	1.00 H	83	41.94	2.87
4	2221.36	28.42 AV	54.00	-25.58	1.00 H	83	25.55	2.87
5	3643.05	47.13 PK	74.00	-26.87	1.18 H	99	41.44	5.69
6	3643.05	34.52 AV	54.00	-19.48	1.18 H	99	28.83	5.69

Remarks:

1. Emission Level(dBuV/m) = Raw Value(dBuV) + Correction Factor(dB/m)
2. Correction Factor(dB/m) = Antenna Factor (dB/m) + Cable Factor (dB) – Pre-Amplifier Factor (dB)
3. The other emission levels were very low against the limit.
4. Margin value = Emission level – Limit value

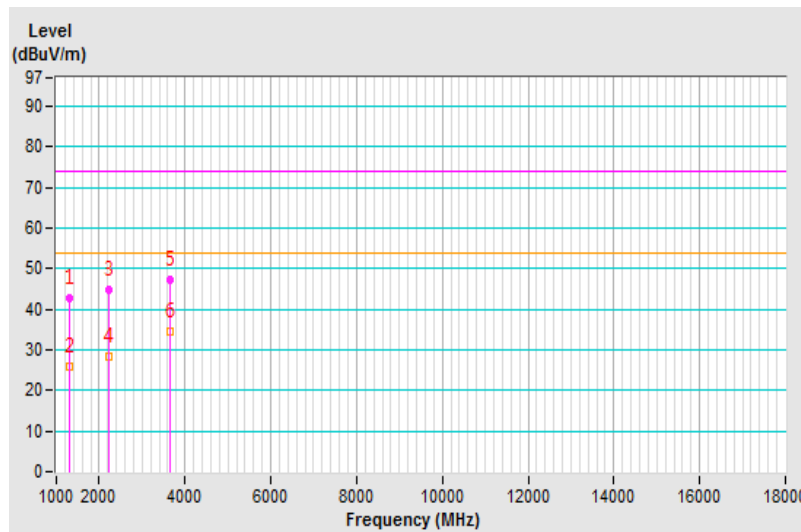

Frequency Range	1GHz ~ 18GHz	Detector Function & Resolution Bandwidth	Peak (PK) / Average (AV), 1MHz
Test Mode	Mode 3	Environmental Conditions	22°C, 63%RH
Tested by	Rolan Zheng	Test Date	2019/1/22

Antenna Polarity & Test Distance : Vertical at 3 m

No	Frequency (MHz)	Emission Level (dBuV/m)	Limit (dBuV/m)	Margin (dB)	Antenna Height (m)	Table Angle (Degree)	Raw Value (dBuV)	Correction Factor (dB/m)
1	1900.86	43.51 PK	74.00	-30.49	1.00 V	105	43.00	0.51
2	1900.86	26.53 AV	54.00	-27.47	1.00 V	105	26.02	0.51
3	2667.59	46.14 PK	74.00	-27.86	1.75 V	25	43.10	3.04
4	2667.59	28.11 AV	54.00	-25.89	1.75 V	25	25.07	3.04
5	3542.35	47.41 PK	74.00	-26.59	1.57 V	42	41.89	5.52
6	3542.35	35.29 AV	54.00	-18.71	1.57 V	42	29.77	5.52

Remarks:

1. Emission Level(dBuV/m) = Raw Value(dBuV) + Correction Factor(dB/m)
2. Correction Factor(dB/m) = Antenna Factor (dB/m) + Cable Factor (dB) – Pre-Amplifier Factor (dB)
3. The other emission levels were very low against the limit.
4. Margin value = Emission level – Limit value

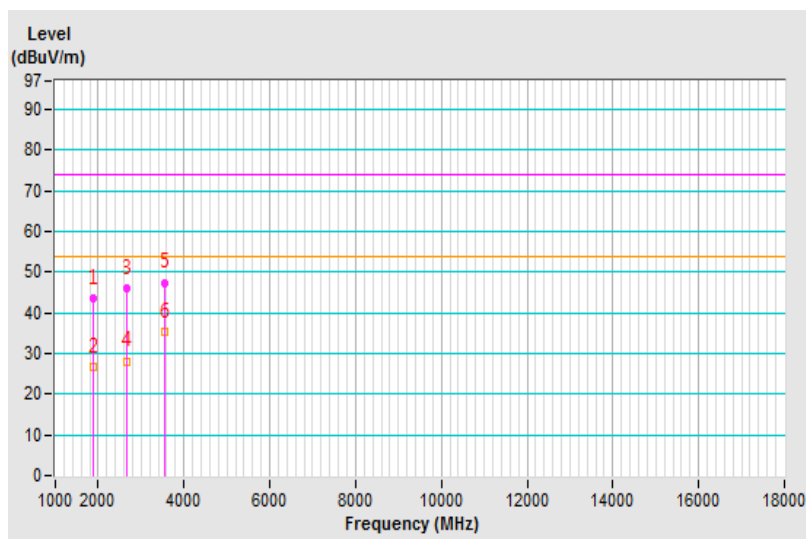

Frequency Range	18GHz ~ 40GHz	Detector Function & Resolution Bandwidth	Peak (PK) / Average (AV), 1MHz
Test Mode	Mode 3	Environmental Conditions	22°C, 63%RH
Tested by	Rolan Zheng	Test Date	2019/1/22

Antenna Polarity & Test Distance : Horizontal at 1.5 m								
No	Frequency (MHz)	Emission Level (dBuV/m)	Limit (dBuV/m)	Margin (dB)	Antenna Height (m)	Table Angle (Degree)	Raw Value (dBuV)	Correction Factor (dB/m)
1	18974.32	53.16 PK	80.00	-26.84	1.48 H	225	55.31	-2.15
2	18974.32	32.28 AV	60.00	-27.72	1.48 H	225	34.43	-2.15

Remarks:

1. Emission Level(dBuV/m) = Raw Value(dBuV) + Correction Factor(dB/m)
2. Correction Factor(dB/m) = Antenna Factor (dB/m) + Cable Factor (dB) – Pre-Amplifier Factor (dB)
3. The other emission levels were very low against the limit.
4. Margin value = Emission level – Limit value

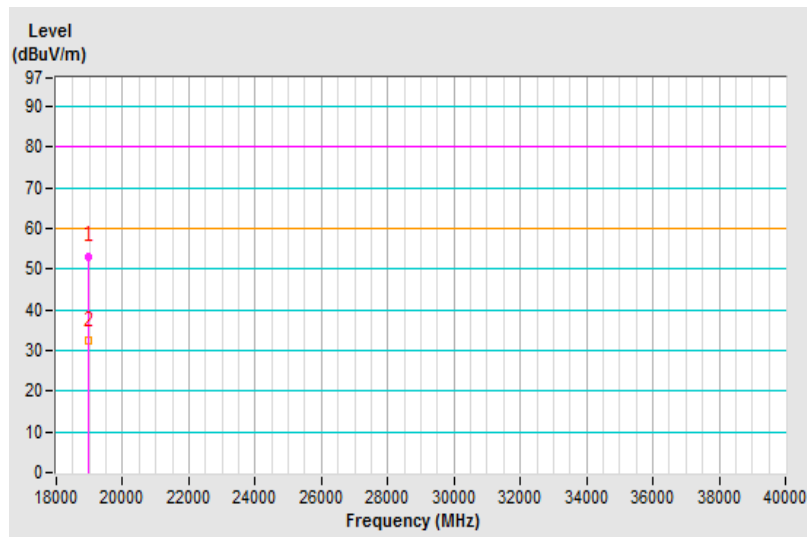

Frequency Range	18GHz ~ 40GHz	Detector Function & Resolution Bandwidth	Peak (PK) / Average (AV), 1MHz
Test Mode	Mode 3	Environmental Conditions	22°C, 63%RH
Tested by	Rolan Zheng	Test Date	2019/1/22

Antenna Polarity & Test Distance : Vertical at 1.5 m								
No	Frequency (MHz)	Emission Level (dBuV/m)	Limit (dBuV/m)	Margin (dB)	Antenna Height (m)	Table Angle (Degree)	Raw Value (dBuV)	Correction Factor (dB/m)
1	19653.55	52.56 PK	80.00	-27.44	1.23 V	285	54.23	-1.67
2	19653.55	30.28 AV	60.00	-29.72	1.23 V	285	31.95	-1.67

Remarks:

1. Emission Level(dBuV/m) = Raw Value(dBuV) + Correction Factor(dB/m)
2. Correction Factor(dB/m) = Antenna Factor (dB/m) + Cable Factor (dB) – Pre-Amplifier Factor (dB)
3. The other emission levels were very low against the limit.
4. Margin value = Emission level – Limit value

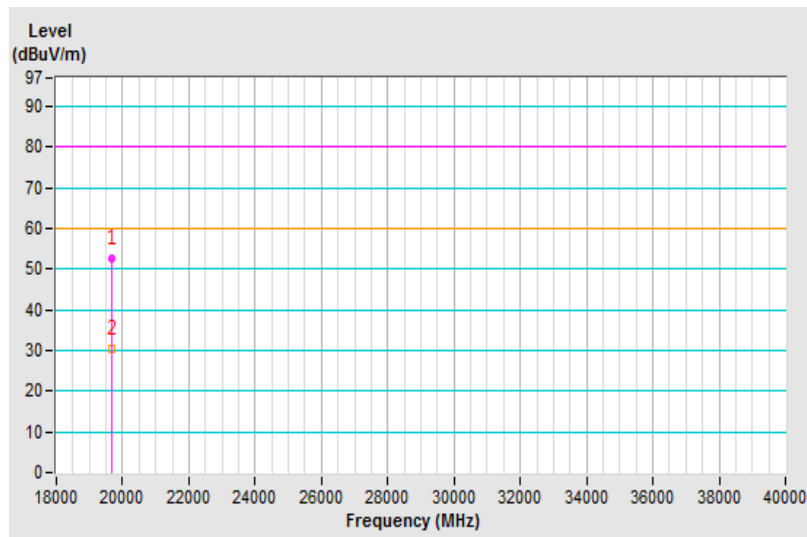

Frequency Range	1GHz ~ 18GHz	Detector Function & Resolution Bandwidth	Peak (PK) / Average (AV), 1MHz
Test Mode	Mode 6	Environmental Conditions	22°C, 63%RH
Tested by	Kai Chu	Test Date	2019/1/18

Antenna Polarity & Test Distance : Horizontal at 3 m								
No	Frequency (MHz)	Emission Level (dBuV/m)	Limit (dBuV/m)	Margin (dB)	Antenna Height (m)	Table Angle (Degree)	Raw Value (dBuV)	Correction Factor (dB/m)
1	1443.26	42.23 PK	74.00	-31.77	1.00 H	114	43.67	-1.44
2	1443.26	28.46 AV	54.00	-25.54	1.00 H	114	29.90	-1.44
3	2638.51	47.73 PK	74.00	-26.27	1.14 H	288	44.84	2.89
4	2638.51	33.16 AV	54.00	-20.84	1.14 H	288	30.27	2.89
5	3016.18	45.26 PK	74.00	-28.74	1.33 H	331	41.32	3.94
6	3016.18	32.93 AV	54.00	-21.07	1.33 H	331	28.99	3.94

Remarks:

1. Emission Level(dBuV/m) = Raw Value(dBuV) + Correction Factor(dB/m)
2. Correction Factor(dB/m) = Antenna Factor (dB/m) + Cable Factor (dB) – Pre-Amplifier Factor (dB)
3. The other emission levels were very low against the limit.
4. Margin value = Emission level – Limit value

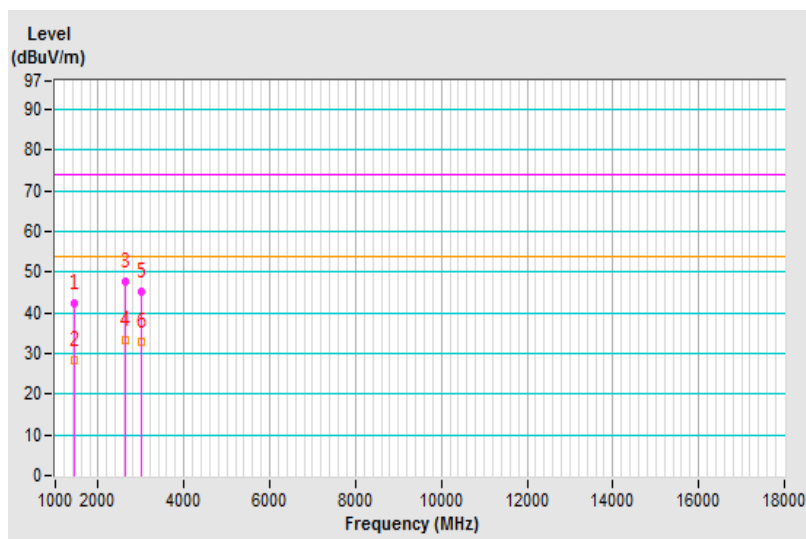

Frequency Range	1GHz ~ 18GHz	Detector Function & Resolution Bandwidth	Peak (PK) / Average (AV), 1MHz
Test Mode	Mode 6	Environmental Conditions	22°C, 63%RH
Tested by	Kai Chu	Test Date	2019/1/18

Antenna Polarity & Test Distance : Vertical at 3 m

No	Frequency (MHz)	Emission Level (dBuV/m)	Limit (dBuV/m)	Margin (dB)	Antenna Height (m)	Table Angle (Degree)	Raw Value (dBuV)	Correction Factor (dB/m)
1	1758.51	42.51 PK	74.00	-31.49	1.66 V	288	43.55	-1.04
2	1758.51	27.11 AV	54.00	-26.89	1.66 V	288	28.15	-1.04
3	3238.15	45.52 PK	74.00	-28.48	1.00 V	344	41.46	4.06
4	3238.15	31.23 AV	54.00	-22.77	1.00 V	344	27.17	4.06
5	4064.27	46.03 PK	74.00	-27.97	1.19 V	188	39.48	6.55
6	4064.27	34.54 AV	54.00	-19.46	1.19 V	188	27.99	6.55

Remarks:

1. Emission Level(dBuV/m) = Raw Value(dBuV) + Correction Factor(dB/m)
2. Correction Factor(dB/m) = Antenna Factor (dB/m) + Cable Factor (dB) – Pre-Amplifier Factor (dB)
3. The other emission levels were very low against the limit.
4. Margin value = Emission level – Limit value

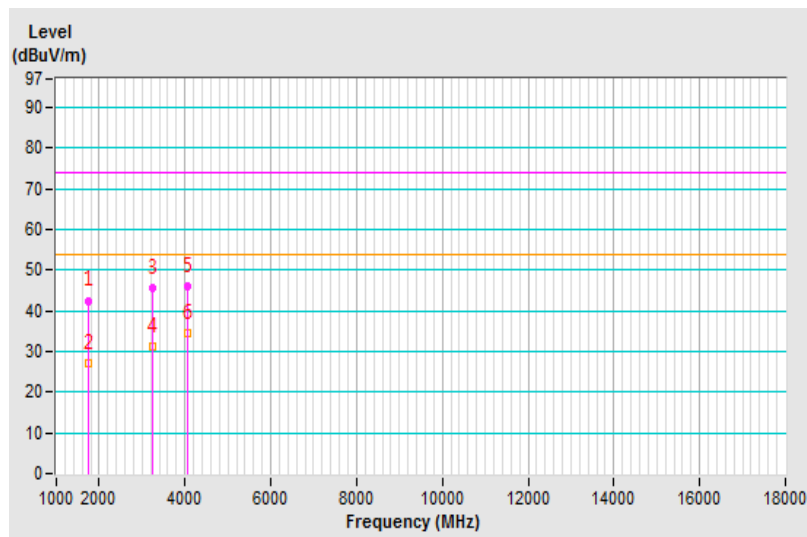

Frequency Range	18GHz ~ 40GHz	Detector Function & Resolution Bandwidth	Peak (PK) / Average (AV), 1MHz
Test Mode	Mode 6	Environmental Conditions	22°C, 63%RH
Tested by	Kai Chu	Test Date	2019/1/18

Antenna Polarity & Test Distance : Horizontal at 1.5 m								
No	Frequency (MHz)	Emission Level (dBuV/m)	Limit (dBuV/m)	Margin (dB)	Antenna Height (m)	Table Angle (Degree)	Raw Value (dBuV)	Correction Factor (dB/m)
1	19106.54	51.35 PK	80.00	-28.65	1.07 H	215	53.37	-2.02
2	19106.54	32.85 AV	60.00	-27.15	1.07 H	215	34.87	-2.02

Remarks:

1. Emission Level(dBuV/m) = Raw Value(dBuV) + Correction Factor(dB/m)
2. Correction Factor(dB/m) = Antenna Factor (dB/m) + Cable Factor (dB) – Pre-Amplifier Factor (dB)
3. The other emission levels were very low against the limit.
4. Margin value = Emission level – Limit value

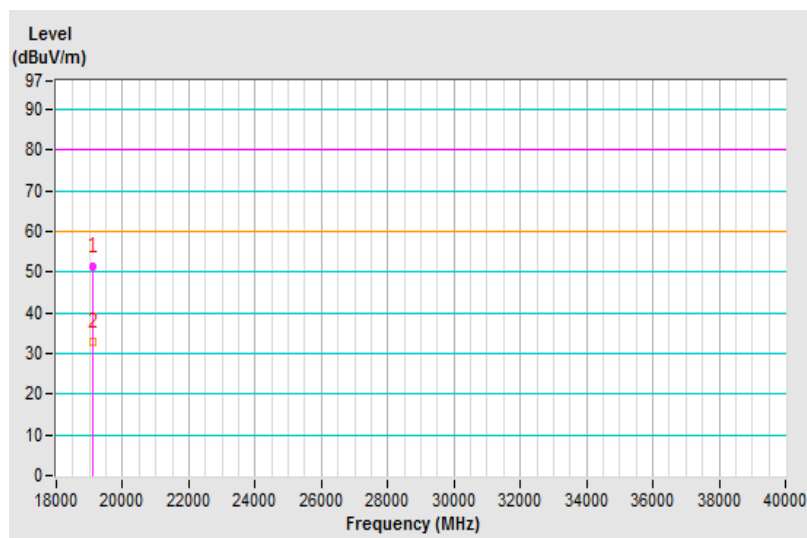

Frequency Range	18GHz ~ 40GHz	Detector Function & Resolution Bandwidth	Peak (PK) / Average (AV), 1MHz
Test Mode	Mode 6	Environmental Conditions	22°C, 63%RH
Tested by	Kai Chu	Test Date	2019/1/18

Antenna Polarity & Test Distance : Vertical at 1.5 m

No	Frequency (MHz)	Emission Level (dBuV/m)	Limit (dBuV/m)	Margin (dB)	Antenna Height (m)	Table Angle (Degree)	Raw Value (dBuV)	Correction Factor (dB/m)
1	18553.15	49.40 PK	80.00	-30.60	1.23 V	323	51.65	-2.25
2	18553.15	31.74 AV	60.00	-28.26	1.23 V	323	33.99	-2.25

Remarks:

1. Emission Level(dBuV/m) = Raw Value(dBuV) + Correction Factor(dB/m)
2. Correction Factor(dB/m) = Antenna Factor (dB/m) + Cable Factor (dB) – Pre-Amplifier Factor (dB)
3. The other emission levels were very low against the limit.
4. Margin value = Emission level – Limit value

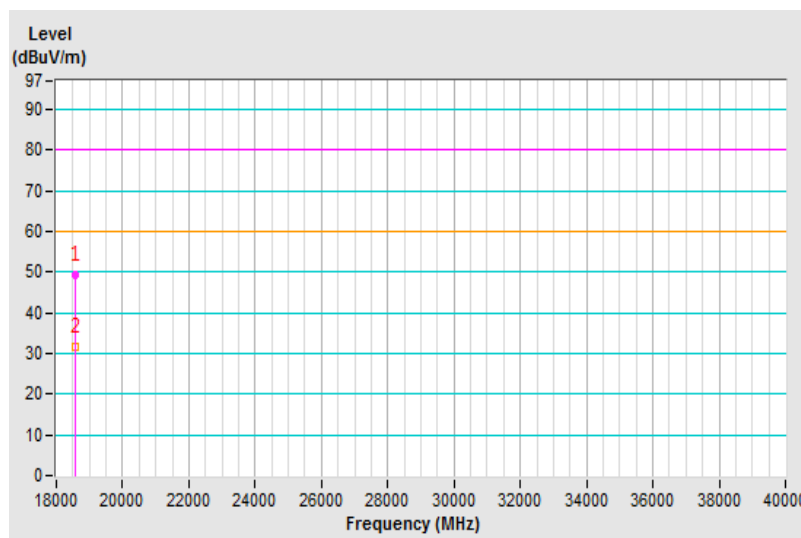

Appendix – Information on the Testing Laboratories

We, Bureau Veritas Consumer Products Services (H.K.) Ltd., Taoyuan Branch, were founded in 1988 to provide our best service in EMC, Radio, Telecom and Safety consultation. Our laboratories are FCC recognized accredited test firms and accredited according to ISO/IEC 17025.

If you have any comments, please feel free to contact us at the following:

Linko EMC/RF Lab

Tel: 886-2-26052180

Fax: 886-2-26051924

Hsin Chu EMC/RF/Telecom Lab

Tel: 886-3-6668565

Fax: 886-3-6668323

Hwa Ya EMC/RF/Safety Lab

Tel: 886-3-3183232

Fax: 886-3-3270892

Email: service.adt@tw.bureauveritas.com

Web Site: www.bureauveritas-adt.com

The address and road map of all our labs can be found in our web site also.

--- END ---