



FCC RADIO TEST REPORT

FCC ID : A4RG013C
Equipment : Smartphone
Model Name : G013C
Applicant : Google LLC
1600 Amphitheatre Parkway,
Mountain View, California, 94043 USA
Standard : FCC 47 CFR Part 2, and 90(S)

The test was completed on Jun. 27, 2018. We, SPORTON INTERNATIONAL INC., would like to declare that the tested sample has been evaluated in accordance with the test procedures given in ANSI / TIA-603-E and has been in compliance with the applicable technical standards.

The report must not be used by the client to claim product certification, approval, or endorsement by TAF or any agency of government.

The test results in this report apply exclusively to the tested model / sample. Without written approval of SPORTON INTERNATIONAL INC. EMC & Wireless Communications Laboratory, the test report shall not be reproduced except in full.

Approved by: Jones Tsai
SPORTON INTERNATIONAL INC. EMC & Wireless Communications Laboratory
No. 52, Huaya 1st Rd., Guishan Dist., Taoyuan City, Taiwan (R.O.C.)



Table of Contents

History of this test report	3
Summary of Test Result.....	4
1 General Description	5
1.1 Feature of Equipment Under Test.....	5
1.2 Product Specification of Equipment Under Test.....	6
1.3 Maximum Power, Frequency Tolerance, and Emission Designator	6
1.4 Modification of EUT	6
1.5 Testing Site.....	7
1.6 Applied Standards	7
2 Test Configuration of Equipment Under Test	8
2.1 Test Mode.....	8
2.2 Connection Diagram of Test System	9
2.3 Support Unit used in test configuration and system	10
2.4 Measurement Results Explanation Example.....	10
2.5 Frequency List of Low/Middle/High Channels	10
3 Conducted Test Items	11
3.1 Measuring Instruments	11
3.2 Conducted Output Power Measurement	12
3.3 Peak-to-Average Ratio	13
3.4 Bandwidth Limitations Measurement	14
3.5 Emissions Mask Measurement	15
3.6 Emissions Mask – Out Of Band Emissions Measurement	16
3.7 Frequency Stability Measurement.....	17
4 Radiated Test Items.....	18
4.1 Measuring Instruments	18
4.2 Field Strength of Spurious Radiation Measurement.....	19
5 List of Measuring Equipment	20
6 Uncertainty of Evaluation	21
Appendix A. Test Results of Conducted Test	
Appendix B. Test Results of Radiated Test	



History of this test report

Report No.	Version	Description	Issued Date
FG820502-02D	01	Initial issue of report	Jun. 27, 2018



Summary of Test Result

Report Clause	Ref Std. Clause	Test Items	Result (PASS/FAIL)	Remark
3.2	§2.1046 §90.635	Conducted Output Power and Effective Radiated Power	Pass	-
3.3	-	Peak-to-Average Ratio	Reporting only	-
3.4	§2.1049 §90.209	Bandwidth Limitations	Reporting only	-
3.5	§2.1051 §90.691	Emission masks – In-band emissions	Pass	-
3.6	§2.1051 §90.691	Emission masks – Out of band emissions	Pass	-
3.7	§2.1055 §90.213	Frequency Stability for Temperature & Voltage	Pass	-
4.2	§2.1053 §90.691	Field Strength of Spurious Radiation	Pass	Under limit 31.08 dB at 4088.000 MHz

Reviewed by: Joseph Lin

Report Producer: Maggie Chiang



1 General Description

1.1 Feature of Equipment Under Test

Product Feature	
Equipment	Smartphone
Model Name	G013C
FCC ID	A4RG013C
EUT supports Radios application	CDMA/EV-DO/GSM/EGPRS/WCDMA/HSPA/LTE/NFC/ GNSS/WPC WLAN 11b/g/n HT20/VHT20 WLAN 11a/n HT20/HT40 WLAN 11ac VHT20/VHT40/VHT80 Bluetooth BR/EDR/LE
EUT Stage	Identical Prototype

Remark: The above EUT's information was declared by manufacturer. Please refer to the specifications or user's manual for more detailed description.

EUT Information List	
No.	S/N
#1	85LY009BE
#2	85LY009BJ
#3	85LY009B6

1.2 Product Specification of Equipment Under Test

Product Specification subjective to this standard	
Tx Frequency	817.9 MHz ~ 823.1 MHz
Rx Frequency	862.9 MHz ~ 868.1 MHz
Maximum Output Power to Antenna	24.43 dBm
Antenna Type / Gain	<For Main Antenna> CDMA2000 B10: integrated loop Antenna with gain -1.60 dBi <For Aux. Antenna> CDMA2000 B10: integrated monopole Antenna with gain -3.00 dBi
Type of Modulation	CDMA2000 : QPSK CDMA2000 1xEV-DO : QPSK/8PSK

1.3 Maximum Power, Frequency Tolerance, and Emission Designator

FCC Rule	Frequency Range (MHz)	System	Type of Modulation	Frequency Tolerance (ppm)	Emission Designator	Max Power (W)
Part 90	817.9 ~ 823.1	CDMA2000 BC10 1xRTT	QPSK	0.0098 ppm	1M28F9W	0.2754
Part 90	817.9 ~ 823.1	CDMA2000 BC10 1xEV-DO	QPSK	0.0098 ppm	1M28F9W	0.2773

1.4 Modification of EUT

No modifications are made to the EUT during all test items.



1.5 Testing Site

Sporton Lab is accredited to ISO 17025 by Taiwan Accreditation Foundation (TAF code : 1190) and the FCC designation No. TW1190 under the FCC 2.948(e) by Mutual Recognition Agreement (MRA) in FCC Test.

Test Site	SPORTON INTERNATIONAL INC.	
Test Site Location	No.52, Huaya 1st Rd., Guishan Dist., Taoyuan City, Taiwan (R.O.C.) TEL: +886-3-327-3456 FAX: +886-3-328-4978	
Test Site No.	Sporton Site No.	
	TH03-HY	03CH07-HY

Note: The test site complies with ANSI C63.4 2014 requirement.

1.6 Applied Standards

According to the specifications of the manufacturer, the EUT must comply with the requirements of the following standards:

- ♦ FCC 47 CFR Part 2, 90
- ♦ ANSI / TIA-603-E
- ♦ ANSI C63.26-2015
- ♦ FCC KDB 971168 D01 Power Meas. License Digital Systems v03r01
- ♦ Interim Guidance for Equipment Authorization of Devices with Channel Bandwidths Combined Across Two Contiguous Service Rule Allocations OET/Lab/EACB, June 6, 2013

Remark:

1. All test items were verified and recorded according to the standards and without any deviation during the test.
2. This EUT has also been tested and complied with the requirements of FCC Part 15, Subpart B, recorded in a separate test report.



2 Test Configuration of Equipment Under Test

2.1 Test Mode

Antenna port conducted and radiated test items listed below are performed according to KDB 971168 D01 Power Meas. License Digital Systems v03r01 with maximum output power.

For radiated measurement, pre-scanned in three orthogonal panels, X, Y, Z. The worst cases (X plane for main antenna and Z plane for aux. antenna and WPC charging mode) were recorded in this report.

Radiated emissions were investigated as following frequency range:

1. 30 MHz to 9000 MHz for CDMA BC10.

Test Modes		
Band	Radiated TCs	Conducted TCs
CDMA2000 BC10	<ul style="list-style-type: none">■ 1xRTT Link■ 1xEV-DO Rev. 0 Link	<ul style="list-style-type: none">■ 1xRTT Link■ 1xEV-DO Rev. 0 Link

Remark: All the radiated test cases were performed with Adapter 1.

2.2 Connection Diagram of Test System

<For Adapter Mode>

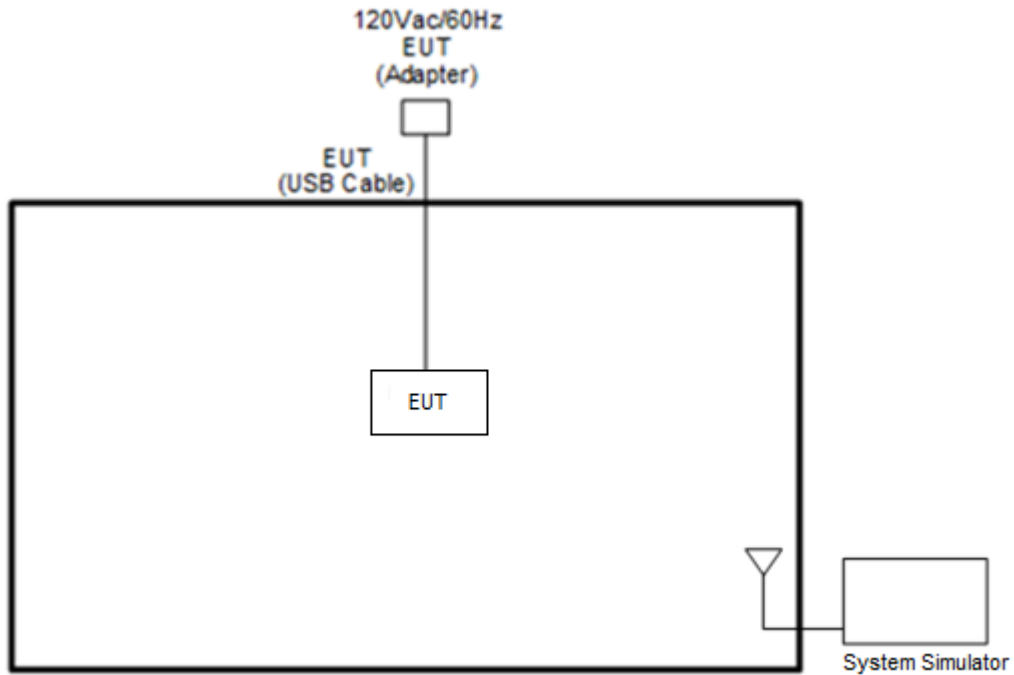

<For WPC Charging Mode>

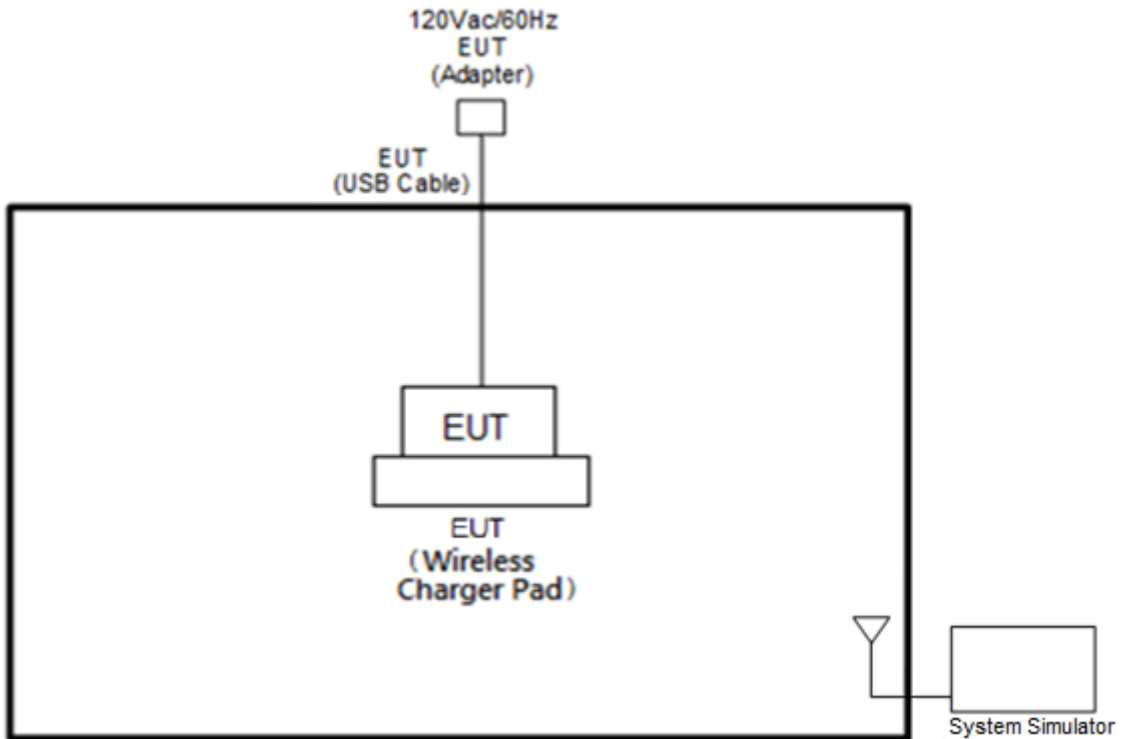



2.3 Support Unit used in test configuration and system

Item	Equipment	Trade Name	Model No.	FCC ID	Data Cable	Power Cord
1.	System Simulator	R&S	CMU 200	N/A	N/A	Unshielded, 1.8 m

2.4 Measurement Results Explanation Example

For all conducted test items:

The offset level is set in the spectrum analyzer to compensate the RF cable loss and attenuator factor between RF conducted output port and spectrum analyzer. With the offset compensation, the spectrum analyzer reading level will be exactly the RF output level.

The spectrum analyzer offset is derived from RF cable loss and attenuator factor.

$$\text{Offset} = \text{RF cable loss} + \text{attenuator factor}.$$

The following shows an offset computation example with RF cable loss 4.2 dB and a 10dB attenuator.

Example :

$$\begin{aligned} \text{Offset(dB)} &= \text{RF cable loss(dB)} + \text{attenuator factor(dB)}. \\ &= 4.2 + 10 = 14.2 \text{ (dB)} \end{aligned}$$

2.5 Frequency List of Low/Middle/High Channels

Frequency List				
Band	Channel/Frequency(MHz)	Lowest	Middle	Highest
CDMA2000 BC10	Channel	476	580	684
	Frequency	817.9	820.5	823.1

3 Conducted Test Items

3.1 Measuring Instruments

See list of measuring instruments of this test report.

3.1.1 Test Setup

3.1.2 Conducted Output Power

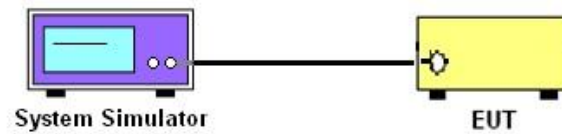

3.1.3 Peak-to-Average Ratio, Occupied Bandwidth, Conducted Band-Edge, and Conducted Spurious Emission

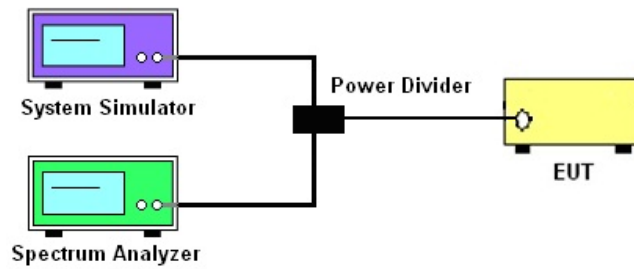

3.1.4 Frequency Stability

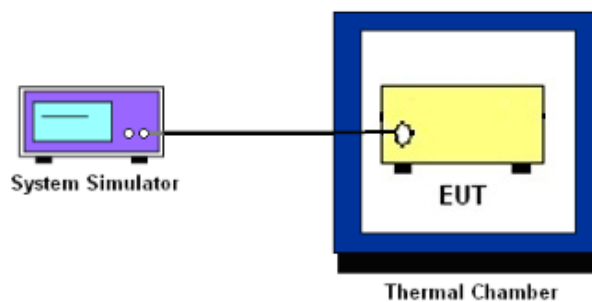

3.1.5 Test Result of Conducted Test

Please refer to Appendix A.



3.2 Conducted Output Power Measurement

3.2.1 Description of the Conducted Output Power Measurement

A system simulator was used to establish communication with the EUT. Its parameters were set to enforce EUT transmitting at the maximum power. The measured power in the radio frequency on the transmitter output terminals shall be reported.

3.2.2 Test Procedures

1. The transmitter output port was connected to the system simulator.
2. Set EUT at maximum power through system simulator.
3. Select lowest, middle, and highest channels for each band and different modulation.
4. Measure and record the power level from the system simulator.



3.3 Peak-to-Average Ratio

3.3.1 Description of the PAR Measurement

Reporting only

3.3.2 Test Procedures

1. The EUT was connected to spectrum and system simulator via a power divider.
2. Set the CCDF (Complementary Cumulative Distribution Function) option in spectrum analyzer.
3. The highest RF powers were measured and recorded the maximum PAPR level associated with a probability of 0.1 %.
4. Record the deviation as Peak to Average Ratio.



3.4 Bandwidth Limitations Measurement

3.4.1 Description of (Occupied) Bandwidth Limitations Measurement

The 99% occupied bandwidth is the width of a frequency band such that, below the lower and above the upper frequency limits, the mean powers emitted are each equal to a specified percentage 0.5% of the total mean transmitted power.

The emission bandwidth is defined as the width of the signal between two points, located at the 2 sides of the carrier frequency, outside of which all emissions are attenuated at least 26 dB below the transmitter power.

3.4.2 Test Procedures

1. The EUT was connected to the spectrum analyzer and system simulator via a power divider.
2. The RF output of the EUT was connected to the spectrum analyzer by RF cable and attenuator. The path loss was compensated to the results for each measurement.
3. The 99% occupied bandwidth were measured, set RBW= 1% of span, VBW \geq 3*RBW, sample detector, trace maximum hold.
4. The 26dB bandwidth were measured, set RBW= 1% of EBW, VBW \geq 3*RBW, peak detector, trace maximum hold.



3.5 Emissions Mask Measurement

3.5.1 Description of Emissions Mask Measurement

Equipment used in this licensed to EA or non-EA systems shall comply with the emission mask provisions of FCC Part 90.691.(a)(1)

- (a). Out-of-band emission requirement shall apply only to the “outer” channels included in an EA license and to spectrum adjacent to interior channels used by incumbent licensees. The emission limits are as follows:
 - (1) For any frequency removed from the EA licensee's frequency block by up to and including 37.5 kHz, the power of any emission shall be attenuated below the transmitter power (P) in watts by at least $116 \text{ Log}_{10}(f/6.1)$ decibels or $50 + 10 \text{ Log}_{10}(P)$ decibels or 80 decibels, whichever is the lesser attenuation, where f is the frequency removed from the center of the outer channel in the block in kilohertz and where f is greater than 12.5 kHz.

3.5.2 Test Procedures

1. The EUT was connected to spectrum analyzer and system simulator via power divider.
2. The emissions mask of low and high channels for the highest RF powers were measured.
3. The measured RBW and the VBW set 3 times of RBW are then set in spectrum analyzer, and the RBW correction factor $10 \log (1\% \text{ of OBW}/\text{measured RBW})$ (dB) was compensated, if required.
4. The test results were shown below plots with a correction offset factor including cable loss, insertion loss of power divider.



3.6 Emissions Mask – Out Of Band Emissions Measurement

3.6.1 Description of Conducted Spurious Emissions Out of band emissions measurement

The power of any emission FCC Part 90.691 (a)(2) on any frequency removed from the assigned frequency by more than 250 percent of the authorized bandwidth at least $43 + 10 \log (P)$ dB.

It is measured by means of a calibrated spectrum analyzer and scanned from 30 MHz up to a frequency including its 10th harmonic.

3.6.2 Test Procedures

1. The EUT was connected to the spectrum analyzer and system simulator via a power divider.
2. The RF output of EUT was connected to the spectrum analyzer by an RF cable and attenuator. The path loss was compensated to the results for each measurement.
3. The middle channel for the highest RF power within the transmitting frequency was measured.
4. The conducted spurious emission for the whole frequency range was taken.
5. The RF fundamental frequency should be excluded against the limit line in the operating frequency band.
6. The limit line is derived from $43 + 10\log(P)$ dB below the transmitter power P(Watts)



3.7 Frequency Stability Measurement

3.7.1 Description of Frequency Stability Measurement

The frequency stability shall be measured by variation of ambient temperature and variation of primary supply voltage to ensure that the fundamental emission stays within the authorized frequency block. The frequency stability of the transmitter shall be maintained within $\pm 0.00025\%$ ($\pm 2.5\text{ppm}$) of the center frequency according to FCC Part 90.213.

3.7.2 Test Procedures for Temperature Variation

1. The EUT was set up in the thermal chamber and connected with the base station.
2. With power OFF, the temperature was decreased to -30°C and the EUT was stabilized for three hours. Power was applied and the maximum change in frequency was recorded within one minute.
3. With power OFF, the temperature was raised in 10°C step up to 50°C . The EUT was stabilized at each step for at least half an hour. Power was applied and the maximum frequency change was recorded within one minute.

3.7.3 Test Procedures for Voltage Variation

1. The EUT was placed in a temperature chamber at $20\pm 5^{\circ}\text{C}$ and connected with the base station.
2. The power supply voltage to the EUT was varied from BEP to 115% of the nominal value measured at the input to the EUT.
3. The variation in frequency was measured for the worst case.

4 Radiated Test Items

4.1 Measuring Instruments

See list of measuring instruments of this test report.

4.1.1 Test Setup

For radiated test from 30MHz to 1GHz

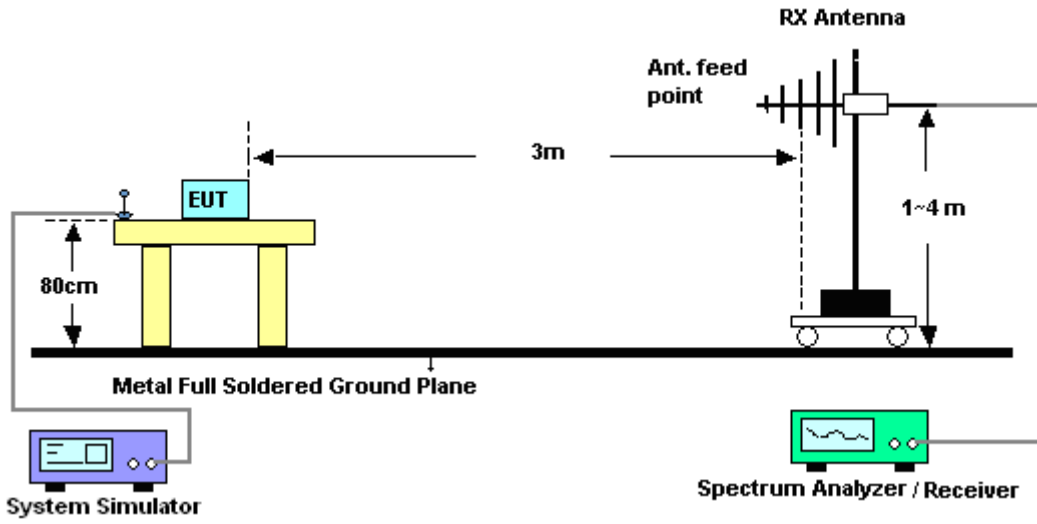

For radiated test above 1GHz

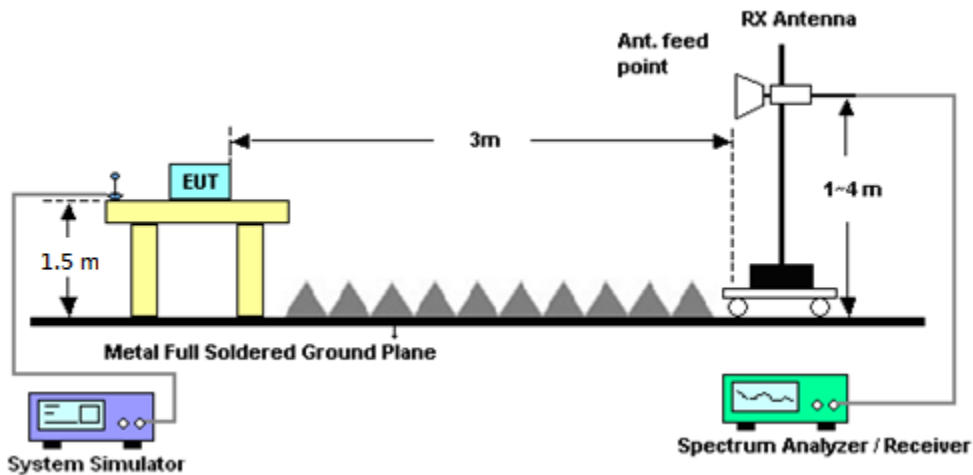

4.1.2 Test Result of Radiated Test

Please refer to Appendix B.



4.2 Field Strength of Spurious Radiation Measurement

4.2.1 Description of Field Strength of Spurious Radiated Measurement

The radiated spurious emission was measured by substitution method according to ANSI / TIA-603-E. The power of any emission FCC Part 90.691 on any frequency removed from the assigned frequency by more than 250 percent of the authorized bandwidth at least $43 + 10 \log (P)$ dB. The spectrum is scanned from 30 MHz up to a frequency including its 10th harmonic.

The power of any emission outside of the authorized operating frequency ranges must be attenuated below the transmitter power (P) by a factor of at least $43+10\log_{10}(P[\text{Watts}])$ dB. The spectrum is scanned from 30 MHz up to a frequency including its 10th harmonic.

4.2.2 Test Procedures

1. The EUT was placed on a rotatable wooden table 0.8 meters for frequency below 1GHz and 1.5 meter for frequency above 1GHz above the ground.
2. The EUT was set 3 meters from the receiving antenna, which was mounted on the antenna tower.
3. The table was rotated 360 degrees to determine the position of the highest spurious emission.
4. The height of the receiving antenna is varied between one meter and four meters to search for the maximum spurious emission for both horizontal and vertical polarizations.
5. Make the measurement with the spectrum analyzer's RBW = 1MHz, VBW = 3MHz, taking record of maximum spurious emission.
6. A horn antenna was substituted in place of the EUT and was driven by a signal generator.
7. Tune the output power of signal generator to the same emission level with EUT maximum spurious emission.
8. Taking the record of output power at antenna port.
9. Repeat step 7 to step 8 for another polarization.
10. $\text{EIRP (dBm)} = \text{S.G. Power} - \text{Tx Cable Loss} + \text{Tx Antenna Gain}$
11. $\text{ERP (dBm)} = \text{EIRP} - 2.15$
12. The RF fundamental frequency should be excluded against the limit line in the operating frequency band.
13. The limit line is derived from $43 + 10\log(P)$ dB below the transmitter power P(Watts)



5 List of Measuring Equipment

Instrument	Manufacturer	Model No.	Serial No.	Characteristics	Calibration Date	Test Date	Due Date	Remark
Spectrum Analyzer	Rohde & Schwarz	FSV40	101397	10Hz~40GHz	Nov. 07, 2017	Jun. 14, 2018~ Jun. 27, 2018	Nov. 06, 2018	Conducted (TH03-HY)
Temperature Chamber	ESPEC	SU-641	92013721	-30°C ~70°C	Dec. 06, 2017	Jun. 14, 2018~ Jun. 27, 2018	Dec. 05, 2019	Conducted (TH03-HY)
Programmable Power Supply	GW Instek	PSS-2005	EL883644	Voltage:0~20V; Current:0~5A	Dec. 06, 2017	Jun. 14, 2018~ Jun. 27, 2018	Dec. 05, 2019	Conducted (TH03-HY)
Base Station (Measure)	Rohde & Schwarz	CMU200	117995	GSM / GPRS / WCDMA / CDMA	Aug. 09, 2017	Jun. 14, 2018~ Jun. 27, 2018	Aug. 08, 2018	Conducted (TH03-HY)
Preamplifier	COM-POWER	PA-103A	161241	10MHz-1GHz	May 21, 2018	Jun. 07, 2018~ Jun. 11, 2018	May 20, 2019	Radiation (03CH07-HY)
Bilog Antenna	TESEQ	CBL 6111D&00800 N1D01N-06	35419&03	30MHz to 1GHz	Dec. 18, 2017	Jun. 07, 2018~ Jun. 11, 2018	Dec. 17, 2018	Radiation (03CH07-HY)
Double Ridge Horn Antenna	ESCO	3117	00075962	1GHz ~ 18GHz	Aug. 23, 2017	Jun. 07, 2018~ Jun. 11, 2018	Aug. 22, 2018	Radiation (03CH07-HY)
Preamplifier	Agilent	8449B	3008A02362	1GHz~ 26.5GHz	Oct. 30, 2017	Jun. 07, 2018~ Jun. 11, 2018	Oct. 29, 2018	Radiation (03CH07-HY)
Spectrum Analyzer	Agilent	N9010A	MY53470118	10Hz~44GHz	Apr. 17, 2018	Jun. 07, 2018~ Jun. 11, 2018	Apr. 16, 2019	Radiation (03CH07-HY)
Antenna Mast	Max-Full	MFA520BS	N/A	1m~4m	N/A	Jun. 07, 2018~ Jun. 11, 2018	N/A	Radiation (03CH07-HY)
Turn Table	ChainTek	Chaintek 3000	N/A	0~360 Degree	N/A	Jun. 07, 2018~ Jun. 11, 2018	N/A	Radiation (03CH07-HY)
SHF-EHF Horn Antenna	SCHWARZBECK	BBHA 9170	BBHA9170584	18GHz- 40GHz	Nov. 27, 2017	Jun. 07, 2018~ Jun. 11, 2018	Nov. 26, 2018	Radiation (03CH07-HY)
Horn Antenna	ESCO	3117	00066584	1GHz~18GHz	Sep. 06, 2017	Jun. 07, 2018~ Jun. 11, 2018	Sep. 05, 2018	Radiation (03CH07-HY)
Signal Generator	Anritsu	MG3694C	163401	0.1Hz~40GHz	Jan. 15, 2018	Jun. 07, 2018~ Jun. 11, 2018	Jan. 14, 2019	Radiation (03CH07-HY)
Filter	Wainwright	WLKS1200-8SS	SN3	1.2G Low Pass	Nov. 21, 2017	Jun. 07, 2018~ Jun. 11, 2018	Nov. 20, 2018	Radiation (03CH07-HY)
Filter	Microwave	H3G018G1	SN477220	3.0G High Pass	Nov. 21, 2017	Jun. 07, 2018~ Jun. 11, 2018	Nov. 20, 2018	Radiation (03CH07-HY)
RF Cable	HUBER + SUHNER	SUCOFLEX 104	MY24971/4,MY 28655/4	9KHz~30MHz	Jan. 02, 2018	Jun. 07, 2018~ Jun. 11, 2018	Jan. 01, 2019	Radiation (03CH07-HY)
RF Cable	HUBER + SUHNER	SUCOFLEX 104	MY28655/4, MY24971/4, MY15682/4	30MHz~1GHz	Feb. 27, 2018	Jun. 07, 2018~ Jun. 11, 2018	Feb. 26, 2019	Radiation (03CH07-HY)
RF Cable	HUBER + SUHNER	SUCOFLEX 104	MY28655/4, MY24971/4, MY15682/4	1GHz~18GHz	Feb. 27, 2018	Jun. 07, 2018~ Jun. 11, 2018	Feb. 26, 2019	Radiation (03CH07-HY)
RF Cable	HUBER + SUHNER	SUCOFLEX 102	MY2858/2	1G~40GHz	Jan. 02, 2018	Jun. 07, 2018~ Jun. 11, 2018	Jan. 01, 2019	Radiation (03CH07-HY)
Software	Audix	E3 6.2009-8-24	80504004656H	N/A	N/A	Jun. 07, 2018~ Jun. 11, 2018	N/A	Radiation (03CH07-HY)



6 Uncertainty of Evaluation

Uncertainty of Radiated Emission Measurement (30 MHz ~ 1000 MHz)

Measuring Uncertainty for a Level of Confidence of 95% ($U = 2Uc(y)$)	3.05
---	------

Uncertainty of Radiated Emission Measurement (1 GHz ~ 18 GHz)

Measuring Uncertainty for a Level of Confidence of 95% ($U = 2Uc(y)$)	3.44
---	------

Uncertainty of Radiated Emission Measurement (18 GHz ~ 40 GHz)

Measuring Uncertainty for a Level of Confidence of 95% ($U = 2Uc(y)$)	3.95
---	------



Appendix A. Test Results of Conducted Test

Conducted Output Power(Average power)

Conducted Power (*Unit: dBm)			
Band	CDMA 2000 BC10		
Channel	476	580	684
Frequency	817.9	820.5	823.1
1xRTT RC1 SO55	24.31	24.36	24.38
1xRTT RC3 SO55	24.29	24.36	24.39
1xRTT RC3 SO32 (+ F-SCH)	24.30	24.33	24.40
1xRTT RC3 SO32 (+SCH)	24.28	24.35	24.39
1xEVDO RTAP 153.6Kbps	24.28	24.35	24.43
1xEVDO RETAP 4096Bits	24.25	24.33	24.40



A2. CDMA

Peak-to-Average Ratio

Mode	CDMA BC10	CDMA BC10	Limit: 13dB
Mod.	1xRTT	1xEV-DO Rev. 0	Result
Lowest CH	3.32	3.64	PASS
Middle CH	3.36	3.72	
Highest CH	3.52	4.12	

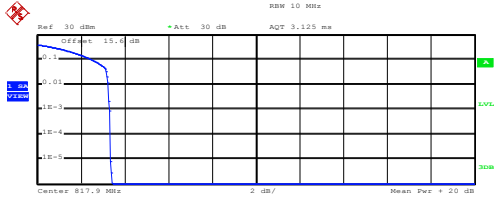
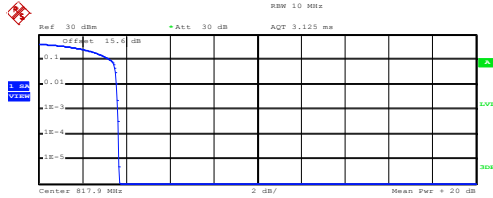
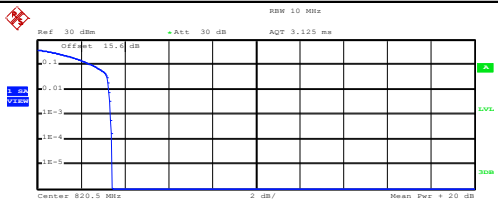
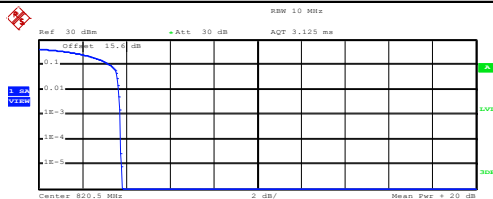
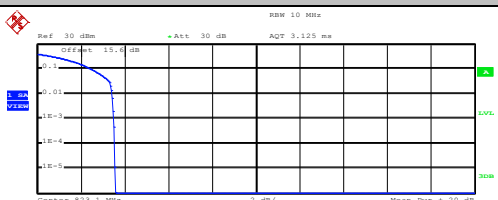
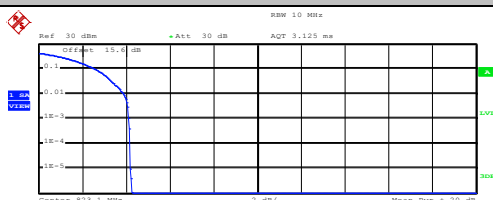

CDMA BC10 (1xRTT)	CDMA BC10 (1xEV-DO Rev. 0)
<p align="center">Lowest Channel</p>  <p>Center 817.9 MHz 2 dB/ Mean Pwr + 20 dB</p> <p>Complementary Cumulative Distribution Function (100000 samples)</p> <p>Trace 1</p> <p>Mean 24.09 dBm Peak 27.50 dBm Crest 3.42 dB</p> <p>10 % 2.56 dB 1 % 3.24 dB .1 % 3.32 dB .01 % 3.36 dB</p> <p>Date: 15.JUN.2018 12:58:13</p>	<p align="center">Lowest Channel</p>  <p>Center 817.9 MHz 2 dB/ Mean Pwr + 20 dB</p> <p>Complementary Cumulative Distribution Function (100000 samples)</p> <p>Trace 1</p> <p>Mean 24.11 dBm Peak 27.82 dBm Crest 3.71 dB</p> <p>10 % 3.28 dB 1 % 3.56 dB .1 % 3.64 dB .01 % 3.68 dB</p> <p>Date: 26.JUN.2018 21:56:56</p>
<p align="center">Middle Channel</p>  <p>Center 820.5 MHz 2 dB/ Mean Pwr + 20 dB</p> <p>Complementary Cumulative Distribution Function (100000 samples)</p> <p>Trace 1</p> <p>Mean 23.74 dBm Peak 27.15 dBm Crest 3.41 dB</p> <p>10 % 2.52 dB 1 % 3.28 dB .1 % 3.36 dB .01 % 3.40 dB</p> <p>Date: 15.JUN.2018 12:58:28</p>	<p align="center">Middle Channel</p>  <p>Center 820.5 MHz 2 dB/ Mean Pwr + 20 dB</p> <p>Complementary Cumulative Distribution Function (100000 samples)</p> <p>Trace 1</p> <p>Mean 23.93 dBm Peak 27.75 dBm Crest 3.82 dB</p> <p>10 % 3.28 dB 1 % 3.68 dB .1 % 3.72 dB .01 % 3.76 dB</p> <p>Date: 26.JUN.2018 21:57:20</p>
<p align="center">Highest Channel</p>  <p>Center 823.1 MHz 2 dB/ Mean Pwr + 20 dB</p> <p>Complementary Cumulative Distribution Function (100000 samples)</p> <p>Trace 1</p> <p>Mean 24.05 dBm Peak 27.64 dBm Crest 3.59 dB</p> <p>10 % 2.52 dB 1 % 3.44 dB .1 % 3.52 dB .01 % 3.56 dB</p> <p>Date: 15.JUN.2018 12:58:41</p>	<p align="center">Highest Channel</p>  <p>Center 823.1 MHz 2 dB/ Mean Pwr + 20 dB</p> <p>Complementary Cumulative Distribution Function (100000 samples)</p> <p>Trace 1</p> <p>Mean 24.05 dBm Peak 28.31 dBm Crest 4.26 dB</p> <p>10 % 2.60 dB 1 % 3.88 dB .1 % 4.12 dB .01 % 4.20 dB</p> <p>Date: 26.JUN.2018 21:59:13</p>



26dB Bandwidth

Mode	CDMA BC10 26dB BW(MHz)	CDMA BC10 26dB BW(MHz)
Mod.	1xRTT	1xEV-DO Rev. 0
Lowest CH	1.43	1.43
Middle CH	1.44	1.44
Highest CH	1.43	1.42



CDMA BC10 (1xRTT)

Lowest Channel

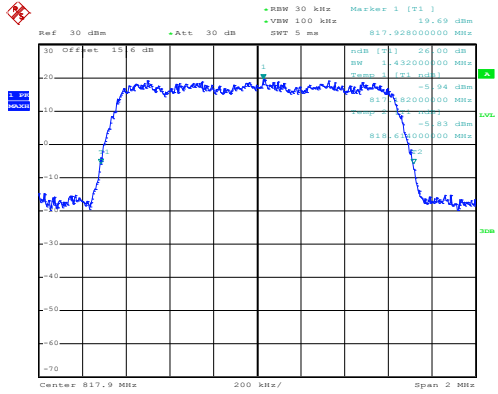

Date: 15.JUN.2018 12:54:46

CDMA BC10 (1xEV-DO Rev. 0)

Lowest Channel

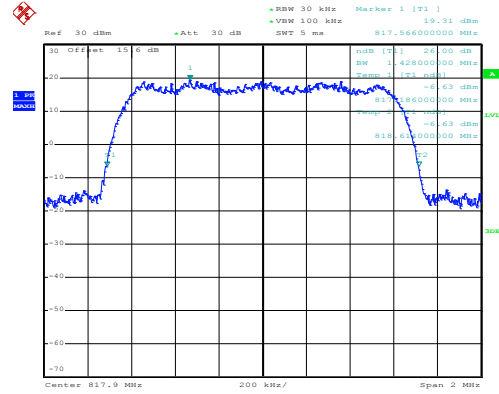

Date: 26.JUN.2018 21:51:00

Middle Channel

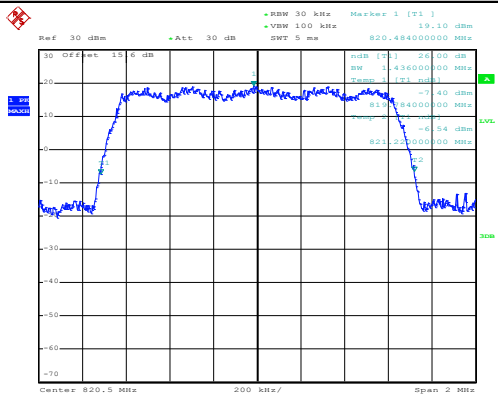

Date: 15.JUN.2018 12:55:28

Middle Channel

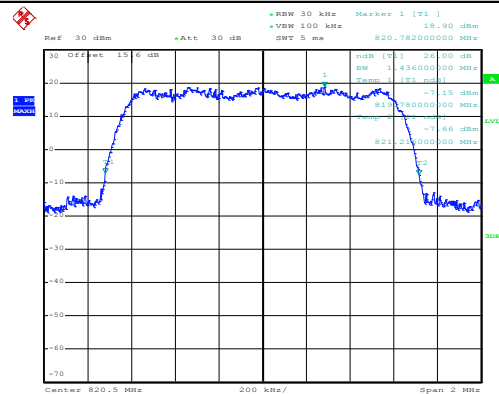

Date: 26.JUN.2018 21:51:33

Highest Channel

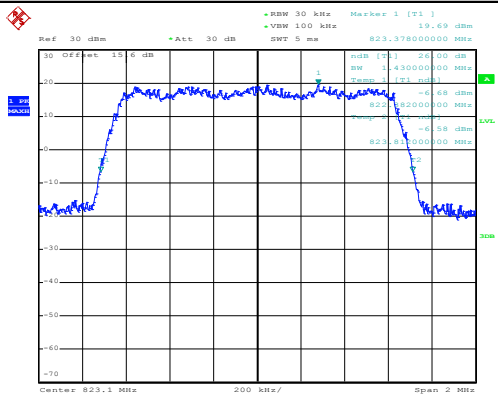

Date: 15.JUN.2018 12:56:06

Highest Channel

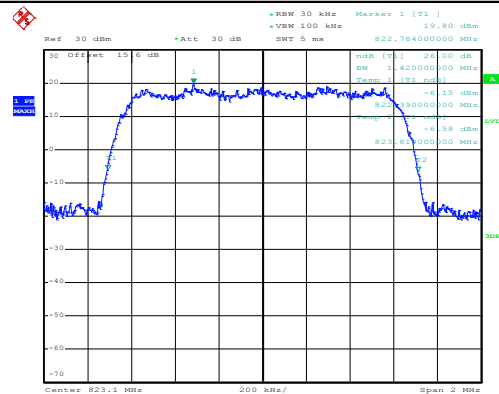

Date: 26.JUN.2018 21:52:06



Occupied Bandwidth

Mode	CDMA BC10 99% OBW(MHz)	CDMA BC10 99% OBW(MHz)
Mod.	1xRTT	1xEV-DO Rev. 0
Lowest CH	1.28	1.28
Middle CH	1.28	1.27
Highest CH	1.28	1.28



CDMA BC10 (1xRTT)

Lowest Channel

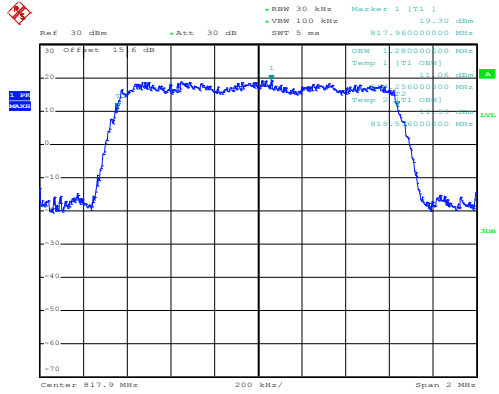

Date: 15.JUN.2018 12:56:52

CDMA BC10 (1xEV-DO Rev. 0)

Lowest Channel

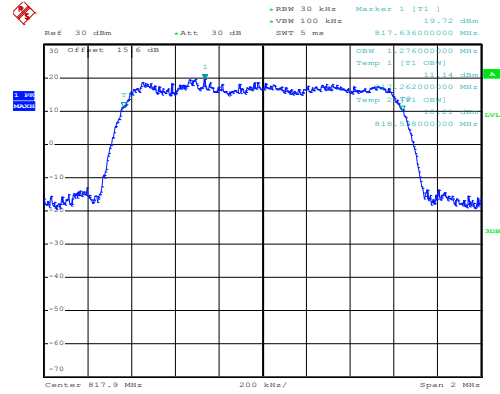

Date: 26.JUN.2018 21:52:41

Middle Channel

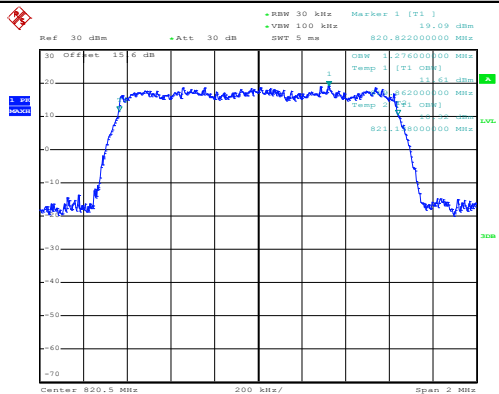

Date: 15.JUN.2018 12:57:25

Middle Channel

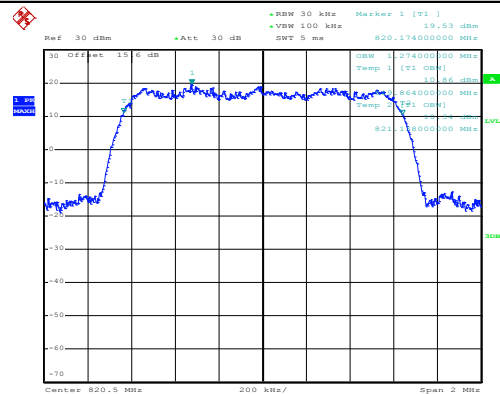

Date: 26.JUN.2018 21:53:14

Highest Channel

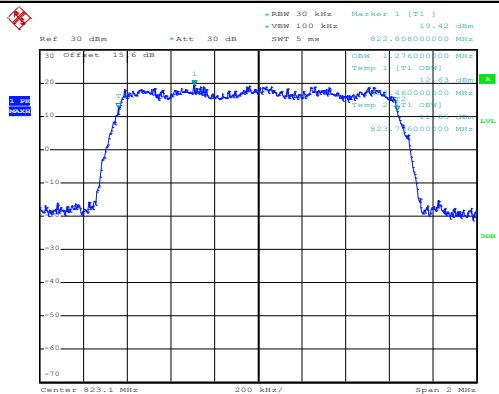

Date: 15.JUN.2018 12:57:57

Highest Channel

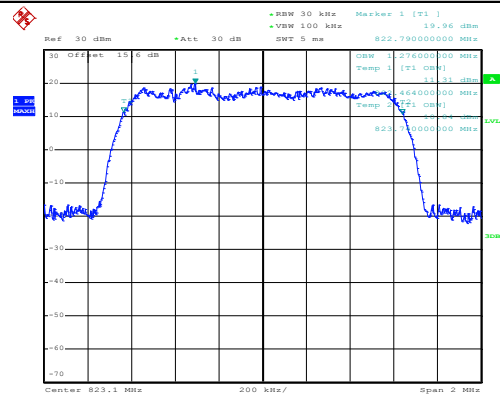

Date: 26.JUN.2018 21:53:47



Conducted Band Edge

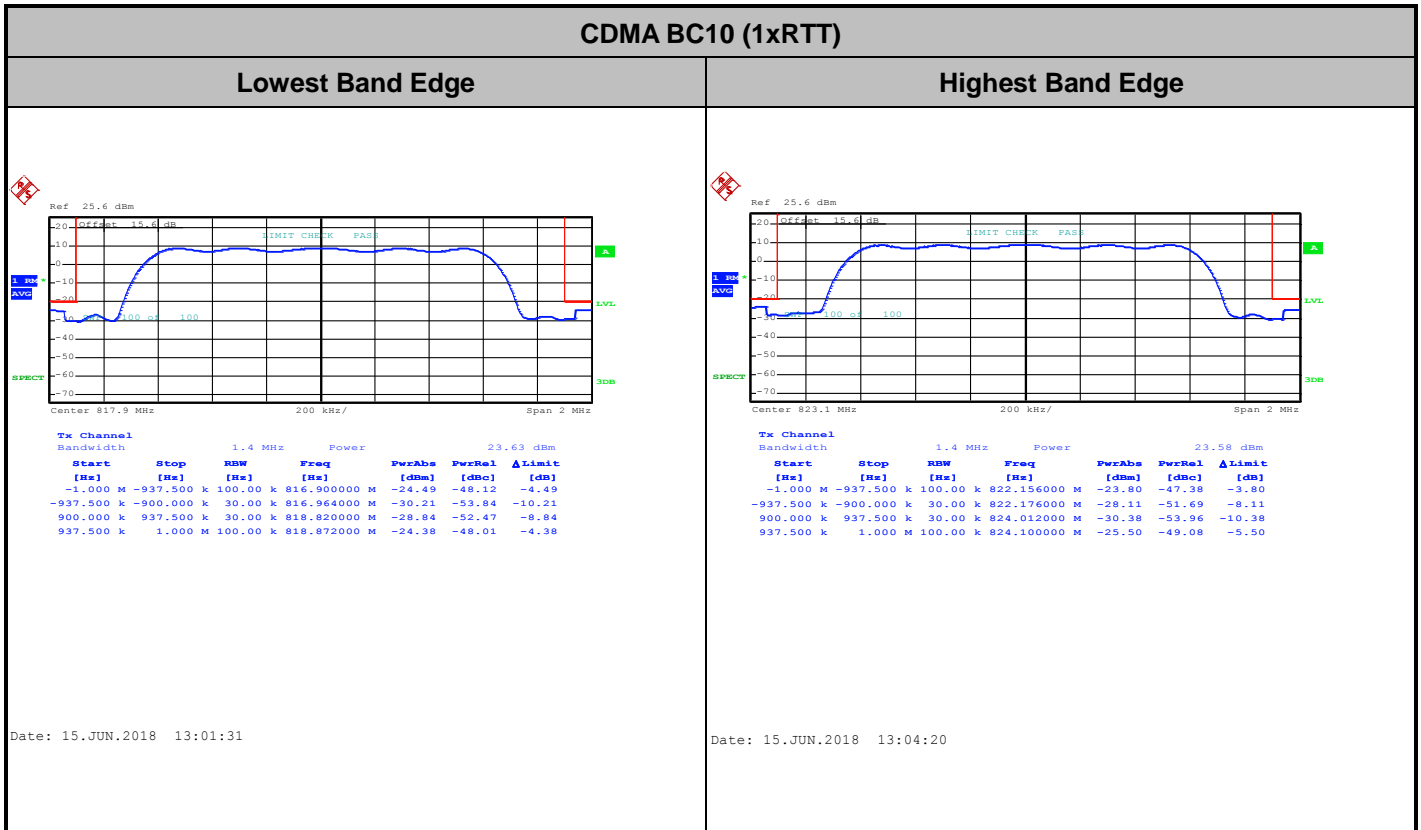



CDMA BC10 (1xEV-DO Rev. 0)

Lowest Band Edge

Highest Band Edge

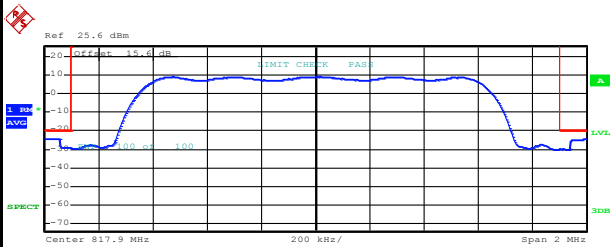

Tx Channel		Bandwidth		Power		23.67 dBm	
Start	Stop	RBW	Freq	PwrAbs	PwrRel	ΔLimit	
[Hz]	[Hz]	[Hz]	[Hz]	[dBm]	[dBc]	[dB]	
-1.000 M	-937.500 k	100.00 k	816.812000 M	-24.32	-47.99	-4.32	
-937.500 k	-900.000 k	30.00 k	816.984000 M	-29.08	-52.74	-9.08	
900.000 k	937.500 k	30.00 k	818.812000 M	-29.90	-53.56	-9.90	
937.500 k	1.000 M	100.00 k	818.888000 M	-24.54	-48.20	-4.54	

Date: 26.JUN.2018 21:47:32

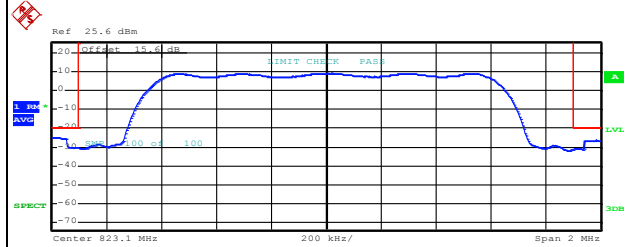

Tx Channel		Bandwidth		Power		23.64 dBm	
Start	Stop	RBW	Freq	PwrAbs	PwrRel	ΔLimit	
[Hz]	[Hz]	[Hz]	[Hz]	[dBm]	[dBc]	[dB]	
-1.000 M	-937.500 k	100.00 k	822.104000 M	-24.97	-48.61	-4.97	
-937.500 k	-900.000 k	30.00 k	822.184000 M	-30.13	-53.77	-10.13	
900.000 k	937.500 k	30.00 k	824.020000 M	-30.96	-54.60	-10.96	
937.500 k	1.000 M	100.00 k	824.084000 M	-26.44	-50.07	-6.44	

Date: 26.JUN.2018 21:50:20



Conducted Spurious Emission

CDMA BC10 (1xRTT)

Lowest Channel

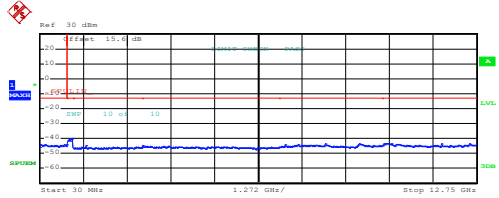

Start [Hz]	Stop [Hz]	RBW [Hz]	Freq [Hz]	PwrAbs [dBm]	ΔLimit [dB]
30.000 M	813.250 M	100.00 k	52.714250 M	-43.95	-30.95
827.750 M	1.000 G	100.00 k	965.463875 M	-39.82	-26.82
1.000 G	3.000 G	100.00 k	1.384000 G	-44.41	-31.41
3.000 G	7.000 G	100.00 k	3.028000 G	-44.57	-31.57
7.000 G	10.000 G	100.00 k	8.339500 G	-43.41	-30.41
10.000 G	12.750 G	100.00 k	10.211750 G	-43.20	-30.20

Date: 15.JUN.2018 13:06:05

CDMA BC10 (1xEV-DO Rev. 0)

Lowest Channel

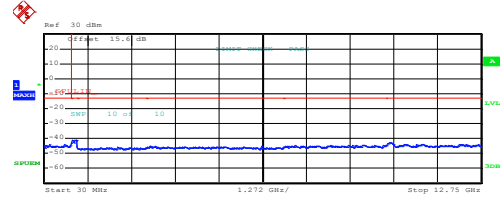

Start [Hz]	Stop [Hz]	RBW [Hz]	Freq [Hz]	PwrAbs [dBm]	ΔLimit [dB]
30.000 M	813.250 M	100.00 k	812.858375 M	-43.71	-30.71
827.750 M	1.000 G	100.00 k	973.645750 M	-41.08	-28.08
1.000 G	3.000 G	100.00 k	2.199000 G	-45.69	-32.69
3.000 G	7.000 G	100.00 k	3.248000 G	-45.12	-32.12
7.000 G	10.000 G	100.00 k	7.333000 G	-44.38	-31.38
10.000 G	12.750 G	100.00 k	10.122375 G	-42.69	-29.69

Date: 26.JUN.2018 21:54:42

Middle Channel

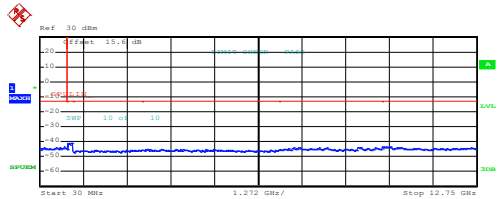

Start [Hz]	Stop [Hz]	RBW [Hz]	Freq [Hz]	PwrAbs [dBm]	ΔLimit [dB]
30.000 M	813.250 M	100.00 k	740.051625 M	-43.60	-30.60
827.750 M	1.000 G	100.00 k	941.176625 M	-41.02	-28.02
1.000 G	3.000 G	100.00 k	2.811000 G	-45.29	-32.29
3.000 G	7.000 G	100.00 k	4.114000 G	-44.94	-31.94
7.000 G	10.000 G	100.00 k	9.368500 G	-43.83	-30.83
10.000 G	12.750 G	100.00 k	10.116875 G	-43.30	-30.30

Date: 15.JUN.2018 13:08:30

Middle Channel

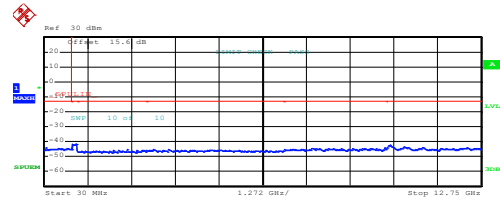

Start [Hz]	Stop [Hz]	RBW [Hz]	Freq [Hz]	PwrAbs [dBm]	ΔLimit [dB]
30.000 M	813.250 M	100.00 k	82.086125 M	-44.06	-31.06
827.750 M	1.000 G	100.00 k	985.533000 M	-41.38	-28.38
1.000 G	3.000 G	100.00 k	2.452000 G	-45.37	-32.37
3.000 G	7.000 G	100.00 k	3.214000 G	-45.31	-32.31
7.000 G	10.000 G	100.00 k	9.953500 G	-44.03	-31.03
10.000 G	12.750 G	100.00 k	10.090750 G	-42.44	-29.44

Date: 26.JUN.2018 21:55:34

Highest Channel

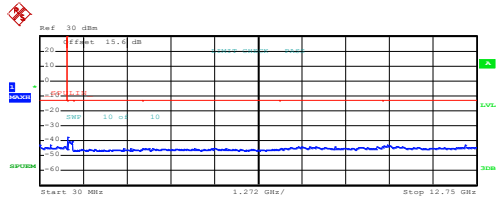

Start [Hz]	Stop [Hz]	RBW [Hz]	Freq [Hz]	PwrAbs [dBm]	ΔLimit [dB]
30.000 M	813.250 M	100.00 k	343.691625 M	-42.88	-29.88
827.750 M	1.000 G	100.00 k	828.008375 M	-37.91	-24.91
1.000 G	3.000 G	100.00 k	2.472000 G	-45.16	-32.16
3.000 G	7.000 G	100.00 k	5.452000 G	-44.88	-31.88
7.000 G	10.000 G	100.00 k	8.638000 G	-43.87	-30.87
10.000 G	12.750 G	100.00 k	10.147125 G	-42.82	-29.82

Date: 15.JUN.2018 13:09:23

Highest Channel

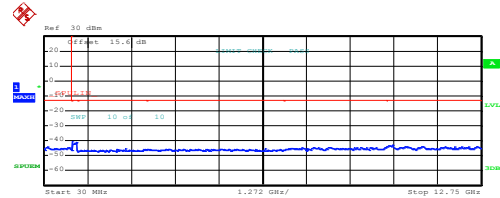

Start [Hz]	Stop [Hz]	RBW [Hz]	Freq [Hz]	PwrAbs [dBm]	ΔLimit [dB]
30.000 M	813.250 M	100.00 k	137.305250 M	-44.04	-31.04
827.750 M	1.000 G	100.00 k	828.008375 M	-40.59	-27.59
1.000 G	3.000 G	100.00 k	2.407000 G	-45.36	-32.36
3.000 G	7.000 G	100.00 k	6.464000 G	-45.42	-32.42
7.000 G	10.000 G	100.00 k	8.005000 G	-44.30	-31.30
10.000 G	12.750 G	100.00 k	10.187000 G	-43.03	-30.03

Date: 26.JUN.2018 21:56:27



Frequency Stability

Test Conditions	Middle Channel	CDMA BC10 (1xRTT)	Limit Note 2.
Temperature (°C)	Voltage (Volt)	Deviation (ppm)	Result
50	Normal Voltage	0.0012	PASS
40	Normal Voltage	0.0012	
30	Normal Voltage	0.0024	
20(Ref.)	Normal Voltage	0.0000	
10	Normal Voltage	0.0037	
0	Normal Voltage	0.0037	
-10	Normal Voltage	0.0085	
-20	Normal Voltage	0.0098	
-30	Normal Voltage	0.0098	
20	Maximum Voltage	0.0061	
20	Normal Voltage	0.0000	
20	Battery End Point	0.0061	

Test Conditions	Middle Channel	CDMA BC10 (1xEV-DO Rev. 0)	Limit Note 2.
Temperature (°C)	Voltage (Volt)	Deviation (ppm)	Result
50	Normal Voltage	0.0012	PASS
40	Normal Voltage	0.0012	
30	Normal Voltage	0.0024	
20(Ref.)	Normal Voltage	0.0000	
10	Normal Voltage	0.0037	
0	Normal Voltage	0.0037	
-10	Normal Voltage	0.0085	
-20	Normal Voltage	0.0098	
-30	Normal Voltage	0.0098	
20	Maximum Voltage	0.0024	
20	Normal Voltage	0.0000	
20	Battery End Point	0.0012	

Note:

1. Normal Voltage = 3.8V. ; Battery End Point (BEP) = 3.4 V. ; Maximum Voltage =4.4V
2. The frequency fundamental emissions stay within the authorized frequency block.



Appendix B. Test Results of Radiated Test

<Main Antenna>

<For Adapter Mode>

CDMA BC10

CDMA BC10									
Channel	Frequency (MHz)	ERP (dBm)	Limit (dBm)	Over Limit (dB)	SPA Reading (dBm)	S.G. Power (dBm)	TX Cable loss (dB)	TX Antenna Gain (dBi)	Polarization (H/V)
Lowest	1640	-58.44	-13	-45.44	-70.76	-60.22	0.97	4.91	H
	2456	-54.83	-13	-41.83	-72.38	-56.67	1.28	5.27	H
	3272	-56.31	-13	-43.31	-75.82	-59.62	1.53	7.00	H
	4088	-44.85	-13	-31.85	-65.71	-49.51	1.81	8.62	H
	1640	-62.51	-13	-49.51	-75.38	-64.29	0.97	4.91	V
	2456	-55.89	-13	-42.89	-73.85	-57.73	1.28	5.27	V
	3272	-54.53	-13	-41.53	-74.41	-57.84	1.53	7.00	V
	4088	-50.71	-13	-37.71	-71.76	-55.37	1.81	8.62	V
Middle	1640	-59.47	-13	-46.47	-71.82	-61.25	0.97	4.91	H
	2464	-55.77	-13	-42.77	-73.22	-57.63	1.28	5.29	H
	3280	-55.03	-13	-42.03	-74.53	-58.38	1.54	7.03	H
	4104	-47.39	-13	-34.39	-68.27	-52.04	1.82	8.62	H
	1640	-62.33	-13	-49.33	-75.18	-64.11	0.97	4.91	V
	2464	-55.71	-13	-42.71	-73.64	-57.57	1.28	5.29	V
	3280	-57.64	-13	-44.64	-77.43	-60.99	1.54	7.03	V
	4104	-49.89	-13	-36.89	-70.88	-54.54	1.82	8.62	V
Highest	1648	-62.85	-13	-49.85	-75.2	-64.61	0.98	4.89	H
	2472	-55.89	-13	-42.89	-73.41	-57.77	1.28	5.32	H
	3288	-58.03	-13	-45.03	-77.63	-61.41	1.54	7.07	H
	4120	-47.97	-13	-34.97	-68.86	-52.61	1.83	8.62	H
	1648	-61.48	-13	-48.48	-74.28	-63.24	0.98	4.89	V
	2472	-56.46	-13	-43.46	-74.43	-58.34	1.28	5.32	V
	3288	-57.87	-13	-44.87	-77.78	-61.25	1.54	7.07	V
	4120	-45.51	-13	-32.51	-66.61	-50.15	1.83	8.62	V

Remark: Spurious emissions within 30-1000MHz were found more than 20dB below limit line.



<Aux. Antenna>

CDMA BC10									
Channel	Frequency (MHz)	ERP (dBm)	Limit (dBm)	Over Limit (dB)	SPA Reading (dBm)	S.G. Power (dBm)	TX Cable loss (dB)	TX Antenna Gain (dBi)	Polarization (H/V)
Lowest	1640	-61.47	-13	-48.47	-73.76	-63.25	0.97	4.91	H
	2456	-50.72	-13	-37.72	-68.12	-52.56	1.28	5.27	H
	3272	-56.63	-13	-43.63	-76.02	-59.94	1.53	7.00	H
	4088	-47.68	-13	-34.68	-68.44	-52.34	1.81	8.62	H
	1640	-59.09	-13	-46.09	-71.98	-60.87	0.97	4.91	V
	2456	-52.65	-13	-39.65	-70.52	-54.49	1.28	5.27	V
	3272	-56.38	-13	-43.38	-76.2	-59.69	1.53	7.00	V
	4088	-48.36	-13	-35.36	-69.29	-53.02	1.81	8.62	V
Middle	1640	-61.04	-13	-48.04	-73.39	-62.82	0.97	4.91	H
	2464	-54.17	-13	-41.17	-71.62	-56.03	1.28	5.29	H
	3280	-55.29	-13	-42.29	-74.72	-58.64	1.54	7.03	H
	4104	-49.37	-13	-36.37	-70.25	-54.02	1.82	8.62	H
	1640	-62.11	-13	-49.11	-74.89	-63.89	0.97	4.91	V
	2464	-53.28	-13	-40.28	-71.21	-55.14	1.28	5.29	V
	3280	-56.28	-13	-43.28	-76.2	-59.63	1.54	7.03	V
	4104	-50.06	-13	-37.06	-71.11	-54.71	1.82	8.62	V
Highest	1648	-62.11	-13	-49.11	-74.4	-63.87	0.98	4.89	H
	2472	-53.41	-13	-40.41	-70.92	-55.29	1.28	5.32	H
	3288	-58.21	-13	-45.21	-77.85	-61.59	1.54	7.07	H
	4120	-44.38	-13	-31.38	-65.31	-49.02	1.83	8.62	H
	1648	-59.67	-13	-46.67	-72.47	-61.43	0.98	4.89	V
	2472	-54.48	-13	-41.48	-72.49	-56.36	1.28	5.32	V
	3288	-57.73	-13	-44.73	-77.67	-61.11	1.54	7.07	V
	4120	-48.72	-13	-35.72	-69.87	-53.36	1.83	8.62	V

Remark: Spurious emissions within 30-1000MHz were found more than 20dB below limit line.



<For WPC Charging Mode>

CDMA BC10									
Channel	Frequency (MHz)	ERP (dBm)	Limit (dBm)	Over Limit (dB)	SPA Reading (dBm)	S.G. Power (dBm)	TX Cable loss (dB)	TX Antenna Gain (dBi)	Polarization (H/V)
Lowest	1640	-61.33	-13	-48.33	-73.7	-63.11	0.97	4.91	H
	2456	-55.62	-13	-42.62	-73.22	-57.46	1.28	5.27	H
	3272	-57.69	-13	-44.69	-77.19	-61	1.53	7.00	H
	4088	-47.72	-13	-34.72	-68.6	-52.38	1.81	8.62	H
	1640	-60.51	-13	-47.51	-73.37	-62.29	0.97	4.91	V
	2456	-55.32	-13	-42.32	-73.18	-57.16	1.28	5.27	V
	3272	-55.83	-13	-42.83	-75.83	-59.14	1.53	7.00	V
	4088	-44.08	-13	-31.08	-65.05	-48.74	1.81	8.62	V
Middle	1640	-62.63	-13	-49.63	-75	-64.41	0.97	4.91	H
	2464	-56.28	-13	-43.28	-73.77	-58.14	1.28	5.29	H
	3280	-58.34	-13	-45.34	-77.81	-61.69	1.54	7.03	H
	4104	-44.72	-13	-31.72	-65.67	-49.37	1.82	8.62	H
	1640	-61.76	-13	-48.76	-74.58	-63.54	0.97	4.91	V
	2464	-54.81	-13	-41.81	-72.76	-56.67	1.28	5.29	V
	3280	-56.47	-13	-43.47	-76.25	-59.82	1.54	7.03	V
	4104	-46.37	-13	-33.37	-67.29	-51.02	1.82	8.62	V
Highest	1648	-62.11	-13	-49.11	-74.49	-63.87	0.98	4.89	H
	2472	-56.88	-13	-43.88	-74.45	-58.76	1.28	5.32	H
	3288	-57.84	-13	-44.84	-77.41	-61.22	1.54	7.07	H
	4120	-47.11	-13	-34.11	-67.94	-51.75	1.83	8.62	H
	1648	-59.82	-13	-46.82	-72.77	-61.58	0.98	4.89	V
	2472	-55.75	-13	-42.75	-73.72	-57.63	1.28	5.32	V
	3288	-56.62	-13	-43.62	-76.5	-60	1.54	7.07	V
	4120	-47.53	-13	-34.53	-68.58	-52.17	1.83	8.62	V

Remark: Spurious emissions within 30-1000MHz were found more than 20dB below limit line.

—————THE END—————