



# SPORTON International Inc.

No. 52, Hwa Ya 1st Rd., Hwa Ya Technology Park, Kwei-Shan Hsiang, Tao Yuan Hsien, Taiwan, R.O.C.  
Ph: 886-3-327-3456 / FAX: 886-3-327-0973 / www.sporton.com.tw

## FCC RADIO TEST REPORT

Applicant's company	Google Inc.
Applicant Address	1600 Amphitheater Parkway, Mountain View, CA 94043
FCC ID	A4RAC-1304
Manufacturer's company	Wistron NeWeb Corporation
Manufacturer Address	20 Park Ave. II, Hsinchu Science Park, Hsinchu 308, Taiwan

Product Name	Dual band WiFi Router
Brand Name	Google
Model Name	AC-1304
Test Rule	47 CFR FCC Part 15 Subpart C § 15.247
Test Freq. Range	2402 ~ 2480MHz
Received Date	Sep. 14, 2016
Final Test Date	Mar. 22, 2017
Submission Type	Original Equipment

### Statement

**Test result included is only for the Bluetooth BR/EDR of the product.**

The test result in this report refers exclusively to the presented test model / sample.

Without written approval of SPORTON International Inc., the test report shall not be reproduced except in full.

The measurements and test results shown in this test report were made in accordance with the procedures and found in compliance with the limit given in **ANSI C63.10-2013, DA-00705** and **47 CFR FCC Part 15 Subpart C**.

The test equipment used to perform the test is calibrated and traceable to NML/ROC.



## Table of Contents

<b>1. VERIFICATION OF COMPLIANCE</b> .....	<b>1</b>
<b>2. SUMMARY OF THE TEST RESULT</b> .....	<b>2</b>
<b>3. GENERAL INFORMATION</b> .....	<b>3</b>
3.1. Product Details.....	3
3.2. Accessories.....	3
3.3. Table for Filed Antenna.....	4
3.4. Table for Carrier Frequencies .....	4
3.5. Table for Test Modes .....	5
3.6. Table for Testing Locations.....	6
3.7. Table for EUT Type Listing .....	6
3.8. Table for Supporting Units .....	7
3.9. Table for Parameters of Test Software Setting .....	8
3.10. EUT Operation during Test .....	8
3.11. Duty Cycle.....	8
3.12. Test Configurations .....	9
<b>4. TEST RESULT</b> .....	<b>12</b>
4.1. AC Power Line Conducted Emissions Measurement.....	12
4.2. Maximum Conducted Output Power Measurement.....	20
4.3. Hopping Channel Separation Measurement .....	22
4.4. Number of Hopping Frequency Measurement.....	33
4.5. Dwell Time Measurement.....	35
4.6. Radiated Emissions Measurement .....	42
4.7. Emissions Measurement .....	59
4.8. Antenna Requirements .....	77
<b>5. LIST OF MEASURING EQUIPMENTS</b> .....	<b>78</b>
<b>6. MEASUREMENT UNCERTAINTY</b> .....	<b>80</b>
<b>TEST PHOTO OF EUT</b>	
<b>PHOTOGRAPHS OF EUT V01</b>	



## History of This Test Report

REPORT NO.	VERSION	DESCRIPTION	ISSUED DATE
FR690910-03AC	Rev. 01	Initial issue of report	Apr. 12, 2017

## 1. VERIFICATION OF COMPLIANCE

Product Name : Dual band WiFi Router  
Brand Name : Google  
Model No. : AC-1304  
Applicant : Google Inc.  
Test Rule Part(s) : 47 CFR FCC Part 15 Subpart C § 15.247

Sporton International as requested by the applicant to evaluate the EMC performance of the product sample received on Sep. 14, 2016 would like to declare that the tested sample has been evaluated and found to be in compliance with the tested rule parts. The data recorded as well as the test configuration specified is true and accurate for showing the sample's EMC nature.



Cliff Chang  
SPORTON INTERNATIONAL INC.

## 2. SUMMARY OF THE TEST RESULT

Applied Standard: 47 CFR FCC Part 15 Subpart C			
Part	Rule Section	Description of Test	Result
4.1	15.207	AC Power Line Conducted Emissions	Complies
4.2	15.247(b)(1)	Maximum Conducted Output Power	Complies
4.3	15.247(a)(1)	Hopping Channel Separation	Complies
4.4	15.247(b)(1)	Number of Hopping Frequency	Complies
4.5	15.247(a)(1)	Dwell Time	Complies
4.6	15.247(d)	Radiated Emissions	Complies
4.7	15.247(d)	Band Edge Emissions	Complies
4.8	15.203	Antenna Requirements	Complies

Note: This application is for a new FCC ID by removing the Zigbee module from original case, FCC ID: A4RNLS-1304-25. Based on the validation results on the new case, there is no significant difference between original case and the new case. So, no tests performed above 1GHz RSE for the new case.

### 3. GENERAL INFORMATION

#### 3.1. Product Details

Items	Description
Power Type	From power adapter
Modulation	FHSS (GFSK / $\pi/4$ -DQPSK / 8DPSK)
Data Rate (Mbps)	GFSK: 1 ; $\pi/4$ -DQPSK: 2 ; 8DPSK: 3
Frequency Range	2402 ~ 2480MHz
Channel Number	79
Channel Bandwidth (99%)	BR (GFSK) 1 Mbps: 0.8769 MHz EDR ( $\pi/4$ -DQPSK) 2 Mbps: 1.1840 MHz EDR (8DPSK) 3 Mbps: 1.1900 MHz
Maximum Conducted Peak Output Power	BR (GFSK) 1 Mbps: 7.68 dBm EDR ( $\pi/4$ -DQPSK) 2 Mbps: 9.79 dBm EDR (8DPSK) 3 Mbps: 10.32 dBm
Maximum Conducted Average Output Power	BR (GFSK) 1 Mbps: 7.52 dBm EDR ( $\pi/4$ -DQPSK) 2 Mbps: 7.59 dBm EDR (8DPSK) 3 Mbps: 7.61 dBm
Carrier Frequencies	Please refer to section 3.4
Antenna	Please refer to section 3.3
Note 1: Bluetooth BR uses a combination of GFSK (1Mbps).	
Note 2: Bluetooth EDR uses a combination of $\pi/4$ -DQPSK (2Mbps) and 8DPSK (3Mbps).	

#### 3.2. Accessories

Power	Brand	Model	Rating
Adapter	Salcomp	GL0102	Input: 100-240V~50/60Hz, 0.4A Output: 5V, 3A
<b>Other</b>			
RJ-45 cable*1, Non-shielded, 2m			

### 3.3. Table for Filed Antenna

Ant.	Chain		Brand	Model No.	Antenna Type	Connector	Gain (dBi)		
	2.4 GHz	5 GHz					2.4 GHz	5 GHz	BT
1	1	2	WNC	N/A	LG material	I-PEX	3.53	4.56	-
2	2	-	WNC	N/A	LG material	I-PEX	3.53	-	-
3	-	1	WNC	N/A	LG material	I-PEX	-	4.56	-
4	3	-	WNC	N/A	LG material	I-PEX	-	-	5.46

Note: The EUT has four antennas.

#### For 2.4GHz function:

For IEEE 802.11b/g/n/ac mode (2TX/2RX):

Chain 1 and Chain 2 can be used as transmitting/receiving antenna.

Chain 1 and Chain 2 could transmit/receive simultaneously.

#### For 5GHz function:

For IEEE 802.11a/n/ac mode (2TX/2RX):

Chain 1 and Chain 2 can be use as transmitting antenna.

Chain 1 and Chain 2 could transmit/receive simultaneously.

#### For Bluetooth function:

Only Chain 3 can be used as transmitting/receiving antenna.

### 3.4. Table for Carrier Frequencies

Frequency Band	Channel No.	Frequency	Channel No.	Frequency
2400~2483.5MHz	0	2402 MHz	40	2442 MHz
	1	2403 MHz	:	:
	:	:	77	2479 MHz
	38	2440 MHz	78	2480 MHz
	39	2441 MHz	-	-

### 3.5. Table for Test Modes

Preliminary tests were performed in different data rate to find the worst radiated emission. The data rate shown in the table below is the worst-case rate with respect to the specific test item. Investigation has been done on all the possible configurations for searching the worst cases. The following table is a list of the test modes shown in this test report.

Test Items	Mode	Data Rate	Channel	Chain
AC Power Conducted Emissions	Normal Link	-	-	-
Maximum Conducted Output Power	BR (GFSK)	1 Mbps	0/39/78	3
	EDR ( $\pi/4$ -DQPSK)	2 Mbps	0/39/78	3
	EDR (8DPSK)	3 Mbps	0/39/78	3
Hopping Channel Separation	BR (GFSK)	1 Mbps	0~1 39~40 77~78	3
	EDR ( $\pi/4$ -DQPSK)	2 Mbps	0~1 39~40 77~78	3
	EDR (8DPSK)	3 Mbps	0~1 39~40 77~78	3
Number of Hopping Frequency	EDR (8DPSK)	3 Mbps	0~78	3
Dwell Time	BR (GFSK) (DH1, DH3, DH5)	1 Mbps	0/39/78	3
Radiated Emissions Below 1GHz	Normal Link	-	-	-
Radiated Emissions Above 1GHz	BR (GFSK)	1 Mbps	0/39/78	3
	EDR (8DPSK)	3 Mbps	0/39/78	3
Band Edge Emissions	BR (GFSK)	1 Mbps	0/39/78	3
	EDR (8DPSK)	3 Mbps	0/39/78	3

Note1: The EUT can be used at Z-axis only.

Note2: There are three source for the EUT. It has influence for Conducted Emission and Radiated Emission (Below 1GHz). These three sources were tested. It has no influence for the others test and the EUT 1 was selected to test.

The following test modes were performed for all tests:

#### For Conducted Emission test:

Mode 1. Normal Link – PHY Main source + U2 second source (samsung)

Mode 2. Normal Link – PHY Second source + U2 second source (samsung)

Mode 3. Normal Link – PHY Main source + U2 main source (toshiba)



**For Radiated Emission test (Below 1GHz):**

Mode 1. Normal Link – PHY Main source + U2 second source (samsung)

Mode 2. Normal Link – PHY Second source + U2 second source (samsung)

Mode 3. Normal Link – PHY Main source + U2 main source (toshiba)

**For Radiated Emission test (Above 1GHz):**

Mode 1. CTX – PHY Main source + U2 second source (samsung)

**For Co-location MPE Test:**

The EUT could be applied with 2.4GHz/5GHz WLAN function and Bluetooth function; therefore Co-location Maximum Permissible Exposure (Please refer to FA690910-03) tests is added for simultaneously transmit among 2.4GHz/5GHz WLAN function and Bluetooth function.

**3.6. Table for Testing Locations**

Test Site Location					
Address:	No.8, Lane 724, Bo-ai St., Jhubei City, Hsinchu County 302, Taiwan, R.O.C.				
TEL:	886-3-656-9065				
FAX:	886-3-656-9085				
Test Site No.	Site Category	Location	FCC Designation No.	IC File No.	VCCI Reg. No
03CH01-CB	SAC	Hsin Chu	TW0006	IC 4086D	-
CO01-CB	Conduction	Hsin Chu	TW0006	IC 4086D	-
TH01-CB	OVEN Room	Hsin Chu	-	-	-

Open Area Test Site (OATS); Semi Anechoic Chamber (SAC).

**3.7. Table for EUT Type Listing**

The EUT has three types, which are identical to each other in all aspects except for the following table:

EUT	PHY	U2
EUT 1	Main source	Second source (samsung)
EUT 2	Second source	Second source (samsung)
EUT 3	Main source	Main source (toshiba)

The PHY and U2 detail information as below:

Source	Model Name
PHY Main source	QCA8072
PHY Second source	QCA8075
U2 main source	Toshiba EMMC, THGBMDG5D1LBAIT
U2 second source	Samsung EMMC, KLM4G1FEPD-B031

### 3.8. Table for Supporting Units

For Test Site No: 03CH01-CB / <Below 1GHz>

Support Unit	Brand	Model	FCC ID
NB*2	DELL	E4300	DoC
NB*2	Apple	Mac Book	DoC
iPad	Apple	A1430	DoC

For Test Site No: CO01-CB

Support Unit	Brand	Model	FCC ID
NB*4	DELL	E6430	DoC
iPad	Apple	A1430	DoC

For Test Site No: TH01-CB and 03CH01-CB / <Above 1GHz>

Support Unit	Brand	Model	FCC ID
NB	DELL	E4300	DoC

### 3.9. Table for Parameters of Test Software Setting

During testing, Channel and Power Controlling Software provided by the customer was used to control the operating channel as well as the output power level. The RF output power selection is for the setting of RF output power expected by the customer and is going to be fixed on the firmware of the final end product.

#### Power Parameters of Bluetooth

##### For BR (GFSK) 1 Mbps:

Test Software Version	Putty		
Frequency	2402 MHz	2441 MHz	2480 MHz
Power Parameters	8	8	8

##### For EDR ( $\pi/4$ -DQPSK) 2 Mbps:

Test Software Version	Putty		
Frequency	2402 MHz	2441 MHz	2480 MHz
Power Parameters	8	8	8

##### For EDR (8DPSK) 3 Mbps:

Test Software Version	Putty		
Frequency	2402 MHz	2441 MHz	2480 MHz
Power Parameters	8	8	8

### 3.10. EUT Operation during Test

The EUT was programmed to be in continuously transmitting mode.

### 3.11. Duty Cycle

Mode	On Time (ms)	On+Off Time (ms)	Duty Cycle (%)	Duty Factor (dB)	1/T Minimum VBW (kHz)
BR (GFSK)	2.899	3.754	77.22%	1.12	0.34
EDR ( $\pi/4$ -DQPSK)	2.913	3.754	77.61%	1.10	0.34
EDR (8DPSK)	2.841	3.754	75.68%	1.21	0.35

### 3.12. Test Configurations

#### 3.12.1. AC Power Line Conduction Emissions Test Configuration

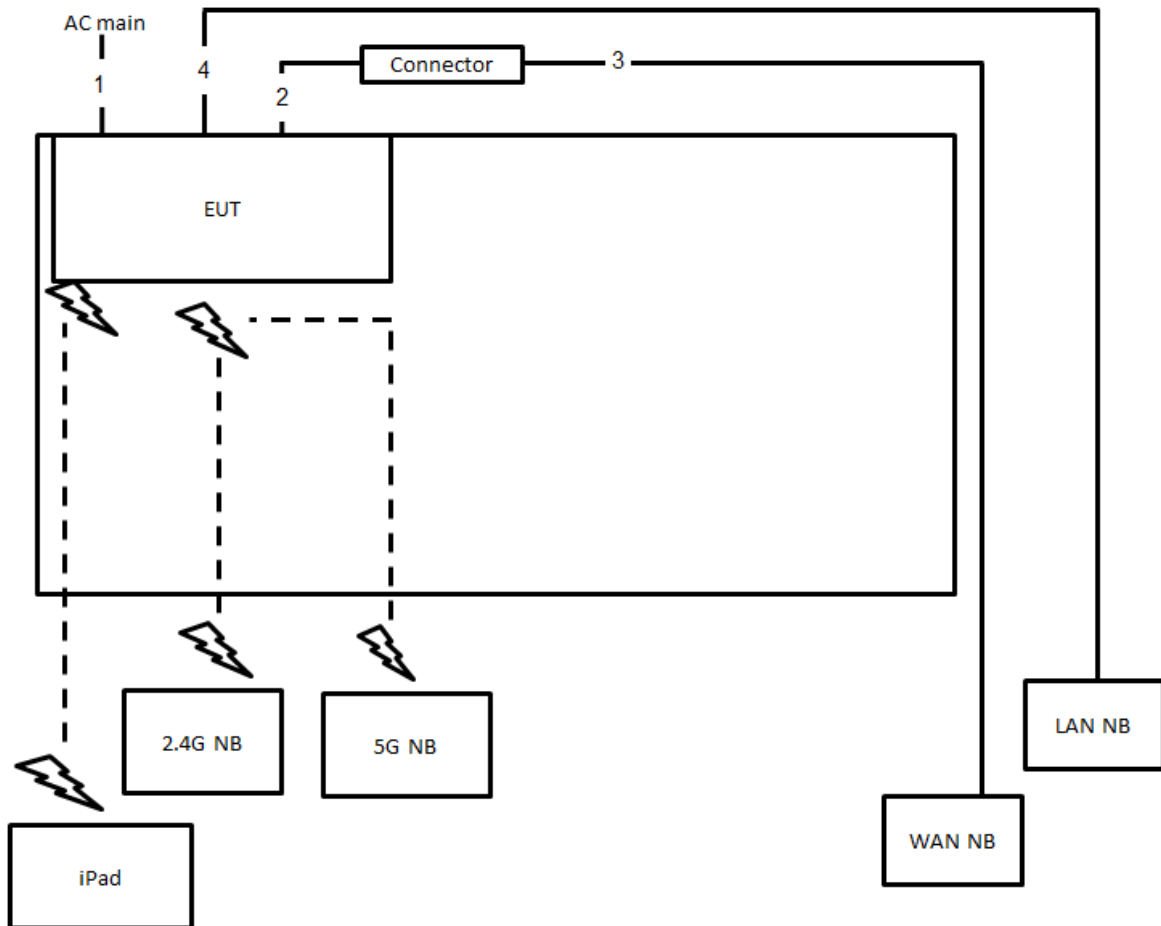

Item	Connection	Shielded	Length
1	Power cable	No	1.8m
2	RJ-45 cable	No	2m
3	RJ-45 cable	No	10m
4	RJ-45 cable	No	10m

### 3.12.2. Radiation Emissions Test Configuration

Test Configuration: 30MHz~1GHz

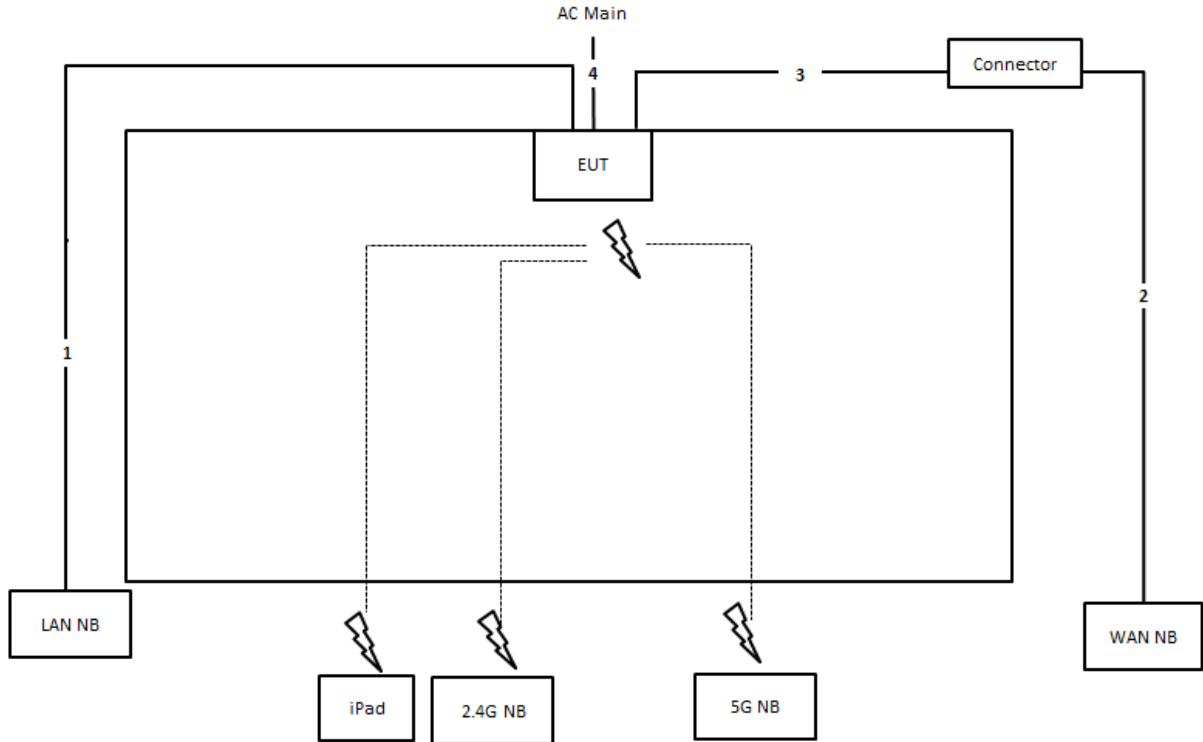

Item	Connection	Shielded	Length
1	RJ-45 cable	No	10m
2	RJ-45 cable	No	10m
3	RJ-45 cable	No	2m
4	Power cable	No	1.8m

Test Configuration: above 1GHz

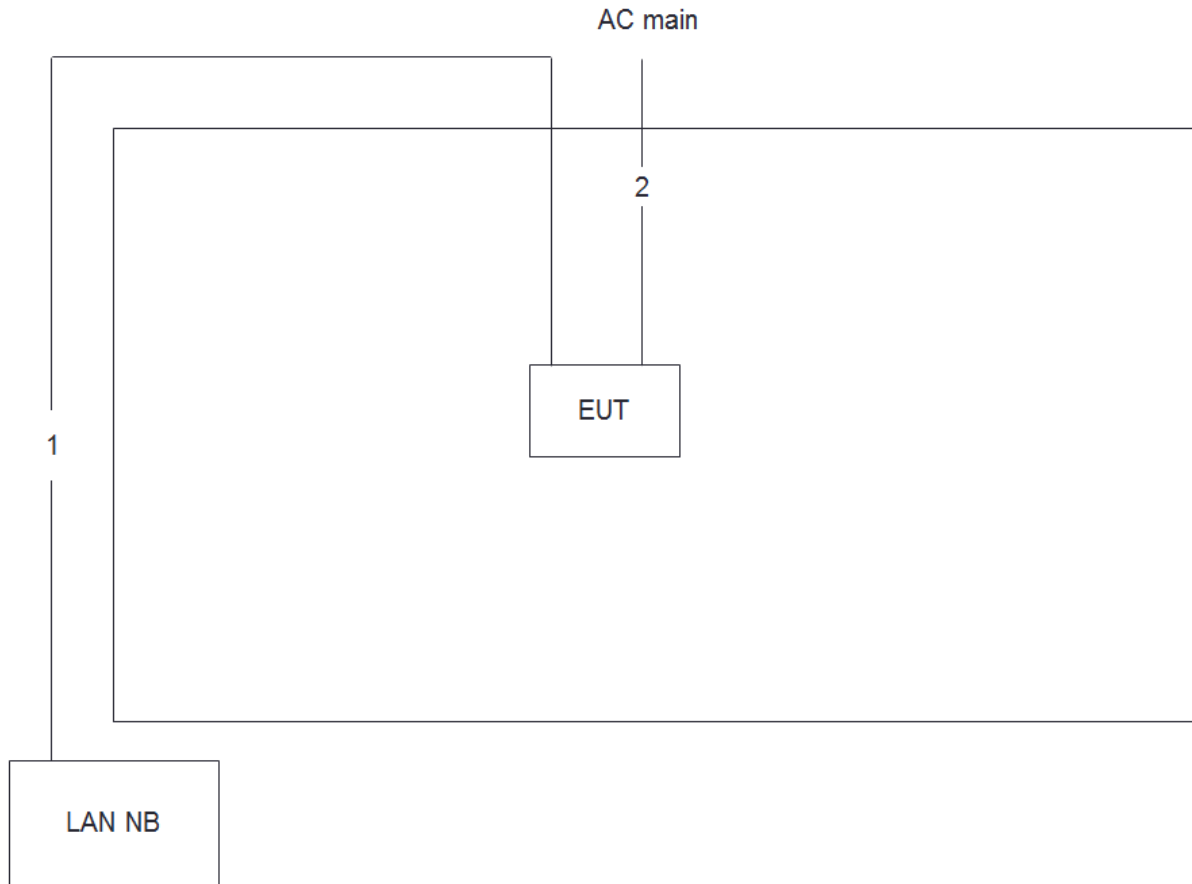

Item	Connection	Shielded	Length
1	RJ-45 cable	No	10m
2	Power cable	No	1.8m

## 4. TEST RESULT

### 4.1. AC Power Line Conducted Emissions Measurement

#### 4.1.1. Limit

For a Low-power Radio-frequency Device which is designed to be connected to the AC power line, the radio frequency voltage that is conducted back onto the AC power line on any frequency or frequencies within the band 150 kHz to 30 MHz shall not exceed below limits table.

Frequency (MHz)	QP Limit (dBuV)	AV Limit (dBuV)
0.15~0.5	66~56	56~46
0.5~5	56	46
5~30	60	50

#### 4.1.2. Measuring Instruments and Setting

Please refer to section 5 of equipments list in this report. The following table is the setting of the receiver.

Receiver Parameters	Setting
Attenuation	10 dB
Start Frequency	0.15 MHz
Stop Frequency	30 MHz
IF Bandwidth	9 kHz

#### 4.1.3. Test Procedures

1. Configure the EUT according to ANSI C63.10. The EUT or host of EUT has to be placed 0.4 meter far from the conducting wall of the shielding room and at least 80 centimeters from any other grounded conducting surface.
2. Connect EUT or host of EUT to the power mains through a line impedance stabilization network (LISN).
3. All the support units are connected to the other LISNs. The LISN should provide 50uH/50ohms coupling impedance.
4. The frequency range from 150 kHz to 30 MHz was searched.
5. Set the test-receiver system to Peak Detect Function and Specified Bandwidth with Maximum Hold Mode.
6. The measurement has to be done between each power line and ground at the power terminal.

#### 4.1.4. Test Setup Layout

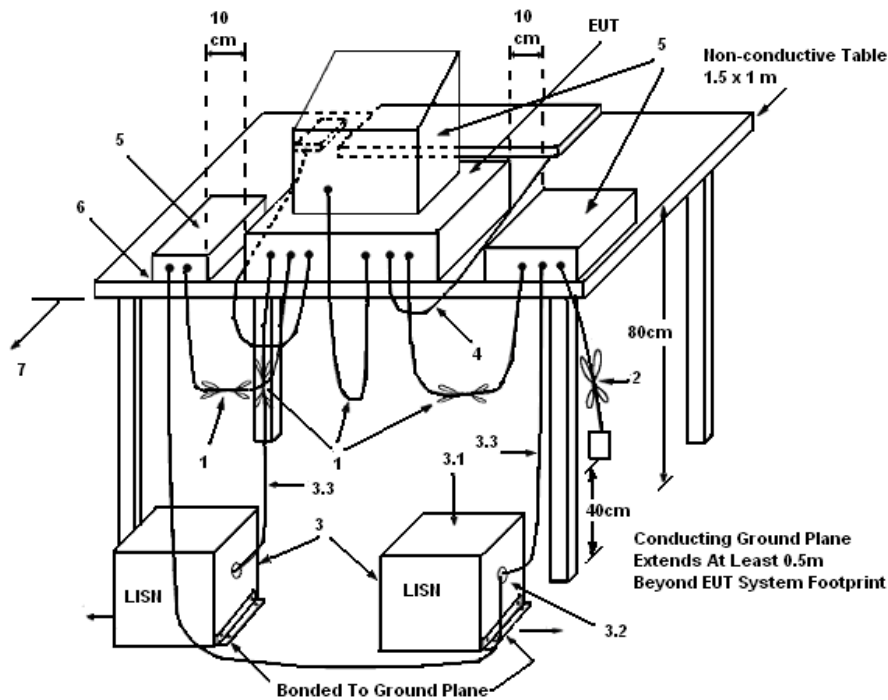

#### LEGEND:

- (1) Interconnecting cables that hang closer than 40 cm to the ground plane shall be folded back and forth in the center forming a bundle 30 to 40 cm long.
- (2) I/O cables that are not connected to a peripheral shall be bundled in the center. The end of the cable may be terminated, if required, using the correct terminating impedance. The overall length shall not exceed 1 m.
- (3) EUT connected to one LISN. Unused LISN measuring port connectors shall be terminated in 50  $\Omega$ . LISN can be placed on top of, or immediately beneath, reference ground plane.
  - (3.1) All other equipment powered from additional LISN(s).
  - (3.2) Multiple outlet strip can be used for multiple power cords of non-EUT equipment.
  - (3.3) LISN at least 80 cm from nearest part of EUT chassis.
- (4) Cables of hand-operated devices, such as keyboards, mice, etc., shall be placed as for normal use.
- (5) Non-EUT components of EUT system being tested.
- (6) Rear of EUT, including peripherals, shall all be aligned and flush with rear of tabletop.
- (7) Rear of tabletop shall be 40 cm removed from a vertical conducting plane that is bonded to the ground plane.

#### 4.1.5. Test Deviation

There is no deviation with the original standard.

#### 4.1.6. EUT Operation during Test

The EUT was placed on the test table and programmed in normal function.



4.1.7. Results of AC Power Line Conducted Emissions Measurement

Temperature	22°C	Humidity	57%
Test Engineer	Deven Huang	Phase	Line
Configuration	Normal Link		
Test Mode	Mode 1 / PHY main source + U2 second source (Samsung)		

Line

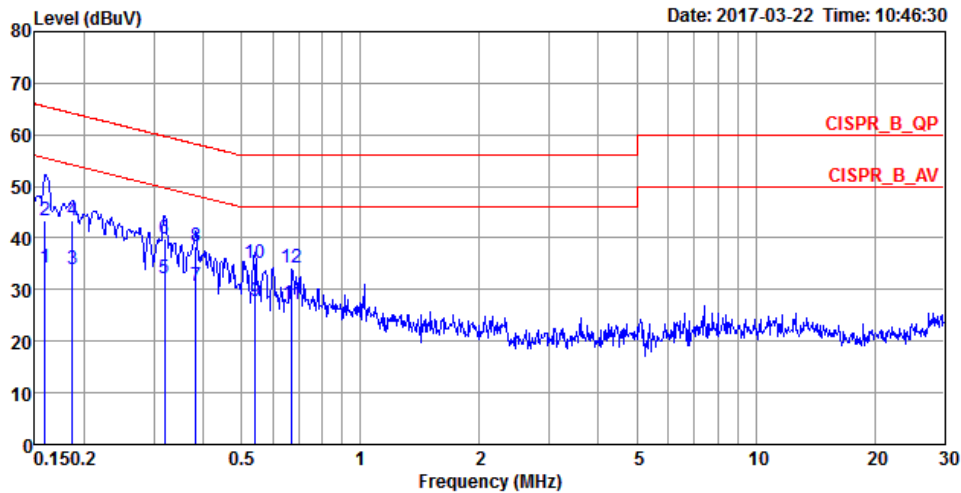

	Freq	Level	Over Limit	Limit Line	Read Level	LISN Factor	Cable Loss	Remark	Pol/Phase
	MHz	dBuV	dB	dBuV	dBuV	dB	dB		
1	0.1590	34.24	-21.28	55.52	24.07	10.00	0.17	Average	LINE
2	0.1590	43.50	-22.02	65.52	33.33	10.00	0.17	QP	LINE
3	0.1864	33.94	-20.26	54.20	23.85	9.91	0.18	Average	LINE
4	0.1864	43.27	-20.93	64.20	33.18	9.91	0.18	QP	LINE
5	0.3200	32.10	-17.61	49.71	22.10	9.93	0.07	Average	LINE
6	0.3200	39.91	-19.80	59.71	29.91	9.93	0.07	QP	LINE
7	0.3832	30.62	-17.59	48.21	20.66	9.94	0.02	Average	LINE
8	0.3832	38.27	-19.94	58.21	28.31	9.94	0.02	QP	LINE
9	0.5407	27.81	-18.19	46.00	17.61	9.95	0.25	Average	LINE
10	0.5407	35.27	-20.73	56.00	25.07	9.95	0.25	QP	LINE
11	0.6719	27.15	-18.85	46.00	16.78	9.95	0.42	Average	LINE
12	0.6719	34.16	-21.84	56.00	23.79	9.95	0.42	QP	LINE

Temperature	22°C	Humidity	57%
Test Engineer	Deven Huang	Phase	Neutral
Configuration	Normal Link		
Test Mode	Mode 1 / PHY main source + U2 second source (Samsung)		

## Neutral

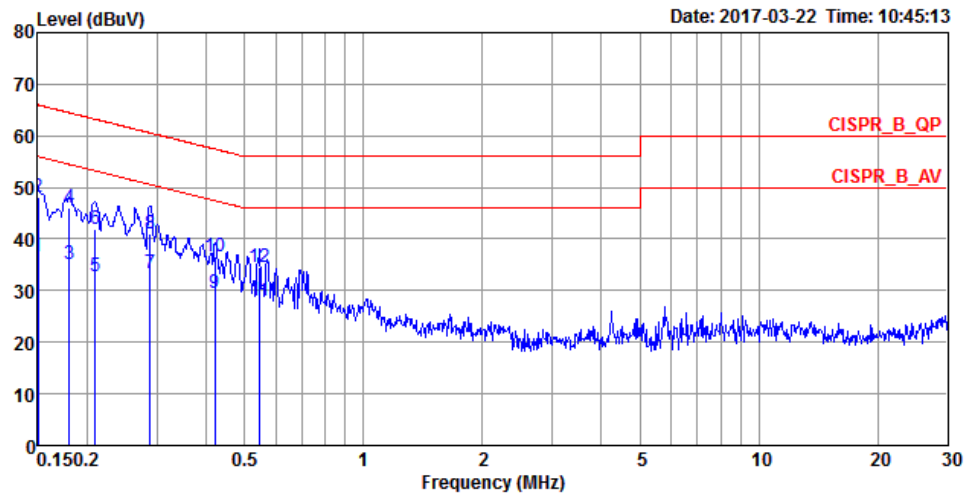

	Freq	Level	Over Limit	Limit Line	Read Level	LISN Factor	Cable Loss	Remark	Pol/Phase
	MHz	dBuV	dB	dBuV	dBuV	dB	dB		
1	0.1500	36.63	-19.37	56.00	26.37	10.10	0.16	Average	NEUTRAL
2	0.1500	48.25	-17.75	66.00	37.99	10.10	0.16	QP	NEUTRAL
3	0.1806	35.17	-19.29	54.46	24.98	10.01	0.18	Average	NEUTRAL
4	0.1806	46.20	-18.26	64.46	36.01	10.01	0.18	QP	NEUTRAL
5	0.2094	32.70	-20.53	53.23	22.47	10.05	0.18	Average	NEUTRAL
6	0.2094	41.83	-21.40	63.23	31.60	10.05	0.18	QP	NEUTRAL
7	0.2878	33.26	-17.33	50.59	23.04	10.12	0.10	Average	NEUTRAL
8	0.2878	41.02	-19.57	60.59	30.80	10.12	0.10	QP	NEUTRAL
9	0.4215	29.53	-17.89	47.42	19.23	10.25	0.05	Average	NEUTRAL
10	0.4215	36.56	-20.86	57.42	26.26	10.25	0.05	QP	NEUTRAL
11	0.5464	27.95	-18.05	46.00	17.48	10.21	0.26	Average	NEUTRAL
12	0.5464	34.54	-21.46	56.00	24.07	10.21	0.26	QP	NEUTRAL

Note: Level = Read Level + LISN Factor + Cable Loss.

Temperature	22°C	Humidity	57%
Test Engineer	Deven Huang	Phase	Line
Configuration	Normal Link		
Test Mode	Mode 2 / PHY second source + U2 second source (Samsung)		

## Line

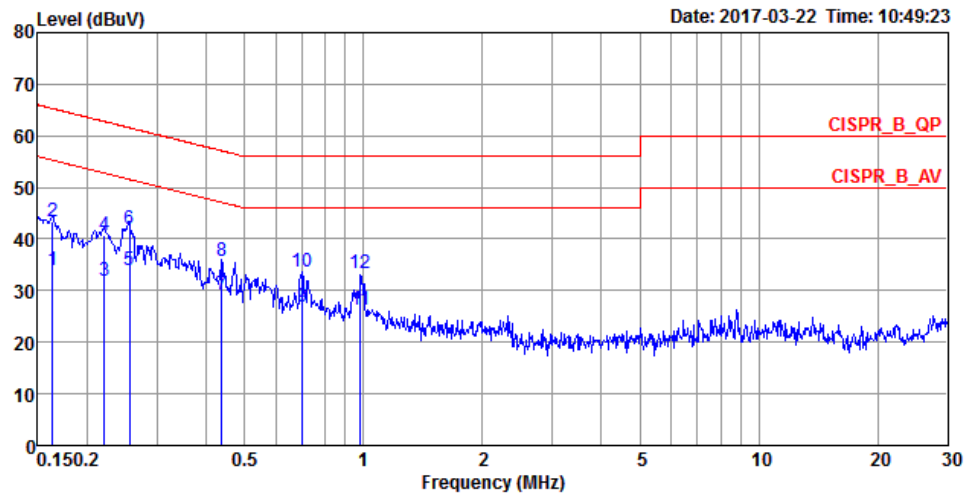

	Freq	Level	Over	Limit	Read	LISN	Cable	Remark	Pol/Phase
	MHz	dBuV	Limit	Line	Level	Factor	Loss		
			dB	dBuV	dBuV	dB	dB		
1	0.1633	34.04	-21.26	55.30	23.87	10.00	0.17	Average	LINE
2	0.1633	43.25	-22.05	65.30	33.08	10.00	0.17	QP	LINE
3	0.2208	31.78	-21.01	52.79	21.70	9.92	0.16	Average	LINE
4	0.2208	40.71	-22.08	62.79	30.63	9.92	0.16	QP	LINE
5	0.2562	33.97	-17.59	51.56	23.92	9.92	0.13	Average	LINE
6	0.2562	42.06	-19.50	61.56	32.01	9.92	0.13	QP	LINE
7	0.4374	29.25	-17.86	47.11	19.22	9.95	0.08	Average	LINE
8	0.4374	35.75	-21.36	57.11	25.72	9.95	0.08	QP	LINE
9	0.7010	26.85	-19.15	46.00	16.44	9.95	0.46	Average	LINE
10	0.7010	33.78	-22.22	56.00	23.37	9.95	0.46	QP	LINE
11	0.9839	26.40	-19.60	46.00	15.71	9.96	0.73	Average	LINE
12	0.9839	33.28	-22.72	56.00	22.59	9.96	0.73	QP	LINE

Temperature	22°C	Humidity	57%
Test Engineer	Deven Huang	Phase	Neutral
Configuration	Normal Link	Test Mode	Mode 2
Test Mode	Mode 2 / PHY second source + U2 second source (Samsung)		

Neutral

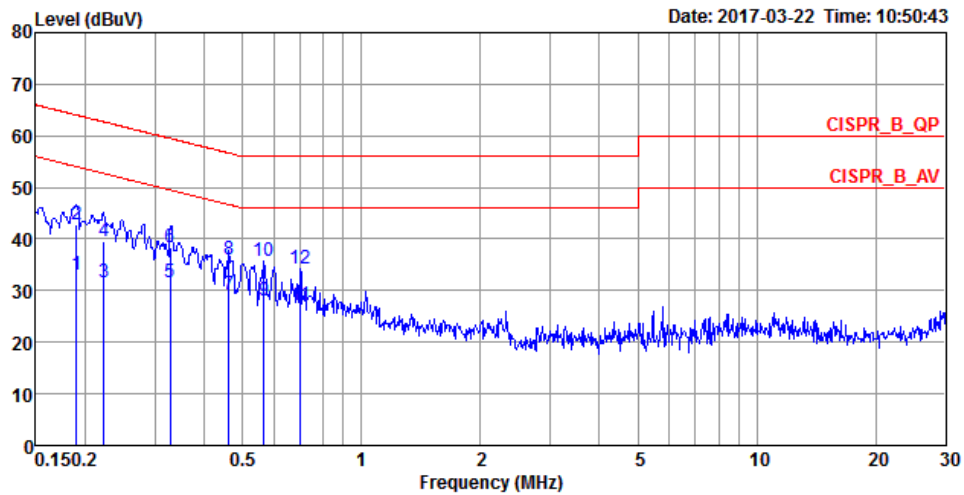

	Freq	Level	Over Limit	Limit Line	Read Level	LISN Factor	Cable Loss	Remark	PoI/Phase
	MHz	dBuV	dB	dBuV	dBuV	dB	dB		
1	0.1904	33.01	-21.01	54.02	22.81	10.01	0.19	Average	NEUTRAL
2	0.1904	42.86	-21.16	64.02	32.66	10.01	0.19	QP	NEUTRAL
3	0.2232	31.71	-20.99	52.70	21.50	10.05	0.16	Average	NEUTRAL
4	0.2232	39.52	-23.18	62.70	29.31	10.05	0.16	QP	NEUTRAL
5	0.3286	31.70	-17.79	49.49	21.45	10.19	0.06	Average	NEUTRAL
6	0.3286	38.50	-20.99	59.49	28.25	10.19	0.06	QP	NEUTRAL
7	0.4612	29.19	-17.48	46.67	18.83	10.24	0.12	Average	NEUTRAL
8	0.4612	35.91	-20.76	56.67	25.55	10.24	0.12	QP	NEUTRAL
9	0.5671	28.02	-17.98	46.00	17.53	10.20	0.29	Average	NEUTRAL
10	0.5671	35.57	-20.43	56.00	25.08	10.20	0.29	QP	NEUTRAL
11	0.7010	27.05	-18.95	46.00	16.43	10.16	0.46	Average	NEUTRAL
12	0.7010	34.29	-21.71	56.00	23.67	10.16	0.46	QP	NEUTRAL

Temperature	22°C	Humidity	57%
Test Engineer	Deven Huang	Phase	Line
Configuration	Normal Link		
Test Mode	Mode 3 / PHY main source + U2 main source (toshiba)		

Line

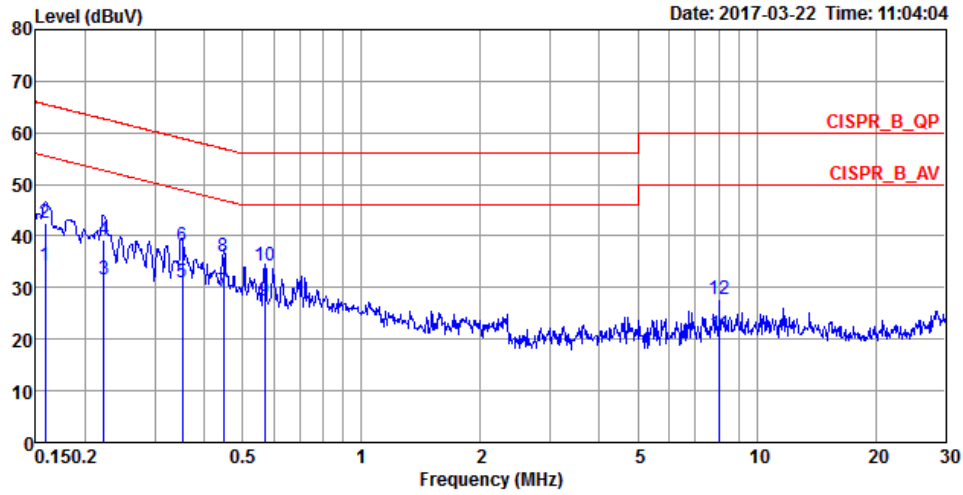

	Freq	Level	Over Limit	Limit Line	Read Level	LISN Factor	Cable Loss	Remark	Pol/Phase
	MHz	dBuV	dB	dBuV	dBuV	dB	dB		
1	0.1582	34.22	-21.34	55.56	24.05	10.00	0.17	Average	LINE
2	0.1582	42.47	-23.09	65.56	32.30	10.00	0.17	QP	LINE
3	0.2232	31.69	-21.01	52.70	21.61	9.92	0.16	Average	LINE
4	0.2232	39.31	-23.39	62.70	29.23	9.92	0.16	QP	LINE
5	0.3520	31.03	-17.88	48.91	21.05	9.94	0.04	Average	LINE
6	0.3520	38.19	-20.72	58.91	28.21	9.94	0.04	QP	LINE
7	0.4468	29.18	-17.75	46.93	19.14	9.95	0.09	Average	LINE
8	0.4468	35.91	-21.02	56.93	25.87	9.95	0.09	QP	LINE
9	0.5701	27.56	-18.44	46.00	17.32	9.95	0.29	Average	LINE
10	0.5701	34.30	-21.70	56.00	24.06	9.95	0.29	QP	LINE
11	8.0624	20.97	-29.03	50.00	10.75	10.08	0.14	Average	LINE
12	8.0624	27.77	-32.23	60.00	17.55	10.08	0.14	QP	LINE

Temperature	22°C	Humidity	57%
Test Engineer	Deven Huang	Phase	Neutral
Configuration	Normal Link		
Test Mode	Mode 3 / PHY main source + U2 main source (toshiba)		

Neutral

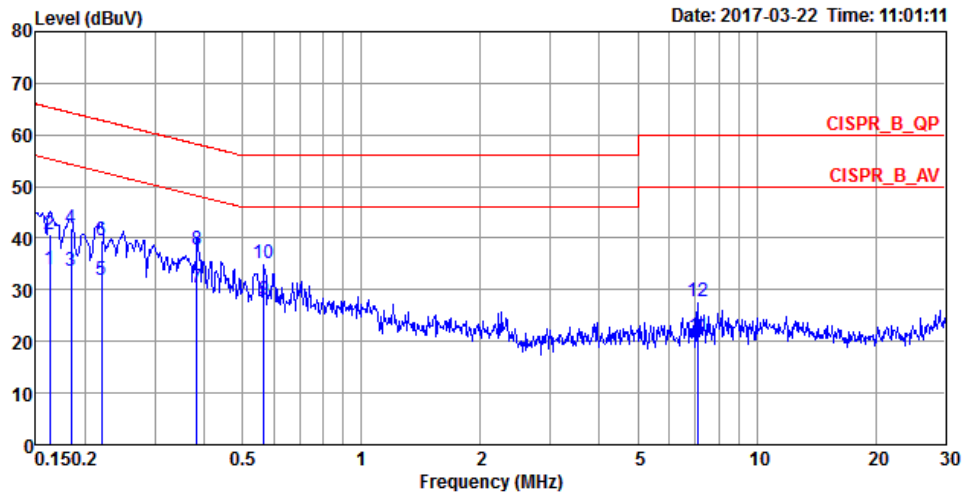

	Freq	Level	Over Limit	Limit Line	Read Level	LISN Factor	Cable Loss	Remark	Pol/Phase
	MHz	dBuV	dB	dBuV	dBuV	dB	dB		
1	0.1624	33.90	-21.44	55.34	23.63	10.10	0.17	Average	NEUTRAL
2	0.1624	40.67	-24.67	65.34	30.40	10.10	0.17	QP	NEUTRAL
3	0.1844	33.51	-20.77	54.28	23.32	10.01	0.18	Average	NEUTRAL
4	0.1844	41.91	-22.37	64.28	31.72	10.01	0.18	QP	NEUTRAL
5	0.2197	31.90	-20.93	52.83	21.69	10.05	0.16	Average	NEUTRAL
6	0.2197	39.58	-23.25	62.83	29.37	10.05	0.16	QP	NEUTRAL
7	0.3832	30.52	-17.69	48.21	20.28	10.22	0.02	Average	NEUTRAL
8	0.3832	37.72	-20.49	58.21	27.48	10.22	0.02	QP	NEUTRAL
9	0.5671	28.04	-17.96	46.00	17.55	10.20	0.29	Average	NEUTRAL
10	0.5671	35.07	-20.93	56.00	24.58	10.20	0.29	QP	NEUTRAL
11	7.0997	20.93	-29.07	50.00	10.72	10.08	0.13	Average	NEUTRAL
12	7.0997	27.64	-32.36	60.00	17.43	10.08	0.13	QP	NEUTRAL

## 4.2. Maximum Conducted Output Power Measurement

### 4.2.1. Limit

For frequency hopping systems operating in the 2400-2483.5 MHz band employing at least 75 non-overlapping hopping channels, the limit for peak output power is 1Watt (30dBm). For all other frequency hopping systems in the 2400-2483.5 MHz band: 0.125 watts (21dBm).

### 4.2.2. Measuring Instruments and Setting

Please refer to section 5 of equipments list in this report. The following table is the setting of the power meter.

Power Meter Parameter	Setting
Bandwidth	50MHz bandwidth is greater than the EUT emission bandwidth
Detector	Peak and Average

### 4.2.3. Test Procedures

This procedure provides an alternative for determining the RMS output power using a broadband RF average power meter with a thermocouple detector.

### 4.2.4. Test Setup Layout

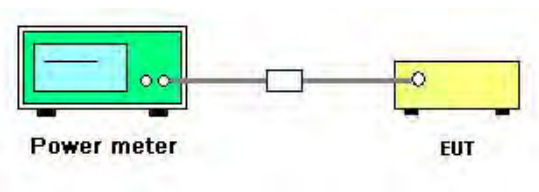

### 4.2.5. Test Deviation

There is no deviation with the original standard.

### 4.2.6. EUT Operation during Test

The EUT was programmed to be in continuously transmitting mode.

#### 4.2.7. Test Result of Maximum Conducted Output Power

Temperature	22°C	Humidity	54%
Test Engineer	Wen Chao	Configurations	GFSK, $\pi/4$ -DQPSK, 8DPSK
Test Date	Sep. 14, 2016 ~ Oct. 06, 2016		

##### For BR (GFSK) 1 Mbps:

Channel	Frequency	Conducted Peak Power (dBm)	Conducted Average Power (dBm)	Max. Limit (dBm)	Result
0	2402 MHz	6.32	6.12	21.00	Complies
39	2441 MHz	6.75	6.56	21.00	Complies
78	2480 MHz	7.68	7.52	21.00	Complies

##### For EDR ( $\pi/4$ -DQPSK) 2 Mbps:

Channel	Frequency	Conducted Peak Power (dBm)	Conducted Average Power (dBm)	Max. Limit (dBm)	Result
0	2402 MHz	8.59	6.25	21.00	Complies
39	2441 MHz	8.96	6.71	21.00	Complies
78	2480 MHz	9.79	7.59	21.00	Complies

##### For EDR (8DPSK) 3 Mbps:

Channel	Frequency	Conducted Peak Power (dBm)	Conducted Average Power (dBm)	Max. Limit (dBm)	Result
0	2402 MHz	9.02	6.25	21.00	Complies
39	2441 MHz	9.47	6.69	21.00	Complies
78	2480 MHz	10.32	7.61	21.00	Complies



### 4.3. Hopping Channel Separation Measurement

#### 4.3.1. Limit

Frequency hopping systems shall have hopping channel carrier frequencies separated by a minimum of 25 kHz or the 20 dB bandwidth of the hopping channel, whichever is greater. Alternatively, frequency hopping systems operating in the 2400-2483.5 MHz band may have hopping channel carrier frequencies that are separated by 25 kHz or two-thirds of the 20 dB bandwidth of the hopping channel, whichever is greater.

#### 4.3.2. Measuring Instruments and Setting

Please refer to section 5 of equipments list in this report. The following table is the setting of spectrum analyzer.

Spectrum Parameter	Setting
Attenuation	Auto
Span Frequency	> Measurement Bandwidth or Channel Separation
RBW	30 kHz (20dB Bandwidth) / 100 kHz (Channel Separation)
VBW	100 kHz (20dB Bandwidth) / 100 kHz (Channel Separation)
Detector	Peak
Trace	Max Hold
Sweep Time	Auto

#### 4.3.3. Test Procedures

1. The transmitter output (antenna port) was connected to the spectrum analyzer in peak hold mode.
2. The resolution bandwidth of 30 kHz and the video bandwidth of 100 kHz were utilized for 20 dB bandwidth measurement.
3. The resolution bandwidth of 100 kHz and the video bandwidth of 100 kHz were utilized for channel separation measurement.

#### 4.3.4. Test Setup Layout

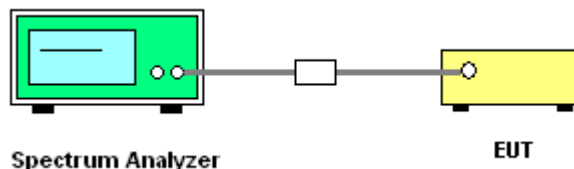

#### 4.3.5. Test Deviation

There is no deviation with the original standard.

#### 4.3.6. EUT Operation during Test

The EUT was programmed to be in continuously transmitting mode.

#### 4.3.7. Test Result of Hopping Channel Separation

Temperature	22°C	Humidity	54%
Test Engineer	Wen Chao	Configurations	GFSK, $\pi/4$ -DQPSK, 8DPSK

For BR (GFSK) 1 Mbps:

Frequency	20dB Bandwidth (MHz)	99% Occupied Bandwidth (MHz)	Ch. Separation (MHz)	Two-Thirds of 20dB Bandwidth (MHz)	Result
2402 MHz	0.9391	0.8769	1.00	0.626	Complies
2441 MHz	0.9275	0.8654	1.00	0.618	Complies
2480 MHz	0.9362	0.8712	1.00	0.624	Complies

Ch. Separation Limits: >20dB bandwidth or > Two-Thirds of 20dB bandwidth

For EDR ( $\pi/4$ -DQPSK) 2 Mbps:

Frequency	20dB Bandwidth (MHz)	99% Occupied Bandwidth (MHz)	Ch. Separation (MHz)	Two-Thirds of 20dB Bandwidth (MHz)	Result
2402 MHz	1.2750	1.1780	1.00	0.850	Complies
2441 MHz	1.2810	1.1720	1.00	0.854	Complies
2480 MHz	1.2780	1.1840	1.00	0.852	Complies

Ch. Separation Limits: >20dB bandwidth or > Two-Thirds of 20dB bandwidth

For EDR (8DPSK) 3 Mbps:

Frequency	20dB Bandwidth (MHz)	99% Occupied Bandwidth (MHz)	Ch. Separation (MHz)	Two-Thirds of 20dB Bandwidth (MHz)	Result
2402 MHz	1.2960	1.1780	1.00	0.864	Complies
2441 MHz	1.2840	1.1750	1.00	0.856	Complies
2480 MHz	1.2960	1.1900	1.00	0.864	Complies

Ch. Separation Limits: >20dB bandwidth or > Two-Thirds of 20dB bandwidth

20 dB Bandwidth Plot on BR (GFSK) 1 Mbps / Channel 0 / 2402 MHz

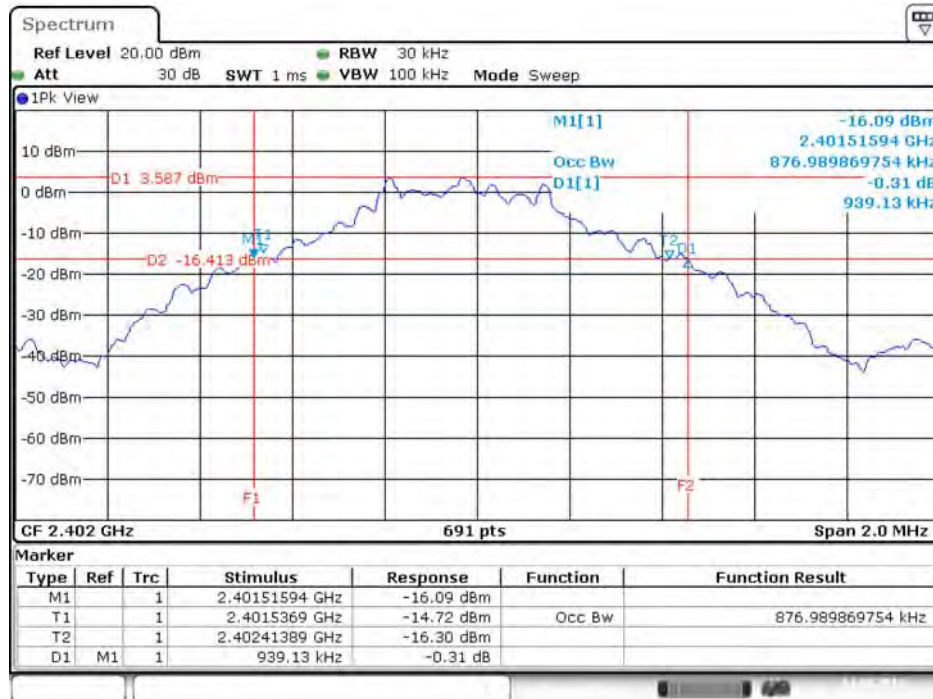

20 dB Bandwidth Plot on BR (GFSK) 1 Mbps / Channel 39 / 2441 MHz

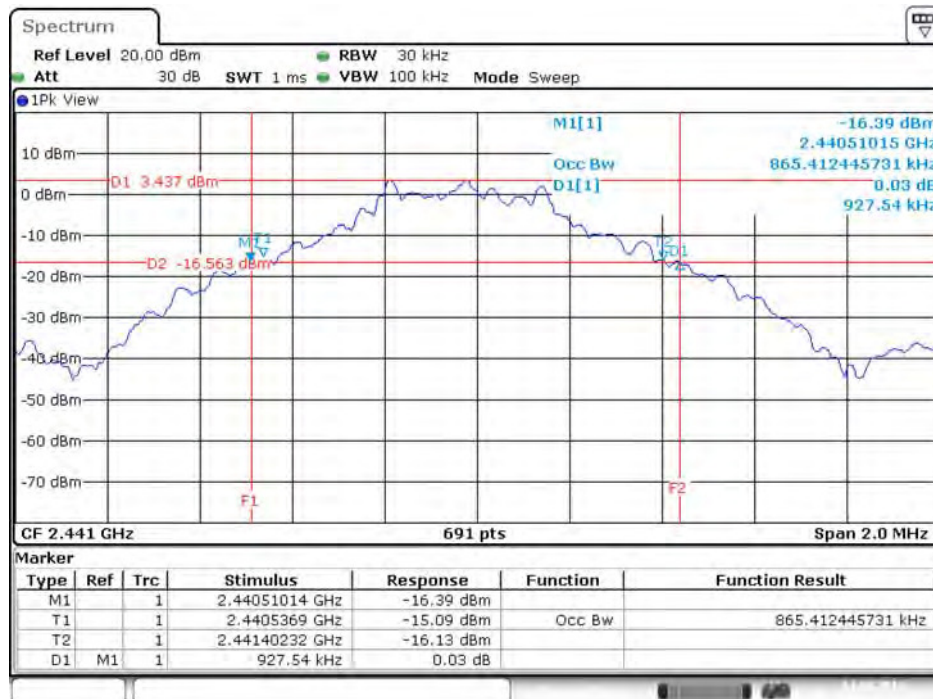

20 dB Bandwidth Plot on BR (GFSK) 1 Mbps / Channel 78 / 2480 MHz

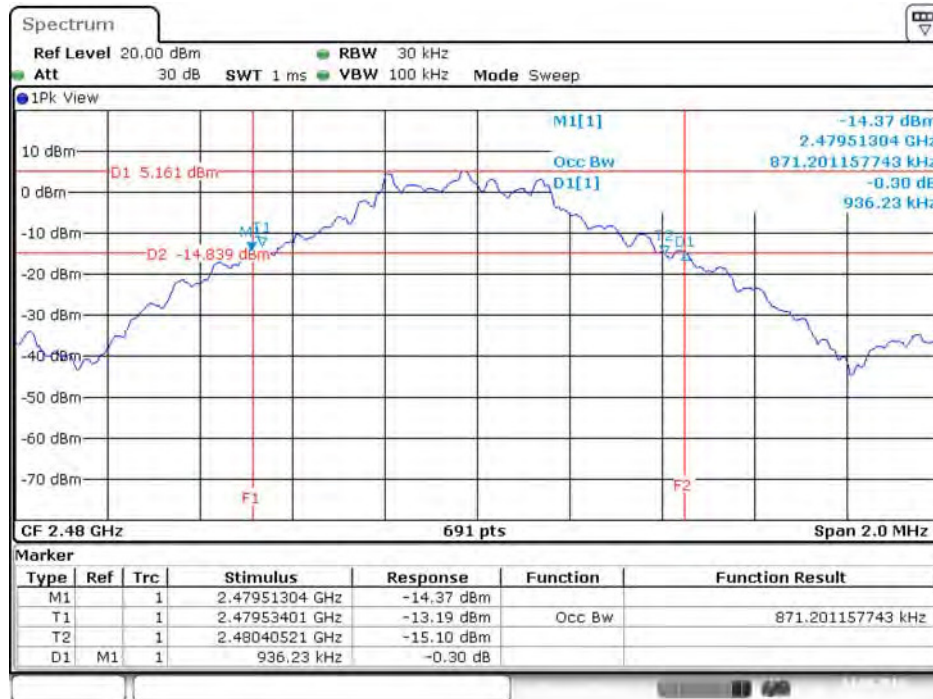

Date: 14.SEP.2016 19:58:44

Channel Separation Plot on BR (GFSK) 1 Mbps / Channel 0~1 / 2402 MHz ~ 2403 MHz

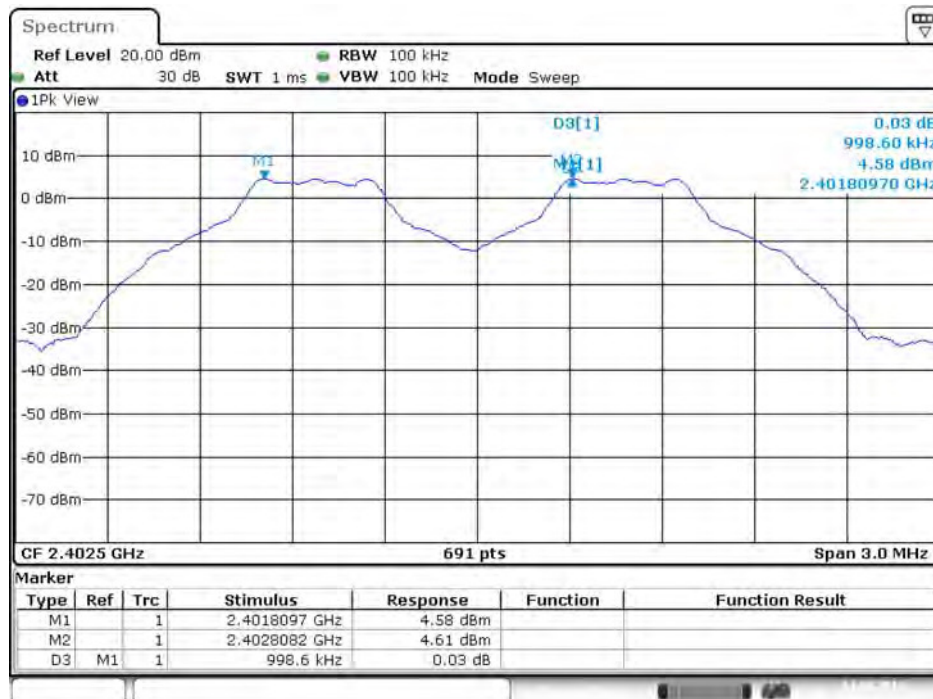

Date: 14.SEP.2016 21:51:37

Channel Separation Plot on BR (GFSK) 1 Mbps / Channel 39~40 / 2441 MHz ~ 2442 MHz

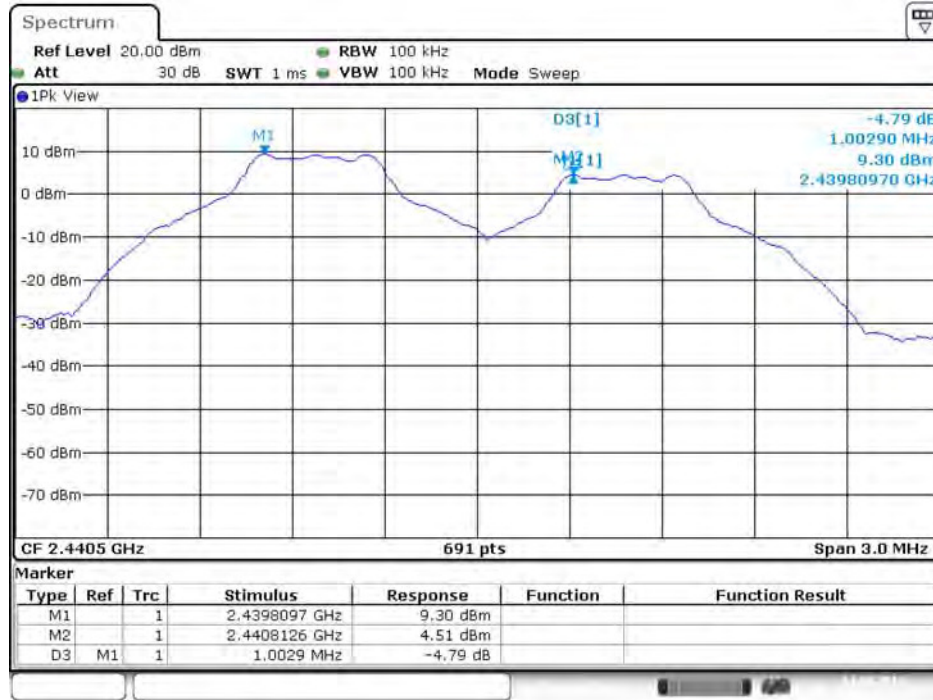

Date: 14.SEP.2016 21:52:51

Channel Separation Plot on BR (GFSK) 1 Mbps / Channel 77~78 / 2479 MHz ~ 2480 MHz

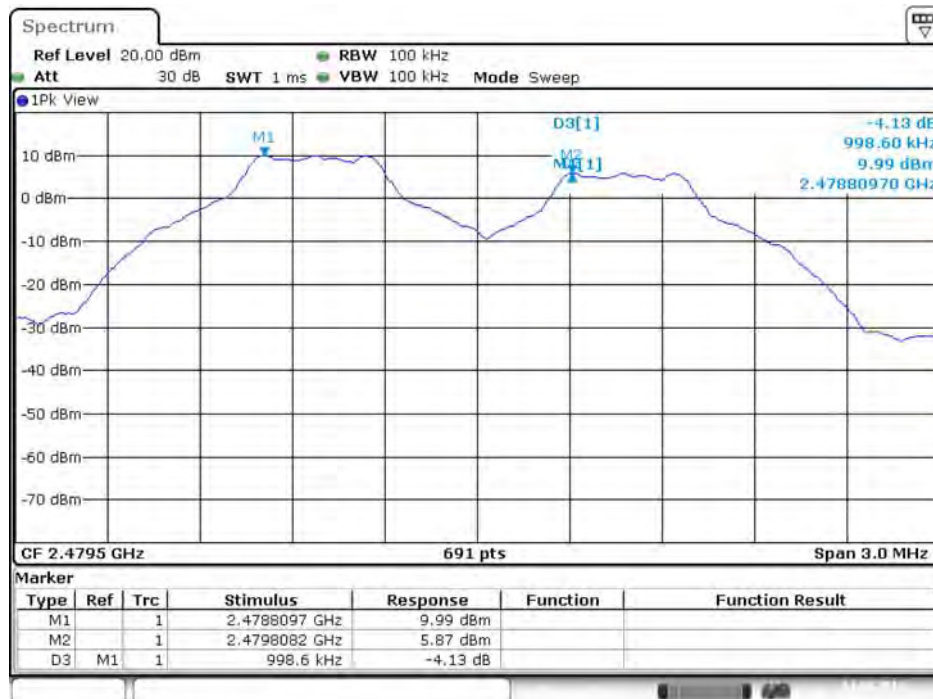

Date: 14.SEP.2016 21:55:25



20 dB Bandwidth Plot on EDR ( $\pi/4$ -DQPSK) 2 Mbps / Channel 0 / 2402 MHz

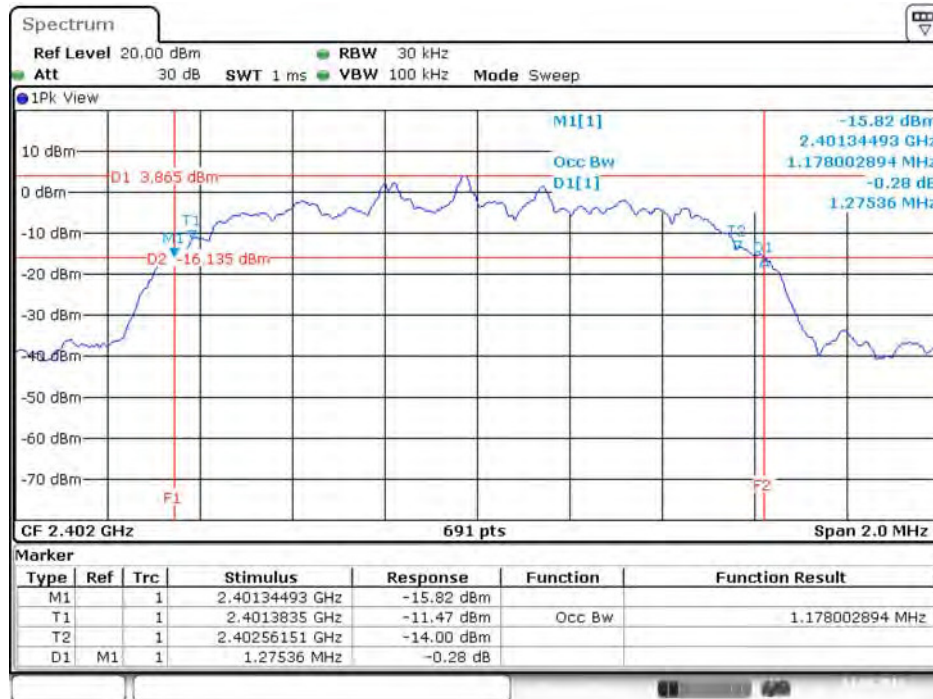

Date: 14.SEP.2016 20:02:18

20 dB Bandwidth Plot on EDR ( $\pi/4$ -DQPSK) 2 Mbps / Channel 39 / 2441 MHz

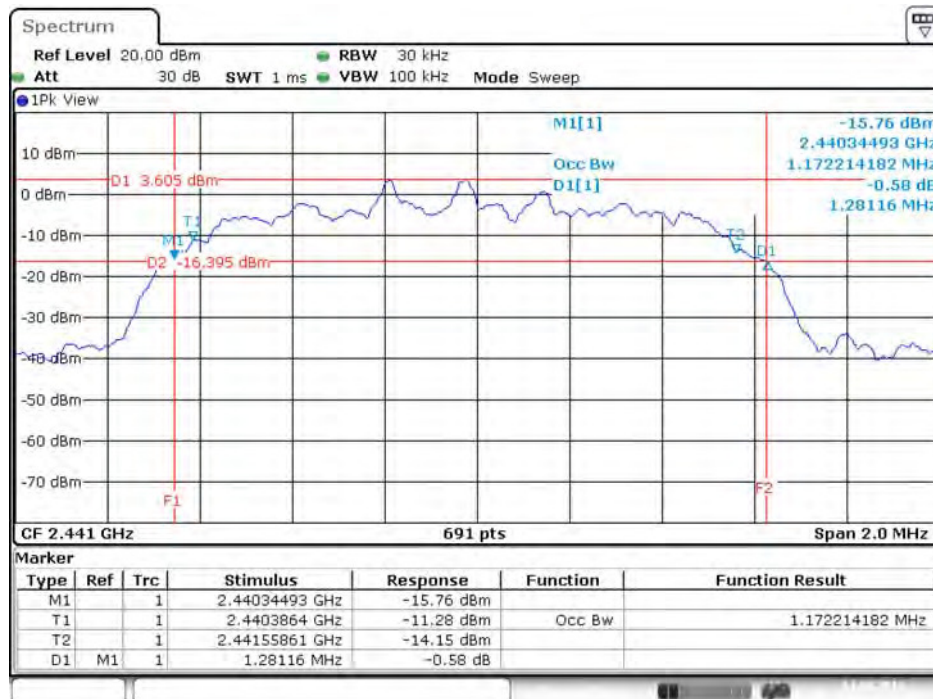

Date: 14.SEP.2016 20:01:38

20 dB Bandwidth Plot on EDR ( $\pi/4$ -DQPSK) 2 Mbps / Channel 78 / 2480 MHz

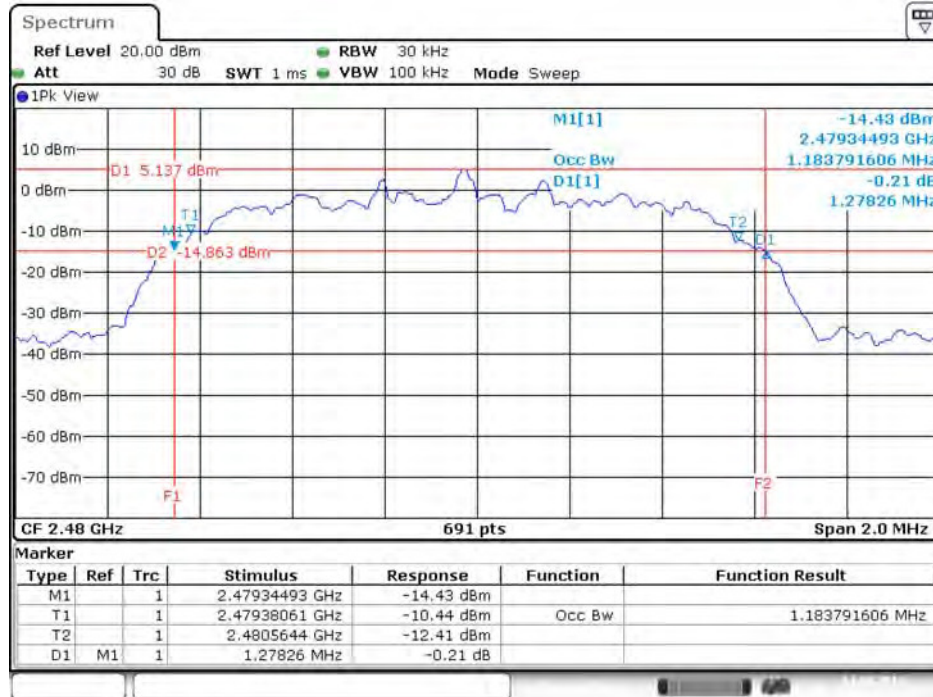

Date: 14.SEP.2016 20:00:21

Channel Separation Plot on EDR ( $\pi/4$ -DQPSK) 2 Mbps / Channel 0~1 / 2402 MHz ~ 2403 MHz

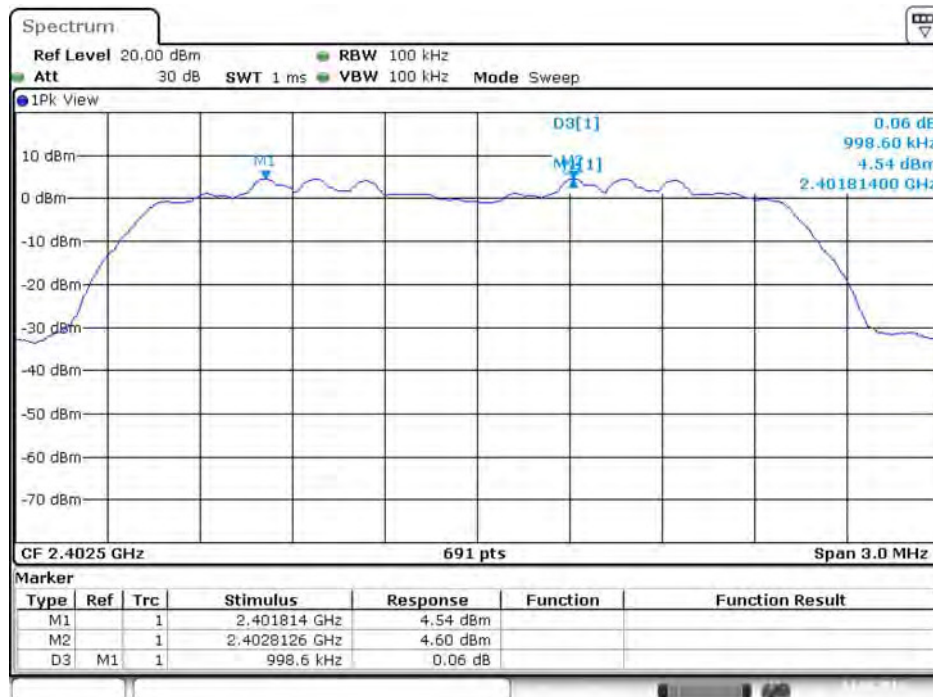

Date: 14.SEP.2016 21:41:51

Channel Separation Plot on EDR ( $\pi/4$ -DQPSK) 2 Mbps / Channel 39~40 / 2441 MHz ~ 2442 MHz

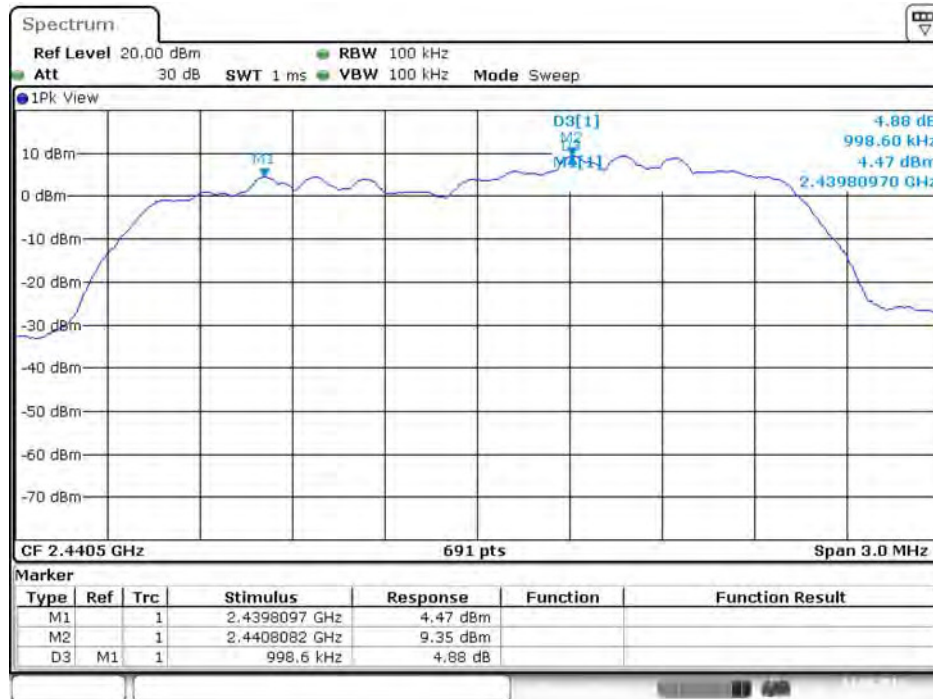

Date: 14.SEP.2016 21:43:06

Channel Separation Plot on EDR ( $\pi/4$ -DQPSK) 2 Mbps / Channel 77~78 / 2479 MHz ~ 2480 MHz

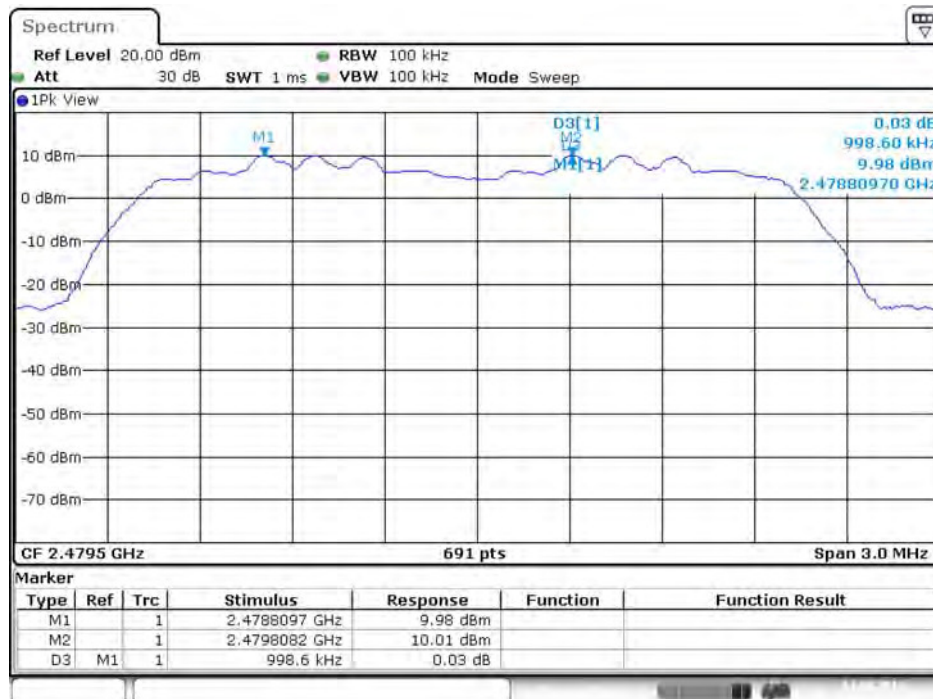

Date: 14.SEP.2016 21:44:09



20 dB Bandwidth Plot on EDR (8DPSK) 3 Mbps / Channel 0 / 2402 MHz

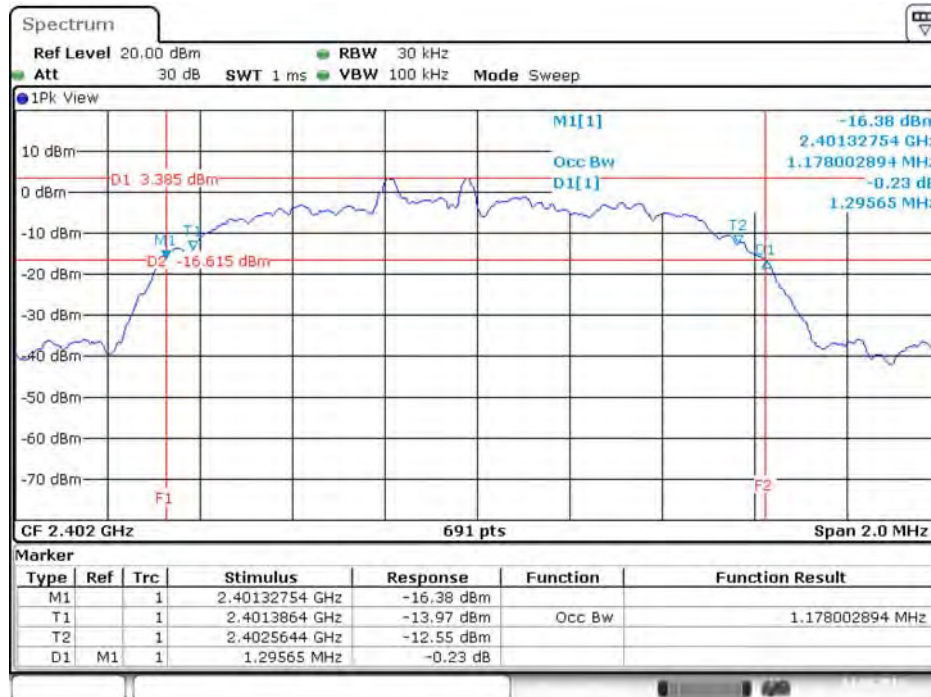

Date: 14.SEP.2016 20:03:56

20 dB Bandwidth Plot on EDR (8DPSK) 3 Mbps / Channel 39 / 2441 MHz

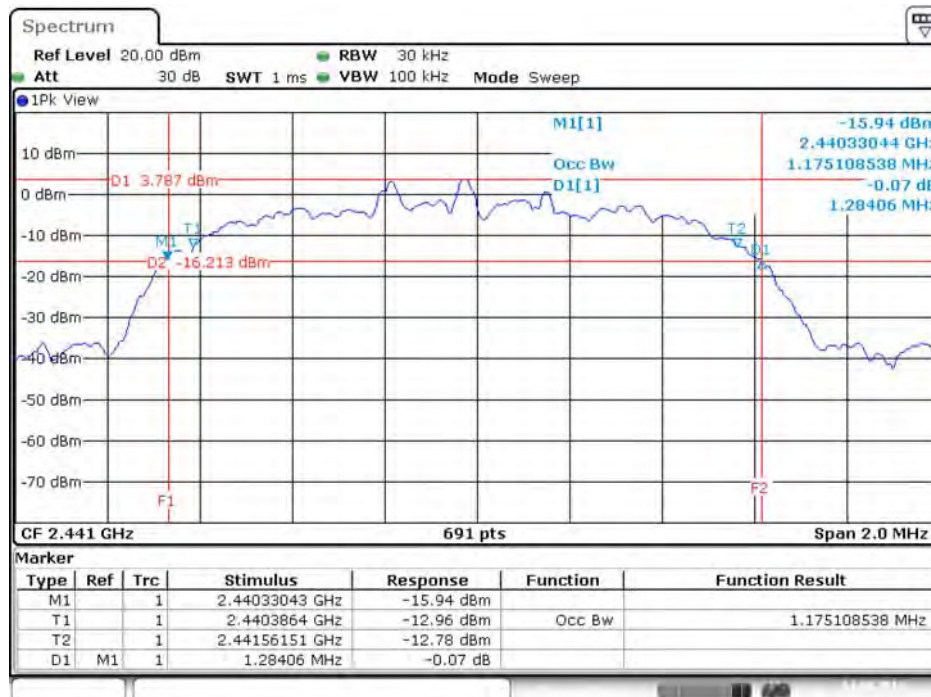

Date: 14.SEP.2016 20:04:47

20 dB Bandwidth Plot on EDR (8DPSK) 3 Mbps / Channel 78 / 2480 MHz

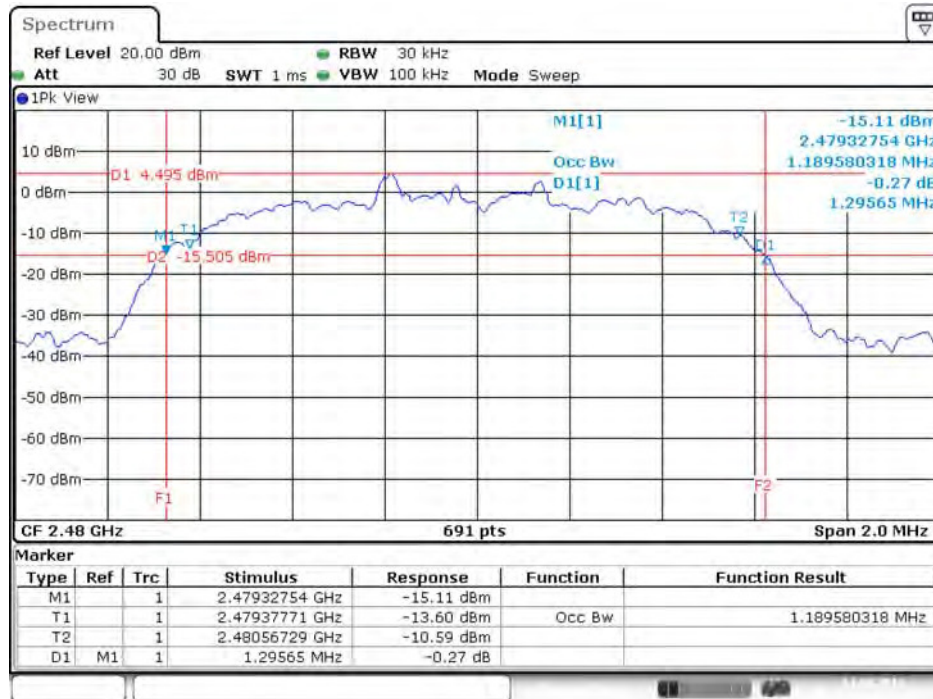

Channel Separation Plot on EDR (8DPSK) 3 Mbps / Channel 0~1 / 2402 MHz ~ 2403 MHz

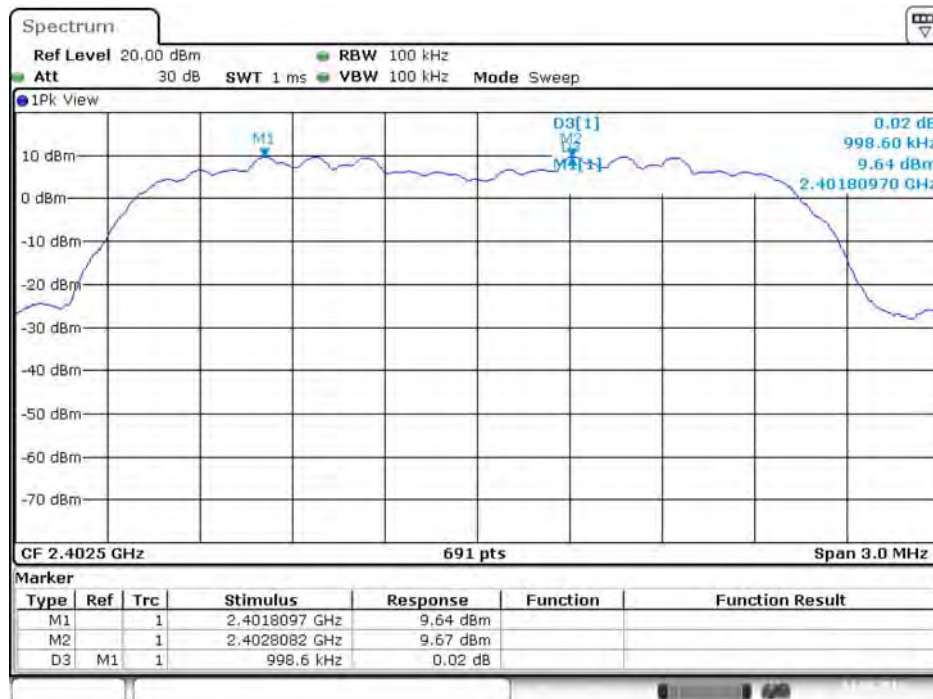

Channel Separation Plot on EDR (8DPSK) 3 Mbps / Channel 39~40 / 2441 MHz ~ 2442 MHz

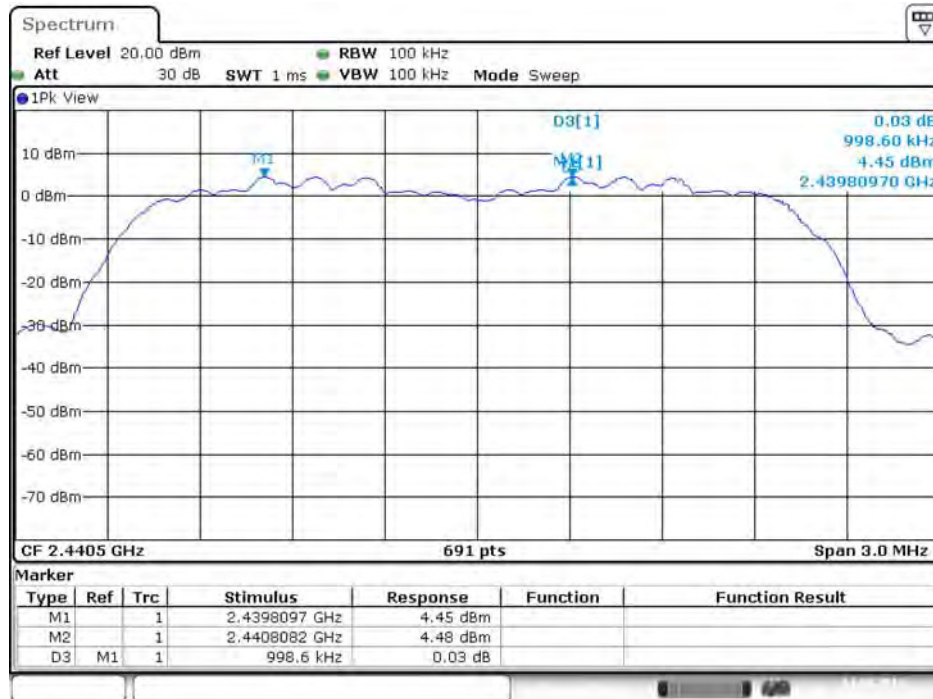

Date: 14.SEP.2016 21:49:01

Channel Separation Plot on EDR (8DPSK) 3 Mbps / Channel 77~78 / 2479 MHz ~ 2480 MHz

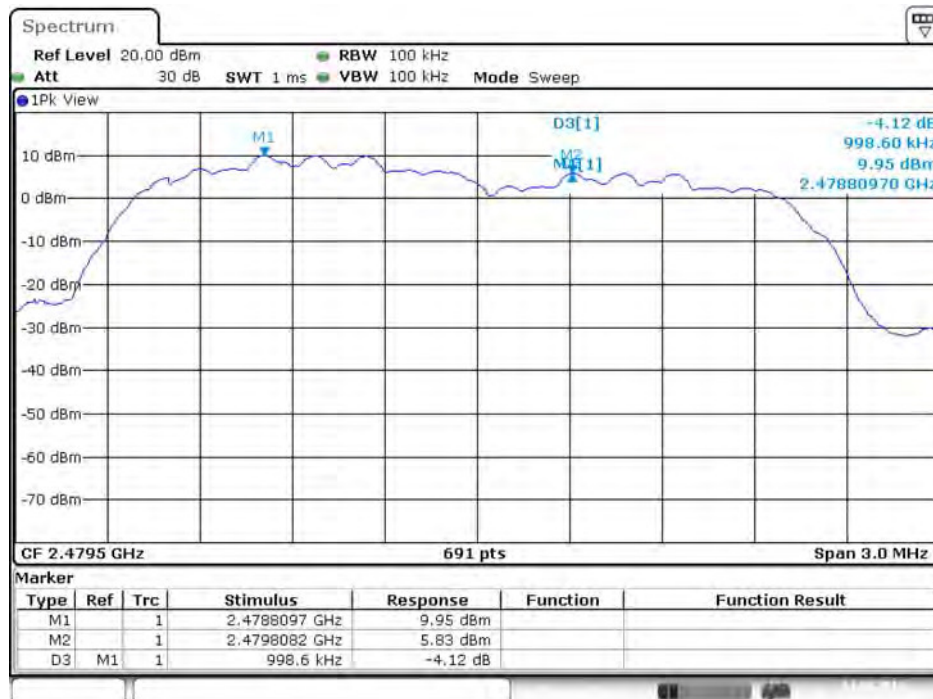

Date: 14.SEP.2016 21:48:00

#### 4.4. Number of Hopping Frequency Measurement

##### 4.4.1. Limit

At least 15 hopping frequencies, and should be equally spaced.

##### 4.4.2. Measuring Instruments and Setting

Please refer to section 5 of equipments list in this report. The following table is the setting of spectrum analyzer.

Spectrum Parameters	Setting
Attenuation	Auto
Span Frequency	> Operating Frequency Range
RBW	1000 kHz
VBW	1000 kHz
Detector	Peak
Trace	Max Hold
Sweep Time	Auto

##### 4.4.3. Test Procedures

1. The transmitter output (antenna port) was connected to the spectrum analyzer in peak hold mode.
2. The resolution bandwidth of 1000 kHz and the video bandwidth of 1000 kHz were utilized.
3. Observe frequency hopping in 2400MHz~2483.5MHz, there are at least 75 non-overlapping channels.

##### 4.4.4. Test Setup Layout

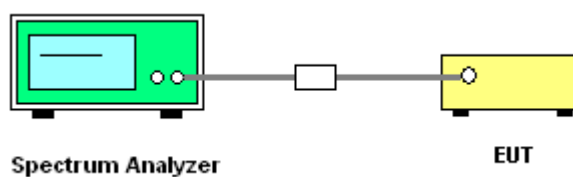

##### 4.4.5. Test Deviation

There is no deviation with the original standard.

##### 4.4.6. EUT Operation during Test

The EUT was programmed to be in continuously transmitting mode.

4.4.7. Test Result of Number of Hopping Frequency

Temperature	22°C	Humidity	54%
Test Engineer	Wen Chao	Configurations	EDR (8DPSK)

Modulation Type	Channel No.	Frequency (MHz)	Hopping Ch. (Channels)	Min. Limit (Channels)	Test Result
EDR (8DPSK)	0 ~ 78	2402 ~ 2480MHz	79	15	Complies

Number of Hopping Channel Plot on EDR (8DPSK) / Channel 0~78 / 2402 MHz ~ 2480 MHz

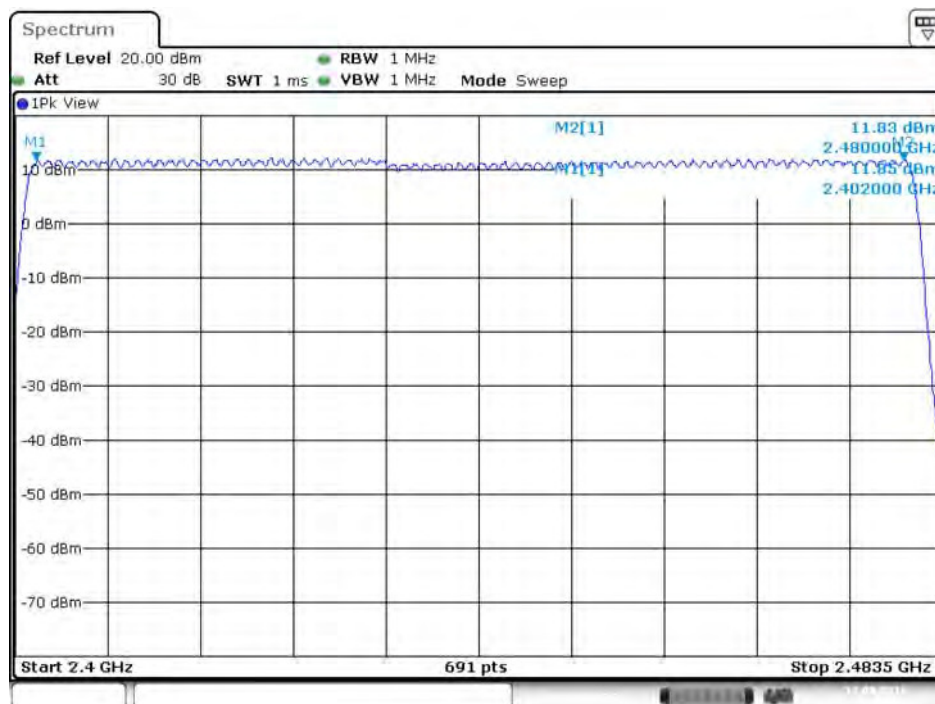

Date: 14.SEP.2016 22:08:23



## 4.5. Dwell Time Measurement

### 4.5.1. Limit

Frequency hopping systems in the 2400-2483.5 MHz band shall use at least 15 channels. The average time of occupancy on any channel shall not be greater than 0.4 seconds within a period of 0.4 seconds multiplied by the number of hopping channels employed.

### 4.5.2. Measuring Instruments and Setting

Please refer to section 5 of equipments list in this report. The following table is the setting of spectrum analyzer.

Spectrum Parameter	Setting
Attenuation	Auto
Span Frequency	0 MHz
RBW	1000 kHz
VBW	1000 kHz
Detector	Peak
Trace	Single Trigger

### 4.5.3. Test Procedures

1. The transmitter output (antenna port) was connected to the spectrum analyzer
2. Set RBW of spectrum analyzer to 1000kHz and VBW to 1000kHz.
3. Use a video trigger with the trigger level set to enable triggering only on full pulses.
4. Sweep Time is more than once pulse time.
5. Set the center frequency on any frequency would be measure and set the frequency span to zero span.
6. Measure the maximum time duration of one single pulse.
7. Set the EUT for DH1, DH3, DH5 packet transmitting.
8. Measure the maximum time duration of one single pulse.

### 4.5.4. Test Setup Layout

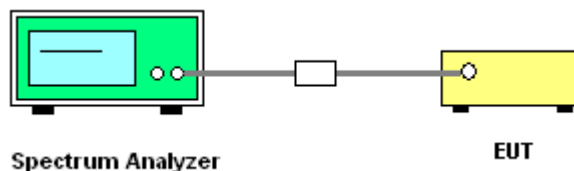

### 4.5.5. Test Deviation

There is no deviation with the original standard.

### 4.5.6. EUT Operation during Test

The EUT was programmed to be in continuously transmitting mode.

#### 4.5.7. Test Result of Dwell Time

<b>Temperature</b>	22°C	<b>Humidity</b>	54%
<b>Test Engineer</b>	Wen Chao	<b>Configurations</b>	BR (GFSK) / DH1, DH3, DH5

Data Packet	Frequency (MHz)	Pulse Duration (ms)	Dwell Time (s)	Limits (s)	Test Result
DH1	2402 MHz	0.4029	0.1289	0.4000	Complies
DH3	2402 MHz	1.6580	0.2653	0.4000	Complies
DH5	2402 MHz	2.8536	0.3044	0.4000	Complies
DH1	2441 MHz	0.4029	0.1289	0.4000	Complies
DH3	2441 MHz	1.6522	0.2643	0.4000	Complies
DH5	2441 MHz	2.8551	0.3045	0.4000	Complies
DH1	2480 MHz	0.4029	0.1289	0.4000	Complies
DH3	2480 MHz	1.6638	0.2662	0.4000	Complies
DH5	2480 MHz	2.8406	0.3030	0.4000	Complies

**Note:** Pulse Duration \* Number of Pulses\*(Dwell time / measure time)

**Remark:**

Dwell Time = 79(channels) x 0.4(s) x average hopping channel x package transfer time (us)

79 channels come from the Hopping Channel number.

Average Hopping Channel = hops / sweep time

Dwell Time Plot on BR (GFSK) / Channel 0 / DH1 / 2402 MHz

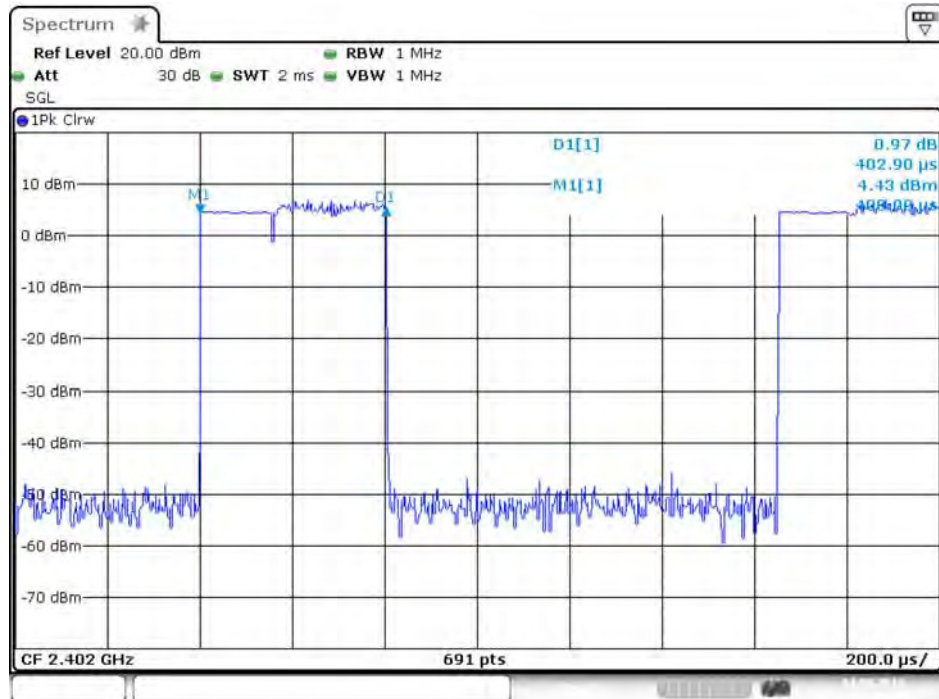

Dwell Time Plot on BR (GFSK) / Channel 39 / DH1 / 2441 MHz

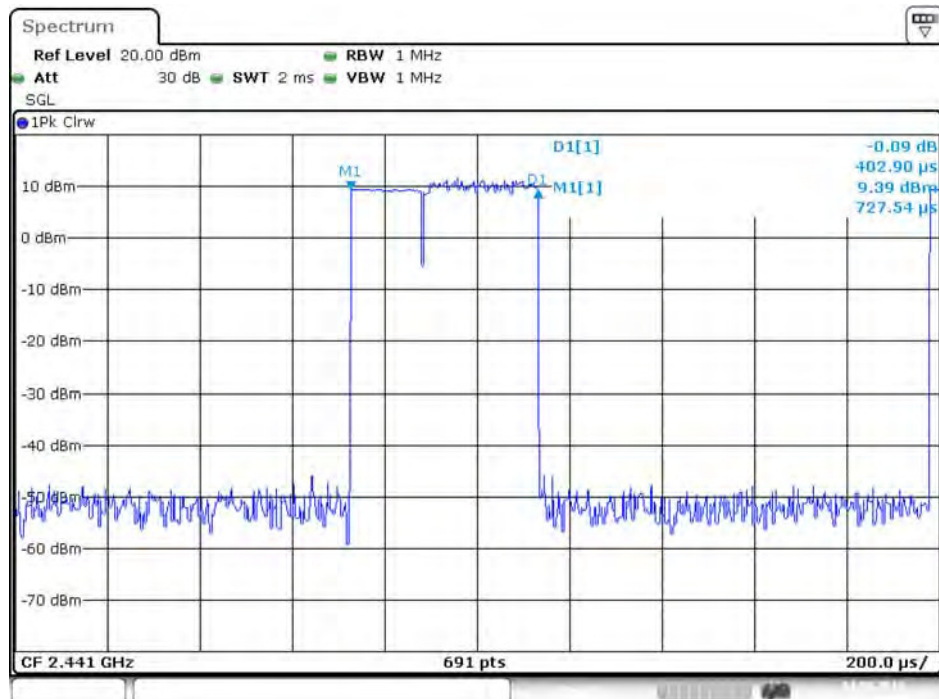



**Dwell Time Plot on BR (GFSK) / Channel 78 / DH1 / 2480 MHz**

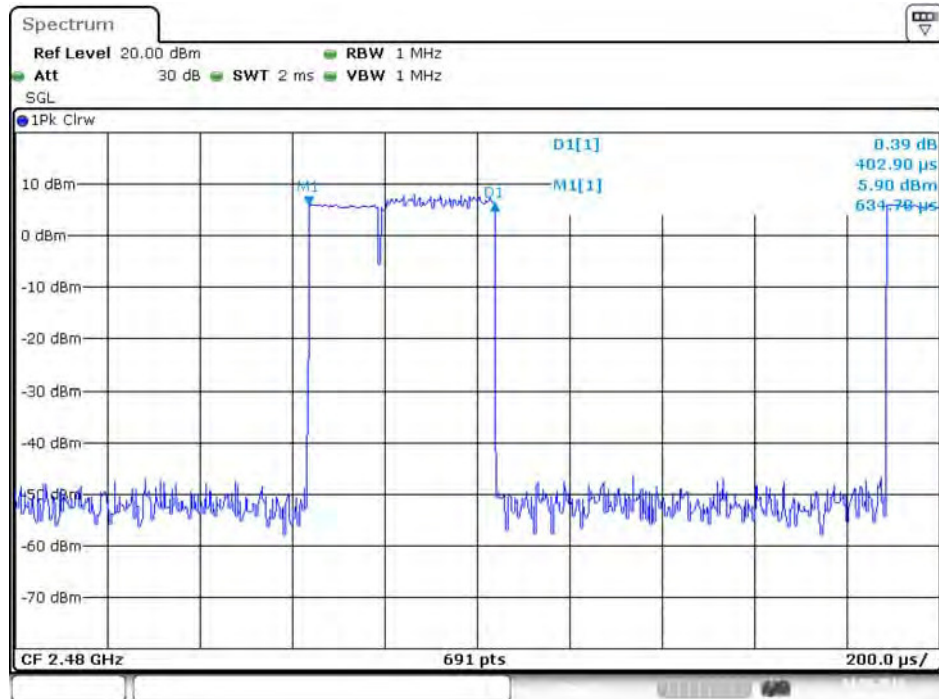

Date: 14.SEP.2016 21:57:32

**Dwell Time Plot on BR (GFSK) / Channel 0 / DH3 / 2402 MHz**

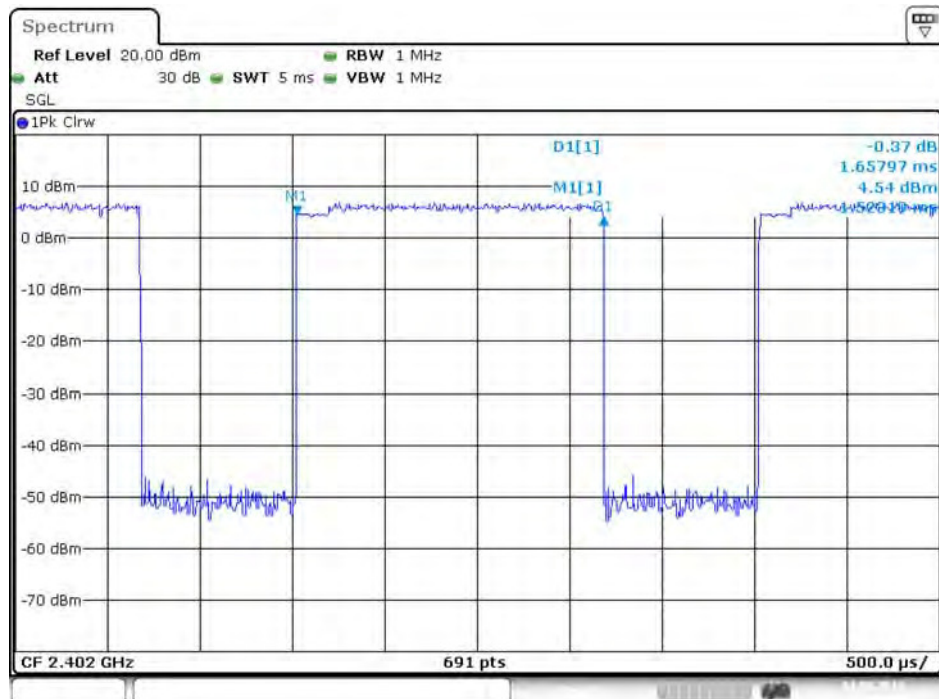

Date: 14.SEP.2016 22:05:20

**Dwell Time Plot on BR (GFSK) / Channel 39 / DH3 / 2441 MHz**

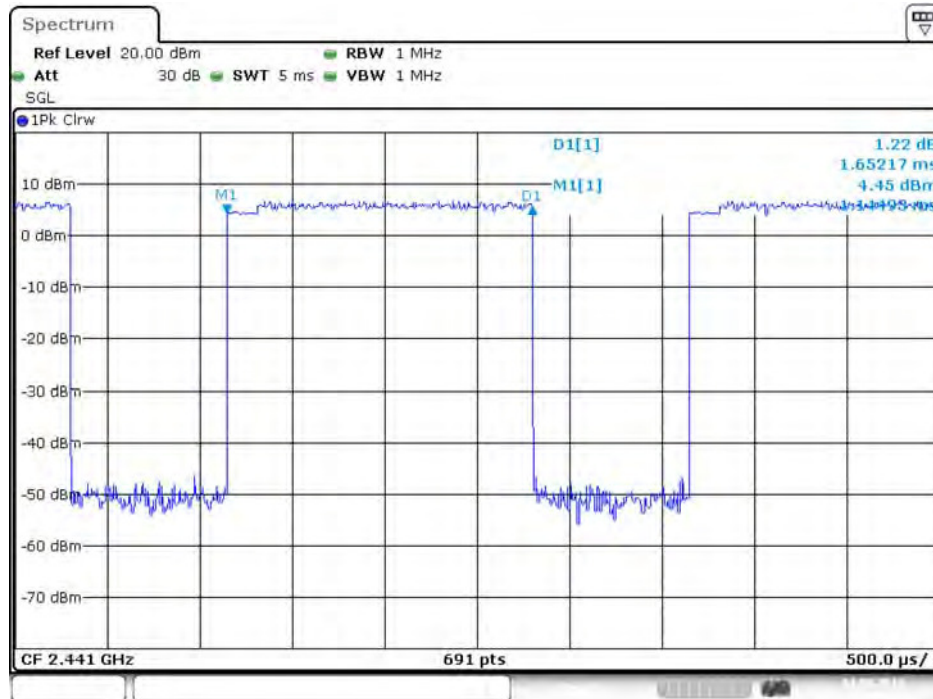

Date: 14.SEP.2016 22:02:32

**Dwell Time Plot on BR (GFSK) / Channel 78 / DH3 / 2480 MHz**

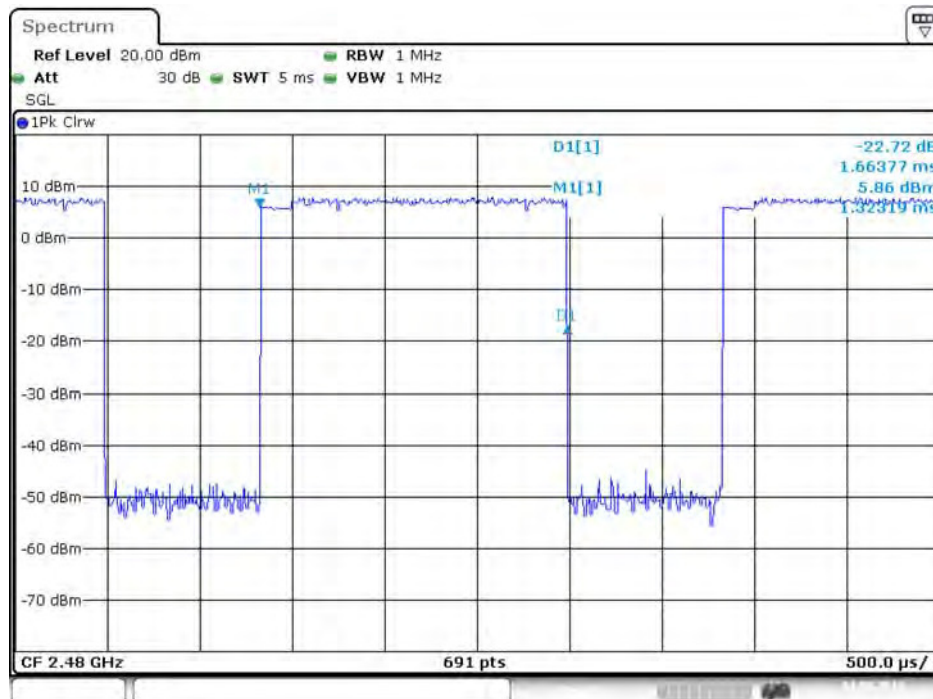

Date: 14.SEP.2016 21:58:54

Dwell Time Plot on BR (GFSK) / Channel 0 / DH5 / 2402 MHz

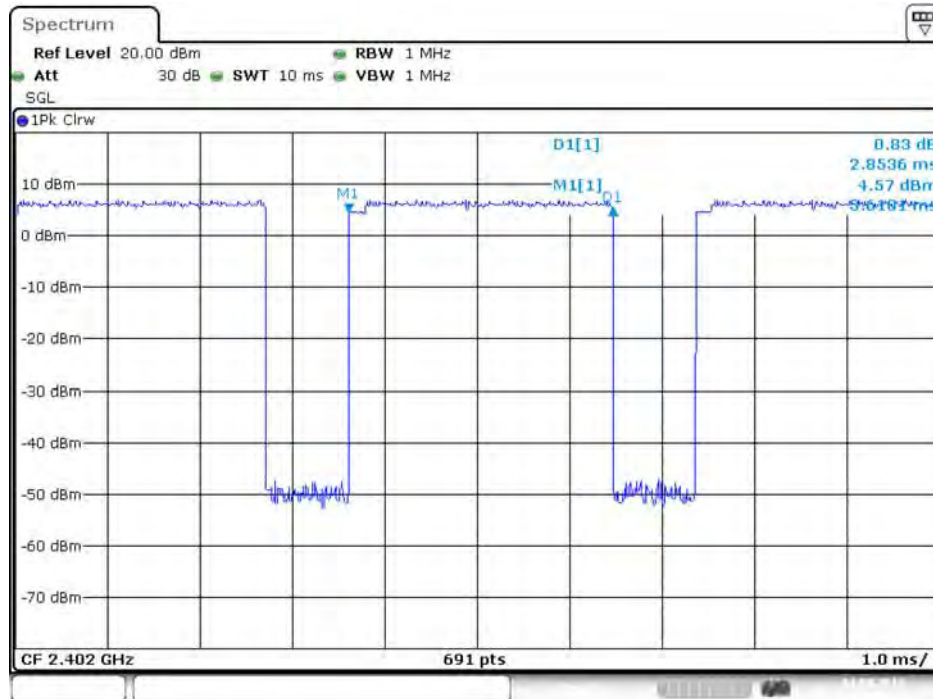

Dwell Time Plot on BR (GFSK) / Channel 39 / DH5 / 2441 MHz

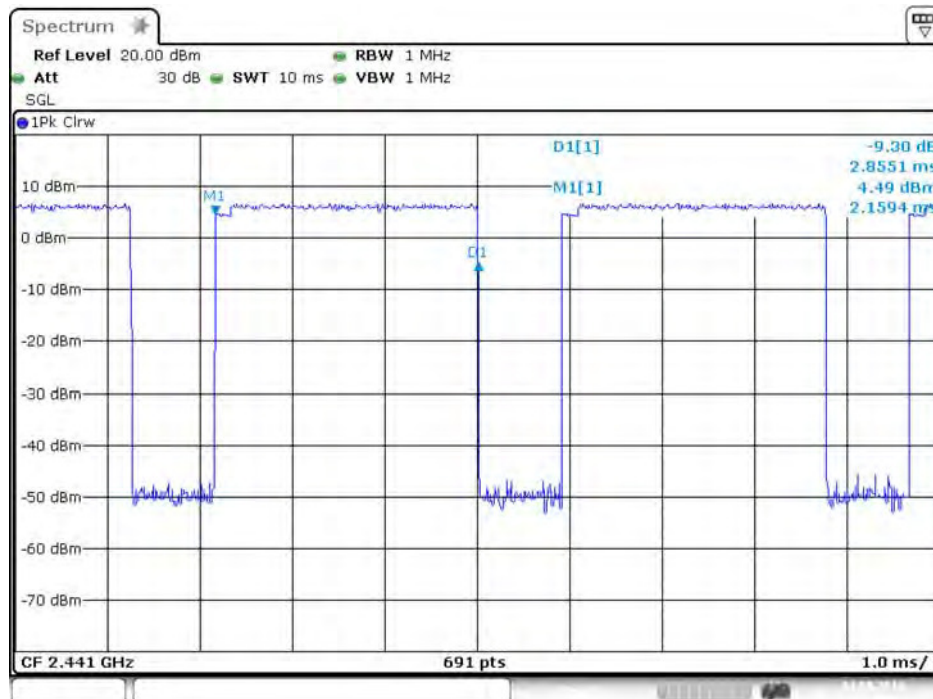

### Dwell Time Plot on BR (GFSK) / Channel 78 / DH5 / 2480 MHz

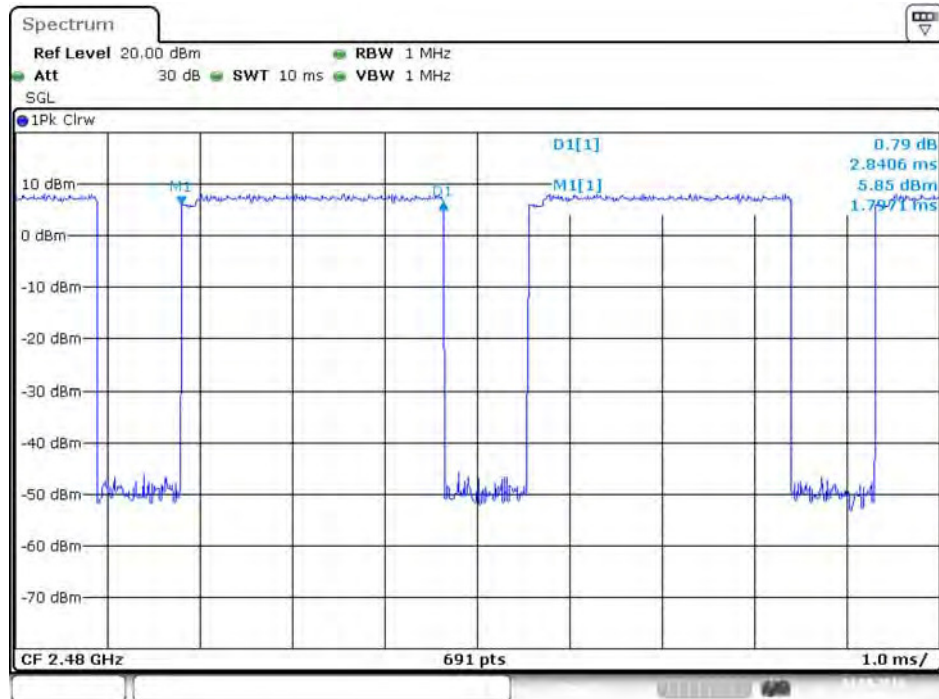

Date: 14.SEP.2016 22:00:37

## 4.6. Radiated Emissions Measurement

### 4.6.1. Limit

20dBc in any 100 kHz bandwidth outside the operating frequency band. In case the emission fall within the restricted band specified on 15.205(a), then the 15.209(a) limit in the table below has to be followed.

Frequencies (MHz)	Field Strength (micorvolts/meter)	Measurement Distance (meters)
0.009~0.490	2400/F(kHz)	300
0.490~1.705	24000/F(kHz)	30
1.705~30.0	30	30
30~88	100	3
88~216	150	3
216~960	200	3
Above 960	500	3

### 4.6.2. Measuring Instruments and Setting

Please refer to section 5 of equipments list in this report. The following table is the setting of spectrum analyzer and receiver.

Spectrum Parameter	Setting
Attenuation	Auto
Start Frequency	1000 MHz
Stop Frequency	10th carrier harmonic
RBW / VBW (Emission in restricted band)	1 MHz / 3MHz for Peak, 1 MHz / 1/T for Average
RBW / VBW (Emission in non-restricted band)	100kHz, 300kHz for peak

Receiver Parameter	Setting
Attenuation	Auto
Start ~ Stop Frequency	9kHz~150kHz, RBW 200Hz for QP
Start ~ Stop Frequency	150kHz~30MHz, RBW 9kHz for QP
Start ~ Stop Frequency	30MHz~1000MHz, RBW 120kHz for QP

#### 4.6.3. Test Procedures

1. Configure the EUT according to ANSI C63.10. The EUT was placed on the top of the turntable 1.5 meter above ground. The phase center of the receiving antenna mounted on the top of a height-variable antenna tower was placed 1m & 3m far away from the turntable.
2. Power on the EUT and all the supporting units. The turntable was rotated by 360 degrees to determine the position of the highest radiation.
3. The height of the broadband receiving antenna was varied between one meter and four meters above ground to find the maximum emissions field strength of both horizontal and vertical polarization.
4. For each suspected emissions, the antenna tower was scan (from 1 M to 4 M) and then the turntable was rotated (from 0 degree to 360 degrees) to find the maximum reading.
5. Set the test-receiver system to Peak or CISPR quasi-peak Detect Function with specified bandwidth under Maximum Hold Mode.
6. For emissions above 1GHz, use 1MHz VBW and 3MHz RBW for peak reading. Then 1MHz RBW and 1/T VBW for average reading in spectrum analyzer.
7. When the radiated emissions limits are expressed in terms of the average value of the emissions, and pulsed operation is employed, the measurement field strength shall be determined by averaging over one complete pulse train, including blanking intervals, as long as the pulse train does not exceed 0.1 seconds. As an alternative (provided the transmitter operates for longer than 0.1 seconds) or in cases where the pulse train exceeds 0.1 seconds, the measured field strength shall be determined from the average absolute voltage during a 0.1 second interval during which the field strength is at its maximum value.
8. If the emissions level of the EUT in peak mode was 3 dB lower than the average limit specified, then testing will be stopped and peak values of EUT will be reported, otherwise, the emissions which do not have 3 dB margin will be repeated one by one using the quasi-peak method for below 1GHz.
9. For testing above 1GHz, the emissions level of the EUT in peak mode was lower than average limit (that means the emissions level in peak mode also complies with the limit in average mode), then testing will be stopped and peak values of EUT will be reported, otherwise, the emissions will be measured in average mode again and reported.
10. In case the emission is lower than 30MHz, loop antenna has to be used for measurement and the recorded data should be QP measured by receiver. High – Low scan is not required in this case.



#### 4.6.4. Test Setup Layout

For Radiated Emissions: 9kHz ~30MHz

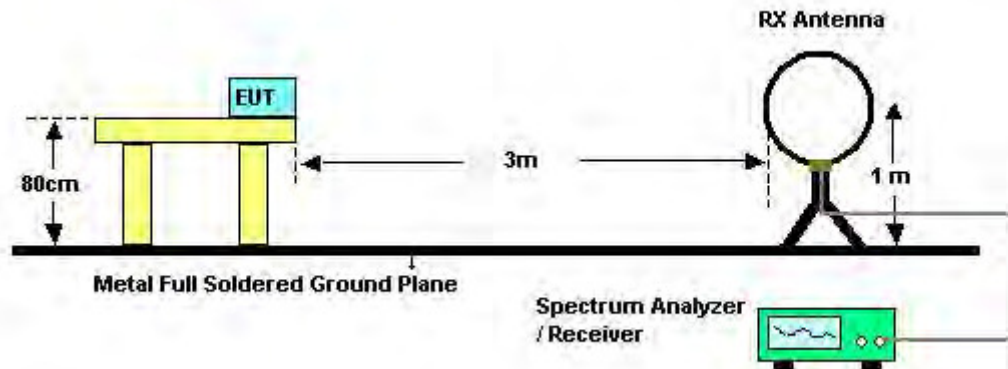

For Radiated Emissions: 30MHz~1GHz

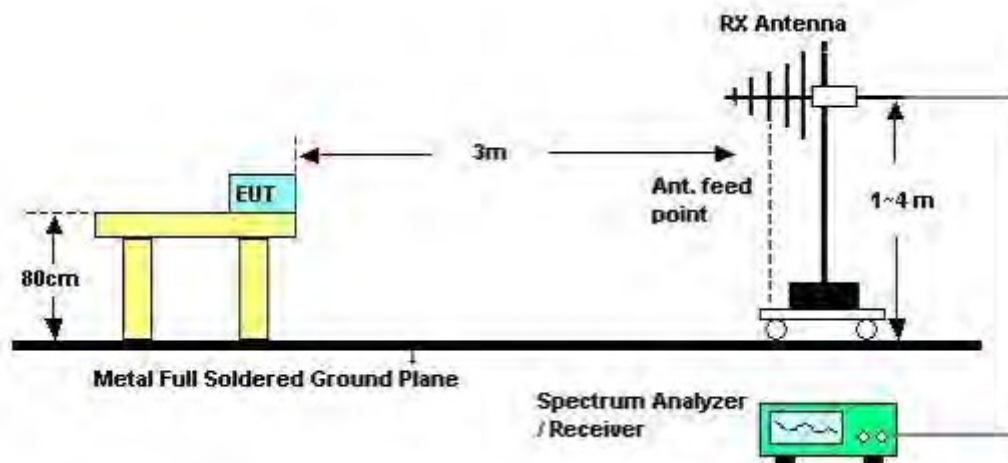

### For Radiated Emissions: Above 1GHz

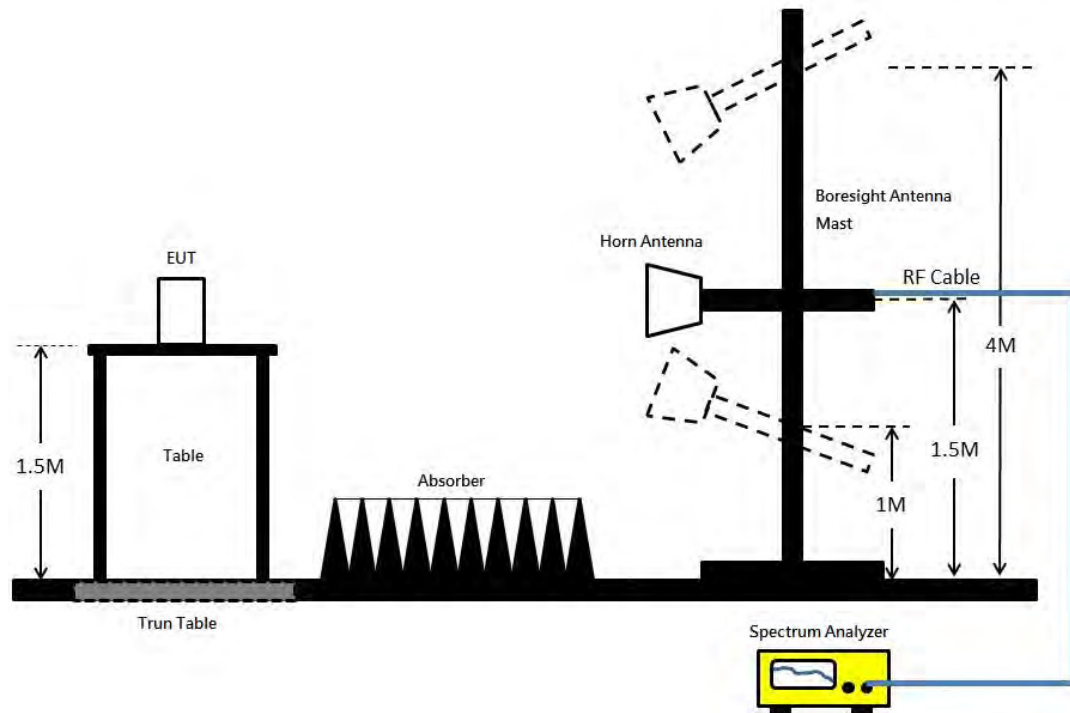

#### 4.6.5. Test Deviation

There is no deviation with the original standard.

#### 4.6.6. EUT Operation during Test

The EUT was programmed to be in continuously transmitting mode.



#### 4.6.7. Results of Radiated Emissions (9kHz~30MHz)

<b>Temperature</b>	22°C	<b>Humidity</b>	54%
<b>Test Engineer</b>	Jay Lo	<b>Test Date</b>	Mar. 16, 2017
<b>Configurations</b>	Normal Link	<b>Test Mode</b>	Mode 1~Mode 3

<b>Freq. (MHz)</b>	<b>Level (dBuV)</b>	<b>Over Limit (dB)</b>	<b>Limit Line (dBuV)</b>	<b>Remark</b>
-	-	-	-	See Note

Note:

The amplitude of spurious emissions which are attenuated by more than 20dB below the permissible value has no need to be reported.

Distance extrapolation factor =  $40 \log(\text{specific distance} / \text{test distance})$  (dB);

Limit line = specific limits (dBuV) + distance extrapolation factor.

4.6.8. Results of Radiated Emissions (30MHz~1GHz)

Temperature	22°C	Humidity	54%
Test Engineer	Joy Luo	Configurations	Normal Link
Test Mode	Mode 1 / PHY main source + U2 second source (Samsung)		

Horizontal

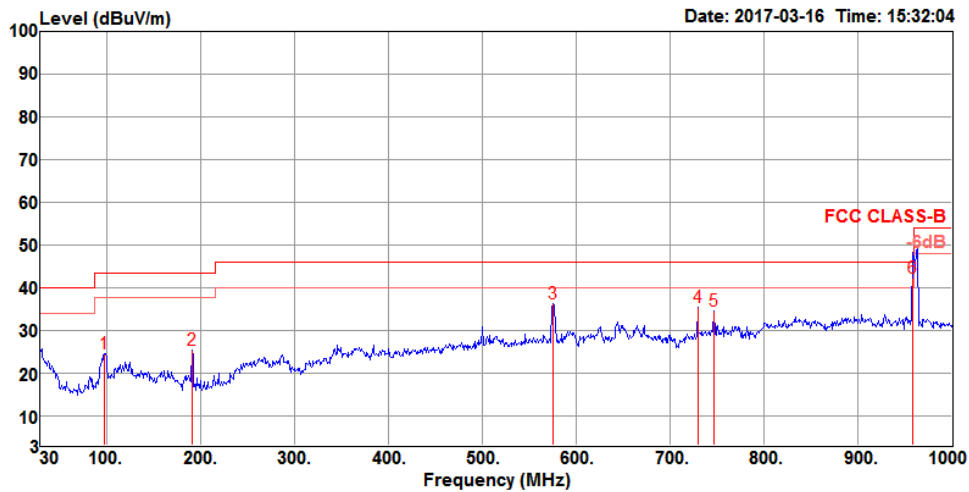

	Freq	Level	Limit	Over	Read	CableAntenna	Preamp	A/Pos	T/Pos	Remark	Pol/Phase	
	MHz	dBuV/m	dBuV/m	dB	dBuV	dB	dB/m	dB	cm	deg		
1	97.90	24.51	43.50	-18.99	39.58	0.20	17.18	32.45	150	212	Peak	HORIZONTAL
2	191.02	25.28	43.50	-18.22	41.30	0.23	16.09	32.34	200	251	Peak	HORIZONTAL
3	575.14	36.20	46.00	-9.80	42.86	0.63	25.10	32.39	100	276	Peak	HORIZONTAL
4	729.37	35.25	46.00	-10.75	40.17	1.20	26.20	32.32	150	160	Peak	HORIZONTAL
5	746.83	34.46	46.00	-11.54	39.00	1.36	26.38	32.28	100	236	Peak	HORIZONTAL
6	958.29	42.14	46.00	-3.86	43.81	1.25	28.20	31.12	100	285	QP	HORIZONTAL

**Vertical**

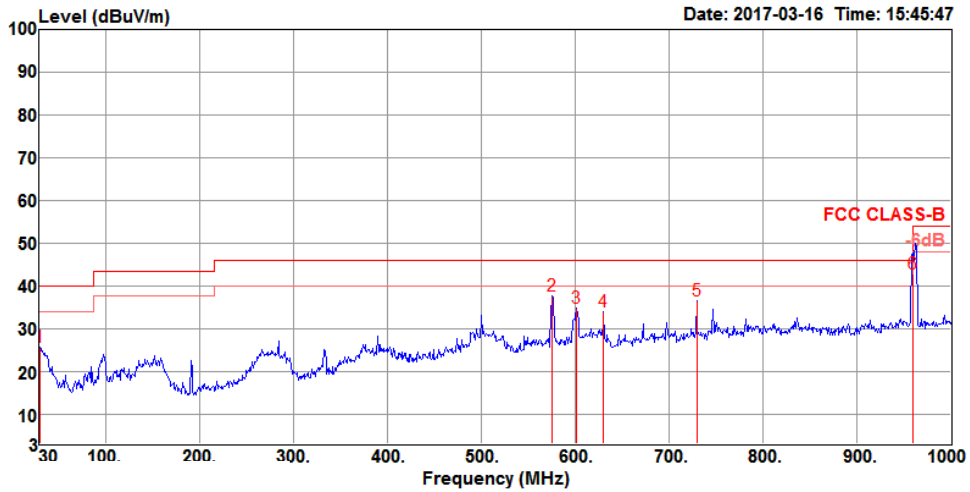

	Freq	Level	Limit	Over	Read	CableAntenna	Preamp	A/Pos	T/Pos	Remark	Pol/Phase
	MHz	dBuV/m	dBuV/m	dB	dBuV	dB	dB/m	dB	cm	deg	
1	30.00	25.49	40.00	-14.51	32.66	0.25	25.60	33.02	200	42 Peak	VERTICAL
2	575.14	37.61	46.00	-8.39	44.54	0.36	25.10	32.39	150	34 Peak	VERTICAL
3	601.33	34.78	46.00	-11.22	41.20	0.56	25.43	32.41	150	2 Peak	VERTICAL
4	630.43	33.81	46.00	-12.19	39.69	0.69	25.83	32.40	150	262 Peak	VERTICAL
5	729.37	36.46	46.00	-9.54	41.33	1.25	26.20	32.32	200	203 Peak	VERTICAL
6	959.26	42.72	46.00	-3.28	44.01	1.63	28.20	31.12	100	281 QP	VERTICAL

Temperature	22°C	Humidity	54%
Test Engineer	Joy Luo	Configurations	Normal Link
Test Mode	Mode 2 / PHY second source + U2 second source (Samsung)		

**Horizontal**

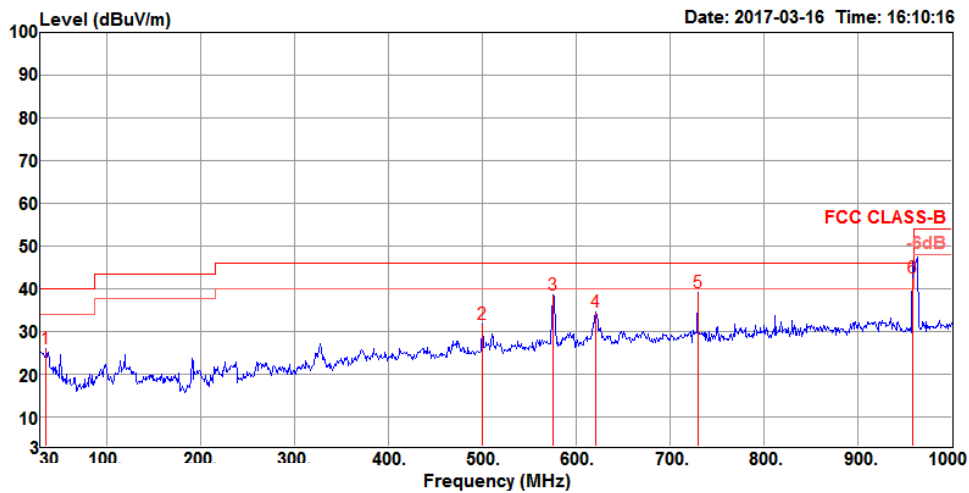

	Freq	Level	Limit Line	Over Limit	Read Level	CableAntenna Loss	Preamp Factor	A/Pos	T/Pos	Remark	Pol/Phase
	MHz	dBuV/m	dBuV/m	dB	dBuV	dB	dB/m	dB	cm	deg	
1	35.82	25.89	40.00	-14.11	35.71	0.25	22.73	32.80	100	205 Peak	HORIZONTAL
2	500.45	31.75	46.00	-14.25	39.77	0.25	24.03	32.30	100	265 Peak	HORIZONTAL
3	575.14	38.58	46.00	-7.42	45.48	0.39	25.10	32.39	200	140 Peak	HORIZONTAL
4	620.73	34.36	46.00	-11.64	40.58	0.48	25.70	32.40	150	316 Peak	HORIZONTAL
5	729.37	39.04	46.00	-6.96	43.77	1.39	26.20	32.32	200	334 Peak	HORIZONTAL
6	958.29	42.64	46.00	-3.36	44.00	1.56	28.20	31.12	100	80 QP	HORIZONTAL

**Vertical**

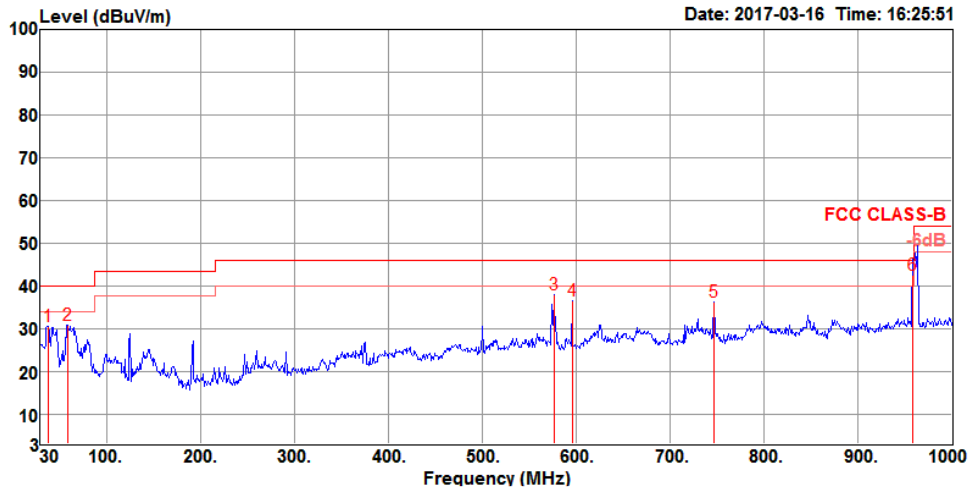

	Freq	Level	Limit Line	Over Limit	Read Level	CableAntenna Loss	Preamp Factor	A/Pos	T/Pos	Remark	Pol/Phase
	MHz	dBuV/m	dBuV/m	dB	dBuV	dB	dB/m	dB	cm	deg	
1	37.76	30.48	40.00	-9.52	41.28	0.42	21.51	32.73	100	280 Peak	VERTICAL
2	59.10	30.74	40.00	-9.26	48.80	0.52	13.82	32.40	100	4 Peak	VERTICAL
3	576.11	37.79	46.00	-8.21	44.40	0.66	25.12	32.39	100	180 Peak	VERTICAL
4	595.51	36.52	46.00	-9.48	42.68	0.89	25.35	32.40	200	0 Peak	VERTICAL
5	746.83	36.12	46.00	-9.88	40.66	1.36	26.38	32.28	125	7 Peak	VERTICAL
6	958.29	42.56	46.00	-3.44	43.79	1.69	28.20	31.12	125	182 QP	VERTICAL

Temperature	22°C	Humidity	54%
Test Engineer	Joy Luo	Configurations	Normal Link
Test Mode	Mode 3 / PHY main source + U2 main source (toshiba)		

**Horizontal**

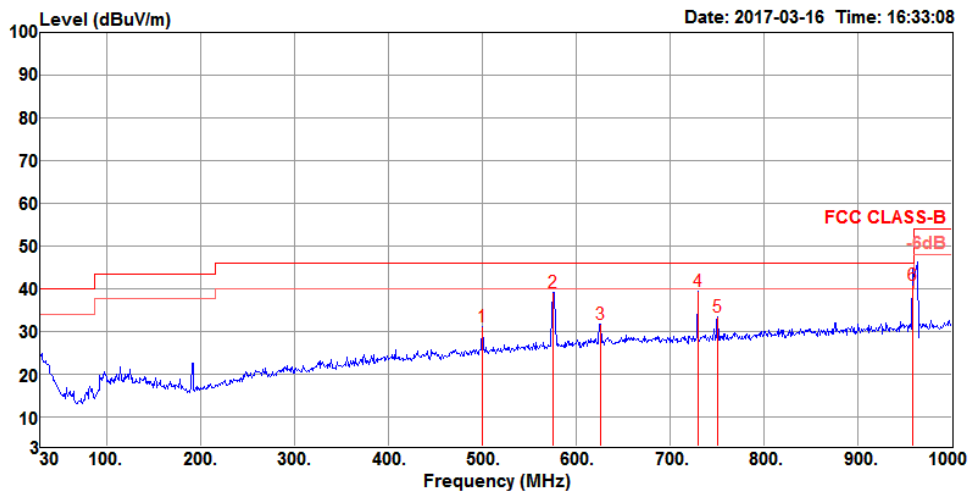

	Freq	Level	Limit Line	Over Limit	Read Level	CableAntenna Loss	Preamp Factor	A/Pos	T/Pos	Remark	Pol/Phase
	MHz	dBuV/m	dBuV/m	dB	dBuV	dB	dB/m	dB	cm	deg	
1	500.45	31.11	46.00	-14.89	39.21	0.17	24.03	32.30	200	102 Peak	HORIZONTAL
2	575.14	39.09	46.00	-6.91	45.85	0.53	25.10	32.39	100	304 Peak	HORIZONTAL
3	625.58	31.64	46.00	-14.36	37.16	1.11	25.77	32.40	200	13 Peak	HORIZONTAL
4	729.37	39.24	46.00	-6.76	44.34	1.02	26.20	32.32	150	295 Peak	HORIZONTAL
5	750.71	33.31	46.00	-12.69	39.19	0.00	26.40	32.28	125	268 Peak	HORIZONTAL
6	958.29	40.79	46.00	-5.21	43.71	0.00	28.20	31.12	100	79 QP	HORIZONTAL

**Vertical**

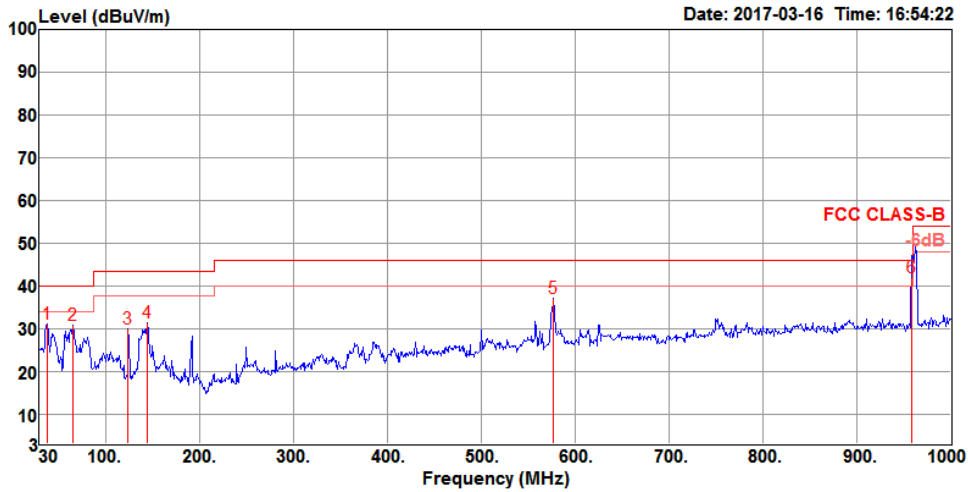

	Freq	Level	Limit	Over	Read	CableAntenna	Preamp	A/Pos	T/Pos	Remark	Pol/Phase
	MHz	dBuV/m	dBuV/m	dB	dBuV	dB	dB/m	dB	cm	deg	
1	37.76	31.00	40.00	-9.00	41.97	0.25	21.51	32.73	100	243 Peak	VERTICAL
2	64.92	30.87	40.00	-9.13	49.62	0.36	13.30	32.41	200	44 Peak	VERTICAL
3	124.09	29.93	43.50	-13.57	42.68	0.69	18.97	32.41	100	230 Peak	VERTICAL
4	144.46	31.35	43.50	-12.15	44.98	0.96	17.80	32.39	100	243 Peak	VERTICAL
5	577.08	37.01	46.00	-8.99	43.03	1.25	25.12	32.39	100	183 Peak	VERTICAL
6	958.29	42.03	46.00	-3.97	43.67	1.28	28.20	31.12	125	173 QP	VERTICAL

**Note:**

The amplitude of spurious emissions which are attenuated by more than 20 dB below the permissible value has no need to be reported.

Emission level (dBuV/m) = 20 log Emission level (uV/m).

Corrected Reading: Antenna Factor + Cable Loss + Read Level - Preamp Factor = Level.

4.6.9. Results for Radiated Emissions (1GHz~10<sup>th</sup> Harmonic)

Temperature	22°C	Humidity	54%
Test Engineer	Stim Sung/Jay Lo	Configurations	BR (GFSK) / Channel 0
Test Date	Sep. 16, 2016 ~ Sep. 22, 2016		

**Horizontal**

	Freq	Level	Limit Line	Over Limit	Read Level	CableAntenna Loss	Antenna Factor	Preamp Factor	A/Pos	T/Pos	Remark	Pol/Phase
	MHz	dBuV/m	dBuV/m	dB	dBuV	dB	dB/m	dB	cm	deg		
1	4803.67	49.29	74.00	-24.71	43.85	5.30	33.08	32.94	234	289	Peak	HORIZONTAL
2	4803.95	41.94	54.00	-12.06	36.50	5.30	33.08	32.94	234	289	Average	HORIZONTAL

**Vertical**

	Freq	Level	Limit Line	Over Limit	Read Level	CableAntenna Loss	Antenna Factor	Preamp Factor	A/Pos	T/Pos	Remark	Pol/Phase
	MHz	dBuV/m	dBuV/m	dB	dBuV	dB	dB/m	dB	cm	deg		
1	4803.70	49.80	74.00	-24.20	44.36	5.30	33.08	32.94	116	183	Peak	VERTICAL
2	4803.96	41.66	54.00	-12.34	36.22	5.30	33.08	32.94	116	183	Average	VERTICAL



<b>Temperature</b>	22°C	<b>Humidity</b>	54%
<b>Test Engineer</b>	Stim Sung/Jay Lo	<b>Configurations</b>	BR (GFSK) / Channel 39
<b>Test Date</b>	Sep. 16, 2016 ~ Sep. 22, 2016		

### Horizontal

	Freq	Level	Limit Line	Over Limit	Read Level	CableAntenna Loss	Antenna Factor	Preamp Factor	A/Pos	T/Pos	Remark	Pol/Phase
	MHz	dBuV/m	dBuV/m	dB	dBuV	dB	dB/m	dB	cm	deg		
1	4881.58	49.44	74.00	-24.56	43.81	5.30	33.26	32.93	241	269	Peak	HORIZONTAL
2	4881.90	42.48	54.00	-11.52	36.85	5.30	33.26	32.93	241	269	Average	HORIZONTAL

### Vertical

	Freq	Level	Limit Line	Over Limit	Read Level	CableAntenna Loss	Antenna Factor	Preamp Factor	A/Pos	T/Pos	Remark	Pol/Phase
	MHz	dBuV/m	dBuV/m	dB	dBuV	dB	dB/m	dB	cm	deg		
1	4881.94	41.74	54.00	-12.26	36.11	5.30	33.26	32.93	117	185	Average	VERTICAL
2	4882.27	49.05	74.00	-24.95	43.42	5.30	33.26	32.93	117	185	Peak	VERTICAL



<b>Temperature</b>	22°C	<b>Humidity</b>	54%
<b>Test Engineer</b>	Stim Sung/Jay Lo	<b>Configurations</b>	BR (GFSK) / Channel 78
<b>Test Date</b>	Sep. 16, 2016 ~ Sep. 22, 2016		

**Horizontal**

	Freq	Level	Limit Line	Over Limit	Read Level	CableAntenna Loss	Antenna Factor	Preamp Factor	A/Pos	T/Pos	Remark	Pol/Phase
	MHz	dBuV/m	dBuV/m	dB	dBuV	dB	dB/m	dB	cm	deg		
1	4959.94	45.02	54.00	-8.98	39.22	5.30	33.41	32.91	244	268	Average	HORIZONTAL
2	4960.11	51.31	74.00	-22.69	45.51	5.30	33.41	32.91	244	268	Peak	HORIZONTAL

**Vertical**

	Freq	Level	Limit Line	Over Limit	Read Level	CableAntenna Loss	Antenna Factor	Preamp Factor	A/Pos	T/Pos	Remark	Pol/Phase
	MHz	dBuV/m	dBuV/m	dB	dBuV	dB	dB/m	dB	cm	deg		
1	4960.00	43.10	54.00	-10.90	37.30	5.30	33.41	32.91	117	183	Average	VERTICAL
2	4960.35	50.43	74.00	-23.57	44.63	5.30	33.41	32.91	117	183	Peak	VERTICAL

**Note:**

The amplitude of spurious emissions which are attenuated by more than 20dB below the permissible value has no need to be reported.

Emission level (dBuV/m) = 20 log Emission level (uV/m).

Corrected Reading: Antenna Factor + Cable Loss + Read Level - Preamp Factor = Level.



<b>Temperature</b>	22°C	<b>Humidity</b>	54%
<b>Test Engineer</b>	Stim Sung/Jay Lo	<b>Configurations</b>	EDR (8DPSK) / Channel 0
<b>Test Date</b>	Sep. 16, 2016 ~ Sep. 22, 2016		

**Horizontal**

	Freq	Level	Limit Line	Over Limit	Read Level	CableAntenna Loss	Antenna Factor	Preamp Factor	A/Pos	T/Pos	Remark	Pol/Phase
	MHz	dBuV/m	dBuV/m	dB	dBuV	dB	dB/m	dB	cm	deg		
1	4803.92	36.12	54.00	-17.88	30.68	5.30	33.08	32.94	258	239	Average	HORIZONTAL
2	4804.03	48.14	74.00	-25.86	42.70	5.30	33.08	32.94	258	239	Peak	HORIZONTAL

**Vertical**

	Freq	Level	Limit Line	Over Limit	Read Level	CableAntenna Loss	Antenna Factor	Preamp Factor	A/Pos	T/Pos	Remark	Pol/Phase
	MHz	dBuV/m	dBuV/m	dB	dBuV	dB	dB/m	dB	cm	deg		
1	4803.95	47.36	74.00	-26.64	41.92	5.30	33.08	32.94	113	181	Peak	VERTICAL
2	4804.05	36.00	54.00	-18.00	30.56	5.30	33.08	32.94	113	181	Average	VERTICAL



<b>Temperature</b>	22°C	<b>Humidity</b>	54%
<b>Test Engineer</b>	Stim Sung/Jay Lo	<b>Configurations</b>	EDR (8DPSK) / Channel 39
<b>Test Date</b>	Sep. 16, 2016 ~ Sep. 22, 2016		

**Horizontal**

	Freq	Level	Limit Line	Over Limit	Read Level	CableAntenna Loss	Antenna Factor	Preamp Factor	A/Pos	T/Pos	Remark	Pol/Phase
	MHz	dBuV/m	dBuV/m	dB	dBuV	dB	dB/m	dB	cm	deg		
1	4881.95	36.42	54.00	-17.58	30.79	5.30	33.26	32.93	267	271	Average	HORIZONTAL
2	4882.26	46.56	74.00	-27.44	40.93	5.30	33.26	32.93	267	271	Peak	HORIZONTAL

**Vertical**

	Freq	Level	Limit Line	Over Limit	Read Level	CableAntenna Loss	Antenna Factor	Preamp Factor	A/Pos	T/Pos	Remark	Pol/Phase
	MHz	dBuV/m	dBuV/m	dB	dBuV	dB	dB/m	dB	cm	deg		
1	4881.92	35.88	54.00	-18.12	30.25	5.30	33.26	32.93	102	188	Average	VERTICAL
2	4882.16	47.88	74.00	-26.12	42.25	5.30	33.26	32.93	102	188	Peak	VERTICAL



<b>Temperature</b>	22°C	<b>Humidity</b>	54%
<b>Test Engineer</b>	Stim Sung/Jay Lo	<b>Configurations</b>	EDR (8DPSK) / Channel 78
<b>Test Date</b>	Sep. 16, 2016 ~ Sep. 22, 2016		

**Horizontal**

	Freq	Level	Limit Line	Over Limit	Read Level	CableAntenna Loss	Antenna Factor	Preamp Factor	A/Pos	T/Pos	Remark	Pol/Phase
	MHz	dBuV/m	dBuV/m	dB	dBuV	dB	dB/m	dB	cm	deg		
1	4959.76	48.69	74.00	-25.31	42.89	5.30	33.41	32.91	239	269	Peak	HORIZONTAL
2	4959.90	39.71	54.00	-14.29	33.91	5.30	33.41	32.91	239	269	Average	HORIZONTAL

**Vertical**

	Freq	Level	Limit Line	Over Limit	Read Level	CableAntenna Loss	Antenna Factor	Preamp Factor	A/Pos	T/Pos	Remark	Pol/Phase
	MHz	dBuV/m	dBuV/m	dB	dBuV	dB	dB/m	dB	cm	deg		
1	4959.97	38.21	54.00	-15.79	32.41	5.30	33.41	32.91	100	186	Average	VERTICAL
2	4960.03	48.26	74.00	-25.74	42.46	5.30	33.41	32.91	100	186	Peak	VERTICAL

**Note:**

The amplitude of spurious emissions which are attenuated by more than 20dB below the permissible value has no need to be reported.

Emission level (dBuV/m) = 20 log Emission level (uV/m).

Corrected Reading: Antenna Factor + Cable Loss + Read Level - Preamp Factor = Level.

## 4.7. Emissions Measurement

### 4.7.1. Limit

20dBc in any 100 kHz bandwidth outside the operating frequency band. In case the emission fall within the restricted band specified on 15.205(a), then the 15.209(a) limit in the table below has to be followed.

Frequencies (MHz)	Field Strength (micovolts/meter)	Measurement Distance (meters)
0.009~0.490	2400/F(kHz)	300
0.490~1.705	24000/F(kHz)	30
1.705~30.0	30	30
30~88	100	3
88~216	150	3
216~960	200	3
Above 960	500	3

### 4.7.2. Measuring Instruments and Setting

Please refer to section 5 of equipments list in this report. The following table is the setting of the spectrum analyzer.

Spectrum Parameter	Setting
Attenuation	Auto
Span Frequency	100 MHz
RBW / VBW (Emission in restricted band)	1MHz / 3MHz for Peak, 1MHz / 1/T for Average
RBW / VBW (20dBc in any 100 kHz bandwidth emission)	100 kHz /100 kHz for Peak

### 4.7.3. Test Procedures

For Radiated band edges Measurement:

1. The test procedure is the same as section 4.6.3.

For Radiated Out of Band Emission Measurement:

1. The test procedure is follow 15.247(d).

#### **4.7.4. Test Setup Layout**

For Radiated band edges Measurement:

This test setup layout is the same as that shown in section 4.6.4.

For Radiated Out of Band Emission Measurement:

This test setup layout is the same as that shown in section 4.6.4.

#### **4.7.5. Test Deviation**

There is no deviation with the original standard.

#### **4.7.6. EUT Operation during Test**

The EUT was programmed to be in continuously transmitting mode.



4.7.7. Test Result of Band Edge and Fundamental Emissions

Temperature	22°C	Humidity	54%
Test Engineer	Stim Sung/Jay Lo	Configurations	BR (GFSK) / Channel 0, 39, 78

Channel 0

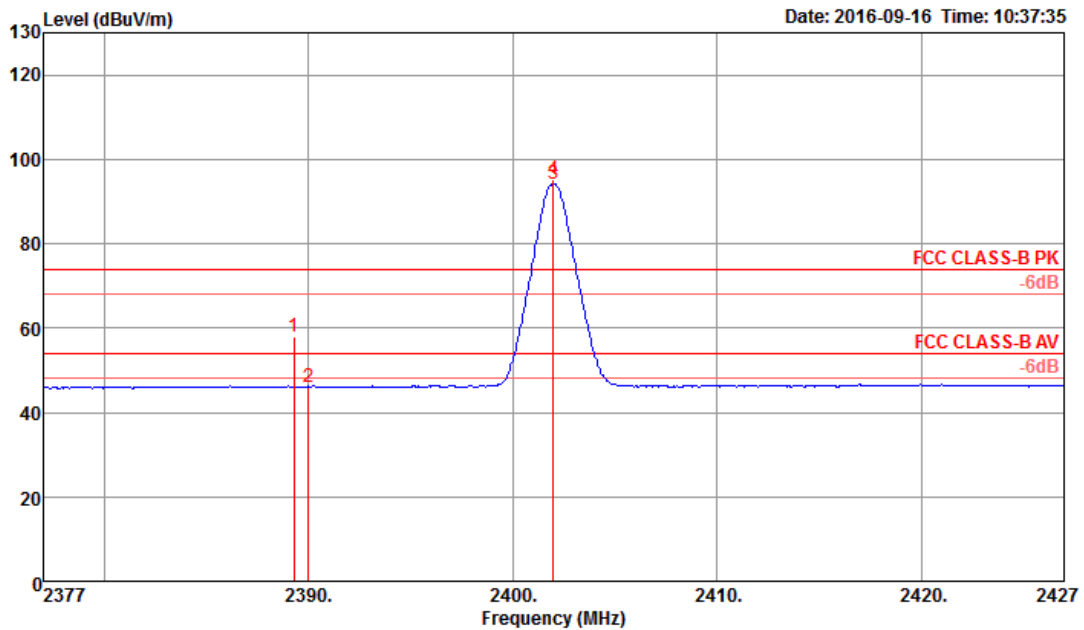

	Freq	Level	Limit	Over	Read	Cable	Antenna	Preamp	A/Pos	T/Pos	Remark	Pol/Phase
	MHz	dBuV/m	dBuV/m	dB	dBuV	dB	dB/m	dB	cm	deg		
1	2389.26	58.02	74.00	-15.98	26.11	3.60	28.31	0.00	103	156	Peak	VERTICAL
2	2390.00	46.17	54.00	-7.83	14.26	3.60	28.31	0.00	103	156	Average	VERTICAL
3 @	2402.00	94.31			62.36	3.61	28.34	0.00	103	156	Average	VERTICAL
4 @	2402.00	95.34			63.39	3.61	28.34	0.00	103	156	Peak	VERTICAL

Item 3, 4 are the fundamental frequency at 2402 MHz.

Channel 39

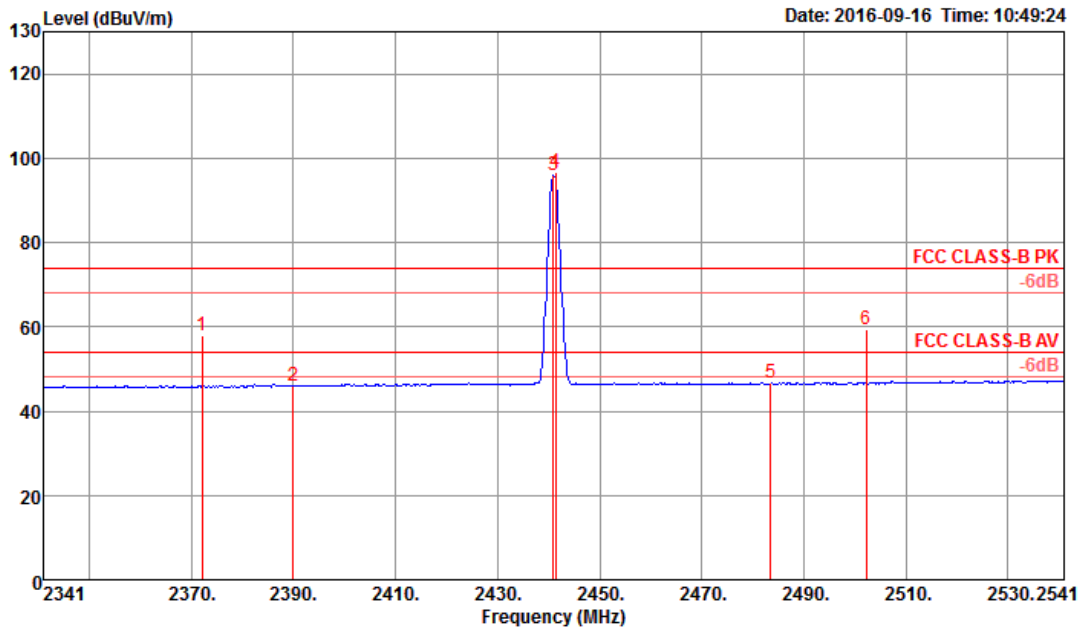

	Freq	Level	Limit	Over	Read	CableAntenna	Preamp	A/Pos	T/Pos	Remark	Pol/Phase
	MHz	dBuV/m	dBuV/m	dB	dBuV	dB	dB/m	dB	cm	deg	
1	2372.09	57.92	74.00	-16.08	26.04	3.59	28.29	0.00	111	151 Peak	VERTICAL
2	2390.00	45.89	54.00	-8.11	13.98	3.60	28.31	0.00	111	151 Average	VERTICAL
3 @	2441.00	95.82			63.77	3.64	28.41	0.00	111	151 Average	VERTICAL
4 @	2441.32	96.77			64.72	3.64	28.41	0.00	111	151 Peak	VERTICAL
5	2483.50	46.77	54.00	-7.23	14.61	3.68	28.48	0.00	111	151 Average	VERTICAL
6	2502.22	59.31	74.00	-14.69	27.12	3.69	28.50	0.00	111	151 Peak	VERTICAL

Item 3, 4 are the fundamental frequency at 2441 MHz.

Channel 78

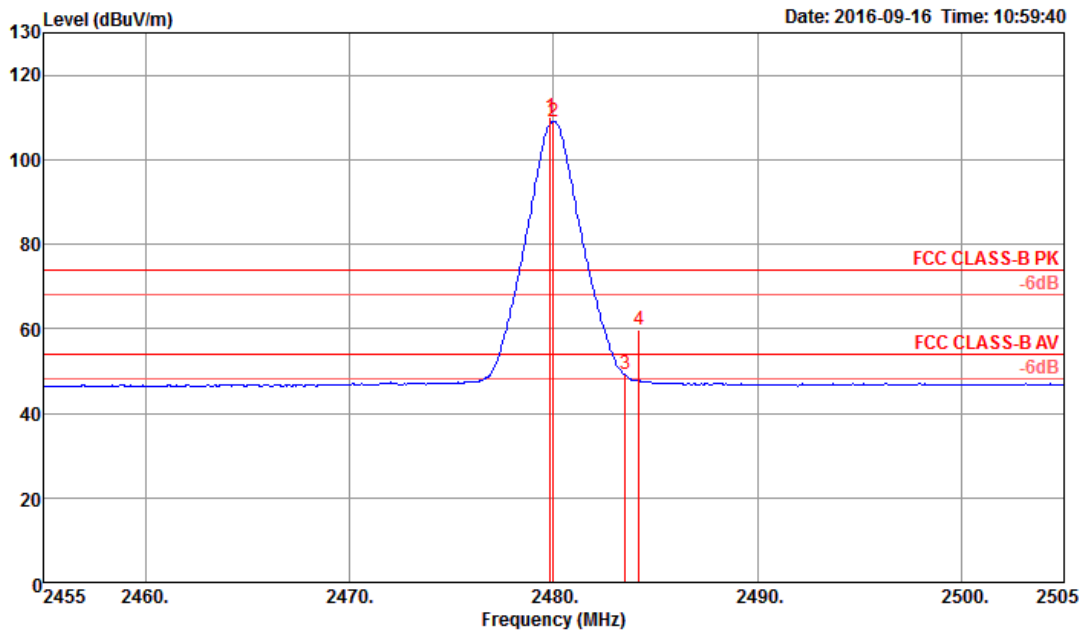

	Freq	Level	Limit Line	Over Limit	Read Level	Cable Loss	Antenna Factor	Preamp Factor	A/Pos	T/Pos	Remark	Po1/Phase
	MHz	dBuV/m	dBuV/m	dB	dBuV	dB	dB/m	dB	cm	deg		
1 @	2479.84	109.99			77.86	3.67	28.46	0.00	286	266	Peak	HORIZONTAL
2 @	2480.00	109.07			76.94	3.67	28.46	0.00	286	266	Average	HORIZONTAL
3	2483.50	49.09	54.00	-4.91	16.93	3.68	28.48	0.00	286	266	Average	HORIZONTAL
4	2484.17	59.74	74.00	-14.26	27.58	3.68	28.48	0.00	286	266	Peak	HORIZONTAL

Item 1, 2 are the fundamental frequency at 2480 MHz.

Note:

Emission level (dBuV/m) = 20 log Emission level (uV/m).

Corrected Reading: Antenna Factor + Cable Loss + Read Level - Preamp Factor = Level.

Temperature	22°C	Humidity	54%
Test Engineer	Stim Sung/Jay Lo	Configurations	EDR (8DPSK) / Channel 0, 39, 78

Channel 0

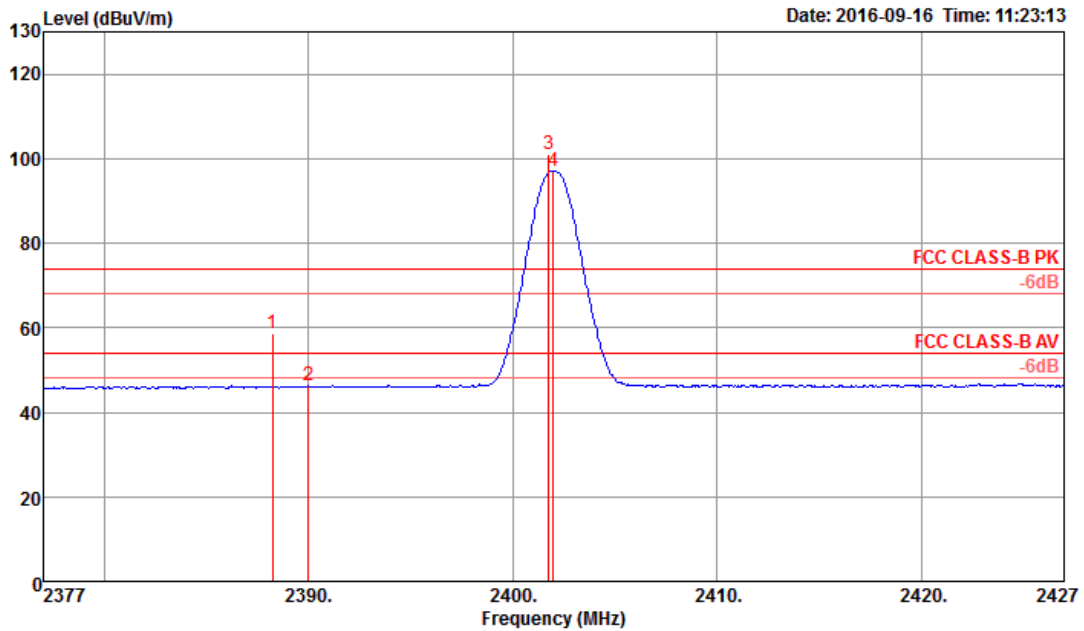

	Freq	Level	Limit Line	Over Limit	Read Level	CableAntenna Loss	Preamp Factor	A/Pos	T/Pos	Remark	Pol/Phase
	MHz	dBuV/m	dBuV/m	dB	dBuV	dB	dB/m	dB	cm	deg	
1	2388.22	58.71	74.00	-15.29	26.80	3.60	28.31	0.00	103	156 Peak	VERTICAL
2	2390.00	46.19	54.00	-7.81	14.28	3.60	28.31	0.00	103	156 Average	VERTICAL
3 @	2401.76	101.18			69.23	3.61	28.34	0.00	103	156 Peak	VERTICAL
4 @	2402.00	97.13			65.18	3.61	28.34	0.00	103	156 Average	VERTICAL

Item 3, 4 are the fundamental frequency at 2402 MHz.

Channel 39

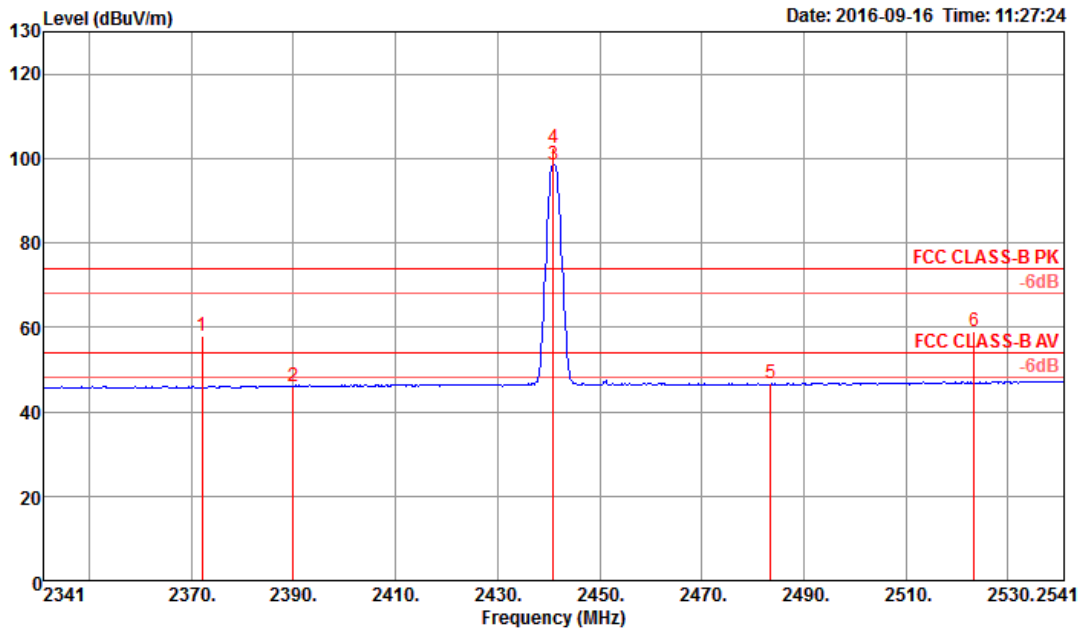

	Freq	Level	Limit Line	Over Limit	Read Level	CableAntenna Loss	Preamp Factor	A/Pos	T/Pos	Remark	Po1/Phase
	MHz	dBuV/m	dBuV/m	dB	dBuV	dB	dB/m	dB	cm	deg	
1	2372.09	57.87	74.00	-16.13	25.99	3.59	28.29	0.00	112	137 Peak	VERTICAL
2	2390.00	45.91	54.00	-8.09	14.00	3.60	28.31	0.00	112	137 Average	VERTICAL
3 @	2441.00	98.52			66.47	3.64	28.41	0.00	112	137 Average	VERTICAL
4 @	2441.00	102.65			70.60	3.64	28.41	0.00	112	137 Peak	VERTICAL
5	2483.50	46.55	54.00	-7.45	14.39	3.68	28.48	0.00	112	137 Average	VERTICAL
6	2523.37	59.11	74.00	-14.89	26.82	3.71	28.58	0.00	112	137 Peak	VERTICAL

Item 3, 4 are the fundamental frequency at 2441 MHz.

Channel 78

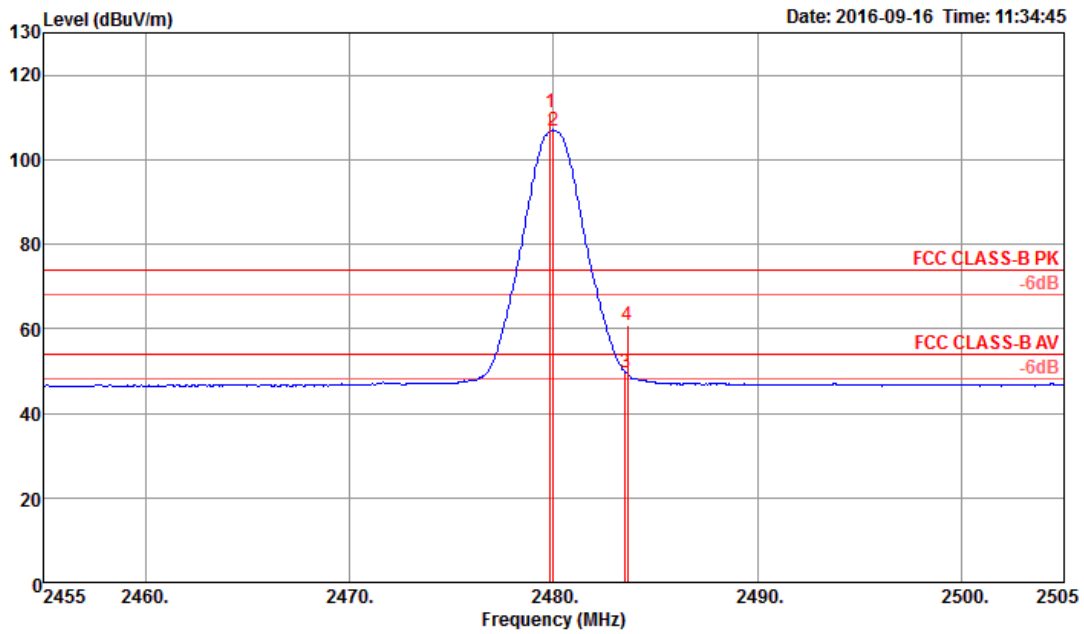

	Freq	Level	Limit Line	Over Limit	Read Level	Cable Loss	Antenna Factor	Preamp Factor	A/Pos	T/Pos	Remark	Pol/Phase
	MHz	dBuV/m	dBuV/m	dB	dBuV	dB	dB/m	dB	cm	deg		
1 @	2479.84	111.04			78.91	3.67	28.46	0.00	284	270	Peak	HORIZONTAL
2 @	2480.00	106.99			74.86	3.67	28.46	0.00	284	270	Average	HORIZONTAL
3	2483.50	49.78	54.00	-4.22	17.62	3.68	28.48	0.00	284	270	Average	HORIZONTAL
4	2483.61	60.69	74.00	-13.31	28.53	3.68	28.48	0.00	284	270	Peak	HORIZONTAL

Item 1, 2 are the fundamental frequency at 2480 MHz.

Note:

Emission level (dBuV/m) = 20 log Emission level (uV/m).

Corrected Reading: Antenna Factor + Cable Loss + Read Level - Preamp Factor = Level.

### Plot on Configuration For BR (GFSK) / Channel 0 / Reference Level

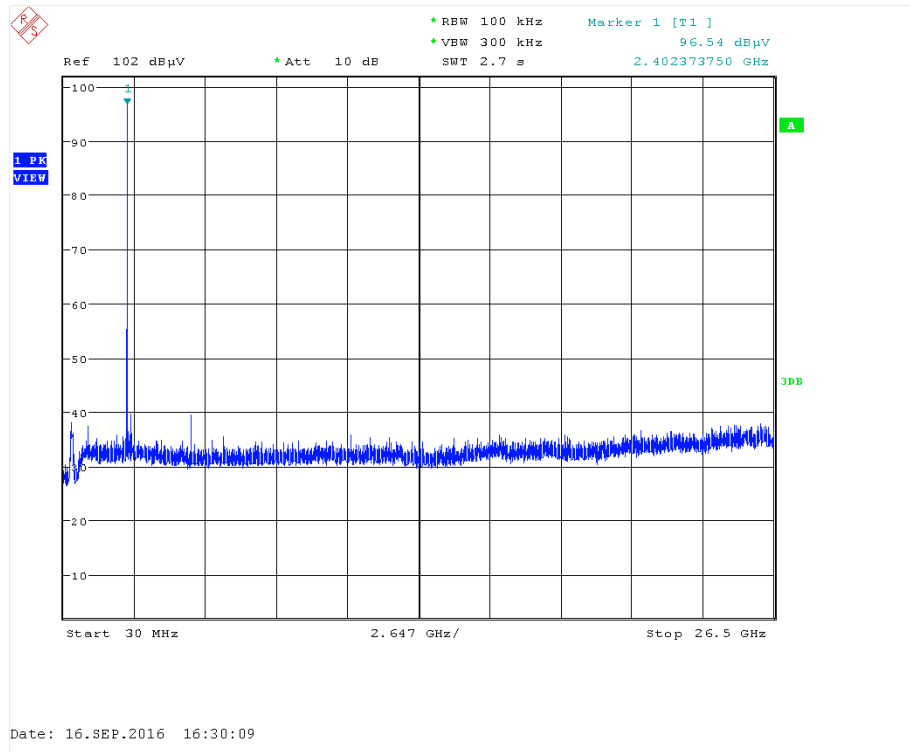

### Plot on Configuration For BR (GFSK) / Channel 0 / 30MHz~2400MHz (down 20dBc)

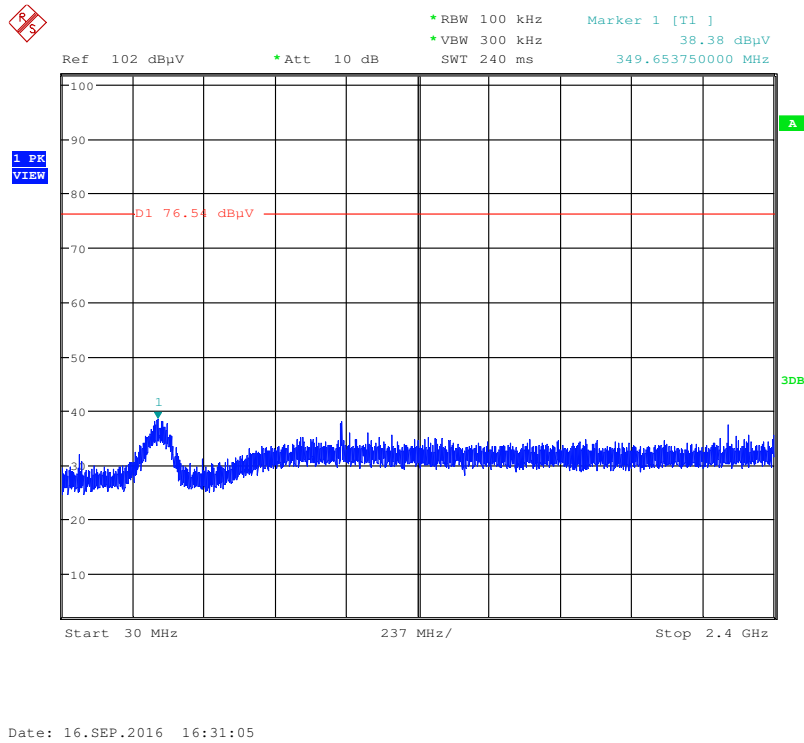

### Plot on Configuration For BR (GFSK) / Channel 0 / 2483.5MHz~26500MHz (down 20dBc)

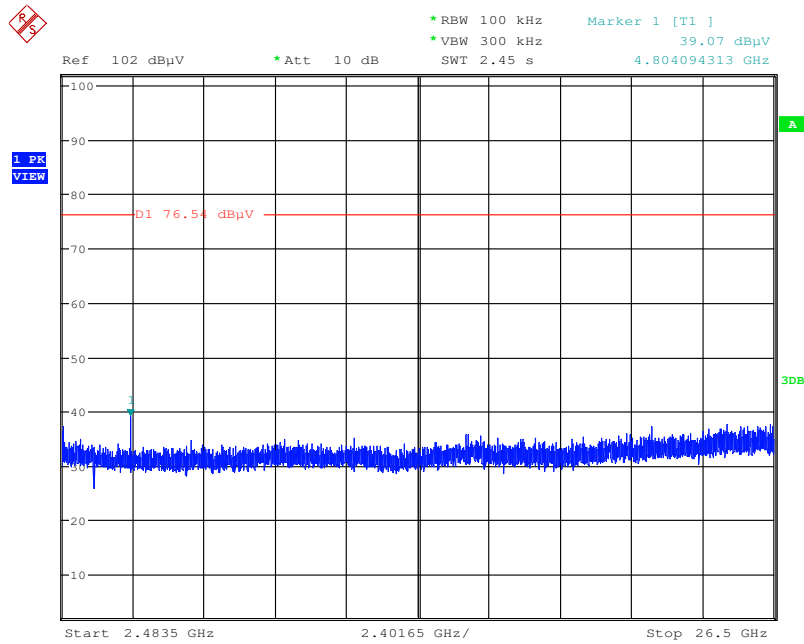

Date: 16.SEP.2016 16:31:41

### Plot on Configuration For BR (GFSK) / Channel 78 / Reference Level

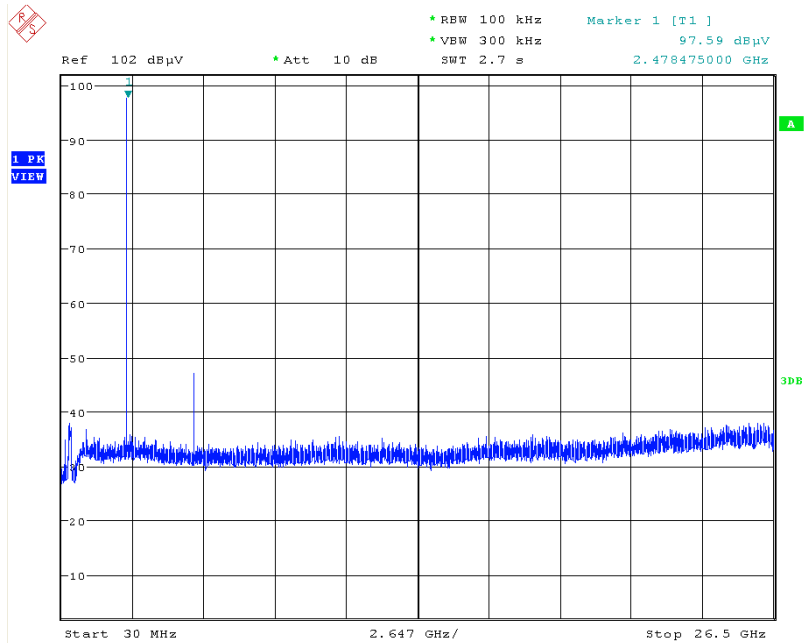

Date: 16.SEP.2016 16:36:47



**Plot on Configuration For BR (GFSK) / Channel 78 / 30MHz~2400MHz (down 20dBc)**

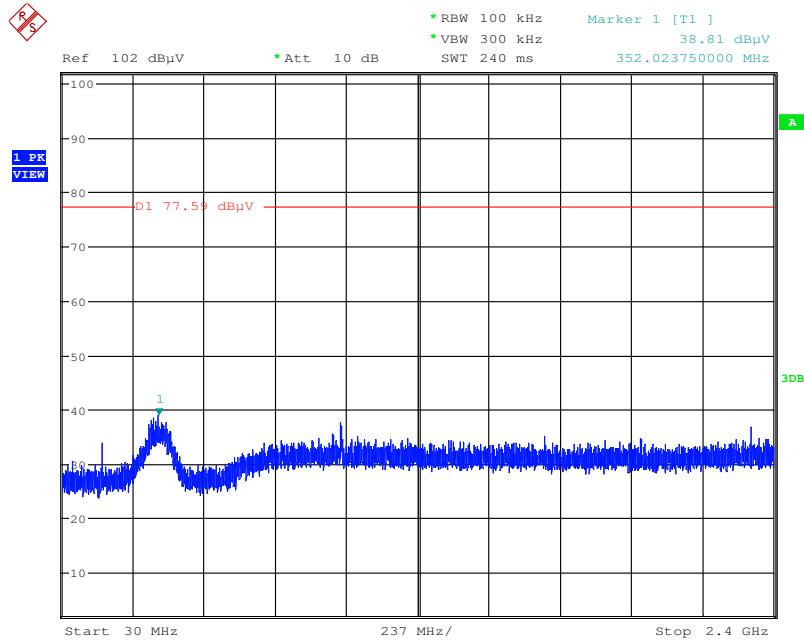

Date: 16.SEP.2016 16:37:41

**Plot on Configuration For BR (GFSK) / Channel 78 / 2483.5MHz~26500MHz (down 20dBc)**

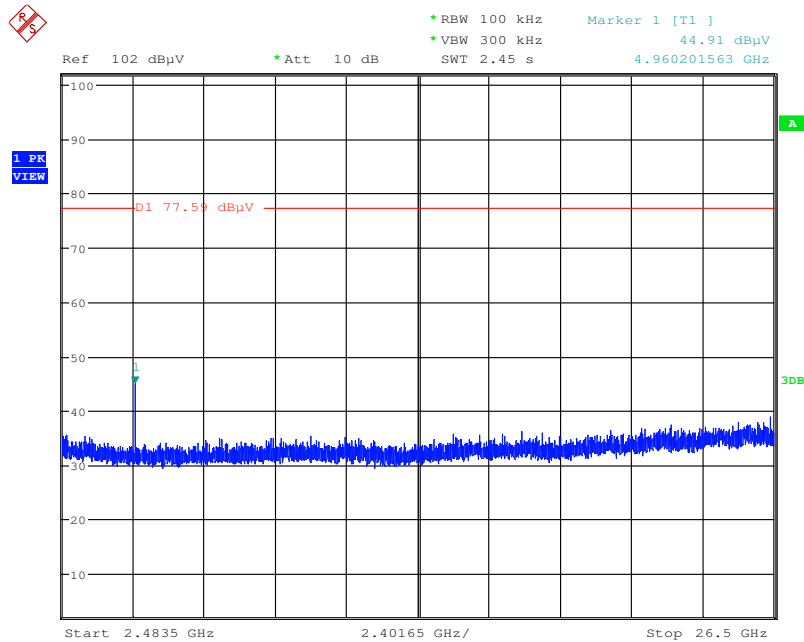

Date: 16.SEP.2016 16:50:57

Plot on Configuration For BR (GFSK) / Hopping / Reference Level

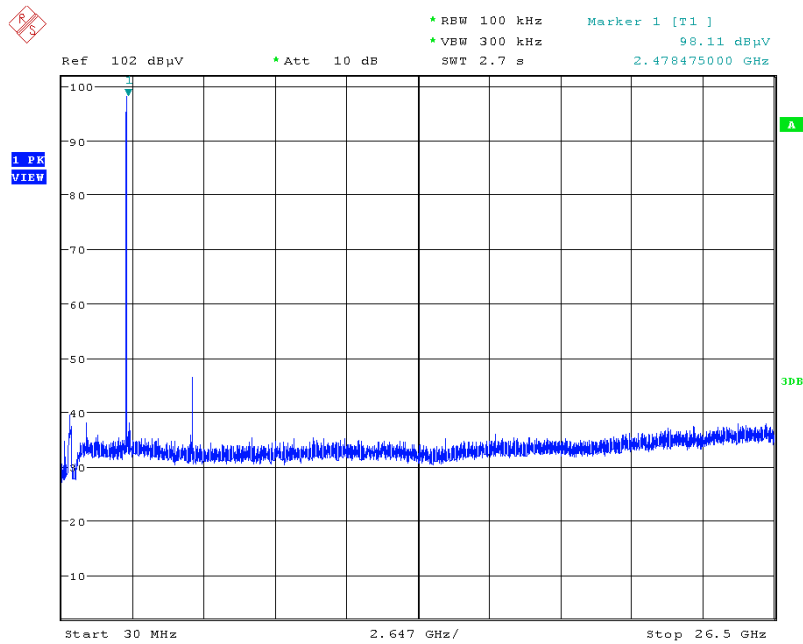

Date: 16.SEP.2016 17:04:10

Plot on Configuration For BR (GFSK) / Hopping / 30MHz~2400MHz (down 20dBc)

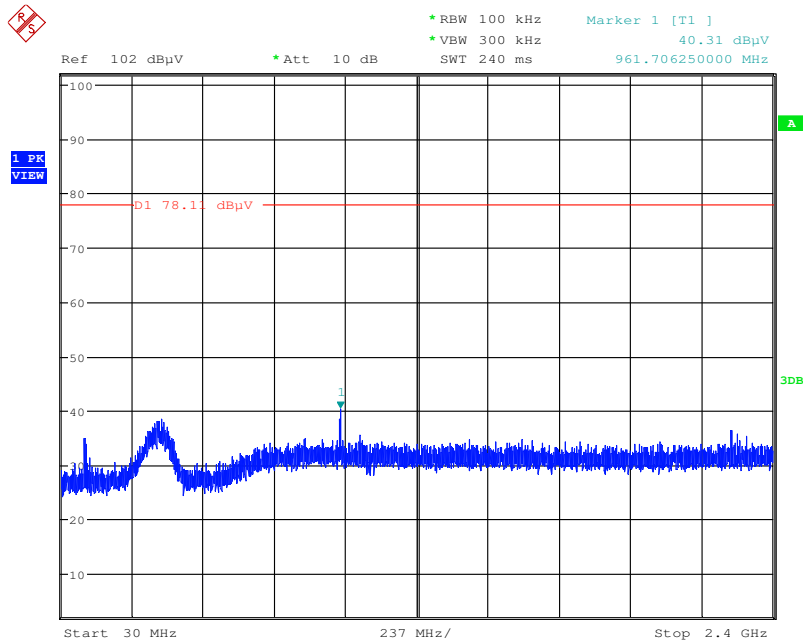

Date: 16.SEP.2016 17:04:54

### Plot on Configuration For BR (GFSK) / Hopping / 2483.5MHz~26500MHz (down 20dBc)

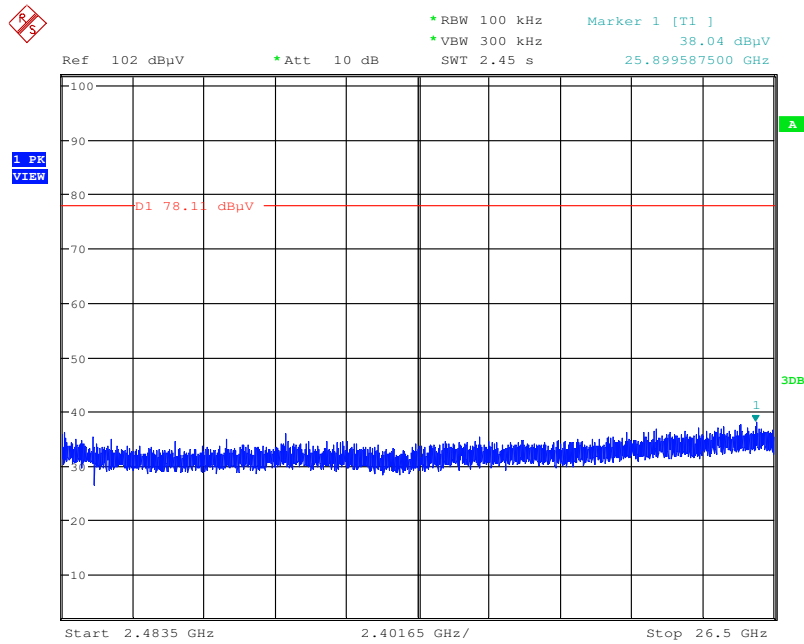

Date: 16.SEP.2016 17:05:37

Plot on Configuration For EDR (8DPSK) / Channel 0 / Reference Level

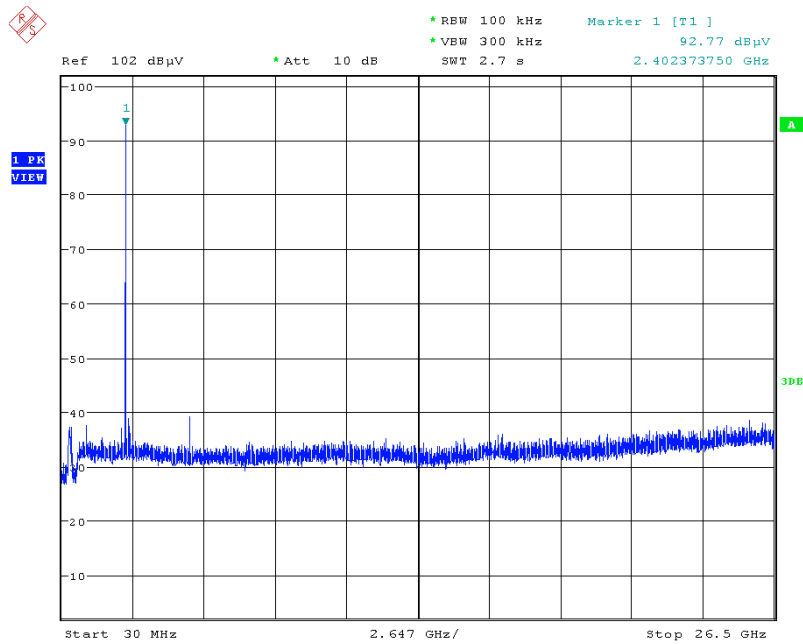

Date: 16.SEP.2016 16:54:01

Plot on Configuration For EDR (8DPSK) / Channel 0 / 30MHz~2400MHz (down 20dBc)

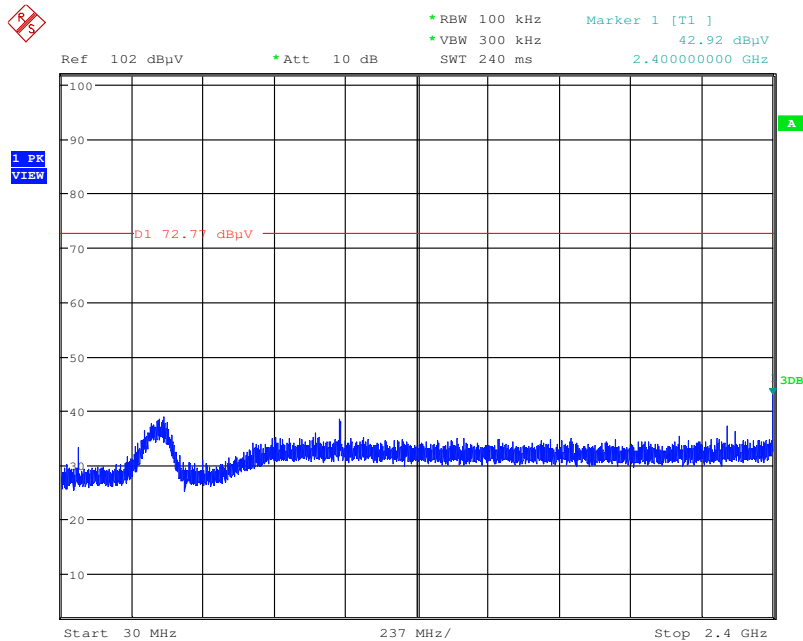

Date: 16.SEP.2016 16:54:55

### Plot on Configuration For EDR (8DPSK) / Channel 0 / 2483.5MHz~26500MHz (down 20dBc)

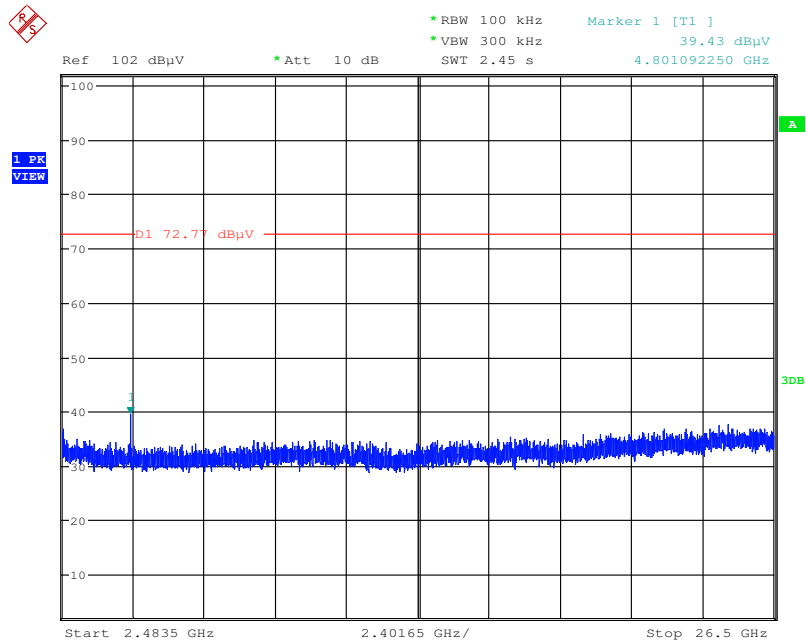

Date: 16.SEP.2016 16:57:20

### Plot on Configuration For EDR (8DPSK) / Channel 78 / Reference Level

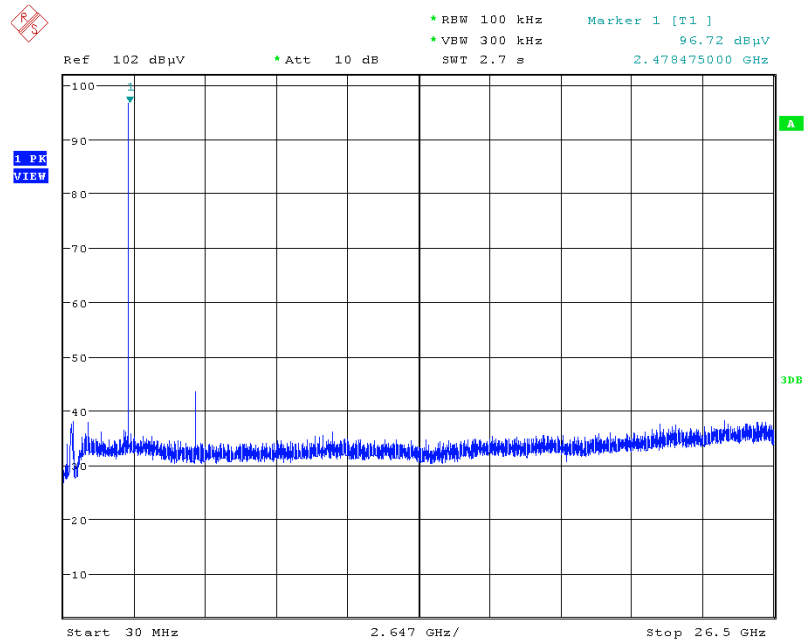

Date: 16.SEP.2016 16:59:19

Plot on Configuration For EDR (8DPSK) / Channel 78 / 30MHz~2400MHz (down 20dBc)

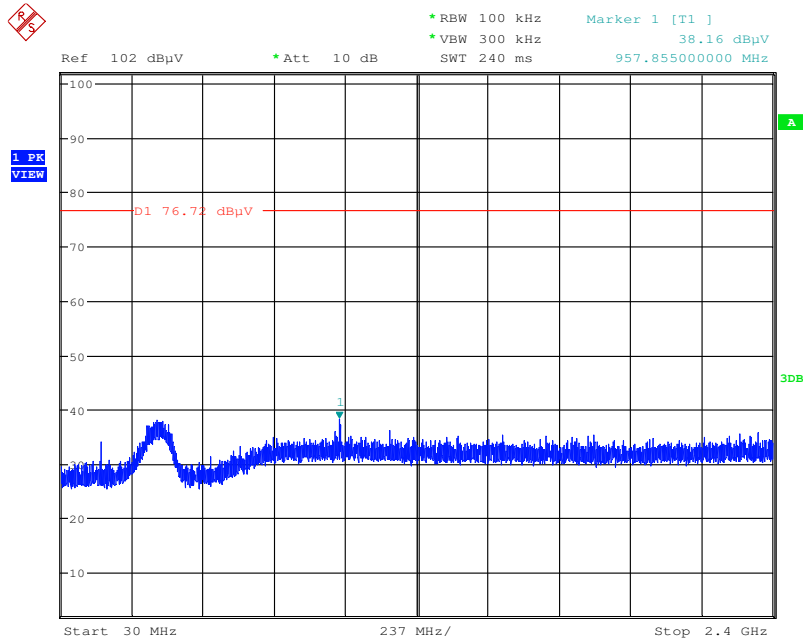

Date: 16.SEP.2016 17:00:48

Plot on Configuration For EDR (8DPSK) / Channel 78 / 2483.5MHz~26500MHz (down 20dBc)

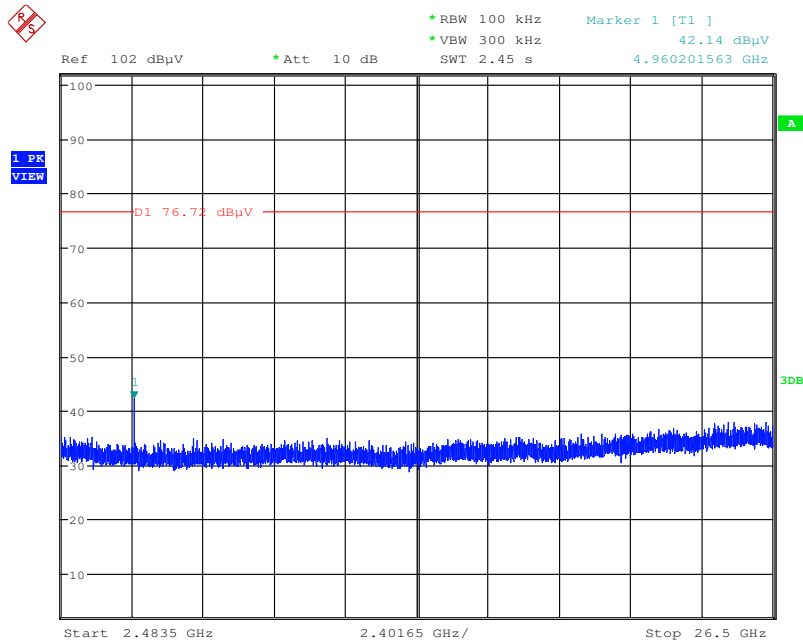

Date: 16.SEP.2016 17:01:31

Plot on Configuration For EDR (8DPSK) / Hopping / Reference Level

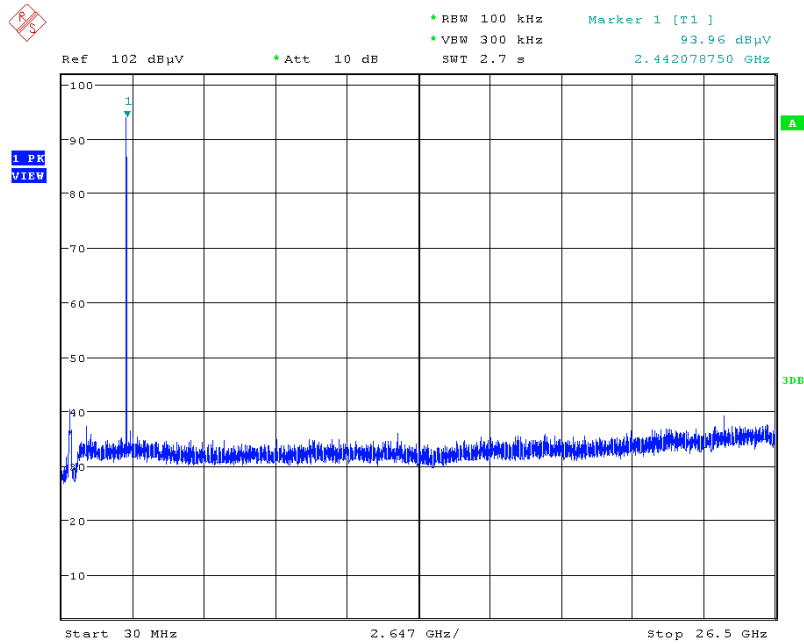

Date: 16.SEP.2016 17:07:01

Plot on Configuration For EDR (8DPSK) / Hopping / 30MHz~2400MHz (down 20dBc)

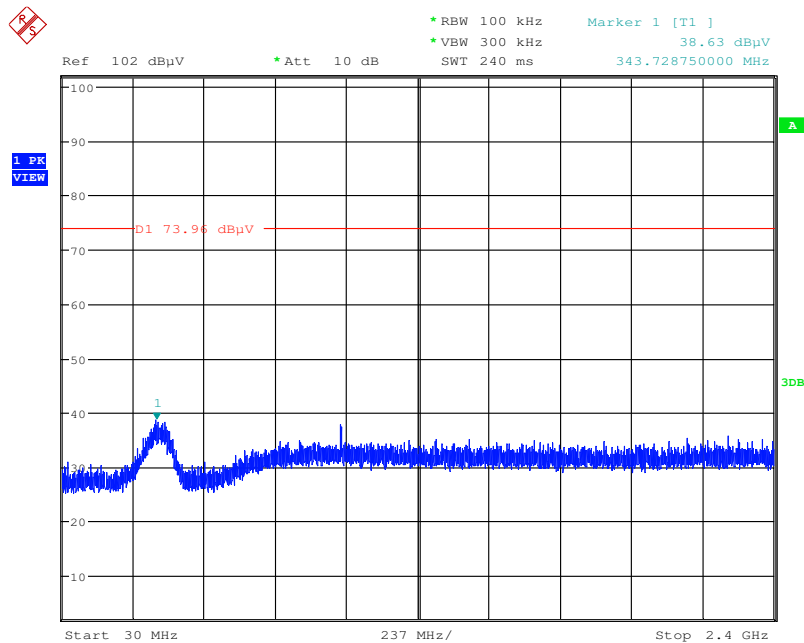

Date: 16.SEP.2016 17:07:41

Plot on Configuration For EDR (8DPSK) / Hopping / 2483.5MHz~26500MHz (down 20dBc)

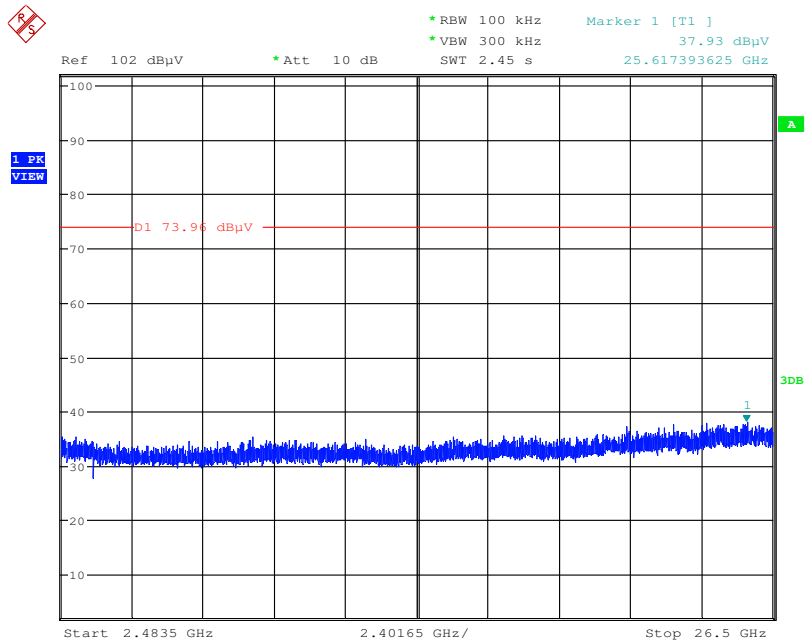

Date: 16.SEP.2016 17:09:14



## **4.8. Antenna Requirements**

### **4.8.1. Limit**

Except for special regulations, the Low-power Radio-frequency Devices must not be equipped with any jacket for installing an antenna with extension cable. An intentional radiator shall be designed to ensure that no antenna other than that furnished by the responsible party shall be used with the device. The use of a permanently attached antenna or of an antenna that uses a unique coupling to the intentional radiator shall be considered sufficient to comply with the provisions of this Section. The manufacturer may design the unit so that the user can replace a broken antenna, but the use of a standard antenna jack or electrical connector is prohibited.

### **4.8.2. Antenna Connector Construction**

Please refer to section 3.3 in this test report, antenna connector complied with the requirements.

## 5. LIST OF MEASURING EQUIPMENTS

Instrument	Manufacturer	Model No.	Serial No.	Characteristics	Calibration Date	Remark
EMI Receiver	Agilent	N9038A	My52260123	9kHz ~ 8.45GHz	Jan. 23, 2017	Conduction (CO01-CB)
LISN	F.C.C.	FCC-LISN-50-16-2	04083	150kHz ~ 100MHz	Dec. 14, 2016	Conduction (CO01-CB)
LISN	Schwarzbeck	NSLK 8127	8127647	9kHz ~ 30MHz	Dec. 21, 2016	Conduction (CO01-CB)
COND Cable	Woken	Cable	01	150kHz ~ 30MHz	May 24, 2016	Conduction (CO01-CB)
Software	Audix	E3	6.120210n	-	N.C.R.	Conduction (CO01-CB)
BILOG ANTENNA with 6dB Attenuator	TESEQ & EMCI	CBL6112D & N-6-06	37880 & AT-N0609	20MHz ~ 2GHz	Aug. 30, 2016	Radiation (03CH01-CB)
Loop Antenna	Teseq	HLA 6120	24155	9kHz - 30 MHz	Mar. 16, 2016*	Radiation (03CH01-CB)
Horn Antenna	EMCO	3115	00075790	750MHz ~ 18GHz	Oct. 22, 2015	Radiation (03CH01-CB)
Horn Antenna	EMCO	3115	00075790	750MHz ~ 18GHz	Nov. 10, 2016	Radiation (03CH01-CB)
Horn Antenna	Schwarzbeck	BBHA 9170	BBHA9170252	15GHz ~ 40GHz	Jul. 25, 2016	Radiation (03CH01-CB)
Pre-Amplifier	Agilent	8447D	2944A10991	0.1MHz ~ 1.3GHz	Mar. 13, 2017	Radiation (03CH01-CB)
Pre-Amplifier	Agilent	8449B	3008A02310	1GHz ~ 26.5GHz	Jan. 18, 2016	Radiation (03CH01-CB)
Pre-Amplifier	Agilent	8449B	3008A02310	1GHz ~ 26.5GHz	Jan. 16, 2017	Radiation (03CH01-CB)
Pre-Amplifier	WM	TF-130N-R1	923365	26GHz ~ 40GHz	Nov. 13, 2015	Radiation (03CH01-CB)
Pre-Amplifier	MITEQ	TTA1840-35-HG	1864479	18GHz ~ 40GHz	Jun. 28, 2016	Radiation (03CH01-CB)
Spectrum Analyzer	R&S	FSP40	100056	9kHz ~ 40GHz	Oct. 27, 2015	Radiation (03CH01-CB)
Spectrum Analyzer	R&S	FSP40	100056	9kHz ~ 40GHz	Nov. 21, 2016	Radiation (03CH01-CB)
EMI Test	R&S	ESCS	100355	9kHz ~ 2.75GHz	May 16, 2016	Radiation (03CH01-CB)
RF Cable-low	Woken	Low Cable-16+17	N/A	30 MHz ~ 1 GHz	Oct. 24, 2016	Radiation (03CH01-CB)
RF Cable-high	Woken	High Cable-16	N/A	1 GHz ~ 18 GHz	Nov. 02, 2015	Radiation (03CH01-CB)
RF Cable-high	Woken	High Cable-16	N/A	1 GHz ~ 18 GHz	Oct. 24, 2016	Radiation (03CH01-CB)
RF Cable-high	Woken	High Cable-17	N/A	1 GHz ~ 18 GHz	Nov. 02, 2015	Radiation (03CH01-CB)
RF Cable-high	Woken	High Cable-16+17	N/A	1 GHz ~ 18 GHz	Oct. 24, 2016	Radiation (03CH01-CB)
RF Cable-high	Woken	High Cable-40G-1	N/A	18GHz ~ 40 GHz	Nov. 02, 2015	Radiation (03CH01-CB)
RF Cable-high	Woken	High Cable-40G#1	N/A	18GHz ~ 40 GHz	Oct. 24, 2016	Radiation (03CH01-CB)
RF Cable-high	Woken	High Cable-40G-2	N/A	18GHz ~ 40 GHz	Nov. 02, 2015	Radiation (03CH01-CB)



Instrument	Manufacturer	Model No.	Serial No.	Characteristics	Calibration Date	Remark
RF Cable-high	Woken	High Cable-40G#2	N/A	18GHz ~ 40 GHz	Oct. 24, 2016	Radiation (03CH01-CB)
Test Software	Audix	E3	6.2009-10-7	N/A	N/A	Radiation (03CH01-CB)
Spectrum analyzer	R&S	FSV40	100979	9kHz~40GHz	Dec. 09, 2015	Conducted (TH01-CB)
RF Cable-high	Woken	RG402	High Cable-6	1 GHz – 26.5 GHz	Nov. 02, 2015	Conducted (TH01-CB)
RF Cable-high	Woken	RG402	High Cable-7	1 GHz – 26.5 GHz	Nov. 02, 2015	Conducted (TH01-CB)
RF Cable-high	Woken	RG402	High Cable-8	1 GHz – 26.5 GHz	Nov. 02, 2015	Conducted (TH01-CB)
RF Cable-high	Woken	RG402	High Cable-9	1 GHz – 26.5 GHz	Nov. 02, 2015	Conducted (TH01-CB)
RF Cable-high	Woken	RG402	High Cable-10	1 GHz – 26.5 GHz	Nov. 02, 2015	Conducted (TH01-CB)
Power Sensor	Agilent	U2021XA	MY53410001	50MHz~18GHz	Nov. 02, 2015	Conducted (TH01-CB)

Note: Calibration Interval of instruments listed above is one year.

\*Calibration Interval of instruments listed above is two years.

N.C.R. means Non-Calibration required.

## 6. MEASUREMENT UNCERTAINTY

Test Items	Uncertainty	Remark
Conducted Emission (150kHz ~ 30MHz)	3.2 dB	Confidence levels of 95%
Radiated Emission (30MHz ~ 1,000MHz)	3.6 dB	Confidence levels of 95%
Radiated Emission (1GHz ~ 18GHz)	3.7 dB	Confidence levels of 95%
Radiated Emission (18GHz ~ 40GHz)	3.5 dB	Confidence levels of 95%
Conducted Emission	1.7 dB	Confidence levels of 95%