



FCC TEST REPORT (WLAN 15.407)

REPORT NO.: RF140407E07-1

MODEL NO.: AW-CM389NF

FCC ID: TLZ-CM389NF

RECEIVED: Apr. 07, 2014

TESTED: Apr. 29 to May 22, 2014

ISSUED: July 02, 2014

APPLICANT: AzureWave Technologies, Inc.

ADDRESS: 8 F., No. 94, Baozhong Rd., Xindian, Taipei,
Taiwan 231

ISSUED BY: Bureau Veritas Consumer Products Services
(H.K.) Ltd., Taoyuan Branch Hsin Chu Laboratory

LAB ADDRESS : No. 81-1, Lu Liao Keng, 9th Ling, Wu Lung Tsuen,
Chiung Lin Hsiang, Hsin Chu Hsien 307, Taiwan,
R.O.C.

TEST LOCATION (1): No. 81-1, Lu Liao Keng, 9th Ling, Wu Lung Tsuen,
Chiung Lin Hsiang, Hsin Chu Hsien 307, Taiwan,
R.O.C.

TEST LOCATION (2): No. 49, Ln. 206, Wende Rd., Shangshan Tsuen,
Chiung Lin Hsiang, Hsin Chu Hsien 307, Taiwan,
R.O.C.

This report should not be used by the client to claim product certification, approval, or endorsement by TAF or any government agencies.



This report is for your exclusive use. Any copying or replication of this report to or for any other person or entity, or use of our name or trademark, is permitted only with our prior written permission. This report sets forth our findings solely with respect to the test samples identified herein. The results set forth in this report are not indicative or representative of the quality or characteristics of the lot from which a test sample was taken or any similar or identical product unless specifically and expressly noted. Our report includes all of the tests requested by you and the results thereof based upon the information that you provided to us. You have 60 days from date of issuance of this report to notify us of any material error or omission caused by our negligence, provided, however, that such notice shall be in writing and shall specifically address the issue you wish to raise. A failure to raise such issue within the prescribed time shall constitute your unqualified acceptance of the completeness of this report, the tests conducted and the correctness of the report contents. Unless specific mention, the uncertainty of measurement has been explicitly taken into account to declare the compliance or non-compliance to the specification



Table of Contents

RELEASE CONTROL RECORD	4
1. CERTIFICATION	5
2. SUMMARY OF TEST RESULTS	6
2.1 MEASUREMENT UNCERTAINTY	7
3. GENERAL INFORMATION.....	8
3.1 GENERAL DESCRIPTION OF EUT (WLAN)	8
3.2 DESCRIPTION OF TEST MODES	12
3.2.1 TEST MODE APPLICABILITY AND TESTED CHANNEL DETAIL	13
3.3 GENERAL DESCRIPTION OF APPLIED STANDARDS	15
3.4 DUTY CYCLE OF TEST SIGNAL.....	16
3.5 DESCRIPTION OF SUPPORT UNITS	20
3.6 CONFIGURATION OF SYSTEM UNDER TEST	21
4. TEST TYPES AND RESULTS	22
4.1 CONDUCTED EMISSION MEASUREMENT	22
4.1.1 LIMITS OF CONDUCTED EMISSION MEASUREMENT	22
4.1.2 TEST INSTRUMENTS	22
4.1.3 TEST PROCEDURES	23
4.1.4 DEVIATION FROM TEST STANDARD	23
4.1.5 TEST SETUP	23
4.1.6 EUT OPERATING CONDITIONS	24
4.1.7 TEST RESULTS	25
4.2 RADIATED EMISSION AND BANDEDGE MEASUREMENT	27
4.2.1 LIMITS OF RADIATED EMISSION AND BANDEDGE MEASUREMENT	27
4.2.2 LIMITS OF UNWANTED EMISSION OUT OF THE RESTRICTED BANDS	27
4.2.3 TEST INSTRUMENTS	28
4.2.4 TEST PROCEDURES	29
4.2.5 DEVIATION FROM TEST STANDARD	29
4.2.6 TEST SETUP	30
4.2.7 EUT OPERATING CONDITION	30
4.2.8 TEST RESULTS	31
4.3 TRANSMIT POWER MEASUREMENT	62
4.3.1 LIMITS OF TRANSMIT POWER MEASUREMENT	62
4.3.2 TEST INSTRUMENTS	63
4.3.3 TEST PROCEDURE	63
4.3.4 DEVIATION FROM TEST STANDARD	64
4.3.5 TEST SETUP	64
4.3.6 EUT OPERATING CONDITIONS	64
4.3.7 TEST RESULTS	65



A D T

4.4	PEAK POWER SPECTRAL DENSITY MEASUREMENT	72
4.4.1	LIMITS OF PEAK POWER SPECTRAL DENSITY MEASUREMENT.....	72
4.4.2	TEST INSTRUMENTS	72
4.4.3	TEST PROCEDURES	72
4.4.4	DEVIATION FROM TEST STANDARD	72
4.4.5	TEST SETUP	72
4.4.6	EUT OPERATING CONDITIONS	73
4.4.7	TEST RESULTS	74
4.5	PEAK POWER EXCURSION MEASUREMENT	78
4.5.1	LIMITS OF PEAK POWER EXCURSION MEASUREMENT.....	78
4.5.2	TEST INSTRUMENTS	78
4.5.3	TEST PROCEDURE	78
4.5.4	DEVIATION FROM TEST STANDARD	78
4.5.5	TEST SETUP	78
4.5.6	EUT OPERATING CONDITIONS	79
4.5.7	TEST RESULTS	80
4.6	FREQUENCY STABILITY	83
4.6.1	LIMITS OF FREQUENCY STABILITY MEASUREMENT	83
4.6.2	TEST INSTRUMENTS	83
4.6.3	TEST PROCEDURE	83
4.6.4	DEVIATION FROM TEST STANDARD	84
4.6.5	TEST SETUP	84
4.6.6	EUT OPERATING CONDITION	84
4.6.7	TEST RESULTS	85
5.	PHOTOGRAPHS OF THE TEST CONFIGURATION.....	86
6.	INFORMATION ON THE TESTING LABORATORIES	87
7.	APPENDIX A - MODIFICATIONS RECORDERS FOR ENGINEERING CHANGES TO THE EUT BY THE LAB.....	88



A D T

RELEASE CONTROL RECORD

ISSUE NO.	REASON FOR CHANGE	DATE ISSUED
RF140407E07-1	Original release	July 02, 2014

1. CERTIFICATION

PRODUCT: IEEE 802.11 2X2 MIMO a/b/g/n/ac Wireless LAN +
Bluetooth + NFC NGFF Module

BRAND NAME: AzureWave

MODEL NO.: AW-CM389NF

TEST SAMPLE: ENGINEERING SAMPLE

APPLICANT: AzureWave Technologies, Inc.

TESTED: Apr. 29 to May 22, 2014

STANDARDS: **FCC Part 15, Subpart E (Section 15.407)**
ANSI C63.10-2009

The above equipment (Model: AW-CM389NF) has been tested by **Bureau Veritas Consumer Products Services (H.K.) Ltd., Taoyuan Branch**, and found compliance with the requirement of the above standards. The test record, data evaluation & Equipment Under Test (EUT) configurations represented herein are true and accurate accounts of the measurements of the sample's EMC characteristics under the conditions specified in this report.

PREPARED BY : Phoenix Huang , **DATE:** July 02, 2014
(Phoenix Huang, Specialist)

APPROVED BY : May Chen , **DATE:** July 02, 2014
(May Chen, Manager)



A D T

2. SUMMARY OF TEST RESULTS

The EUT has been tested according to the following specifications:

APPLIED STANDARD: FCC PART 15, SUBPART E (SECTION 15.407)			
STANDARD SECTION	TEST TYPE	RESULT	REMARK
15.407(b)(6)	AC Power Conducted Emission	PASS	Meet the requirement of limit. Minimum passing margin is -13.28dB at 0.45469MHz
15.407(b/1/2/3) (b)(6)	Spurious Emissions	PASS	Meet the requirement of limit. Minimum passing margin is -0.6dB at 5470.00MHz.
15.407(a/1/2)	Transmit Power	PASS	Meet the requirement of limit.
15.407(a)(6)	Peak Power Excursion	PASS	Meet the requirement of limit.
15.407(a/1/2)	Peak Power Spectral Density	PASS	Meet the requirement of limit.
15.407(g)	Frequency Stability	PASS	Meet the requirement of limit.
15.203	Antenna Requirement	PASS	Antenna connector is i-pex(MHF) not a standard connector.

NOTE: 1. For WLAN: The EUT was operating in 2400 ~ 2483.5MHz, 5.15~5.35GHz, 5.47~5.6GHz & 5.65~5.725GHz and 5.725~5.850GHz frequencies band. This report was recorded the RF parameters including 5.15~5.35GHz, 5.47~5.6GHz & 5.65~5.725GHz. For the 2400 ~ 2483.5MHz and 5.725~5.850GHz RF parameters was recorded in another test report.

2. The DFS report was recorded in another test report.



A D T

2.1 MEASUREMENT UNCERTAINTY

Where relevant, the following measurement uncertainty levels have been estimated for tests performed on the EUT as specified in CISPR 16-4-2:

This uncertainty represents an expanded uncertainty expressed at approximately the 95% confidence level using a coverage factor of $k=2$.

Measurement	Value
Conducted emissions	2.86 dB
Radiated emissions (30MHz-1GHz)	5.43 dB
Radiated emissions (1GHz -6GHz)	3.65 dB
Radiated emissions (6GHz -18GHz)	3.88 dB
Radiated emissions (18GHz -40GHz)	4.11 dB



3. GENERAL INFORMATION

3.1 GENERAL DESCRIPTION OF EUT (WLAN)

PRODUCT	IEEE 802.11 2X2 MIMO a/b/g/n/ac Wireless LAN + Bluetooth + NFC NGFF Module
MODEL NO.	AW-CM389NF
POWER SUPPLY	3.3Vdc (from host equipment)
MODULATION TYPE	CCK, DQPSK, DBPSK for DSSS 64QAM, 16QAM, QPSK, BPSK for OFDM BT-LE (GFSK) for DTS 256QAM for OFDM in 11ac mode only
MODULATION TECHNOLOGY	DSSS, OFDM, DTS
TRANSFER RATE	802.11b: up to 11Mbps 802.11a / g: up to 54Mbps 802.11n: up to 300Mbps 802.11ac: up to 866.7Mbps BT-LE (GFSK): 1Mbps
OPERATING FREQUENCY	For 15.407 5GHz: 5.18 ~ 5.24GHz, 5.26 ~ 5.32GHz, 5.50 ~ 5.58GHz & 5.66GHz ~ 5.70GHz
	For 15.247 2.4GHz: 2.412 ~ 2.462GHz 5GHz: 5.745 ~ 5.825GHz BT-LE(GFSK): 2.402 ~ 2.480GHz
NUMBER OF CHANNEL	For 15.407 16 for 802.11a, 802.11n (HT20), 802.11ac (VHT20) 7 for 802.11n (HT40), 802.11ac (VHT40) 3 for 802.11ac (VHT80)
	For 15.247 (2.4GHz) 11 for 802.11b, 802.11g, 802.11n (HT20) 7 for 802.11n (HT40) 40 for BT-LE(GFSK) For 15.247 (5GHz) 5 for 802.11a, 802.11n (HT20), 802.11ac (VHT20) 2 for 802.11n (HT40), 802.11ac (VHT40) 1 for 802.11ac (VHT80)



MAXIMUM OUTPUT POWER	For 15.407 802.11a: 74.508mW 802.11ac (VHT20): 76.001mW 802.11ac (VHT40): 67.59mW 802.11ac (VHT80): 16.936mW For 15.247 (2.4GHz) 802.11b: 71.042mW 802.11g: 694.376mW 802.11n (HT20): 695.976mW 802.11n (HT40): 286.123mW BT-LE(GFSK): 7.709mW For 15.247 (5GHz) 802.11a: 372.853mW 802.11ac (VHT20): 370.202mW 802.11ac (VHT40): 335.013mW 802.11ac (VHT80): 541.874mW
ANTENNA TYPE	Please see NOTE
DATA CABLE	NA
I/O PORTS	Refer to user's manual
ASSOCIATED DEVICES	NA

Note:

1. There are Bluetooth, WLAN and NFC technology used for the EUT.
2. WLAN/BT/NFC coexistence mode:

Condition	Technology		
1	WLAN(2.4GHz) 1Tx only	BT	NFC
2	WLAN(5GHz) 1Tx only	BT	NFC

From above coexistence mode, radiated emission of the simultaneous operation has been evaluated and no non-compliance was found.



3. The antennas provided to the EUT, please refer to the following table:

For WLAN / BT used (Set 1 antenna)								
Antenna No.	Transmitter Circuit	Brand	Model	Antenna Gain(dBi) < including cable loss>	Frequency range (MHz to MHz)	Antenna Type	Connector Type	Cable Length (cm)
1	Chain (0)	MAG.LAYERS	MSA-4008-25GC1-A1	2.98	2400~2500	PIFA	i-pec(MHF)	15
				5.16	4900~5900			
2	Chain (1)	MAG.LAYERS	MSA-4008-25GC1-A1	2.98	2400~2500	PIFA	i-pec(MHF)	15
				5.16	4900~5900			
For WLAN / BT used (Set 2 antenna)								
Antenna No.	Transmitter Circuit	Brand	Model	Antenna Gain(dBi) < including cable loss>	Frequency range (MHz to MHz)	Antenna Type	Connector Type	Cable Length (cm)
3	Main Antenna Chain 0	Wistron Neweb Corporation	DC33001KT00 (81EAAL15.G92)	1.54	2400~2500	PIFA	i-pec(MHF)	36.3
				1.26	5150~5850			
4	Aux Antenna Chain 1	Wistron Neweb Corporation	DC33001KT10 (81EAAL15.G75)	0.63	2400~2500	PIFA	i-pec(MHF)	59.3
				1.84	5150~5850			
For NFC used								
Antenna No.	Brand	Model	Antenna Gain(dBi)	Frequency range (MHz)	Antenna Type	Connector Type	Cable Length (cm)	
5	Marvell	30X40X4T_PCB	0.5	13.56	PCB	i-pec(MHF)	N/A	

From the above antenna sets, the **set 1** was selected as representative antenna for the test and its data was recorded in this report.

4. The EUT incorporates a MIMO function without Beamforming.

MODULATION MODE	DATA RATE (MCS)	TX & RX CONFIGURATION	
802.11a	6 ~ 54Mbps	1Tx diversity/2TX(CDD)	1Rx diversity/2RX
802.11b	1 ~ 11Mbps	1Tx diversity/2TX(CDD)	1Rx diversity/2RX
802.11g	6 ~ 54Mbps	1Tx diversity/2TX(CDD)	1Rx diversity/2RX
802.11n (HT20)	MCS 0~7	1Tx	1Rx diversity
	MCS 8~15	2Tx	2Rx
802.11n (HT40)	MCS 0~7	1Tx	1Rx diversity
	MCS 8~15	2Tx	2Rx
802.11ac (VHT20) (5GHz)	MCS0~8 (256QAM) Nss=1	1Tx	1Rx diversity
	MCS0~8 (256QAM) Nss=2	2Tx	2Rx
802.11ac (VHT40) (5GHz)	MCS0~9 (256QAM) Nss=1	1Tx	1Rx diversity
	MCS0~9 (256QAM) Nss=2	2Tx	2Rx
802.11ac (VHT80) (5GHz)	MCS0~9 (256QAM) Nss=1	1Tx	1Rx diversity
	MCS0~9 (256QAM) Nss=2	2Tx	2Rx

Note: The modulation and bandwidth are similar for 802.11n mode for 20MHz (40MHz) and 802.11ac mode for 20MHz (40MHz), therefore investigated worst case to representative mode in test report. (Final test mode refer section 3.2.1)

5. The above EUT information was declared by the manufacturer and for more detailed features description, please refer to the manufacturer's specifications or User's Manual.

3.2 DESCRIPTION OF TEST MODES

Operated in 5150 ~ 5350MHz band:

8 channels are provided for 802.11a, 802.11n (HT20), 802.11ac (VHT20):

CHANNEL	FREQUENCY	CHANNEL	FREQUENCY
36	5180 MHz	52	5260 MHz
40	5200 MHz	56	5280 MHz
44	5220 MHz	60	5300 MHz
48	5240 MHz	64	5320 MHz

4 channels are provided for 802.11n (HT40), 802.11ac (VHT40):

CHANNEL	FREQUENCY
38	5190 MHz
46	5230 MHz
54	5270 MHz
62	5310 MHz

2 channels are provided for 802.11ac (VHT80):

CHANNEL	FREQUENCY
42	5210 MHz
58	5290 MHz

Operated in 5470MHz ~ 5600MHz & 5650MHz ~ 5725MHz bands:

8 channels are provided for 802.11a, 802.11n (HT20), 802.11ac (VHT20):

CHANNEL	FREQUENCY	CHANNEL	FREQUENCY
100	5500 MHz	116	5580 MHz
104	5520 MHz	132	5660 MHz
108	5540 MHz	136	5680 MHz
112	5560 MHz	140	5700 MHz

3 channels are provided for 802.11n (HT40), 802.11ac (VHT40):

CHANNEL	FREQUENCY
102	5510 MHz
110	5550 MHz
134	5670 MHz

1 channel is provided for 802.11ac (VHT80):

CHANNEL	FREQUENCY
106	5530 MHz

3.2.1 TEST MODE APPLICABILITY AND TESTED CHANNEL DETAIL

EUT CONFIGURE MODE	APPLICABLE TO				DESCRIPTION
	PLC	RE < 1G	RE ≥ 1G	APCM	
-	√	√	√	√	-

Where **PLC**: Power Line Conducted Emission

RE < 1G: Radiated Emission below 1GHz

RE ≥ 1G: Radiated Emission above 1GHz

APCM: Antenna Port Conducted Measurement

NOTE: 1. For 5GHz: The EUT's antenna (PIFA) had been pre-tested on the positioned of each 3 axis. The worst case was found when positioned on **X-plane**.

POWER LINE CONDUCTED EMISSION TEST:

Pre-Scan has been conducted to determine the worst-case mode from all possible combinations between available modulations, data rates and antenna ports (if EUT with antenna diversity architecture).

Following channel(s) was (were) selected for the final test as listed below.

MODE	AVAILABLE CHANNEL	TESTED CHANNEL	MODULATION TECHNOLOGY	MODULATION TYPE	DATA RATE (Mbps)
802.11a	36 to 140	116	OFDM	BPSK	6

RADIATED EMISSION TEST (BELOW 1 GHz):

Pre-Scan has been conducted to determine the worst-case mode from all possible combinations between available modulations, data rates and antenna ports (if EUT with antenna diversity architecture).

Following channel(s) was (were) selected for the final test as listed below.

MODE	AVAILABLE CHANNEL	TESTED CHANNEL	MODULATION TECHNOLOGY	MODULATION TYPE	DATA RATE (Mbps)
802.11a	36 to 140	116	OFDM	BPSK	6



RADIATED EMISSION TEST (ABOVE 1 GHz):

- Pre-Scan has been conducted to determine the worst-case mode from all possible combinations between available modulations, data rates and antenna ports (if EUT with antenna diversity architecture).
- Following channel(s) was (were) selected for the final test as listed below.

MODE	AVAILABLE CHANNEL	TESTED CHANNEL	MODULATION TECHNOLOGY	MODULATI ON TYPE	DATA RATE (Mbps)
802.11a	36 to 140	36, 40, 48, 52, 60, 64, 100, 116, 132, 140	OFDM	BPSK	6
802.11ac (VHT20)	36 to 140	36, 40, 48, 52, 60, 64, 100, 116, 132, 140	OFDM	BPSK	13
802.11ac (VHT40)	38 to 134	38, 46, 54, 62, 102, 110, 134	OFDM	BPSK	27
802.11ac (VHT80)	42 to 106	42, 58, 106	OFDM	BPSK	58.5

ANTENNA PORT CONDUCTED MEASUREMENT:

- Pre-Scan has been conducted to determine the worst-case mode from all possible combinations between available modulations, data rates and antenna ports (if EUT with antenna diversity architecture).
- Following channel(s) was (were) selected for the final test as listed below.

MODE	AVAILABLE CHANNEL	TESTED CHANNEL	MODULATION TECHNOLOGY	MODULATI ON TYPE	DATA RATE (Mbps)
802.11a	36 to 140	36, 40, 48, 52, 60, 64, 100, 116, 132, 140	OFDM	BPSK	6
802.11ac (VHT20)	36 to 140	36, 40, 48, 52, 60, 64, 100, 116, 132, 140	OFDM	BPSK	13
802.11ac (VHT40)	38 to 134	38, 46, 54, 62, 102, 110, 134	OFDM	BPSK	27
802.11ac (VHT80)	42 to 106	42, 58, 106	OFDM	BPSK	58.5

TEST CONDITION:

APPLICABLE TO	ENVIRONMENTAL CONDITIONS	INPUT POWER (SYSTEM)	TESTED BY
PLC	26deg. C, 67%RH	120Vac, 60Hz	Ping Liu
RE<1G	23deg. C, 67%RH	120Vac, 60Hz	Robert Cheng
RE≥1G	24deg. C, 67%RH	120Vac, 60Hz	Andy Ho
APCM	25deg. C, 60%RH	120Vac, 60Hz	Chilin Lee



A D T

3.3 GENERAL DESCRIPTION OF APPLIED STANDARDS

The EUT is a RF product. According to the specifications of the manufacturer, it must comply with the requirements of the following standards:

FCC Part 15, Subpart E (15.407)

789033 D01 General UNII Test Procedures v01r03

662911 D01 Multiple Transmitter Output v02r01

ANSI C63.10-2009

All test items have been performed and recorded as per the above standards.



A D T

3.4 DUTY CYCLE OF TEST SIGNAL

Duty cycle of test signal is 100 %, duty factor is not required.

802.11a

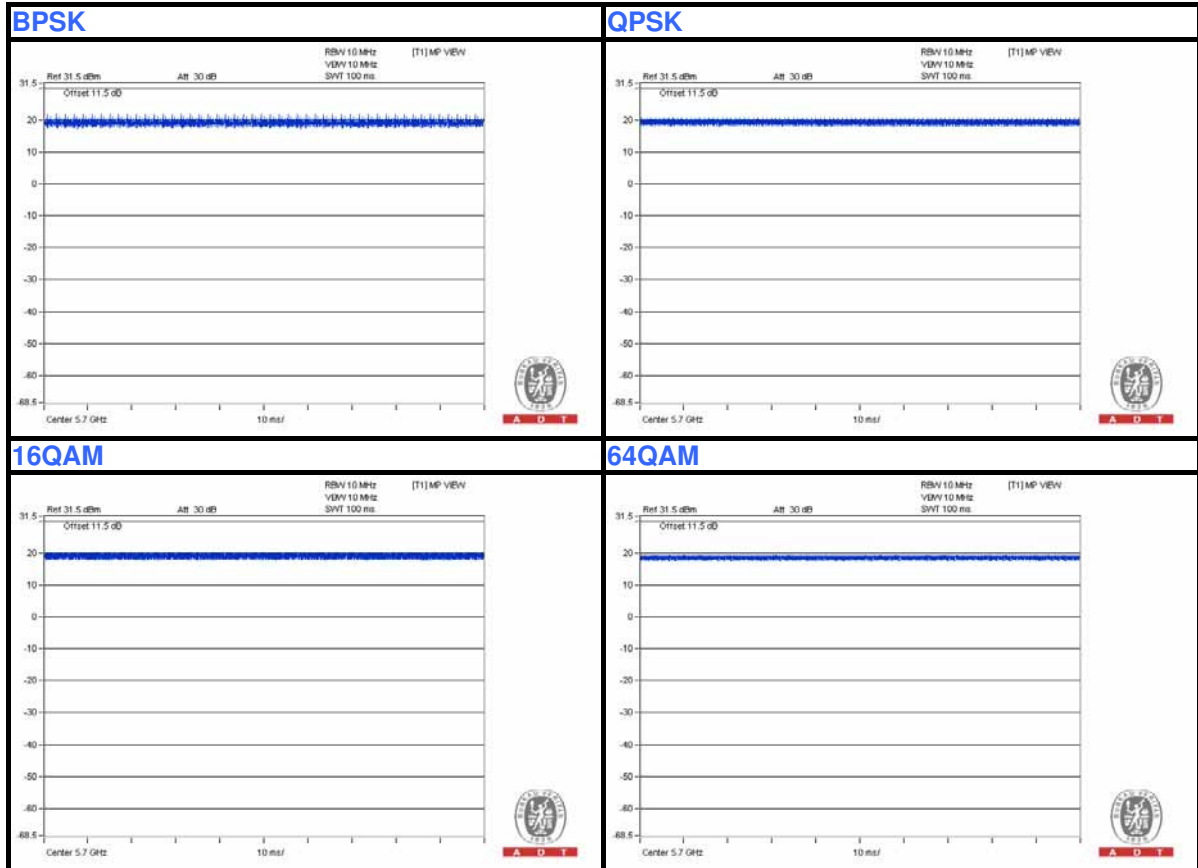



A D T

Duty cycle of test signal is 100 %, duty factor is not required.

802.11ac (VHT20)

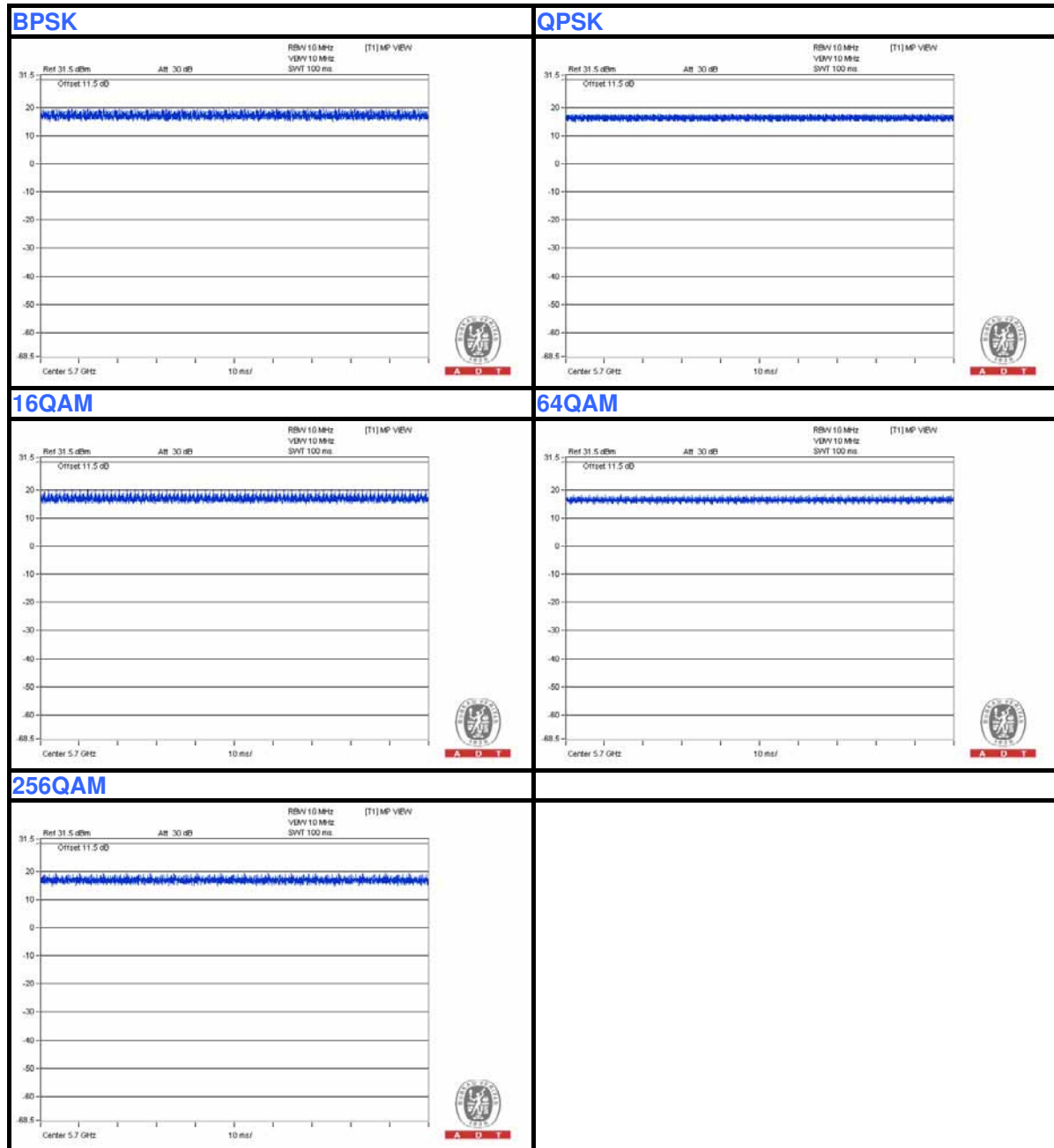



A D T

Duty cycle of test signal is 100 %, duty factor is not required.

802.11ac (VHT40)





A D T

Duty cycle of test signal is 100 %, duty factor is not required.

802.11ac (VHT80)

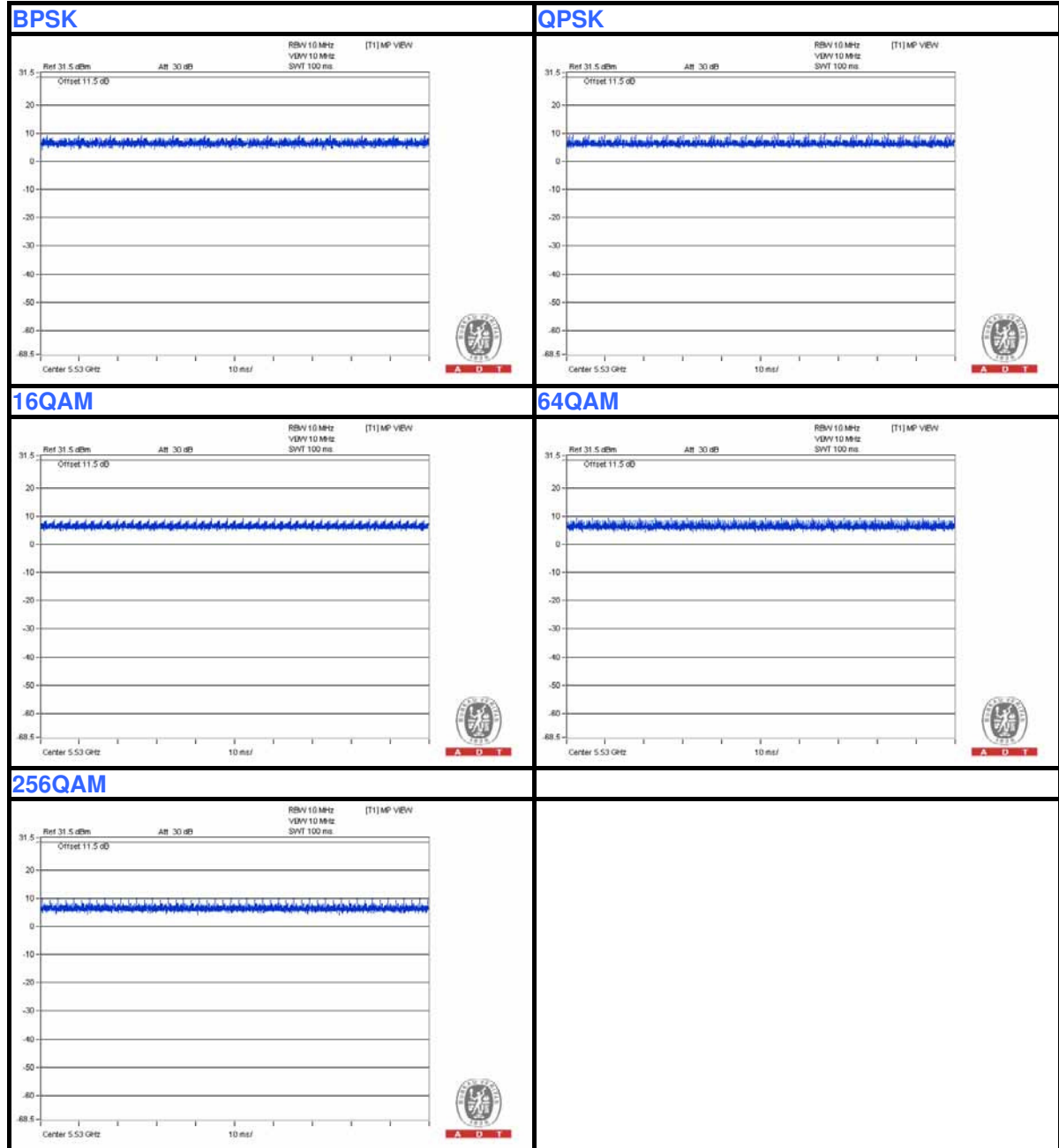



3.5 DESCRIPTION OF SUPPORT UNITS

The EUT has been tested as an independent unit together with other necessary accessories or support units. The following support units or accessories were used to form a representative test configuration during the tests.

No.	Product	Brand	Model No.	Serial No.	FCC ID
1	NOTEBOOK COMPUTER	ASUS	NA	NA	NA
2	NOTEBOOK COMPUTER	DELL	PP32LA	GSLB32S	FCC DoC
3	TEST TOOL	AzureWave	NA	NA	NA
4	SDIO Card	AzureWave	NA	NA	NA

No.	Signal cable description
1	NA
2	UTP Cable, 10m
3	NA
4	NA

Note: The power cords of the above support units were unshielded (1.8m).

3.6 CONFIGURATION OF SYSTEM UNDER TEST

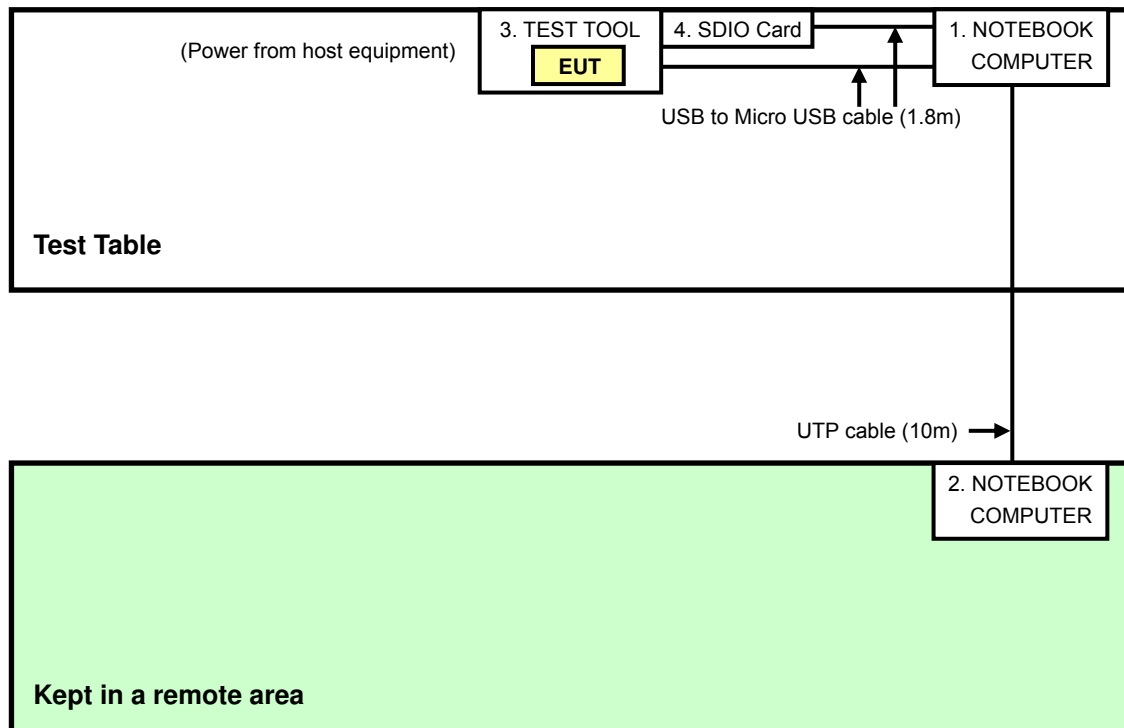



A D T

4. TEST TYPES AND RESULTS

4.1 CONDUCTED EMISSION MEASUREMENT

4.1.1 LIMITS OF CONDUCTED EMISSION MEASUREMENT

FREQUENCY OF EMISSION (MHz)	CONDUCTED LIMIT (dB μ V)	
	Quasi-peak	Average
0.15-0.5	66 to 56	56 to 46
0.5-5	56	46
5-30	60	50

- NOTE:**
1. The lower limit shall apply at the transition frequencies.
 2. The limit decreases in line with the logarithm of the frequency in the range of 0.15 to 0.50 MHz.

4.1.2 TEST INSTRUMENTS

DESCRIPTION & MANUFACTURER	MODEL NO.	SERIAL NO.	CALIBRATED DATE	CALIBRATED UNTIL
Test Receiver ROHDE & SCHWARZ	ESCS 30	100375	Apr. 29, 2014	Apr. 28, 2015
Line-Impedance Stabilization Network (for EUT) SCHWARZBECK	NSLK8127	8127-522	Sep. 05, 2013	Sep. 04, 2014
Line-Impedance Stabilization Network (for Peripheral)	ENV216	100072	June 06, 2013	June 05, 2014
RF Cable (JYEBAO)	5DFB	CONCAB-003	Mar. 07, 2014	Mar. 06, 2015
50 ohms Terminator	50	EMC-03	Sep. 24, 2013	Sep. 23, 2014
Software ADT	BV ADT_Cond_V7.3.7. 3	NA	NA	NA

Note:

1. The calibration interval of the above test instruments is 12 months and the calibrations are traceable to NML/ROC and NIST/USA.
2. The test was performed in Shielded Room No. C.
3. The VCCI Con C Registration No. is C-3611.
4. Tested Date: Apr. 29, 2014

4.1.3 TEST PROCEDURES

- a. The EUT was placed 0.4 meters from the conducting wall of the shielded room with EUT being connected to the power mains through a line impedance stabilization network (LISN). Other support units were connected to the power mains through another LISN.
- b. The two LISNs provide 50 ohm/ 50uH of coupling impedance for the measuring instrument.
- c. Both lines of the power mains connected to the EUT were checked for maximum conducted interference.
- d. The frequency range from 150kHz to 30MHz was searched. Emission level under (Limit – 20dB) was not recorded.

NOTE:

1. The resolution bandwidth of test receiver is 9kHz for Quasi-peak detection (QP) & Average detection (AV).

4.1.4 DEVIATION FROM TEST STANDARD

No deviation

4.1.5 TEST SETUP

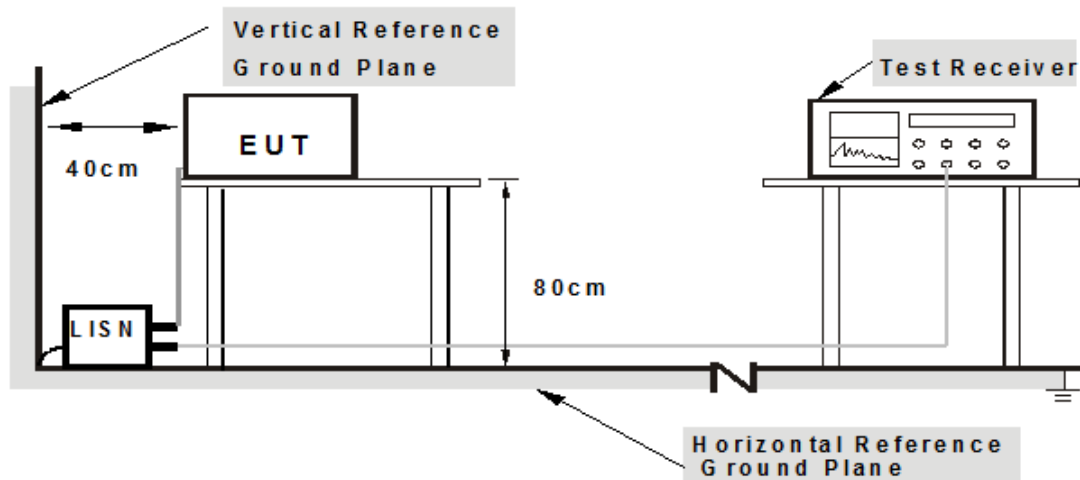

Note: 1. Support units were connected to second LISN.

For the actual test configuration, please refer to the related item – Photographs of the Test Configuration.



A D T

4.1.6 EUT OPERATING CONDITIONS

1. Connect the EUT with the support unit 2 (Notebook Computer) which is placed in a remote area.
2. The communication partner run test program “DutApiMimoBtFmBrdigeEth.exe[ver.2.0.0.43]” to enable EUT under transmission/receiving condition continuously at specific channel frequency.

4.1.7 TEST RESULTS

PHASE	Line (L)	DETECTOR FUNCTION	Quasi-Peak (QP) / Average (AV)
--------------	----------	--------------------------	--------------------------------

No	Freq. [MHz]	Corr. Factor (dB)	Reading Value [dB (uV)]		Emission Level [dB (uV)]		Limit [dB (uV)]		Margin (dB)	
			Q.P.	AV.	Q.P.	AV.	Q.P.	AV.	Q.P.	AV.
1	0.19687	0.06	48.02	38.03	48.08	38.09	63.74	53.74	-15.66	-15.65
2	0.25156	0.06	44.01	32.74	44.07	32.80	61.71	51.71	-17.63	-18.90
3	0.39219	0.07	36.22	28.12	36.29	28.19	58.02	48.02	-21.73	-19.83
4	0.45469	0.07	40.17	33.44	40.24	33.51	56.79	46.79	-16.55	-13.28
5	0.52500	0.07	40.18	30.89	40.25	30.96	56.00	46.00	-15.75	-15.04
6	3.86328	0.20	34.18	22.80	34.38	23.00	56.00	46.00	-21.62	-23.00

REMARKS:

1. Q.P. and AV. are abbreviations of quasi-peak and average individually.
2. The emission levels of other frequencies were very low against the limit.
3. Margin value = Emission Level – Limit value
4. Correction Factor = Insertion loss + Cable loss
5. Emission Level = Correction Factor + Reading Value

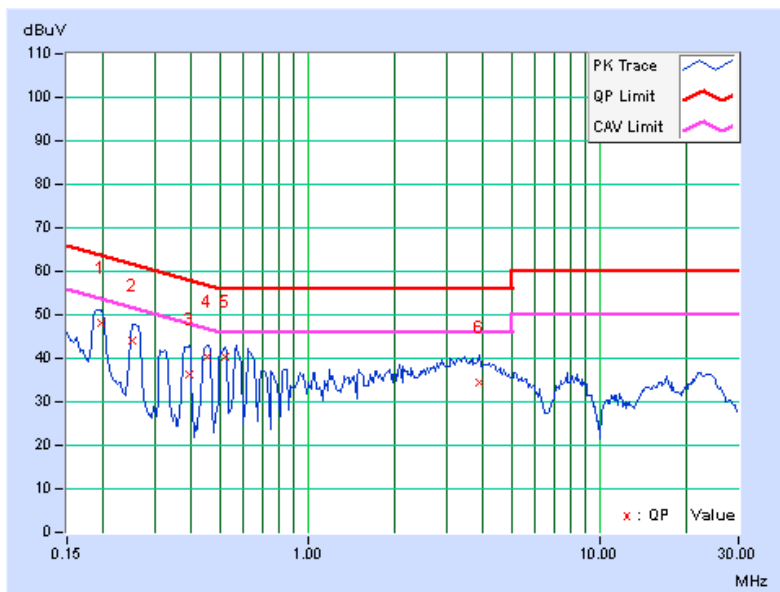

PHASE	Neutral (N)	DETECTOR FUNCTION	Quasi-Peak (QP) / Average (AV)
--------------	-------------	--------------------------	--------------------------------

No	Freq.	Corr.	Reading Value		Emission Level		Limit		Margin	
	[MHz]	(dB)	Q.P.	AV.	Q.P.	AV.	Q.P.	AV.	Q.P.	AV.
1	0.18906	0.06	48.94	38.89	49.00	38.95	64.08	54.08	-15.08	-15.13
2	0.25547	0.06	44.42	36.36	44.48	36.42	61.58	51.58	-17.09	-15.15
3	0.44297	0.07	39.90	32.47	39.97	32.54	57.01	47.01	-17.03	-14.46
4	0.56406	0.08	39.23	27.52	39.31	27.60	56.00	46.00	-16.69	-18.40
5	0.65000	0.08	35.15	25.44	35.23	25.52	56.00	46.00	-20.77	-20.48
6	3.35156	0.18	34.87	24.15	35.05	24.33	56.00	46.00	-20.95	-21.67

REMARKS:

1. Q.P. and AV. are abbreviations of quasi-peak and average individually.
2. The emission levels of other frequencies were very low against the limit.
3. Margin value = Emission Level – Limit value
4. Correction Factor = Insertion loss + Cable loss
5. Emission Level = Correction Factor + Reading Value

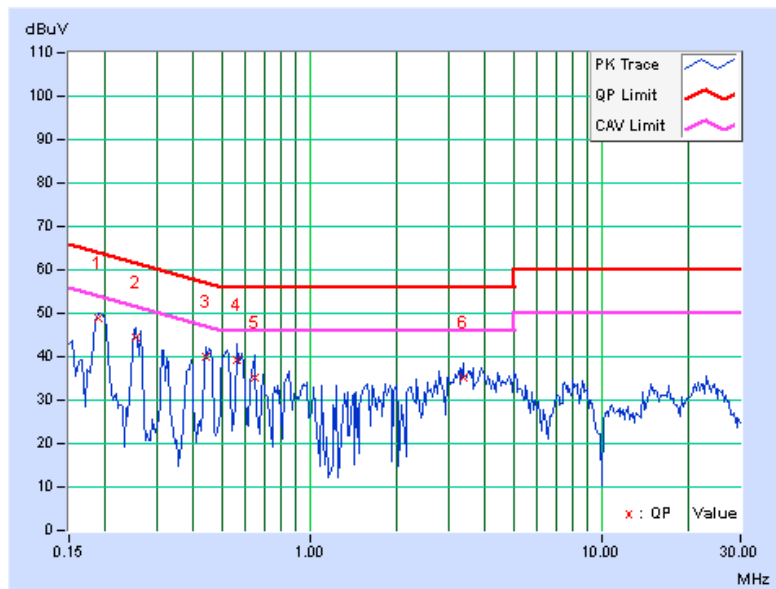



4.2 RADIATED EMISSION AND BANDEGE MEASUREMENT

4.2.1 LIMITS OF RADIATED EMISSION AND BANDEGE MEASUREMENT

Radiated emissions which fall in the restricted bands must comply with the radiated emission limits specified as below table:

Frequencies (MHz)	Field strength (microvolts/meter)	Measurement distance (meters)
0.009-0.490	2400/F(kHz)	300
0.490-1.705	24000/F(kHz)	30
1.705-30.0	30	30
30-88	100	3
88-216	150	3
216-960	200	3
Above 960	500	3

NOTE:

1. The lower limit shall apply at the transition frequencies.
2. Emission level (dBuV/m) = 20 log Emission level (uV/m).
3. For frequencies above 1000MHz, the field strength limits are based on average detector, however, the peak field strength of any emission shall not exceed the maximum permitted average limits, specified above by more than 20dB under any condition of modulation.

4.2.2 LIMITS OF UNWANTED EMISSION OUT OF THE RESTRICTED BANDS

APPLICABLE TO	LIMIT	
√	FIELD STRENGTH AT 3m (dBμV/m)	
	PK	AV
	74	54
	EIRP LIMIT (dBm)	EQUIVALENT FIELD STRENGTH AT 3m (dBμV/m)
	PK	PK
	-27	68.3

NOTE:

1. The following formula is used to convert the equipment isotropic radiated power (eirp) to field strength:

$$E = \frac{1000000\sqrt{30P}}{3} \mu\text{V/m, where P is the eirp (Watts).}$$



A D T

4.2.3 TEST INSTRUMENTS

DESCRIPTION & MANUFACTURER	MODEL NO.	SERIAL NO.	CALIBRATED DATE	CALIBRATED UNTIL
MXE EMI Receiver Agilent	N9038A	MY51210105	Jan. 21,2014	Jan. 20,2015
Pre-Amplifier Mini-Circuits	ZFL-1000VH2 B	AMP-ZFL-03	Nov. 13, 2013	Nov. 12, 2014
Trilog Broadband Antenna SCHWARZBECK	VULB 9168	9168-360	Feb. 26, 2014	Feb. 25, 2015
RF Cable	NA	CHGCAB_001	Oct. 05, 2013	Oct. 04, 2014
Spectrum Analyzer R&S	FSV40	100964	July 15, 2013	July 14, 2014
Horn_Antenna AISI	AIH.8018	0000320091110	Nov. 18, 2013	Nov. 17, 2014
Pre-Amplifier Agilent	8449B	3008A02578	June 25, 2013	June 24, 2014
RF Cable	NA	RF104-201 RF104-203 RF104-204	Dec. 12, 2013	Dec. 11, 2014
Spectrum Analyzer Agilent	E4446A	MY48250253	Aug. 28, 2013	Aug. 27, 2014
Pre-Amplifier SPACEK LABS	SLKKa-48-6	9K16	Nov. 13, 2013	Nov. 12, 2014
Horn_Antenna SCHWARZBECK	BBHA 9170	9170-424	Oct. 08, 2013	Oct. 07, 2014
Software	ADT_Radiated _V8.7.07	NA	NA	NA
Antenna Tower & Turn Table CT	NA	NA	NA	NA

Note:

1. The calibration interval of the above test instruments is 12 months and the calibrations are traceable to NML/ROC and NIST/USA.
2. The horn antenna, preamplifier (model: 8449B) are used only for the measurement of emission frequency above 1GHz if tested.
- 3 The test was performed in 966 Chamber No. G.
4. The FCC Site Registration No. is 966073.
- 5 The VCCI Site Registration No. is G-137.
- 6 The CANADA Site Registration No. is IC 7450H-2.
- 7 Tested Date: May 16 to 20, 2014

4.2.4 TEST PROCEDURES

- a. The EUT was placed on the top of a rotating table 0.8 meters above the ground at 3 meter chamber room for test. The table was rotated 360 degrees to determine the position of the highest radiation.
- b. The EUT was set 3 meters away from the interference-receiving antenna, which was mounted on the top of a variable-height antenna tower.
- c. The height of antenna is varied from one meter to four meters above the ground to determine the maximum value of the field strength. Both horizontal and vertical polarizations of the antenna are set to make the measurement.
- d. For each suspected emission, the EUT was arranged to its worst case and then the antenna was tuned to heights from 1 meter to 4 meters and the rotatable table was turned from 0 degrees to 360 degrees to find the maximum reading.
- e. The test-receiver system was set to quasi-peak detect function and specified bandwidth with maximum hold mode when the test frequency is below 1 GHz.
- f. The test-receiver system was set to peak and average detect function and specified bandwidth with maximum hold mode when the test frequency is above 1 GHz. If the peak reading value also meets average limit, measurement with the average detector is unnecessary.

Note:

1. The resolution bandwidth and video bandwidth of test receiver/spectrum analyzer is 120kHz for Quasi-peak detection (QP) at frequency below 1GHz.
2. The resolution bandwidth of test receiver/spectrum analyzer is 1 MHz and the video bandwidth is 3 MHz for Peak detection (PK) at frequency above 1GHz.
3. The resolution bandwidth of test receiver/spectrum analyzer is 1MHz and the video bandwidth is 3MHz for RMS Average (Duty cycle < 98%) for Average detection (AV) at frequency above 1GHz, then the measurement results was added to a correction factor ($10 \log(1/\text{duty cycle})$).
4. The resolution bandwidth of test receiver/spectrum analyzer is 1MHz and the video bandwidth is 10Hz (Duty cycle $\geq 98\%$) for Average detection (AV) at frequency above 1GHz.
5. All modes of operation were investigated and the worst-case emissions are reported.

4.2.5 DEVIATION FROM TEST STANDARD

No deviation

4.2.6 TEST SETUP

<Frequency Range below 1GHz>

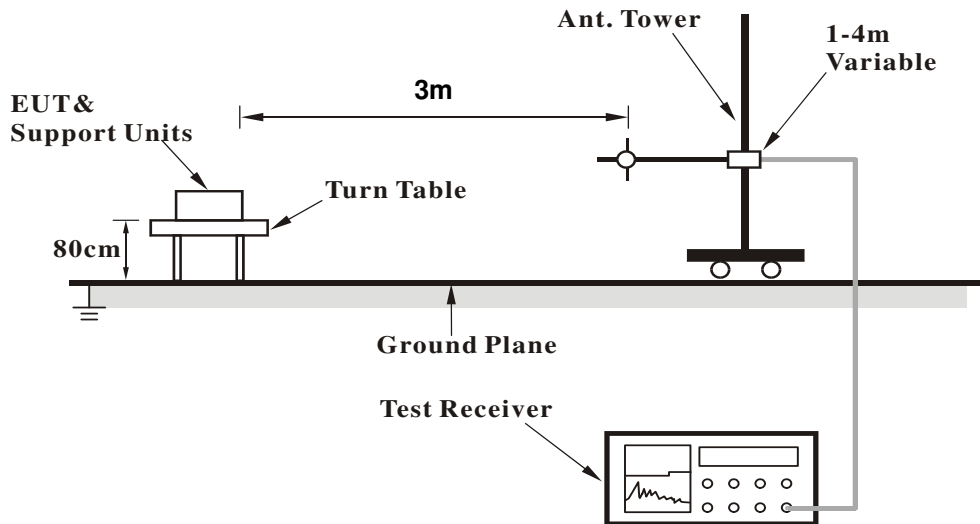

<Frequency Range above 1GHz>

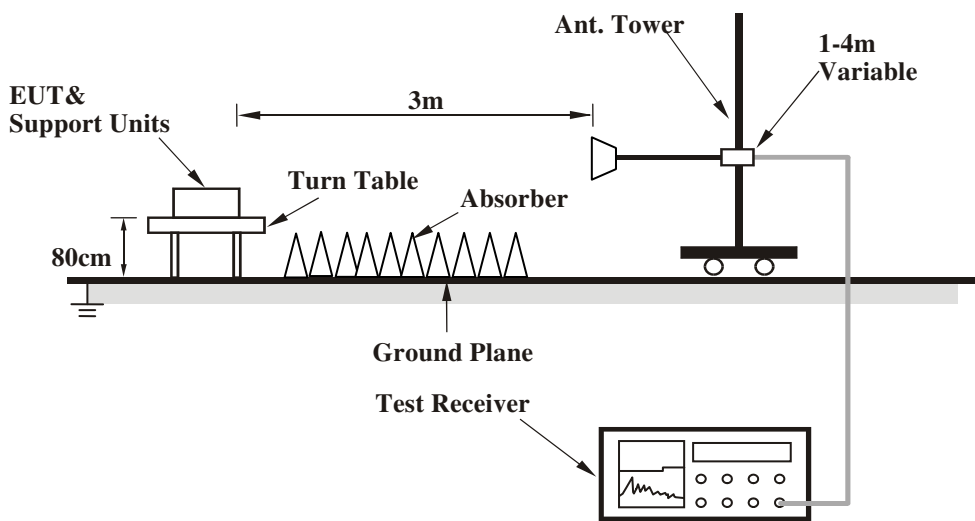

For the actual test configuration, please refer to the related item – Photographs of the Test Configuration.

4.2.7 EUT OPERATING CONDITION

Same as 4.1.6



A D T

4.2.8 TEST RESULTS

BELOW 1GHz WORST-CASE DATA

802.11a

CHANNEL	TX Channel 116	DETECTOR FUNCTION	Quasi-Peak (QP)
FREQUENCY RANGE	Below 1GHz		

ANTENNA POLARITY & TEST DISTANCE: HORIZONTAL AT 3 M

NO.	FREQ. (MHz)	EMISSION LEVEL (dBuV/m)	LIMIT (dBuV/m)	MARGIN (dB)	ANTENNA HEIGHT (m)	TABLE ANGLE (Degree)	RAW VALUE (dBuV)	CORRECTION FACTOR (dB/m)
1	47.90	35.4 QP	40.0	-4.6	1.11 H	265	48.90	-13.48
2	72.01	33.4 QP	40.0	-6.6	1.07 H	234	49.47	-16.06
3	311.92	42.2 QP	46.0	-3.8	1.04 H	98	54.21	-11.98
4	359.99	38.2 QP	46.0	-7.8	1.11 H	98	49.01	-10.80
5	527.99	36.1 QP	46.0	-9.9	1.21 H	268	42.91	-6.80
6	935.98	40.1 QP	46.0	-5.9	1.10 H	98	39.25	0.86

ANTENNA POLARITY & TEST DISTANCE: VERTICAL AT 3 M

NO.	FREQ. (MHz)	EMISSION LEVEL (dBuV/m)	LIMIT (dBuV/m)	MARGIN (dB)	ANTENNA HEIGHT (m)	TABLE ANGLE (Degree)	RAW VALUE (dBuV)	CORRECTION FACTOR (dB/m)
1	60.52	34.6 QP	40.0	-5.4	1.10 V	204	48.80	-14.19
2	312.06	37.6 QP	46.0	-8.4	1.10 V	279	49.59	-11.98
3	432.02	41.5 QP	46.0	-4.5	1.11 V	201	50.12	-8.61
4	527.98	39.2 QP	46.0	-6.8	1.34 V	201	46.01	-6.80
5	647.98	36.3 QP	46.0	-9.7	1.10 V	67	40.43	-4.09
6	935.98	42.7 QP	46.0	-3.3	1.11 V	304	41.85	0.86

REMARKS:

1. Emission Level(dBuV/m) = Raw Value(dBuV) + Correction Factor(dB/m)
2. Correction Factor(dB/m) = Antenna Factor(dB/m) + Cable Factor(dB) – Pre-Amplifier Factor(dB)
3. The other emission levels were very low against the limit.
4. Margin value = Emission Level – Limit value



A D T

ABOVE 1GHz DATA

802.11a

CHANNEL	TX Channel 36	DETECTOR FUNCTION	Peak (PK)
FREQUENCY RANGE	1GHz ~ 40GHz		Average (AV)

ANTENNA POLARITY & TEST DISTANCE: HORIZONTAL AT 3 M

NO.	FREQ. (MHz)	EMISSION LEVEL (dBuV/m)	LIMIT (dBuV/m)	MARGIN (dB)	ANTENNA HEIGHT (m)	TABLE ANGLE (Degree)	RAW VALUE (dBuV)	CORRECTION FACTOR (dB/m)
1	5150.00	68.4 PK	74.0	-5.6	1.32 H	60	60.17	8.23
2	5150.00	51.0 AV	54.0	-3.0	1.32 H	60	42.77	8.23
3	*5180.00	110.5 PK			1.32 H	60	102.27	8.23
4	*5180.00	101.8 AV			1.32 H	60	93.57	8.23
5	#10360.00	55.0 PK	74.0	-19.0	1.00 H	140	40.12	14.88
6	#10360.00	43.7 AV	54.0	-10.3	1.00 H	140	28.82	14.88
7	15540.00	62.4 PK	74.0	-11.6	1.00 H	249	41.55	20.85
8	15540.00	49.6 AV	54.0	-4.4	1.00 H	249	28.75	20.85

ANTENNA POLARITY & TEST DISTANCE: VERTICAL AT 3 M

NO.	FREQ. (MHz)	EMISSION LEVEL (dBuV/m)	LIMIT (dBuV/m)	MARGIN (dB)	ANTENNA HEIGHT (m)	TABLE ANGLE (Degree)	RAW VALUE (dBuV)	CORRECTION FACTOR (dB/m)
1	5150.00	62.8 PK	74.0	-11.2	1.11 V	360	54.57	8.23
2	5150.00	45.7 AV	54.0	-8.3	1.11 V	360	37.47	8.23
3	*5180.00	108.0 PK			1.11 V	360	99.77	8.23
4	*5180.00	98.7 AV			1.11 V	360	90.47	8.23
5	#10360.00	54.7 PK	74.0	-19.3	1.28 V	94	39.82	14.88
6	#10360.00	44.6 AV	54.0	-9.4	1.28 V	94	29.72	14.88
7	15540.00	63.7 PK	74.0	-10.3	1.19 V	326	42.85	20.85
8	15540.00	50.2 AV	54.0	-3.8	1.19 V	326	29.35	20.85

REMARKS:

1. Emission Level(dBuV/m) = Raw Value(dBuV) + Correction Factor(dB/m)
2. Correction Factor(dB/m) = Antenna Factor(dB/m) + Cable Factor(dB) – Pre-Amplifier Factor(dB)
3. The other emission levels were very low against the limit.
4. Margin value = Emission Level – Limit value
5. " * ": Fundamental frequency.
6. " # ": The radiated frequency is out of the restricted band.



A D T

CHANNEL	TX Channel 40	DETECTOR FUNCTION	Peak (PK)
FREQUENCY RANGE	1GHz ~ 40GHz		Average (AV)

ANTENNA POLARITY & TEST DISTANCE: HORIZONTAL AT 3 M

NO.	FREQ. (MHz)	EMISSION LEVEL (dBuV/m)	LIMIT (dBuV/m)	MARGIN (dB)	ANTENNA HEIGHT (m)	TABLE ANGLE (Degree)	RAW VALUE (dBuV)	CORRECTION FACTOR (dB/m)
1	*5200.00	112.6 PK			1.35 H	68	104.36	8.24
2	*5200.00	103.8 AV			1.35 H	68	95.56	8.24
3	#10400.00	53.8 PK	74.0	-20.2	1.00 H	112	38.57	15.23
4	#10400.00	40.5 AV	54.0	-13.5	1.00 H	112	25.27	15.23
5	15600.00	61.9 PK	74.0	-12.1	1.04 H	8	41.02	20.88
6	15600.00	51.5 AV	54.0	-2.5	1.04 H	8	30.62	20.88

ANTENNA POLARITY & TEST DISTANCE: VERTICAL AT 3 M

NO.	FREQ. (MHz)	EMISSION LEVEL (dBuV/m)	LIMIT (dBuV/m)	MARGIN (dB)	ANTENNA HEIGHT (m)	TABLE ANGLE (Degree)	RAW VALUE (dBuV)	CORRECTION FACTOR (dB/m)
1	*5200.00	109.7 PK			1.11 V	357	101.46	8.24
2	*5200.00	100.9 AV			1.11 V	357	92.66	8.24
3	#10400.00	54.5 PK	74.0	-19.5	1.37 V	100	39.27	15.23
4	#10400.00	44.4 AV	54.0	-9.6	1.37 V	100	29.17	15.23
5	15600.00	64.9 PK	74.0	-9.1	1.14 V	311	44.02	20.88
6	15600.00	51.9 AV	54.0	-2.1	1.14 V	311	31.02	20.88

REMARKS:

1. Emission Level(dBuV/m) = Raw Value(dBuV) + Correction Factor(dB/m)
2. Correction Factor(dB/m) = Antenna Factor(dB/m) + Cable Factor(dB) – Pre-Amplifier Factor(dB)
3. The other emission levels were very low against the limit.
4. Margin value = Emission Level – Limit value
5. " * ": Fundamental frequency.
6. " # ": The radiated frequency is out of the restricted band.



A D T

CHANNEL	TX Channel 48	DETECTOR FUNCTION	Peak (PK)
FREQUENCY RANGE	1GHz ~ 40GHz		Average (AV)

ANTENNA POLARITY & TEST DISTANCE: HORIZONTAL AT 3 M

NO.	FREQ. (MHz)	EMISSION LEVEL (dBuV/m)	LIMIT (dBuV/m)	MARGIN (dB)	ANTENNA HEIGHT (m)	TABLE ANGLE (Degree)	RAW VALUE (dBuV)	CORRECTION FACTOR (dB/m)
1	*5240.00	111.9 PK			1.35 H	86	103.50	8.40
2	*5240.00	103.1 AV			1.35 H	86	94.70	8.40
3	#10480.00	53.6 PK	74.0	-20.4	1.00 H	115	38.39	15.21
4	#10480.00	40.6 AV	54.0	-13.4	1.00 H	115	25.39	15.21
5	15720.00	62.8 PK	74.0	-11.2	1.05 H	1	41.93	20.87
6	15720.00	52.0 AV	54.0	-2.0	1.05 H	1	31.13	20.87

ANTENNA POLARITY & TEST DISTANCE: VERTICAL AT 3 M

NO.	FREQ. (MHz)	EMISSION LEVEL (dBuV/m)	LIMIT (dBuV/m)	MARGIN (dB)	ANTENNA HEIGHT (m)	TABLE ANGLE (Degree)	RAW VALUE (dBuV)	CORRECTION FACTOR (dB/m)
1	*5240.00	109.1 PK			1.11 V	354	100.70	8.40
2	*5240.00	99.8 AV			1.11 V	354	91.40	8.40
3	#10480.00	54.9 PK	74.0	-19.1	1.25 V	82	39.69	15.21
4	#10480.00	44.8 AV	54.0	-9.2	1.25 V	82	29.59	15.21
5	15720.00	66.0 PK	74.0	-8.0	1.13 V	307	45.13	20.87
6	15720.00	52.7 AV	54.0	-1.3	1.13 V	307	31.83	20.87

REMARKS:

1. Emission Level(dBuV/m) = Raw Value(dBuV) + Correction Factor(dB/m)
2. Correction Factor(dB/m) = Antenna Factor(dB/m) + Cable Factor(dB) – Pre-Amplifier Factor(dB)
3. The other emission levels were very low against the limit.
4. Margin value = Emission Level – Limit value
5. " * ": Fundamental frequency.
6. " # ": The radiated frequency is out of the restricted band.



A D T

CHANNEL	TX Channel 52	DETECTOR FUNCTION	Peak (PK)
FREQUENCY RANGE	1GHz ~ 40GHz		Average (AV)

ANTENNA POLARITY & TEST DISTANCE: HORIZONTAL AT 3 M

NO.	FREQ. (MHz)	EMISSION LEVEL (dBuV/m)	LIMIT (dBuV/m)	MARGIN (dB)	ANTENNA HEIGHT (m)	TABLE ANGLE (Degree)	RAW VALUE (dBuV)	CORRECTION FACTOR (dB/m)
1	*5260.00	111.8 PK			1.35 H	78	103.34	8.46
2	*5260.00	103.4 AV			1.35 H	78	94.94	8.46
3	#10520.00	52.8 PK	74.0	-21.2	1.01 H	106	37.54	15.26
4	#10520.00	39.9 AV	54.0	-14.1	1.01 H	106	24.64	15.26
5	15780.00	61.1 PK	74.0	-12.9	1.03 H	22	40.35	20.75
6	15780.00	50.8 AV	54.0	-3.2	1.03 H	22	30.05	20.75

ANTENNA POLARITY & TEST DISTANCE: VERTICAL AT 3 M

NO.	FREQ. (MHz)	EMISSION LEVEL (dBuV/m)	LIMIT (dBuV/m)	MARGIN (dB)	ANTENNA HEIGHT (m)	TABLE ANGLE (Degree)	RAW VALUE (dBuV)	CORRECTION FACTOR (dB/m)
1	*5260.00	109.1 PK			1.15 V	344	100.64	8.46
2	*5260.00	100.0 AV			1.15 V	344	91.54	8.46
3	#10520.00	54.6 PK	74.0	-19.4	1.28 V	96	39.34	15.26
4	#10520.00	44.4 AV	54.0	-9.6	1.28 V	96	29.14	15.26
5	15780.00	65.6 PK	74.0	-8.4	1.17 V	308	44.85	20.75
6	15780.00	52.3 AV	54.0	-1.7	1.17 V	308	31.55	20.75

REMARKS:

1. Emission Level(dBuV/m) = Raw Value(dBuV) + Correction Factor(dB/m)
2. Correction Factor(dB/m) = Antenna Factor(dB/m) + Cable Factor(dB) – Pre-Amplifier Factor(dB)
3. The other emission levels were very low against the limit.
4. Margin value = Emission Level – Limit value
5. " * ": Fundamental frequency.
6. " # ": The radiated frequency is out of the restricted band.



A D T

CHANNEL	TX Channel 60	DETECTOR FUNCTION	Peak (PK)
FREQUENCY RANGE	1GHz ~ 40GHz		Average (AV)

ANTENNA POLARITY & TEST DISTANCE: HORIZONTAL AT 3 M

NO.	FREQ. (MHz)	EMISSION LEVEL (dBuV/m)	LIMIT (dBuV/m)	MARGIN (dB)	ANTENNA HEIGHT (m)	TABLE ANGLE (Degree)	RAW VALUE (dBuV)	CORRECTION FACTOR (dB/m)
1	*5300.00	110.5 PK			1.00 H	27	101.88	8.62
2	*5300.00	101.6 AV			1.00 H	27	92.98	8.62
3	10600.00	54.1 PK	74.0	-19.9	1.00 H	113	38.57	15.53
4	10600.00	41.1 AV	54.0	-12.9	1.00 H	113	25.57	15.53
5	15900.00	62.8 PK	74.0	-11.2	1.04 H	0	41.50	21.30
6	15900.00	52.1 AV	54.0	-1.9	1.04 H	0	30.80	21.30

ANTENNA POLARITY & TEST DISTANCE: VERTICAL AT 3 M

NO.	FREQ. (MHz)	EMISSION LEVEL (dBuV/m)	LIMIT (dBuV/m)	MARGIN (dB)	ANTENNA HEIGHT (m)	TABLE ANGLE (Degree)	RAW VALUE (dBuV)	CORRECTION FACTOR (dB/m)
1	*5300.00	107.2 PK			1.14 V	342	98.58	8.62
2	*5300.00	98.2 AV			1.14 V	342	89.58	8.62
3	10600.00	54.4 PK	74.0	-19.6	1.30 V	95	38.87	15.53
4	10600.00	44.1 AV	54.0	-9.9	1.30 V	95	28.57	15.53
5	15900.00	65.8 PK	74.0	-8.2	1.14 V	310	44.50	21.30
6	15900.00	52.5 AV	54.0	-1.5	1.14 V	310	31.20	21.30

REMARKS:

1. Emission Level(dBuV/m) = Raw Value(dBuV) + Correction Factor(dB/m)
2. Correction Factor(dB/m) = Antenna Factor(dB/m) + Cable Factor(dB) – Pre-Amplifier Factor(dB)
3. The other emission levels were very low against the limit.
4. Margin value = Emission Level – Limit value
5. " * ": Fundamental frequency.



A D T

CHANNEL	TX Channel 64	DETECTOR FUNCTION	Peak (PK)
FREQUENCY RANGE	1GHz ~ 40GHz		Average (AV)

ANTENNA POLARITY & TEST DISTANCE: HORIZONTAL AT 3 M

NO.	FREQ. (MHz)	EMISSION LEVEL (dBuV/m)	LIMIT (dBuV/m)	MARGIN (dB)	ANTENNA HEIGHT (m)	TABLE ANGLE (Degree)	RAW VALUE (dBuV)	CORRECTION FACTOR (dB/m)
1	*5320.00	110.9 PK			1.56 H	114	102.21	8.69
2	*5320.00	102.0 AV			1.56 H	114	93.31	8.69
3	5350.00	69.5 PK	74.0	-4.5	1.56 H	114	60.70	8.80
4	5350.00	52.2 AV	54.0	-1.8	1.56 H	114	43.40	8.80
5	10640.00	52.9 PK	74.0	-21.1	1.08 H	125	37.36	15.54
6	10640.00	40.1 AV	54.0	-13.9	1.08 H	125	24.56	15.54
7	15960.00	62.0 PK	74.0	-12.0	1.01 H	1	41.18	20.82
8	15960.00	51.3 AV	54.0	-2.7	1.01 H	1	30.48	20.82

ANTENNA POLARITY & TEST DISTANCE: VERTICAL AT 3 M

NO.	FREQ. (MHz)	EMISSION LEVEL (dBuV/m)	LIMIT (dBuV/m)	MARGIN (dB)	ANTENNA HEIGHT (m)	TABLE ANGLE (Degree)	RAW VALUE (dBuV)	CORRECTION FACTOR (dB/m)
1	*5320.00	107.4 PK			1.14 V	339	98.71	8.69
2	*5320.00	98.2 AV			1.14 V	339	89.51	8.69
3	5350.00	62.9 PK	74.0	-11.1	1.14 V	339	54.10	8.80
4	5350.00	45.7 AV	54.0	-8.3	1.14 V	339	36.90	8.80
5	10640.00	54.8 PK	74.0	-19.2	1.34 V	106	39.26	15.54
6	10640.00	44.4 AV	54.0	-9.6	1.34 V	106	28.86	15.54
7	15960.00	65.1 PK	74.0	-8.9	1.14 V	317	44.28	20.82
8	15960.00	52.1 AV	54.0	-1.9	1.14 V	317	31.28	20.82

REMARKS:

1. Emission Level(dBuV/m) = Raw Value(dBuV) + Correction Factor(dB/m)
2. Correction Factor(dB/m) = Antenna Factor(dB/m) + Cable Factor(dB) – Pre-Amplifier Factor(dB)
3. The other emission levels were very low against the limit.
4. Margin value = Emission Level – Limit value
5. " * ": Fundamental frequency.



A D T

CHANNEL	TX Channel 100	DETECTOR FUNCTION	Peak (PK)
FREQUENCY RANGE	1GHz ~ 40GHz		Average (AV)

ANTENNA POLARITY & TEST DISTANCE: HORIZONTAL AT 3 M

NO.	FREQ. (MHz)	EMISSION LEVEL (dBuV/m)	LIMIT (dBuV/m)	MARGIN (dB)	ANTENNA HEIGHT (m)	TABLE ANGLE (Degree)	RAW VALUE (dBuV)	CORRECTION FACTOR (dB/m)
1	5460.00	66.4 PK	74.0	-7.6	1.52 H	114	57.21	9.19
2	5460.00	48.5 AV	54.0	-5.5	1.52 H	114	39.31	9.19
3	#5470.00	70.8 PK	74.0	-3.2	1.52 H	114	61.58	9.22
4	#5470.00	53.4 AV	54.0	-0.6	1.52 H	114	44.18	9.22
5	*5500.00	111.5 PK			1.52 H	114	102.17	9.33
6	*5500.00	103.0 AV			1.52 H	114	93.67	9.33
7	11000.00	53.1 PK	74.0	-20.9	1.04 H	112	36.15	16.95
8	11000.00	40.2 AV	54.0	-13.8	1.04 H	112	23.25	16.95
9	#16500.00	61.8 PK	74.0	-12.2	1.03 H	10	38.76	23.04
10	#16500.00	51.3 AV	54.0	-2.7	1.03 H	10	28.26	23.04

ANTENNA POLARITY & TEST DISTANCE: VERTICAL AT 3 M

NO.	FREQ. (MHz)	EMISSION LEVEL (dBuV/m)	LIMIT (dBuV/m)	MARGIN (dB)	ANTENNA HEIGHT (m)	TABLE ANGLE (Degree)	RAW VALUE (dBuV)	CORRECTION FACTOR (dB/m)
1	5460.00	61.4 PK	74.0	-12.6	1.06 V	354	52.21	9.19
2	5460.00	44.2 AV	54.0	-9.8	1.06 V	354	35.01	9.19
3	#5470.00	62.8 PK	74.0	-11.2	1.06 V	354	53.58	9.22
4	#5470.00	45.7 AV	54.0	-8.3	1.06 V	354	36.48	9.22
5	*5500.00	108.5 PK			1.06 V	354	99.17	9.33
6	*5500.00	99.5 AV			1.06 V	354	90.17	9.33
7	11000.00	54.4 PK	74.0	-19.6	1.30 V	101	37.45	16.95
8	11000.00	44.1 AV	54.0	-9.9	1.30 V	101	27.15	16.95
9	#16500.00	64.8 PK	74.0	-9.2	1.13 V	305	41.76	23.04
10	#16500.00	51.9 AV	54.0	-2.1	1.13 V	305	28.86	23.04

REMARKS:

1. Emission Level(dBuV/m) = Raw Value(dBuV) + Correction Factor(dB/m)
2. Correction Factor(dB/m) = Antenna Factor(dB/m) + Cable Factor(dB) – Pre-Amplifier Factor(dB)
3. The other emission levels were very low against the limit.
4. Margin value = Emission Level – Limit value
5. " * ": Fundamental frequency.
6. " # ": The radiated frequency is out of the restricted band.



A D T

CHANNEL	TX Channel 116	DETECTOR FUNCTION	Peak (PK)
FREQUENCY RANGE	1GHz ~ 40GHz		Average (AV)

ANTENNA POLARITY & TEST DISTANCE: HORIZONTAL AT 3 M

NO.	FREQ. (MHz)	EMISSION LEVEL (dBuV/m)	LIMIT (dBuV/m)	MARGIN (dB)	ANTENNA HEIGHT (m)	TABLE ANGLE (Degree)	RAW VALUE (dBuV)	CORRECTION FACTOR (dB/m)
1	*5580.00	113.3 PK			1.49 H	112	103.83	9.47
2	*5580.00	104.3 AV			1.49 H	112	94.83	9.47
3	11160.00	53.5 PK	74.0	-20.5	1.02 H	100	37.29	16.21
4	11160.00	40.4 AV	54.0	-13.6	1.02 H	100	24.19	16.21
5	#16740.00	62.7 PK	74.0	-11.3	1.09 H	1	39.02	23.68
6	#16740.00	51.9 AV	54.0	-2.1	1.09 H	1	28.22	23.68

ANTENNA POLARITY & TEST DISTANCE: VERTICAL AT 3 M

NO.	FREQ. (MHz)	EMISSION LEVEL (dBuV/m)	LIMIT (dBuV/m)	MARGIN (dB)	ANTENNA HEIGHT (m)	TABLE ANGLE (Degree)	RAW VALUE (dBuV)	CORRECTION FACTOR (dB/m)
1	*5580.00	109.0 PK			1.11 V	360	99.53	9.47
2	*5580.00	99.6 AV			1.11 V	360	90.13	9.47
3	11160.00	54.6 PK	74.0	-19.4	1.37 V	122	38.39	16.21
4	11160.00	43.9 AV	54.0	-10.1	1.37 V	122	27.69	16.21
5	#16740.00	64.7 PK	74.0	-9.3	1.19 V	325	41.02	23.68
6	#16740.00	52.4 AV	54.0	-1.6	1.19 V	325	28.72	23.68

REMARKS:

1. Emission Level(dBuV/m) = Raw Value(dBuV) + Correction Factor(dB/m)
2. Correction Factor(dB/m) = Antenna Factor(dB/m) + Cable Factor(dB) – Pre-Amplifier Factor(dB)
3. The other emission levels were very low against the limit.
4. Margin value = Emission Level – Limit value
5. " * ": Fundamental frequency.
6. " # ": The radiated frequency is out of the restricted band.



A D T

CHANNEL	TX Channel 132	DETECTOR FUNCTION	Peak (PK)
FREQUENCY RANGE	1GHz ~ 40GHz		Average (AV)

ANTENNA POLARITY & TEST DISTANCE: HORIZONTAL AT 3 M

NO.	FREQ. (MHz)	EMISSION LEVEL (dBuV/m)	LIMIT (dBuV/m)	MARGIN (dB)	ANTENNA HEIGHT (m)	TABLE ANGLE (Degree)	RAW VALUE (dBuV)	CORRECTION FACTOR (dB/m)
1	*5660.00	112.3 PK			1.49 H	112	102.57	9.73
2	*5660.00	103.3 AV			1.49 H	112	93.57	9.73
3	11320.00	53.4 PK	74.0	-20.6	1.02 H	128	36.48	16.92
4	11320.00	40.3 AV	54.0	-13.7	1.02 H	128	23.38	16.92
5	#16980.00	62.1 PK	74.0	-11.9	1.05 H	9	37.90	24.20
6	#16980.00	51.6 AV	54.0	-2.4	1.05 H	9	27.40	24.20

ANTENNA POLARITY & TEST DISTANCE: VERTICAL AT 3 M

NO.	FREQ. (MHz)	EMISSION LEVEL (dBuV/m)	LIMIT (dBuV/m)	MARGIN (dB)	ANTENNA HEIGHT (m)	TABLE ANGLE (Degree)	RAW VALUE (dBuV)	CORRECTION FACTOR (dB/m)
1	*5660.00	109.8 PK			1.17 V	360	100.07	9.73
2	*5660.00	100.3 AV			1.17 V	360	90.57	9.73
3	11320.00	54.5 PK	74.0	-19.5	1.37 V	91	37.58	16.92
4	11320.00	44.2 AV	54.0	-9.8	1.37 V	91	27.28	16.92
5	#16980.00	65.1 PK	74.0	-8.9	1.18 V	332	40.90	24.20
6	#16980.00	52.5 AV	54.0	-1.5	1.18 V	332	28.30	24.20

REMARKS:

1. Emission Level(dBuV/m) = Raw Value(dBuV) + Correction Factor(dB/m)
2. Correction Factor(dB/m) = Antenna Factor(dB/m) + Cable Factor(dB) – Pre-Amplifier Factor(dB)
3. The other emission levels were very low against the limit.
4. Margin value = Emission Level – Limit value
5. " * ": Fundamental frequency.
6. " # ": The radiated frequency is out of the restricted band.



A D T

CHANNEL	TX Channel 140	DETECTOR FUNCTION	Peak (PK)
FREQUENCY RANGE	1GHz ~ 40GHz		Average (AV)

ANTENNA POLARITY & TEST DISTANCE: HORIZONTAL AT 3 M

NO.	FREQ. (MHz)	EMISSION LEVEL (dBuV/m)	LIMIT (dBuV/m)	MARGIN (dB)	ANTENNA HEIGHT (m)	TABLE ANGLE (Degree)	RAW VALUE (dBuV)	CORRECTION FACTOR (dB/m)
1	*5700.00	109.8 PK			1.75 H	117	99.92	9.88
2	*5700.00	101.0 AV			1.75 H	117	91.12	9.88
3	#5725.00	66.2 PK	74.0	-7.8	1.75 H	117	56.29	9.91
4	#5725.00	50.5 AV	54.0	-3.5	1.75 H	117	40.59	9.91
5	11400.00	52.8 PK	74.0	-21.2	1.00 H	134	36.05	16.75
6	11400.00	40.0 AV	54.0	-14.0	1.00 H	134	23.25	16.75
7	#17100.00	61.2 PK	74.0	-12.8	1.06 H	1	36.14	25.06
8	#17100.00	50.8 AV	54.0	-3.2	1.06 H	1	25.74	25.06

ANTENNA POLARITY & TEST DISTANCE: VERTICAL AT 3 M

NO.	FREQ. (MHz)	EMISSION LEVEL (dBuV/m)	LIMIT (dBuV/m)	MARGIN (dB)	ANTENNA HEIGHT (m)	TABLE ANGLE (Degree)	RAW VALUE (dBuV)	CORRECTION FACTOR (dB/m)
1	*5700.00	106.4 PK			1.17 V	345	96.52	9.88
2	*5700.00	97.6 AV			1.17 V	345	87.72	9.88
3	#5725.00	61.5 PK	74.0	-12.5	1.17 V	345	51.59	9.91
4	#5725.00	44.1 AV	54.0	-9.9	1.17 V	345	34.19	9.91
5	11400.00	55.3 PK	74.0	-18.7	1.31 V	92	38.55	16.75
6	11400.00	44.6 AV	54.0	-9.4	1.31 V	92	27.85	16.75
7	#17100.00	64.9 PK	74.0	-9.1	1.19 V	321	39.84	25.06
8	#17100.00	51.6 AV	54.0	-2.4	1.19 V	321	26.54	25.06

REMARKS:

1. Emission Level(dBuV/m) = Raw Value(dBuV) + Correction Factor(dB/m)
2. Correction Factor(dB/m) = Antenna Factor(dB/m) + Cable Factor(dB) – Pre-Amplifier Factor(dB)
3. The other emission levels were very low against the limit.
4. Margin value = Emission Level – Limit value
5. " * ": Fundamental frequency.
6. " # ": The radiated frequency is out of the restricted band.



A D T

802.11ac (VHT20)

CHANNEL	TX Channel 36	DETECTOR FUNCTION	Peak (PK)
FREQUENCY RANGE	1GHz ~ 40GHz		Average (AV)

ANTENNA POLARITY & TEST DISTANCE: HORIZONTAL AT 3 M

NO.	FREQ. (MHz)	EMISSION LEVEL (dBuV/m)	LIMIT (dBuV/m)	MARGIN (dB)	ANTENNA HEIGHT (m)	TABLE ANGLE (Degree)	RAW VALUE (dBuV)	CORRECTION FACTOR (dB/m)
1	5150.00	72.8 PK	74.0	-1.2	1.03 H	127	64.57	8.23
2	5150.00	53.1 AV	54.0	-0.9	1.03 H	127	44.87	8.23
3	*5180.00	108.4 PK			1.03 H	127	100.17	8.23
4	*5180.00	99.8 AV			1.03 H	127	91.57	8.23
5	#10360.00	52.9 PK	74.0	-21.1	1.03 H	116	38.02	14.88
6	#10360.00	40.1 AV	54.0	-13.9	1.03 H	116	25.22	14.88
7	15540.00	61.2 PK	74.0	-12.8	1.09 H	12	40.35	20.85
8	15540.00	50.3 AV	54.0	-3.7	1.09 H	12	29.45	20.85

ANTENNA POLARITY & TEST DISTANCE: VERTICAL AT 3 M

NO.	FREQ. (MHz)	EMISSION LEVEL (dBuV/m)	LIMIT (dBuV/m)	MARGIN (dB)	ANTENNA HEIGHT (m)	TABLE ANGLE (Degree)	RAW VALUE (dBuV)	CORRECTION FACTOR (dB/m)
1	5150.00	61.1 PK	74.0	-12.9	1.17 V	341	52.87	8.23
2	5150.00	44.2 AV	54.0	-9.8	1.17 V	341	35.97	8.23
3	*5180.00	105.1 PK			1.17 V	341	96.87	8.23
4	*5180.00	96.4 AV			1.17 V	341	88.17	8.23
5	#10360.00	55.0 PK	74.0	-19.0	1.35 V	76	40.12	14.88
6	#10360.00	44.2 AV	54.0	-9.8	1.35 V	76	29.32	14.88
7	15540.00	63.9 PK	74.0	-10.1	1.23 V	320	43.05	20.85
8	15540.00	50.8 AV	54.0	-3.2	1.23 V	320	29.95	20.85

REMARKS:

1. Emission Level(dBuV/m) = Raw Value(dBuV) + Correction Factor(dB/m)
2. Correction Factor(dB/m) = Antenna Factor(dB/m) + Cable Factor(dB) – Pre-Amplifier Factor(dB)
3. The other emission levels were very low against the limit.
4. Margin value = Emission Level – Limit value
5. " * ": Fundamental frequency.
6. " # ": The radiated frequency is out of the restricted band.



A D T

CHANNEL	TX Channel 40	DETECTOR FUNCTION	Peak (PK)
FREQUENCY RANGE	1GHz ~ 40GHz		Average (AV)

ANTENNA POLARITY & TEST DISTANCE: HORIZONTAL AT 3 M

NO.	FREQ. (MHz)	EMISSION LEVEL (dBuV/m)	LIMIT (dBuV/m)	MARGIN (dB)	ANTENNA HEIGHT (m)	TABLE ANGLE (Degree)	RAW VALUE (dBuV)	CORRECTION FACTOR (dB/m)
1	*5200.00	107.6 PK			1.07 H	117	99.36	8.24
2	*5200.00	99.1 AV			1.07 H	117	90.86	8.24
3	#10400.00	53.2 PK	74.0	-20.8	1.02 H	128	37.97	15.23
4	#10400.00	40.3 AV	54.0	-13.7	1.02 H	128	25.07	15.23
5	15600.00	61.5 PK	74.0	-12.5	1.10 H	18	40.62	20.88
6	15600.00	50.4 AV	54.0	-3.6	1.10 H	18	29.52	20.88

ANTENNA POLARITY & TEST DISTANCE: VERTICAL AT 3 M

NO.	FREQ. (MHz)	EMISSION LEVEL (dBuV/m)	LIMIT (dBuV/m)	MARGIN (dB)	ANTENNA HEIGHT (m)	TABLE ANGLE (Degree)	RAW VALUE (dBuV)	CORRECTION FACTOR (dB/m)
1	*5200.00	104.2 PK			1.14 V	340	95.96	8.24
2	*5200.00	95.8 AV			1.14 V	340	87.56	8.24
3	#10400.00	55.1 PK	74.0	-18.9	1.40 V	83	39.87	15.23
4	#10400.00	44.1 AV	54.0	-9.9	1.40 V	83	28.87	15.23
5	15600.00	64.3 PK	74.0	-9.7	1.21 V	327	43.42	20.88
6	15600.00	50.8 AV	54.0	-3.2	1.21 V	327	29.92	20.88

REMARKS:

1. Emission Level(dBuV/m) = Raw Value(dBuV) + Correction Factor(dB/m)
2. Correction Factor(dB/m) = Antenna Factor(dB/m) + Cable Factor(dB) – Pre-Amplifier Factor(dB)
3. The other emission levels were very low against the limit.
4. Margin value = Emission Level – Limit value
5. " * ": Fundamental frequency.
6. " # ": The radiated frequency is out of the restricted band.



A D T

CHANNEL	TX Channel 48	DETECTOR FUNCTION	Peak (PK)
FREQUENCY RANGE	1GHz ~ 40GHz		Average (AV)

ANTENNA POLARITY & TEST DISTANCE: HORIZONTAL AT 3 M

NO.	FREQ. (MHz)	EMISSION LEVEL (dBuV/m)	LIMIT (dBuV/m)	MARGIN (dB)	ANTENNA HEIGHT (m)	TABLE ANGLE (Degree)	RAW VALUE (dBuV)	CORRECTION FACTOR (dB/m)
1	*5240.00	108.1 PK			1.00 H	115	99.70	8.40
2	*5240.00	99.4 AV			1.00 H	115	91.00	8.40
3	#10480.00	54.0 PK	74.0	-20.0	1.00 H	143	38.79	15.21
4	#10480.00	40.7 AV	54.0	-13.3	1.00 H	143	25.49	15.21
5	15720.00	61.4 PK	74.0	-12.6	1.02 H	0	40.53	20.87
6	15720.00	50.2 AV	54.0	-3.8	1.02 H	0	29.33	20.87

ANTENNA POLARITY & TEST DISTANCE: VERTICAL AT 3 M

NO.	FREQ. (MHz)	EMISSION LEVEL (dBuV/m)	LIMIT (dBuV/m)	MARGIN (dB)	ANTENNA HEIGHT (m)	TABLE ANGLE (Degree)	RAW VALUE (dBuV)	CORRECTION FACTOR (dB/m)
1	*5240.00	104.8 PK			1.13 V	347	96.40	8.40
2	*5240.00	95.8 AV			1.13 V	347	87.40	8.40
3	#10480.00	54.8 PK	74.0	-19.2	1.39 V	94	39.59	15.21
4	#10480.00	43.6 AV	54.0	-10.4	1.39 V	94	28.39	15.21
5	15720.00	64.0 PK	74.0	-10.0	1.15 V	326	43.13	20.87
6	15720.00	50.7 AV	54.0	-3.3	1.15 V	326	29.83	20.87

REMARKS:

1. Emission Level(dBuV/m) = Raw Value(dBuV) + Correction Factor(dB/m)
2. Correction Factor(dB/m) = Antenna Factor(dB/m) + Cable Factor(dB) – Pre-Amplifier Factor(dB)
3. The other emission levels were very low against the limit.
4. Margin value = Emission Level – Limit value
5. " * ": Fundamental frequency.
6. " # ": The radiated frequency is out of the restricted band.



A D T

CHANNEL	TX Channel 52	DETECTOR FUNCTION	Peak (PK)
FREQUENCY RANGE	1GHz ~ 40GHz		Average (AV)

ANTENNA POLARITY & TEST DISTANCE: HORIZONTAL AT 3 M

NO.	FREQ. (MHz)	EMISSION LEVEL (dBuV/m)	LIMIT (dBuV/m)	MARGIN (dB)	ANTENNA HEIGHT (m)	TABLE ANGLE (Degree)	RAW VALUE (dBuV)	CORRECTION FACTOR (dB/m)
1	*5260.00	112.1 PK			1.32 H	121	103.64	8.46
2	*5260.00	102.6 AV			1.32 H	121	94.14	8.46
3	#10520.00	52.9 PK	74.0	-21.1	1.06 H	135	37.64	15.26
4	#10520.00	40.1 AV	54.0	-13.9	1.06 H	135	24.84	15.26
5	15780.00	62.2 PK	74.0	-11.8	1.03 H	0	41.45	20.75
6	15780.00	50.6 AV	54.0	-3.4	1.03 H	0	29.85	20.75

ANTENNA POLARITY & TEST DISTANCE: VERTICAL AT 3 M

NO.	FREQ. (MHz)	EMISSION LEVEL (dBuV/m)	LIMIT (dBuV/m)	MARGIN (dB)	ANTENNA HEIGHT (m)	TABLE ANGLE (Degree)	RAW VALUE (dBuV)	CORRECTION FACTOR (dB/m)
1	*5260.00	108.9 PK			1.13 V	345	100.44	8.46
2	*5260.00	99.4 AV			1.13 V	345	90.94	8.46
3	#10520.00	54.5 PK	74.0	-19.5	1.33 V	105	39.24	15.26
4	#10520.00	43.3 AV	54.0	-10.7	1.33 V	105	28.04	15.26
5	15780.00	64.3 PK	74.0	-9.7	1.10 V	327	43.55	20.75
6	15780.00	51.7 AV	54.0	-2.3	1.10 V	327	30.95	20.75

REMARKS:

1. Emission Level(dBuV/m) = Raw Value(dBuV) + Correction Factor(dB/m)
2. Correction Factor(dB/m) = Antenna Factor(dB/m) + Cable Factor(dB) – Pre-Amplifier Factor(dB)
3. The other emission levels were very low against the limit.
4. Margin value = Emission Level – Limit value
5. " * ": Fundamental frequency.
6. " # ": The radiated frequency is out of the restricted band.



A D T

CHANNEL	TX Channel 60	DETECTOR FUNCTION	Peak (PK)
FREQUENCY RANGE	1GHz ~ 40GHz		Average (AV)

ANTENNA POLARITY & TEST DISTANCE: HORIZONTAL AT 3 M

NO.	FREQ. (MHz)	EMISSION LEVEL (dBuV/m)	LIMIT (dBuV/m)	MARGIN (dB)	ANTENNA HEIGHT (m)	TABLE ANGLE (Degree)	RAW VALUE (dBuV)	CORRECTION FACTOR (dB/m)
1	*5300.00	112.2 PK			1.31 H	125	103.58	8.62
2	*5300.00	102.9 AV			1.31 H	125	94.28	8.62
3	10600.00	53.7 PK	74.0	-20.3	1.07 H	143	38.17	15.53
4	10600.00	40.4 AV	54.0	-13.6	1.07 H	143	24.87	15.53
5	15900.00	62.1 PK	74.0	-11.9	1.01 H	11	40.80	21.30
6	15900.00	50.9 AV	54.0	-3.1	1.01 H	11	29.60	21.30

ANTENNA POLARITY & TEST DISTANCE: VERTICAL AT 3 M

NO.	FREQ. (MHz)	EMISSION LEVEL (dBuV/m)	LIMIT (dBuV/m)	MARGIN (dB)	ANTENNA HEIGHT (m)	TABLE ANGLE (Degree)	RAW VALUE (dBuV)	CORRECTION FACTOR (dB/m)
1	*5300.00	108.6 PK			1.06 V	359	99.98	8.62
2	*5300.00	99.4 AV			1.06 V	359	90.78	8.62
3	10600.00	54.1 PK	74.0	-19.9	1.32 V	93	38.57	15.53
4	10600.00	43.1 AV	54.0	-10.9	1.32 V	93	27.57	15.53
5	15900.00	64.9 PK	74.0	-9.1	1.16 V	334	43.60	21.30
6	15900.00	52.2 AV	54.0	-1.8	1.16 V	334	30.90	21.30

REMARKS:

1. Emission Level(dBuV/m) = Raw Value(dBuV) + Correction Factor(dB/m)
2. Correction Factor(dB/m) = Antenna Factor(dB/m) + Cable Factor(dB) – Pre-Amplifier Factor(dB)
3. The other emission levels were very low against the limit.
4. Margin value = Emission Level – Limit value
5. " * ": Fundamental frequency.



A D T

CHANNEL	TX Channel 64	DETECTOR FUNCTION	Peak (PK)
FREQUENCY RANGE	1GHz ~ 40GHz		Average (AV)

ANTENNA POLARITY & TEST DISTANCE: HORIZONTAL AT 3 M

NO.	FREQ. (MHz)	EMISSION LEVEL (dBuV/m)	LIMIT (dBuV/m)	MARGIN (dB)	ANTENNA HEIGHT (m)	TABLE ANGLE (Degree)	RAW VALUE (dBuV)	CORRECTION FACTOR (dB/m)
1	*5320.00	111.0 PK			1.30 H	123	102.31	8.69
2	*5320.00	101.7 AV			1.30 H	123	93.01	8.69
3	5350.00	73.0 PK	74.0	-1.0	1.30 H	123	64.20	8.80
4	5350.00	52.5 AV	54.0	-1.5	1.30 H	123	43.70	8.80
5	10640.00	53.9 PK	74.0	-20.1	1.00 H	126	38.36	15.54
6	10640.00	40.7 AV	54.0	-13.3	1.00 H	126	25.16	15.54
7	15960.00	61.7 PK	74.0	-12.3	1.02 H	0	40.88	20.82
8	15960.00	49.8 AV	54.0	-4.2	1.02 H	0	28.98	20.82

ANTENNA POLARITY & TEST DISTANCE: VERTICAL AT 3 M

NO.	FREQ. (MHz)	EMISSION LEVEL (dBuV/m)	LIMIT (dBuV/m)	MARGIN (dB)	ANTENNA HEIGHT (m)	TABLE ANGLE (Degree)	RAW VALUE (dBuV)	CORRECTION FACTOR (dB/m)
1	*5320.00	107.9 PK			1.05 V	349	99.21	8.69
2	*5320.00	98.2 AV			1.05 V	349	89.51	8.69
3	5350.00	61.7 PK	74.0	-12.3	1.05 V	349	52.90	8.80
4	5350.00	44.7 AV	54.0	-9.3	1.05 V	349	35.90	8.80
5	10640.00	54.5 PK	74.0	-19.5	1.36 V	98	38.96	15.54
6	10640.00	43.6 AV	54.0	-10.4	1.36 V	98	28.06	15.54
7	15960.00	63.6 PK	74.0	-10.4	1.15 V	327	42.78	20.82
8	15960.00	50.8 AV	54.0	-3.2	1.15 V	327	29.98	20.82

REMARKS:

1. Emission Level(dBuV/m) = Raw Value(dBuV) + Correction Factor(dB/m)
2. Correction Factor(dB/m) = Antenna Factor(dB/m) + Cable Factor(dB) – Pre-Amplifier Factor(dB)
3. The other emission levels were very low against the limit.
4. Margin value = Emission Level – Limit value
5. " * ": Fundamental frequency.



A D T

CHANNEL	TX Channel 100	DETECTOR FUNCTION	Peak (PK)
FREQUENCY RANGE	1GHz ~ 40GHz		Average (AV)

ANTENNA POLARITY & TEST DISTANCE: HORIZONTAL AT 3 M

NO.	FREQ. (MHz)	EMISSION LEVEL (dBuV/m)	LIMIT (dBuV/m)	MARGIN (dB)	ANTENNA HEIGHT (m)	TABLE ANGLE (Degree)	RAW VALUE (dBuV)	CORRECTION FACTOR (dB/m)
1	5460.00	61.5 PK	74.0	-12.5	1.52 H	118	52.31	9.19
2	5460.00	44.8 AV	54.0	-9.2	1.52 H	118	35.61	9.19
3	#5470.00	70.3 PK	74.0	-3.7	1.52 H	118	61.08	9.22
4	#5470.00	52.7 AV	54.0	-1.3	1.52 H	118	43.48	9.22
5	*5500.00	111.3 PK			1.52 H	118	101.97	9.33
6	*5500.00	101.3 AV			1.52 H	118	91.97	9.33
7	11000.00	53.2 PK	74.0	-20.8	1.01 H	128	36.25	16.95
8	11000.00	39.9 AV	54.0	-14.1	1.01 H	128	22.95	16.95
9	#16500.00	61.5 PK	74.0	-12.5	1.00 H	18	38.46	23.04
10	#16500.00	49.6 AV	54.0	-4.4	1.00 H	18	26.56	23.04

ANTENNA POLARITY & TEST DISTANCE: VERTICAL AT 3 M

NO.	FREQ. (MHz)	EMISSION LEVEL (dBuV/m)	LIMIT (dBuV/m)	MARGIN (dB)	ANTENNA HEIGHT (m)	TABLE ANGLE (Degree)	RAW VALUE (dBuV)	CORRECTION FACTOR (dB/m)
1	5460.00	61.6 PK	74.0	-12.4	1.05 V	34	52.41	9.19
2	5460.00	44.7 AV	54.0	-9.3	1.05 V	34	35.51	9.19
3	#5470.00	62.7 PK	74.0	-11.3	1.05 V	347	53.48	9.22
4	#5470.00	45.6 AV	54.0	-8.4	1.05 V	347	36.38	9.22
5	*5500.00	108.1 PK			1.05 V	347	98.77	9.33
6	*5500.00	98.1 AV			1.05 V	347	88.77	9.33
7	11000.00	54.4 PK	74.0	-19.6	1.30 V	116	37.45	16.95
8	11000.00	43.1 AV	54.0	-10.9	1.30 V	116	26.15	16.95
9	#16500.00	63.4 PK	74.0	-10.6	1.08 V	341	40.36	23.04
10	#16500.00	50.7 AV	54.0	-3.3	1.08 V	341	27.66	23.04

REMARKS:

1. Emission Level(dBuV/m) = Raw Value(dBuV) + Correction Factor(dB/m)
2. Correction Factor(dB/m) = Antenna Factor(dB/m) + Cable Factor(dB) – Pre-Amplifier Factor(dB)
3. The other emission levels were very low against the limit.
4. Margin value = Emission Level – Limit value
5. " * ": Fundamental frequency.
6. " # ": The radiated frequency is out of the restricted band.



A D T

CHANNEL	TX Channel 116	DETECTOR FUNCTION	Peak (PK)
FREQUENCY RANGE	1GHz ~ 40GHz		Average (AV)

ANTENNA POLARITY & TEST DISTANCE: HORIZONTAL AT 3 M

NO.	FREQ. (MHz)	EMISSION LEVEL (dBuV/m)	LIMIT (dBuV/m)	MARGIN (dB)	ANTENNA HEIGHT (m)	TABLE ANGLE (Degree)	RAW VALUE (dBuV)	CORRECTION FACTOR (dB/m)
1	*5580.00	111.5 PK			1.31 H	138	102.03	9.47
2	*5580.00	102.5 AV			1.31 H	138	93.03	9.47
3	11160.00	52.9 PK	74.0	-21.1	1.12 H	134	36.69	16.21
4	11160.00	39.8 AV	54.0	-14.2	1.12 H	134	23.59	16.21
5	#16740.00	61.9 PK	74.0	-12.1	1.06 H	0	38.22	23.68
6	#16740.00	50.3 AV	54.0	-3.7	1.06 H	0	26.62	23.68

ANTENNA POLARITY & TEST DISTANCE: VERTICAL AT 3 M

NO.	FREQ. (MHz)	EMISSION LEVEL (dBuV/m)	LIMIT (dBuV/m)	MARGIN (dB)	ANTENNA HEIGHT (m)	TABLE ANGLE (Degree)	RAW VALUE (dBuV)	CORRECTION FACTOR (dB/m)
1	*5580.00	108.1 PK			1.05 V	346	98.63	9.47
2	*5580.00	99.1 AV			1.05 V	346	89.63	9.47
3	11160.00	54.7 PK	74.0	-19.3	1.29 V	91	38.49	16.21
4	11160.00	43.5 AV	54.0	-10.5	1.29 V	91	27.29	16.21
5	#16740.00	64.4 PK	74.0	-9.6	1.04 V	324	40.72	23.68
6	#16740.00	51.4 AV	54.0	-2.6	1.04 V	324	27.72	23.68

REMARKS:

1. Emission Level(dBuV/m) = Raw Value(dBuV) + Correction Factor(dB/m)
2. Correction Factor(dB/m) = Antenna Factor(dB/m) + Cable Factor(dB) – Pre-Amplifier Factor(dB)
3. The other emission levels were very low against the limit.
4. Margin value = Emission Level – Limit value
5. " * ": Fundamental frequency.
6. " # ": The radiated frequency is out of the restricted band.



A D T

CHANNEL	TX Channel 132	DETECTOR FUNCTION	Peak (PK)
FREQUENCY RANGE	1GHz ~ 40GHz		Average (AV)

ANTENNA POLARITY & TEST DISTANCE: HORIZONTAL AT 3 M

NO.	FREQ. (MHz)	EMISSION LEVEL (dBuV/m)	LIMIT (dBuV/m)	MARGIN (dB)	ANTENNA HEIGHT (m)	TABLE ANGLE (Degree)	RAW VALUE (dBuV)	CORRECTION FACTOR (dB/m)
1	*5660.00	112.4 PK			1.33 H	108	102.67	9.73
2	*5660.00	102.9 AV			1.33 H	108	93.17	9.73
3	11320.00	52.4 PK	74.0	-21.6	1.04 H	123	35.48	16.92
4	11320.00	39.8 AV	54.0	-14.2	1.04 H	123	22.88	16.92
5	#16980.00	62.2 PK	74.0	-11.8	1.01 H	0	38.00	24.20
6	#16980.00	50.6 AV	54.0	-3.4	1.01 H	0	26.40	24.20

ANTENNA POLARITY & TEST DISTANCE: VERTICAL AT 3 M

NO.	FREQ. (MHz)	EMISSION LEVEL (dBuV/m)	LIMIT (dBuV/m)	MARGIN (dB)	ANTENNA HEIGHT (m)	TABLE ANGLE (Degree)	RAW VALUE (dBuV)	CORRECTION FACTOR (dB/m)
1	*5660.00	109.2 PK			1.05 V	350	99.47	9.73
2	*5660.00	100.1 AV			1.05 V	350	90.37	9.73
3	11320.00	54.7 PK	74.0	-19.3	1.28 V	107	37.78	16.92
4	11320.00	43.5 AV	54.0	-10.5	1.28 V	107	26.58	16.92
5	#16980.00	64.0 PK	74.0	-10.0	1.05 V	323	39.80	24.20
6	#16980.00	51.7 AV	54.0	-2.3	1.05 V	323	27.50	24.20

REMARKS:

1. Emission Level(dBuV/m) = Raw Value(dBuV) + Correction Factor(dB/m)
2. Correction Factor(dB/m) = Antenna Factor(dB/m) + Cable Factor(dB) – Pre-Amplifier Factor(dB)
3. The other emission levels were very low against the limit.
4. Margin value = Emission Level – Limit value
5. " * ": Fundamental frequency.
6. " # ": The radiated frequency is out of the restricted band.



A D T

CHANNEL	TX Channel 140	DETECTOR FUNCTION	Peak (PK)
FREQUENCY RANGE	1GHz ~ 40GHz		Average (AV)

ANTENNA POLARITY & TEST DISTANCE: HORIZONTAL AT 3 M

NO.	FREQ. (MHz)	EMISSION LEVEL (dBuV/m)	LIMIT (dBuV/m)	MARGIN (dB)	ANTENNA HEIGHT (m)	TABLE ANGLE (Degree)	RAW VALUE (dBuV)	CORRECTION FACTOR (dB/m)
1	*5700.00	109.3 PK			1.47 H	119	99.42	9.88
2	*5700.00	100.2 AV			1.47 H	119	90.32	9.88
3	#5725.00	71.5 PK	74.0	-2.5	1.47 H	119	61.59	9.91
4	#5725.00	51.8 AV	54.0	-2.2	1.47 H	119	41.89	9.91
5	11400.00	52.8 PK	74.0	-21.2	1.00 H	127	36.05	16.75
6	11400.00	39.6 AV	54.0	-14.4	1.00 H	127	22.85	16.75
7	#17100.00	60.8 PK	74.0	-13.2	1.05 H	25	35.74	25.06
8	#17100.00	49.2 AV	54.0	-4.8	1.05 H	25	24.14	25.06

ANTENNA POLARITY & TEST DISTANCE: VERTICAL AT 3 M

NO.	FREQ. (MHz)	EMISSION LEVEL (dBuV/m)	LIMIT (dBuV/m)	MARGIN (dB)	ANTENNA HEIGHT (m)	TABLE ANGLE (Degree)	RAW VALUE (dBuV)	CORRECTION FACTOR (dB/m)
1	*5700.00	105.7 PK			1.12 V	339	95.82	9.88
2	*5700.00	96.8 AV			1.12 V	339	86.92	9.88
3	#5725.00	61.3 PK	74.0	-12.7	1.12 V	339	51.39	9.91
4	#5725.00	43.9 AV	54.0	-10.1	1.12 V	339	33.99	9.91
5	11400.00	55.2 PK	74.0	-18.8	1.30 V	110	38.45	16.75
6	11400.00	43.8 AV	54.0	-10.2	1.30 V	110	27.05	16.75
7	#17100.00	64.0 PK	74.0	-10.0	1.04 V	329	38.94	25.06
8	#17100.00	50.8 AV	54.0	-3.2	1.04 V	329	25.74	25.06

REMARKS:

1. Emission Level(dBuV/m) = Raw Value(dBuV) + Correction Factor(dB/m)
2. Correction Factor(dB/m) = Antenna Factor(dB/m) + Cable Factor(dB) – Pre-Amplifier Factor(dB)
3. The other emission levels were very low against the limit.
4. Margin value = Emission Level – Limit value
5. " * ": Fundamental frequency.
6. " # ": The radiated frequency is out of the restricted band.



A D T

802.11ac (VHT40)

CHANNEL	TX Channel 38	DETECTOR FUNCTION	Peak (PK)
FREQUENCY RANGE	1GHz ~ 40GHz		Average (AV)

ANTENNA POLARITY & TEST DISTANCE: HORIZONTAL AT 3 M

NO.	FREQ. (MHz)	EMISSION LEVEL (dBuV/m)	LIMIT (dBuV/m)	MARGIN (dB)	ANTENNA HEIGHT (m)	TABLE ANGLE (Degree)	RAW VALUE (dBuV)	CORRECTION FACTOR (dB/m)
1	5150.00	66.3 PK	74.0	-7.7	1.63 H	83	58.07	8.23
2	5150.00	52.7 AV	54.0	-1.3	1.63 H	83	44.47	8.23
3	*5190.00	103.0 PK			1.63 H	83	94.76	8.24
4	*5190.00	92.9 AV			1.63 H	83	84.66	8.24
5	#10380.00	54.2 PK	74.0	-19.8	1.04 H	124	39.14	15.06
6	#10380.00	43.1 AV	54.0	-10.9	1.04 H	124	28.04	15.06
7	15570.00	62.7 PK	74.0	-11.3	1.02 H	241	41.84	20.86
8	15570.00	49.9 AV	54.0	-4.1	1.02 H	241	29.04	20.86

ANTENNA POLARITY & TEST DISTANCE: VERTICAL AT 3 M

NO.	FREQ. (MHz)	EMISSION LEVEL (dBuV/m)	LIMIT (dBuV/m)	MARGIN (dB)	ANTENNA HEIGHT (m)	TABLE ANGLE (Degree)	RAW VALUE (dBuV)	CORRECTION FACTOR (dB/m)
1	5150.00	61.8 PK	74.0	-12.2	1.09 V	339	53.57	8.23
2	5150.00	44.6 AV	54.0	-9.4	1.09 V	339	36.37	8.23
3	*5190.00	99.7 PK			1.09 V	339	91.46	8.24
4	*5190.00	89.5 AV			1.09 V	339	81.26	8.24
5	#10380.00	54.8 PK	74.0	-19.2	1.33 V	107	39.74	15.06
6	#10380.00	43.6 AV	54.0	-10.4	1.33 V	107	28.54	15.06
7	15570.00	63.2 PK	74.0	-10.8	1.04 V	316	42.34	20.86
8	15570.00	50.1 AV	54.0	-3.9	1.04 V	316	29.24	20.86

REMARKS:

1. Emission Level(dBuV/m) = Raw Value(dBuV) + Correction Factor(dB/m)
2. Correction Factor(dB/m) = Antenna Factor(dB/m) + Cable Factor(dB) – Pre-Amplifier Factor(dB)
3. The other emission levels were very low against the limit.
4. Margin value = Emission Level – Limit value
5. " * ": Fundamental frequency.
6. " # ": The radiated frequency is out of the restricted band.



A D T

CHANNEL	TX Channel 46	DETECTOR FUNCTION	Peak (PK)
FREQUENCY RANGE	1GHz ~ 40GHz		Average (AV)

ANTENNA POLARITY & TEST DISTANCE: HORIZONTAL AT 3 M

NO.	FREQ. (MHz)	EMISSION LEVEL (dBuV/m)	LIMIT (dBuV/m)	MARGIN (dB)	ANTENNA HEIGHT (m)	TABLE ANGLE (Degree)	RAW VALUE (dBuV)	CORRECTION FACTOR (dB/m)
1	*5230.00	106.4 PK			1.57 H	100	98.04	8.36
2	*5230.00	96.1 AV			1.57 H	100	87.74	8.36
3	#10460.00	54.0 PK	74.0	-20.0	1.00 H	134	38.79	15.21
4	#10460.00	40.4 AV	54.0	-13.6	1.00 H	134	25.19	15.21
5	15690.00	61.5 PK	74.0	-12.5	1.00 H	33	40.59	20.91
6	15690.00	49.4 AV	54.0	-4.6	1.00 H	33	28.49	20.91

ANTENNA POLARITY & TEST DISTANCE: VERTICAL AT 3 M

NO.	FREQ. (MHz)	EMISSION LEVEL (dBuV/m)	LIMIT (dBuV/m)	MARGIN (dB)	ANTENNA HEIGHT (m)	TABLE ANGLE (Degree)	RAW VALUE (dBuV)	CORRECTION FACTOR (dB/m)
1	*5230.00	103.1 PK			1.07 V	342	94.74	8.36
2	*5230.00	93.0 AV			1.07 V	342	84.64	8.36
3	#10460.00	54.9 PK	74.0	-19.1	1.35 V	117	39.69	15.21
4	#10460.00	43.4 AV	54.0	-10.6	1.35 V	117	28.19	15.21
5	15690.00	64.0 PK	74.0	-10.0	1.05 V	331	43.09	20.91
6	15690.00	50.8 AV	54.0	-3.2	1.05 V	331	29.89	20.91

REMARKS:

1. Emission Level(dBuV/m) = Raw Value(dBuV) + Correction Factor(dB/m)
2. Correction Factor(dB/m) = Antenna Factor(dB/m) + Cable Factor(dB) – Pre-Amplifier Factor(dB)
3. The other emission levels were very low against the limit.
4. Margin value = Emission Level – Limit value
5. " * ": Fundamental frequency.
6. " # ": The radiated frequency is out of the restricted band.



A D T

CHANNEL	TX Channel 54	DETECTOR FUNCTION	Peak (PK)
FREQUENCY RANGE	1GHz ~ 40GHz		Average (AV)

ANTENNA POLARITY & TEST DISTANCE: HORIZONTAL AT 3 M

NO.	FREQ. (MHz)	EMISSION LEVEL (dBuV/m)	LIMIT (dBuV/m)	MARGIN (dB)	ANTENNA HEIGHT (m)	TABLE ANGLE (Degree)	RAW VALUE (dBuV)	CORRECTION FACTOR (dB/m)
1	*5270.00	107.7 PK			1.63 H	86	99.20	8.50
2	*5270.00	97.2 AV			1.63 H	86	88.70	8.50
3	#10540.00	54.2 PK	74.0	-19.8	1.00 H	133	38.87	15.33
4	#10540.00	43.1 AV	54.0	-10.9	1.00 H	133	27.77	15.33
5	15810.00	62.9 PK	74.0	-11.1	1.00 H	234	42.14	20.76
6	15810.00	50.1 AV	54.0	-3.9	1.00 H	234	29.34	20.76

ANTENNA POLARITY & TEST DISTANCE: VERTICAL AT 3 M

NO.	FREQ. (MHz)	EMISSION LEVEL (dBuV/m)	LIMIT (dBuV/m)	MARGIN (dB)	ANTENNA HEIGHT (m)	TABLE ANGLE (Degree)	RAW VALUE (dBuV)	CORRECTION FACTOR (dB/m)
1	*5270.00	104.1 PK			1.05 V	341	95.60	8.50
2	*5270.00	93.8 AV			1.05 V	341	85.30	8.50
3	#10540.00	54.8 PK	74.0	-19.2	1.27 V	113	39.47	15.33
4	#10540.00	43.6 AV	54.0	-10.4	1.27 V	113	28.27	15.33
5	15810.00	64.6 PK	74.0	-9.4	1.05 V	314	43.84	20.76
6	15810.00	51.2 AV	54.0	-2.8	1.05 V	314	30.44	20.76

REMARKS:

1. Emission Level(dBuV/m) = Raw Value(dBuV) + Correction Factor(dB/m)
2. Correction Factor(dB/m) = Antenna Factor(dB/m) + Cable Factor(dB) – Pre-Amplifier Factor(dB)
3. The other emission levels were very low against the limit.
4. Margin value = Emission Level – Limit value
5. " * ": Fundamental frequency.
6. " # ": The radiated frequency is out of the restricted band.



A D T

CHANNEL	TX Channel 62	DETECTOR FUNCTION	Peak (PK)
FREQUENCY RANGE	1GHz ~ 40GHz		Average (AV)

ANTENNA POLARITY & TEST DISTANCE: HORIZONTAL AT 3 M

NO.	FREQ. (MHz)	EMISSION LEVEL (dBuV/m)	LIMIT (dBuV/m)	MARGIN (dB)	ANTENNA HEIGHT (m)	TABLE ANGLE (Degree)	RAW VALUE (dBuV)	CORRECTION FACTOR (dB/m)
1	*5310.00	103.5 PK			1.63 H	84	94.85	8.65
2	*5310.00	93.3 AV			1.63 H	84	84.65	8.65
3	5350.00	68.6 PK	74.0	-5.4	1.63 H	84	59.80	8.80
4	5350.00	53.1 AV	54.0	-0.9	1.63 H	84	44.30	8.80
5	10620.00	54.6 PK	74.0	-19.4	1.07 H	133	39.07	15.53
6	10620.00	43.3 AV	54.0	-10.7	1.07 H	133	27.77	15.53
7	15930.00	62.1 PK	74.0	-11.9	1.00 H	253	41.03	21.07
8	15930.00	49.4 AV	54.0	-4.6	1.00 H	253	28.33	21.07

ANTENNA POLARITY & TEST DISTANCE: VERTICAL AT 3 M

NO.	FREQ. (MHz)	EMISSION LEVEL (dBuV/m)	LIMIT (dBuV/m)	MARGIN (dB)	ANTENNA HEIGHT (m)	TABLE ANGLE (Degree)	RAW VALUE (dBuV)	CORRECTION FACTOR (dB/m)
1	*5310.00	100.2 PK			1.02 V	343	91.55	8.65
2	*5310.00	90.1 AV			1.02 V	343	81.45	8.65
3	5350.00	61.8 PK	74.0	-12.2	1.02 V	343	53.00	8.80
4	5350.00	44.5 AV	54.0	-9.5	1.02 V	343	35.70	8.80
5	10620.00	55.0 PK	74.0	-19.0	1.34 V	113	39.47	15.53
6	10620.00	43.6 AV	54.0	-10.4	1.34 V	113	28.07	15.53
7	15930.00	63.7 PK	74.0	-10.3	1.09 V	334	42.63	21.07
8	15930.00	50.4 AV	54.0	-3.6	1.09 V	334	29.33	21.07

REMARKS:

1. Emission Level(dBuV/m) = Raw Value(dBuV) + Correction Factor(dB/m)
2. Correction Factor(dB/m) = Antenna Factor(dB/m) + Cable Factor(dB) – Pre-Amplifier Factor(dB)
3. The other emission levels were very low against the limit.
4. Margin value = Emission Level – Limit value
5. " * ": Fundamental frequency.



A D T

CHANNEL	TX Channel 102	DETECTOR FUNCTION	Peak (PK)
FREQUENCY RANGE	1GHz ~ 40GHz		Average (AV)

ANTENNA POLARITY & TEST DISTANCE: HORIZONTAL AT 3 M

NO.	FREQ. (MHz)	EMISSION LEVEL (dBuV/m)	LIMIT (dBuV/m)	MARGIN (dB)	ANTENNA HEIGHT (m)	TABLE ANGLE (Degree)	RAW VALUE (dBuV)	CORRECTION FACTOR (dB/m)
1	5460.00	60.0 PK	74.0	-14.0	1.21 H	134	50.81	9.19
2	5460.00	47.2 AV	54.0	-6.8	1.21 H	134	38.01	9.19
3	#5470.00	65.9 PK	74.0	-8.1	1.21 H	134	56.68	9.22
4	#5470.00	52.9 AV	54.0	-1.1	1.21 H	134	43.68	9.22
5	*5510.00	102.9 PK			1.21 H	134	93.55	9.35
6	*5510.00	92.6 AV			1.21 H	134	83.25	9.35
7	11020.00	53.4 PK	74.0	-20.6	1.00 H	115	36.59	16.81
8	11020.00	40.2 AV	54.0	-13.8	1.00 H	115	23.39	16.81
9	#16530.00	62.1 PK	74.0	-11.9	1.00 H	5	38.94	23.16
10	#16530.00	49.9 AV	54.0	-4.1	1.00 H	5	26.74	23.16

ANTENNA POLARITY & TEST DISTANCE: VERTICAL AT 3 M

NO.	FREQ. (MHz)	EMISSION LEVEL (dBuV/m)	LIMIT (dBuV/m)	MARGIN (dB)	ANTENNA HEIGHT (m)	TABLE ANGLE (Degree)	RAW VALUE (dBuV)	CORRECTION FACTOR (dB/m)
1	5460.00	61.0 PK	74.0	-13.0	1.05 V	347	51.81	9.19
2	5460.00	44.1 AV	54.0	-9.9	1.05 V	347	34.91	9.19
3	#5470.00	62.6 PK	74.0	-11.4	1.05 V	347	53.38	9.22
4	#5470.00	45.8 AV	54.0	-8.2	1.05 V	347	36.58	9.22
5	*5510.00	99.2 PK			1.05 V	347	89.85	9.35
6	*5510.00	89.1 AV			1.05 V	347	79.75	9.35
7	11020.00	54.6 PK	74.0	-19.4	1.28 V	96	37.79	16.81
8	11020.00	43.6 AV	54.0	-10.4	1.28 V	96	26.79	16.81
9	#16530.00	63.3 PK	74.0	-10.7	1.01 V	319	40.14	23.16
10	#16530.00	50.0 AV	54.0	-4.0	1.01 V	319	26.84	23.16

REMARKS:

1. Emission Level(dBuV/m) = Raw Value(dBuV) + Correction Factor(dB/m)
2. Correction Factor(dB/m) = Antenna Factor(dB/m) + Cable Factor(dB) – Pre-Amplifier Factor(dB)
3. The other emission levels were very low against the limit.
4. Margin value = Emission Level – Limit value
5. " * ": Fundamental frequency.
6. " # ": The radiated frequency is out of the restricted band.



A D T

CHANNEL	TX Channel 110	DETECTOR FUNCTION	Peak (PK)
FREQUENCY RANGE	1GHz ~ 40GHz		Average (AV)

ANTENNA POLARITY & TEST DISTANCE: HORIZONTAL AT 3 M

NO.	FREQ. (MHz)	EMISSION LEVEL (dBuV/m)	LIMIT (dBuV/m)	MARGIN (dB)	ANTENNA HEIGHT (m)	TABLE ANGLE (Degree)	RAW VALUE (dBuV)	CORRECTION FACTOR (dB/m)
1	*5550.00	110.4 PK			1.45 H	120	100.98	9.42
2	*5550.00	99.5 AV			1.45 H	120	90.08	9.42
3	11100.00	53.7 PK	74.0	-20.3	1.05 H	126	37.38	16.32
4	11100.00	42.7 AV	54.0	-11.3	1.05 H	126	26.38	16.32
5	#16650.00	62.4 PK	74.0	-11.6	1.01 H	239	38.95	23.45
6	#16650.00	49.9 AV	54.0	-4.1	1.01 H	239	26.45	23.45

ANTENNA POLARITY & TEST DISTANCE: VERTICAL AT 3 M

NO.	FREQ. (MHz)	EMISSION LEVEL (dBuV/m)	LIMIT (dBuV/m)	MARGIN (dB)	ANTENNA HEIGHT (m)	TABLE ANGLE (Degree)	RAW VALUE (dBuV)	CORRECTION FACTOR (dB/m)
1	*5550.00	107.2 PK			1.05 V	342	97.78	9.42
2	*5550.00	96.2 AV			1.05 V	342	86.78	9.42
3	11100.00	55.8 PK	74.0	-18.2	1.28 V	97	39.48	16.32
4	11100.00	44.2 AV	54.0	-9.8	1.28 V	97	27.88	16.32
5	#16650.00	64.1 PK	74.0	-9.9	1.00 V	331	40.65	23.45
6	#16650.00	50.8 AV	54.0	-3.2	1.00 V	331	27.35	23.45

REMARKS:

1. Emission Level(dBuV/m) = Raw Value(dBuV) + Correction Factor(dB/m)
2. Correction Factor(dB/m) = Antenna Factor(dB/m) + Cable Factor(dB) – Pre-Amplifier Factor(dB)
3. The other emission levels were very low against the limit.
4. Margin value = Emission Level – Limit value
5. " * ": Fundamental frequency.
6. " # ": The radiated frequency is out of the restricted band.



A D T

CHANNEL	TX Channel 134	DETECTOR FUNCTION	Peak (PK)
FREQUENCY RANGE	1GHz ~ 40GHz		Average (AV)

ANTENNA POLARITY & TEST DISTANCE: HORIZONTAL AT 3 M

NO.	FREQ. (MHz)	EMISSION LEVEL (dBuV/m)	LIMIT (dBuV/m)	MARGIN (dB)	ANTENNA HEIGHT (m)	TABLE ANGLE (Degree)	RAW VALUE (dBuV)	CORRECTION FACTOR (dB/m)
1	*5670.00	108.2 PK			1.46 H	121	98.43	9.77
2	*5670.00	97.8 AV			1.46 H	121	88.03	9.77
3	#5725.00	67.9 PK	74.0	-6.1	1.46 H	121	57.99	9.91
4	#5725.00	52.7 AV	54.0	-1.3	1.46 H	121	42.79	9.91
5	11340.00	54.3 PK	74.0	-19.7	1.00 H	130	37.42	16.88
6	11340.00	43.1 AV	54.0	-10.9	1.00 H	130	26.22	16.88
7	#17010.00	62.4 PK	74.0	-11.6	1.05 H	249	38.15	24.25
8	#17010.00	49.8 AV	54.0	-4.2	1.05 H	249	25.55	24.25

ANTENNA POLARITY & TEST DISTANCE: VERTICAL AT 3 M

NO.	FREQ. (MHz)	EMISSION LEVEL (dBuV/m)	LIMIT (dBuV/m)	MARGIN (dB)	ANTENNA HEIGHT (m)	TABLE ANGLE (Degree)	RAW VALUE (dBuV)	CORRECTION FACTOR (dB/m)
1	*5670.00	105.1 PK			1.09 V	341	95.33	9.77
2	*5670.00	94.7 AV			1.09 V	341	84.93	9.77
3	#5725.00	61.4 PK	74.0	-12.6	1.09 V	341	51.49	9.91
4	#5725.00	43.9 AV	54.0	-10.1	1.09 V	341	33.99	9.91
5	11340.00	54.6 PK	74.0	-19.4	1.30 V	103	37.72	16.88
6	11340.00	43.4 AV	54.0	-10.6	1.30 V	103	26.52	16.88
7	#17010.00	63.1 PK	74.0	-10.9	1.02 V	328	38.85	24.25
8	#17010.00	50.1 AV	54.0	-3.9	1.02 V	328	25.85	24.25

REMARKS:

1. Emission Level(dBuV/m) = Raw Value(dBuV) + Correction Factor(dB/m)
2. Correction Factor(dB/m) = Antenna Factor(dB/m) + Cable Factor(dB) – Pre-Amplifier Factor(dB)
3. The other emission levels were very low against the limit.
4. Margin value = Emission Level – Limit value
5. " * ": Fundamental frequency.
6. " # ": The radiated frequency is out of the restricted band.



A D T

802.11ac (VHT80)

CHANNEL	TX Channel 42	DETECTOR FUNCTION	Peak (PK)
FREQUENCY RANGE	1GHz ~ 40GHz		Average (AV)

ANTENNA POLARITY & TEST DISTANCE: HORIZONTAL AT 3 M

NO.	FREQ. (MHz)	EMISSION LEVEL (dBuV/m)	LIMIT (dBuV/m)	MARGIN (dB)	ANTENNA HEIGHT (m)	TABLE ANGLE (Degree)	RAW VALUE (dBuV)	CORRECTION FACTOR (dB/m)
1	5150.00	70.1 PK	74.0	-3.9	1.38 H	87	61.87	8.23
2	5150.00	53.0 AV	54.0	-1.0	1.38 H	87	44.77	8.23
3	*5210.00	99.4 PK			1.38 H	87	91.13	8.27
4	*5210.00	90.0 AV			1.38 H	87	81.73	8.27
5	#10420.00	54.9 PK	74.0	-19.1	1.05 H	115	39.69	15.21
6	#10420.00	43.5 AV	54.0	-10.5	1.05 H	115	28.29	15.21
7	15630.00	62.5 PK	74.0	-11.5	1.00 H	254	41.61	20.89
8	15630.00	49.4 AV	54.0	-4.6	1.00 H	254	28.51	20.89

ANTENNA POLARITY & TEST DISTANCE: VERTICAL AT 3 M

NO.	FREQ. (MHz)	EMISSION LEVEL (dBuV/m)	LIMIT (dBuV/m)	MARGIN (dB)	ANTENNA HEIGHT (m)	TABLE ANGLE (Degree)	RAW VALUE (dBuV)	CORRECTION FACTOR (dB/m)
1	5150.00	61.5 PK	74.0	-12.5	1.05 V	340	53.27	8.23
2	5150.00	44.2 AV	54.0	-9.8	1.05 V	340	35.97	8.23
3	*5210.00	96.1 PK			1.05 V	340	87.83	8.27
4	*5210.00	86.7 AV			1.05 V	340	78.43	8.27
5	#10420.00	54.3 PK	74.0	-19.7	1.28 V	118	39.09	15.21
6	#10420.00	43.0 AV	54.0	-11.0	1.28 V	118	27.79	15.21
7	15630.00	62.9 PK	74.0	-11.1	1.06 V	313	42.01	20.89
8	15630.00	49.9 AV	54.0	-4.1	1.06 V	313	29.01	20.89

REMARKS:

1. Emission Level(dBuV/m) = Raw Value(dBuV) + Correction Factor(dB/m)
2. Correction Factor(dB/m) = Antenna Factor(dB/m) + Cable Factor(dB) – Pre-Amplifier Factor(dB)
3. The other emission levels were very low against the limit.
4. Margin value = Emission Level – Limit value
5. " * ": Fundamental frequency.
6. " # ": The radiated frequency is out of the restricted band.



A D T

CHANNEL	TX Channel 58	DETECTOR FUNCTION	Peak (PK)
FREQUENCY RANGE	1GHz ~ 40GHz		Average (AV)

ANTENNA POLARITY & TEST DISTANCE: HORIZONTAL AT 3 M

NO.	FREQ. (MHz)	EMISSION LEVEL (dBuV/m)	LIMIT (dBuV/m)	MARGIN (dB)	ANTENNA HEIGHT (m)	TABLE ANGLE (Degree)	RAW VALUE (dBuV)	CORRECTION FACTOR (dB/m)
1	5150.00	51.7 PK	74.0	-22.3	1.34 H	85	43.47	8.23
2	5150.00	40.7 AV	54.0	-13.3	1.34 H	85	32.47	8.23
3	*5290.00	98.9 PK			1.34 H	85	90.31	8.59
4	*5290.00	90.1 AV			1.34 H	85	81.51	8.59
5	5361.10	67.1 PK	74.0	-6.9	1.34 H	85	58.26	8.84
6	5361.10	53.1 AV	54.0	-0.9	1.34 H	85	44.26	8.84
7	#10580.00	53.1 PK	74.0	-20.9	1.00 H	129	37.64	15.46
8	#10580.00	39.6 AV	54.0	-14.4	1.00 H	129	24.14	15.46
9	15870.00	61.2 PK	74.0	-12.8	1.00 H	8	40.09	21.11
10	15870.00	49.6 AV	54.0	-4.4	1.00 H	8	28.49	21.11

ANTENNA POLARITY & TEST DISTANCE: VERTICAL AT 3 M

NO.	FREQ. (MHz)	EMISSION LEVEL (dBuV/m)	LIMIT (dBuV/m)	MARGIN (dB)	ANTENNA HEIGHT (m)	TABLE ANGLE (Degree)	RAW VALUE (dBuV)	CORRECTION FACTOR (dB/m)
1	5150.00	62.5 PK	74.0	-11.5	1.10 V	335	54.27	8.23
2	5150.00	45.5 AV	54.0	-8.5	1.10 V	335	37.27	8.23
3	*5290.00	96.0 PK			1.10 V	335	87.41	8.59
4	*5290.00	86.7 AV			1.10 V	335	78.11	8.59
5	5361.10	61.3 PK	74.0	-12.7	1.10 V	335	52.46	8.84
6	5361.10	43.9 AV	54.0	-10.1	1.10 V	335	35.06	8.84
7	#10580.00	54.6 PK	74.0	-19.4	1.36 V	95	39.14	15.46
8	#10580.00	43.7 AV	54.0	-10.3	1.36 V	95	28.24	15.46
9	15870.00	63.2 PK	74.0	-10.8	1.07 V	338	42.09	21.11
10	15870.00	49.9 AV	54.0	-4.1	1.07 V	338	28.79	21.11

REMARKS:

1. Emission Level(dBuV/m) = Raw Value(dBuV) + Correction Factor(dB/m)
2. Correction Factor(dB/m) = Antenna Factor(dB/m) + Cable Factor(dB) – Pre-Amplifier Factor(dB)
3. The other emission levels were very low against the limit.
4. Margin value = Emission Level – Limit value
5. " * ": Fundamental frequency.
6. " # ": The radiated frequency is out of the restricted band.



A D T

CHANNEL	TX Channel 106	DETECTOR FUNCTION	Peak (PK)
FREQUENCY RANGE	1GHz ~ 40GHz		Average (AV)

ANTENNA POLARITY & TEST DISTANCE: HORIZONTAL AT 3 M

NO.	FREQ. (MHz)	EMISSION LEVEL (dBuV/m)	LIMIT (dBuV/m)	MARGIN (dB)	ANTENNA HEIGHT (m)	TABLE ANGLE (Degree)	RAW VALUE (dBuV)	CORRECTION FACTOR (dB/m)
1	5350.00	67.0 PK	74.0	-7.0	1.26 H	123	58.20	8.80
2	5350.00	52.4 AV	54.0	-1.6	1.26 H	123	43.60	8.80
3	#5470.00	70.3 PK	74.0	-3.7	1.26 H	123	61.08	9.22
4	#5470.00	52.5 AV	54.0	-1.5	1.26 H	123	43.28	9.22
5	*5530.00	99.7 PK			1.26 H	123	90.31	9.39
6	*5530.00	90.5 AV			1.26 H	123	81.11	9.39
7	11060.00	53.0 PK	74.0	-21.0	1.00 H	132	36.43	16.57
8	11060.00	39.7 AV	54.0	-14.3	1.00 H	132	23.13	16.57
9	#16590.00	61.6 PK	74.0	-12.4	1.00 H	28	38.19	23.41
10	#16590.00	49.7 AV	54.0	-4.3	1.00 H	28	26.29	23.41

ANTENNA POLARITY & TEST DISTANCE: VERTICAL AT 3 M

NO.	FREQ. (MHz)	EMISSION LEVEL (dBuV/m)	LIMIT (dBuV/m)	MARGIN (dB)	ANTENNA HEIGHT (m)	TABLE ANGLE (Degree)	RAW VALUE (dBuV)	CORRECTION FACTOR (dB/m)
1	5350.00	61.1 PK	74.0	-12.9	1.07 V	343	52.30	8.80
2	5350.00	44.0 AV	54.0	-10.0	1.07 V	343	35.20	8.80
3	#5470.00	62.1 PK	74.0	-11.9	1.07 V	343	52.88	9.22
4	#5470.00	45.2 AV	54.0	-8.8	1.07 V	343	35.98	9.22
5	*5530.00	96.4 PK			1.07 V	343	87.01	9.39
6	*5530.00	86.7 AV			1.07 V	343	77.31	9.39
7	11060.00	54.9 PK	74.0	-19.1	1.33 V	117	38.33	16.57
8	11060.00	43.6 AV	54.0	-10.4	1.33 V	117	27.03	16.57
9	#16590.00	63.6 PK	74.0	-10.4	1.04 V	341	40.19	23.41
10	#16590.00	50.4 AV	54.0	-3.6	1.04 V	341	26.99	23.41

REMARKS:

1. Emission Level(dBuV/m) = Raw Value(dBuV) + Correction Factor(dB/m)
2. Correction Factor(dB/m) = Antenna Factor(dB/m) + Cable Factor(dB) – Pre-Amplifier Factor(dB)
3. The other emission levels were very low against the limit.
4. Margin value = Emission Level – Limit value
5. " * ": Fundamental frequency.
6. " # ": The radiated frequency is out of the restricted band.

4.3 TRANSMIT POWER MEASUREMENT

4.3.1 LIMITS OF TRANSMIT POWER MEASUREMENT

Frequency Band	Limit
5.15 – 5.25GHz	The lesser of 50mW (17dBm) or 4dBm + 10logB
5.25 – 5.35GHz	The lesser of 250mW (24dBm) or 11dBm + 10logB
5.47 – 5.725GHz	The lesser of 250mW (24dBm) or 11dBm + 10logB
5.725 – 5.825GHz	The lesser of 1W (30dBm) or 17dBm + 10logB

Note: Where B is the 26dB emission bandwidth in MHz.

Per KDB 662911 D01 Multiple Transmitter Output Method of conducted output power measurement on IEEE 802.11 devices,

Array Gain = 0 dB (i.e., no array gain) for NANT ≤ 4;

Array Gain = 0 dB (i.e., no array gain) for channel widths ≥ 40 MHz for any NANT;

Array Gain = 5 log(NANT/NSS) dB or 3 dB, whichever is less for 20-MHz channel widths with NANT ≥ 5.

For power measurements on all other devices: Array Gain = 10 log(NANT/NSS) dB.



A D T

4.3.2 TEST INSTRUMENTS

FOR POWER OUTPUT MEASUREMENT

DESCRIPTION & MANUFACTURER	MODEL NO.	SERIAL NO.	CALIBRATED DATE	CALIBRATED UNTIL
Power meter Anritsu	ML2495A	1014008	Apr. 30, 2014	Apr. 29, 2015
Power sensor Anritsu	MA2411B	0917122	Apr. 30, 2014	Apr. 29, 2015

Note:

1. The calibration interval of the above test instruments is 12 months and the calibrations are traceable to NML/ROC and NIST/USA.
2. Tested date : May 22, 2014

FOR 26dB OCCUPIED BANDWIDTH

DESCRIPTION & MANUFACTURER	MODEL NO.	SERIAL NO.	CALIBRATED DATE	CALIBRATED UNTIL
SPECTRUM ANALYZER R&S	FSV 40	100964	July 15, 2013	July 14, 2014

Note:

1. The calibration interval of the above test instruments is 12 months and the calibrations are traceable to NML/ROC and NIST/USA.
2. Tested date : May 22, 2014

4.3.3 TEST PROCEDURE

FOR POWER OUTPUT MEASUREMENT

Method PM is used to perform output power measurement, trigger and gating function of wide band power meter is enabled to measure max output power of TX on burst. Duty factor is not added to measured value.

FOR 26dB OCCUPIED BANDWIDTH

1. Set RBW = approximately 1% of the emission bandwidth.
2. Set the VBW > RBW.
3. Detector = Peak.
4. Trace mode = max hold.
5. Measure the maximum width of the emission that is 26 dB down from the peak of the emission. Compare this with the RBW setting of the analyzer. Readjust RBW and repeat measurement as needed until the RBW/EBW ratio is approximately 1%.

4.3.4 DEVIATION FROM TEST STANDARD

No deviation

4.3.5 TEST SETUP

FOR POWER OUTPUT MEASUREMENT

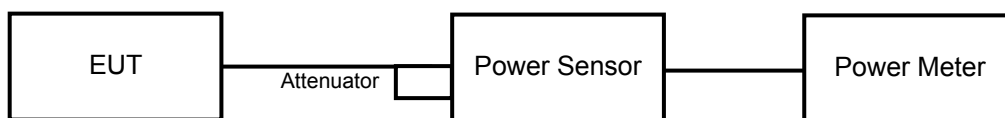

FOR 26dB OCCUPIED BANDWIDTH

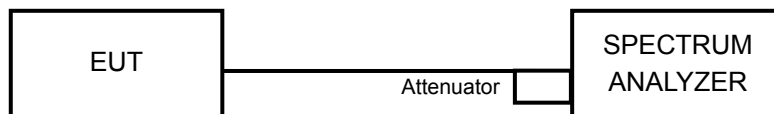

4.3.6 EUT OPERATING CONDITIONS

The software provided by client to enable the EUT under transmission condition continuously at specific channel frequencies individually.



4.3.7 TEST RESULTS

802.11a

CHAN.	CHAN. FREQ. (MHz)	AVERAGE POWER (dBm)		TOTAL POWER (mW)	TOTAL POWER (dBm)	POWER LIMIT (dBm)	PASS / FAIL
		CHAIN 0	CHAIN 1				
36	5180	11.41	11.92	29.396	14.68	16.96	PASS
40	5200	11.20	11.66	27.838	14.45	16.99	PASS
48	5240	11.35	11.81	28.817	14.60	16.95	PASS
52	5260	15.50	15.41	70.235	18.47	23.98	PASS
60	5300	15.13	15.20	65.697	18.18	24.00	PASS
64	5320	14.28	14.31	53.769	17.31	24.00	PASS
100	5500	14.31	15.37	61.412	17.88	23.97	PASS
116	5580	15.38	16.02	74.508	18.72	24.00	PASS
132	5660	15.11	15.39	67.028	18.26	24.00	PASS
140	5700	13.17	13.45	42.88	16.32	24.00	PASS

26dB OCCUPIED BANDWIDTH:

CHANNEL	CHANNEL FREQUENCY (MHz)	26dBc BANDWIDTH (MHz)	
		CHAIN 0	CHAIN 1
36	5180	19.91	19.81
40	5200	20.20	19.91
48	5240	20.05	19.73
52	5260	26.66	19.88
60	5300	25.73	22.11
64	5320	20.59	20.01
100	5500	19.97	19.85
116	5580	22.83	20.37
132	5660	31.95	19.96
140	5700	20.16	20.23

Note: For output power limitation is determined based on 26dBc bandwidth.



A D T

Power Limit = 4dBm + 10logB < UNII Band 1>			
Channel Number	Freq.(MHz)	Min. B(MHz)	Determined Conducted Limit (dBm)
36	5180	19.81	16.96 < 17
40	5200	19.91	16.99 < 17
48	5240	19.73	16.95 < 17
Power Limit = 11dBm + 10logB < UNII Band 2~3>			
Channel Number	Freq.(MHz)	Min. B(MHz)	Determined Conducted Limit (dBm)
52	5260	19.88	23.98 < 24
60	5300	22.11	24.44 > 24
64	5320	20.01	24.01 > 24
100	5500	19.85	23.97 < 24
116	5580	20.37	24.08 > 24
132	5660	19.96	24 = 24
140	5700	20.16	24.04 > 24



802.11ac (VHT20)

CHAN.	CHAN. FREQ. (MHz)	AVERAGE POWER (dBm)		TOTAL POWER (mW)	TOTAL POWER (dBm)	POWER LIMIT (dBm)	PASS / FAIL
		CHAIN 0	CHAIN 1				
36	5180	12.07	12.77	35.029	15.44	17	PASS
40	5200	13.45	13.77	45.954	16.62	17	PASS
48	5240	13.26	13.89	45.675	16.60	17	PASS
52	5260	15.23	15.60	69.651	18.43	24	PASS
60	5300	15.32	15.39	68.635	18.37	24	PASS
64	5320	13.27	13.51	43.671	16.40	24	PASS
100	5500	13.43	13.35	43.656	16.40	24	PASS
116	5580	15.45	16.12	76.001	18.81	24	PASS
132	5660	15.19	15.62	69.512	18.42	24	PASS
140	5700	11.51	11.83	29.399	14.68	24	PASS

26dB OCCUPIED BANDWIDTH:

CHANNEL	CHANNEL FREQUENCY (MHz)	26dBc BANDWIDTH (MHz)	
		CHAIN 0	CHAIN 1
36	5180	20.39	20.34
40	5200	20.49	20.33
48	5240	22.83	20.29
52	5260	27.34	20.40
60	5300	31.81	28.74
64	5320	20.74	20.39
100	5500	20.39	20.14
116	5580	29.20	23.39
132	5660	31.93	21.44
140	5700	20.41	20.30

Note: For output power limitation is determined based on 26dBc bandwidth.



A D T

Power Limit = 4dBm + 10logB < UNII Band 1>			
Channel Number	Freq.(MHz)	Min. B(MHz)	Determined Conducted Limit (dBm)
36	5180	20.34	17.08 > 17
40	5200	20.33	17.08 > 17
48	5240	20.29	17.07 > 17
Power Limit = 11dBm + 10logB < UNII Band 2~3>			
Channel Number	Freq.(MHz)	Min. B(MHz)	Determined Conducted Limit (dBm)
52	5260	20.40	24.09 > 24
60	5300	28.74	25.58 > 24
64	5320	20.39	24.09 > 24
100	5500	20.14	24.04 > 24
116	5580	23.39	24.69 > 24
132	5660	21.44	24.31 > 24
140	5700	20.30	24.07 > 24



A D T

802.11ac (VHT40)

CHAN.	CHAN. FREQ. (MHz)	AVERAGE POWER (dBm)		TOTAL POWER (mW)	TOTAL POWER (dBm)	POWER LIMIT (dBm)	PASS / FAIL
		CHAIN 0	CHAIN 1				
38	5190	7.01	7.95	11.26	10.52	17	PASS
46	5230	12.73	13.54	41.344	16.16	17	PASS
54	5270	14.67	14.90	60.212	17.80	24	PASS
62	5310	11.83	12.17	31.723	15.01	24	PASS
102	5510	9.91	9.88	19.522	12.91	24	PASS
110	5550	15.11	15.46	67.59	18.30	24	PASS
134	5670	13.10	13.13	40.976	16.13	24	PASS

26dB OCCUPIED BANDWIDTH:

CHANNEL	CHANNEL FREQUENCY (MHz)	26dBc BANDWIDTH (MHz)	
		CHAIN 0	CHAIN 1
38	5190	41.75	41.56
46	5230	42.47	42.24
54	5270	42.32	48.43
62	5310	50.88	41.56
102	5510	41.80	41.49
110	5550	55.48	58.62
134	5670	41.97	41.72

Note: For output power limitation is determined based on 26dBc bandwidth.



A D T

Power Limit = 4dBm + 10logB < UNII Band 1>			
Channel Number	Freq.(MHz)	Min. B(MHz)	Determined Conducted Limit (dBm)
38	5190	41.56	20.18 > 17
46	5230	42.24	20.25 > 17
Power Limit = 11dBm + 10logB < UNII Band 2~3>			
Channel Number	Freq.(MHz)	Min. B(MHz)	Determined Conducted Limit (dBm)
54	5270	42.32	27.26 > 24
62	5310	41.56	27.18 > 24
102	5510	41.49	27.17 > 24
110	5550	55.48	28.44 > 24
134	5670	41.72	27.2 > 24



A D T

802.11ac (VHT80)

CHAN.	CHAN. FREQ. (MHz)	AVERAGE POWER (dBm)		TOTAL POWER (mW)	TOTAL POWER (dBm)	POWER LIMIT (dBm)	PASS / FAIL
		CHAIN 0	CHAIN 1				
42	5210	7.68	8.81	13.464	11.29	17	PASS
58	5290	8.71	9.78	16.936	12.29	24	PASS
106	5530	8.72	9.39	16.137	12.08	24	PASS

26dB OCCUPIED BANDWIDTH:

CHANNEL	CHANNEL FREQUENCY (MHz)	26dBc BANDWIDTH (MHz)	
		CHAIN 0	CHAIN 1
42	5210	82.12	81.99
58	5290	82.06	81.95
106	5530	82.17	81.92

Note: For output power limitation is determined based on 26dBc bandwidth.

Power Limit = 4dBm + 10logB < UNII Band 1>			
Channel Number	Freq.(MHz)	Min. B(MHz)	Determined Conducted Limit (dBm)
42	5210	81.99	23.13 > 17
Power Limit = 11dBm + 10logB < UNII Band 2~3>			
Channel Number	Freq.(MHz)	Min. B(MHz)	Determined Conducted Limit (dBm)
58	5290	81.95	30.13 > 24
106	5530	81.92	30.13 > 24

4.4 PEAK POWER SPECTRAL DENSITY MEASUREMENT

4.4.1 LIMITS OF PEAK POWER SPECTRAL DENSITY MEASUREMENT

FREQUENCY BAND	LIMIT
5.15 ~ 5.25GHz	4dBm
5.25 ~ 5.35GHz	11dBm
5.47 – 5.725GHz	11dBm
5.725 ~ 5.825GHz	17dBm

4.4.2 TEST INSTRUMENTS

DESCRIPTION & MANUFACTURER	MODEL NO.	SERIAL NO.	CALIBRATED DATE	CALIBRATED UNTIL
SPECTRUM ANALYZER R&S	FSV 40	100964	July 15, 2013	July 14, 2014

Note:

1. The calibration interval of the above test instruments is 12 months and the calibrations are traceable to NML/ROC and NIST/USA.
2. Tested date : May 22, 2014

4.4.3 TEST PROCEDURES

Using method SA-1

1. Set span to encompass the entire emission bandwidth (EBW) of the signal.
2. Set RBW = 1 MHz, Set VBW \geq 3 MHz, Detector = RMS
3. Sweep time = auto, trigger set to “free run”.
4. Trace average at least 100 traces in power averaging mode.
5. Record the max value

4.4.4 DEVIATION FROM TEST STANDARD

No deviation

4.4.5 TEST SETUP



4.4.6 EUT OPERATING CONDITIONS

Same as 4.3.6



A D T

4.4.7 TEST RESULTS

802.11a

CHANNEL	CHANNEL FREQUENCY (MHz)	PSD (dBm)		TOTAL POWER DENSITY (dBm)	MAX. LIMIT (dBm)	PASS/FAIL
		CHAIN 0	CHAIN 1			
36	5180	-2.33	-3.44	0.16	1.83	PASS
40	5200	-3.94	-1.44	0.50	1.83	PASS
48	5240	-2.63	-1.33	1.08	1.83	PASS
52	5260	1.09	2.37	4.79	8.83	PASS
60	5300	0.91	1.47	4.21	8.83	PASS
64	5320	-0.08	1.19	3.61	8.83	PASS
100	5500	0.03	-0.34	2.86	8.83	PASS
116	5580	3.72	1.80	5.88	8.83	PASS
132	5660	2.34	0.42	4.50	8.83	PASS
140	5700	-0.53	-0.90	2.30	8.83	PASS

NOTE: 1. Method a) of power density measurement of KDB 662911 is using for calculating total power density. Total power density is summing entire spectra across corresponding frequency bins on the various outputs by computer.

2. **5150~5250MHz:** Directional gain = $5.16\text{dBi} + 10\log(2) = 8.17\text{dBi} > 6\text{dBi}$, so the power density limit shall be reduced to $4 - (8.17 - 6) = 1.83\text{dBm}$.

5250~5350MHz, 5470~5725MHz: Directional gain = $5.16\text{dBi} + 10\log(2) = 8.17\text{dBi} > 6\text{dBi}$, so the power density limit shall be reduced to $11 - (8.17 - 6) = 8.83\text{dBm}$.



802.11ac (VHT20)

CHANNEL	CHANNEL FREQUENCY (MHz)	PSD (dBm)		TOTAL POWER DENSITY (dBm)	MAX. LIMIT (dBm)	PASS/FAIL
		CHAIN 0	CHAIN 1			
36	5180	-2.85	-1.93	0.64	4	PASS
40	5200	-1.58	-0.42	2.05	4	PASS
48	5240	-1.06	-0.43	2.28	4	PASS
52	5260	0.75	1.48	4.14	11	PASS
60	5300	0.93	1.84	4.42	11	PASS
64	5320	-0.90	-0.21	2.47	11	PASS
100	5500	-1.14	-0.90	1.99	11	PASS
116	5580	1.49	1.50	4.51	11	PASS
132	5660	0.89	0.98	3.95	11	PASS
140	5700	-1.96	-2.40	0.84	11	PASS

NOTE: 1. Method a) of power density measurement of KDB 662911 is using for calculating total power density. Total power density is summing entire spectra across corresponding frequency bins on the various outputs by computer.

802.11ac (VHT40)

CHANNEL	CHANNEL FREQUENCY (MHz)	PSD (dBm)		TOTAL POWER DENSITY (dBm)	MAX. LIMIT (dBm)	PASS/FAIL
		CHAIN 0	CHAIN 1			
38	5190	-9.50	-8.71	-6.08	4	PASS
46	5230	-3.56	-4.00	-0.76	4	PASS
54	5270	-4.17	-2.22	-0.08	11	PASS
62	5310	-6.66	-4.55	-2.47	11	PASS
102	5510	-8.46	-8.15	-5.29	11	PASS
110	5550	-1.43	-2.44	1.10	11	PASS
134	5670	-5.47	-3.60	-1.42	11	PASS

NOTE: 1. Method a) of power density measurement of KDB 662911 is using for calculating total power density. Total power density is summing entire spectra across corresponding frequency bins on the various outputs by computer.



A D T

802.11ac (VHT80)

CHANNEL	CHANNEL FREQUENCY (MHz)	PSD (dBm)		TOTAL POWER DENSITY (dBm)	MAX. LIMIT (dBm)	PASS/FAIL
		CHAIN 0	CHAIN 1			
42	5210	-12.66	-12.20	-9.41	4	PASS
58	5290	-12.19	-10.50	-8.25	11	PASS
106	5530	-13.34	-11.67	-9.42	11	PASS

NOTE: 1. Method a) of power density measurement of KDB 662911 is using for calculating total power density. Total power density is summing entire spectra across corresponding frequency bins on the various outputs by computer.



A D T

SPECTRUM PLOT OF WORST VALUE

802.11a / Chain(0) : CH116

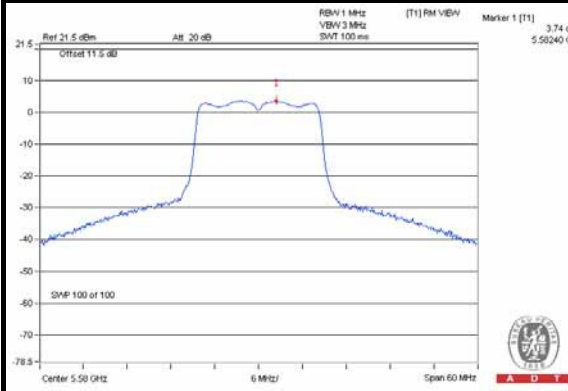

802.11ac (VHT20) / Chain(1) : CH116

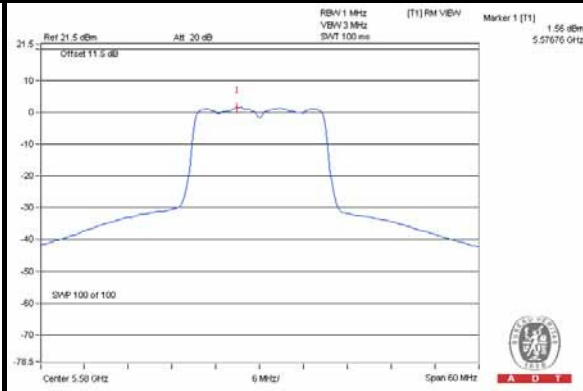

802.11ac (VHT40) / Chain(0) : CH110

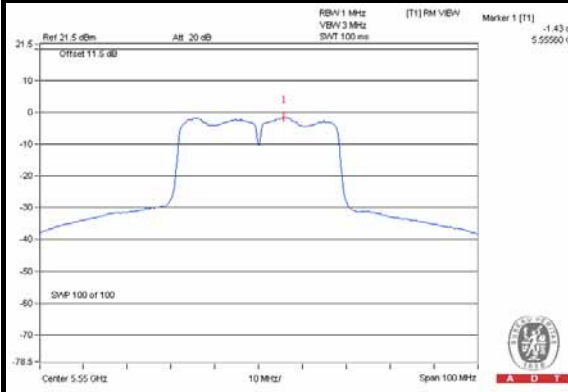

802.11ac (VHT80) / Chain(1) : CH58

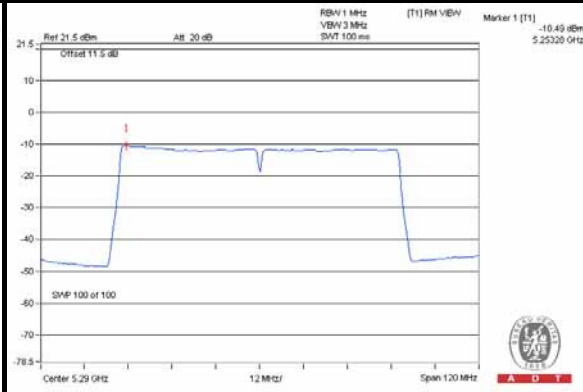

4.5 PEAK POWER EXCURSION MEASUREMENT

4.5.1 LIMITS OF PEAK POWER EXCURSION MEASUREMENT

Shall not exceed 13 dB

4.5.2 TEST INSTRUMENTS

DESCRIPTION & MANUFACTURER	MODEL NO.	SERIAL NO.	CALIBRATED DATE	CALIBRATED UNTIL
SPECTRUM ANALYZER R&S	FSV 40	100964	July 15, 2013	July 14, 2014

Note:

1. The calibration interval of the above test instruments is 12 months and the calibrations are traceable to NML/ROC and NIST/USA.
2. Tested date : May 22, 2014

4.5.3 TEST PROCEDURE

1. Set RBW = 1 MHz, VBW \geq 3 MHz, Detector = peak.
2. Trace mode = max-hold. Allow the sweeps to continue until the trace stabilizes.
3. Use the peak search function to find the peak of the spectrum.
4. Measure the PPSD.
5. Compute the ratio of the maximum of the peak-max-hold spectrum to the PPSD.

4.5.4 DEVIATION FROM TEST STANDARD

No deviation

4.5.5 TEST SETUP

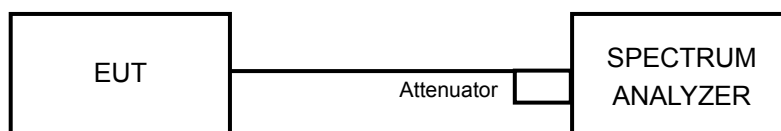

4.5.6 EUT OPERATING CONDITIONS

The software provided by client to enable the EUT under transmission condition continuously at specific channel frequencies individually.



A D T

4.5.7 TEST RESULTS

MODULATION MODE	MODULATION TYPE	CHANNEL FREQUENCY (MHz)	PEAK VALUE (dBm)	PPSD (dBm)	PEAK EXCURSION (dB)	LIMIT (dB)	PASS/ FAIL
802.11a	BPSK	5700	9.83	-0.53	10.36	13	PASS
	QPSK		9.7	-1.53	11.23	13	PASS
	16QAM		9.5	-1.11	10.61	13	PASS
	64QAM		10.67	-1.29	11.96	13	PASS
802.11ac (VHT20)	BPSK	5700	7.57	-1.96	9.53	13	PASS
	QPSK		7.87	-3.75	11.62	13	PASS
	16QAM		7.69	-3.5	11.19	13	PASS
	64QAM		8	-3.24	11.24	13	PASS
	256QAM		7.86	-3.61	11.47	13	PASS
802.11ac (VHT40)	BPSK	5670	6.1	-4.5	10.6	13	PASS
	QPSK		6.23	-4.78	11.01	13	PASS
	16QAM		6.14	-4.72	10.86	13	PASS
	64QAM		6.96	-4.61	11.57	13	PASS
	256QAM		7.05	-4.81	11.86	13	PASS
802.11ac (VHT80)	BPSK	5530	-2.2	-13.21	11.01	13	PASS
	QPSK		-2.12	-13.44	11.32	13	PASS
	16QAM		-1.29	-13.44	12.15	13	PASS
	64QAM		-1.04	-13.15	12.11	13	PASS
	256QAM		-2.06	-13.7	11.64	13	PASS



A D T

SPECTRUM PLOT OF WORST VALUE

802.11a / 64QAM

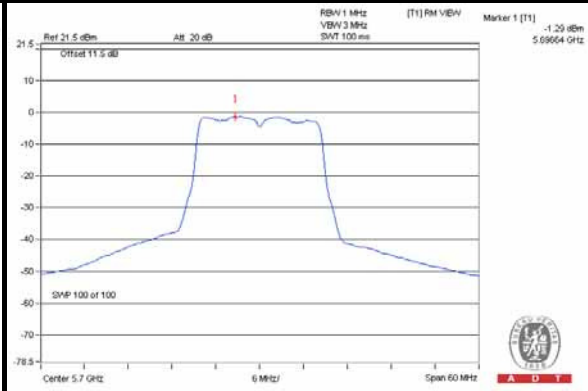
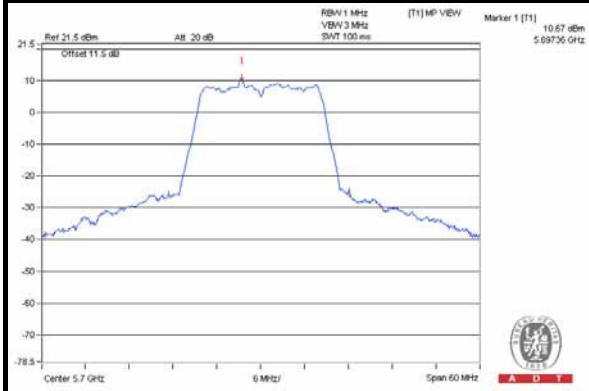

802.11ac (VHT20) / QPSK

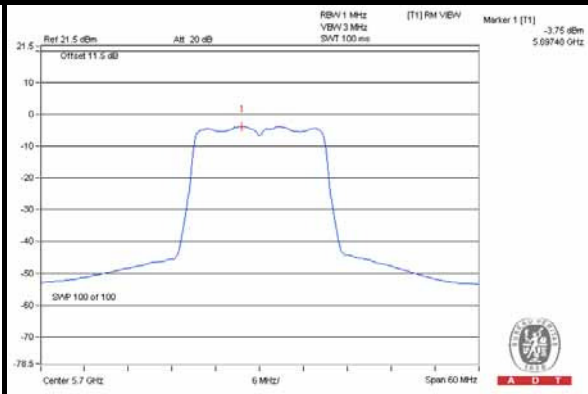
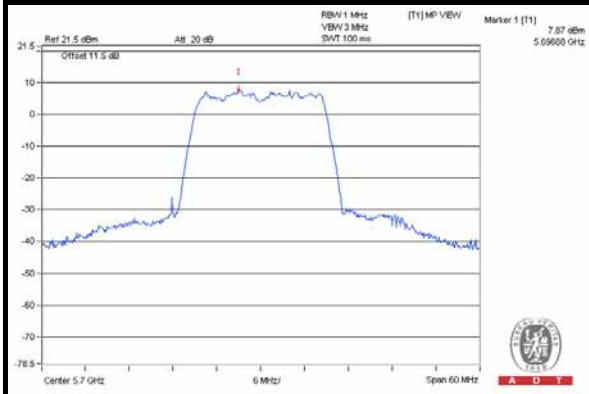



A D T

802.11ac (VHT40) / 256QAM

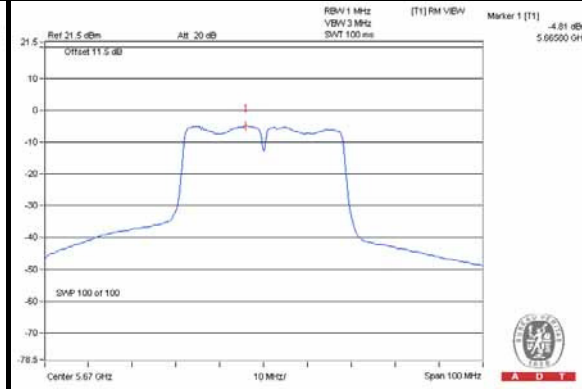
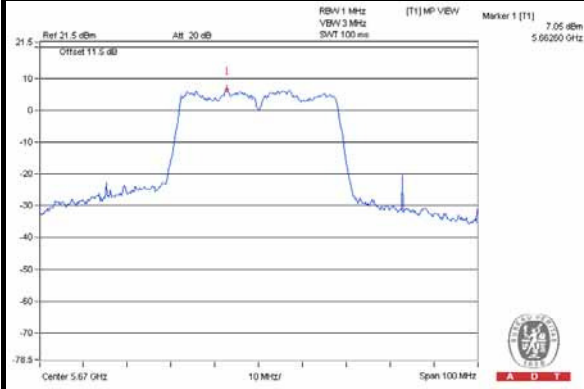

802.11ac (VHT80) / 16QAM

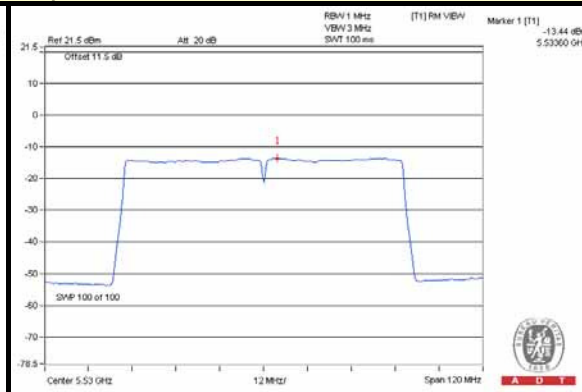
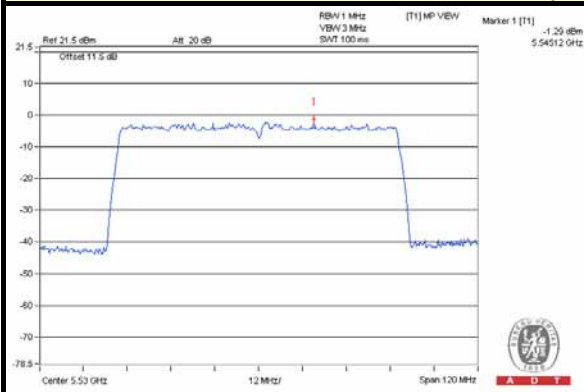



A D T

4.6 FREQUENCY STABILITY

4.6.1 LIMITS OF FREQUENCY STABILITY MEASUREMENT

The frequency of the carrier signal shall be maintained within band of operation

4.6.2 TEST INSTRUMENTS

DESCRIPTION & MANUFACTURER	MODEL NO.	SERIAL NO.	CALIBRATED DATE	CALIBRATED UNTIL
SPECTRUM ANALYZER R&S	FSV 40	100964	July 15, 2013	July 14, 2014
Temperature Humidity Chamber GIANTFORCE &	GTH-150-40-SP -AR	MAA0812-008	Jan. 13, 2014	Jan. 12, 2015

Note:

1. The calibration interval of the above test instruments is 12 months and the calibrations are traceable to NML/ROC and NIST/USA.
2. Tested date : May 22, 2014

4.6.3 TEST PROCEDURE

1. The EUT was placed inside the environmental test chamber and powered by nominal DC voltage.
2. Turn the EUT on and couple its output to a spectrum analyzer.
3. Turn the EUT off and set the chamber to the highest temperature specified.
4. Allow sufficient time (approximately 30 min) for the temperature of the chamber to stabilize, turn the EUT on and measure the operating frequency after 2, 5, and 10 minutes.
5. Repeat step 2 and 3 with the temperature chamber set to the lowest temperature.
6. The test chamber was allowed to stabilize at +20 degree C for a minimum of 30 minutes. The supply voltage was then adjusted on the EUT from 85% to 115% and the frequency record.

4.6.4 DEVIATION FROM TEST STANDARD

No deviation

4.6.5 TEST SETUP

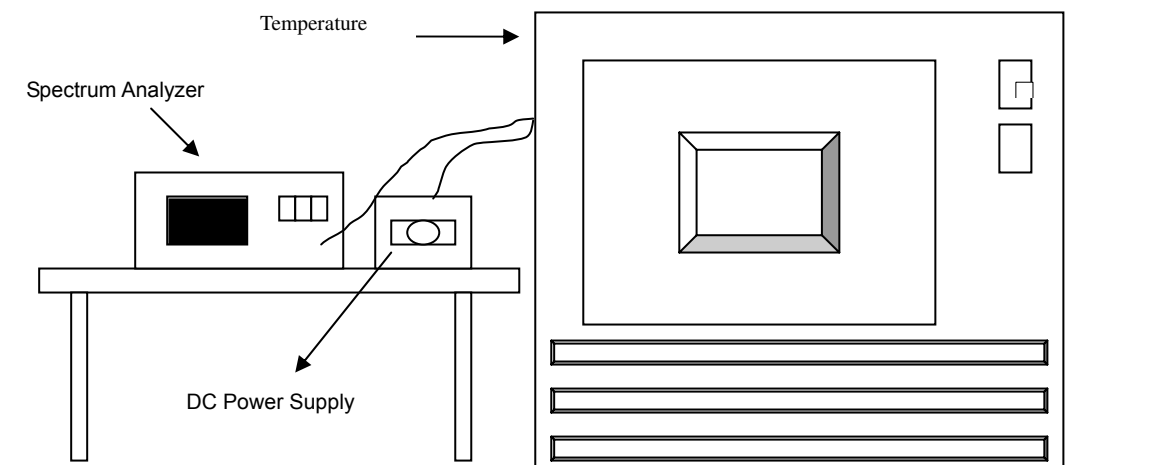

4.6.6 EUT OPERATING CONDITION

Set the EUT transmit at un-modulation mode to test frequency stability.



A D T

4.6.7 TEST RESULTS

FREQUENCY STABILITY VERSUS TEMP.									
OPERATING FREQUENCY: 5320MHz									
TEMP. (°C)	POWER SUPPLY (Vdc)	0 MINUTE		2 MINUTE		5 MINUTE		10 MINUTE	
		Measured Frequency	Frequency Drift	Measured Frequency	Frequency Drift	Measured Frequency	Frequency Drift	Measured Frequency	Frequency Drift
		(MHz)	%	(MHz)	%	(MHz)	%	(MHz)	%
50	3.3	5320.011	0.00021	5320.0157	0.00030	5320.0118	0.00022	5320.0126	0.00024
40	3.3	5320.0238	0.00045	5320.0246	0.00046	5320.0281	0.00053	5320.0262	0.00049
30	3.3	5320.0235	0.00044	5320.0277	0.00052	5320.0249	0.00047	5320.0263	0.00049
20	3.3	5319.9935	-0.00012	5319.9935	-0.00012	5319.9923	-0.00014	5319.9913	-0.00016
10	3.3	5319.9818	-0.00034	5319.9833	-0.00031	5319.9812	-0.00035	5319.9839	-0.00030
0	3.3	5319.98	-0.00038	5319.9764	-0.00044	5319.9792	-0.00039	5319.9783	-0.00041
-10	3.3	5320.0149	0.00028	5320.0176	0.00033	5320.0164	0.00031	5320.017	0.00032
-20	3.3	5319.991	-0.00017	5319.9906	-0.00018	5319.994	-0.00011	5319.9954	-0.00009
-30	3.3	5319.9947	-0.00010	5319.9966	-0.00006	5319.9985	-0.00003	5319.9949	-0.00010

FREQUENCY STABILITY VERSUS VOLTAGE									
OPERATING FREQUENCY: 5320MHz									
TEMP. (°C)	POWER SUPPLY (Vdc)	0 MINUTE		2 MINUTE		5 MINUTE		10 MINUTE	
		Measured Frequency	Frequency Drift	Measured Frequency	Frequency Drift	Measured Frequency	Frequency Drift	Measured Frequency	Frequency Drift
		(MHz)	%	(MHz)	%	(MHz)	%	(MHz)	%
20	3.795	5319.9926	-0.00014	5319.9925	-0.00014	5319.9925	-0.00014	5319.9914	-0.00016
	3.3	5319.9935	-0.00012	5319.9935	-0.00012	5319.9923	-0.00014	5319.9913	-0.00016
	2.805	5319.9934	-0.00012	5319.9938	-0.00012	5319.9925	-0.00014	5319.9918	-0.00015

5. PHOTOGRAPHS OF THE TEST CONFIGURATION

Please refer to the attached file (Test Setup Photo).



A D T

6. INFORMATION ON THE TESTING LABORATORIES

We, Bureau Veritas Consumer Products Services (H.K.) Ltd., Taoyuan Branch, were founded in 1988 to provide our best service in EMC, Radio, Telecom and Safety consultation. Our laboratories are accredited and approved according to ISO/IEC 17025.

If you have any comments, please feel free to contact us at the following:

Linko EMC/RF Lab:

Tel: 886-2-26052180

Fax: 886-2-26052943

Hsin Chu EMC/RF Lab:

Tel: 886-3-5935343

Fax: 886-3-5935342

Hwa Ya EMC/RF/Safety/Telecom Lab:

Tel: 886-3-3183232

Fax: 886-3-3270892

Email: service.adt@tw.bureauveritas.com

Web Site: www.bureauveritas-adt.com

The address and road map of all our labs can be found in our web site also.



A D T

7. APPENDIX A - MODIFICATIONS RECORDERS FOR ENGINEERING CHANGES TO THE EUT BY THE LAB

No modifications were made to the EUT by the lab during the test.

--- END ---