



FCC TEST REPORT (15.407)

REPORT NO.: RF150508C06A-7

MODEL: WT2

FCC ID: A4R-WT2

RECEIVED: May 08, 2015

TESTED: Jun. 10, 2015 ~ Jun. 18, 2015

ISSUED: Aug. 05, 2016

APPLICANT: Google Inc.

ADDRESS: 1600 Amphitheatre Parkway Mountain View
California United States 94043

ISSUED BY: Bureau Veritas Consumer Products Services
(H.K.) Ltd., Taoyuan Branch

LAB ADDRESS: No. 47-2, 14th Ling, Chia Pau Vil., Lin Kou Dist.,
New Taipei City, Taiwan (R.O.C)

TEST LOCATION: No. 19, Hwa Ya 2nd Rd, Wen Hwa Vil., Kwei
Shan Dist., Taoyuan City 33383, Taiwan (R.O.C.)

This report should not be used by the client to claim product certification, approval, or endorsement by TAF or any government agencies.



This report is for your exclusive use. Any copying or replication of this report to or for any other person or entity, or use of our name or trademark, is permitted only with our prior written permission. This report sets forth our findings solely with respect to the test samples identified herein. The results set forth in this report are not indicative or representative of the quality or characteristics of the lot from which a test sample was taken or any similar or identical product unless specifically and expressly noted. Our report includes all of the tests requested by you and the results thereof based upon the information that you provided to us. You have 60 days from date of issuance of this report to notify us of any material error or omission caused by our negligence, provided, however, that such notice shall be in writing and shall specifically address the issue you wish to raise. A failure to raise such issue within the prescribed time shall constitute your unqualified acceptance of the completeness of this report, the tests conducted and the correctness of the report contents. Unless specific mention, the uncertainty of measurement has been explicitly taken into account to declare the compliance or non-compliance to the specification.

TABLE OF CONTENTS

Preface	4
RELEASE CONTROL RECORD	5
1. CERTIFICATION.....	6
2. SUMMARY OF TEST RESULTS	7
2.1 MEASUREMENT UNCERTAINTY.....	7
3. GENERAL INFORMATION	8
3.1 GENERAL DESCRIPTION OF EUT	8
3.2 DESCRIPTION OF TEST MODES	10
3.2.1 TEST MODE APPLICABILITY AND TESTED CHANNEL DETAIL	12
3.3 DESCRIPTION OF SUPPORT UNITS	14
3.3.1 CONFIGURATION OF SYSTEM UNDER TEST	14
3.4 DUTY CYCLE TEST SIGNAL	15
3.5 GENERAL DESCRIPTION OF APPLIED STANDARDS	20
4. TEST TYPES AND RESULTS	21
4.1 RADIATED EMISSION AND BANDEDGE MEASUREMENT	21
4.1.1 LIMITS OF RADIATED EMISSION AND BANDEDGE MEASUREMENT	21
4.1.2 LIMITS OF UNWANTED EMISSION OUT OF THE RESTRICTED BANDS	21
4.1.3 TEST INSTRUMENTS	22
4.1.4 TEST PROCEDURES	23
4.1.5 DEVIATION FROM TEST STANDARD	23
4.1.6 TEST SETUP	24
4.1.7 EUT OPERATING CONDITIONS	24
4.1.8 TEST RESULTS.....	25
4.2 CONDUCTED EMISSION MEASUREMENT	63
4.2.1 LIMITS OF CONDUCTED EMISSION MEASUREMENT	63
4.2.2 TEST INSTRUMENTS.....	63
4.2.3 TEST PROCEDURES	64
4.2.4 DEVIATION FROM TEST STANDARD	64
4.2.5 TEST SETUP	65
4.2.6 EUT OPERATING CONDITIONS	65
4.2.7 TEST RESULTS.....	66
4.3 TRANSMIT POWER MEASUREMENT	68
4.3.1 LIMITS OF TRANSMIT POWER MEASUREMENT	68
4.3.2 TEST SETUP	68
4.3.3 TEST INSTRUMENTS.....	68
4.3.4 TEST PROCEDURE	69
4.3.5 DEVIATION FROM TEST STANDARD	69
4.3.6 EUT OPERATING CONDITIONS	69
4.3.7 TEST RESULTS.....	70
4.4 PEAK POWER SPECTRAL DENSITY MEASUREMENT	71
4.4.1 LIMITS OF PEAK POWER SPECTRAL DENSITY MEASUREMENT	71
4.4.2 TEST SETUP	71
4.4.3 TEST INSTRUMENTS.....	71
4.4.4 TEST PROCEDURES	71
4.4.5 DEVIATION FROM TEST STANDARD	72
4.4.6 EUT OPERATING CONDITIONS	72
4.4.7 TEST RESULTS.....	73
4.5 FREQUENCY STABILITY	77
4.5.1 LIMITS OF FREQUENCY STABILITY MEASUREMENT	77
4.5.2 TEST SETUP	77
4.5.3 TEST INSTRUMENTS.....	77
4.5.4 TEST PROCEDURE	78



4.5.5	DEVIATION FROM TEST STANDARD	78
4.5.6	EUT OPERATING CONDITION.....	78
4.5.7	TEST RESULTS.....	79
4.6	6dB BANDWIDTH MEASUREMENT	80
4.6.1	LIMITS OF 6dB BANDWIDTH MEASUREMENT	80
4.6.2	TEST SETUP	80
4.6.3	TEST INSTRUMENTS	80
4.6.4	TEST PROCEDURE	80
4.6.5	DEVIATION FROM TEST STANDARD	80
4.6.6	EUT OPERATING CONDITIONS	80
4.6.7	TEST RESULTS.....	81
5.	PHOTOGRAPHS OF THE TEST CONFIGURATION.....	83
6.	INFORMATION ON THE TESTING LABORATORIES	84
7.	APPENDIX A - MODIFICATIONS RECORDERS FOR ENGINEERING CHANGES TO THE EUT BY THE LAB	85



Preface

To whom it may concern,

We hereby declare that the integrated module-end product (FCC ID: A4R-WT2) is identical to the integrated module-end product (FCC ID: A4R-WT1) in the WLAN layout of the circuit, components and transmit power levels. The difference is only to add LTE function into the integrated module-end product and change the model name from WT1 to WT2.

Based on the similarity between both modules, we hereby request to leverage the all test data of FCC ID: A4R-WT1 described as below to demonstrate the compliance of FCC ID: A4R-WT2 for part 15E.

The list of reference details (Re-use the test data from the original integrated module-end product):

Equipment Class	Reference FCC ID	Reference to the test sections from FCC test report RF150508C06-7	
NII	A4R-WT1	4.1	Radiated Emission and Bandedge Measurement
		4.2	Conducted Emission Measurement
		4.3	Transmit Power Measurement
		4.4	Peak Power Spectral Density Measurement
		4.5	Frequency Stability
		4.6	6dB Bandwidth Measurement



RELEASE CONTROL RECORD

ISSUE NO.	REASON FOR CHANGE	DATE ISSUED
RF150508C06A-7	Original release	Aug. 05, 2016



1. CERTIFICATION

PRODUCT NAME/DESCRIPTION: Connectivity Bridge
MODEL: WT2
BRAND: Google
APPLICANT: Google Inc.
TESTED: Jun. 10, 2015 ~ Jun. 18, 2015
TEST SAMPLE: Identical Prototype
STANDARDS: **FCC Part 15, Subpart E (Section 15.407)**
ANSI C63.10-2009

The above equipment (model: WT2) has been tested by **Bureau Veritas Consumer Products Services (H.K.) Ltd., Taoyuan Branch**, and found compliance with the requirement of the above standards. The test record, data evaluation & Equipment Under Test (EUT) configurations represented herein are true and accurate accounts of the measurements of the sample's EMC characteristics under the conditions specified in this report.

PREPARED BY : Evonne Liu , **DATE :** Aug. 05, 2016
Evonne Liu / Specialist

APPROVED BY : Stanley Wu , **DATE :** Aug. 05, 2016
Stanley Wu / Assistant Manager

2. SUMMARY OF TEST RESULTS

The EUT has been tested according to the following specifications:

APPLIED STANDARD: FCC PART 15, SUBPART E (SECTION 15.407)			
STANDARD SECTION	TEST TYPE	RESULT	REMARK
15.407(b)(6)	AC Power Conducted Emission	PASS	Meet the requirement of limit. Minimum passing margin is -18.06dB at 0.51754MHz.
15.407(b/1/2/3) (b)(6)	Radiated Emissions	PASS	Meet the requirement of limit. Minimum passing margin is -1.08dB at 5714MHz.
15.407(a/1/2/3)	Max Average Transmit Power	PASS	Meet the requirement of limit.
15.407(a/1/2/3)	Peak Power Spectral Density	PASS	Meet the requirement of limit.
15.407(e)	6dB bandwidth	PASS	Meet the requirement of limit. (U-NII-3 Band only)
15.407(g)	Frequency Stability	PASS	Meet the requirement of limit.
15.203	Antenna Requirement	PASS	No antenna connector is used.

NOTE:

- Only the test item for conducted and radiated emission had been tested for this addendum and the 5260 ~ 5320MHz and 5500 ~ 5700MHz conducted data is referring to module report (Report No.: RF140407E07-1).

2.1 MEASUREMENT UNCERTAINTY

Where relevant, the following measurement uncertainty levels have been estimated for tests performed on the EUT as specified in CISPR 16-4-2:

MEASUREMENT	FREQUENCY	UNCERTAINTY
Conducted emissions	9kHz~30MHz	2.44 dB
Radiated emissions	9kHz ~ 30MHz	2.14 dB
	30MHz ~ 200MHz	2.93 dB
	200MHz ~ 1000MHz	2.95 dB
	1GHz ~ 18GHz	2.26 dB
	18GHz ~ 40GHz	1.94 dB

This uncertainty represents an expanded uncertainty expressed at approximately the 95% confidence level using a coverage factor of $k = 2$.

3. GENERAL INFORMATION

3.1 GENERAL DESCRIPTION OF EUT

PRODUCT NAME/DESCRIPTION	Connectivity Bridge
MODEL	WT2
POWER SUPPLY	5.0Vdc (adapter)
MODULATION TYPE	256QAM, 64QAM, 16QAM, QPSK, BPSK
MODULATION TECHNOLOGY	OFDM
TRANSFER RATE	802.11a: 54.0/ 48.0/ 36.0/ 24.0/ 18.0/ 12.0/ 9.0/ 6.0Mbps 802.11n: up to MCS7 802.11ac: up to V9
OPERATING FREQUENCY	5180 ~ 5240MHz, 5260 ~ 5320MHz, 5500 ~ 5700MHz, 5745 ~ 5825MHz
NUMBER OF CHANNEL	5180 ~ 5240MHz: 4 for 802.11a, 802.11n (20MHz) 2 for 802.11n (40MHz) 1 for 802.11ac (80MHz) 5260 ~ 5320MHz: 4 for 802.11a, 802.11n (20MHz) 2 for 802.11n (40MHz) 1 for 802.11ac (80MHz) 5500 ~ 5700MHz: 11 for 802.11a, 802.11n (20MHz) 5 for 802.11n (40MHz) 2 for 802.11ac (80MHz) 5745 ~ 5825MHz: 5 for 802.11a, 802.11n (20MHz) 2 for 802.11n (40MHz) 1 for 802.11ac (80MHz)
OUTPUT POWER	45.60mW for 5180 ~ 5240MHz 75.16mW for 5745 ~ 5825MHz
ANTENNA TYPE	FPCB antenna with 2.51dBi gain (5180 ~ 5240MHz) FPCB antenna with 1.79dBi gain (5745 ~ 5825MHz)
ANTENNA CONNECTOR	NA
DATA CABLE	Refer to Note as below
I/O PORTS	Refer to user's manual
ACCESSORY DEVICES	Refer to Note as below

NOTE:

1. The EUT contains following accessory devices.

ITEM	BRAND	MODEL	SPECIFICATION
Adapter	TPT	MII050200	I/P: 100-240Vac, 50-60Hz, 0.3A O/P: 5Vdc, 2A
WWAN Module	Telit	LE910-NAG	--
WiFi Module	AzureWave	AW-CM389NF	--

2. The EUT provides 1 completed transmitter and 1 receiver.

MODULATION MODE	TX FUNCTION
802.11a	1TX
802.11n (20MHz)	1TX
802.11n (40MHz)	1TX
802.11ac (80MHz)	1TX

3. The above EUT information is declared by the manufacturer and for more detailed features description, please refer to the manufacturer's specifications or User's Manual.

3.2 DESCRIPTION OF TEST MODES

WLAN 5180 ~ 5240MHz

4 channels are provided for 802.11a, 802.11n (20MHz):

CHANNEL	FREQUENCY	CHANNEL	FREQUENCY
36	5180 MHz	44	5220 MHz
40	5200 MHz	48	5240 MHz

2 channels are provided for 802.11n (40MHz):

CHANNEL	FREQUENCY	CHANNEL	FREQUENCY
38	5190 MHz	46	5230 MHz

1 channel is provided for 802.11ac (80MHz):

CHANNEL	FREQUENCY
42	5210 MHz

FOR 5260 ~ 5320MHz

4 channels are provided for 802.11a, 802.11n (20MHz):

CHANNEL	FREQUENCY	CHANNEL	FREQUENCY
52	5260 MHz	60	5300 MHz
56	5280 MHz	64	5320 MHz

2 channels are provided for 802.11n (40MHz):

CHANNEL	FREQUENCY	CHANNEL	FREQUENCY
54	5270 MHz	62	5310 MHz

1 channel is provided for 802.11ac (80MHz):

CHANNEL	FREQUENCY
58	5290MHz

WLAN 5500 ~ 5700MHz

11 channels are provided for 802.11a, 802.11n (20MHz):

CHANNEL	FREQUENCY	CHANNEL	FREQUENCY
100	5500MHz	124	5620MHz
104	5520MHz	128	5640MHz
108	5540MHz	132	5660MHz
112	5560MHz	136	5680MHz
116	5580MHz	140	5700MHz
120	5600MHz		

5 channels are provided for 802.11n (40MHz):

CHANNEL	FREQUENCY	CHANNEL	FREQUENCY
102	5510MHz	126	5630MHz
110	5550MHz	134	5670MHz
118	5590MHz		

2 channel is provided for 802.11ac (80MHz):

CHANNEL	FREQUENCY
106	5530MHz

FOR 5.0GHz (5745 ~ 5825MHz):

5 channels are provided for 802.11a, 802.11n (20MHz):

CHANNEL	FREQUENCY	CHANNEL	FREQUENCY
149	5745MHz	161	5805MHz
153	5765MHz	165	5825MHz
157	5785MHz		

2 channels are provided for 802.11n (40MHz):

CHANNEL	FREQUENCY	CHANNEL	FREQUENCY
151	5755MHz	159	5795MHz

1 channel is provided for 802.11ac (80MHz):

CHANNEL	FREQUENCY
155	5775MHz

3.2.1 TEST MODE APPLICABILITY AND TESTED CHANNEL DETAIL

EUT CONFIGURE MODE	APPLICABLE TO				DESCRIPTION
	RE \geq 1G	RE $<$ 1G	PLC	APCM	
-	√	√	√	√	-

Where **RE \geq 1G**: Radiated Emission above 1GHz **RE $<$ 1G**: Radiated Emission below 1GHz
PLC: Power Line Conducted Emission **APCM**: Antenna Port Conducted Measurement

RADIATED EMISSION TEST (ABOVE 1GHz):

Pre-Scan has been conducted to determine the worst-case mode from all possible combinations between available modulations, data rates and antenna ports (if EUT with antenna diversity architecture).

Following channel(s) was (were) selected for the final test as listed below.

EUT CONFIGURE MODE	MODE	FREQ. BAND (MHz)	AVAILABLE CHANNEL	TESTED CHANNEL	MODULATION TECHNOLOGY	MODULATION TYPE	DATA RATE (Mbps)
-	802.11a	5180-5240	36 to 48	36, 44, 48	OFDM	BPSK	6.0
	802.11n (20MHz)		36 to 48	36, 44, 48	OFDM	BPSK	MCS0
	802.11n (40MHz)		38 to 46	38, 46	OFDM	BPSK	MCS0
	802.11ac (80MHz)		42	42	OFDM	BPSK	V0
-	802.11a	5260-5320	52 to 64	52, 60, 64	OFDM	BPSK	6.0
	802.11n (20MHz)		52 to 64	52, 60, 64	OFDM	BPSK	MCS0
	802.11n (40MHz)		54 to 62	54, 62	OFDM	BPSK	MCS0
	802.11ac (80MHz)		58	58	OFDM	BPSK	V0
-	802.11a	5500-5700	100 to 140	100, 116, 140	OFDM	BPSK	6.0
	802.11n (20MHz)		100 to 140	100, 116, 140	OFDM	BPSK	MCS0
	802.11n (40MHz)		102 to 134	102, 110, 134	OFDM	BPSK	MCS0
	802.11ac (80MHz)		106 to 122	106, 102	OFDM	BPSK	V0
-	802.11a	5745-5825	149 to 165	149, 157, 165	OFDM	BPSK	6.0
	802.11n (20MHz)		149 to 165	149, 157, 165	OFDM	BPSK	MCS0
	802.11n (40MHz)		151 to 159	151, 159	OFDM	BPSK	MCS0
	802.11ac (80MHz)		155	155	OFDM	BPSK	V0

RADIATED EMISSION TEST (BELOW 1GHz):

Pre-Scan has been conducted to determine the worst-case mode from all possible combinations between available modulations, data rates and antenna ports (if EUT with antenna diversity architecture).

Following channel(s) was (were) selected for the final test as listed below.

EUT CONFIGURE MODE	MODE	FREQ. BAND (MHz)	AVAILABLE CHANNEL	TESTED CHANNEL	MODULATION TECHNOLOGY	MODULATION TYPE	DATA RATE (Mbps)
-	802.11n (40MHz)	5745-5825	151 to 159	151	OFDM	BPSK	MCS0

POWER LINE CONDUCTED EMISSION TEST:

EUT CONFIGURE MODE	MODE	FREQ. BAND (MHz)	AVAILABLE CHANNEL	TESTED CHANNEL	MODULATION TECHNOLOGY	MODULATION TYPE	DATA RATE (Mbps)
-	802.11n (40MHz)	5745-5825	151 to 159	151	OFDM	BPSK	MCS0

BANDEDGE MEASUREMENT:

Pre-Scan has been conducted to determine the worst-case mode from all possible combinations between available modulations, data rates and antenna ports (if EUT with antenna diversity architecture).

Following channel(s) was (were) selected for the final test as listed below.

EUT CONFIGURE MODE	MODE	FREQ. BAND (MHz)	AVAILABLE CHANNEL	TESTED CHANNEL	MODULATION TECHNOLOGY	MODULATION TYPE	DATA RATE (Mbps)
-	802.11a	5180-5240	36 to 48	36, 44, 48	OFDM	BPSK	6.0
	802.11n (20MHz)		36 to 48	36, 44, 48	OFDM	BPSK	MCS0
	802.11n (40MHz)		38 to 46	38, 46	OFDM	BPSK	MCS0
	802.11ac (80MHz)		42	42	OFDM	BPSK	V0
-	802.11a	5745-5825	149 to 165	149, 157, 165	OFDM	BPSK	6.0
	802.11n (20MHz)		149 to 165	149, 157, 165	OFDM	BPSK	MCS0
	802.11n (40MHz)		151 to 159	151, 159	OFDM	BPSK	MCS0
	802.11ac (80MHz)		155	155	OFDM	BPSK	V0

ANTENNA PORT CONDUCTED MEASUREMENT:

This item includes all test value of each mode, but only includes spectrum plot of worst value of each mode.

Pre-Scan has been conducted to determine the worst-case mode from all possible combinations between available modulations, data rates and antenna ports (if EUT with antenna diversity architecture).

Following channel(s) was (were) selected for the final test as listed below.

EUT CONFIGURE MODE	MODE	FREQ. BAND (MHz)	AVAILABLE CHANNEL	TESTED CHANNEL	MODULATION TECHNOLOGY	MODULATION TYPE	DATA RATE (Mbps)
-	802.11a	5180-5240	36 to 48	36, 44, 48	OFDM	BPSK	6.0
	802.11n (20MHz)		36 to 48	36, 44, 48	OFDM	BPSK	MCS0
	802.11n (40MHz)		38 to 46	38, 46	OFDM	BPSK	MCS0
	802.11ac (80MHz)		42	42	OFDM	BPSK	V0
-	802.11a	5745-5825	149 to 165	149, 157, 165	OFDM	BPSK	6.0
	802.11n (20MHz)		149 to 165	149, 157, 165	OFDM	BPSK	MCS0
	802.11n (40MHz)		151 to 159	151, 159	OFDM	BPSK	MCS0
	802.11ac (80MHz)		155	155	OFDM	BPSK	V0

TEST CONDITION:

APPLICABLE TO	ENVIRONMENTAL CONDITIONS	INPUT POWER	TESTED BY
RE \geq 1G	25deg. C, 65%RH	120Vac, 60Hz	Hwa Chiang, Charles Hsiao
RE<1G	25deg. C, 65%RH	120Vac, 60Hz	Charles Hsiao
PLC	25deg. C, 65%RH	120Vac, 60Hz	Toby Tian
APCM	25deg. C, 65%RH	120Vac, 60Hz	Luke Chen

3.3 DESCRIPTION OF SUPPORT UNITS

The EUT has been tested as an independent unit together with other necessary accessories or support units.

3.3.1 CONFIGURATION OF SYSTEM UNDER TEST

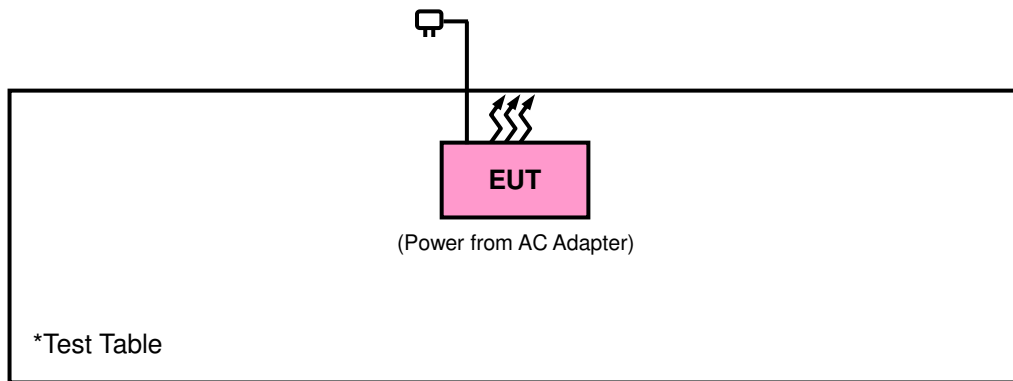

3.4 DUTY CYCLE TEST SIGNAL

MODULATION TYPE: BPSK

If duty cycle is < 98%, duty factor shall be considered.

802.11a: Duty cycle = 2.099/4.583 = 0.458, Duty factor = $10 \cdot \log(1/0.458) = 3.39$

802.11n (20MHz): Duty cycle = 1.971/5.096 = 0.386, Duty factor = $10 \cdot \log(1/0.386) = 4.13$

802.11n (40MHz): Duty cycle = 0.945/5.032 = 0.187, Duty factor = $10 \cdot \log(1/0.187) = 7.26$

802.11ac (80MHz): Duty cycle = 0.448/5.160 = 0.087, Duty factor = $10 \cdot \log(1/0.087) = 10.60$

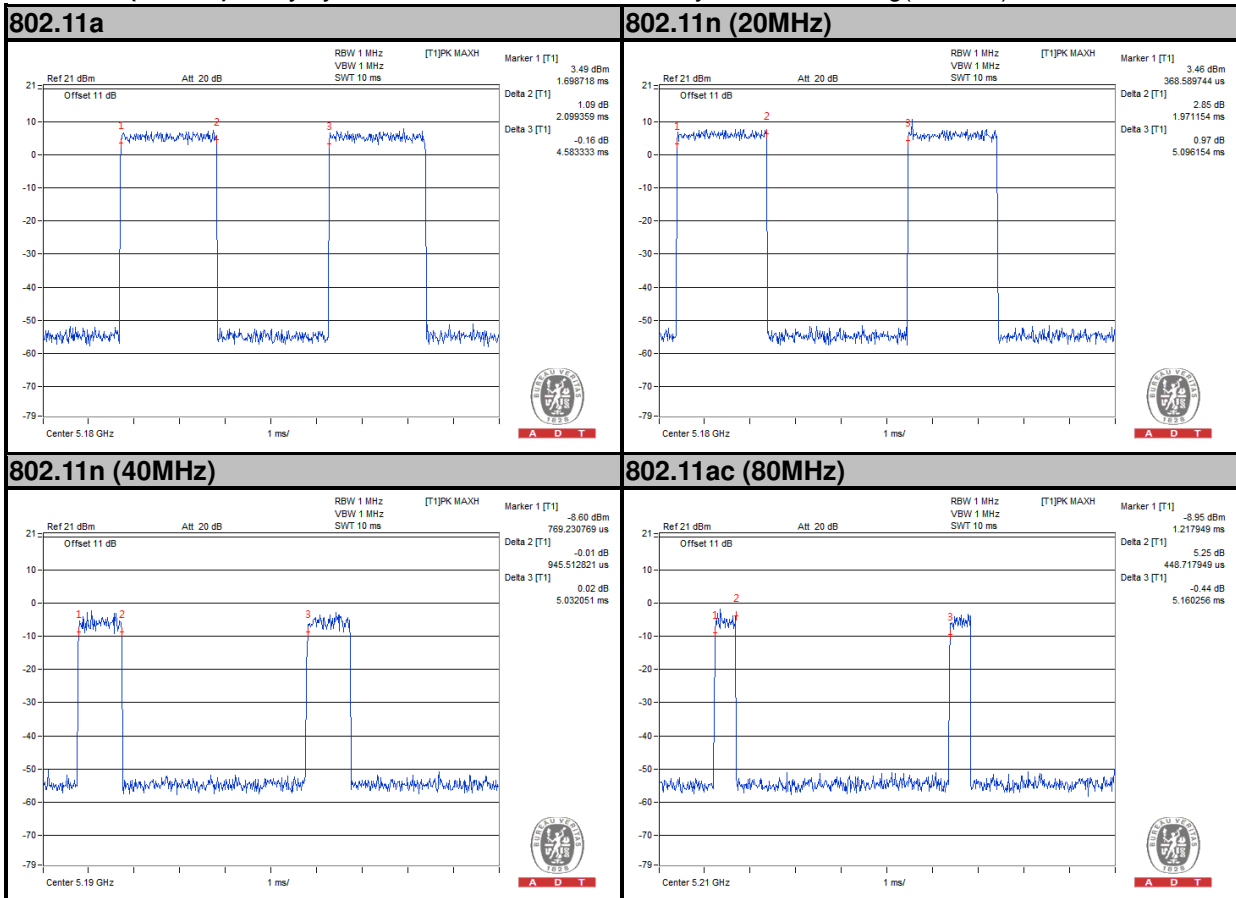

MODULATION TYPE: QPSK

If duty cycle is < 98%, duty factor shall be considered.

802.11a: Duty cycle = 1.057/2.596 = 0.407, Duty factor = 10 * log(1/0.407) = 3.90

802.11n (20MHz): Duty cycle = 0.993/4.871 = 0.203, Duty factor = 10 * log(1/0.203) = 6.91

802.11n (40MHz): Duty cycle = 0.464/4.230 = 0.109, Duty factor = 10 * log(1/0.109) = 9.59

802.11ac (80MHz): Duty cycle = 0.224/5.160 = 0.043, Duty factor = 10 * log(1/0.043) = 13.62

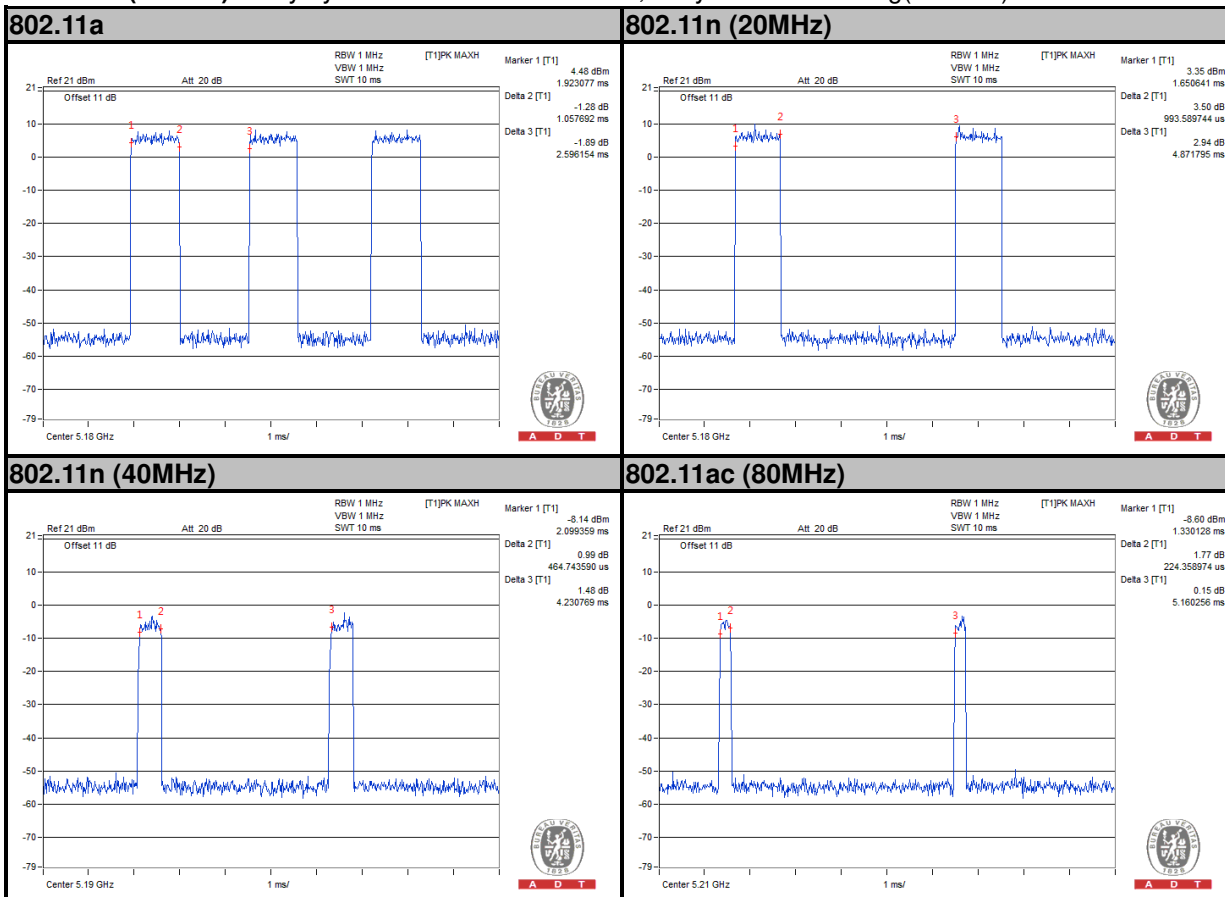

MODULATION TYPE: 16QAM

If duty cycle is < 98%, duty factor shall be considered.

802.11a: Duty cycle = 0.544/2.035 = 0.267, Duty factor = 10 * log(1/0.267) = 5.72

802.11n (20MHz): Duty cycle = 0.512/5.032 = 0.101, Duty factor = 10 * log(1/0.101) = 9.92

802.11n (40MHz): Duty cycle = 0.224/5.993 = 0.037, Duty factor = 10 * log(1/0.037) = 14.27

802.11ac (80MHz): Duty cycle = 0.128/5.160 = 0.024, Duty factor = 10 * log(1/0.024) = 16.06

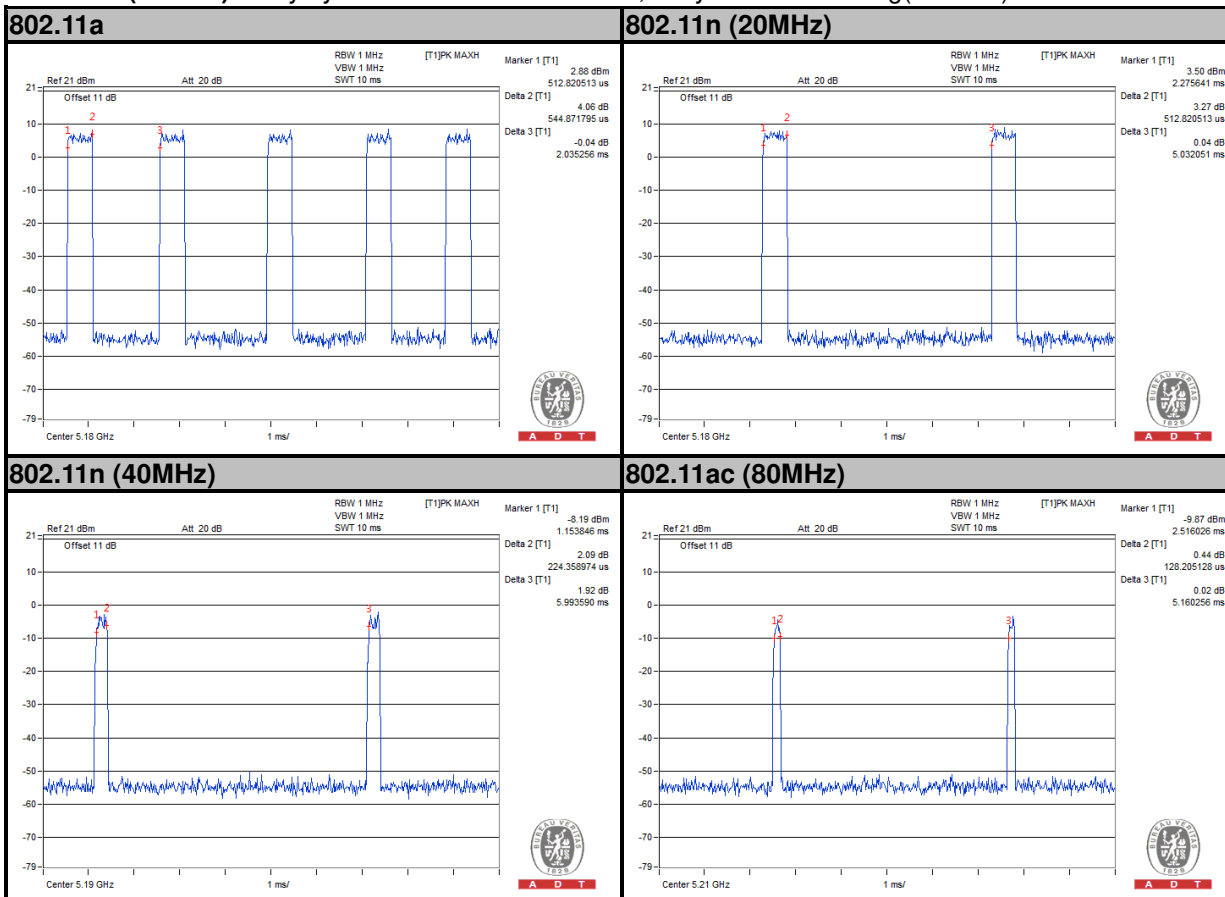

MODULATION TYPE: 64QAM

If duty cycle is < 98%, duty factor shall be considered.

802.11a: Duty cycle = 0.280/1.818 = 0.154, Duty factor = $10 \cdot \log(1/0.154) = 8.12$

802.11n (20MHz): Duty cycle = 0.288/5.384 = 0.053, Duty factor = $10 \cdot \log(1/0.053) = 12.71$

802.11n (40MHz): Duty cycle = 0.128/5.897 = 0.021, Duty factor = $10 \cdot \log(1/0.021) = 16.64$

802.11ac (80MHz): Duty cycle = 0.080/5.160 = 0.015, Duty factor = $10 \cdot \log(1/0.015) = 18.10$

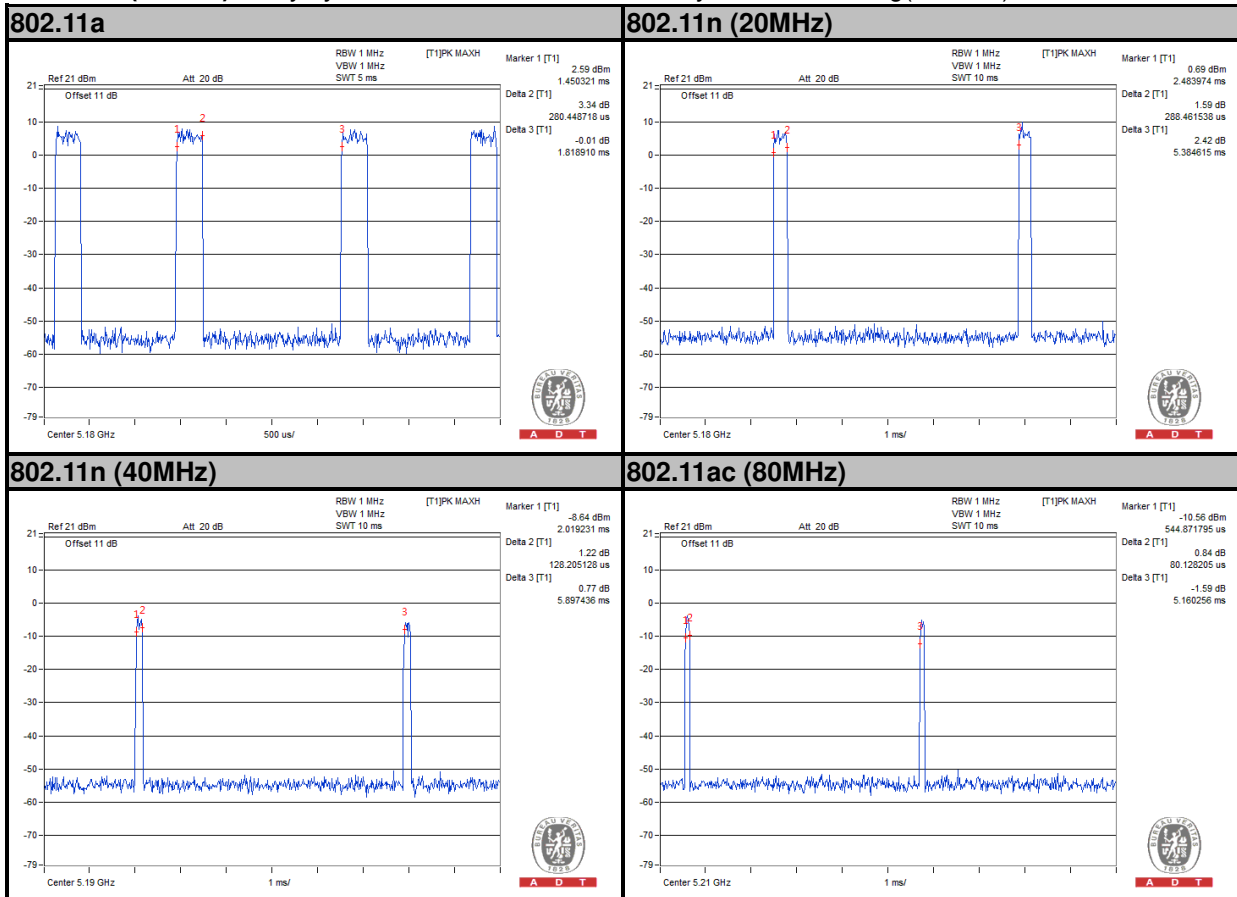

MODULATION TYPE: 256QAM

If duty cycle is < 98%, duty factor shall be considered.

802.11ac (80MHz): Duty cycle = $0.048/5.160 = 0.009$, Duty factor = $10 * \log(1/0.009) = 20.32$

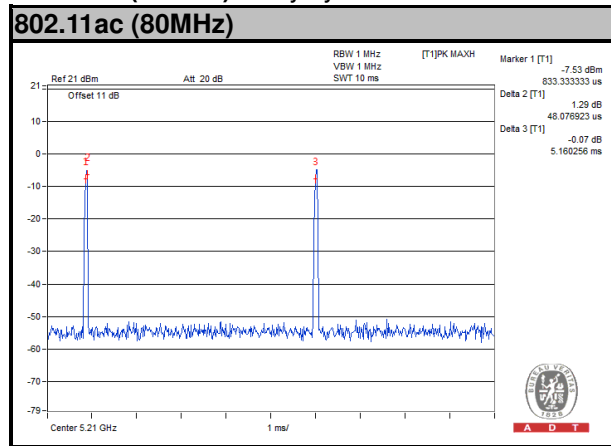



3.5 GENERAL DESCRIPTION OF APPLIED STANDARDS

The EUT is a RF Product. According to the specifications of the manufacturer, it must comply with the requirements of the following standards:

FCC Part 15, Subpart E (15.407)

789033 D02 General UNII Test Procedures New Rules v01r02

644545 D01 Guidance for IEEE 802 11ac v01r02

ANSI C63.10-2009

All test items have been performed and recorded as per the above standards.

NOTE: The EUT has been verified to comply with the requirements of FCC Part 15, Subpart B, Class B (DoC). The test report has been issued separately.

4. TEST TYPES AND RESULTS

4.1 RADIATED EMISSION AND BANDEDGE MEASUREMENT

4.1.1 LIMITS OF RADIATED EMISSION AND BANDEDGE MEASUREMENT

Radiated emissions which fall in the restricted bands must comply with the radiated emission limits specified as below table:

FREQUENCIES (MHz)	FIELD STRENGTH (microvolts/meter)	MEASUREMENT DISTANCE (meters)
0.009 ~ 0.490	2400/F(kHz)	300
0.490 ~ 1.705	24000/F(kHz)	30
1.705 ~ 30.0	30	30
30 ~ 88	100	3
88 ~ 216	150	3
216 ~ 960	200	3
Above 960	500	3

NOTE:

1. The lower limit shall apply at the transition frequencies.
2. Emission level (dBuV/m) = 20 log Emission level (uV/m).
3. For frequencies above 1000MHz, the field strength limits are based on average detector, however, the peak field strength of any emission shall not exceed the maximum permitted average limits, specified above by more than 20dB under any condition of modulation.

4.1.2 LIMITS OF UNWANTED EMISSION OUT OF THE RESTRICTED BANDS

APPLICABLE TO	LIMIT	
789033 D02 General UNII Test Procedures New Rules v01	FIELD STRENGTH AT 3m	
	PK: 74 (dBµV/m)	AV: 54 (dBµV/m)
APPLICABLE TO	EIRP LIMIT	EQUIVALENT FIELD STRENGTH AT 3m
15.407(b)(1)	PK: -27 (dBm/MHz)	PK: 68.2 (dBµV/m)
15.407(b)(2)		
15.407(b)(3)		
15.407(b)(4)	PK: -27 (dBm/MHz) ^{*1} PK: -17 (dBm/MHz) ^{*2}	PK: 68.2 (dBµV/m) ^{*1} PK: 78.2 (dBµV/m) ^{*2}

NOTE: ^{*1} beyond 10MHz of the band edge ^{*2} within 10 MHz of band edge

The following formula is used to convert the equipment isotropic radiated power (eirp) to field strength:

$$E = \frac{1000000\sqrt{30P}}{3} \mu\text{V/m, where P is the eirp (Watts).}$$

4.1.3 TEST INSTRUMENTS

DESCRIPTION & MANUFACTURER	MODEL NO.	SERIAL NO.	DATE OF CALIBRATION	DUE DATE OF CALIBRATION
Test Receiver Agilent	N9038A	MY51210203	Jan.21, 2015	Jan.21, 2016
Spectrum Analyzer Agilent	N9010A	MY52220314	Sep.03, 2014	Sep.02, 2015
Spectrum Analyzer ROHDE & SCHWARZ	FSU43	101261	Dec. 10, 2014	Dec. 09, 2015
BILOG Antenna SCHWARZBECK	VULB9168	9168-472	Feb. 04, 2015	Feb. 04, 2016
HORN Antenna SCHWARZBECK	BBHA 9120 D	9120D-969	Feb. 09, 2015	Feb. 09, 2016
HORN Antenna SCHWARZBECK	BBHA 9170	9170-480	Feb. 04, 2015	Feb. 04, 2016
Loop Antenna	EM-6879	269	Aug.13, 2014	Aug.12, 2015
Preamplifier EMCI	EMC 012645	980115	Dec. 12, 2014	Dec. 11, 2015
Preamplifier EMCI	EMC 184045	980116	Jan. 09, 2015	Jan. 08, 2016
Preamplifier EMCI	EMC 330H	980112	Dec. 27, 2014	Dec. 26, 2015
RF signal cable HUBER+SUHNNER	SUCOFLEX 104	309219/4 2950114	Oct. 18, 2014	Oct. 17, 2015
RF signal cable HUBER+SUHNNER	SUCOFLEX 104	250130/4	Oct. 18, 2014	Oct. 17, 2015
RF signal cable Worken	RG-213	NA	Nov. 07, 2014	Nov. 06, 2015
Software BV ADT	E3 6.120103	NA	NA	NA
Antenna Tower MF	MFA-440H	NA	NA	NA
Turn Table MF	MFT-201SS	NA	NA	NA
Antenna Tower & Turn Table Controller MF	MF-7802	NA	NA	NA
Bluetooth Tester	CBT	100980	Feb. 10, 2015	Feb. 09, 2016
Power Meter	ML2495A	1232002	Sep. 17, 2014	Sep. 16, 2015
Power Sensor	MA2411B	1207325	Sep. 17, 2014	Sep. 16, 2015

- NOTE:**
1. The calibration interval of the above test instruments is 12 months and the calibrations are traceable to NML/ROC and NIST/USA.
 2. The calibration interval of the loop antenna is 24 months and the calibrations are traceable to NML/ROC and NIST/USA.
 3. The test was performed in HwaYa Chamber 10.
 4. The horn antenna and HP preamplifier (model: 8449B) are used only for the measurement of emission frequency above 1GHz if tested.
 5. The FCC Site Registration No. is 690701.
 6. The IC Site Registration No. is IC 7450F-10.

4.1.4 TEST PROCEDURES

- a. The EUT was placed on the top of a rotating table 0.8 meters (for below 1GHz) / 1.5 meters (for above 1GHz) above the ground at 3 meter chamber room for test. The table was rotated 360 degrees to determine the position of the highest radiation.
- b. The EUT was set 3 meters away from the interference-receiving antenna, which was mounted on the top of a variable-height antenna tower.
- c. The antenna is a broadband antenna, and its height is varied from one meter to four meters above the ground to determine the maximum value of the field strength. Both horizontal and vertical polarizations of the antenna are set to make the measurement.
- d. For each suspected emission, the EUT was arranged to its worst case and then the antenna was tuned to heights from 1 meter to 4 meters and the rotatable table was turned from 0 degrees to 360 degrees to find the maximum reading.
- e. The test-receiver system was set to Peak Detect Function and Specified Bandwidth with Maximum Hold Mode.
- f. If the emission level of the EUT in peak mode was 10dB lower than the limit specified, then testing could be stopped and the peak values of the EUT would be reported. Otherwise the emissions that did not have 10dB margin would be re-tested one by one using peak, quasi-peak or average method as specified and then reported in a data sheet.

NOTE:

1. The resolution bandwidth and video bandwidth of test receiver/spectrum analyzer is 120kHz for Peak detection (PK) and Quasi-peak detection (QP) at frequency below 1GHz.
2. The resolution bandwidth of test receiver/spectrum analyzer is 1MHz and video bandwidth is 3MHz for Peak detection at frequency above 1GHz.
3. The resolution bandwidth of test receiver/spectrum analyzer is 1MHz and the video bandwidth is 1kHz (Duty cycle < 98%) or 10Hz (Duty cycle > 98%) for Average detection (AV) at frequency above 1GHz.
4. All modes of operation were investigated and the worst-case emissions are reported.

4.1.5 DEVIATION FROM TEST STANDARD

No deviation.

4.1.6 TEST SETUP

<Frequency Range 30MHz ~ 1GHz>

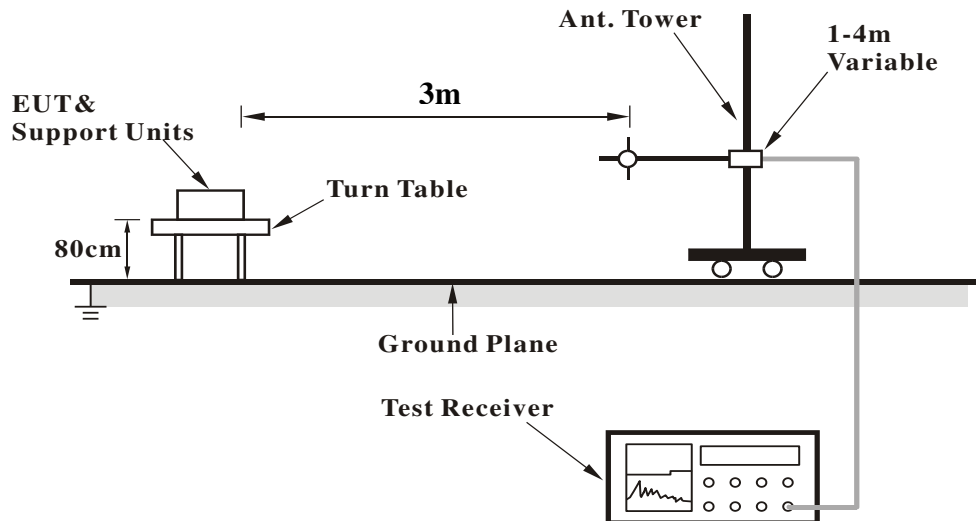

<Frequency Range above 1GHz>

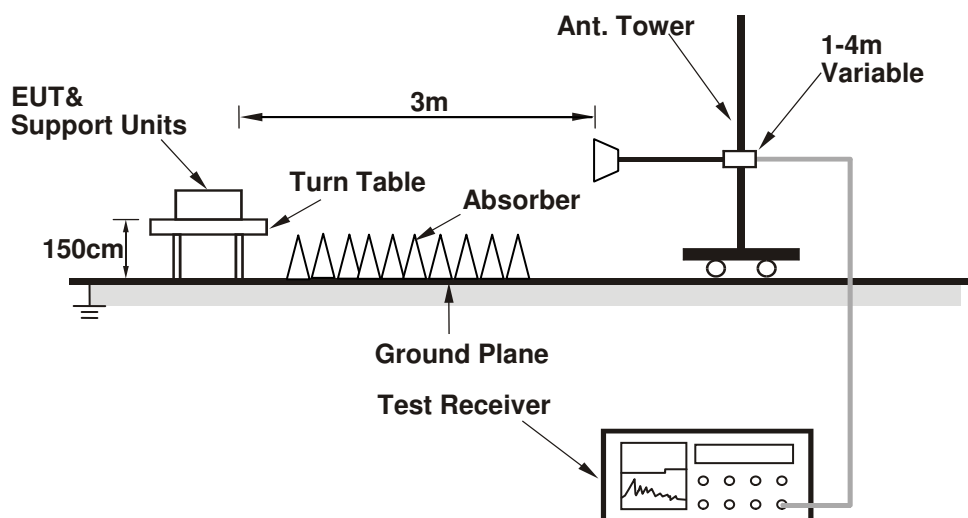

For the actual test configuration, please refer to the attached file (Test Setup Photo).

4.1.7 EUT OPERATING CONDITIONS

- Placed the EUT on a testing table.
- Use the software to control the EUT under transmission condition continuously at specific channel frequency.

4.1.8 TEST RESULTS

ABOVE 1GHz WORST-CASE DATA

802.11a

EUT TEST CONDITION		MEASUREMENT DETAIL	
CHANNEL	Channel 36	FREQUENCY RANGE	1GHz ~ 40GHz
INPUT POWER	120Vac, 60 Hz	DETECTOR FUNCTION	Peak (PK) Average (AV)
ENVIRONMENTAL CONDITIONS	25deg. C, 65%RH	TESTED BY	Hwa Chiang

ANTENNA POLARITY & TEST DISTANCE: HORIZONTAL AT 3 M										
FREQ. (MHz)	EMISSION LEVEL (dBuV/m)	READ LEVEL (dBuV)	LIMIT (dBuV/m)	MARGIN (dB)	ANTENNA FACTOR (dB/m)	CABLE LOSS (dB)	PREAMP FACTOR (dB)	ANTENNA HEIGHT (cm)	TABLE ANGLE (Degree)	REMARK
5026	42.07	34.04	54	-11.93	34.03	7.97	33.97	235	46	Average
5026	56.92	48.89	74	-17.08	34.03	7.97	33.97	235	46	Peak
5180	77.77	69.46			34.15	8.16	34	235	46	Average
5180	85.98	77.67			34.15	8.16	34	235	46	Peak
5450	42.52	33.7	54	-11.48	34.36	8.51	34.05	235	46	Average
5450	56.89	48.07	74	-17.11	34.36	8.51	34.05	235	46	Peak
ANTENNA POLARITY & TEST DISTANCE: VERTICAL AT 3 M										
FREQ. (MHz)	EMISSION LEVEL (dBuV/m)	READ LEVEL (dBuV)	LIMIT (dBuV/m)	MARGIN (dB)	ANTENNA FACTOR (dB/m)	CABLE LOSS (dB)	PREAMP FACTOR (dB)	ANTENNA HEIGHT (cm)	TABLE ANGLE (Degree)	REMARK
5034	42.15	34.09	54	-11.85	34.03	8	33.97	101	171	Average
5034	56.82	48.76	74	-17.18	34.03	8	33.97	101	171	Peak
5180	77.13	68.82			34.15	8.16	34	101	171	Average
5180	84.83	76.52			34.15	8.16	34	101	171	Peak
5428	42.47	33.7	54	-11.53	34.33	8.48	34.04	101	171	Average
5428	57.39	48.62	74	-16.61	34.33	8.48	34.04	101	171	Peak

REMARKS:

- Emission Level = Read Level + Antenna Factor + Cable Loss - Preamp Factor
Margin value = Emission level – Limit value
- 5180MHz: Fundamental frequency.

EUT TEST CONDITION		MEASUREMENT DETAIL	
CHANNEL	Channel 44	FREQUENCY RANGE	1GHz ~ 40GHz
INPUT POWER	120Vac, 60 Hz	DETECTOR FUNCTION	Peak (PK) Average (AV)
ENVIRONMENTAL CONDITIONS	25deg. C, 65%RH	TESTED BY	Hwa Chiang

ANTENNA POLARITY & TEST DISTANCE: HORIZONTAL AT 3 M										
FREQ. (MHz)	EMISSION LEVEL (dBuV/m)	READ LEVEL (dBuV)	LIMIT (dBuV/m)	MARGIN (dB)	ANTENNA FACTOR (dB/m)	CABLE LOSS (dB)	PREAMP FACTOR (dB)	ANTENNA HEIGHT (cm)	TABLE ANGLE (Degree)	REMARK
5110	42.24	34.04	54	-11.76	34.09	8.1	33.99	244	45	Average
5110	56.72	48.52	74	-17.28	34.09	8.1	33.99	244	45	Peak
5220	77.4	69.01			34.17	8.22	34	244	45	Average
5220	85.35	76.96			34.17	8.22	34	244	45	Peak
5382	41.86	33.18	54	-12.14	34.31	8.41	34.04	244	45	Average
5382	57.47	48.79	74	-16.53	34.31	8.41	34.04	244	45	Peak
ANTENNA POLARITY & TEST DISTANCE: VERTICAL AT 3 M										
FREQ. (MHz)	EMISSION LEVEL (dBuV/m)	READ LEVEL (dBuV)	LIMIT (dBuV/m)	MARGIN (dB)	ANTENNA FACTOR (dB/m)	CABLE LOSS (dB)	PREAMP FACTOR (dB)	ANTENNA HEIGHT (cm)	TABLE ANGLE (Degree)	REMARK
5092	42.17	34	54	-11.83	34.08	8.07	33.98	101	194	Average
5092	56.59	48.42	74	-17.41	34.08	8.07	33.98	101	194	Peak
5220	75.96	67.57			34.17	8.22	34	101	194	Average
5220	84.23	75.84			34.17	8.22	34	101	194	Peak
5458	42.56	33.74	54	-11.44	34.36	8.51	34.05	101	194	Average
5458	58.37	49.55	74	-15.63	34.36	8.51	34.05	101	194	Peak

REMARKS:

- Emission Level = Read Level + Antenna Factor + Cable Loss - Preamp Factor
Margin value = Emission level – Limit value
- 5220MHz: Fundamental frequency.

EUT TEST CONDITION		MEASUREMENT DETAIL	
CHANNEL	Channel 48	FREQUENCY RANGE	1GHz ~ 40GHz
INPUT POWER	120Vac, 60 Hz	DETECTOR FUNCTION	Peak (PK) Average (AV)
ENVIRONMENTAL CONDITIONS	25deg. C, 65%RH	TESTED BY	Hwa Chiang

ANTENNA POLARITY & TEST DISTANCE: HORIZONTAL AT 3 M										
FREQ. (MHz)	EMISSION LEVEL (dBuV/m)	READ LEVEL (dBuV)	LIMIT (dBuV/m)	MARGIN (dB)	ANTENNA FACTOR (dB/m)	CABLE LOSS (dB)	PREAMP FACTOR (dB)	ANTENNA HEIGHT (cm)	TABLE ANGLE (Degree)	REMARK
5066	42.15	34.05	54	-11.85	34.05	8.03	33.98	245	52	Average
5066	57.43	49.33	74	-16.57	34.05	8.03	33.98	245	52	Peak
5240	78.16	69.72			34.19	8.26	34.01	245	52	Average
5240	85.68	77.24			34.19	8.26	34.01	245	52	Peak
5390	42.4	33.72	54	-11.6	34.31	8.41	34.04	245	52	Average
5390	57.64	48.96	74	-16.36	34.31	8.41	34.04	245	52	Peak
ANTENNA POLARITY & TEST DISTANCE: VERTICAL AT 3 M										
FREQ. (MHz)	EMISSION LEVEL (dBuV/m)	READ LEVEL (dBuV)	LIMIT (dBuV/m)	MARGIN (dB)	ANTENNA FACTOR (dB/m)	CABLE LOSS (dB)	PREAMP FACTOR (dB)	ANTENNA HEIGHT (cm)	TABLE ANGLE (Degree)	REMARK
5076	42.18	34.06	54	-11.82	34.07	8.03	33.98	100	163	Average
5076	57.17	49.05	74	-16.83	34.07	8.03	33.98	100	163	Peak
5240	76.21	67.77			34.19	8.26	34.01	100	163	Average
5240	84.58	76.14			34.19	8.26	34.01	100	163	Peak
5426	42.5	33.73	54	-11.5	34.33	8.48	34.04	100	163	Average
5426	57.55	48.78	74	-16.45	34.33	8.48	34.04	100	163	Peak

REMARKS:

- Emission Level = Read Level + Antenna Factor + Cable Loss - Preamp Factor
Margin value = Emission level – Limit value
- 5240MHz: Fundamental frequency.

EUT TEST CONDITION		MEASUREMENT DETAIL	
CHANNEL	Channel 52	FREQUENCY RANGE	1GHz ~ 40GHz
INPUT POWER	120Vac, 60 Hz	DETECTOR FUNCTION	Peak (PK) Average (AV)
ENVIRONMENTAL CONDITIONS	25deg. C, 65%RH	TESTED BY	Charles Hsiao

ANTENNA POLARITY & TEST DISTANCE: HORIZONTAL AT 3 M										
FREQ. (MHz)	EMISSION LEVEL (dBuV/m)	READ LEVEL (dBuV)	LIMIT (dBuV/m)	MARGIN (dB)	ANTENNA FACTOR (dB/m)	CABLE LOSS (dB)	PREAMP FACTOR (dB)	ANTENNA HEIGHT (cm)	TABLE ANGLE (Degree)	REMARK
5090	42.21	34.04	54	-11.79	34.08	8.07	33.98	119	131	Average
5090	56.82	48.65	74	-17.18	34.08	8.07	33.98	119	131	Peak
5260	80.86	72.4			34.21	8.26	34.01	119	131	Average
5260	88.68	80.22			34.21	8.26	34.01	119	131	Peak
5416	42.48	33.75	54	-11.52	34.33	8.44	34.04	119	131	Average
5416	57.26	48.53	74	-16.74	34.33	8.44	34.04	119	131	Peak
ANTENNA POLARITY & TEST DISTANCE: VERTICAL AT 3 M										
FREQ. (MHz)	EMISSION LEVEL (dBuV/m)	READ LEVEL (dBuV)	LIMIT (dBuV/m)	MARGIN (dB)	ANTENNA FACTOR (dB/m)	CABLE LOSS (dB)	PREAMP FACTOR (dB)	ANTENNA HEIGHT (cm)	TABLE ANGLE (Degree)	REMARK
5066	42.02	33.92	54	-11.98	34.05	8.03	33.98	100	252	Average
5066	57.49	49.39	74	-16.51	34.05	8.03	33.98	100	252	Peak
5260	79.17	70.71			34.21	8.26	34.01	100	252	Average
5260	87.34	78.88			34.21	8.26	34.01	100	252	Peak
5454	42.53	33.71	54	-11.47	34.36	8.51	34.05	100	252	Average
5454	57.68	48.86	74	-16.32	34.36	8.51	34.05	100	252	Peak

REMARKS:

- Emission Level = Read Level + Antenna Factor + Cable Loss - Preamp Factor
Margin value = Emission level – Limit value
- 5260MHz: Fundamental frequency.

EUT TEST CONDITION		MEASUREMENT DETAIL	
CHANNEL	Channel 60	FREQUENCY RANGE	1GHz ~ 40GHz
INPUT POWER	120Vac, 60 Hz	DETECTOR FUNCTION	Peak (PK) Average (AV)
ENVIRONMENTAL CONDITIONS	25deg. C, 65%RH	TESTED BY	Charles Hsiao

ANTENNA POLARITY & TEST DISTANCE: HORIZONTAL AT 3 M										
FREQ. (MHz)	EMISSION LEVEL (dBuV/m)	READ LEVEL (dBuV)	LIMIT (dBuV/m)	MARGIN (dB)	ANTENNA FACTOR (dB/m)	CABLE LOSS (dB)	PREAMP FACTOR (dB)	ANTENNA HEIGHT (cm)	TABLE ANGLE (Degree)	REMARK
5078	42.13	34.01	54	-11.87	34.07	8.03	33.98	111	131	Average
5078	56.7	48.58	74	-17.3	34.07	8.03	33.98	111	131	Peak
5300	80.46	71.92			34.24	8.32	34.02	111	131	Average
5300	88.76	80.22			34.24	8.32	34.02	111	131	Peak
5458	42.53	33.71	54	-11.47	34.36	8.51	34.05	111	131	Average
5458	56.93	48.11	74	-17.07	34.36	8.51	34.05	111	131	Peak
ANTENNA POLARITY & TEST DISTANCE: VERTICAL AT 3 M										
FREQ. (MHz)	EMISSION LEVEL (dBuV/m)	READ LEVEL (dBuV)	LIMIT (dBuV/m)	MARGIN (dB)	ANTENNA FACTOR (dB/m)	CABLE LOSS (dB)	PREAMP FACTOR (dB)	ANTENNA HEIGHT (cm)	TABLE ANGLE (Degree)	REMARK
5042	42.07	34.01	54	-11.93	34.04	8	33.98	101	234	Average
5042	56.78	48.72	74	-17.22	34.04	8	33.98	101	234	Peak
5300	79.54	71			34.24	8.32	34.02	101	234	Average
5300	87.88	79.34			34.24	8.32	34.02	101	234	Peak
5430	42.48	33.69	54	-11.52	34.35	8.48	34.04	101	234	Average
5430	57.36	48.57	74	-16.64	34.35	8.48	34.04	101	234	Peak

REMARKS:

- Emission Level = Read Level + Antenna Factor + Cable Loss - Preamp Factor
Margin value = Emission level – Limit value
- 5300MHz: Fundamental frequency.

EUT TEST CONDITION		MEASUREMENT DETAIL	
CHANNEL	Channel 64	FREQUENCY RANGE	1GHz ~ 40GHz
INPUT POWER	120Vac, 60 Hz	DETECTOR FUNCTION	Peak (PK) Average (AV)
ENVIRONMENTAL CONDITIONS	25deg. C, 65%RH	TESTED BY	Charles Hsiao

ANTENNA POLARITY & TEST DISTANCE: HORIZONTAL AT 3 M										
FREQ. (MHz)	EMISSION LEVEL (dBuV/m)	READ LEVEL (dBuV)	LIMIT (dBuV/m)	MARGIN (dB)	ANTENNA FACTOR (dB/m)	CABLE LOSS (dB)	PREAMP FACTOR (dB)	ANTENNA HEIGHT (cm)	TABLE ANGLE (Degree)	REMARK
5036	42.06	34	54	-11.94	34.03	8	33.97	251	321	Average
5036	56.73	48.67	74	-17.27	34.03	8	33.97	251	321	Peak
5320	79.52	70.94			34.25	8.35	34.02	251	321	Average
5320	87.14	78.56			34.25	8.35	34.02	251	321	Peak
5428	42.41	33.64	54	-11.59	34.33	8.48	34.04	251	321	Average
5428	57.52	48.75	74	-16.48	34.33	8.48	34.04	251	321	Peak
ANTENNA POLARITY & TEST DISTANCE: VERTICAL AT 3 M										
FREQ. (MHz)	EMISSION LEVEL (dBuV/m)	READ LEVEL (dBuV)	LIMIT (dBuV/m)	MARGIN (dB)	ANTENNA FACTOR (dB/m)	CABLE LOSS (dB)	PREAMP FACTOR (dB)	ANTENNA HEIGHT (cm)	TABLE ANGLE (Degree)	REMARK
5136	42.23	33.98	54	-11.77	34.11	8.13	33.99	100	198	Average
5136	56.42	48.17	74	-17.58	34.11	8.13	33.99	100	198	Peak
5320	78.92	70.34			34.25	8.35	34.02	100	198	Average
5320	86.42	77.84			34.25	8.35	34.02	100	198	Peak
5432	42.72	33.93	54	-11.28	34.35	8.48	34.04	100	198	Average
5432	57.1	48.31	74	-16.9	34.35	8.48	34.04	100	198	Peak

REMARKS:

- Emission Level = Read Level + Antenna Factor + Cable Loss - Preamp Factor
Margin value = Emission level – Limit value
- 5320MHz: Fundamental frequency.

EUT TEST CONDITION		MEASUREMENT DETAIL	
CHANNEL	Channel 100	FREQUENCY RANGE	1GHz ~ 40GHz
INPUT POWER	120Vac, 60 Hz	DETECTOR FUNCTION	Peak (PK) Average (AV)
ENVIRONMENTAL CONDITIONS	25deg. C, 65%RH	TESTED BY	Charles Hsiao

ANTENNA POLARITY & TEST DISTANCE: HORIZONTAL AT 3 M										
FREQ. (MHz)	EMISSION LEVEL (dBuV/m)	READ LEVEL (dBuV)	LIMIT (dBuV/m)	MARGIN (dB)	ANTENNA FACTOR (dB/m)	CABLE LOSS (dB)	PREAMP FACTOR (dB)	ANTENNA HEIGHT (cm)	TABLE ANGLE (Degree)	REMARK
5420	43.31	34.54	54	-10.69	34.33	8.48	34.04	229	303	Average
5420	57.44	48.67	74	-16.56	34.33	8.48	34.04	229	303	Peak
5470	61.27	52.44	68.2	-6.93	34.37	8.51	34.05	228	302	Peak
5500	87.87	78.95			34.4	8.57	34.05	229	303	Average
5500	95.51	86.59			34.4	8.57	34.05	229	303	Peak
5725	57.4	48.24	68.2	-10.8	34.62	8.65	34.11	229	303	Peak
ANTENNA POLARITY & TEST DISTANCE: VERTICAL AT 3 M										
FREQ. (MHz)	EMISSION LEVEL (dBuV/m)	READ LEVEL (dBuV)	LIMIT (dBuV/m)	MARGIN (dB)	ANTENNA FACTOR (dB/m)	CABLE LOSS (dB)	PREAMP FACTOR (dB)	ANTENNA HEIGHT (cm)	TABLE ANGLE (Degree)	REMARK
5444	43.12	34.33	54	-10.88	34.35	8.48	34.04	103	208	Average
5444	57.32	48.53	74	-16.68	34.35	8.48	34.04	103	208	Peak
5470	55.78	46.95	68.2	-12.42	34.37	8.51	34.05	103	208	Peak
5500	82.97	74.05			34.4	8.57	34.05	103	208	Average
5500	91.22	82.3			34.4	8.57	34.05	103	208	Peak
5725	56.04	46.88	68.2	-12.16	34.62	8.65	34.11	103	208	Peak

REMARKS:

- Emission Level = Read Level + Antenna Factor + Cable Loss - Preamp Factor
Margin value = Emission level – Limit value
- 5500MHz: Fundamental frequency.
- 5470MHz & 5725MHz: Out of restricted band

EUT TEST CONDITION		MEASUREMENT DETAIL	
CHANNEL	Channel 116	FREQUENCY RANGE	1GHz ~ 40GHz
INPUT POWER	120Vac, 60 Hz	DETECTOR FUNCTION	Peak (PK) Average (AV)
ENVIRONMENTAL CONDITIONS	25deg. C, 65%RH	TESTED BY	Charles Hsiao

ANTENNA POLARITY & TEST DISTANCE: HORIZONTAL AT 3 M										
FREQ. (MHz)	EMISSION LEVEL (dBuV/m)	READ LEVEL (dBuV)	LIMIT (dBuV/m)	MARGIN (dB)	ANTENNA FACTOR (dB/m)	CABLE LOSS (dB)	PREAMP FACTOR (dB)	ANTENNA HEIGHT (cm)	TABLE ANGLE (Degree)	REMARK
5448	42.62	33.79	54	-11.38	34.36	8.51	34.04	229	306	Average
5448	57.39	48.56	74	-16.61	34.36	8.51	34.04	229	306	Peak
5470	56.13	47.3	68.2	-12.07	34.37	8.51	34.05	229	306	Peak
5580	88.67	79.68			34.47	8.6	34.08	229	306	Average
5580	96.84	87.85			34.47	8.6	34.08	229	306	Peak
5725	56.38	47.22	68.2	-11.82	34.62	8.65	34.11	229	306	Peak
ANTENNA POLARITY & TEST DISTANCE: VERTICAL AT 3 M										
FREQ. (MHz)	EMISSION LEVEL (dBuV/m)	READ LEVEL (dBuV)	LIMIT (dBuV/m)	MARGIN (dB)	ANTENNA FACTOR (dB/m)	CABLE LOSS (dB)	PREAMP FACTOR (dB)	ANTENNA HEIGHT (cm)	TABLE ANGLE (Degree)	REMARK
5432	42.52	33.73	54	-11.48	34.35	8.48	34.04	101	209	Average
5432	57.23	48.44	74	-16.77	34.35	8.48	34.04	101	209	Peak
5470	55.97	47.14	68.2	-12.23	34.37	8.51	34.05	101	209	Peak
5580	84.47	75.48			34.47	8.6	34.08	101	209	Average
5580	92.56	83.57			34.47	8.6	34.08	101	209	Peak
5725	55.32	46.16	68.2	-12.88	34.62	8.65	34.11	101	209	Peak

REMARKS:

- Emission Level = Read Level + Antenna Factor + Cable Loss - Preamp Factor
Margin value = Emission level – Limit value
- 5580MHz: Fundamental frequency.
- 5470MHz & 5725MHz: Out of restricted band

EUT TEST CONDITION		MEASUREMENT DETAIL	
CHANNEL	Channel 140	FREQUENCY RANGE	1GHz ~ 40GHz
INPUT POWER	120Vac, 60 Hz	DETECTOR FUNCTION	Peak (PK) Average (AV)
ENVIRONMENTAL CONDITIONS	25deg. C, 65%RH	TESTED BY	Charles Hsiao

ANTENNA POLARITY & TEST DISTANCE: HORIZONTAL AT 3 M										
FREQ. (MHz)	EMISSION LEVEL (dBuV/m)	READ LEVEL (dBuV)	LIMIT (dBuV/m)	MARGIN (dB)	ANTENNA FACTOR (dB/m)	CABLE LOSS (dB)	PREAMP FACTOR (dB)	ANTENNA HEIGHT (cm)	TABLE ANGLE (Degree)	REMARK
5398	42.36	33.64	54	-11.64	34.32	8.44	34.04	231	308	Average
5398	56.7	47.98	74	-17.3	34.32	8.44	34.04	231	308	Peak
5470	56.81	47.98	68.2	-11.39	34.37	8.51	34.05	231	308	Peak
5700	86.35	77.22			34.59	8.64	34.1	231	308	Average
5700	94.65	85.52			34.59	8.64	34.1	231	308	Peak
5725	61.86	52.7	68.2	-6.34	34.62	8.65	34.11	230	308	Peak
ANTENNA POLARITY & TEST DISTANCE: VERTICAL AT 3 M										
FREQ. (MHz)	EMISSION LEVEL (dBuV/m)	READ LEVEL (dBuV)	LIMIT (dBuV/m)	MARGIN (dB)	ANTENNA FACTOR (dB/m)	CABLE LOSS (dB)	PREAMP FACTOR (dB)	ANTENNA HEIGHT (cm)	TABLE ANGLE (Degree)	REMARK
5458	42.57	33.75	54	-11.43	34.36	8.51	34.05	106	187	Average
5458	57.41	48.59	74	-16.59	34.36	8.51	34.05	106	187	Peak
5470	55.67	46.84	68.2	-12.53	34.37	8.51	34.05	106	187	Peak
5700	82.83	73.7			34.59	8.64	34.1	106	187	Average
5700	90.56	81.43			34.59	8.64	34.1	106	187	Peak
5725	54.94	45.78	68.2	-13.26	34.62	8.65	34.11	106	187	Peak

REMARKS:

- Emission Level = Read Level + Antenna Factor + Cable Loss - Preamp Factor
Margin value = Emission level – Limit value
- 5700MHz: Fundamental frequency.
- 5470MHz & 5725MHz: Out of restricted band

EUT TEST CONDITION		MEASUREMENT DETAIL	
CHANNEL	Channel 149	FREQUENCY RANGE	1GHz ~ 40GHz
INPUT POWER	120Vac, 60 Hz	DETECTOR FUNCTION	Peak (PK) Average (AV)
ENVIRONMENTAL CONDITIONS	25deg. C, 65%RH	TESTED BY	Charles Hsiao

ANTENNA POLARITY & TEST DISTANCE: HORIZONTAL AT 3 M										
FREQ. (MHz)	EMISSION LEVEL (dBuV/m)	READ LEVEL (dBuV)	LIMIT (dBuV/m)	MARGIN (dB)	ANTENNA FACTOR (dB/m)	CABLE LOSS (dB)	PREAMP FACTOR (dB)	ANTENNA HEIGHT (cm)	TABLE ANGLE (Degree)	REMARK
5714	65.88	56.73	68.2	-2.32	34.61	8.65	34.11	100	324	Peak
5724	75.72	66.56	78.2	-2.48	34.62	8.65	34.11	101	322	Peak
5745	86.16	76.97			34.64	8.66	34.11	100	324	Average
5745	94.61	85.42			34.64	8.66	34.11	100	324	Peak
5860	56.09	46.77	78.2	-22.11	34.76	8.7	34.14	100	324	Peak
5866	56	46.67	68.2	-12.2	34.76	8.71	34.14	100	324	Peak
ANTENNA POLARITY & TEST DISTANCE: VERTICAL AT 3 M										
FREQ. (MHz)	EMISSION LEVEL (dBuV/m)	READ LEVEL (dBuV)	LIMIT (dBuV/m)	MARGIN (dB)	ANTENNA FACTOR (dB/m)	CABLE LOSS (dB)	PREAMP FACTOR (dB)	ANTENNA HEIGHT (cm)	TABLE ANGLE (Degree)	REMARK
5714	64.28	55.13	68.2	-3.92	34.61	8.65	34.11	111	203	Peak
5722	74.99	65.83	78.2	-3.21	34.62	8.65	34.11	113	206	Peak
5745	84.83	75.64			34.64	8.66	34.11	111	203	Average
5745	93.15	83.96			34.64	8.66	34.11	111	203	Peak
5852	56.74	47.44	78.2	-21.46	34.74	8.7	34.14	111	203	Peak
5868	56.1	46.77	68.2	-12.1	34.76	8.71	34.14	111	203	Peak

REMARKS:

- Emission Level = Read Level + Antenna Factor + Cable Loss - Preamp Factor
Margin value = Emission level – Limit value
- 5745MHz: Fundamental frequency.
- 5714MHz & 5724MHz, 5860MHz & 5866MHz: Out of restricted band
5714MHz & 5722MHz, 5852MHz & 5868MHz: Out of restricted band

EUT TEST CONDITION		MEASUREMENT DETAIL	
CHANNEL	Channel 157	FREQUENCY RANGE	1GHz ~ 40GHz
INPUT POWER	120Vac, 60 Hz	DETECTOR FUNCTION	Peak (PK) Average (AV)
ENVIRONMENTAL CONDITIONS	25deg. C, 65%RH	TESTED BY	Charles Hsiao

ANTENNA POLARITY & TEST DISTANCE: HORIZONTAL AT 3 M										
FREQ. (MHz)	EMISSION LEVEL (dBuV/m)	READ LEVEL (dBuV)	LIMIT (dBuV/m)	MARGIN (dB)	ANTENNA FACTOR (dB/m)	CABLE LOSS (dB)	PREAMP FACTOR (dB)	ANTENNA HEIGHT (cm)	TABLE ANGLE (Degree)	REMARK
5710	56.67	47.52	68.2	-11.53	34.61	8.65	34.11	100	324	Peak
5716	56.09	46.94	78.2	-22.11	34.61	8.65	34.11	100	324	Peak
5785	85.92	76.69			34.68	8.68	34.13	100	324	Average
5785	94.26	85.03			34.68	8.68	34.13	100	324	Peak
5854	57.41	48.09	78.2	-20.79	34.76	8.7	34.14	100	324	Peak
5864	55.25	45.92	68.2	-12.95	34.76	8.71	34.14	100	324	Peak
ANTENNA POLARITY & TEST DISTANCE: VERTICAL AT 3 M										
FREQ. (MHz)	EMISSION LEVEL (dBuV/m)	READ LEVEL (dBuV)	LIMIT (dBuV/m)	MARGIN (dB)	ANTENNA FACTOR (dB/m)	CABLE LOSS (dB)	PREAMP FACTOR (dB)	ANTENNA HEIGHT (cm)	TABLE ANGLE (Degree)	REMARK
5708	56.24	47.09	68.2	-11.96	34.61	8.65	34.11	110	205	Peak
5720	56.47	47.31	78.2	-21.73	34.62	8.65	34.11	110	205	Peak
5785	85.88	76.65			34.68	8.68	34.13	110	205	Average
5785	93.89	84.66			34.68	8.68	34.13	110	205	Peak
5858	56.85	47.53	78.2	-21.35	34.76	8.7	34.14	110	205	Peak
5864	56.2	46.87	68.2	-12	34.76	8.71	34.14	110	205	Peak

REMARKS:

- Emission Level = Read Level + Antenna Factor + Cable Loss - Preamp Factor
Margin value = Emission level – Limit value
- 5785MHz: Fundamental frequency.
- 5710MHz & 5716MHz, 5854MHz & 5864MHz: Out of restricted band
5708MHz & 5720MHz, 5858MHz & 5864MHz: Out of restricted band

EUT TEST CONDITION		MEASUREMENT DETAIL	
CHANNEL	Channel 165	FREQUENCY RANGE	1GHz ~ 40GHz
INPUT POWER	120Vac, 60 Hz	DETECTOR FUNCTION	Peak (PK) Average (AV)
ENVIRONMENTAL CONDITIONS	25deg. C, 65%RH	TESTED BY	Charles Hsiao

ANTENNA POLARITY & TEST DISTANCE: HORIZONTAL AT 3 M

FREQ. (MHz)	EMISSION LEVEL (dBuV/m)	READ LEVEL (dBuV)	LIMIT (dBuV/m)	MARGIN (dB)	ANTENNA FACTOR (dB/m)	CABLE LOSS (dB)	PREAMP FACTOR (dB)	ANTENNA HEIGHT (cm)	TABLE ANGLE (Degree)	REMARK
5710	56.83	47.68	68.2	-11.37	34.61	8.65	34.11	105	324	Peak
5720	56.03	46.87	78.2	-22.17	34.62	8.65	34.11	105	324	Peak
5825	86.65	77.36			34.73	8.69	34.13	105	324	Average
5825	94.66	85.37			34.73	8.69	34.13	105	324	Peak
5850	70.52	61.22	78.2	-7.68	34.74	8.7	34.14	106	320	Peak
5864	60.87	51.54	68.2	-7.33	34.76	8.71	34.14	105	324	Peak

ANTENNA POLARITY & TEST DISTANCE: VERTICAL AT 3 M

FREQ. (MHz)	EMISSION LEVEL (dBuV/m)	READ LEVEL (dBuV)	LIMIT (dBuV/m)	MARGIN (dB)	ANTENNA FACTOR (dB/m)	CABLE LOSS (dB)	PREAMP FACTOR (dB)	ANTENNA HEIGHT (cm)	TABLE ANGLE (Degree)	REMARK
5710	55.94	46.79	68.2	-12.26	34.61	8.65	34.11	111	203	Peak
5724	55.99	46.83	78.2	-22.21	34.62	8.65	34.11	111	203	Peak
5825	84.97	75.68			34.73	8.69	34.13	111	203	Average
5825	93.32	84.03			34.73	8.69	34.13	111	203	Peak
5852	64.15	54.85	78.2	-14.05	34.74	8.7	34.14	111	203	Peak
5870	57.35	48.02	68.2	-10.85	34.76	8.71	34.14	111	203	Peak

REMARKS:

- Emission Level = Read Level + Antenna Factor + Cable Loss - Preamp Factor
Margin value = Emission level – Limit value
- 5825MHz: Fundamental frequency.
- 5710MHz & 5720MHz, 5850MHz & 5864MHz: Out of restricted band
5710MHz & 5724MHz, 5852MHz & 5870MHz: Out of restricted band

802.11n (20MHz)

EUT TEST CONDITION		MEASUREMENT DETAIL	
CHANNEL	Channel 36	FREQUENCY RANGE	1GHz ~ 40GHz
INPUT POWER	120Vac, 60 Hz	DETECTOR FUNCTION	Peak (PK) Average (AV)
ENVIRONMENTAL CONDITIONS	25deg. C, 65%RH	TESTED BY	Hwa Chiang

ANTENNA POLARITY & TEST DISTANCE: HORIZONTAL AT 3 M										
FREQ. (MHz)	EMISSION LEVEL (dBuV/m)	READ LEVEL (dBuV)	LIMIT (dBuV/m)	MARGIN (dB)	ANTENNA FACTOR (dB/m)	CABLE LOSS (dB)	PREAMP FACTOR (dB)	ANTENNA HEIGHT (cm)	TABLE ANGLE (Degree)	REMARK
5118	42.24	34.04	54	-11.76	34.09	8.1	33.99	243	44	Average
5118	57.24	49.04	74	-16.76	34.09	8.1	33.99	243	44	Peak
5180	78.12	69.81			34.15	8.16	34	243	44	Average
5180	86.59	78.28			34.15	8.16	34	243	44	Peak
5406	42.33	33.61	54	-11.67	34.32	8.44	34.04	243	44	Average
5406	57.22	48.5	74	-16.78	34.32	8.44	34.04	243	44	Peak
ANTENNA POLARITY & TEST DISTANCE: VERTICAL AT 3 M										
FREQ. (MHz)	EMISSION LEVEL (dBuV/m)	READ LEVEL (dBuV)	LIMIT (dBuV/m)	MARGIN (dB)	ANTENNA FACTOR (dB/m)	CABLE LOSS (dB)	PREAMP FACTOR (dB)	ANTENNA HEIGHT (cm)	TABLE ANGLE (Degree)	REMARK
5100	42.28	34.12	54	-11.72	34.08	8.07	33.99	101	168	Average
5100	57.64	49.48	74	-16.36	34.08	8.07	33.99	101	168	Peak
5180	77.51	69.2			34.15	8.16	34	101	168	Average
5180	85.88	77.57			34.15	8.16	34	101	168	Peak
5450	42.55	33.73	54	-11.45	34.36	8.51	34.05	101	168	Average
5450	58.14	49.32	74	-15.86	34.36	8.51	34.05	101	168	Peak

REMARKS:

- Emission Level = Read Level + Antenna Factor + Cable Loss - Preamp Factor
Margin value = Emission level – Limit value
- 5180MHz: Fundamental frequency.

EUT TEST CONDITION		MEASUREMENT DETAIL	
CHANNEL	Channel 44	FREQUENCY RANGE	1GHz ~ 40GHz
INPUT POWER	120Vac, 60 Hz	DETECTOR FUNCTION	Peak (PK) Average (AV)
ENVIRONMENTAL CONDITIONS	25deg. C, 65%RH	TESTED BY	Hwa Chiang

ANTENNA POLARITY & TEST DISTANCE: HORIZONTAL AT 3 M										
FREQ. (MHz)	EMISSION LEVEL (dBuV/m)	READ LEVEL (dBuV)	LIMIT (dBuV/m)	MARGIN (dB)	ANTENNA FACTOR (dB/m)	CABLE LOSS (dB)	PREAMP FACTOR (dB)	ANTENNA HEIGHT (cm)	TABLE ANGLE (Degree)	REMARK
5124	42.23	34.01	54	-11.77	34.11	8.1	33.99	244	44	Average
5124	57.22	49	74	-16.78	34.11	8.1	33.99	244	44	Peak
5220	79.83	71.44			34.17	8.22	34	244	44	Average
5220	87.93	79.54			34.17	8.22	34	244	44	Peak
5450	42.56	33.74	54	-11.44	34.36	8.51	34.05	244	44	Average
5450	58.26	49.44	74	-15.74	34.36	8.51	34.05	244	44	Peak
ANTENNA POLARITY & TEST DISTANCE: VERTICAL AT 3 M										
FREQ. (MHz)	EMISSION LEVEL (dBuV/m)	READ LEVEL (dBuV)	LIMIT (dBuV/m)	MARGIN (dB)	ANTENNA FACTOR (dB/m)	CABLE LOSS (dB)	PREAMP FACTOR (dB)	ANTENNA HEIGHT (cm)	TABLE ANGLE (Degree)	REMARK
5042	42	33.94	54	-12	34.04	8	33.98	101	193	Average
5042	56.83	48.77	74	-17.17	34.04	8	33.98	101	193	Peak
5220	79.33	70.94			34.17	8.22	34	101	193	Average
5220	86.85	78.46			34.17	8.22	34	101	193	Peak
5362	42.37	33.73	54	-11.63	34.29	8.38	34.03	101	193	Average
5362	57.11	48.47	74	-16.89	34.29	8.38	34.03	101	193	Peak

REMARKS:

- Emission Level = Read Level + Antenna Factor + Cable Loss - Preamp Factor
Margin value = Emission level – Limit value
- 5220MHz: Fundamental frequency.

EUT TEST CONDITION		MEASUREMENT DETAIL	
CHANNEL	Channel 48	FREQUENCY RANGE	1GHz ~ 40GHz
INPUT POWER	120Vac, 60 Hz	DETECTOR FUNCTION	Peak (PK) Average (AV)
ENVIRONMENTAL CONDITIONS	25deg. C, 65%RH	TESTED BY	Hwa Chiang

ANTENNA POLARITY & TEST DISTANCE: HORIZONTAL AT 3 M										
FREQ. (MHz)	EMISSION LEVEL (dBuV/m)	READ LEVEL (dBuV)	LIMIT (dBuV/m)	MARGIN (dB)	ANTENNA FACTOR (dB/m)	CABLE LOSS (dB)	PREAMP FACTOR (dB)	ANTENNA HEIGHT (cm)	TABLE ANGLE (Degree)	REMARK
5070	42.06	33.96	54	-11.94	34.05	8.03	33.98	245	46	Average
5070	57.23	49.13	74	-16.77	34.05	8.03	33.98	245	46	Peak
5240	79.36	70.92			34.19	8.26	34.01	245	46	Average
5240	87.28	78.84			34.19	8.26	34.01	245	46	Peak
5432	42.47	33.68	54	-11.53	34.35	8.48	34.04	245	46	Average
5432	57.52	48.73	74	-16.48	34.35	8.48	34.04	245	46	Peak
ANTENNA POLARITY & TEST DISTANCE: VERTICAL AT 3 M										
FREQ. (MHz)	EMISSION LEVEL (dBuV/m)	READ LEVEL (dBuV)	LIMIT (dBuV/m)	MARGIN (dB)	ANTENNA FACTOR (dB/m)	CABLE LOSS (dB)	PREAMP FACTOR (dB)	ANTENNA HEIGHT (cm)	TABLE ANGLE (Degree)	REMARK
5148	42.38	34.13	54	-11.62	34.12	8.13	34	100	163	Average
5148	57.2	48.95	74	-16.8	34.12	8.13	34	100	163	Peak
5240	78.61	70.17			34.19	8.26	34.01	100	163	Average
5240	86.28	77.84			34.19	8.26	34.01	100	163	Peak
5386	42.78	34.1	54	-11.22	34.31	8.41	34.04	100	163	Average
5386	57.12	48.44	74	-16.88	34.31	8.41	34.04	100	163	Peak

REMARKS:

- Emission Level = Read Level + Antenna Factor + Cable Loss - Preamp Factor
Margin value = Emission level – Limit value
- 5240MHz: Fundamental frequency.

EUT TEST CONDITION		MEASUREMENT DETAIL	
CHANNEL	Channel 52	FREQUENCY RANGE	1GHz ~ 40GHz
INPUT POWER	120Vac, 60 Hz	DETECTOR FUNCTION	Peak (PK) Average (AV)
ENVIRONMENTAL CONDITIONS	25deg. C, 65%RH	TESTED BY	Charles Hsiao

ANTENNA POLARITY & TEST DISTANCE: HORIZONTAL AT 3 M										
FREQ. (MHz)	EMISSION LEVEL (dBuV/m)	READ LEVEL (dBuV)	LIMIT (dBuV/m)	MARGIN (dB)	ANTENNA FACTOR (dB/m)	CABLE LOSS (dB)	PREAMP FACTOR (dB)	ANTENNA HEIGHT (cm)	TABLE ANGLE (Degree)	REMARK
5134	42.31	34.06	54	-11.69	34.11	8.13	33.99	251	321	Average
5134	56.05	47.8	74	-17.95	34.11	8.13	33.99	251	321	Peak
5260	80.39	71.93			34.21	8.26	34.01	251	321	Average
5260	88.87	80.41			34.21	8.26	34.01	251	321	Peak
5430	42.52	33.73	54	-11.48	34.35	8.48	34.04	251	321	Average
5430	56.78	47.99	74	-17.22	34.35	8.48	34.04	251	321	Peak
ANTENNA POLARITY & TEST DISTANCE: VERTICAL AT 3 M										
FREQ. (MHz)	EMISSION LEVEL (dBuV/m)	READ LEVEL (dBuV)	LIMIT (dBuV/m)	MARGIN (dB)	ANTENNA FACTOR (dB/m)	CABLE LOSS (dB)	PREAMP FACTOR (dB)	ANTENNA HEIGHT (cm)	TABLE ANGLE (Degree)	REMARK
5060	42.25	34.15	54	-11.75	34.05	8.03	33.98	100	198	Average
5060	56.86	48.76	74	-17.14	34.05	8.03	33.98	100	198	Peak
5260	78.94	70.48			34.21	8.26	34.01	100	198	Average
5260	87.25	78.79			34.21	8.26	34.01	100	198	Peak
5364	42.34	33.7	54	-11.66	34.29	8.38	34.03	100	198	Average
5364	57.6	48.96	74	-16.4	34.29	8.38	34.03	100	198	Peak

REMARKS:

- Emission Level = Read Level + Antenna Factor + Cable Loss - Preamp Factor
Margin value = Emission level – Limit value
- 5260MHz: Fundamental frequency.

EUT TEST CONDITION		MEASUREMENT DETAIL	
CHANNEL	Channel 60	FREQUENCY RANGE	1GHz ~ 40GHz
INPUT POWER	120Vac, 60 Hz	DETECTOR FUNCTION	Peak (PK) Average (AV)
ENVIRONMENTAL CONDITIONS	25deg. C, 65%RH	TESTED BY	Charles Hsiao

ANTENNA POLARITY & TEST DISTANCE: HORIZONTAL AT 3 M										
FREQ. (MHz)	EMISSION LEVEL (dBuV/m)	READ LEVEL (dBuV)	LIMIT (dBuV/m)	MARGIN (dB)	ANTENNA FACTOR (dB/m)	CABLE LOSS (dB)	PREAMP FACTOR (dB)	ANTENNA HEIGHT (cm)	TABLE ANGLE (Degree)	REMARK
5146	42.43	34.18	54	-11.57	34.12	8.13	34	251	321	Average
5146	57.27	49.02	74	-16.73	34.12	8.13	34	251	321	Peak
5300	80.1	71.56			34.24	8.32	34.02	251	321	Average
5300	88.23	79.69			34.24	8.32	34.02	251	321	Peak
5460	38.99	30.17	54	-15.01	34.36	8.51	34.05	251	321	Average
5460	57.68	48.86	74	-16.32	34.36	8.51	34.05	251	321	Peak
ANTENNA POLARITY & TEST DISTANCE: VERTICAL AT 3 M										
FREQ. (MHz)	EMISSION LEVEL (dBuV/m)	READ LEVEL (dBuV)	LIMIT (dBuV/m)	MARGIN (dB)	ANTENNA FACTOR (dB/m)	CABLE LOSS (dB)	PREAMP FACTOR (dB)	ANTENNA HEIGHT (cm)	TABLE ANGLE (Degree)	REMARK
5054	41.93	33.87	54	-12.07	34.04	8	33.98	100	198	Average
5054	57.57	49.51	74	-16.43	34.04	8	33.98	100	198	Peak
5300	79.26	70.72			34.24	8.32	34.02	100	198	Average
5300	87.06	78.52			34.24	8.32	34.02	100	198	Peak
5394	42.39	33.68	54	-11.61	34.31	8.44	34.04	100	198	Average
5394	57.28	48.57	74	-16.72	34.31	8.44	34.04	100	198	Peak

REMARKS:

- Emission Level = Read Level + Antenna Factor + Cable Loss - Preamp Factor
Margin value = Emission level – Limit value
- 5300MHz: Fundamental frequency.

EUT TEST CONDITION		MEASUREMENT DETAIL	
CHANNEL	Channel 64	FREQUENCY RANGE	1GHz ~ 40GHz
INPUT POWER	120Vac, 60 Hz	DETECTOR FUNCTION	Peak (PK) Average (AV)
ENVIRONMENTAL CONDITIONS	25deg. C, 65%RH	TESTED BY	Charles Hsiao

ANTENNA POLARITY & TEST DISTANCE: HORIZONTAL AT 3 M										
FREQ. (MHz)	EMISSION LEVEL (dBuV/m)	READ LEVEL (dBuV)	LIMIT (dBuV/m)	MARGIN (dB)	ANTENNA FACTOR (dB/m)	CABLE LOSS (dB)	PREAMP FACTOR (dB)	ANTENNA HEIGHT (cm)	TABLE ANGLE (Degree)	REMARK
5054	41.98	33.92	54	-12.02	34.04	8	33.98	242	321	Average
5054	56.35	48.29	74	-17.65	34.04	8	33.98	242	321	Peak
5320	78.2	69.62			34.25	8.35	34.02	242	321	Average
5320	86.27	77.69			34.25	8.35	34.02	242	321	Peak
5438	42.52	33.73	54	-11.48	34.35	8.48	34.04	242	321	Average
5438	56.84	48.05	74	-17.16	34.35	8.48	34.04	242	321	Peak
ANTENNA POLARITY & TEST DISTANCE: VERTICAL AT 3 M										
FREQ. (MHz)	EMISSION LEVEL (dBuV/m)	READ LEVEL (dBuV)	LIMIT (dBuV/m)	MARGIN (dB)	ANTENNA FACTOR (dB/m)	CABLE LOSS (dB)	PREAMP FACTOR (dB)	ANTENNA HEIGHT (cm)	TABLE ANGLE (Degree)	REMARK
5082	42.22	34.06	54	-11.78	34.07	8.07	33.98	100	198	Average
5082	56.84	48.68	74	-17.16	34.07	8.07	33.98	100	198	Peak
5320	77.1	68.52			34.25	8.35	34.02	100	198	Average
5320	85.29	76.71			34.25	8.35	34.02	100	198	Peak
5454	42.57	33.75	54	-11.43	34.36	8.51	34.05	100	198	Average
5454	57.12	48.3	74	-16.88	34.36	8.51	34.05	100	198	Peak

REMARKS:

- Emission Level = Read Level + Antenna Factor + Cable Loss - Preamp Factor
Margin value = Emission level – Limit value
- 5320MHz: Fundamental frequency.

EUT TEST CONDITION		MEASUREMENT DETAIL	
CHANNEL	Channel 100	FREQUENCY RANGE	1GHz ~ 40GHz
INPUT POWER	120Vac, 60 Hz	DETECTOR FUNCTION	Peak (PK) Average (AV)
ENVIRONMENTAL CONDITIONS	25deg. C, 65%RH	TESTED BY	Charles Hsiao

ANTENNA POLARITY & TEST DISTANCE: HORIZONTAL AT 3 M										
FREQ. (MHz)	EMISSION LEVEL (dBuV/m)	READ LEVEL (dBuV)	LIMIT (dBuV/m)	MARGIN (dB)	ANTENNA FACTOR (dB/m)	CABLE LOSS (dB)	PREAMP FACTOR (dB)	ANTENNA HEIGHT (cm)	TABLE ANGLE (Degree)	REMARK
5432	42.52	33.73	54	-11.48	34.35	8.48	34.04	229	303	Average
5432	57.55	48.76	74	-16.45	34.35	8.48	34.04	229	303	Peak
5470	55.41	46.58	68.2	-12.79	34.37	8.51	34.05	229	303	Peak
5500	86.97	78.05			34.4	8.57	34.05	229	303	Average
5500	94.86	85.94			34.4	8.57	34.05	229	303	Peak
5725	55.21	46.05	68.2	-12.99	34.62	8.65	34.11	229	303	Peak
ANTENNA POLARITY & TEST DISTANCE: VERTICAL AT 3 M										
FREQ. (MHz)	EMISSION LEVEL (dBuV/m)	READ LEVEL (dBuV)	LIMIT (dBuV/m)	MARGIN (dB)	ANTENNA FACTOR (dB/m)	CABLE LOSS (dB)	PREAMP FACTOR (dB)	ANTENNA HEIGHT (cm)	TABLE ANGLE (Degree)	REMARK
5422	42.31	33.54	54	-11.69	34.33	8.48	34.04	103	208	Average
5422	57.18	48.41	74	-16.82	34.33	8.48	34.04	103	208	Peak
5470	55.52	46.69	68.2	-12.68	34.37	8.51	34.05	103	208	Peak
5500	81.87	72.95			34.4	8.57	34.05	103	208	Average
5500	90.23	81.31			34.4	8.57	34.05	103	208	Peak
5725	55.69	46.53	68.2	-12.51	34.62	8.65	34.11	103	208	Peak

REMARKS:

- Emission Level = Read Level + Antenna Factor + Cable Loss - Preamp Factor
Margin value = Emission level – Limit value
- 5500MHz: Fundamental frequency.
- 5470MHz & 5725MHz: Out of restricted band

EUT TEST CONDITION		MEASUREMENT DETAIL	
CHANNEL	Channel 116	FREQUENCY RANGE	1GHz ~ 40GHz
INPUT POWER	120Vac, 60 Hz	DETECTOR FUNCTION	Peak (PK) Average (AV)
ENVIRONMENTAL CONDITIONS	25deg. C, 65%RH	TESTED BY	Charles Hsiao

ANTENNA POLARITY & TEST DISTANCE: HORIZONTAL AT 3 M										
FREQ. (MHz)	EMISSION LEVEL (dBuV/m)	READ LEVEL (dBuV)	LIMIT (dBuV/m)	MARGIN (dB)	ANTENNA FACTOR (dB/m)	CABLE LOSS (dB)	PREAMP FACTOR (dB)	ANTENNA HEIGHT (cm)	TABLE ANGLE (Degree)	REMARK
5432	42.52	33.73	54	-11.48	34.35	8.48	34.04	229	306	Average
5432	57.37	48.58	74	-16.63	34.35	8.48	34.04	229	306	Peak
5470	55.2	46.37	68.2	-13	34.37	8.51	34.05	229	306	Peak
5580	88.77	79.78			34.47	8.6	34.08	229	306	Average
5580	96.27	87.28			34.47	8.6	34.08	229	306	Peak
5725	54.86	45.7	68.2	-13.34	34.62	8.65	34.11	229	306	Peak
ANTENNA POLARITY & TEST DISTANCE: VERTICAL AT 3 M										
FREQ. (MHz)	EMISSION LEVEL (dBuV/m)	READ LEVEL (dBuV)	LIMIT (dBuV/m)	MARGIN (dB)	ANTENNA FACTOR (dB/m)	CABLE LOSS (dB)	PREAMP FACTOR (dB)	ANTENNA HEIGHT (cm)	TABLE ANGLE (Degree)	REMARK
5456	42.67	33.85	54	-11.33	34.36	8.51	34.05	101	209	Average
5456	57.22	48.4	74	-16.78	34.36	8.51	34.05	101	209	Peak
5470	55.8	46.97	68.2	-12.4	34.37	8.51	34.05	101	209	Peak
5580	84.49	75.5			34.47	8.6	34.08	101	209	Average
5580	92.69	83.7			34.47	8.6	34.08	101	209	Peak
5725	55.57	46.41	68.2	-12.63	34.62	8.65	34.11	101	209	Peak

REMARKS:

- Emission Level = Read Level + Antenna Factor + Cable Loss - Preamp Factor
Margin value = Emission level – Limit value
- 5580MHz: Fundamental frequency.
- 5470MHz & 5725MHz: Out of restricted band

EUT TEST CONDITION		MEASUREMENT DETAIL	
CHANNEL	Channel 140	FREQUENCY RANGE	1GHz ~ 40GHz
INPUT POWER	120Vac, 60 Hz	DETECTOR FUNCTION	Peak (PK) Average (AV)
ENVIRONMENTAL CONDITIONS	25deg. C, 65%RH	TESTED BY	Charles Hsiao

ANTENNA POLARITY & TEST DISTANCE: HORIZONTAL AT 3 M										
FREQ. (MHz)	EMISSION LEVEL (dBuV/m)	READ LEVEL (dBuV)	LIMIT (dBuV/m)	MARGIN (dB)	ANTENNA FACTOR (dB/m)	CABLE LOSS (dB)	PREAMP FACTOR (dB)	ANTENNA HEIGHT (cm)	TABLE ANGLE (Degree)	REMARK
5436	42.42	33.63	54	-11.58	34.35	8.48	34.04	231	308	Average
5436	58.21	49.42	74	-15.79	34.35	8.48	34.04	231	308	Peak
5470	56.52	47.69	68.2	-11.68	34.37	8.51	34.05	231	308	Peak
5700	84.83	75.7			34.59	8.64	34.1	231	308	Average
5700	92.84	83.71			34.59	8.64	34.1	231	308	Peak
5725	55.39	46.23	68.2	-12.81	34.62	8.65	34.11	231	308	Peak
ANTENNA POLARITY & TEST DISTANCE: VERTICAL AT 3 M										
FREQ. (MHz)	EMISSION LEVEL (dBuV/m)	READ LEVEL (dBuV)	LIMIT (dBuV/m)	MARGIN (dB)	ANTENNA FACTOR (dB/m)	CABLE LOSS (dB)	PREAMP FACTOR (dB)	ANTENNA HEIGHT (cm)	TABLE ANGLE (Degree)	REMARK
5444	42.52	33.73	54	-11.48	34.35	8.48	34.04	106	187	Average
5444	57.35	48.56	74	-16.65	34.35	8.48	34.04	106	187	Peak
5470	57.88	49.05	68.2	-10.32	34.37	8.51	34.05	106	187	Peak
5700	80.23	71.1			34.59	8.64	34.1	106	187	Average
5700	88.06	78.93			34.59	8.64	34.1	106	187	Peak
5725	56.2	47.04	68.2	-12	34.62	8.65	34.11	106	187	Peak

REMARKS:

- Emission Level = Read Level + Antenna Factor + Cable Loss - Preamp Factor
Margin value = Emission level – Limit value
- 5700MHz: Fundamental frequency.
- 5470MHz & 5725MHz: Out of restricted band

EUT TEST CONDITION		MEASUREMENT DETAIL	
CHANNEL	Channel 149	FREQUENCY RANGE	1GHz ~ 40GHz
INPUT POWER	120Vac, 60 Hz	DETECTOR FUNCTION	Peak (PK) Average (AV)
ENVIRONMENTAL CONDITIONS	25deg. C, 65%RH	TESTED BY	Charles Hsiao

ANTENNA POLARITY & TEST DISTANCE: HORIZONTAL AT 3 M										
FREQ. (MHz)	EMISSION LEVEL (dBuV/m)	READ LEVEL (dBuV)	LIMIT (dBuV/m)	MARGIN (dB)	ANTENNA FACTOR (dB/m)	CABLE LOSS (dB)	PREAMP FACTOR (dB)	ANTENNA HEIGHT (cm)	TABLE ANGLE (Degree)	REMARK
5712	66.4	57.25	68.2	-1.8	34.61	8.65	34.11	101	323	Peak
5724	75.7	66.54	78.2	-2.5	34.62	8.65	34.11	102	322	Peak
5745	86.83	77.64			34.64	8.66	34.11	100	324	Average
5745	95.3	86.11			34.64	8.66	34.11	100	324	Peak
5854	56.13	46.81	78.2	-22.07	34.76	8.7	34.14	100	324	Peak
5862	55.93	46.6	68.2	-12.27	34.76	8.71	34.14	100	324	Peak
ANTENNA POLARITY & TEST DISTANCE: VERTICAL AT 3 M										
FREQ. (MHz)	EMISSION LEVEL (dBuV/m)	READ LEVEL (dBuV)	LIMIT (dBuV/m)	MARGIN (dB)	ANTENNA FACTOR (dB/m)	CABLE LOSS (dB)	PREAMP FACTOR (dB)	ANTENNA HEIGHT (cm)	TABLE ANGLE (Degree)	REMARK
5712	66.55	57.4	68.2	-1.65	34.61	8.65	34.11	106	187	Peak
5724	75.95	66.79	78.2	-2.25	34.62	8.65	34.11	104	180	Peak
5745	86.54	77.35			34.64	8.66	34.11	105	179	Average
5745	94.14	84.95			34.64	8.66	34.11	105	179	Peak
5856	55.63	46.31	78.2	-22.57	34.76	8.7	34.14	105	179	Peak
5864	56.26	46.93	68.2	-11.94	34.76	8.71	34.14	105	179	Peak

REMARKS:

- Emission Level = Read Level + Antenna Factor + Cable Loss - Preamp Factor
Margin value = Emission level – Limit value
- 5745MHz: Fundamental frequency.
- 5712MHz & 5724MHz, 5854MHz & 5862MHz: Out of restricted band
5712MHz & 5724MHz, 5856MHz & 5864MHz: Out of restricted band

EUT TEST CONDITION		MEASUREMENT DETAIL	
CHANNEL	Channel 157	FREQUENCY RANGE	1GHz ~ 40GHz
INPUT POWER	120Vac, 60 Hz	DETECTOR FUNCTION	Peak (PK) Average (AV)
ENVIRONMENTAL CONDITIONS	25deg. C, 65%RH	TESTED BY	Charles Hsiao

ANTENNA POLARITY & TEST DISTANCE: HORIZONTAL AT 3 M										
FREQ. (MHz)	EMISSION LEVEL (dBuV/m)	READ LEVEL (dBuV)	LIMIT (dBuV/m)	MARGIN (dB)	ANTENNA FACTOR (dB/m)	CABLE LOSS (dB)	PREAMP FACTOR (dB)	ANTENNA HEIGHT (cm)	TABLE ANGLE (Degree)	REMARK
5710	57.49	48.34	68.2	-10.71	34.61	8.65	34.11	105	324	Peak
5724	56.65	47.49	78.2	-21.55	34.62	8.65	34.11	105	324	Peak
5785	85.88	76.65			34.68	8.68	34.13	105	324	Average
5785	94.04	84.81			34.68	8.68	34.13	105	324	Peak
5858	57.94	48.62	78.2	-20.26	34.76	8.7	34.14	105	324	Peak
5862	57.56	48.23	68.2	-10.64	34.76	8.71	34.14	105	324	Peak

ANTENNA POLARITY & TEST DISTANCE: VERTICAL AT 3 M										
FREQ. (MHz)	EMISSION LEVEL (dBuV/m)	READ LEVEL (dBuV)	LIMIT (dBuV/m)	MARGIN (dB)	ANTENNA FACTOR (dB/m)	CABLE LOSS (dB)	PREAMP FACTOR (dB)	ANTENNA HEIGHT (cm)	TABLE ANGLE (Degree)	REMARK
5712	56.08	46.93	68.2	-12.12	34.61	8.65	34.11	110	179	Peak
5724	56.61	47.45	78.2	-21.59	34.62	8.65	34.11	110	179	Peak
5785	85.59	76.36			34.68	8.68	34.13	110	179	Average
5785	93.93	84.7			34.68	8.68	34.13	110	179	Peak
5858	57.33	48.01	78.2	-20.87	34.76	8.7	34.14	110	179	Peak
5868	56.47	47.14	68.2	-11.73	34.76	8.71	34.14	110	179	Peak

REMARKS:

- Emission Level = Read Level + Antenna Factor + Cable Loss - Preamp Factor
Margin value = Emission level – Limit value
- 5785MHz: Fundamental frequency.
- 5710MHz & 5724MHz, 5858MHz & 5862MHz: Out of restricted band
5712MHz & 5724MHz, 5858MHz & 5868MHz: Out of restricted band

EUT TEST CONDITION		MEASUREMENT DETAIL	
CHANNEL	Channel 165	FREQUENCY RANGE	1GHz ~ 40GHz
INPUT POWER	120Vac, 60 Hz	DETECTOR FUNCTION	Peak (PK) Average (AV)
ENVIRONMENTAL CONDITIONS	25deg. C, 65%RH	TESTED BY	Charles Hsiao

ANTENNA POLARITY & TEST DISTANCE: HORIZONTAL AT 3 M										
FREQ. (MHz)	EMISSION LEVEL (dBuV/m)	READ LEVEL (dBuV)	LIMIT (dBuV/m)	MARGIN (dB)	ANTENNA FACTOR (dB/m)	CABLE LOSS (dB)	PREAMP FACTOR (dB)	ANTENNA HEIGHT (cm)	TABLE ANGLE (Degree)	REMARK
5708	55.93	46.78	68.2	-12.27	34.61	8.65	34.11	105	324	Peak
5722	55.74	46.58	78.2	-22.46	34.62	8.65	34.11	105	324	Peak
5825	86.94	77.65			34.73	8.69	34.13	105	324	Average
5825	94.7	85.41			34.73	8.69	34.13	105	324	Peak
5850	73.5	64.2	78.2	-4.7	34.74	8.7	34.14	105	327	Peak
5862	61.2	51.87	68.2	-7	34.76	8.71	34.14	105	324	Peak
ANTENNA POLARITY & TEST DISTANCE: VERTICAL AT 3 M										
FREQ. (MHz)	EMISSION LEVEL (dBuV/m)	READ LEVEL (dBuV)	LIMIT (dBuV/m)	MARGIN (dB)	ANTENNA FACTOR (dB/m)	CABLE LOSS (dB)	PREAMP FACTOR (dB)	ANTENNA HEIGHT (cm)	TABLE ANGLE (Degree)	REMARK
5714	56.38	47.23	68.2	-11.82	34.61	8.65	34.11	109	203	Peak
5722	55.7	46.54	78.2	-22.5	34.62	8.65	34.11	109	203	Peak
5825	85.55	76.26			34.73	8.69	34.13	109	203	Average
5825	93.35	84.06			34.73	8.69	34.13	109	203	Peak
5850	73.12	63.82	78.2	-5.08	34.74	8.7	34.14	110	205	Peak
5862	61.52	52.19	68.2	-6.68	34.76	8.71	34.14	109	203	Peak

REMARKS:

- Emission Level = Read Level + Antenna Factor + Cable Loss - Preamp Factor
Margin value = Emission level – Limit value
- 5825MHz: Fundamental frequency.
- 5708MHz & 5722MHz, 5850MHz & 5862MHz: Out of restricted band
5714MHz & 5722MHz, 5850MHz & 5862MHz: Out of restricted band

802.11n (40MHz)

EUT TEST CONDITION		MEASUREMENT DETAIL	
CHANNEL	Channel 38	FREQUENCY RANGE	1GHz ~ 40GHz
INPUT POWER	120Vac, 60 Hz	DETECTOR FUNCTION	Peak (PK) Average (AV)
ENVIRONMENTAL CONDITIONS	25deg. C, 65%RH	TESTED BY	Hwa Chiang

ANTENNA POLARITY & TEST DISTANCE: HORIZONTAL AT 3 M										
FREQ. (MHz)	EMISSION LEVEL (dBuV/m)	READ LEVEL (dBuV)	LIMIT (dBuV/m)	MARGIN (dB)	ANTENNA FACTOR (dB/m)	CABLE LOSS (dB)	PREAMP FACTOR (dB)	ANTENNA HEIGHT (cm)	TABLE ANGLE (Degree)	REMARK
5054	42.51	34.45	54	-11.49	34.04	8	33.98	238	44	Average
5054	56.6	48.54	74	-17.4	34.04	8	33.98	238	44	Peak
5190	73.11	64.77			34.15	8.19	34	238	44	Average
5190	81.18	72.84			34.15	8.19	34	238	44	Peak
5444	42.97	34.18	54	-11.03	34.35	8.48	34.04	238	44	Average
5444	57.58	48.79	74	-16.42	34.35	8.48	34.04	238	44	Peak
5054	42.51	34.45	54	-11.49	34.04	8	33.98	238	44	Average
ANTENNA POLARITY & TEST DISTANCE: VERTICAL AT 3 M										
FREQ. (MHz)	EMISSION LEVEL (dBuV/m)	READ LEVEL (dBuV)	LIMIT (dBuV/m)	MARGIN (dB)	ANTENNA FACTOR (dB/m)	CABLE LOSS (dB)	PREAMP FACTOR (dB)	ANTENNA HEIGHT (cm)	TABLE ANGLE (Degree)	REMARK
5092	42.47	34.3	54	-11.53	34.08	8.07	33.98	101	179	Average
5092	57.14	48.97	74	-16.86	34.08	8.07	33.98	101	179	Peak
5190	72.86	64.52			34.15	8.19	34	101	179	Average
5190	80.48	72.14			34.15	8.19	34	101	179	Peak
5382	42.84	34.16	54	-11.16	34.31	8.41	34.04	101	179	Average
5382	58.09	49.41	74	-15.91	34.31	8.41	34.04	101	179	Peak
5092	42.47	34.3	54	-11.53	34.08	8.07	33.98	101	179	Average

REMARKS:

- Emission Level = Read Level + Antenna Factor + Cable Loss - Preamp Factor
Margin value = Emission level – Limit value
- 5190MHz: Fundamental frequency.

EUT TEST CONDITION		MEASUREMENT DETAIL	
CHANNEL	Channel 46	FREQUENCY RANGE	1GHz ~ 40GHz
INPUT POWER	120Vac, 60 Hz	DETECTOR FUNCTION	Peak (PK) Average (AV)
ENVIRONMENTAL CONDITIONS	25deg. C, 65%RH	TESTED BY	Hwa Chiang

ANTENNA POLARITY & TEST DISTANCE: HORIZONTAL AT 3 M										
FREQ. (MHz)	EMISSION LEVEL (dBuV/m)	READ LEVEL (dBuV)	LIMIT (dBuV/m)	MARGIN (dB)	ANTENNA FACTOR (dB/m)	CABLE LOSS (dB)	PREAMP FACTOR (dB)	ANTENNA HEIGHT (cm)	TABLE ANGLE (Degree)	REMARK
5090	42.55	34.38	54	-11.45	34.08	8.07	33.98	239	318	Average
5090	56.75	48.58	74	-17.25	34.08	8.07	33.98	239	318	Peak
5230	79.41	71.01			34.19	8.22	34.01	239	318	Average
5230	87.42	79.02			34.19	8.22	34.01	239	318	Peak
5396	43.05	34.33	54	-10.95	34.32	8.44	34.04	239	318	Average
5396	57.22	48.5	74	-16.78	34.32	8.44	34.04	239	318	Peak
ANTENNA POLARITY & TEST DISTANCE: VERTICAL AT 3 M										
FREQ. (MHz)	EMISSION LEVEL (dBuV/m)	READ LEVEL (dBuV)	LIMIT (dBuV/m)	MARGIN (dB)	ANTENNA FACTOR (dB/m)	CABLE LOSS (dB)	PREAMP FACTOR (dB)	ANTENNA HEIGHT (cm)	TABLE ANGLE (Degree)	REMARK
5104	42.51	34.35	54	-11.49	34.08	8.07	33.99	100	253	Average
5104	56.65	48.49	74	-17.35	34.08	8.07	33.99	100	253	Peak
5230	79.02	70.62			34.19	8.22	34.01	100	253	Average
5230	86.27	77.87			34.19	8.22	34.01	100	253	Peak
5452	42.99	34.17	54	-11.01	34.36	8.51	34.05	100	253	Average
5452	58.03	49.21	74	-15.97	34.36	8.51	34.05	100	253	Peak

REMARKS:

- Emission Level = Read Level + Antenna Factor + Cable Loss - Preamp Factor
Margin value = Emission level – Limit value
- 5230MHz: Fundamental frequency.

EUT TEST CONDITION		MEASUREMENT DETAIL	
CHANNEL	Channel 54	FREQUENCY RANGE	1GHz ~ 40GHz
INPUT POWER	120Vac, 60 Hz	DETECTOR FUNCTION	Peak (PK) Average (AV)
ENVIRONMENTAL CONDITIONS	25deg. C, 65%RH	TESTED BY	Charles Hsiao

ANTENNA POLARITY & TEST DISTANCE: HORIZONTAL AT 3 M										
FREQ. (MHz)	EMISSION LEVEL (dBuV/m)	READ LEVEL (dBuV)	LIMIT (dBuV/m)	MARGIN (dB)	ANTENNA FACTOR (dB/m)	CABLE LOSS (dB)	PREAMP FACTOR (dB)	ANTENNA HEIGHT (cm)	TABLE ANGLE (Degree)	REMARK
5078	42.45	34.33	54	-11.55	34.07	8.03	33.98	245	321	Average
5078	55.94	47.82	74	-18.06	34.07	8.03	33.98	245	321	Peak
5270	80.4	71.91			34.21	8.29	34.01	245	321	Average
5270	87.97	79.48			34.21	8.29	34.01	245	321	Peak
5428	42.95	34.18	54	-11.05	34.33	8.48	34.04	245	321	Average
5428	57.17	48.4	74	-16.83	34.33	8.48	34.04	245	321	Peak
ANTENNA POLARITY & TEST DISTANCE: VERTICAL AT 3 M										
FREQ. (MHz)	EMISSION LEVEL (dBuV/m)	READ LEVEL (dBuV)	LIMIT (dBuV/m)	MARGIN (dB)	ANTENNA FACTOR (dB/m)	CABLE LOSS (dB)	PREAMP FACTOR (dB)	ANTENNA HEIGHT (cm)	TABLE ANGLE (Degree)	REMARK
5146	42.85	34.6	54	-11.15	34.12	8.13	34	100	198	Average
5146	56.39	48.14	74	-17.61	34.12	8.13	34	100	198	Peak
5270	78.05	69.56			34.21	8.29	34.01	100	198	Average
5270	86.37	77.88			34.21	8.29	34.01	100	198	Peak
5426	42.84	34.07	54	-11.16	34.33	8.48	34.04	100	198	Average
5426	57.09	48.32	74	-16.91	34.33	8.48	34.04	100	198	Peak

REMARKS:

- Emission Level = Read Level + Antenna Factor + Cable Loss - Preamp Factor
Margin value = Emission level – Limit value
- 5270MHz: Fundamental frequency.

EUT TEST CONDITION		MEASUREMENT DETAIL	
CHANNEL	Channel 62	FREQUENCY RANGE	1GHz ~ 40GHz
INPUT POWER	120Vac, 60 Hz	DETECTOR FUNCTION	Peak (PK) Average (AV)
ENVIRONMENTAL CONDITIONS	25deg. C, 65%RH	TESTED BY	Charles Hsiao

ANTENNA POLARITY & TEST DISTANCE: HORIZONTAL AT 3 M										
FREQ. (MHz)	EMISSION LEVEL (dBuV/m)	READ LEVEL (dBuV)	LIMIT (dBuV/m)	MARGIN (dB)	ANTENNA FACTOR (dB/m)	CABLE LOSS (dB)	PREAMP FACTOR (dB)	ANTENNA HEIGHT (cm)	TABLE ANGLE (Degree)	REMARK
5068	42.59	34.49	54	-11.41	34.05	8.03	33.98	244	321	Average
5068	57.5	49.4	74	-16.5	34.05	8.03	33.98	244	321	Peak
5310	76.87	68.32			34.25	8.32	34.02	244	321	Average
5310	85.1	76.55			34.25	8.32	34.02	244	321	Peak
5414	42.88	34.15	54	-11.12	34.33	8.44	34.04	244	321	Average
5414	57.13	48.4	74	-16.87	34.33	8.44	34.04	244	321	Peak
ANTENNA POLARITY & TEST DISTANCE: VERTICAL AT 3 M										
FREQ. (MHz)	EMISSION LEVEL (dBuV/m)	READ LEVEL (dBuV)	LIMIT (dBuV/m)	MARGIN (dB)	ANTENNA FACTOR (dB/m)	CABLE LOSS (dB)	PREAMP FACTOR (dB)	ANTENNA HEIGHT (cm)	TABLE ANGLE (Degree)	REMARK
5096	42.35	34.19	54	-11.65	34.08	8.07	33.99	100	198	Average
5096	56.43	48.27	74	-17.57	34.08	8.07	33.99	100	198	Peak
5310	76.37	67.82			34.25	8.32	34.02	100	198	Average
5310	84.5	75.95			34.25	8.32	34.02	100	198	Peak
5354	42.72	34.09	54	-11.28	34.28	8.38	34.03	100	198	Average
5354	56.82	48.19	74	-17.18	34.28	8.38	34.03	100	198	Peak

REMARKS:

- Emission Level = Read Level + Antenna Factor + Cable Loss - Preamp Factor
Margin value = Emission level – Limit value
- 5310MHz: Fundamental frequency.

EUT TEST CONDITION		MEASUREMENT DETAIL	
CHANNEL	Channel 102	FREQUENCY RANGE	1GHz ~ 40GHz
INPUT POWER	120Vac, 60 Hz	DETECTOR FUNCTION	Peak (PK) Average (AV)
ENVIRONMENTAL CONDITIONS	25deg. C, 65%RH	TESTED BY	Charles Hsiao

ANTENNA POLARITY & TEST DISTANCE: HORIZONTAL AT 3 M										
FREQ. (MHz)	EMISSION LEVEL (dBuV/m)	READ LEVEL (dBuV)	LIMIT (dBuV/m)	MARGIN (dB)	ANTENNA FACTOR (dB/m)	CABLE LOSS (dB)	PREAMP FACTOR (dB)	ANTENNA HEIGHT (cm)	TABLE ANGLE (Degree)	REMARK
5450	42.91	34.09	54	-11.09	34.36	8.51	34.05	229	303	Average
5450	56.86	48.04	74	-17.14	34.36	8.51	34.05	229	303	Peak
5470	56.26	47.43	68.2	-11.94	34.37	8.51	34.05	229	303	Peak
5510	83.77	74.86			34.4	8.57	34.06	229	303	Average
5510	91.7	82.79			34.4	8.57	34.06	229	303	Peak
5725	55.83	46.67	68.2	-12.37	34.62	8.65	34.11	229	303	Peak
ANTENNA POLARITY & TEST DISTANCE: VERTICAL AT 3 M										
FREQ. (MHz)	EMISSION LEVEL (dBuV/m)	READ LEVEL (dBuV)	LIMIT (dBuV/m)	MARGIN (dB)	ANTENNA FACTOR (dB/m)	CABLE LOSS (dB)	PREAMP FACTOR (dB)	ANTENNA HEIGHT (cm)	TABLE ANGLE (Degree)	REMARK
5438	42.88	34.09	54	-11.12	34.35	8.48	34.04	103	208	Average
5438	56.81	48.02	74	-17.19	34.35	8.48	34.04	103	208	Peak
5470	56.29	47.46	68.2	-11.91	34.37	8.51	34.05	103	208	Peak
5510	78.97	70.06			34.4	8.57	34.06	103	208	Average
5510	87.28	78.37			34.4	8.57	34.06	103	208	Peak
5725	55.31	46.15	68.2	-12.89	34.62	8.65	34.11	103	208	Peak

REMARKS:

- Emission Level = Read Level + Antenna Factor + Cable Loss - Preamp Factor
Margin value = Emission level – Limit value
- 5510MHz: Fundamental frequency.
- 5470MHz & 5725MHz: Out of restricted band

EUT TEST CONDITION		MEASUREMENT DETAIL	
CHANNEL	Channel 110	FREQUENCY RANGE	1GHz ~ 40GHz
INPUT POWER	120Vac, 60 Hz	DETECTOR FUNCTION	Peak (PK) Average (AV)
ENVIRONMENTAL CONDITIONS	25deg. C, 65%RH	TESTED BY	Charles Hsiao

ANTENNA POLARITY & TEST DISTANCE: HORIZONTAL AT 3 M										
FREQ. (MHz)	EMISSION LEVEL (dBuV/m)	READ LEVEL (dBuV)	LIMIT (dBuV/m)	MARGIN (dB)	ANTENNA FACTOR (dB/m)	CABLE LOSS (dB)	PREAMP FACTOR (dB)	ANTENNA HEIGHT (cm)	TABLE ANGLE (Degree)	REMARK
5446	47.07	38.24	54	-6.93	34.36	8.51	34.04	229	305	Average
5446	59.96	51.13	74	-14.04	34.36	8.51	34.04	229	305	Peak
5470	62.99	54.16	68.2	-5.21	34.37	8.51	34.05	228	306	Peak
5550	88.59	79.62			34.45	8.59	34.07	229	306	Average
5550	96.6	87.63			34.45	8.59	34.07	229	306	Peak
5725	55.03	45.87	68.2	-13.17	34.62	8.65	34.11	229	306	Peak
ANTENNA POLARITY & TEST DISTANCE: VERTICAL AT 3 M										
FREQ. (MHz)	EMISSION LEVEL (dBuV/m)	READ LEVEL (dBuV)	LIMIT (dBuV/m)	MARGIN (dB)	ANTENNA FACTOR (dB/m)	CABLE LOSS (dB)	PREAMP FACTOR (dB)	ANTENNA HEIGHT (cm)	TABLE ANGLE (Degree)	REMARK
5458	43.07	34.25	54	-10.93	34.36	8.51	34.05	101	209	Average
5458	57.11	48.29	74	-16.89	34.36	8.51	34.05	101	209	Peak
5470	57.79	48.96	68.2	-10.41	34.37	8.51	34.05	101	209	Peak
5550	84.54	75.57			34.45	8.59	34.07	101	209	Average
5550	92.37	83.4			34.45	8.59	34.07	101	209	Peak
5725	55.35	46.19	68.2	-12.85	34.62	8.65	34.11	101	209	Peak

REMARKS:

- Emission Level = Read Level + Antenna Factor + Cable Loss - Preamp Factor
Margin value = Emission level – Limit value
- 5550MHz: Fundamental frequency.
- 5470MHz & 5725MHz: Out of restricted band

EUT TEST CONDITION		MEASUREMENT DETAIL	
CHANNEL	Channel 134	FREQUENCY RANGE	1GHz ~ 40GHz
INPUT POWER	120Vac, 60 Hz	DETECTOR FUNCTION	Peak (PK) Average (AV)
ENVIRONMENTAL CONDITIONS	25deg. C, 65%RH	TESTED BY	Charles Hsiao

ANTENNA POLARITY & TEST DISTANCE: HORIZONTAL AT 3 M										
FREQ. (MHz)	EMISSION LEVEL (dBuV/m)	READ LEVEL (dBuV)	LIMIT (dBuV/m)	MARGIN (dB)	ANTENNA FACTOR (dB/m)	CABLE LOSS (dB)	PREAMP FACTOR (dB)	ANTENNA HEIGHT (cm)	TABLE ANGLE (Degree)	REMARK
5430	42.88	34.09	54	-11.12	34.35	8.48	34.04	231	308	Average
5430	57.35	48.56	74	-16.65	34.35	8.48	34.04	231	308	Peak
5470	56.39	47.56	68.2	-11.81	34.37	8.51	34.05	231	308	Peak
5670	86	76.9			34.57	8.63	34.1	231	308	Average
5670	94.18	85.08			34.57	8.63	34.1	231	308	Peak
5725	58.93	49.77	68.2	-9.27	34.62	8.65	34.11	230	308	Peak
ANTENNA POLARITY & TEST DISTANCE: VERTICAL AT 3 M										
FREQ. (MHz)	EMISSION LEVEL (dBuV/m)	READ LEVEL (dBuV)	LIMIT (dBuV/m)	MARGIN (dB)	ANTENNA FACTOR (dB/m)	CABLE LOSS (dB)	PREAMP FACTOR (dB)	ANTENNA HEIGHT (cm)	TABLE ANGLE (Degree)	REMARK
5430	42.92	34.13	54	-11.08	34.35	8.48	34.04	106	211	Average
5430	57.03	48.24	74	-16.97	34.35	8.48	34.04	106	211	Peak
5470	55.76	46.93	68.2	-12.44	34.37	8.51	34.05	106	211	Peak
5670	82.8	73.7			34.57	8.63	34.1	106	211	Average
5670	90.59	81.49			34.57	8.63	34.1	106	211	Peak
5725	56.2	47.04	68.2	-12	34.62	8.65	34.11	106	211	Peak

REMARKS:

- Emission Level = Read Level + Antenna Factor + Cable Loss - Preamp Factor
Margin value = Emission level – Limit value
- 5670MHz: Fundamental frequency.
- 5470MHz & 5725MHz: Out of restricted band

EUT TEST CONDITION		MEASUREMENT DETAIL	
CHANNEL	Channel 151	FREQUENCY RANGE	1GHz ~ 40GHz
INPUT POWER	120Vac, 60 Hz	DETECTOR FUNCTION	Peak (PK) Average (AV)
ENVIRONMENTAL CONDITIONS	25deg. C, 65%RH	TESTED BY	Charles Hsiao

ANTENNA POLARITY & TEST DISTANCE: HORIZONTAL AT 3 M										
FREQ. (MHz)	EMISSION LEVEL (dBuV/m)	READ LEVEL (dBuV)	LIMIT (dBuV/m)	MARGIN (dB)	ANTENNA FACTOR (dB/m)	CABLE LOSS (dB)	PREAMP FACTOR (dB)	ANTENNA HEIGHT (cm)	TABLE ANGLE (Degree)	REMARK
5714	67.12	57.97	68.2	-1.08	34.61	8.65	34.11	101	323	Peak
5724	76.66	67.5	78.2	-1.54	34.62	8.65	34.11	101	323	Peak
5755	86.18	76.97			34.66	8.66	34.11	100	323	Average
5755	93.92	84.71			34.66	8.66	34.11	100	323	Peak
5854	56.19	46.87	78.2	-22.01	34.76	8.7	34.14	100	323	Peak
5870	57.01	47.68	68.2	-11.19	34.76	8.71	34.14	100	323	Peak
ANTENNA POLARITY & TEST DISTANCE: VERTICAL AT 3 M										
FREQ. (MHz)	EMISSION LEVEL (dBuV/m)	READ LEVEL (dBuV)	LIMIT (dBuV/m)	MARGIN (dB)	ANTENNA FACTOR (dB/m)	CABLE LOSS (dB)	PREAMP FACTOR (dB)	ANTENNA HEIGHT (cm)	TABLE ANGLE (Degree)	REMARK
5714	67.08	57.93	68.2	-1.12	34.61	8.65	34.11	201	120	Peak
5722	72.91	63.75	78.2	-5.29	34.62	8.65	34.11	106	120	Peak
5755	83.89	74.68			34.66	8.66	34.11	113	120	Average
5755	92.02	82.81			34.66	8.66	34.11	113	120	Peak
5858	57.46	48.14	78.2	-20.74	34.76	8.7	34.14	113	120	Peak
5864	57.29	47.96	68.2	-10.91	34.76	8.71	34.14	113	120	Peak

REMARKS:

- Emission Level = Read Level + Antenna Factor + Cable Loss - Preamp Factor
Margin value = Emission level – Limit value
- 5755MHz: Fundamental frequency.
- 5714MHz & 5724MHz, 5854MHz & 5870MHz: Out of restricted band
5714MHz & 5722MHz, 5858MHz & 5864MHz: Out of restricted band

EUT TEST CONDITION		MEASUREMENT DETAIL	
CHANNEL	Channel 159	FREQUENCY RANGE	1GHz ~ 40GHz
INPUT POWER	120Vac, 60 Hz	DETECTOR FUNCTION	Peak (PK) Average (AV)
ENVIRONMENTAL CONDITIONS	25deg. C, 65%RH	TESTED BY	Charles Hsiao

ANTENNA POLARITY & TEST DISTANCE: HORIZONTAL AT 3 M										
FREQ. (MHz)	EMISSION LEVEL (dBuV/m)	READ LEVEL (dBuV)	LIMIT (dBuV/m)	MARGIN (dB)	ANTENNA FACTOR (dB/m)	CABLE LOSS (dB)	PREAMP FACTOR (dB)	ANTENNA HEIGHT (cm)	TABLE ANGLE (Degree)	REMARK
5714	57.95	48.8	68.2	-10.25	34.61	8.65	34.11	112	330	Peak
5720	59.47	50.31	78.2	-18.73	34.62	8.65	34.11	112	330	Peak
5795	85.94	76.7			34.69	8.68	34.13	112	330	Average
5795	93.5	84.26			34.69	8.68	34.13	112	330	Peak
5854	64.75	55.43	78.2	-13.45	34.76	8.7	34.14	112	330	Peak
5862	59.58	50.25	68.2	-8.62	34.76	8.71	34.14	112	330	Peak
ANTENNA POLARITY & TEST DISTANCE: VERTICAL AT 3 M										
FREQ. (MHz)	EMISSION LEVEL (dBuV/m)	READ LEVEL (dBuV)	LIMIT (dBuV/m)	MARGIN (dB)	ANTENNA FACTOR (dB/m)	CABLE LOSS (dB)	PREAMP FACTOR (dB)	ANTENNA HEIGHT (cm)	TABLE ANGLE (Degree)	REMARK
5706	52.23	43.08	68.2	-15.97	34.61	8.65	34.11	109	204	Peak
5722	56.64	47.48	78.2	-21.56	34.62	8.65	34.11	109	204	Peak
5795	84.62	75.38			34.69	8.68	34.13	109	204	Average
5795	92.14	82.9			34.69	8.68	34.13	109	204	Peak
5852	66.96	57.66	78.2	-11.24	34.74	8.7	34.14	109	204	Peak
5870	64.78	55.45	68.2	-3.42	34.76	8.71	34.14	109	204	Peak

REMARKS:

- Emission Level = Read Level + Antenna Factor + Cable Loss - Preamp Factor
Margin value = Emission level – Limit value
- 5795MHz: Fundamental frequency.
- 5714MHz & 5720MHz, 5854MHz & 5862MHz: Out of restricted band
5706MHz & 5722MHz, 5852MHz & 5870MHz: Out of restricted band

802.11ac (80MHz)

EUT TEST CONDITION		MEASUREMENT DETAIL	
CHANNEL	Channel 42	FREQUENCY RANGE	1GHz ~ 40GHz
INPUT POWER	120Vac, 60 Hz	DETECTOR FUNCTION	Peak (PK) Average (AV)
ENVIRONMENTAL CONDITIONS	25deg. C, 65%RH	TESTED BY	Hwa Chiang

ANTENNA POLARITY & TEST DISTANCE: HORIZONTAL AT 3 M										
FREQ. (MHz)	EMISSION LEVEL (dBuV/m)	READ LEVEL (dBuV)	LIMIT (dBuV/m)	MARGIN (dB)	ANTENNA FACTOR (dB/m)	CABLE LOSS (dB)	PREAMP FACTOR (dB)	ANTENNA HEIGHT (cm)	TABLE ANGLE (Degree)	REMARK
5062	43.48	35.38	54	-10.52	34.05	8.03	33.98	239	318	Average
5062	57.17	49.07	74	-16.83	34.05	8.03	33.98	239	318	Peak
5210	75.13	66.77			34.17	8.19	34	239	318	Average
5210	82.67	74.31			34.17	8.19	34	239	318	Peak
5428	47.1	38.33	54	-6.9	34.33	8.48	34.04	239	318	Average
5428	58.4	49.63	74	-15.6	34.33	8.48	34.04	239	318	Peak
ANTENNA POLARITY & TEST DISTANCE: VERTICAL AT 3 M										
FREQ. (MHz)	EMISSION LEVEL (dBuV/m)	READ LEVEL (dBuV)	LIMIT (dBuV/m)	MARGIN (dB)	ANTENNA FACTOR (dB/m)	CABLE LOSS (dB)	PREAMP FACTOR (dB)	ANTENNA HEIGHT (cm)	TABLE ANGLE (Degree)	REMARK
5020	44.96	36.95	54	-9.04	34.01	7.97	33.97	101	260	Average
5020	57.3	49.29	74	-16.7	34.01	7.97	33.97	101	260	Peak
5210	72.74	64.38			34.17	8.19	34	101	260	Average
5210	81.18	72.82			34.17	8.19	34	101	260	Peak
5380	42.9	34.22	54	-11.1	34.31	8.41	34.04	101	260	Average
5380	57.12	48.44	74	-16.88	34.31	8.41	34.04	101	260	Peak

REMARKS:

- Emission Level = Read Level + Antenna Factor + Cable Loss - Preamp Factor
Margin value = Emission level – Limit value
- 5210MHz: Fundamental frequency.

EUT TEST CONDITION		MEASUREMENT DETAIL	
CHANNEL	Channel 58	FREQUENCY RANGE	1GHz ~ 40GHz
INPUT POWER	120Vac, 60 Hz	DETECTOR FUNCTION	Peak (PK) Average (AV)
ENVIRONMENTAL CONDITIONS	25deg. C, 65%RH	TESTED BY	Charles Hsiao

ANTENNA POLARITY & TEST DISTANCE: HORIZONTAL AT 3 M										
FREQ. (MHz)	EMISSION LEVEL (dBuV/m)	READ LEVEL (dBuV)	LIMIT (dBuV/m)	MARGIN (dB)	ANTENNA FACTOR (dB/m)	CABLE LOSS (dB)	PREAMP FACTOR (dB)	ANTENNA HEIGHT (cm)	TABLE ANGLE (Degree)	REMARK
5084	42.63	34.47	54	-11.37	34.07	8.07	33.98	216	298	Average
5084	56.45	48.29	74	-17.55	34.07	8.07	33.98	216	298	Peak
5290	74.04	65.51			34.23	8.32	34.02	216	298	Average
5290	82.51	73.98			34.23	8.32	34.02	216	298	Peak
5454	46.07	37.25	54	-7.93	34.36	8.51	34.05	216	298	Average
5454	57.44	48.62	74	-16.56	34.36	8.51	34.05	216	298	Peak
ANTENNA POLARITY & TEST DISTANCE: VERTICAL AT 3 M										
FREQ. (MHz)	EMISSION LEVEL (dBuV/m)	READ LEVEL (dBuV)	LIMIT (dBuV/m)	MARGIN (dB)	ANTENNA FACTOR (dB/m)	CABLE LOSS (dB)	PREAMP FACTOR (dB)	ANTENNA HEIGHT (cm)	TABLE ANGLE (Degree)	REMARK
5064	42.69	34.59	54	-11.31	34.05	8.03	33.98	101	206	Average
5064	56.7	48.6	74	-17.3	34.05	8.03	33.98	101	206	Peak
5290	73.14	64.61			34.23	8.32	34.02	101	206	Average
5290	81.62	73.09			34.23	8.32	34.02	101	206	Peak
5412	43.28	34.55	54	-10.72	34.33	8.44	34.04	101	206	Average
5412	56.97	48.24	74	-17.03	34.33	8.44	34.04	101	206	Peak

REMARKS:

- Emission Level = Read Level + Antenna Factor + Cable Loss - Preamp Factor
Margin value = Emission level – Limit value
- 5290MHz: Fundamental frequency.

EUT TEST CONDITION		MEASUREMENT DETAIL	
CHANNEL	Channel 106	FREQUENCY RANGE	1GHz ~ 40GHz
INPUT POWER	120Vac, 60 Hz	DETECTOR FUNCTION	Peak (PK) Average (AV)
ENVIRONMENTAL CONDITIONS	25deg. C, 65%RH	TESTED BY	Charles Hsiao

ANTENNA POLARITY & TEST DISTANCE: HORIZONTAL AT 3 M										
FREQ. (MHz)	EMISSION LEVEL (dBuV/m)	READ LEVEL (dBuV)	LIMIT (dBuV/m)	MARGIN (dB)	ANTENNA FACTOR (dB/m)	CABLE LOSS (dB)	PREAMP FACTOR (dB)	ANTENNA HEIGHT (cm)	TABLE ANGLE (Degree)	REMARK
5458	48.67	39.85	54	-5.33	34.36	8.51	34.05	221	302	Average
5458	59.06	50.24	74	-14.94	34.36	8.51	34.05	221	302	Peak
5470	56.14	47.31	68.2	-12.06	34.37	8.51	34.05	221	303	Peak
5530	82.6	73.67			34.42	8.58	34.07	221	303	Average
5530	90.63	81.7			34.42	8.58	34.07	221	303	Peak
5725	57.91	48.75	68.2	-10.29	34.62	8.65	34.11	221	303	Peak
ANTENNA POLARITY & TEST DISTANCE: VERTICAL AT 3 M										
FREQ. (MHz)	EMISSION LEVEL (dBuV/m)	READ LEVEL (dBuV)	LIMIT (dBuV/m)	MARGIN (dB)	ANTENNA FACTOR (dB/m)	CABLE LOSS (dB)	PREAMP FACTOR (dB)	ANTENNA HEIGHT (cm)	TABLE ANGLE (Degree)	REMARK
5454	43.27	34.45	54	-10.73	34.36	8.51	34.05	101	208	Average
5454	57.72	48.9	74	-16.28	34.36	8.51	34.05	101	208	Peak
5470	55.94	47.11	68.2	-12.26	34.37	8.51	34.05	101	208	Peak
5530	78.4	69.47			34.42	8.58	34.07	101	208	Average
5530	86.3	77.37			34.42	8.58	34.07	101	208	Peak
5725	55.17	46.01	68.2	-13.03	34.62	8.65	34.11	101	208	Peak

REMARKS:

- Emission Level = Read Level + Antenna Factor + Cable Loss - Preamp Factor
Margin value = Emission level – Limit value
- 5530MHz: Fundamental frequency.
- 5470MHz & 5725MHz: Out of restricted band

EUT TEST CONDITION		MEASUREMENT DETAIL	
CHANNEL	Channel 155	FREQUENCY RANGE	1GHz ~ 40GHz
INPUT POWER	120Vac, 60 Hz	DETECTOR FUNCTION	Peak (PK) Average (AV)
ENVIRONMENTAL CONDITIONS	25deg. C, 65%RH	TESTED BY	Charles Hsiao

ANTENNA POLARITY & TEST DISTANCE: HORIZONTAL AT 3 M										
FREQ. (MHz)	EMISSION LEVEL (dBuV/m)	READ LEVEL (dBuV)	LIMIT (dBuV/m)	MARGIN (dB)	ANTENNA FACTOR (dB/m)	CABLE LOSS (dB)	PREAMP FACTOR (dB)	ANTENNA HEIGHT (cm)	TABLE ANGLE (Degree)	REMARK
5706	66.69	57.54	68.2	-1.51	34.61	8.65	34.11	112	330	Peak
5722	67.35	58.19	78.2	-10.85	34.62	8.65	34.11	112	330	Peak
5775	79.89	70.66			34.68	8.67	34.12	112	330	Average
5775	88.36	79.13			34.68	8.67	34.12	112	330	Peak
5854	68.89	59.57	78.2	-9.31	34.76	8.7	34.14	112	330	Peak
5864	66.56	57.23	68.2	-1.64	34.76	8.71	34.14	112	330	Peak
ANTENNA POLARITY & TEST DISTANCE: VERTICAL AT 3 M										
FREQ. (MHz)	EMISSION LEVEL (dBuV/m)	READ LEVEL (dBuV)	LIMIT (dBuV/m)	MARGIN (dB)	ANTENNA FACTOR (dB/m)	CABLE LOSS (dB)	PREAMP FACTOR (dB)	ANTENNA HEIGHT (cm)	TABLE ANGLE (Degree)	REMARK
5706	66.57	57.42	68.2	-1.63	34.61	8.65	34.11	112	203	Peak
5718	67.61	58.45	78.2	-10.59	34.62	8.65	34.11	112	203	Peak
5775	79.2	69.97			34.68	8.67	34.12	112	203	Average
5775	87.71	78.48			34.68	8.67	34.12	112	203	Peak
5852	57.43	48.13	78.2	-20.77	34.74	8.7	34.14	112	203	Peak
5870	56.03	46.7	68.2	-12.17	34.76	8.71	34.14	112	203	Peak

REMARKS:

- Emission Level = Read Level + Antenna Factor + Cable Loss - Preamp Factor
Margin value = Emission level – Limit value
- 5775MHz: Fundamental frequency.
- 5706MHz & 5722MHz, 5854MHz & 5864MHz: Out of restricted band
5706MHz & 5718MHz, 5852MHz & 5870MHz: Out of restricted band



BELOW 1GHz WORST-CASE DATA:

802.11n (40MHz)

EUT TEST CONDITION		MEASUREMENT DETAIL	
CHANNEL	Channel 151	FREQUENCY RANGE	30MHz ~ 1GHz
INPUT POWER	120Vac, 60 Hz	DETECTOR FUNCTION	Peak (PK) Quasi-peak (QP)
ENVIRONMENTAL CONDITIONS	25deg. C, 65%RH	TESTED BY	Charles Hsiao

ANTENNA POLARITY & TEST DISTANCE: HORIZONTAL AT 3 M										
FREQ. (MHz)	EMISSION LEVEL (dBuV/m)	READ LEVEL (dBuV)	LIMIT (dBuV/m)	MARGIN (dB)	ANTENNA FACTOR (dB/m)	CABLE LOSS (dB)	PREAMP FACTOR (dB)	ANTENNA HEIGHT (cm)	TABLE ANGLE (Degree)	REMARK
79.14	14.61	37.45	40	-25.39	8.26	1.11	32.21	114	79	Peak
147.72	22.97	45.33	43.5	-20.53	8.39	1.52	32.27	122	197	Peak
189.84	18.23	38.25	43.5	-25.27	10.62	1.61	32.25	106	161	Peak
532.4	19.13	31.82	46	-26.87	16.77	2.7	32.16	132	239	Peak
799.1	20.79	29.21	46	-25.21	20.32	3.32	32.06	120	48	Peak
948.2	23.91	29.67	46	-22.09	21.74	3.62	31.12	173	185	Peak
ANTENNA POLARITY & TEST DISTANCE: VERTICAL AT 3 M										
FREQ. (MHz)	EMISSION LEVEL (dBuV/m)	READ LEVEL (dBuV)	LIMIT (dBuV/m)	MARGIN (dB)	ANTENNA FACTOR (dB/m)	CABLE LOSS (dB)	PREAMP FACTOR (dB)	ANTENNA HEIGHT (cm)	TABLE ANGLE (Degree)	REMARK
30.81	20.35	40.26	40	-19.65	11.61	0.74	32.26	102	30	Peak
75.9	21.41	44.12	40	-18.59	8.4	1.11	32.22	140	117	Peak
147.72	16.93	39.29	43.5	-26.57	8.39	1.52	32.27	152	352	Peak
533.1	23.23	35.91	46	-22.77	16.79	2.7	32.17	155	122	Peak
841.1	22.47	30.03	46	-23.53	20.9	3.38	31.84	120	190	Peak
995.1	24.69	29.14	54	-29.31	22.19	3.72	30.36	133	321	Peak

REMARKS: Emission Level = Read Level + Antenna Factor + Cable Loss - Preamp Factor

Margin value = Emission level – Limit value

4.2 CONDUCTED EMISSION MEASUREMENT

4.2.1 LIMITS OF CONDUCTED EMISSION MEASUREMENT

FREQUENCY OF EMISSION (MHz)	CONDUCTED LIMIT (dB μ V)	
	Quasi-peak	Average
0.15 ~ 0.5	66 to 56	56 to 46
0.5 ~ 5	56	46
5 ~ 30	60	50

NOTE:

1. The lower limit shall apply at the transition frequencies.
2. The limit decreases in line with the logarithm of the frequency in the range of 0.15 to 0.50MHz.
3. All emanations from a class A/B digital device or system, including any network of conductors and apparatus connected thereto, shall not exceed the level of field strengths specified above.

4.2.2 TEST INSTRUMENTS

DESCRIPTION & MANUFACTURER	MODEL NO.	SERIAL NO.	DATE OF CALIBRATION	DUE DATE OF CALIBRATION
Test Receiver ROHDE & SCHWARZ	ESCI	100613	Nov. 11, 2014	Nov. 10, 2015
RF signal cable Woken	5D-FB	Cable-HYC01-01	Dec. 26, 2014	Dec. 25, 2015
LISN ROHDE & SCHWARZ (EUT)	ESH3-Z5	835239/001	Mar. 02, 2015	Mar. 01, 2016
LISN ROHDE & SCHWARZ (Peripheral)	ESH3-Z5	100311	Jul. 21, 2014	Jul. 20, 2015
Software ADT	BV ADT_Cond_ V7.3.7.3	NA	NA	NA

- NOTE:**
1. The calibration interval of the above test instruments is 12 months and the calibrations are traceable to NML/ROC and NIST/USA.
 2. The test was performed in HwaYa Shielded Room 1.
 3. The VCCI Site Registration No. is C-2040.

4.2.3 TEST PROCEDURES

- a. The EUT was placed 0.4 meters from the conducting wall of the shielded room with EUT being connected to the power mains through a line impedance stabilization network (LISN). Other support units were connected to the power mains through another LISN. The two LISNs provide 50 ohm/ 50uH of coupling impedance for the measuring instrument.
- b. Both lines of the power mains connected to the EUT were checked for maximum conducted interference.
- c. The frequency range from 150kHz to 30MHz was searched. Emission levels under (Limit - 20dB) was not recorded.

NOTE: All modes of operation were investigated and the worst-case emissions are reported.

4.2.4 DEVIATION FROM TEST STANDARD

No deviation.

4.2.5 TEST SETUP

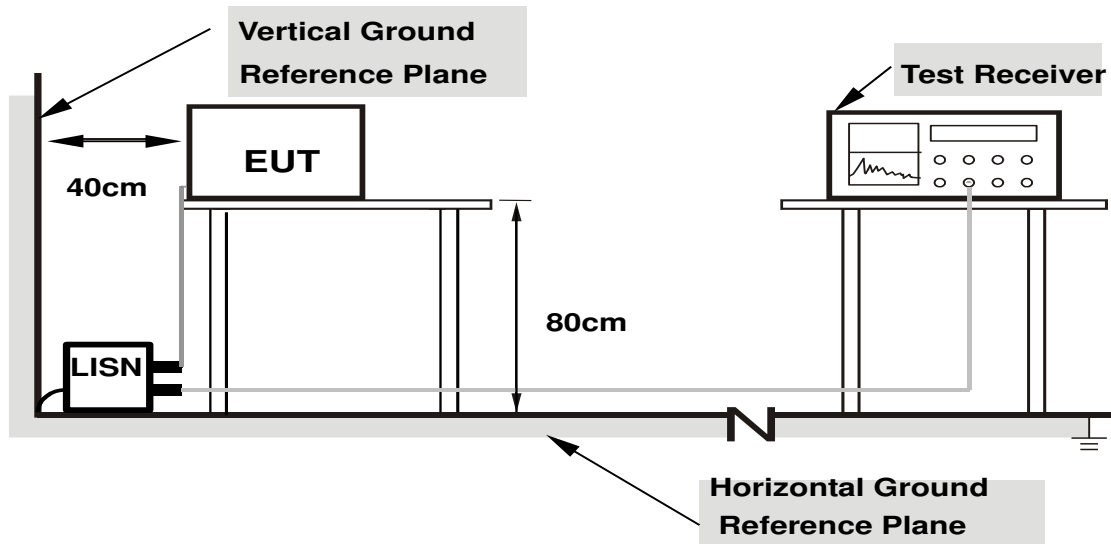

- Note:**
- 1.Support units were connected to second LISN.
 - 2.Both of LISNs (AMN) are 80 cm from EUT and at least 80 from other units and other metal planes

For the actual test configuration, please refer to the attached file (Test Setup Photo).

4.2.6 EUT OPERATING CONDITIONS

Same as section 4.1.6.

4.2.7 TEST RESULTS

CONDUCTED WORST-CASE DATA :

Frequency Range	150kHz ~ 30MHz	Detector Function & Resolution Bandwidth	Quasi-Peak (QP) / Average (AV), 9kHz
Input Power	120Vac, 60Hz	Environmental Conditions	25°C, 65%RH
Tested by	Toby Tian	Test Date	2015/6/18

Phase Of Power : Line (L)										
No	Frequency (MHz)	Correction Factor (dB)	Reading Value (dBuV)		Emission Level (dBuV)		Limit (dBuV)		Margin (dB)	
			Q.P.	AV.	Q.P.	AV.	Q.P.	AV.	Q.P.	AV.
1	0.16569	0.05	42.27	34.23	42.32	34.28	65.17	55.17	-22.85	-20.89
2	0.21226	0.06	36.55	25.98	36.61	26.04	63.12	53.12	-26.51	-27.08
3	0.51754	0.06	36.50	26.20	36.56	26.26	56.00	46.00	-19.44	-19.74
4	0.64266	0.07	34.30	24.11	34.37	24.18	56.00	46.00	-21.63	-21.82
5	4.57612	0.21	29.66	19.93	29.87	20.14	56.00	46.00	-26.13	-25.86
6	9.50663	0.43	32.55	22.74	32.98	23.17	60.00	50.00	-27.02	-26.83

Remarks:

1. Q.P. and AV. are abbreviations of quasi-peak and average individually.
2. The emission levels of other frequencies were very low against the limit.
3. Margin value = Emission level – Limit value
4. Correction factor = Insertion loss + Cable loss
5. Emission Level = Correction Factor + Reading Value

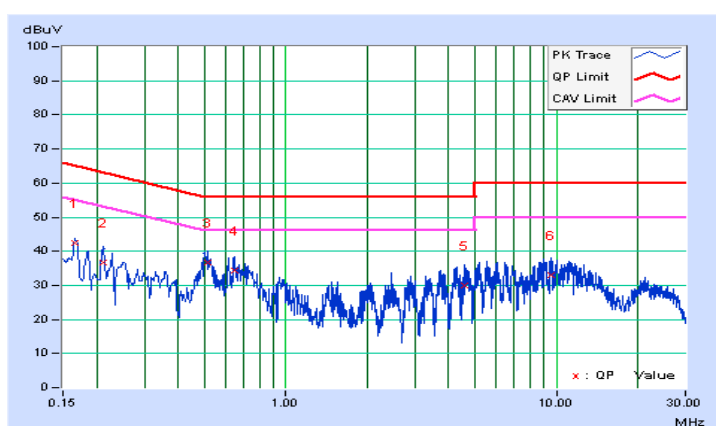

Frequency Range	150kHz ~ 30MHz	Detector Function & Resolution Bandwidth	Quasi-Peak (QP) / Average (AV), 9kHz
Input Power	120Vac, 60Hz	Environmental Conditions	25°C, 65%RH
Tested by	Toby Tian	Test Date	2015/6/18

Phase Of Power : Neutral (N)										
No	Frequency (MHz)	Correction Factor (dB)	Reading Value (dBuV)		Emission Level (dBuV)		Limit (dBuV)		Margin (dB)	
			Q.P.	AV.	Q.P.	AV.	Q.P.	AV.	Q.P.	AV.
1	0.16564	0.05	42.28	34.03	42.33	34.08	65.18	55.18	-22.85	-21.10
2	0.20458	0.05	39.13	30.46	39.18	30.51	63.42	53.42	-24.24	-22.91
3	0.51754	0.06	34.92	27.88	34.98	27.94	56.00	46.00	-21.02	-18.06
4	0.66221	0.07	30.50	24.12	30.57	24.19	56.00	46.00	-25.43	-21.81
5	4.17339	0.20	27.46	20.89	27.66	21.09	56.00	46.00	-28.34	-24.91
6	9.65130	0.41	31.60	22.72	32.01	23.13	60.00	50.00	-27.99	-26.87

Remarks:

1. Q.P. and AV. are abbreviations of quasi-peak and average individually.
2. The emission levels of other frequencies were very low against the limit.
3. Margin value = Emission level – Limit value
4. Correction factor = Insertion loss + Cable loss
5. Emission Level = Correction Factor + Reading Value

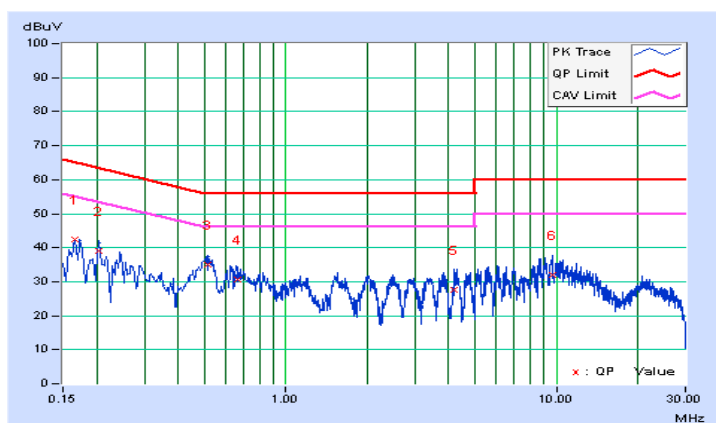

4.3 TRANSMIT POWER MEASUREMENT

4.3.1 LIMITS OF TRANSMIT POWER MEASUREMENT

OPERATION BAND	EUT CATEGORY		LIMIT
U-NII-1		Outdoor Access Point	1 Watt (30 dBm) (Max. e.i.r.p \leq 125mW(21 dBm) at any elevation angle above 30 degrees as measured from the horizon)
		Fixed point-to-point Access Point	1 Watt (30 dBm)
		Indoor Access Point	1 Watt (30 dBm)
	√	Mobile and Portable client device	250mW (24 dBm)
U-NII-2A		---	250mW (24 dBm) or 11 dBm+10 log B*
U-NII-2C		---	250mW (24 dBm) or 11 dBm+10 log B*
U-NII-3	√	---	1 Watt (30 dBm)

NOTE: Where B is the 26dB emission bandwidth in MHz.

4.3.2 TEST SETUP

FOR POWER OUTPUT MEASUREMENT

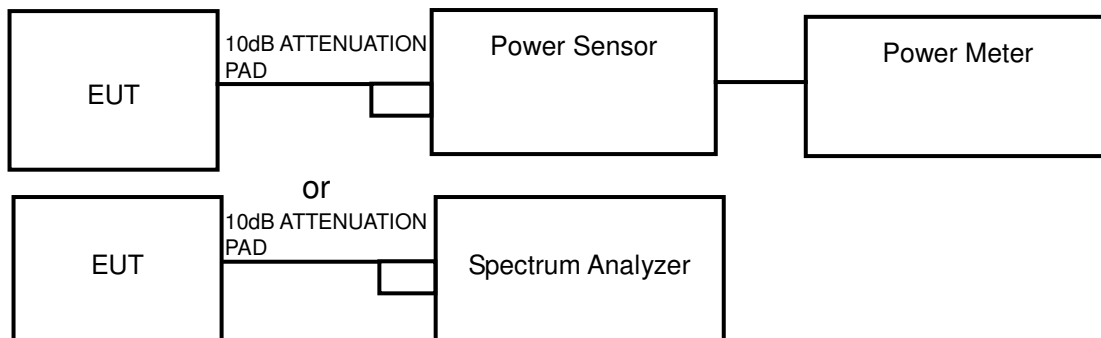

4.3.3 TEST INSTRUMENTS

Refer to section 4.1.3 to get information of above instrument.

4.3.4 TEST PROCEDURE

FOR AVERAGE POWER MEASUREMENT

<802.11a, 802.11n (20MHz), 802.11n (40MHz)>

Method PM is used to perform output power measurement, trigger and gating function of wide band power meter is enabled to measure max output power of TX on burst. Duty factor is not added to measured value.

<802.11ac (80MHz)>

Method SA-1 is used to perform output power measurement, trigger and gating function of spectrum analyzer is enabled to measure max output power of TX on burst. Duty factor is not added to measured value.

4.3.5 DEVIATION FROM TEST STANDARD

No deviation.

4.3.6 EUT OPERATING CONDITIONS

The software provided by client to enable the EUT under transmission condition continuously at specific channel frequencies individually.

4.3.7 TEST RESULTS

POWER OUTPUT

802.11a

CHANNEL	CHANNEL FREQUENCY (MHz)	MAX. CONDUCTED POWER (mW)	MAX. CONDUCTED POWER (dBm)	POWER LIMIT (dBm)	PASS/FAIL
36	5180	28.71	14.58	24	PASS
44	5220	26.67	14.26	24	PASS
48	5240	26.61	14.25	24	PASS
149	5745	60.26	17.8	30	PASS
157	5785	63.24	18.01	30	PASS
165	5825	63.10	18	30	PASS

802.11n (20MHz)

CHANNEL	CHANNEL FREQUENCY (MHz)	MAX. CONDUCTED POWER (mW)	MAX. CONDUCTED POWER (dBm)	POWER LIMIT (dBm)	PASS/FAIL
36	5180	34.67	15.40	24	PASS
44	5220	45.50	16.58	24	PASS
48	5240	45.60	16.59	24	PASS
149	5745	72.28	18.59	30	PASS
157	5785	62.37	17.95	30	PASS
165	5825	65.31	18.15	30	PASS

802.11n (40MHz)

CHANNEL	CHANNEL FREQUENCY (MHz)	MAX. CONDUCTED POWER (mW)	MAX. CONDUCTED POWER (dBm)	POWER LIMIT (dBm)	PASS/FAIL
38	5190	9.95	9.98	24	PASS
46	5230	39.17	15.93	24	PASS
151	5755	58.34	17.66	30	PASS
159	5795	57.81	17.62	30	PASS

802.11ac (80MHz)

CHANNEL	CHANNEL FREQUENCY (MHz)	MAX. CONDUCTED POWER (mW)	MAX. CONDUCTED POWER (dBm)	POWER LIMIT (dBm)	PASS/FAIL
42	5210	12.11	10.83	24	PASS
155	5775	75.16	18.76	30	PASS

4.4 PEAK POWER SPECTRAL DENSITY MEASUREMENT

4.4.1 LIMITS OF PEAK POWER SPECTRAL DENSITY MEASUREMENT

Operation Band	EUT Category		LIMIT
U-NII-1		Outdoor Access Point	17dBm/ MHz
		Fixed point-to-point Access Point	
		Indoor Access Point	
	√	Mobile and Portable client device	11dBm/ MHz
U-NII-2A		---	11dBm/ MHz
U-NII-2C		---	11dBm/ MHz
U-NII-3	√	---	30dBm/ 500kHz

4.4.2 TEST SETUP

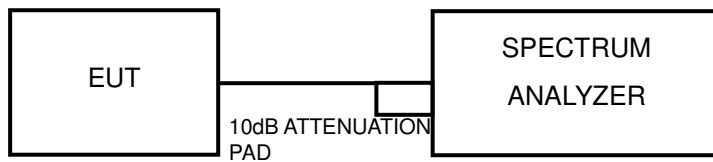

4.4.3 TEST INSTRUMENTS

Refer to section 4.1.3 to get information of above instrument.

4.4.4 TEST PROCEDURES

For U-NII-1 band:

- 1) Set span to encompass the entire emission bandwidth (EBW) of the signal.
- 2) Set RBW = 30 kHz, Set VBW \geq 1 MHz, Detector = RMS
- 3) Set Channel power measure = 1MHz
- 4) Sweep time = auto, trigger set to "free run".
- 5) Trace average at least 100 traces in power averaging mode.
- 6) Record the max value

- 1) Set span to encompass the entire emission bandwidth (EBW) of the signal.
- 2) Set RBW = 30 kHz, Set VBW \geq 1 MHz, Detector = RMS
- 3) Set Channel power measure = 1MHz
- 4) Sweep time = auto, trigger set to "free run".
- 5) Trace average at least 100 traces in power averaging mode.
- 6) Record the max value and add 10 log (1/duty cycle)

For U-NII-3 band:

- 1) Set span to encompass the entire emission bandwidth (EBW) of the signal.
- 2) Set RBW = 500 kHz, Set VBW \geq 3 RBW, Detector = RMS
- 3) Sweep time = auto, trigger set to "free run".
- 4) Trace average at least 100 traces in power averaging mode.
- 5) Record the max value and add 10 log (1/duty cycle)

4.4.5 DEVIATION FROM TEST STANDARD

No deviation.

4.4.6 EUT OPERATING CONDITIONS

Same as Item 4.3.6.

4.4.7 TEST RESULTS

For U-NII-1 Band

802.11a

CHANNEL	FREQUENCY (MHz)	PSD W/O DUTY FACTOR (dBm)	DUTY FACTOR	PSD WITH DUTY FACTOR (dBm)	MAXIMUM LIMIT (dBm)	PASS/FAIL
36	5180	0.61	3.39	4.00	11	PASS
44	5220	-0.26	3.39	3.13	11	PASS
48	5240	0.14	3.39	3.53	11	PASS

NOTE: Refer to section 3.3 for duty cycle spectrum plot.

802.11n (20MHz)

CHANNEL	FREQUENCY (MHz)	PSD W/O DUTY FACTOR (dBm)	DUTY FACTOR	PSD WITH DUTY FACTOR (dBm)	MAXIMUM LIMIT (dBm)	PASS/FAIL
36	5180	0.89	4.13	5.02	11	PASS
44	5220	2.33	4.13	6.46	11	PASS
48	5240	2.19	4.13	6.32	11	PASS

NOTE: Refer to section 3.3 for duty cycle spectrum plot.

802.11n (40MHz)

CHANNEL	FREQUENCY (MHz)	PSD W/O DUTY FACTOR (dBm)	DUTY FACTOR	PSD WITH DUTY FACTOR (dBm)	MAXIMUM LIMIT (dBm)	PASS/FAIL
38	5190	-10.43	7.26	-3.17	11	PASS
46	5230	-4.51	7.26	2.75	11	PASS

NOTE: Refer to section 3.3 for duty cycle spectrum plot.

802.11ac (80MHz)

CHANNEL	FREQUENCY (MHz)	PSD W/O DUTY FACTOR (dBm)	DUTY FACTOR	PSD WITH DUTY FACTOR (dBm)	MAXIMUM LIMIT (dBm)	PASS/FAIL
42	5210	-8.09	10.60	2.51	11	PASS

NOTE: Refer to section 3.3 for duty cycle spectrum plot.

SPECTRUM PLOT OF WORST VALUE

802.11a

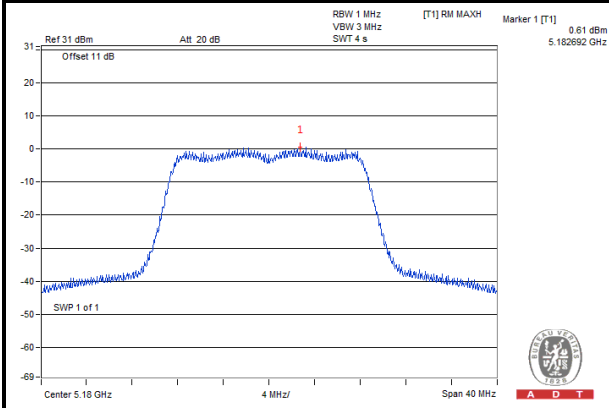

802.11n (20MHz)

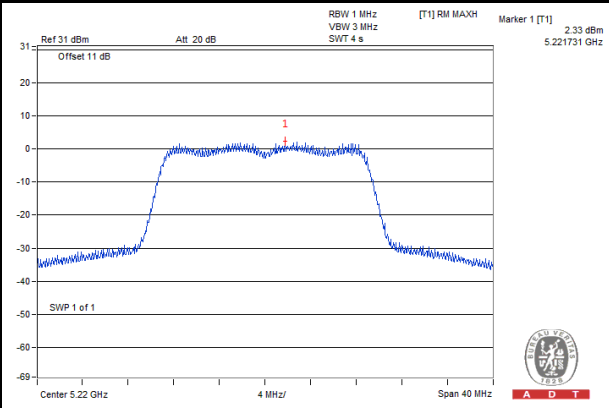

802.11n (40MHz)

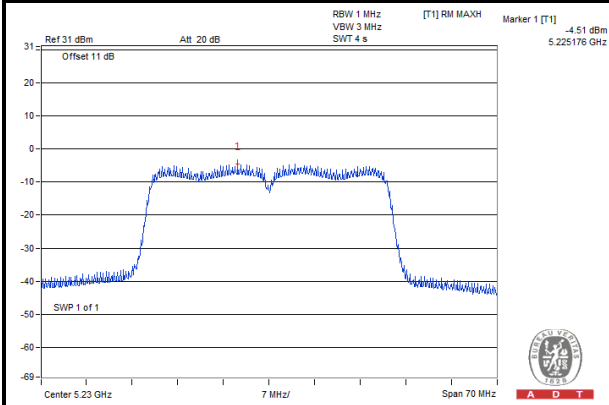

802.11ac (80MHz)

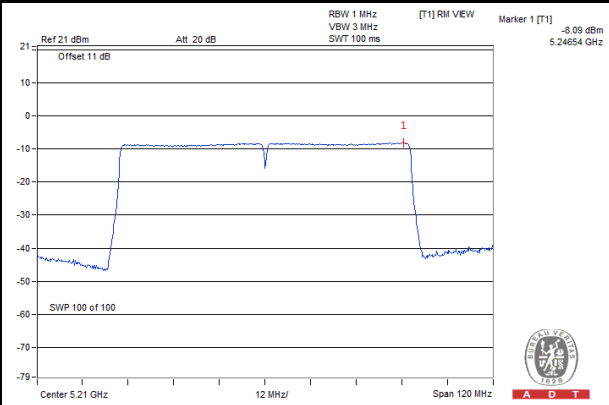

For U-NII-3 Band

802.11a

CHANNEL	FREQUENCY (MHz)	PSD W/O DUTY FACTOR (dBm)	DUTY FACTOR	PSD WITH DUTY FACTOR (dBm)	LIMIT (dBm/500kHz)	PASS/FAIL
149	5745	-0.20	3.39	3.19	30	PASS
157	5785	0.26	3.39	3.65	30	PASS
165	5825	1.24	3.39	4.63	30	PASS

802.11n (20MHz)

CHANNEL	FREQUENCY (MHz)	PSD W/O DUTY FACTOR (dBm)	DUTY FACTOR	PSD WITH DUTY FACTOR (dBm)	LIMIT (dBm/500kHz)	PASS/FAIL
149	5745	0.68	4.13	4.81	30	PASS
157	5785	0.94	4.13	5.07	30	PASS
165	5825	2.11	4.13	6.24	30	PASS

802.11n (40MHz)

CHANNEL	FREQUENCY (MHz)	PSD W/O DUTY FACTOR (dBm)	DUTY FACTOR	PSD WITH DUTY FACTOR (dBm)	LIMIT (dBm/500kHz)	PASS/FAIL
151	5755	-3.40	7.26	3.86	30	PASS
159	5795	-2.66	7.26	4.60	30	PASS

802.11ac (80MHz)

CHANNEL	FREQUENCY (MHz)	PSD W/O DUTY FACTOR (dBm)	DUTY FACTOR	PSD WITH DUTY FACTOR (dBm)	LIMIT (dBm/500kHz)	PASS/FAIL
155	5775	-0.28	10.60	10.32	30	PASS

SPECTRUM PLOT OF WORST VALUE

802.11a

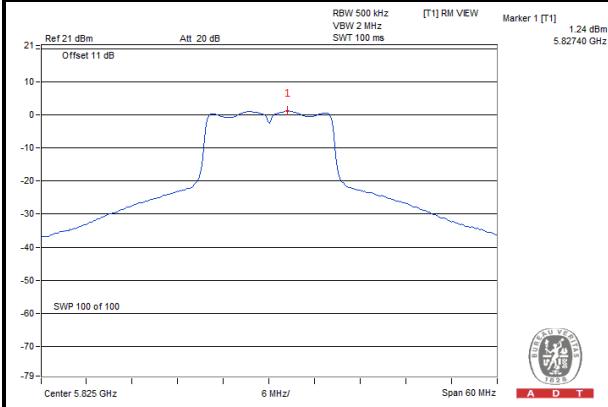

802.11n (20MHz)

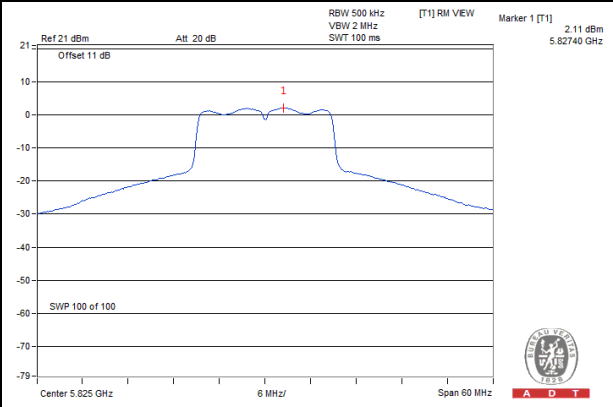

802.11n (40MHz)

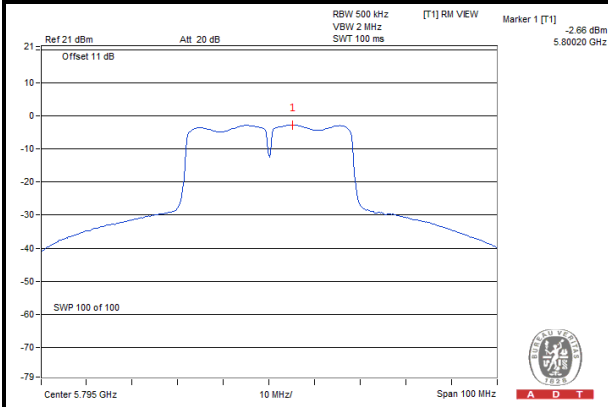

802.11ac (80MHz)

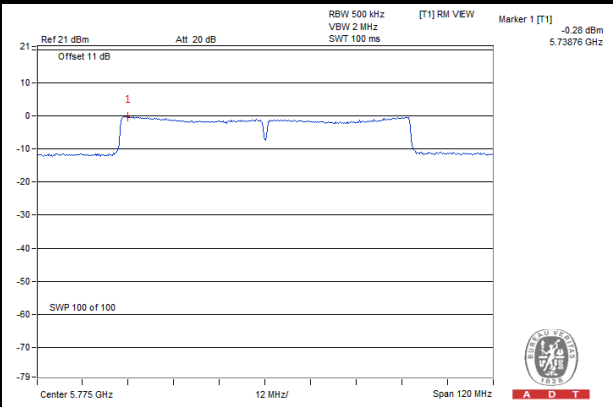

4.5 FREQUENCY STABILITY

4.5.1 LIMITS OF FREQUENCY STABILITY MEASUREMENT

The frequency of the carrier signal shall be maintained within band of operation.

4.5.2 TEST SETUP

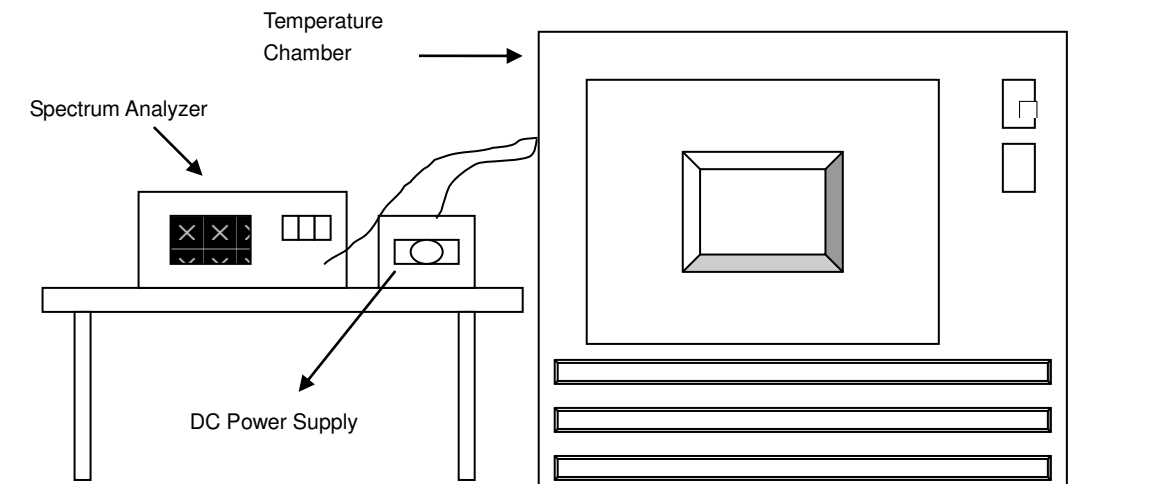

4.5.3 TEST INSTRUMENTS

Refer to section 4.1.3 to get information of above instrument.

4.5.4 TEST PROCEDURE

- a. To ensure emission at the band edge is maintained within the authorized band, those values shall be measured by radiation emissions at upper and lower frequency points, and finally compensated by frequency deviation as procedures below.
- b. The EUT was operated at the maximum output power, and connected to the spectrum analyzer, which is set to maximum hold function and peak detector. The peak value of the power envelope was measured and noted. The upper and lower frequency points were respectively measured relatively 10dB lower than the measured peak value.
- c. The frequency deviation was calculated by adding the upper frequency point and the lower frequency point divided by two. Those detailed values of frequency deviation are provided in table below.

4.5.5 DEVIATION FROM TEST STANDARD

No deviation.

4.5.6 EUT OPERATING CONDITION

Set the EUT transmit at un-modulation mode to test frequency stability.

4.5.7 TEST RESULTS

FREQUENCY STABILITY VERSUS TEMP.									
OPERATING FREQUENCY: 5180MHz									
TEMP. (°C)	POWER SUPPLY (Vdc)	0 MINUTE		2 MINUTE		5 MINUTE		10 MINUTE	
		Measured Frequency (MHz)	Frequency Drift (ppm)	Measured Frequency (MHz)	Frequency Drift (ppm)	Measured Frequency (MHz)	Frequency Drift (ppm)	Measured Frequency (MHz)	Frequency Drift (ppm)
60	5.0	5180.036317	7.011	5180.036156	6.980	5180.036450	7.037	5180.036237	6.996
50	5.0	5180.037288	7.198	5180.037238	7.189	5180.036572	7.060	5180.036869	7.118
40	5.0	5180.037048	7.152	5180.036660	7.077	5180.037135	7.169	5180.037039	7.150
30	5.0	5180.037953	7.327	5180.038350	7.403	5180.038404	7.414	5180.038257	7.386
20	5.0	5180.039440	7.614	5180.039150	7.558	5180.038971	7.523	5180.039183	7.564
10	5.0	5180.040929	7.901	5180.040270	7.774	5180.040218	7.764	5180.040231	7.767
0	5.0	5180.039088	7.546	5180.039096	7.547	5180.038945	7.518	5180.039023	7.533
-10	5.0	5180.037682	7.275	5180.037732	7.284	5180.037373	7.215	5180.037389	7.218
-20	5.0	5180.036865	7.117	5180.036866	7.117	5180.037001	7.143	5180.037413	7.223
-30	5.0	5180.035887	6.928	5180.036278	7.003	5180.036141	6.977	5180.036260	7.000

FREQUENCY STABILITY VERSUS VOLTAGE									
OPERATING FREQUENCY: 5180MHz									
TEMP. (°C)	POWER SUPPLY (Vdc)	0 MINUTE		2 MINUTE		5 MINUTE		10 MINUTE	
		Measured Frequency (MHz)	Frequency Drift (ppm)	Measured Frequency (MHz)	Frequency Drift (ppm)	Measured Frequency (MHz)	Frequency Drift (ppm)	Measured Frequency (MHz)	Frequency Drift (ppm)
20	4.3	5180.038999	7.529	5180.038288	7.392	5180.038567	7.445	5180.038872	7.504
	5.0	5180.039440	7.614	5180.039150	7.558	5180.038971	7.523	5180.039183	7.564
	5.75	5180.040507	7.820	5180.040530	7.824	5180.040162	7.753	5180.040119	7.745

4.6 6dB BANDWIDTH MEASUREMENT

4.6.1 LIMITS OF 6dB BANDWIDTH MEASUREMENT

The minimum of 6dB Bandwidth Measurement is 0.5MHz.

4.6.2 TEST SETUP

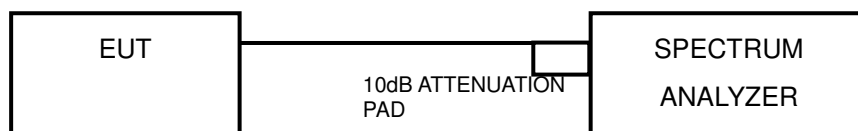

4.6.3 TEST INSTRUMENTS

Refer to section 4.1.3 to get information of above instrument.

4.6.4 TEST PROCEDURE

- Set resolution bandwidth (RBW) = 100kHz
- Set the video bandwidth (VBW) $\geq 3 \times$ RBW, Detector = Peak.
- Trace mode = max hold.
- Sweep = auto couple.
- Measure the maximum width of the emission that is constrained by the frequencies associated with the two amplitude points (upper and lower) that are attenuated by 6 dB relative to the maximum level measured in the fundamental emission.

4.6.5 DEVIATION FROM TEST STANDARD

No deviation.

4.6.6 EUT OPERATING CONDITIONS

The software provided by client to enable the EUT under transmission condition continuously at lowest, middle and highest channel frequencies individually.

4.6.7 TEST RESULTS

802.11a

CHANNEL	FREQUENCY (MHz)	6dB BANDWIDTH (MHz)	MINIMUM LIMIT (MHz)	PASS / FAIL
149	5745	16.34	0.5	PASS
157	5785	16.32	0.5	PASS
165	5825	15.95	0.5	PASS

802.11n (20MHz)

CHANNEL	FREQUENCY (MHz)	6dB BANDWIDTH (MHz)	MINIMUM LIMIT (MHz)	PASS / FAIL
149	5745	17.56	0.5	PASS
157	5785	16.93	0.5	PASS
165	5825	16.83	0.5	PASS

802.11n (40MHz)

CHANNEL	FREQUENCY (MHz)	6dB BANDWIDTH (MHz)	MINIMUM LIMIT (MHz)	PASS / FAIL
151	5755	35.56	0.5	PASS
159	5795	35.25	0.5	PASS

802.11ac (80MHz)

CHANNEL	FREQUENCY (MHz)	6dB BANDWIDTH (MHz)	MINIMUM LIMIT (MHz)	PASS / FAIL
155	5775	74.76	0.5	PASS

SPECTRUM PLOT OF WORST VALUE

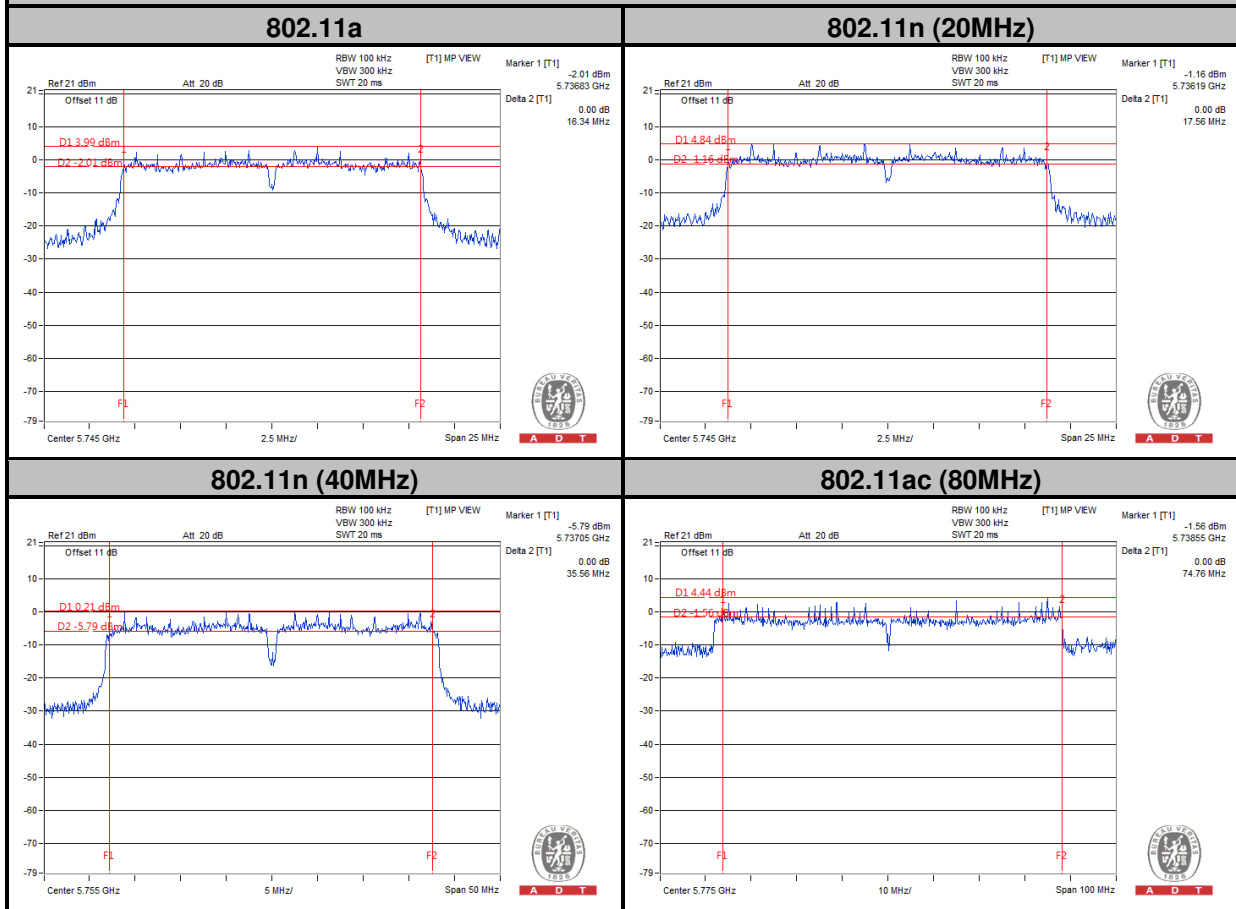

5. PHOTOGRAPHS OF THE TEST CONFIGURATION

Please refer to the attached file (Test Setup Photo).



6. INFORMATION ON THE TESTING LABORATORIES

We, Bureau Veritas Consumer Products Services (H.K.) Ltd., Taoyuan Branch, were founded in 1988 to provide our best service in EMC, Radio, Telecom and Safety consultation. Our laboratories are accredited and approved according to ISO/IEC 17025.

If you have any comments, please feel free to contact us at the following:

Linko EMC/RF Lab:

Tel: 886-2-26052180

Fax: 886-2-26051924

Hsin Chu EMC/RF/Telecom Lab:

Tel: 886-3-5935343

Fax: 886-3-5935342

Hwa Ya EMC/RF/Safety Lab:

Tel: 886-3-3183232

Fax: 886-3-3270892

Email: service.adt@tw.bureauveritas.com

Web Site: www.bureauveritas-adt.com

The address and road map of all our labs can be found in our web site also.

7. APPENDIX A - MODIFICATIONS RECORDERS FOR ENGINEERING CHANGES TO THE EUT BY THE LAB

No any modifications are made to the EUT by the lab during the test.

---END---