



FCC TEST REPORT (15.247)

REPORT NO.: RF150508C06A-6
MODEL: WT2
FCC ID: A4R-WT2
RECEIVED: May 08, 2015
TESTED: Jun. 10, 2015 ~ Aug. 15, 2015
ISSUED: Aug. 05, 2016

APPLICANT: Google Inc.

ADDRESS: 1600 Amphitheatre Parkway Mountain View California
United States 94043

ISSUED BY: Bureau Veritas Consumer Products Services (H.K.)
Ltd., Taoyuan Branch

LAB ADDRESS: No. 47-2, 14th Ling, Chia Pau Vil., Lin Kou Dist., New
Taipei City, Taiwan (R.O.C)

TEST LOCATION: No. 19, Hwa Ya 2nd Rd, Wen Hwa Vil., Kwei Shan
Dist., Taoyuan City 33383, Taiwan (R.O.C.)

This report should not be used by the client to claim product certification, approval, or endorsement by TAF or any government agencies.



This report is for your exclusive use. Any copying or replication of this report to or for any other person or entity, or use of our name or trademark, is permitted only with our prior written permission. This report sets forth our findings solely with respect to the test samples identified herein. The results set forth in this report are not indicative or representative of the quality or characteristics of the lot from which a test sample was taken or any similar or identical product unless specifically and expressly noted. Our report includes all of the tests requested by you and the results thereof based upon the information that you provided to us. You have 60 days from date of issuance of this report to notify us of any material error or omission caused by our negligence, provided, however, that such notice shall be in writing and shall specifically address the issue you wish to raise. A failure to raise such issue within the prescribed time shall constitute your unqualified acceptance of the completeness of this report, the tests conducted and the correctness of the report contents. Unless specific mention, the uncertainty of measurement has been explicitly taken into account to declare the compliance or non-compliance to the specification.

TABLE OF CONTENTS

Preface	3
RELEASE CONTROL RECORD	4
1. CERTIFICATION.....	5
2. SUMMARY OF TEST RESULTS	6
2.1 MEASUREMENT UNCERTAINTY.....	6
3. GENERAL INFORMATION	7
3.1 GENERAL DESCRIPTION OF EUT	7
3.2 DESCRIPTION OF TEST MODES	8
3.2.1 TEST MODE APPLICABILITY AND TESTED CHANNEL DETAIL	9
3.3 DESCRIPTION OF SUPPORT UNITS	10
3.3.1 CONFIGURATION OF SYSTEM UNDER TEST	10
3.4 GENERAL DESCRIPTION OF APPLIED STANDARDS	11
4. TEST TYPES AND RESULTS (FOR 2.4GHz BAND)	12
4.1 RADIATED EMISSION AND BANDEDGE MEASUREMENT	12
4.1.1 LIMITS OF RADIATED EMISSION AND BANDEDGE MEASUREMENT	12
4.1.2 TEST INSTRUMENTS.....	13
4.1.3 TEST PROCEDURES	14
4.1.4 DEVIATION FROM TEST STANDARD	14
4.1.5 TEST SETUP	15
4.1.6 EUT OPERATING CONDITIONS	15
4.1.7 TEST RESULTS.....	16
4.2 CONDUCTED EMISSION MEASUREMENT	29
4.2.1 LIMITS OF CONDUCTED EMISSION MEASUREMENT	29
4.2.2 TEST INSTRUMENTS.....	29
4.2.3 TEST PROCEDURES	30
4.2.4 DEVIATION FROM TEST STANDARD	30
4.2.5 TEST SETUP	31
4.2.6 EUT OPERATING CONDITIONS	31
4.2.7 TEST RESULTS.....	32
4.3 CONDUCTED OUTPUT POWER	34
4.3.1 LIMITS OF CONDUCTED OUTPUT POWER MEASUREMENT	34
4.3.2 TEST SETUP	34
4.3.3 TEST INSTRUMENTS.....	34
4.3.4 TEST PROCEDURES	34
4.3.5 DEVIATION FROM TEST STANDARD	34
4.3.6 EUT OPERATING CONDITIONS	34
4.3.7 TEST RESULTS.....	35
5. PHOTOGRAPHS OF THE TEST CONFIGURATION.....	36
6. INFORMATION ON THE TESTING LABORATORIES	37
7. APPENDIX A – MODIFICATIONS RECORDERS FOR ENGINEERING CHANGES TO THE EUT BY THE LAB	38



Preface

To whom it may concern,

We hereby declare that the integrated module-end product (FCC ID: A4R-WT2) is identical to the integrated module-end product (FCC ID: A4R-WT1) in the WLAN layout of the circuit, components and transmit power levels. The difference is only to add LTE function into the integrated module-end product and change the model name from WT1 to WT2.

Based on the similarity between both modules, we hereby request to leverage the all test data of FCC ID: A4R-WT1 described as below to demonstrate the compliance of FCC ID: A4R-WT2 for part 15C.

The list of reference details (Re-use the test data from the original integrated module-end product):

Equipment Class	Reference FCC ID	Reference to the test sections from FCC test report RF150508C06-6	
DTS	A4R-WT1	4.1	Radiated Emission and Bandedge Measurement
		4.2	Conducted Emission Measurement
		4.3	Conducted Output Power



RELEASE CONTROL RECORD

ISSUE NO.	REASON FOR CHANGE	DATE ISSUED
RF150508C06A-6	Original release	Aug. 05, 2016



1. CERTIFICATION

PRODUCT NAME/DESCRIPTION: Connectivity Bridge
MODEL: WT2
BRAND: Google
APPLICANT: Google Inc.
TESTED: Jun. 10, 2015 ~ Aug. 15, 2015
TEST SAMPLE: Identical Prototype
STANDARDS: **FCC Part 15, Subpart C (Section 15.247)**
ANSI C63.10-2013

The above equipment (model: WT2) has been tested by **Bureau Veritas Consumer Products Services (H.K.) Ltd., Taoyuan Branch**, and found compliance with the requirement of the above standards. The test record, data evaluation & Equipment Under Test (EUT) configurations represented herein are true and accurate accounts of the measurements of the sample's EMC characteristics under the conditions specified in this report.

PREPARED BY : Evonne Liu , **DATE** : Aug. 05, 2016
Evonne Liu / Specialist

APPROVED BY : Stanley Wu , **DATE** : Aug. 05, 2016
Stanley Wu / Assistant Manager

2. SUMMARY OF TEST RESULTS

The EUT has been tested according to the following specifications:

APPLIED STANDARD: FCC PART 15, SUBPART C (SECTION 15.247)			
STANDARD SECTION	TEST TYPE	RESULT	REMARK
15.207	AC Power Conducted Emission	PASS	Meet the requirement of limit. Minimum passing margin is -17.51dB at 0.49799MHz.
15.205 & 15.209	Radiated Emissions	PASS	Meet the requirement of limit. Minimum passing margin is -1.11dB at 2488MHz.
15.247(d)	Band Edge Measurement	Not Applicable	Refer to Note
15.247(d)	Antenna Port Emission	Not Applicable	Refer to Note
15.247(a)(2)	6dB bandwidth	Not Applicable	Refer to Note
15.247(b)	Conducted power	PASS	Meet the requirement of limit.
15.247(e)	Power Spectral Density	Not Applicable	Refer to Note
15.203	Antenna Requirement	Not Applicable	Refer to Note

NOTE:

1. Only the test item for conducted power, conducted and radiated emission had been tested for this addendum and the conducted data is referring to module report (Report No.: RF140407E07).

2.1 MEASUREMENT UNCERTAINTY

Where relevant, the following measurement uncertainty levels have been estimated for tests performed on the EUT as specified in CISPR 16-4-2:

MEASUREMENT	FREQUENCY	UNCERTAINTY
Conducted emissions	9kHz~30MHz	2.44 dB
Radiated emissions	9kHz ~ 30MHz	2.14 dB
	30MHz ~ 200MHz	2.93 dB
	200MHz ~ 1000MHz	2.95 dB
	1GHz ~ 18GHz	2.26 dB
	18GHz ~ 40GHz	1.94 dB

This uncertainty represents an expanded uncertainty expressed at approximately the 95% confidence level using a coverage factor of $k = 2$.

3. GENERAL INFORMATION

3.1 GENERAL DESCRIPTION OF EUT

PRODUCT NAME/DESCRIPTION	Connectivity Bridge
MODEL	WT2
POWER SUPPLY	5.0Vdc (adapter)
MODULATION TYPE	CCK, DQPSK, DBPSK for DSSS 64QAM, 16QAM, QPSK, BPSK for OFDM
MODULATION TECHNOLOGY	DSSS, OFDM
TRANSFER RATE	802.11b: 11.0 / 5.5 / 2.0 / 1.0 Mbps 802.11g: 54.0 / 48.0 / 36.0 / 24.0 / 18.0 / 12.0 / 9.0 / 6.0 Mbps 802.11n: up to MCS7
OPERATING FREQUENCY	2412 ~ 2462MHz
NUMBER OF CHANNEL	11 for 802.11b, 802.11g, 802.11n (20MHz) 7 for 802.11n (40MHz)
OUTPUT POWER	621.628mW
ANTENNA TYPE	FPCB antenna with 4.06dBi gain
ANTENNA CONNECTOR	NA
DATA CABLE	Refer to Note as below
I/O PORTS	Refer to user's manual
ACCESSORY DEVICES	Refer to Note as below

NOTE:

1. The EUT contains following accessory devices.

ITEM	BRAND	MODEL	SPECIFICATION
Adapter	TPT	MII050200	I/P: 100-240Vac, 50-60Hz, 0.3A O/P: 5Vdc, 2A
WWAN Module	Telit	LE910-NAG	--
WiFi Module	AzureWave	AW-CM389NF	--

2. The EUT incorporates a MIMO function. Physically, the EUT provides two completed transmitters and two receivers.

MODULATION MODE	TX FUNCTION
802.11b	2TX
802.11g	2TX
802.11n (20MHz)	2TX
802.11n (40MHz)	2TX

3. The above EUT information is declared by the manufacturer and for more detailed features description, please refer to the manufacturer's specifications or User's Manual.

3.2 DESCRIPTION OF TEST MODES

FOR 2.4GHz:

11 channels are provided for 802.11b, 802.11g and 802.11n (20MHz):

CHANNEL	FREQUENCY	CHANNEL	FREQUENCY
1	2412MHz	7	2442MHz
2	2417MHz	8	2447MHz
3	2422MHz	9	2452MHz
4	2427MHz	10	2457MHz
5	2432MHz	11	2462MHz
6	2437MHz		

7 channels are provided for 802.11n (40MHz):

CHANNEL	FREQUENCY	CHANNEL	FREQUENCY
3	2422MHz	7	2442MHz
4	2427MHz	8	2447MHz
5	2432MHz	9	2452MHz
6	2437MHz		

3.2.1 TEST MODE APPLICABILITY AND TESTED CHANNEL DETAIL

WLAN 2.4GHz:

EUT CONFIGURE MODE	APPLICABLE TO				DESCRIPTION
	RE≥1G	RE<1G	PLC	APCM	
-	√	√	√	√	-

Where **RE≥1G**: Radiated Emission above 1GHz **RE<1G**: Radiated Emission below 1GHz
PLC: Power Line Conducted Emission **APCM**: Antenna Port Conducted Measurement

RADIATED EMISSION TEST (ABOVE 1GHz):

- Pre-Scan has been conducted to determine the worst-case mode from all possible combinations between available modulations, data rates and antenna ports (if EUT with antenna diversity architecture).
- Following channel(s) was (were) selected for the final test as listed below.

EUT CONFIGURE MODE	MODE	AVAILABLE CHANNEL	TESTED CHANNEL	MODULATION TECHNOLOGY	MODULATION TYPE	DATA RATE (Mbps)
-	802.11b	1 to 11	1, 6, 11	DSSS	DBPSK	1.0
-	802.11g	1 to 11	1, 6, 11	OFDM	BPSK	6.0
-	802.11n (20MHz)	1 to 11	1, 6, 11	OFDM	BPSK	MCS0
-	802.11n (40MHz)	3 to 9	3, 6, 9	OFDM	BPSK	MCS0

RADIATED EMISSION TEST (BELOW 1GHz):

- Pre-Scan has been conducted to determine the worst-case mode from all possible combinations between available modulations, data rates and antenna ports (if EUT with antenna diversity architecture).
- Following channel(s) was (were) selected for the final test as listed below.

EUT CONFIGURE MODE	MODE	AVAILABLE CHANNEL	TESTED CHANNEL	MODULATION TECHNOLOGY	MODULATION TYPE	DATA RATE (Mbps)
-	802.11n (20MHz)	1 to 11	11	OFDM	BPSK	MCS0

POWER LINE CONDUCTED EMISSION TEST:

- Pre-Scan has been conducted to determine the worst-case mode from all possible combinations between available modulations, data rates and antenna ports (if EUT with antenna diversity architecture).
- Following channel(s) was (were) selected for the final test as listed below.

EUT CONFIGURE MODE	MODE	AVAILABLE CHANNEL	TESTED CHANNEL	MODULATION TECHNOLOGY	MODULATION TYPE	DATA RATE (Mbps)
-	802.11n (20MHz)	1 to 11	11	OFDM	BPSK	MCS0

ANTENNA PORT CONDUCTED MEASUREMENT:

- This item includes all test value of each mode, but only includes spectrum plot of worst value of each mode.
- Pre-Scan has been conducted to determine the worst-case mode from all possible combinations between available modulations, data rates and antenna ports (if EUT with antenna diversity architecture).
- Following channel(s) was (were) selected for the final test as listed below.

EUT CONFIGURE MODE	MODE	AVAILABLE CHANNEL	TESTED CHANNEL	MODULATION TECHNOLOGY	MODULATION TYPE	DATA RATE (Mbps)
-	802.11b	1 to 11	1, 6, 11	DSSS	DBPSK	1.0
-	802.11g	1 to 11	1, 6, 11	OFDM	BPSK	6.0
-	802.11n (20MHz)	1 to 11	1, 6, 11	OFDM	BPSK	MCS0

TEST CONDITION:

APPLICABLE TO	ENVIRONMENTAL CONDITIONS	INPUT POWER	TESTED BY
RE \geq 1G	25deg. C, 65%RH	120Vac, 60Hz	Karl Lee
RE<1G	25deg. C, 65%RH	120Vac, 60Hz	Charles Hsiao
PLC	25deg. C, 65%RH	120Vac, 60Hz	Toby Tian
APCM	25deg. C, 65%RH	120Vac, 60Hz	Taylor Liu

3.3 DESCRIPTION OF SUPPORT UNITS

The EUT has been tested as an independent unit together with other necessary accessories or support units.

3.3.1 CONFIGURATION OF SYSTEM UNDER TEST

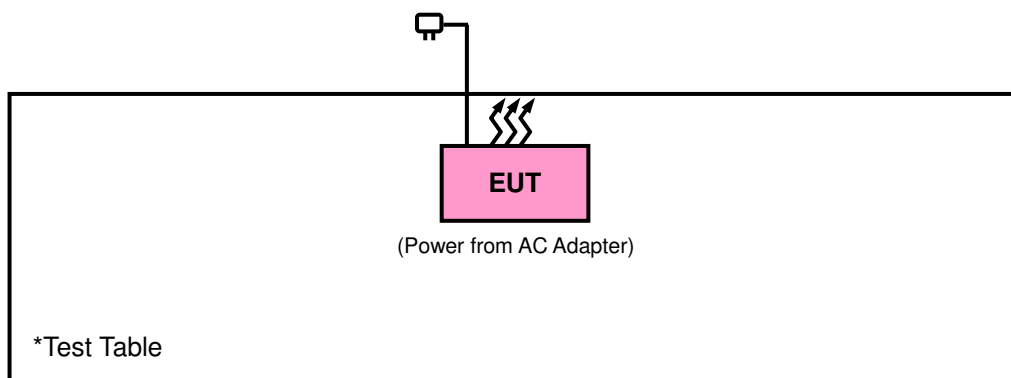



3.4 GENERAL DESCRIPTION OF APPLIED STANDARDS

The EUT is a RF Product. According to the specifications of the manufacturer, it must comply with the requirements of the following standards:

FCC Part 15, Subpart C (15.247)

558074 D01 DTS Meas Guidance v03r05

662911 D01 Multiple Transmitter Output v02r01

ANSI C63.10-2013

All test items have been performed and recorded as per the above standards.

NOTE: The EUT has been verified to comply with the requirements of FCC Part 15, Subpart B, Class B (DoC). The test report has been issued separately.

4. TEST TYPES AND RESULTS (FOR 2.4GHz BAND)

4.1 RADIATED EMISSION AND BANDEDGE MEASUREMENT

4.1.1 LIMITS OF RADIATED EMISSION AND BANDEDGE MEASUREMENT

Radiated emissions which fall in the restricted bands must comply with the radiated emission limits specified as below table. Other emissions shall be at least 20dB below the highest level of the desired power:

FREQUENCIES (MHz)	FIELD STRENGTH (microvolts/meter)	MEASUREMENT DISTANCE (meters)
0.009 ~ 0.490	2400/F(kHz)	300
0.490 ~ 1.705	24000/F(kHz)	30
1.705 ~ 30.0	30	30
30 ~ 88	100	3
88 ~ 216	150	3
216 ~ 960	200	3
Above 960	500	3

NOTE:

1. The lower limit shall apply at the transition frequencies.
2. Emission level (dBuV/m) = 20 log Emission level (uV/m).
3. For frequencies above 1000MHz, the field strength limits are based on average detector, however, the peak field strength of any emission shall not exceed the maximum permitted average limits, specified above by more than 20dB under any condition of modulation.

4.1.2 TEST INSTRUMENTS

DESCRIPTION & MANUFACTURER	MODEL NO.	SERIAL NO.	DATE OF CALIBRATION	DUE DATE OF CALIBRATION
Test Receiver Agilent	N9038A	MY51210203	Jan.21, 2015	Jan.21, 2016
Spectrum Analyzer Agilent	N9010A	MY52220314	Sep.03, 2014	Sep.02, 2015
Spectrum Analyzer ROHDE & SCHWARZ	FSU43	101261	Dec. 10, 2014	Dec. 09, 2015
BILOG Antenna SCHWARZBECK	VULB9168	9168-472	Feb. 04, 2015	Feb. 04, 2016
HORN Antenna SCHWARZBECK	BBHA 9120 D	9120D-969	Feb. 09, 2015	Feb. 09, 2016
HORN Antenna SCHWARZBECK	BBHA 9170	9170-480	Feb. 04, 2015	Feb. 04, 2016
Preamplifier EMCI	EMC 012645	980115	Dec. 12, 2014	Dec. 11, 2015
Preamplifier EMCI	EMC 184045	980116	Jan. 09, 2015	Jan. 08, 2016
Preamplifier EMCI	EMC 330H	980112	Dec. 27, 2014	Dec. 26, 2015
RF signal cable HUBER+SUHNNER	SUCOFLEX 104	309219/4 2950114	Oct. 18, 2014	Oct. 17, 2015
RF signal cable HUBER+SUHNNER	SUCOFLEX 104	250130/4	Oct. 18, 2014	Oct. 17, 2015
RF signal cable Worken	RG-213	NA	Nov. 07, 2014	Nov. 06, 2015
Software BV ADT	E3 6.120103	NA	NA	NA
Antenna Tower MF	MFA-440H	NA	NA	NA
Turn Table MF	MFT-201SS	NA	NA	NA
Antenna Tower & Turn Table Controller MF	MF-7802	NA	NA	NA
Bluetooth Tester	CBT	100980	Feb. 10, 2015	Feb. 09, 2016
Power Meter	ML2495A	1232002	Sep. 17, 2014	Sep. 16, 2015
Power Sensor	MA2411B	1207325	Sep. 17, 2014	Sep. 16, 2015

- NOTE:**
1. The calibration interval of the above test instruments is 12 months and the calibrations are traceable to NML/ROC and NIST/USA.
 2. The calibration interval of the loop antenna is 24 months and the calibrations are traceable to NML/ROC and NIST/USA.
 3. The test was performed in HwaYa Chamber 10.
 4. The horn antenna and HP preamplifier (model: 8449B) are used only for the measurement of emission frequency above 1GHz if tested.
 5. The FCC Site Registration No. is 690701.
 6. The IC Site Registration No. is IC 7450F-10.

4.1.3 TEST PROCEDURES

- a. The EUT was placed on the top of a rotating table 0.8 meters (for below 1GHz) / 1.5 meters (for above 1GHz) above the ground at 3 meter chamber room for test. The table was rotated 360 degrees to determine the position of the highest radiation.
- b. The EUT was set 3 meters away from the interference-receiving antenna, which was mounted on the top of a variable-height antenna tower.
- c. Height of receiving antenna is varied from one meter to four meters above the ground to determine the maximum value of the field strength. Both horizontal and vertical polarizations of the antenna are set to make the measurement.
- d. For each suspected emission, the EUT was arranged to its worst case and then the antenna was tuned to heights from 1 meter to 4 meters and the rotatable table was turned from 0 degrees to 360 degrees to find the maximum reading.
- e. The test-receiver system was set to Peak Detect Function and Specified Bandwidth with Maximum Hold Mode.
- f. If the emission level of the EUT in peak mode was lower than the limit specified, then testing could be stopped and the peak values of the EUT would be reported. Otherwise the emissions would be re-tested one by one using peak, quasi-peak or average method as specified and then reported in a data sheet.

NOTE:

1. The resolution bandwidth and video bandwidth of test receiver/spectrum analyzer is 120kHz for Quasi-peak detection at frequency below 1GHz.
2. The resolution bandwidth of test receiver/spectrum analyzer is 1MHz and video bandwidth is 3MHz for Peak detection at frequency above 1GHz.
3. The resolution bandwidth of test receiver/spectrum analyzer is 1MHz and the video bandwidth is 1kHz (Duty cycle < 98%) or 10Hz (Duty cycle > 98%) for Average detection (AV) at frequency above 1GHz.
4. All modes of operation were investigated and the worst-case emissions are reported.

4.1.4 DEVIATION FROM TEST STANDARD

No deviation.

4.1.5 TEST SETUP

<Frequency Range 30MHz ~ 1GHz>

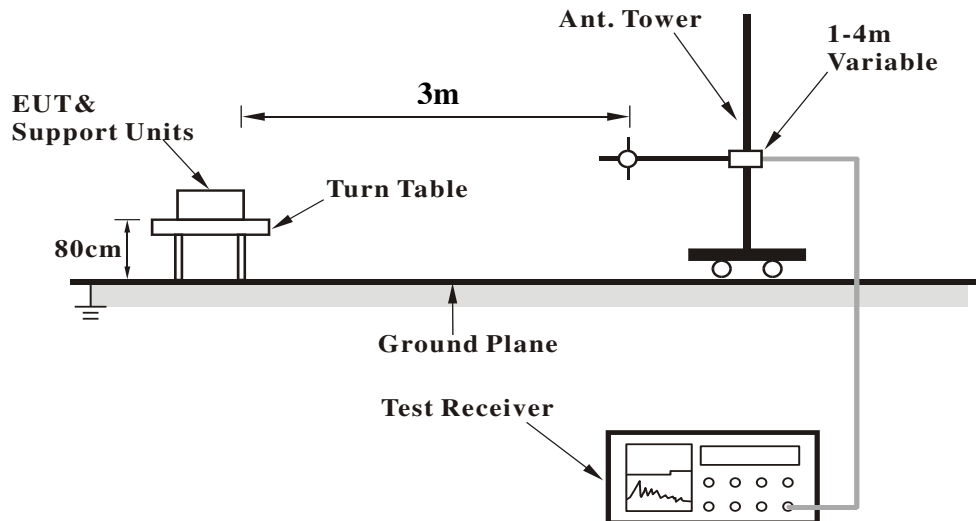

<Frequency Range above 1GHz>

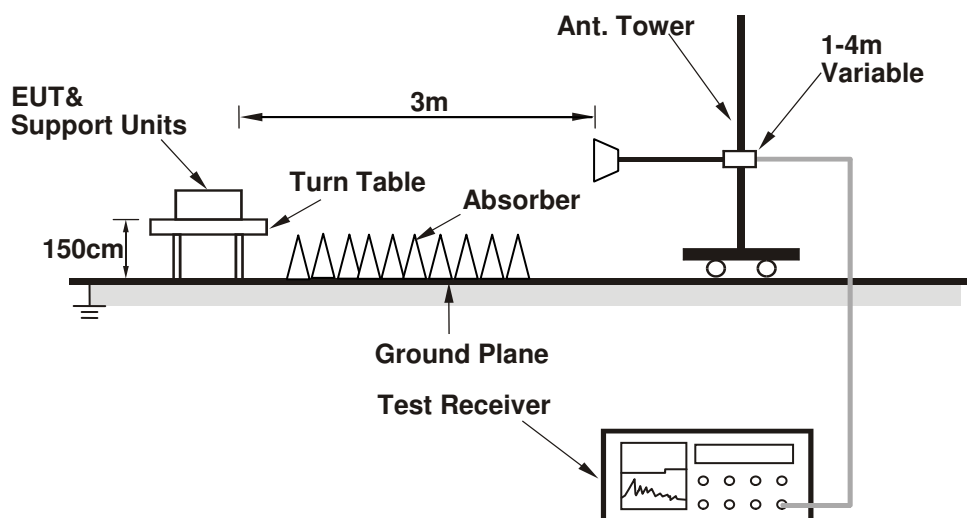

For the actual test configuration, please refer to the attached file (Test Setup Photo).

4.1.6 EUT OPERATING CONDITIONS

- Placed the EUT on a testing table.
- Use the software to control the EUT under transmission condition continuously at specific channel frequency.

4.1.7 TEST RESULTS

ABOVE 1GHz WORST-CASE DATA

802.11b

EUT TEST CONDITION		MEASUREMENT DETAIL	
CHANNEL	Channel 1	FREQUENCY RANGE	1GHz ~ 25GHz
INPUT POWER	120Vac, 60 Hz	DETECTOR FUNCTION	Peak (PK) Average (AV)
ENVIRONMENTAL CONDITIONS	25deg. C, 65%RH	TESTED BY	Karl Lee

ANTENNA POLARITY & TEST DISTANCE: HORIZONTAL AT 3 M										
FREQ. (MHz)	EMISSION LEVEL (dBuV/m)	READ LEVEL (dBuV)	LIMIT (dBuV/m)	MARGIN (dB)	ANTENNA FACTOR (dB/m)	CABLE LOSS (dB)	PREAMP FACTOR (dB)	ANTENNA HEIGHT (cm)	TABLE ANGLE (Degree)	REMARK
2384	41.3	39.61	54	-12.7	31.78	5.4	35.49	166	193	Average
2384	56.35	54.66	74	-17.65	31.78	5.4	35.49	166	193	Peak
2412	101.2	99.43			31.81	5.43	35.47	166	193	Average
2412	104.9	103.13			31.81	5.43	35.47	166	193	Peak
2490	40.69	38.68	54	-13.31	31.9	5.53	35.42	166	193	Average
2490	56.85	54.84	74	-17.15	31.9	5.53	35.42	166	193	Peak
ANTENNA POLARITY & TEST DISTANCE: VERTICAL AT 3 M										
FREQ. (MHz)	EMISSION LEVEL (dBuV/m)	READ LEVEL (dBuV)	LIMIT (dBuV/m)	MARGIN (dB)	ANTENNA FACTOR (dB/m)	CABLE LOSS (dB)	PREAMP FACTOR (dB)	ANTENNA HEIGHT (cm)	TABLE ANGLE (Degree)	REMARK
2360	40.36	38.73	54	-13.64	31.76	5.37	35.5	119	266	Average
2360	55.94	54.31	74	-18.06	31.76	5.37	35.5	119	266	Peak
2412	99.65	97.88			31.81	5.43	35.47	119	266	Average
2412	102.15	100.38			31.81	5.43	35.47	119	266	Peak
2490	40.8	38.79	54	-13.2	31.9	5.53	35.42	119	266	Average
2490	55.8	53.79	74	-18.2	31.9	5.53	35.42	119	266	Peak

REMARKS:

- Emission Level = Read Level + Antenna Factor + Cable Loss - Preamp Factor
Margin value = Emission level – Limit value
- 2412MHz: Fundamental frequency.

EUT TEST CONDITION		MEASUREMENT DETAIL	
CHANNEL	Channel 6	FREQUENCY RANGE	1GHz ~ 25GHz
INPUT POWER	120Vac, 60 Hz	DETECTOR FUNCTION	Peak (PK) Average (AV)
ENVIRONMENTAL CONDITIONS	25deg. C, 65%RH	TESTED BY	Karl Lee

ANTENNA POLARITY & TEST DISTANCE: HORIZONTAL AT 3 M										
FREQ. (MHz)	EMISSION LEVEL (dBuV/m)	READ LEVEL (dBuV)	LIMIT (dBuV/m)	MARGIN (dB)	ANTENNA FACTOR (dB/m)	CABLE LOSS (dB)	PREAMP FACTOR (dB)	ANTENNA HEIGHT (cm)	TABLE ANGLE (Degree)	REMARK
2390	40.06	38.33	54	-13.94	31.8	5.4	35.47	142	159	Average
2390	55.84	54.11	74	-18.16	31.8	5.4	35.47	142	159	Peak
2437	100.66	98.81			31.85	5.46	35.46	142	159	Average
2437	103.98	102.13			31.85	5.46	35.46	142	159	Peak
2488	40.76	38.75	54	-13.24	31.9	5.53	35.42	142	159	Average
2488	56.43	54.42	74	-17.57	31.9	5.53	35.42	142	159	Peak

ANTENNA POLARITY & TEST DISTANCE: VERTICAL AT 3 M										
FREQ. (MHz)	EMISSION LEVEL (dBuV/m)	READ LEVEL (dBuV)	LIMIT (dBuV/m)	MARGIN (dB)	ANTENNA FACTOR (dB/m)	CABLE LOSS (dB)	PREAMP FACTOR (dB)	ANTENNA HEIGHT (cm)	TABLE ANGLE (Degree)	REMARK
2374	42.03	40.37	54	-11.97	31.78	5.37	35.49	119	159	Average
2374	55.71	54.05	74	-18.29	31.78	5.37	35.49	119	159	Peak
2437	98.87	97.02			31.85	5.46	35.46	119	159	Average
2437	101.29	99.44			31.85	5.46	35.46	119	159	Peak
2492	40.64	38.62	54	-13.36	31.9	5.53	35.41	119	159	Average
2492	56.88	54.86	74	-17.12	31.9	5.53	35.41	119	159	Peak

REMARKS:

- Emission Level = Read Level + Antenna Factor + Cable Loss - Preamp Factor
Margin value = Emission level – Limit value
- 2437MHz: Fundamental frequency.

EUT TEST CONDITION		MEASUREMENT DETAIL	
CHANNEL	Channel 11	FREQUENCY RANGE	1GHz ~ 25GHz
INPUT POWER	120Vac, 60 Hz	DETECTOR FUNCTION	Peak (PK) Average (AV)
ENVIRONMENTAL CONDITIONS	25deg. C, 65%RH	TESTED BY	Karl Lee

ANTENNA POLARITY & TEST DISTANCE: HORIZONTAL AT 3 M										
FREQ. (MHz)	EMISSION LEVEL (dBuV/m)	READ LEVEL (dBuV)	LIMIT (dBuV/m)	MARGIN (dB)	ANTENNA FACTOR (dB/m)	CABLE LOSS (dB)	PREAMP FACTOR (dB)	ANTENNA HEIGHT (cm)	TABLE ANGLE (Degree)	REMARK
2390	40.07	38.34	54	-13.93	31.8	5.4	35.47	141	193	Average
2390	55.63	53.9	74	-18.37	31.8	5.4	35.47	141	193	Peak
2462	100.17	98.24			31.87	5.5	35.44	141	193	Average
2462	103.82	101.89			31.87	5.5	35.44	141	193	Peak
2490	40.99	38.98	54	-13.01	31.9	5.53	35.42	141	193	Average
2490	55.64	53.63	74	-18.36	31.9	5.53	35.42	141	193	Peak
ANTENNA POLARITY & TEST DISTANCE: VERTICAL AT 3 M										
FREQ. (MHz)	EMISSION LEVEL (dBuV/m)	READ LEVEL (dBuV)	LIMIT (dBuV/m)	MARGIN (dB)	ANTENNA FACTOR (dB/m)	CABLE LOSS (dB)	PREAMP FACTOR (dB)	ANTENNA HEIGHT (cm)	TABLE ANGLE (Degree)	REMARK
2378	40.1	38.44	54	-13.9	31.78	5.37	35.49	119	259	Average
2378	55.65	53.99	74	-18.35	31.78	5.37	35.49	119	259	Peak
2462	98.93	97			31.87	5.5	35.44	119	259	Average
2462	101.22	99.29			31.87	5.5	35.44	119	259	Peak
2484	41.34	39.38	54	-12.66	31.88	5.5	35.42	119	259	Average
2484	55.93	53.97	74	-18.07	31.88	5.5	35.42	119	259	Peak

REMARKS:

- Emission Level = Read Level + Antenna Factor + Cable Loss - Preamp Factor
Margin value = Emission level – Limit value
- 2462MHz: Fundamental frequency.

802.11g

EUT TEST CONDITION		MEASUREMENT DETAIL	
CHANNEL	Channel 1	FREQUENCY RANGE	1GHz ~ 25GHz
INPUT POWER	120Vac, 60 Hz	DETECTOR FUNCTION	Peak (PK) Average (AV)
ENVIRONMENTAL CONDITIONS	25deg. C, 65%RH	TESTED BY	Karl Lee

ANTENNA POLARITY & TEST DISTANCE: HORIZONTAL AT 3 M										
FREQ. (MHz)	EMISSION LEVEL (dBuV/m)	READ LEVEL (dBuV)	LIMIT (dBuV/m)	MARGIN (dB)	ANTENNA FACTOR (dB/m)	CABLE LOSS (dB)	PREAMP FACTOR (dB)	ANTENNA HEIGHT (cm)	TABLE ANGLE (Degree)	REMARK
2390	51.14	49.41	54	-2.86	31.8	5.4	35.47	114	162	Average
2390	66.9	65.17	74	-7.1	31.8	5.4	35.47	114	162	Peak
2412	97.05	95.28			31.81	5.43	35.47	166	193	Average
2412	104.26	102.49			31.81	5.43	35.47	166	193	Peak
2486	40.72	38.73	54	-13.28	31.88	5.53	35.42	166	193	Average
2486	55.97	53.98	74	-18.03	31.88	5.53	35.42	166	193	Peak
4824	42.73	34.6	54	-11.27	33.97	8.26	34.1	101	224	Average
4824	53.46	45.33	74	-20.54	33.97	8.26	34.1	101	224	Peak
ANTENNA POLARITY & TEST DISTANCE: VERTICAL AT 3 M										
FREQ. (MHz)	EMISSION LEVEL (dBuV/m)	READ LEVEL (dBuV)	LIMIT (dBuV/m)	MARGIN (dB)	ANTENNA FACTOR (dB/m)	CABLE LOSS (dB)	PREAMP FACTOR (dB)	ANTENNA HEIGHT (cm)	TABLE ANGLE (Degree)	REMARK
2390	45.12	43.39	54	-8.88	31.8	5.4	35.47	119	266	Average
2390	59.59	57.86	74	-14.41	31.8	5.4	35.47	119	266	Peak
2412	94.64	92.87			31.81	5.43	35.47	119	266	Average
2412	102.27	100.5			31.81	5.43	35.47	119	266	Peak
2498	41.44	39.42	54	-12.56	31.9	5.53	35.41	119	266	Average
2498	57.11	55.09	74	-16.89	31.9	5.53	35.41	119	266	Peak
4824	43.57	35.44	54	-10.43	33.97	8.26	34.1	100	298	Average
4824	54.8	46.67	74	-19.2	33.97	8.26	34.1	100	298	Peak

REMARKS:

- Emission Level = Read Level + Antenna Factor + Cable Loss - Preamp Factor
Margin value = Emission level – Limit value
- 2412MHz: Fundamental frequency.

EUT TEST CONDITION		MEASUREMENT DETAIL	
CHANNEL	Channel 6	FREQUENCY RANGE	1GHz ~ 25GHz
INPUT POWER	120Vac, 60 Hz	DETECTOR FUNCTION	Peak (PK) Average (AV)
ENVIRONMENTAL CONDITIONS	25deg. C, 65%RH	TESTED BY	Karl Lee

ANTENNA POLARITY & TEST DISTANCE: HORIZONTAL AT 3 M										
FREQ. (MHz)	EMISSION LEVEL (dBuV/m)	READ LEVEL (dBuV)	LIMIT (dBuV/m)	MARGIN (dB)	ANTENNA FACTOR (dB/m)	CABLE LOSS (dB)	PREAMP FACTOR (dB)	ANTENNA HEIGHT (cm)	TABLE ANGLE (Degree)	REMARK
2390	50.83	49.1	54	-3.17	31.8	5.4	35.47	154	159	Average
2390	65.34	63.61	74	-8.66	31.8	5.4	35.47	154	159	Peak
2437	101.96	100.11			31.85	5.46	35.46	142	159	Average
2437	109.45	107.6			31.85	5.46	35.46	142	159	Peak
2484	47.69	45.73	54	-6.31	31.88	5.5	35.42	142	159	Average
2484	63.62	61.66	74	-10.38	31.88	5.5	35.42	142	159	Peak
4874	47.99	39.8	54	-6.01	33.98	8.27	34.06	100	211	Average
4874	59.3	51.11	74	-14.7	33.98	8.27	34.06	100	211	Peak
7311	49.87	39.38	54	-4.13	35.54	9.95	35	107	0	Average
7311	61.05	50.56	74	-12.95	35.54	9.95	35	107	0	Peak

ANTENNA POLARITY & TEST DISTANCE: VERTICAL AT 3 M										
FREQ. (MHz)	EMISSION LEVEL (dBuV/m)	READ LEVEL (dBuV)	LIMIT (dBuV/m)	MARGIN (dB)	ANTENNA FACTOR (dB/m)	CABLE LOSS (dB)	PREAMP FACTOR (dB)	ANTENNA HEIGHT (cm)	TABLE ANGLE (Degree)	REMARK
2390	48.66	46.93	54	-5.34	31.8	5.4	35.47	105	159	Average
2390	63.81	62.08	74	-10.19	31.8	5.4	35.47	105	159	Peak
2437	99.29	97.44			31.85	5.46	35.46	105	159	Average
2437	107.46	105.61			31.85	5.46	35.46	105	159	Peak
2484	44.72	42.76	54	-9.28	31.88	5.5	35.42	105	159	Average
2484	59.55	57.59	74	-14.45	31.88	5.5	35.42	105	159	Peak
4874	48.18	39.99	54	-5.82	33.98	8.27	34.06	112	295	Average
4874	59.92	51.73	74	-14.08	33.98	8.27	34.06	112	295	Peak
7311	47.87	37.38	54	-6.13	35.54	9.95	35	100	244	Average
7311	58.3	47.81	74	-15.7	35.54	9.95	35	100	244	Peak

REMARKS:

- Emission Level = Read Level + Antenna Factor + Cable Loss - Preamp Factor
Margin value = Emission level – Limit value
- 2437MHz: Fundamental frequency.

EUT TEST CONDITION		MEASUREMENT DETAIL	
CHANNEL	Channel 11	FREQUENCY RANGE	1GHz ~ 25GHz
INPUT POWER	120Vac, 60 Hz	DETECTOR FUNCTION	Peak (PK) Average (AV)
ENVIRONMENTAL CONDITIONS	25deg. C, 65%RH	TESTED BY	Karl Lee

ANTENNA POLARITY & TEST DISTANCE: HORIZONTAL AT 3 M										
FREQ. (MHz)	EMISSION LEVEL (dBuV/m)	READ LEVEL (dBuV)	LIMIT (dBuV/m)	MARGIN (dB)	ANTENNA FACTOR (dB/m)	CABLE LOSS (dB)	PREAMP FACTOR (dB)	ANTENNA HEIGHT (cm)	TABLE ANGLE (Degree)	REMARK
2376	40.18	38.52	54	-13.82	31.78	5.37	35.49	123	77	Average
2376	55.28	53.62	74	-18.72	31.78	5.37	35.49	123	77	Peak
2462	96.42	94.49			31.87	5.5	35.44	123	77	Average
2462	104.48	102.55			31.87	5.5	35.44	123	77	Peak
2484	52.58	50.62	54	-1.42	31.88	5.5	35.42	123	79	Average
2484	68.1	66.14	74	-5.9	31.88	5.5	35.42	123	79	Peak
ANTENNA POLARITY & TEST DISTANCE: VERTICAL AT 3 M										
FREQ. (MHz)	EMISSION LEVEL (dBuV/m)	READ LEVEL (dBuV)	LIMIT (dBuV/m)	MARGIN (dB)	ANTENNA FACTOR (dB/m)	CABLE LOSS (dB)	PREAMP FACTOR (dB)	ANTENNA HEIGHT (cm)	TABLE ANGLE (Degree)	REMARK
2358	40.08	38.45	54	-13.92	31.76	5.37	35.5	119	259	Average
2358	56.24	54.61	74	-17.76	31.76	5.37	35.5	119	259	Peak
2462	94.34	92.41			31.87	5.5	35.44	119	259	Average
2462	102.93	101			31.87	5.5	35.44	119	259	Peak
2484	49.28	47.32	54	-4.72	31.88	5.5	35.42	119	259	Average
2484	67.4	65.44	74	-6.6	31.88	5.5	35.42	119	259	Peak

REMARKS:

- Emission Level = Read Level + Antenna Factor + Cable Loss - Preamp Factor
Margin value = Emission level – Limit value
- 2462MHz: Fundamental frequency.

802.11n (20MHz)

EUT TEST CONDITION		MEASUREMENT DETAIL	
CHANNEL	Channel 1	FREQUENCY RANGE	1GHz ~ 25GHz
INPUT POWER	120Vac, 60 Hz	DETECTOR FUNCTION	Peak (PK) Average (AV)
ENVIRONMENTAL CONDITIONS	25deg. C, 65%RH	TESTED BY	Karl Lee

ANTENNA POLARITY & TEST DISTANCE: HORIZONTAL AT 3 M										
FREQ. (MHz)	EMISSION LEVEL (dBuV/m)	READ LEVEL (dBuV)	LIMIT (dBuV/m)	MARGIN (dB)	ANTENNA FACTOR (dB/m)	CABLE LOSS (dB)	PREAMP FACTOR (dB)	ANTENNA HEIGHT (cm)	TABLE ANGLE (Degree)	REMARK
2390	51.14	49.41	54	-2.86	31.8	5.4	35.47	114	162	Average
2390	65.27	63.54	74	-8.73	31.8	5.4	35.47	114	162	Peak
2412	95.96	94.19			31.81	5.43	35.47	166	193	Average
2412	103.1	101.33			31.81	5.43	35.47	166	193	Peak
2484	40.63	38.67	54	-13.37	31.88	5.5	35.42	166	193	Average
2484	56.17	54.21	74	-17.83	31.88	5.5	35.42	166	193	Peak
ANTENNA POLARITY & TEST DISTANCE: VERTICAL AT 3 M										
FREQ. (MHz)	EMISSION LEVEL (dBuV/m)	READ LEVEL (dBuV)	LIMIT (dBuV/m)	MARGIN (dB)	ANTENNA FACTOR (dB/m)	CABLE LOSS (dB)	PREAMP FACTOR (dB)	ANTENNA HEIGHT (cm)	TABLE ANGLE (Degree)	REMARK
2388	46.47	44.76	54	-7.53	31.8	5.4	35.49	119	159	Average
2388	59.08	57.37	74	-14.92	31.8	5.4	35.49	119	159	Peak
2412	93.21	91.44			31.81	5.43	35.47	119	159	Average
2412	101.18	99.41			31.81	5.43	35.47	119	159	Peak
2494	44.78	42.76	54	-9.22	31.9	5.53	35.41	119	159	Average
2494	56.01	53.99	74	-17.99	31.9	5.53	35.41	119	159	Peak

REMARKS:

- Emission Level = Read Level + Antenna Factor + Cable Loss - Preamp Factor
Margin value = Emission level – Limit value
- 2412MHz: Fundamental frequency.

EUT TEST CONDITION		MEASUREMENT DETAIL	
CHANNEL	Channel 6	FREQUENCY RANGE	1GHz ~ 25GHz
INPUT POWER	120Vac, 60 Hz	DETECTOR FUNCTION	Peak (PK) Average (AV)
ENVIRONMENTAL CONDITIONS	25deg. C, 65%RH	TESTED BY	Karl Lee

ANTENNA POLARITY & TEST DISTANCE: HORIZONTAL AT 3 M

FREQ. (MHz)	EMISSION LEVEL (dBuV/m)	READ LEVEL (dBuV)	LIMIT (dBuV/m)	MARGIN (dB)	ANTENNA FACTOR (dB/m)	CABLE LOSS (dB)	PREAMP FACTOR (dB)	ANTENNA HEIGHT (cm)	TABLE ANGLE (Degree)	REMARK
2390	51.91	50.18	54	-2.09	31.8	5.4	35.47	153	160	Average
2390	65.54	63.81	74	-8.46	31.8	5.4	35.47	153	160	Peak
2437	101.08	99.23			31.85	5.46	35.46	142	159	Average
2437	109.82	107.97			31.85	5.46	35.46	142	159	Peak
2486	52.87	50.88	54	-1.13	31.88	5.53	35.42	108	188	Average
2486	70.07	68.08	74	-3.93	31.88	5.53	35.42	108	188	Peak
4874	48.42	40.23	54	-5.58	33.98	8.27	34.06	100	211	Average
4874	59.71	51.52	74	-14.29	33.98	8.27	34.06	100	211	Peak
7311	49.67	39.18	54	-4.33	35.54	9.95	35	107	360	Average
7311	60.47	49.98	74	-13.53	35.54	9.95	35	107	360	Peak

ANTENNA POLARITY & TEST DISTANCE: VERTICAL AT 3 M

FREQ. (MHz)	EMISSION LEVEL (dBuV/m)	READ LEVEL (dBuV)	LIMIT (dBuV/m)	MARGIN (dB)	ANTENNA FACTOR (dB/m)	CABLE LOSS (dB)	PREAMP FACTOR (dB)	ANTENNA HEIGHT (cm)	TABLE ANGLE (Degree)	REMARK
2390	46.39	44.66	54	-7.61	31.8	5.4	35.47	119	159	Average
2390	59.98	58.25	74	-14.02	31.8	5.4	35.47	119	159	Peak
2437	99.12	97.27			31.85	5.46	35.46	119	159	Average
2437	107.17	105.32			31.85	5.46	35.46	119	159	Peak
2492	46	43.98	54	-8	31.9	5.53	35.41	119	159	Average
2492	62.97	60.95	74	-11.03	31.9	5.53	35.41	119	159	Peak
4874	48.14	39.95	54	-5.86	33.98	8.27	34.06	112	295	Average
4874	58.43	50.24	74	-15.57	33.98	8.27	34.06	112	295	Peak
7311	48.69	38.2	54	-5.31	35.54	9.95	35	104	238	Average
7311	59.12	48.63	74	-14.88	35.54	9.95	35	104	238	Peak

REMARKS:

- Emission Level = Read Level + Antenna Factor + Cable Loss - Preamp Factor
Margin value = Emission level – Limit value
- 2437MHz: Fundamental frequency.

EUT TEST CONDITION		MEASUREMENT DETAIL	
CHANNEL	Channel 11	FREQUENCY RANGE	1GHz ~ 25GHz
INPUT POWER	120Vac, 60 Hz	DETECTOR FUNCTION	Peak (PK) Average (AV)
ENVIRONMENTAL CONDITIONS	25deg. C, 65%RH	TESTED BY	Karl Lee

ANTENNA POLARITY & TEST DISTANCE: HORIZONTAL AT 3 M										
FREQ. (MHz)	EMISSION LEVEL (dBuV/m)	READ LEVEL (dBuV)	LIMIT (dBuV/m)	MARGIN (dB)	ANTENNA FACTOR (dB/m)	CABLE LOSS (dB)	PREAMP FACTOR (dB)	ANTENNA HEIGHT (cm)	TABLE ANGLE (Degree)	REMARK
2372	40.04	38.38	54	-13.96	31.78	5.37	35.49	123	77	Average
2372	55.22	53.56	74	-18.78	31.78	5.37	35.49	123	77	Peak
2462	95.05	93.12			31.87	5.5	35.44	123	77	Average
2462	103.05	101.12			31.87	5.5	35.44	123	77	Peak
2488	52.89	50.88	54	-1.11	31.9	5.53	35.42	123	79	Average
2488	71.42	69.41	74	-2.58	31.9	5.53	35.42	123	79	Peak
ANTENNA POLARITY & TEST DISTANCE: VERTICAL AT 3 M										
FREQ. (MHz)	EMISSION LEVEL (dBuV/m)	READ LEVEL (dBuV)	LIMIT (dBuV/m)	MARGIN (dB)	ANTENNA FACTOR (dB/m)	CABLE LOSS (dB)	PREAMP FACTOR (dB)	ANTENNA HEIGHT (cm)	TABLE ANGLE (Degree)	REMARK
2322	39.94	38.43	54	-14.06	31.73	5.3	35.52	119	259	Average
2322	56.24	54.73	74	-17.76	31.73	5.3	35.52	119	259	Peak
2462	92.91	90.98			31.87	5.5	35.44	119	259	Average
2462	100.46	98.53			31.87	5.5	35.44	119	259	Peak
2484	48.62	46.66	54	-5.38	31.88	5.5	35.42	119	259	Average
2484	67.21	65.25	74	-6.79	31.88	5.5	35.42	119	259	Peak

REMARKS:

- Emission Level = Read Level + Antenna Factor + Cable Loss - Preamp Factor
Margin value = Emission level – Limit value
- 2462MHz: Fundamental frequency.

802.11n (40MHz)

EUT TEST CONDITION		MEASUREMENT DETAIL	
CHANNEL	Channel 3	FREQUENCY RANGE	1GHz ~ 25GHz
INPUT POWER	120Vac, 60 Hz	DETECTOR FUNCTION	Peak (PK) Average (AV)
ENVIRONMENTAL CONDITIONS	25deg. C, 65%RH	TESTED BY	Karl Lee

ANTENNA POLARITY & TEST DISTANCE: HORIZONTAL AT 3 M										
FREQ. (MHz)	EMISSION LEVEL (dBuV/m)	READ LEVEL (dBuV)	LIMIT (dBuV/m)	MARGIN (dB)	ANTENNA FACTOR (dB/m)	CABLE LOSS (dB)	PREAMP FACTOR (dB)	ANTENNA HEIGHT (cm)	TABLE ANGLE (Degree)	REMARK
2390	51.68	49.95	54	-2.32	31.8	5.4	35.47	114	162	Average
2390	63.66	61.93	74	-10.34	31.8	5.4	35.47	114	162	Peak
2422	92.85	91.05			31.83	5.43	35.46	142	159	Average
2422	100.82	99.02			31.83	5.43	35.46	142	159	Peak
2500	42.18	40.16	54	-11.82	31.9	5.53	35.41	142	159	Average
2500	55.92	53.9	74	-18.08	31.9	5.53	35.41	142	159	Peak
ANTENNA POLARITY & TEST DISTANCE: VERTICAL AT 3 M										
FREQ. (MHz)	EMISSION LEVEL (dBuV/m)	READ LEVEL (dBuV)	LIMIT (dBuV/m)	MARGIN (dB)	ANTENNA FACTOR (dB/m)	CABLE LOSS (dB)	PREAMP FACTOR (dB)	ANTENNA HEIGHT (cm)	TABLE ANGLE (Degree)	REMARK
2390	49.67	47.94	54	-4.33	31.8	5.4	35.47	122	159	Average
2390	61.77	60.04	74	-12.23	31.8	5.4	35.47	122	159	Peak
2422	90.11	88.31			31.83	5.43	35.46	122	159	Average
2422	98.79	96.99			31.83	5.43	35.46	122	159	Peak
2496	41.22	39.2	54	-12.78	31.9	5.53	35.41	122	159	Average
2496	55.95	53.93	74	-18.05	31.9	5.53	35.41	122	159	Peak

REMARKS:

- Emission Level = Read Level + Antenna Factor + Cable Loss - Preamp Factor
Margin value = Emission level – Limit value
- 2422MHz: Fundamental frequency.

EUT TEST CONDITION		MEASUREMENT DETAIL	
CHANNEL	Channel 6	FREQUENCY RANGE	1GHz ~ 25GHz
INPUT POWER	120Vac, 60 Hz	DETECTOR FUNCTION	Peak (PK) Average (AV)
ENVIRONMENTAL CONDITIONS	25deg. C, 65%RH	TESTED BY	Karl Lee

ANTENNA POLARITY & TEST DISTANCE: HORIZONTAL AT 3 M										
FREQ. (MHz)	EMISSION LEVEL (dBuV/m)	READ LEVEL (dBuV)	LIMIT (dBuV/m)	MARGIN (dB)	ANTENNA FACTOR (dB/m)	CABLE LOSS (dB)	PREAMP FACTOR (dB)	ANTENNA HEIGHT (cm)	TABLE ANGLE (Degree)	REMARK
2390	50.76	49.03	54	-3.24	31.8	5.4	35.47	113	159	Average
2390	66.09	64.36	74	-7.91	31.8	5.4	35.47	113	159	Peak
2437	96.29	94.44			31.85	5.46	35.46	142	159	Average
2437	103.24	101.39			31.85	5.46	35.46	142	159	Peak
2484	50.16	48.2	54	-3.84	31.88	5.5	35.42	108	188	Average
2484	66.67	64.71	74	-7.33	31.88	5.5	35.42	108	188	Peak

ANTENNA POLARITY & TEST DISTANCE: VERTICAL AT 3 M										
FREQ. (MHz)	EMISSION LEVEL (dBuV/m)	READ LEVEL (dBuV)	LIMIT (dBuV/m)	MARGIN (dB)	ANTENNA FACTOR (dB/m)	CABLE LOSS (dB)	PREAMP FACTOR (dB)	ANTENNA HEIGHT (cm)	TABLE ANGLE (Degree)	REMARK
2390	47.45	45.72	54	-6.55	31.8	5.4	35.47	105	169	Average
2390	58.1	56.37	74	-15.9	31.8	5.4	35.47	105	169	Peak
2437	93.27	91.42			31.85	5.46	35.46	105	169	Average
2437	101.13	99.28			31.85	5.46	35.46	105	169	Peak
2484	48.03	46.07	54	-5.97	31.88	5.5	35.42	105	169	Average
2484	56.42	54.46	74	-17.58	31.88	5.5	35.42	105	169	Peak

REMARKS:

- Emission Level = Read Level + Antenna Factor + Cable Loss - Preamp Factor
Margin value = Emission level – Limit value
- 2437MHz: Fundamental frequency.

EUT TEST CONDITION		MEASUREMENT DETAIL	
CHANNEL	Channel 9	FREQUENCY RANGE	1GHz ~ 25GHz
INPUT POWER	120Vac, 60 Hz	DETECTOR FUNCTION	Peak (PK) Average (AV)
ENVIRONMENTAL CONDITIONS	25deg. C, 65%RH	TESTED BY	Karl Lee

ANTENNA POLARITY & TEST DISTANCE: HORIZONTAL AT 3 M										
FREQ. (MHz)	EMISSION LEVEL (dBuV/m)	READ LEVEL (dBuV)	LIMIT (dBuV/m)	MARGIN (dB)	ANTENNA FACTOR (dB/m)	CABLE LOSS (dB)	PREAMP FACTOR (dB)	ANTENNA HEIGHT (cm)	TABLE ANGLE (Degree)	REMARK
2362	40.75	39.12	54	-13.25	31.76	5.37	35.5	123	77	Average
2362	55.13	53.5	74	-18.87	31.76	5.37	35.5	123	77	Peak
2452	91.27	89.4			31.85	5.46	35.44	123	77	Average
2452	99.01	97.14			31.85	5.46	35.44	123	77	Peak
2486	50.67	48.68	54	-3.33	31.88	5.53	35.42	123	79	Average
2486	67.33	65.34	74	-6.67	31.88	5.53	35.42	123	79	Peak

ANTENNA POLARITY & TEST DISTANCE: VERTICAL AT 3 M										
FREQ. (MHz)	EMISSION LEVEL (dBuV/m)	READ LEVEL (dBuV)	LIMIT (dBuV/m)	MARGIN (dB)	ANTENNA FACTOR (dB/m)	CABLE LOSS (dB)	PREAMP FACTOR (dB)	ANTENNA HEIGHT (cm)	TABLE ANGLE (Degree)	REMARK
2350	40.93	39.36	54	-13.07	31.74	5.33	35.5	119	259	Average
2350	55.56	53.99	74	-18.44	31.74	5.33	35.5	119	259	Peak
2452	89.43	87.56			31.85	5.46	35.44	119	259	Average
2452	97.11	95.24			31.85	5.46	35.44	119	259	Peak
2484	49.36	47.4	54	-4.64	31.88	5.5	35.42	119	259	Average
2484	62.1	60.14	74	-11.9	31.88	5.5	35.42	119	259	Peak

REMARKS:

- Emission Level = Read Level + Antenna Factor + Cable Loss - Preamp Factor
Margin value = Emission level – Limit value
- 2452MHz: Fundamental frequency.

BELOW 1GHz WORST-CASE DATA:

802.11n (20MHz)

EUT TEST CONDITION		MEASUREMENT DETAIL	
CHANNEL	Channel 11	FREQUENCY RANGE	30MHz ~ 1GHz
INPUT POWER	120Vac, 60 Hz	DETECTOR FUNCTION	Peak (PK) Average (AV)
ENVIRONMENTAL CONDITIONS	25deg. C, 65%RH	TESTED BY	Charles Hsiao

ANTENNA POLARITY & TEST DISTANCE: HORIZONTAL AT 3 M

FREQ. (MHz)	EMISSION LEVEL (dBuV/m)	READ LEVEL (dBuV)	LIMIT (dBuV/m)	MARGIN (dB)	ANTENNA FACTOR (dB/m)	CABLE LOSS (dB)	PREAMP FACTOR (dB)	ANTENNA HEIGHT (cm)	TABLE ANGLE (Degree)	REMARK
96.42	30.38	51.72	43.5	-13.12	9.42	1.28	32.04	120	154	Peak
161.76	31.33	51.42	43.5	-12.17	10.65	1.52	32.26	161	125	Peak
283.26	21.86	38.18	46	-24.14	13.77	2.03	32.12	186	175	Peak
336.4	20.82	34.92	46	-25.18	15.8	2.19	32.09	164	168	Peak
786.5	23.82	28.58	46	-22.18	24.05	3.27	32.08	120	115	Peak
925.1	27.35	28.91	46	-18.65	26.2	3.53	31.29	174	154	Peak

ANTENNA POLARITY & TEST DISTANCE: VERTICAL AT 3 M

FREQ. (MHz)	EMISSION LEVEL (dBuV/m)	READ LEVEL (dBuV)	LIMIT (dBuV/m)	MARGIN (dB)	ANTENNA FACTOR (dB/m)	CABLE LOSS (dB)	PREAMP FACTOR (dB)	ANTENNA HEIGHT (cm)	TABLE ANGLE (Degree)	REMARK
54.57	32.65	56.65	40	-7.35	7.33	0.9	32.23	165	174	Peak
90.48	28.93	50.59	43.5	-14.57	8.94	1.11	31.71	187	165	Peak
163.65	20.11	40.34	43.5	-23.39	10.51	1.52	32.26	152	158	Peak
337.1	17.23	31.32	46	-28.77	15.8	2.19	32.08	117	147	Peak
699.7	23.89	29.77	46	-22.11	23.1	3.11	32.09	169	211	Peak
881.7	24.4	27.63	46	-21.6	24.88	3.49	31.6	165	216	Peak

REMARKS: Emission Level = Read Level + Antenna Factor + Cable Loss - Preamp Factor

Margin value = Emission level – Limit value

4.2 CONDUCTED EMISSION MEASUREMENT

4.2.1 LIMITS OF CONDUCTED EMISSION MEASUREMENT

FREQUENCY OF EMISSION (MHz)	CONDUCTED LIMIT (dB μ V)	
	Quasi-peak	Average
0.15 ~ 0.5	66 to 56	56 to 46
0.5 ~ 5	56	46
5 ~ 30	60	50

- NOTE:**
1. The lower limit shall apply at the transition frequencies.
 2. The limit decreases in line with the logarithm of the frequency in the range of 0.15 to 0.50MHz.
 3. All emanations from a class A/B digital device or system, including any network of conductors and apparatus connected thereto, shall not exceed the level of field strengths specified above.

4.2.2 TEST INSTRUMENTS

DESCRIPTION & MANUFACTURER	MODEL NO.	SERIAL NO.	DATE OF CALIBRATION	DUE DATE OF CALIBRATION
Test Receiver ROHDE & SCHWARZ	ESCI	100613	Nov. 11, 2014	Nov. 10, 2015
RF signal cable Woken	5D-FB	Cable-HYC01-01	Dec. 26, 2014	Dec. 25, 2015
LISN ROHDE & SCHWARZ (EUT)	ESH3-Z5	835239/001	Mar. 02, 2015	Mar. 01, 2016
LISN ROHDE & SCHWARZ (Peripheral)	ESH3-Z5	100311	Jul. 21, 2014	Jul. 20, 2015
Software ADT	BV ADT_Cond_ V7.3.7.3	NA	NA	NA

- NOTE:**
1. The calibration interval of the above test instruments is 12 months and the calibrations are traceable to NML/ROC and NIST/USA.
 2. The test was performed in HwaYa Shielded Room 1.
 3. The VCCI Site Registration No. is C-2040.

4.2.3 TEST PROCEDURES

- a. The EUT was placed 0.4 meters from the conducting wall of the shielded room with EUT being connected to the power mains through a line impedance stabilization network (LISN). Other support units were connected to the power mains through another LISN. The two LISNs provide 50 ohm/ 50uH of coupling impedance for the measuring instrument.
- b. Both lines of the power mains connected to the EUT were checked for maximum conducted interference.
- c. The frequency range from 150kHz to 30MHz was searched. Emission levels under (Limit - 20dB) was not recorded.

NOTE: All modes of operation were investigated and the worst-case emissions are reported.

4.2.4 DEVIATION FROM TEST STANDARD

No deviation.

4.2.5 TEST SETUP

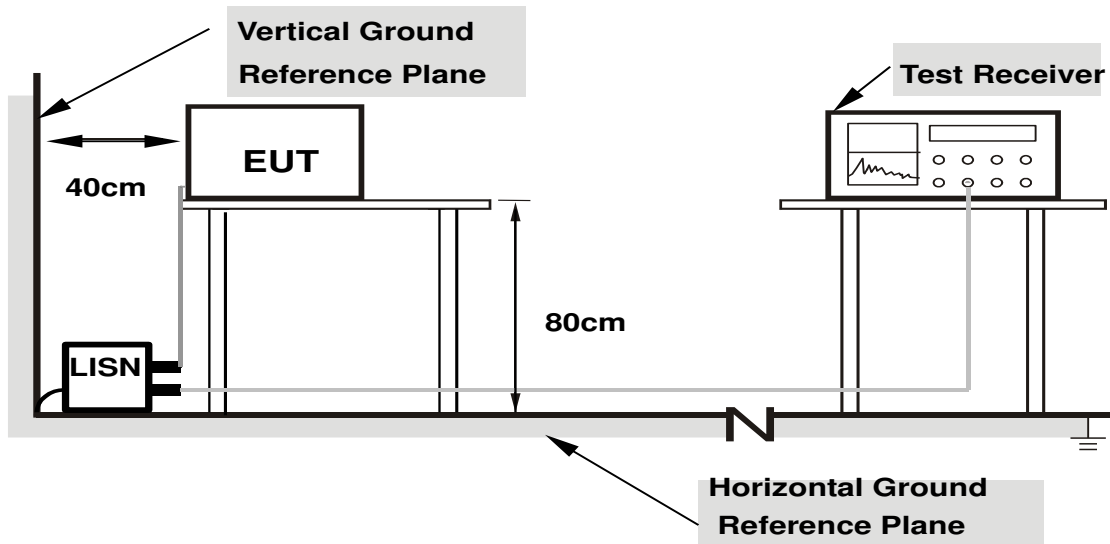

- Note: 1.Support units were connected to second LISN.**
2.Both of LISNs (AMN) are 80 cm from EUT and at least 80 from other units and other metal planes

For the actual test configuration, please refer to the attached file (Test Setup Photo).

4.2.6 EUT OPERATING CONDITIONS

Same as section 4.1.6.

4.2.7 TEST RESULTS

CONDUCTED WORST-CASE DATA :

Frequency Range	150kHz ~ 30MHz	Detector Function & Resolution Bandwidth	Quasi-Peak (QP) / Average (AV), 9kHz
Input Power	120Vac, 60Hz	Environmental Conditions	25°C, 65%RH
Tested by	Toby Tian	Test Date	2015/6/18

Phase Of Power : Line (L)										
No	Frequency (MHz)	Correction Factor (dB)	Reading Value (dBuV)		Emission Level (dBuV)		Limit (dBuV)		Margin (dB)	
			Q.P.	AV.	Q.P.	AV.	Q.P.	AV.	Q.P.	AV.
1	0.18508	0.06	35.85	23.77	35.91	23.83	64.25	54.25	-28.35	-30.43
2	0.22820	0.06	33.99	24.39	34.05	24.45	62.51	52.51	-28.46	-28.06
3	0.50581	0.06	36.52	26.78	36.58	26.84	56.00	46.00	-19.42	-19.16
4	0.64657	0.07	34.08	24.23	34.15	24.30	56.00	46.00	-21.85	-21.70
5	4.35325	0.21	30.54	21.60	30.75	21.81	56.00	46.00	-25.25	-24.19
6	9.68258	0.44	33.20	23.66	33.64	24.10	60.00	50.00	-26.36	-25.90

Remarks:

1. Q.P. and AV. are abbreviations of quasi-peak and average individually.
2. The emission levels of other frequencies were very low against the limit.
3. Margin value = Emission level – Limit value
4. Correction factor = Insertion loss + Cable loss
5. Emission Level = Correction Factor + Reading Value

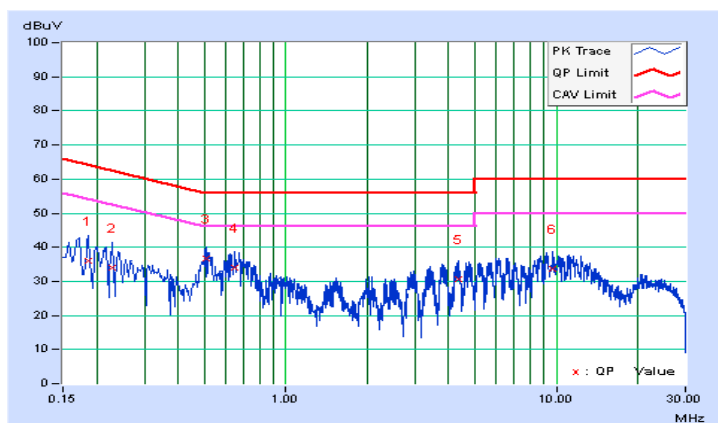

Frequency Range	150kHz ~ 30MHz	Detector Function & Resolution Bandwidth	Quasi-Peak (QP) / Average (AV), 9kHz
Input Power	120Vac, 60Hz	Environmental Conditions	25°C, 65%RH
Tested by	Toby Tian	Test Date	2015/6/18

Phase Of Power : Neutral (N)										
No	Frequency (MHz)	Correction Factor (dB)	Reading Value (dBuV)		Emission Level (dBuV)		Limit (dBuV)		Margin (dB)	
			Q.P.	AV.	Q.P.	AV.	Q.P.	AV.	Q.P.	AV.
1	0.17346	0.05	40.46	30.15	40.51	30.20	64.79	54.79	-24.28	-24.59
2	0.21256	0.05	36.68	26.83	36.73	26.88	63.10	53.10	-26.37	-26.22
3	0.49799	0.06	34.24	28.46	34.30	28.52	56.03	46.03	-21.73	-17.51
4	0.63093	0.07	31.07	22.40	31.14	22.47	56.00	46.00	-24.86	-23.53
5	4.80681	0.22	27.91	21.60	28.13	21.82	56.00	46.00	-27.87	-24.18
6	9.18992	0.39	31.50	22.88	31.89	23.27	60.00	50.00	-28.11	-26.73

Remarks:

1. Q.P. and AV. are abbreviations of quasi-peak and average individually.
2. The emission levels of other frequencies were very low against the limit.
3. Margin value = Emission level – Limit value
4. Correction factor = Insertion loss + Cable loss
5. Emission Level = Correction Factor + Reading Value

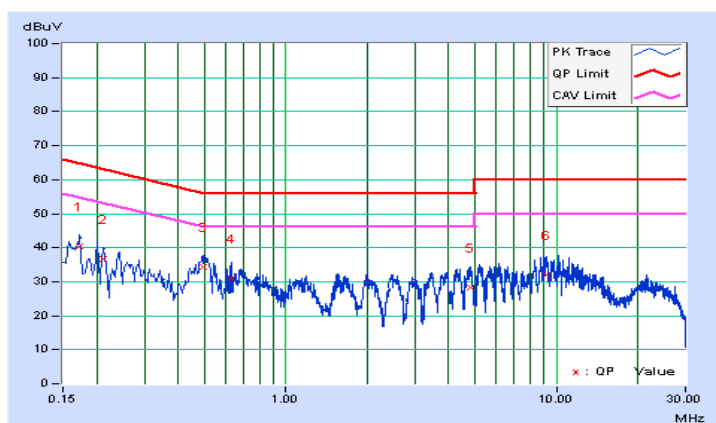

4.3 CONDUCTED OUTPUT POWER

4.3.1 LIMITS OF CONDUCTED OUTPUT POWER MEASUREMENT

For systems using digital modulation in the 2400–2483.5 MHz bands: 1 Watt (30dBm)

Per KDB 662911 D01 Multiple Transmitter Output v02r01 Method of conducted output power measurement on IEEE 802.11 devices,

Array Gain = 0 dB (i.e., no array gain) for NANT \leq 4;

Array Gain = 0 dB (i.e., no array gain) for channel widths \geq 40 MHz for any NANT;

Array Gain = $5 \log(\text{NANT}/\text{NSS})$ dB or 3 dB, whichever is less for 20-MHz channel widths with NANT \geq 5.

For power measurements on all other devices: Array Gain = $10 \log(\text{NANT}/\text{NSS})$ dB.

4.3.2 TEST SETUP

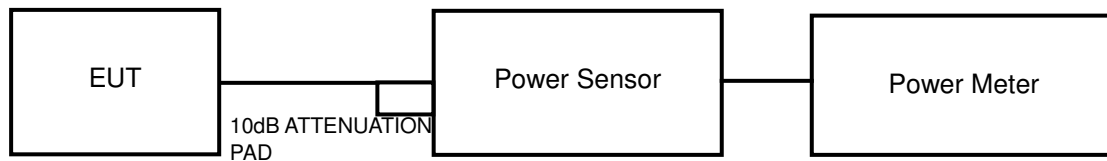

4.3.3 TEST INSTRUMENTS

Refer to section 4.1.2 to get information of above instrument.

4.3.4 TEST PROCEDURES

A peak power sensor was used on the output port of the EUT. A power meter was used to read the response of the peak power sensor. Record the peak power level.

4.3.5 DEVIATION FROM TEST STANDARD

No deviation.

4.3.6 EUT OPERATING CONDITIONS

The software provided by client to enable the EUT under transmission condition continuously at lowest, middle and highest channel frequencies individually.

4.3.7 TEST RESULTS

FOR 2TX USE

802.11b

CHAN.	FREQ. (MHz)	PEAK POWER (dBm)		TOTAL POWER (mW)	TOTAL POWER (dBm)	LIMIT (dBm)	PASS / FAIL
		CHAIN 0	CHAIN 1				
1	2412	15.37	16.21	76.218	18.82	30	PASS
6	2437	14.86	15.45	65.695	18.18	30	PASS
11	2462	5.00	15.43	38.076	15.81	30	PASS

802.11g

CHAN.	FREQ. (MHz)	PEAK POWER (dBm)		TOTAL POWER (mW)	TOTAL POWER (dBm)	LIMIT (dBm)	PASS / FAIL
		CHAIN 0	CHAIN 1				
1	2412	23.39	23.14	424.336	26.28	30	PASS
6	2437	24.93	24.92	621.628	27.94	30	PASS
11	2462	22.53	23.14	385.124	25.86	30	PASS

802.11n (20MHz)

CHAN.	FREQ. (MHz)	PEAK POWER (dBm)		TOTAL POWER (mW)	TOTAL POWER (dBm)	LIMIT (dBm)	PASS / FAIL
		CHAIN 0	CHAIN 1				
1	2412	21.58	21.53	286.113	24.57	30	PASS
6	2437	24.88	24.95	620.218	27.93	30	PASS
11	2462	20.88	20.68	239.412	23.79	30	PASS

802.11n (40MHz)

CHAN.	FREQ. (MHz)	PEAK POWER (dBm)		TOTAL POWER (mW)	TOTAL POWER (dBm)	LIMIT (dBm)	PASS / FAIL
		CHAIN 0	CHAIN 1				
3	2422	18.85	19.72	170.492	22.32	30	PASS
6	2437	22.40	21.76	323.749	25.10	30	PASS
9	2452	18.04	18.50	134.474	21.29	30	PASS

5. PHOTOGRAPHS OF THE TEST CONFIGURATION

Please refer to the attached file (Test Setup Photo).



6. INFORMATION ON THE TESTING LABORATORIES

We, Bureau Veritas Consumer Products Services (H.K.) Ltd., Taoyuan Branch, were founded in 1988 to provide our best service in EMC, Radio, Telecom and Safety consultation. Our laboratories are accredited and approved according to ISO/IEC 17025.

If you have any comments, please feel free to contact us at the following:

Linko EMC/RF Lab:

Tel: 886-2-26052180

Fax: 886-2-26051924

Hsin Chu EMC/RF/Telecom Lab:

Tel: 886-3-5935343

Fax: 886-3-5935342

Hwa Ya EMC/RF/Safety Lab:

Tel: 886-3-3183232

Fax: 886-3-3270892

Email: service.adt@tw.bureauveritas.com

Web Site: www.bureauveritas-adt.com

The address and road map of all our labs can be found in our web site also.

7. APPENDIX A – MODIFICATIONS RECORDERS FOR ENGINEERING CHANGES TO THE EUT BY THE LAB

No any modifications are made to the EUT by the lab during the test.

---END---