



# FCC TEST REPORT (PART 27)

**REPORT NO.:** RF150508C06-2

**MODEL:** WT1

**FCC ID:** A4R-WT1

**RECEIVED:** May 08, 2015

**TESTED:** May 25, 2015

**ISSUED:** Jun. 17, 2015

**COMPANY NAME:** Google Inc.

**ADDRESS:** 1600 Amphitheatre Parkway Mountain View  
California United States 94043

**ISSUED BY:** Bureau Veritas Consumer Products Services  
(H.K.) Ltd., Taoyuan Branch

**LAB ADDRESS:** No. 47-2, 14th Ling, Chia Pau Vil., Lin Kou Dist.,  
New Taipei City, Taiwan, R.O.C.

**TEST LOCATION:** No. 19, Hwa Ya 2nd Rd, Wen Hwa Vil., Kwei Shan  
Dist., Taoyuan City 333, Taiwan, R.O.C.

This report should not be used by the client to claim product certification, approval, or endorsement by TAF or any government agencies.



This report is for your exclusive use. Any copying or replication of this report to or for any other person or entity, or use of our name or trademark, is permitted only with our prior written permission. This report sets forth our findings solely with respect to the test samples identified herein. The results set forth in this report are not indicative or representative of the quality or characteristics of the lot from which a test sample was taken or any similar or identical product unless specifically and expressly noted. Our report includes all of the tests requested by you and the results thereof based upon the information that you provided to us. You have 60 days from date of issuance of this report to notify us of any material error or omission caused by our negligence, provided, however, that such notice shall be in writing and shall specifically address the issue you wish to raise. A failure to raise such issue within the prescribed time shall constitute your unqualified acceptance of the completeness of this report, the tests conducted and the correctness of the report contents. Unless specific mention, the uncertainty of measurement has been explicitly taken into account to declare the compliance or non-compliance to the specification



## TABLE OF CONTENTS

RELEASE CONTROL RECORD.....	3
1 CERTIFICATION .....	4
2 SUMMARY OF TEST RESULTS.....	5
2.1 MEASUREMENT UNCERTAINTY .....	6
2.2 TEST SITE AND INSTRUMENTS .....	7
3 GENERAL INFORMATION .....	8
3.1 GENERAL DESCRIPTION OF EUT.....	8
3.2 CONFIGURATION OF SYSTEM UNDER TEST .....	9
3.3 DESCRIPTION OF SUPPORT UNITS.....	10
3.4 DESCRIPTION OF TEST MODES.....	11
3.5 GENERAL DESCRIPTION OF APPLIED STANDARDS .....	11
4 TEST TYPES AND RESULTS.....	12
4.1 OUTPUT POWER MEASUREMENT .....	12
4.1.1 LIMITS OF OUTPUT POWER MEASUREMENT .....	12
4.1.2 TEST PROCEDURES.....	12
4.1.3 TEST SETUP .....	13
4.1.4 TEST RESULTS .....	14
4.2 RADIATED EMISSION MEASUREMENT .....	15
4.2.1 LIMITS OF RADIATED EMISSION MEASUREMENT .....	15
4.2.2 TEST PROCEDURES.....	15
4.2.3 DEVIATION FROM TEST STANDARD .....	15
4.2.4 TEST SETUP .....	16
4.2.5 TEST RESULTS .....	17
5 INFORMATION ON THE TESTING LABORATORIES .....	19
6 APPENDIX A – MODIFICATIONS RECORDERS FOR ENGINEERING CHANGES TO THE EUT BY THE LAB.....	20



A D T

## RELEASE CONTROL RECORD

ISSUE NO.	REASON FOR CHANGE	DATE ISSUED
RF150508C06-2	Original release	Jun. 17, 2015



# 1 CERTIFICATION

**PRODUCT NAME/DESCRIPTION:** Connectivity Bridge

**MODEL:** WT1

**BRAND:** Google

**COMPANY NAME:** Google Inc.

**TESTED:** May 25, 2015

**TEST SAMPLE:** Identical Prototype

**TEST STANDARDS:** **FCC Part 27, Subpart C, L**  
**FCC Part 2**

The above equipment (model: WT1) has been tested by **Bureau Veritas Consumer Products Services (H.K.) Ltd., Taoyuan Branch**, and found compliance with the requirement of the above standards. The test record, data evaluation & Equipment Under Test (EUT) configurations represented herein are true and accurate accounts of the measurements of the sample's EMC characteristics under the conditions specified in this report.

**PREPARED BY** : Gina Liu , **DATE:** Jun. 17, 2015

Gina Liu / Specialist

**APPROVED BY** : Sam chen , **DATE:** Jun. 17, 2015

Sam Chen / Senior Project Engineer



A D T

## 2 SUMMARY OF TEST RESULTS

The EUT has been tested according to the following specifications:

WCDMA			
STANDARD SECTION	TEST TYPE	RESULT	REMARK
2.1046 27.50(d)(4)	Equivalent Isotropic Radiated Power	PASS	Meet the requirement of limit.
2.1055 27.54	Frequency Stability	PASS	Meet the requirement of limit.
2.1049 27.53(h)	Occupied Bandwidth	PASS	Meet the requirement of limit.
27.50(d)(5)	Peak to Average Ratio	PASS	Meet the requirement of limit.
27.53(h)	Band Edge Measurements	PASS	Meet the requirement of limit.
2.1051 27.53(h)	Conducted Spurious Emissions	PASS	Meet the requirement of limit.
2.1053 27.53(h)	Radiated Spurious Emissions	PASS	Meet the requirement of limit. Minimum passing margin is -26.20dB at 3465.2MHz.

## 2.1 MEASUREMENT UNCERTAINTY

Where relevant, the following measurement uncertainty levels have been estimated for tests performed on the EUT as specified in CISPR 16-4-2:

MEASUREMENT	FREQUENCY	UNCERTAINTY
Conducted emissions	9kHz~30MHz	2.44 dB
Radiated emissions	30MHz ~ 200MHz	2.93 dB
	200MHz ~1000MHz	2.95 dB
	1GHz ~ 18GHz	2.26 dB
	18GHz ~ 40GHz	1.94 dB

This uncertainty represents an expanded uncertainty expressed at approximately the 95% confidence level using a coverage factor of  $k=2$ .



A D T

## 2.2 TEST SITE AND INSTRUMENTS

DESCRIPTION & MANUFACTURER	MODEL NO.	SERIAL NO.	DATE OF CALIBRATION	DUE DATE OF CALIBRATION
Test Receiver ROHDE & SCHWARZ	N9038A	MY51210203	Jan.21, 2015	Jan.21, 2016
Spectrum Analyzer ROHDE & SCHWARZ	N9010A	MY52220314	Sep.03, 2014	Sep.02, 2015
BILOG Antenna SCHWARZBECK	VULB9168	9168-472	Feb. 04, 2015	Feb. 04, 2016
HORN Antenna SCHWARZBECK	BBHA 9120 D	9120D-969	Feb. 09, 2015	Feb. 09, 2016
HORN Antenna SCHWARZBECK	BBHA 9170	9170-480	Feb. 04, 2015	Feb. 04, 2016
Preamplifier EMCI	EMC 012645	980115	Dec. 12, 2014	Dec. 11, 2015
Preamplifier EMCI	EMC 184045	980116	Jan. 09, 2015	Jan. 08, 2016
Preamplifier EMCI	EMC 330H	980112	Dec. 27, 2014	Dec. 26, 2015
RF signal cable HUBER+SUHNNER	SUCOFLEX 104	309219/4 2950114	Oct. 18, 2014	Oct. 17, 2015
RF signal cable HUBER+SUHNNER	SUCOFLEX 104	250130/4	Oct. 18, 2014	Oct. 17, 2015
RF signal cable Worken	RG-213	NA	Nov. 07, 2014	Nov. 06, 2015
Software BV ADT	E3 6.120103	NA	NA	NA
Antenna Tower MF	MFA-440H	NA	NA	NA
Turn Table MF	MFT-201SS	NA	NA	NA
Antenna Tower & Turn Table Controller MF	MF-7802	NA	NA	NA
Radio Communication Analyzer	MT8820C	6201300640	Aug. 01, 2013	Jul. 31, 2015

- NOTE:** 1. The calibration interval of the above test instruments is 12 / 24 months and the calibrations are traceable to NML/ROC and NIST/USA.
2. The test was performed in HwaYa Chamber 10.
3. The horn antenna and HP preamplifier (model: 8449B) are used only for the measurement of emission frequency above 1GHz if tested.
4. The FCC Site Registration No. is 690701.
5. The IC Site Registration No. is IC 7450F-10.



### 3 GENERAL INFORMATION

#### 3.1 GENERAL DESCRIPTION OF EUT

<b>PRODUCT NAME/DESCRIPTION</b>	Connectivity Bridge	
<b>MODEL</b>	WT1	
<b>POWER SUPPLY</b>	5Vdc (Adapter)	
<b>MODULATION TECHNOLOGY</b>	WCDMA	QPSK, BPSK
<b>FREQUENCY RANGE</b>	WCDMA	1712.4MHz ~1752.6MHz
<b>MAX. EIRP POWER</b>	WCDMA	388.78mW
<b>ANTENNA TYPE</b>	Fixed Internal Antenna	
<b>DATA CABLE</b>	Refer to Note as below	
<b>I/O PORTS</b>	Refer to users' manual	
<b>ACCESSORY DEVICES</b>	Refer to Note as below	

**NOTE:**

1. The EUT contains following accessory devices.

ITEM	BRAND	MODEL	SPECIFICATION
Adapter	TPT	MII050200	I/P: 100-240Vac, 50/60Hz, 0.3A O/P: 5Vdc, 2A
WWAN Module	Telit	HE910D	
WLAN Module	BCM4354	AW-CM195NF	

2. The above EUT information is declared by manufacturer and for more detailed features description, please refer to the manufacturer's specifications or User's Manual.



### 3.2 CONFIGURATION OF SYSTEM UNDER TEST FOR RADIATION EMISSION TEST

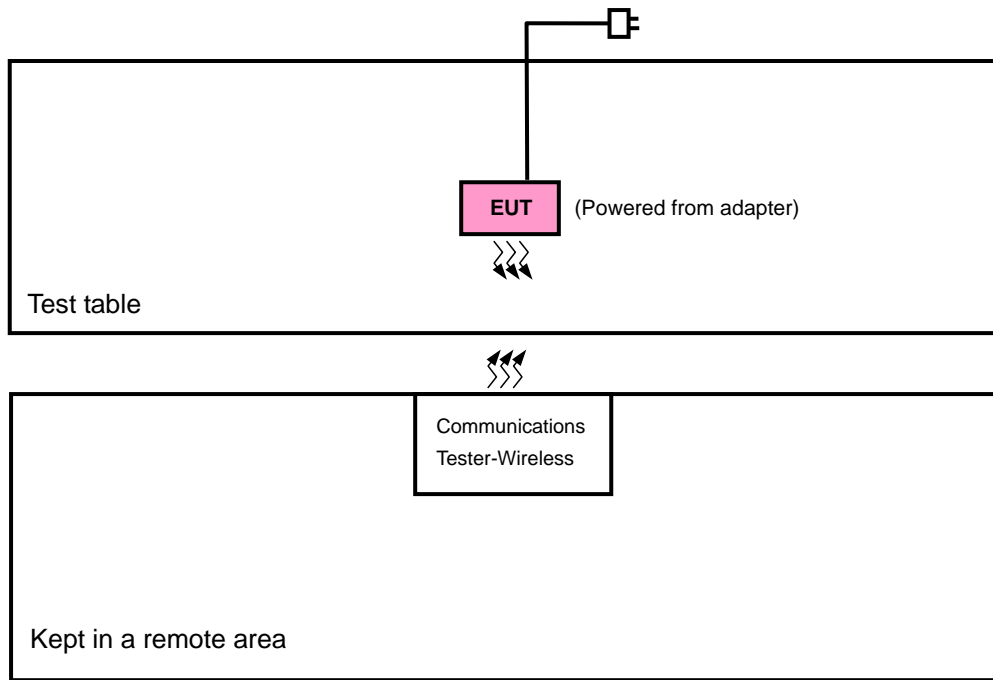

### FOR E.I.R.P. TEST

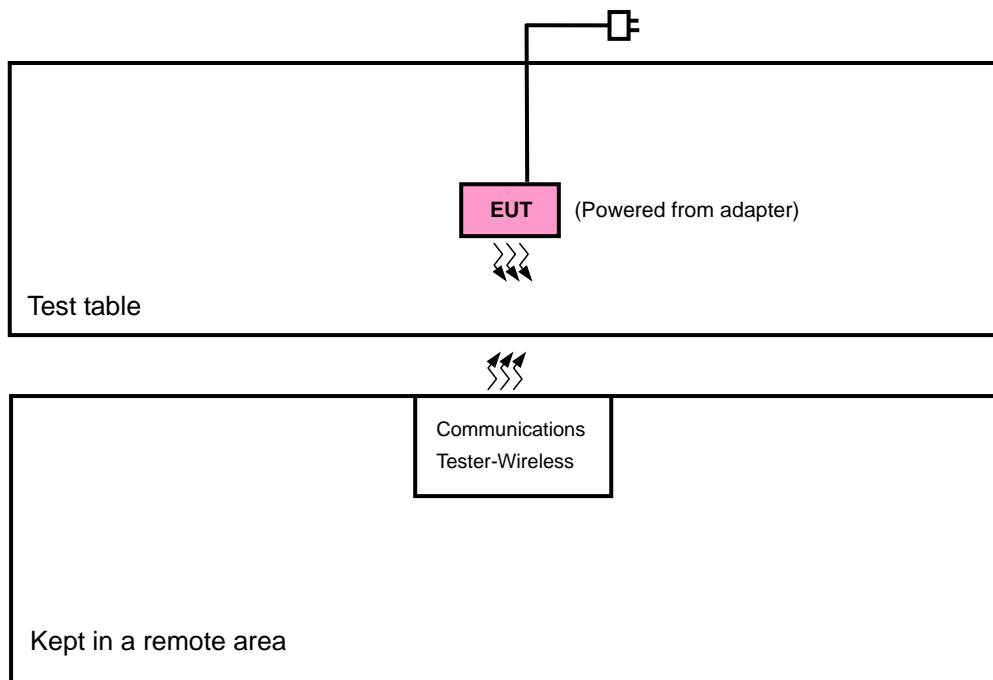



### 3.3 DESCRIPTION OF SUPPORT UNITS

The EUT has been tested as an independent unit together with other necessary accessories or support units. The following support units or accessories were used to form a representative test configuration during the tests.

NO.	PRODUCT	BRAND	MODEL NO.	SERIAL NO.	FCC ID
1	Communications Tester-Wireless	Agilent	8960 Series 10	MY53201073	NA

NO.	SIGNAL CABLE DESCRIPTION OF THE ABOVE SUPPORT UNITS
1	NA

**NOTE:**

- 1. All power cords of the above support units are non shielded (1.8m).
- 2. Item 1 acted as communication partners to transfer data.

### 3.4 DESCRIPTION OF TEST MODES

Pre-Scan has been conducted to determine the worst-case mode from all possible combinations between available modulations, data rates, XYZ axis and antenna ports. The worst case was found when positioned on X-plane for ERP and radiated emission. Following channel(s) was (were) selected for the final test as listed below:

#### WCDMA

TEST ITEM	AVAILABLE CHANNEL	TESTED CHANNEL	MODE
EIRP	1312 to 1513	1312, 1413, 1513	WCDMA
RADIATED EMISSION	1312 to 1513	1413	WCDMA

#### TEST CONDITION:

TEST ITEM	ENVIRONMENTAL CONDITIONS	INPUT POWER	TESTED BY
EIRP	26deg. C, 58%RH	120Vac, 60Hz	Howard Kao
RADIATED EMISSION	25deg. C, 65%RH	120Vac, 60Hz	Hwa Chiang

### 3.5 GENERAL DESCRIPTION OF APPLIED STANDARDS

The EUT is a RF product. According to the specifications of the manufacturer, it must comply with the requirements of the following standards:

**FCC 47 CFR Part 2**

**FCC 47 CFR Part 27**

**ANSI/TIA/EIA-603-C 2004**

**NOTE:** All test items have been performed and recorded as per the above standards.

## 4 TEST TYPES AND RESULTS

### 4.1 OUTPUT POWER MEASUREMENT

#### 4.1.1 LIMITS OF OUTPUT POWER MEASUREMENT

Fixed, mobile, and portable (hand-held) stations operating in the 1710–1755 MHz band are limited to 1 watt EIRP.

#### 4.1.2 TEST PROCEDURES

##### EIRP MEASUREMENT:

- a. All measurements were done at low, middle and high operational frequency range. RBW and VBW is 1MHz for GSM, GPRS & EDGE, 5MHz for CDMA & WCDMA, and 10MHz for LTE mode.
- b. Substitution method is used for E.I.R.P measurement. In the semi-anechoic chamber, EUT placed on the 0.8m height of Turn Table, rotated the table around 360 degrees to search the maximum radiation power and receiver antenna shall be rotated vertical and horizontal polarization and moved height from 1m to 4m to find the maximum polar radiated power. The “Read Value” is the spectrum reading the maximum power value.
- c. The substitution horn antenna is substituted for EUT at the same position and signals generator export the CW signal to the substitution antenna via a tx cable. Rotated the Turn Table and moved receiving antenna to find the maximum radiation power. Adjust output power level of S.G to get a Value of spectrum reading equal to “Read Value” of step b. Record the power level of S.G
- d.  $EIRP = \text{Output power level of S.G} - \text{TX cable loss} + \text{Antenna gain of substitution horn}.$

##### CONDUCTED POWER MEASUREMENT:

- a. The EUT was set up for the maximum power with LTE link data modulation and link up with simulator.
- b. Set the EUT to transmit under low, middle and high channel and record the power level shown on simulator.

### 4.1.3 TEST SETUP

#### EIRP / ERP MEASUREMENT:

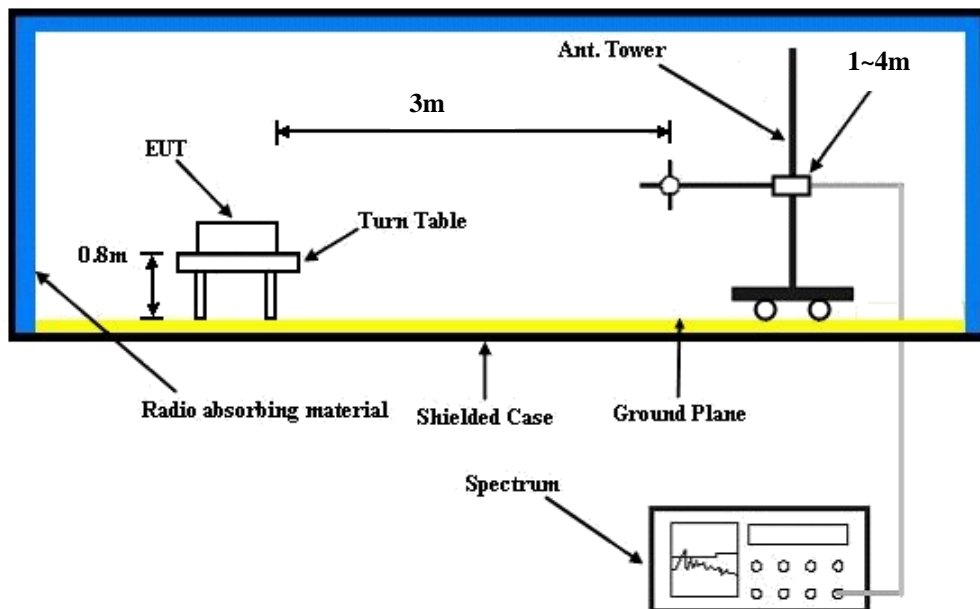

#### CONDUCTED POWER MEASUREMENT:

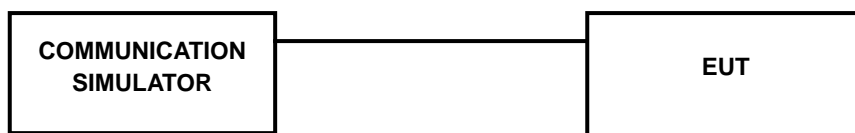



A D T

#### 4.1.4 TEST RESULTS

##### Conducted Output Power (dBm)

Band	WCDMA IV		
Channel	1312	1413	1513
Frequency (MHz)	1712.4	1732.6	1752.6
RMC 12.2K	26.40	26.30	26.32

##### EIRP (dBm)

WCDMA							
Plane	Channel	Frequency (MHz)	LVL (dBm)	Correction Factor(dB)	EIRP(dBm)	EIRP(mW)	Polarization (H/V)
X	1312	1712.4	-16.82	42.49	25.67	368.55	H
	1413	1732.6	-16.43	42.33	25.90	388.78	
	1513	1752.6	-16.49	42.10	25.61	363.92	
	1312	1712.4	-22.29	42.99	20.70	117.49	V
	1413	1732.6	-22.12	42.74	20.62	115.35	
	1513	1752.6	-21.87	42.21	20.34	108.14	

## 4.2 RADIATED EMISSION MEASUREMENT

### 4.2.1 LIMITS OF RADIATED EMISSION MEASUREMENT

The power of any emission outside a licensee's frequency block shall be attenuated below the transmitter power (P) by at least  $43 + 10 \log_{10}(P)$  dB. The limit of emission equal to  $-13\text{dBm}$

### 4.2.2 TEST PROCEDURES

- a. Substitution method is used for E.I.R.P measurement. In the semi-anechoic chamber, EUT placed on the 0.8m height of Turn Table, rotated the table around 360 degrees to search the maximum radiation power and receiver antenna shall be rotated vertical and horizontal polarization and moved height from 1m to 4m to find the maximum polar radiated power. The "Read Value" is the spectrum reading the maximum power value.
- b. The substitution horn antenna is substituted for EUT at the same position and signals generator export the CW signal to the substitution antenna via a TX cable. Rotated the Turn Table and moved receiving antenna to find the maximum radiation power. Adjust output power level of S.G to get a Value of spectrum reading equal to "Read Value " of step a. Record the power level of S.G
- c.  $\text{EIRP} = \text{Output power level of S.G} - \text{TX cable loss} + \text{Antenna gain of substitution horn.}$
- d. E.R.P power can be calculated form E.I.R.P power by subtracting the gain of dipole,  $\text{E.R.P power} = \text{E.I.P.R power} - 2.15\text{dBi.}$

**NOTE:** The resolution bandwidth of spectrum analyzer is 1 MHz and the video bandwidth is 3 MHz.

### 4.2.3 DEVIATION FROM TEST STANDARD

No deviation

#### 4.2.4 TEST SETUP

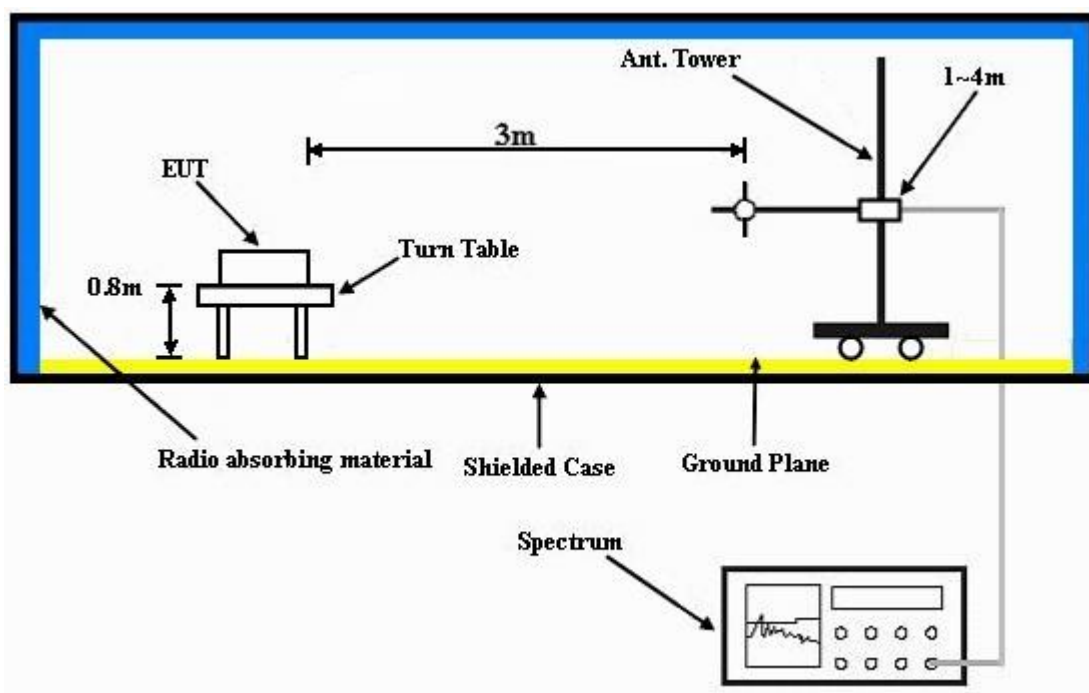

For the actual test configuration, please refer to the attached file (Test Setup Photo).





A D T

### 4.2.5 TEST RESULTS

#### WCDMA



Bureau Veritas Consumer Products Services Ltd., Taoyuan Branch

A D T

Data: 13

Date: 2015-05-25

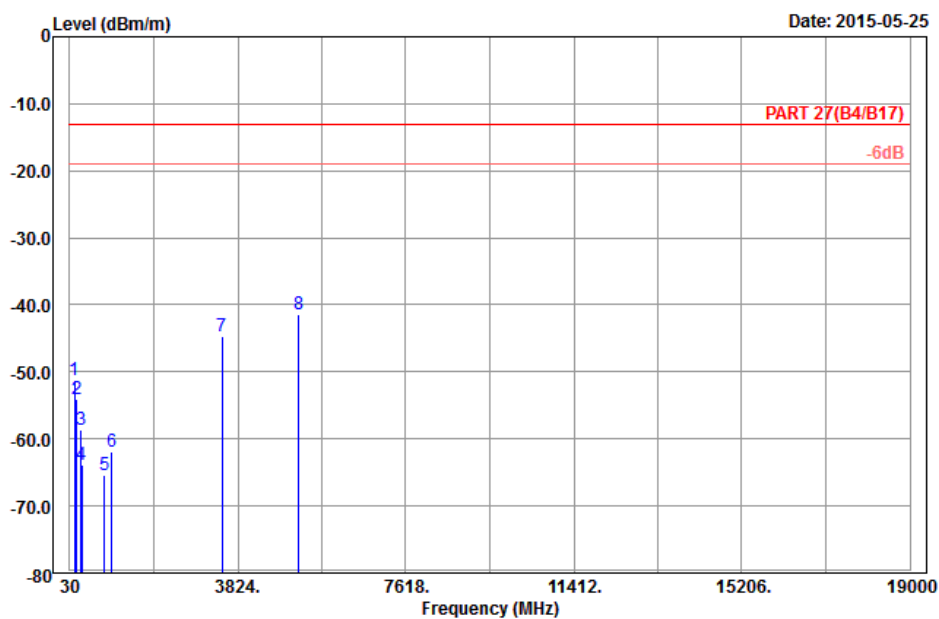

Site : 966 chamber 1  
 Condition: PART 27(B4/B17) 3m Horizontal  
 Remark : Band IV\_Link\_CH1413  
 Tested by: Hwa Chiang

	Freq	Level	Read Level	Limit	Over		
	MHz	dBm/m	dBm	dBm/m	dB	dB/m	Remark
1	142.05	-51.27	-43.51	-13.00	-38.27	-7.76	Peak
2	193.08	-54.03	-48.16	-13.00	-41.03	-5.87	Peak
3	291.36	-58.55	-52.67	-13.00	-45.55	-5.88	Peak
4	300.70	-63.84	-57.89	-13.00	-50.84	-5.95	Peak
5	814.50	-65.33	-67.18	-13.00	-52.33	1.85	Peak
6	979.70	-61.97	-67.17	-13.00	-48.97	5.20	Peak
7	3465.20	-44.75	-59.09	-13.00	-31.75	14.34	Peak
8 pp	5197.80	-41.51	-61.63	-13.00	-28.51	20.12	Peak



A D T



Bureau Veritas Consumer Products Services Ltd., Taoyuan Branch

A D T

Data: 14

Date: 2015-05-25

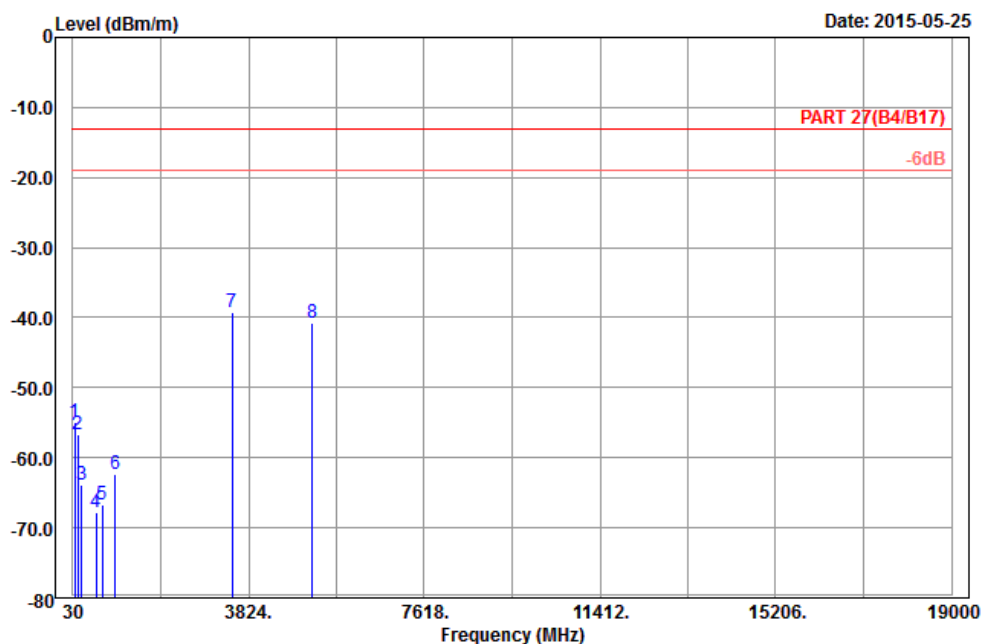

Site : 966 chamber 1  
 Condition: PART 27(B4/B17) 3m Vertical  
 Remark : Band IV\_Link\_CH1413  
 Tested by: Hwa Chiang

	Freq	Level	Read Level	Limit Line	Over Limit	Factor	Remark
	MHz	dBm/m	dBm	dBm/m	dB	dB/m	
1	76.44	-55.00	-42.90	-13.00	-42.00	-12.10	Peak
2	132.87	-56.58	-48.92	-13.00	-43.58	-7.66	Peak
3	213.33	-63.84	-57.84	-13.00	-50.84	-6.00	Peak
4	533.10	-67.87	-65.00	-13.00	-54.87	-2.87	Peak
5	668.90	-66.64	-66.41	-13.00	-53.64	-0.23	Peak
6	950.30	-62.24	-67.35	-13.00	-49.24	5.11	Peak
7 pp	3465.20	-39.20	-53.54	-13.00	-26.20	14.34	Peak
8	5197.80	-40.66	-60.78	-13.00	-27.66	20.12	Peak

## 5 INFORMATION ON THE TESTING LABORATORIES

We, Bureau Veritas Consumer Products Services (H.K.) Ltd., Taoyuan Branch, were founded in 1988 to provide our best service in EMC, Radio, Telecom and Safety consultation. Our laboratories are accredited and approved according to ISO/IEC 17025.

If you have any comments, please feel free to contact us at the following:

**Linko EMC/RF Lab:**

Tel: 886-2-26052180

Fax: 886-2-26051924

**Hsin Chu EMC/RF/Telecom Lab:**

Tel: 886-3-5935343

Fax: 886-3-5935342

**Hwa Ya EMC/RF/Safety Lab:**

Tel: 886-3-3183232

Fax: 886-3-3270892

**Email:** [service.adt@tw.bureauveritas.com](mailto:service.adt@tw.bureauveritas.com)

**Web Site:** [www.adt.com.tw](http://www.adt.com.tw)

The address and road map of all our labs can be found in our web site also.



A D T

## **6 APPENDIX A – MODIFICATIONS RECORDERS FOR ENGINEERING CHANGES TO THE EUT BY THE LAB**

No modifications were made to the EUT by the lab during the test.

**---END---**