



A D T

FCC TEST REPORT (WLAN/DTS 15.247)

REPORT NO.: RF140407E07

MODEL NO.: AW-CM389NF

FCC ID: TLZ-CM389NF

RECEIVED: Apr. 07, 2014

TESTED: Apr. 29 to June 10, 2014

ISSUED: July 02, 2014

APPLICANT: AzureWave Technologies, Inc.

ADDRESS: 8 F., No. 94, Baozhong Rd., Xindian, Taipei,
Taiwan 231

ISSUED BY: Bureau Veritas Consumer Products Services
(H.K.) Ltd., Taoyuan Branch Hsin Chu Laboratory

LAB ADDRESS : No. 81-1, Lu Liao Keng, 9th Ling, Wu Lung Tsuen,
Chiung Lin Hsiang, Hsin Chu Hsien 307, Taiwan,
R.O.C.

TEST LOCATION (1): No. 81-1, Lu Liao Keng, 9th Ling, Wu Lung Tsuen,
Chiung Lin Hsiang, Hsin Chu Hsien 307, Taiwan,
R.O.C.

TEST LOCATION (2): No. 49, Ln. 206, Wende Rd., Shangshan Tsuen,
Chiung Lin Hsiang, Hsin Chu Hsien 307, Taiwan,
R.O.C.

This report should not be used by the client to claim product certification, approval, or endorsement by TAF or any government agencies.



This report is for your exclusive use. Any copying or replication of this report to or for any other person or entity, or use of our name or trademark, is permitted only with our prior written permission. This report sets forth our findings solely with respect to the test samples identified herein. The results set forth in this report are not indicative or representative of the quality or characteristics of the lot from which a test sample was taken or any similar or identical product unless specifically and expressly noted. Our report includes all of the tests requested by you and the results thereof based upon the information that you provided to us. You have 60 days from date of issuance of this report to notify us of any material error or omission caused by our negligence, provided, however, that such notice shall be in writing and shall specifically address the issue you wish to raise. A failure to raise such issue within the prescribed time shall constitute your unqualified acceptance of the completeness of this report, the tests conducted and the correctness of the report contents. Unless specific mention, the uncertainty of measurement has been explicitly taken into account to declare the compliance or non-compliance to the specification



A D T

Table of Contents

RELEASE CONTROL RECORD.....	5
1. CERTIFICATION	6
2. SUMMARY OF TEST RESULTS.....	7
2.1 MEASUREMENT UNCERTAINTY	9
3. GENERAL INFORMATION.....	10
3.1 GENERAL DESCRIPTION OF EUT (WLAN/DTS).....	10
3.2 DESCRIPTION OF TEST MODES.....	14
3.2.1 TEST MODE APPLICABILITY AND TESTED CHANNEL DETAIL.....	16
3.3 GENERAL DESCRIPTION OF APPLIED STANDARDS	19
3.4 DUTY CYCLE OF TEST SIGNAL.....	20
3.5 DESCRIPTION OF SUPPORT UNITS	23
3.6 CONFIGURATION OF SYSTEM UNDER TEST	24
4. TEST TYPES AND RESULTS (FOR 2.4GHz, 2.400 ~ 2.4835GHz BAND).....	25
4.1 CONDUCTED EMISSION MEASUREMENT	25
4.1.1 LIMITS OF CONDUCTED EMISSION MEASUREMENT.....	25
4.1.2 TEST INSTRUMENTS	25
4.1.3 TEST PROCEDURES	26
4.1.4 DEVIATION FROM TEST STANDARD	26
4.1.5 TEST SETUP	26
4.1.6 EUT OPERATING CONDITIONS	27
4.1.7 TEST RESULTS (WLAN)	28
4.1.8 TEST RESULTS (BT<LE>).....	30
4.2 RADIATED EMISSION AND BANDEDGE MEASUREMENT.....	32
4.2.1 LIMITS OF RADIATED EMISSION AND BANDEDGE MEASUREMENT	32
4.2.2 TEST INSTRUMENTS	33
4.2.3 TEST PROCEDURES	35
4.2.4 DEVIATION FROM TEST STANDARD	36
4.2.5 TEST SETUP	36
4.2.6 EUT OPERATING CONDITIONS	36
4.2.7 TEST RESULTS (WLAN)	37
4.2.8 TEST RESULTS (BT<LE>).....	50
4.3 6DB BANDWIDTH MEASUREMENT.....	54
4.3.1 LIMITS OF 6DB BANDWIDTH MEASUREMENT	54
4.3.2 TEST INSTRUMENTS	54
4.3.3 TEST PROCEDURE	54
4.3.4 DEVIATION FROM TEST STANDARD	54
4.3.5 TEST SETUP	54
4.3.6 EUT OPERATING CONDITIONS	54
4.3.7 TEST RESULTS	55
4.4 CONDUCTED OUTPUT POWER MEASUREMENT	58
4.4.1 LIMITS OF CONDUCTED OUTPUT POWER MEASUREMENT.....	58
4.4.2 TEST INSTRUMENTS	58
4.4.3 TEST PROCEDURES	58
4.4.4 DEVIATION FROM TEST STANDARD	59
4.4.5 TEST SETUP	59
4.4.6 EUT OPERATING CONDITIONS	59
4.4.7 TEST RESULTS	60
4.5 POWER SPECTRAL DENSITY MEASUREMENT.....	62
4.5.1 LIMITS OF POWER SPECTRAL DENSITY MEASUREMENT	62
4.5.2 TEST INSTRUMENTS	62
4.5.3 TEST PROCEDURE	62



4.5.4	DEVIATION FROM TEST STANDARD	62
4.5.5	TEST SETUP	62
4.5.6	EUT OPERATING CONDITION	62
4.5.7	TEST RESULTS	63
4.6	CONDUCTED OUT-BAND EMISSION MEASUREMENT.....	67
4.6.1	LIMITS OF CONDUCTED OUT-BAND EMISSION MEASUREMENT	67
4.6.2	TEST INSTRUMENTS	67
4.6.3	TEST PROCEDURE	67
4.6.4	DEVIATION FROM TEST STANDARD	68
4.6.5	TEST SETUP	68
4.6.6	EUT OPERATING CONDITION	68
4.6.7	TEST RESULTS	68
5.	TEST TYPES AND RESULTS (FOR 5GHz, 5.725~5.850GHz BAND).....	78
5.1	CONDUCTED EMISSION MEASUREMENT	78
5.1.1	LIMITS OF CONDUCTED EMISSION MEASUREMENT.....	78
5.1.2	TEST INSTRUMENTS	78
5.1.3	TEST PROCEDURES	79
5.1.4	DEVIATION FROM TEST STANDARD	79
5.1.5	TEST SETUP	79
5.1.6	EUT OPERATING CONDITIONS	80
5.1.7	TEST RESULTS	81
5.2	RADIATED AND BANDEDGE EMISSION MEASUREMENT.....	83
5.2.1	LIMITS OF RADIATED AND BANDEDGE EMISSION MEASUREMENT	83
5.2.2	TEST INSTRUMENTS	84
5.2.3	TEST PROCEDURES	85
5.2.4	DEVIATION FROM TEST STANDARD	85
5.2.5	TEST SETUP	86
5.2.6	EUT OPERATING CONDITIONS	86
5.2.7	TEST RESULTS	87
5.3	6DB BANDWIDTH MEASUREMENT.....	97
5.3.1	LIMITS OF 6DB BANDWIDTH MEASUREMENT	97
5.3.2	TEST INSTRUMENTS	97
5.3.3	TEST PROCEDURE	97
5.3.4	DEVIATION FROM TEST STANDARD	97
5.3.5	TEST SETUP	97
5.3.6	EUT OPERATING CONDITIONS	97
5.3.7	TEST RESULTS	98
5.4	CONDUCTED OUTPUT POWER MEASUREMENT	100
5.4.1	LIMITS OF CONDUCTED OUTPUT POWER MEASUREMENT	100
5.4.2	INSTRUMENTS.....	100
5.4.3	TEST PROCEDURES	101
5.4.4	DEVIATION FROM TEST STANDARD	102
5.4.5	TEST SETUP	102
5.4.6	EUT OPERATING CONDITIONS	102
5.4.7	TEST RESULTS	103
5.5	POWER SPECTRAL DENSITY MEASUREMENT.....	105
5.5.1	LIMITS OF POWER SPECTRAL DENSITY MEASUREMENT	105
5.5.2	TEST INSTRUMENTS	105
5.5.3	TEST PROCEDURE	105
5.5.4	DEVIATION FROM TEST STANDARD	105
5.5.5	TEST SETUP	105
5.5.6	EUT OPERATING CONDITION	105
5.5.7	TEST RESULTS	106



A D T

5.6	CONDUCTED OUT-BAND EMISSION MEASUREMENT.....	108
5.6.1	LIMITS OF CONDUCTED OUT-BAND EMISSION MEASUREMENT	108
5.6.2	TEST INSTRUMENTS	108
5.6.3	TEST PROCEDURE	108
5.6.4	DEVIATION FROM TEST STANDARD	109
5.6.5	TEST SETUP	109
5.6.6	EUT OPERATING CONDITION	109
5.6.7	TEST RESULTS	109
6.	PHOTOGRAPHS OF THE TEST CONFIGURATION.....	118
7.	INFORMATION ON THE TESTING LABORATORIES	119
8.	APPENDIX A - MODIFICATIONS RECORDERS FOR ENGINEERING CHANGES TO THE EUT BY THE LAB.....	120



A D T

RELEASE CONTROL RECORD

ISSUE NO.	REASON FOR CHANGE	DATE ISSUED
RF140407E07	Original release	July 02, 2014



1. CERTIFICATION

PRODUCT: IEEE 802.11 2X2 MIMO a/b/g/n/ac Wireless LAN + Bluetooth + NFC NGFF Module

BRAND NAME: AzureWave

MODEL NO.: AW-CM389NF

TEST SAMPLE: ENGINEERING SAMPLE

APPLICANT: AzureWave Technologies, Inc.

TESTED: Apr. 29 to June 10, 2014

STANDARDS: **FCC Part 15, Subpart C (Section 15.247)**
ANSI C63.10-2009

The above equipment (Model: AW-CM389NF) has been tested by **Bureau Veritas Consumer Products Services (H.K.) Ltd., Taoyuan Branch**, and found compliance with the requirement of the above standards. The test record, data evaluation & Equipment Under Test (EUT) configurations represented herein are true and accurate accounts of the measurements of the sample's EMC characteristics under the conditions specified in this report.

PREPARED BY : Phoenix Huang , **DATE:** July 02, 2014
(Phoenix Huang, Specialist)

APPROVED BY : May Chen , **DATE:** July 02, 2014
(May Chen, Manager)



A D T

2. SUMMARY OF TEST RESULTS

The EUT has been tested according to the following specifications:

For 2.4GHz(WLAN), 2400~2483.5MHz Band

APPLIED STANDARD: FCC PART 15, SUBPART C (SECTION 15.247)			
STANDARD SECTION	TEST TYPE	RESULT	REMARK
15.207	AC Power Conducted Emission	PASS	Meet the requirement of limit. Minimum passing margin is -12.97dB at 0.19687MHz
15.247(d) 15.209	Radiated Emissions	PASS	Meet the requirement of limit. Minimum passing margin is -0.1dB at 2483.50MHz & 4824.00MHz
15.247(d)	Band Edge Measurement	PASS	Meet the requirement of limit.
15.247(a)(2)	6dB bandwidth	PASS	Meet the requirement of limit.
15.247(b)	Conducted Output power	PASS	Meet the requirement of limit.
15.247(e)	Power Spectral Density	PASS	Meet the requirement of limit.
15.203	Antenna Requirement	PASS	Antenna connector is i-pex(MHF) not a standard connector.

For 2.4GHz(BT-LE(GFSK)), 2402~2480MHz Band

APPLIED STANDARD: FCC PART 15, SUBPART C (SECTION 15.247)			
STANDARD SECTION	TEST TYPE	RESULT	REMARK
15.207	AC Power Conducted Emission	PASS	Meet the requirement of limit. Minimum passing margin is -13.77dB at 0.19687MHz
15.247(d) 15.209	Radiated Emissions	PASS	Meet the requirement of limit. Minimum passing margin is -2.0dB at 2483.5MHz
15.247(d)	Band Edge Measurement	PASS	Meet the requirement of limit.
15.247(a)(2)	6dB bandwidth	PASS	Meet the requirement of limit.
15.247(b)	Conducted Output power	PASS	Meet the requirement of limit.
15.247(e)	Power Spectral Density	PASS	Meet the requirement of limit.
15.203	Antenna Requirement	PASS	Antenna connector is i-pex(MHF) not a standard connector.



A D T

For 5GHz, 5725~5850MHz Band

APPLIED STANDARD: FCC PART 15, SUBPART C (SECTION 15.247)			
STANDARD SECTION	TEST TYPE	RESULT	REMARK
15.207	AC Power Conducted Emission	PASS	Meet the requirement of limit. Minimum passing margin is -12.00dB at 0.19297MHz
15.247(d) 15.209	Radiated Emissions	PASS	Meet the requirement of limit. Minimum passing margin is -3.4dB at 935.92MHz
15.247(d)	Band Edge Measurement	PASS	Meet the requirement of limit.
15.247(a)(2)	6dB bandwidth	PASS	Meet the requirement of limit.
15.247(b)	Conducted Output power	PASS	Meet the requirement of limit.
15.247(e)	Power Spectral Density	PASS	Meet the requirement of limit.
15.203	Antenna Requirement	PASS	Antenna connector is i-pex(MHF) not a standard connector.

NOTE: The EUT was operating in 2.400 ~ 2.4835GHz, 5.15~5.35GHz, 5.47~5.6GHz & 5.65~5.725GHz and 5.725~5.850GHz frequencies band. This report was recorded the RF parameters including 2.400 ~ 2.4835GHz and 5.725~5.850GHz. For the 5.15~5.35GHz, 5.47~5.6GHz & 5.65~5.725GHz RF parameters was recorded in another test report.

2.1 MEASUREMENT UNCERTAINTY

Where relevant, the following measurement uncertainty levels have been estimated for tests performed on the EUT as specified in CISPR 16-4-2:

This uncertainty represents an expanded uncertainty expressed at approximately the 95% confidence level using a coverage factor of $k=2$.

Measurement	Value
Conducted emissions	2.86 dB
Radiated emissions (30MHz-1GHz)	5.37 dB
Radiated emissions (1GHz -6GHz) for Chamber G	3.65 dB
Radiated emissions (1GHz -6GHz) for Chamber H	3.72 dB
Radiated emissions (6GHz -18GHz) for Chamber G	3.88 dB
Radiated emissions (6GHz -18GHz) for Chamber H	4.00 dB
Radiated emissions (18GHz -40GHz)	4.11 dB



3. GENERAL INFORMATION

3.1 GENERAL DESCRIPTION OF EUT (WLAN/DTS)

PRODUCT	IEEE 802.11 2X2 MIMO a/b/g/n/ac Wireless LAN + Bluetooth + NFC NGFF Module
MODEL NO.	AW-CM389NF
POWER SUPPLY	3.3Vdc (from host equipment)
MODULATION TYPE	CCK, DQPSK, DBPSK for DSSS 64QAM, 16QAM, QPSK, BPSK for OFDM BT-LE (GFSK) for DTS 256QAM for OFDM in 11ac mode only
MODULATION TECHNOLOGY	DSSS, OFDM, DTS
TRANSFER RATE	802.11b: up to 11Mbps 802.11a / g: up to 54Mbps 802.11n: up to 300Mbps 802.11ac: up to 866.7Mbps BT-LE (GFSK): 1Mbps
OPERATING FREQUENCY	For 15.407 5GHz: 5.18 ~ 5.24GHz, 5.26 ~ 5.32GHz, 5.50 ~ 5.58GHz & 5.66GHz ~ 5.70GHz
	For 15.247 2.4GHz: 2.412 ~ 2.462GHz 5GHz: 5.745 ~ 5.825GHz BT-LE(GFSK): 2.402 ~ 2.480GHz
NUMBER OF CHANNEL	For 15.407 16 for 802.11a, 802.11n (HT20), 802.11ac (VHT20) 7 for 802.11n (HT40), 802.11ac (VHT40) 3 for 802.11ac (VHT80)
	For 15.247 (2.4GHz) 11 for 802.11b, 802.11g, 802.11n (HT20) 7 for 802.11n (HT40) 40 for BT-LE(GFSK) For 15.247 (5GHz) 5 for 802.11a, 802.11n (HT20), 802.11ac (VHT20) 2 for 802.11n (HT40), 802.11ac (VHT40) 1 for 802.11ac (VHT80)

MAXIMUM OUTPUT POWER	<p>For 15.407</p> <p>802.11a: 74.508mW 802.11ac (VHT20): 76.001mW 802.11ac (VHT40): 67.59mW 802.11ac (VHT80): 16.936mW</p> <p>For 15.247 (2.4GHz)</p> <p>802.11b: 71.042mW 802.11g: 694.376mW 802.11n (HT20): 695.976mW 802.11n (HT40): 286.123mW BT-LE(GFSK): 7.709mW</p> <p>For 15.247 (5GHz)</p> <p>802.11a: 372.853mW 802.11ac (VHT20): 370.202mW 802.11ac (VHT40): 335.013mW 802.11ac (VHT80): 541.874mW</p>
ANTENNA TYPE	Please see NOTE
DATA CABLE	NA
I/O PORTS	Refer to user's manual
ASSOCIATED DEVICES	NA

Note:

1. There are Bluetooth, WLAN and NFC technology used for the EUT.
2. WLAN/BT/NFC coexistence mode:

Condition	Technology		
1	WLAN(2.4GHz) 1Tx only	BT	NFC
2	WLAN(5GHz) 1Tx only	BT	NFC

From above coexistence mode, radiated emission of the simultaneous operation has been evaluated and no non-compliance was found.



3. The antennas provided to the EUT, please refer to the following table:

For WLAN / BT used (Set 1 antenna)								
Antenna No.	Transmitter Circuit	Brand	Model	Antenna Gain(dBi) < including cable loss>	Frequency range (MHz to MHz)	Antenna Type	Connector Type	Cable Length (cm)
1	Chain (0)	MAG.LAYERS	MSA-4008-25GC1-A1	2.98	2400~2500	PIFA	i-pex(MHF)	15
				5.16	4900~5900			
2	Chain (1)	MAG.LAYERS	MSA-4008-25GC1-A1	2.98	2400~2500	PIFA	i-pex(MHF)	15
				5.16	4900~5900			
For WLAN / BT used (Set 2 antenna)								
Antenna No.	Transmitter Circuit	Brand	Model	Antenna Gain(dBi) < including cable loss>	Frequency range (MHz to MHz)	Antenna Type	Connector Type	Cable Length (cm)
3	Main Antenna Chain 0	Wistron Neweb Corporation	DC33001KT00 (81EAAL15.G92)	1.54	2400~2500	PIFA	i-pex(MHF)	36.3
				1.26	5150~5850			
4	Aux Antenna Chain 1	Wistron Neweb Corporation	DC33001KT10 (81EAAL15.G75)	0.63	2400~2500	PIFA	i-pex(MHF)	59.3
				1.84	5150~5850			
For NFC used								
Antenna No.	Brand	Model	Antenna Gain(dBi)	Frequency range (MHz)	Antenna Type	Connector Type	Cable Length (cm)	
5	Marvell	30X40X4T_PCB	0.5	13.56	PCB	i-pex(MHF)	N/A	

From the above antenna sets, the **set 1** was selected as representative antenna for the test and its data was recorded in this report.

4. The EUT incorporates a MIMO function without Beamforming.

MODULATION MODE	DATA RATE (MCS)	TX & RX CONFIGURATION	
802.11a	6 ~ 54Mbps	1Tx diversity/2TX(CDD)	1Rx diversity/2RX
802.11b	1 ~ 11Mbps	1Tx diversity/2TX(CDD)	1Rx diversity/2RX
802.11g	6 ~ 54Mbps	1Tx diversity/2TX(CDD)	1Rx diversity/2RX
802.11n (HT20)	MCS 0~7	1Tx	1Rx diversity
	MCS 8~15	2Tx	2Rx
802.11n (HT40)	MCS 0~7	1Tx	1Rx diversity
	MCS 8~15	2Tx	2Rx
802.11ac (VHT20) (5GHz)	MCS0~8 (256QAM) Nss=1	1Tx	1Rx diversity
	MCS0~8 (256QAM) Nss=2	2Tx	2Rx
802.11ac (VHT40) (5GHz)	MCS0~9 (256QAM) Nss=1	1Tx	1Rx diversity
	MCS0~9 (256QAM) Nss=2	2Tx	2Rx
802.11ac (VHT80) (5GHz)	MCS0~9 (256QAM) Nss=1	1Tx	1Rx diversity
	MCS0~9 (256QAM) Nss=2	2Tx	2Rx

Note: The modulation and bandwidth are similar for 802.11n mode for 20MHz (40MHz) and 802.11ac mode for 20MHz (40MHz), therefore investigated worst case to representative mode in test report. (Final test mode refer section 3.2.1)

5. The above EUT information was declared by the manufacturer and for more detailed features description, please refer to the manufacturer's specifications or User's Manual.

3.2 DESCRIPTION OF TEST MODES

Operated in 2400 ~ 2483.5MHz band:

11 channels are provided for 802.11b, 802.11g, 802.11n (HT20):

CHANNEL	FREQUENCY	CHANNEL	FREQUENCY
1	2412MHz	7	2442MHz
2	2417MHz	8	2447MHz
3	2422MHz	9	2452MHz
4	2427MHz	10	2457MHz
5	2432MHz	11	2462MHz
6	2437MHz		

7 channels are provided for 802.11n (HT40):

CHANNEL	FREQUENCY	CHANNEL	FREQUENCY
3	2422MHz	7	2442MHz
4	2427MHz	8	2447MHz
5	2432MHz	9	2452MHz
6	2437MHz		

40 channels are provided for Bluetooth LE mode:

CHANNEL	FREQ. (MHZ)	CHANNEL	FREQ. (MHZ)	CHANNEL	FREQ. (MHZ)	CHANNEL	FREQ. (MHZ)
0	2402	10	2422	20	2442	30	2462
1	2404	11	2424	21	2444	31	2464
2	2406	12	2426	22	2446	32	2466
3	2408	13	2428	23	2448	33	2468
4	2410	14	2430	24	2450	34	2470
5	2412	15	2432	25	2452	35	2472
6	2414	16	2434	26	2454	36	2474
7	2416	17	2436	27	2456	37	2476
8	2418	18	2438	28	2458	38	2478
9	2420	19	2440	29	2460	39	2480



A D T

Operated in 5725 ~ 5850MHz band:

5 channels are provided for 802.11a, 802.11n (HT20), 802.11ac (VHT20):

CHANNEL	FREQUENCY	CHANNEL	FREQUENCY
149	5745 MHz	161	5805 MHz
153	5765 MHz	165	5825 MHz
157	5785 MHz		

2 channels are provided for 802.11n (HT40), 802.11ac (VHT40):

CHANNEL	FREQUENCY
151	5755 MHz
159	5795 MHz

1 channel is provided for 802.11ac (VHT80):

CHANNEL	FREQUENCY
155	5775 MHz

3.2.1 TEST MODE APPLICABILITY AND TESTED CHANNEL DETAIL

EUT CONFIGURE MODE	APPLICABLE TO					DESCRIPTION
	PLC	RE < 1G	RE ≥ 1G	APCM	OB	
-	√	√	√	√	√	-

Where **PLC**: Power Line Conducted Emission **RE < 1G**: Radiated Emission below 1GHz
RE ≥ 1G: Radiated Emission above 1GHz **APCM**: Antenna Port Conducted Measurement
OB: Conducted Out-Band Emission Measurement

NOTE: 1. **For 2.4GHz:** The EUT's antenna (PIFA) had been pre-tested on the positioned of each 3 axis. The worst case was found when positioned on **X-plane** (for below 1GHz) and **Z-plane** (for above 1GHz).
2. **For 5GHz:** The EUT's antenna (PIFA) had been pre-tested on the positioned of each 3 axis. The worst case was found when positioned on **X-plane**.

POWER LINE CONDUCTED EMISSION TEST:

- Pre-Scan has been conducted to determine the worst-case mode from all possible combinations between available modulations, data rates and antenna ports (if EUT with antenna diversity architecture).
- Following channel(s) was (were) selected for the final test as listed below.

MODE	AVAILABLE CHANNEL	TESTED CHANNEL	MODULATION TECHNOLOGY	MODULATION TYPE	DATA RATE (Mbps)
802.11g	1 to 11	6	OFDM	BPSK	6
BT-LE	0 to 39	0	DTS	GFSK	1
802.11a	149 to 165	149	OFDM	BPSK	6

RADIATED EMISSION TEST (BELOW 1 GHz):

- Pre-Scan has been conducted to determine the worst-case mode from all possible combinations between available modulations, data rates and antenna ports (if EUT with antenna diversity architecture).
- Following channel(s) was (were) selected for the final test as listed below.

MODE	AVAILABLE CHANNEL	TESTED CHANNEL	MODULATION TECHNOLOGY	MODULATION TYPE	DATA RATE (Mbps)
802.11g	1 to 11	6	OFDM	BPSK	6
BT-LE	0 to 39	0	DTS	GFSK	1
802.11a	149 to 165	149	OFDM	BPSK	6

RADIATED EMISSION TEST (ABOVE 1 GHz):

- Pre-Scan has been conducted to determine the worst-case mode from all possible combinations between available modulations, data rates and antenna ports (if EUT with antenna diversity architecture).
- Following channel(s) was (were) selected for the final test as listed below.

MODE	AVAILABLE CHANNEL	TESTED CHANNEL	MODULATION TECHNOLOGY	MODULATION TYPE	DATA RATE (Mbps)
802.11b	1 to 11	1, 6, 11	DSSS	DBPSK	1
802.11g	1 to 11	1, 6, 11	OFDM	BPSK	6
For 2.4 GHz 802.11n (HT20)	1 to 11	1, 6, 11	OFDM	BPSK	13
For 2.4 GHz 802.11n (HT40)	3 to 9	3, 6, 9	OFDM	BPSK	27
BT-LE	0 to 39	0, 19, 39	DTS	GFSK	1
802.11a	149 to 165	149, 157, 165	OFDM	BPSK	6
For 5 GHz 802.11ac (VHT20)	149 to 165	149, 157, 165	OFDM	BPSK	13
For 5 GHz 802.11ac (VHT40)	151 to 159	151, 159	OFDM	BPSK	27
For 5 GHz 802.11ac (VHT80)	155	155	OFDM	BPSK	58.5

ANTENNA PORT CONDUCTED MEASUREMENT:

- Pre-Scan has been conducted to determine the worst-case mode from all possible combinations between available modulations, data rates and antenna ports (if EUT with antenna diversity architecture).
- Following channel(s) was (were) selected for the final test as listed below.

MODE	AVAILABLE CHANNEL	TESTED CHANNEL	MODULATION TECHNOLOGY	MODULATION TYPE	DATA RATE (Mbps)
802.11b	1 to 11	1, 6, 11	DSSS	DBPSK	1
802.11g	1 to 11	1, 6, 11	OFDM	BPSK	6
For 2.4 GHz 802.11n (HT20)	1 to 11	1, 6, 11	OFDM	BPSK	13
For 2.4 GHz 802.11n (HT40)	3 to 9	3, 6, 9	OFDM	BPSK	27
BT-LE	0 to 39	0, 19, 39	DTS	GFSK	1
802.11a	149 to 165	149, 157, 165	OFDM	BPSK	6
For 5 GHz 802.11ac (VHT20)	149 to 165	149, 157, 165	OFDM	BPSK	13
For 5 GHz 802.11ac (VHT40)	151 to 159	151, 159	OFDM	BPSK	27
For 5 GHz 802.11ac (VHT80)	155	155	OFDM	BPSK	58.5



CONDUCTED OUT-BAND EMISSION MEASUREMENT:

- Pre-Scan has been conducted to determine the worst-case mode from all possible combinations between available modulations, data rates and antenna ports (if EUT with antenna diversity architecture).
- Following channel(s) was (were) selected for the final test as listed below.

MODE	AVAILABLE CHANNEL	TESTED CHANNEL	MODULATION TECHNOLOGY	MODULATION TYPE	DATA RATE (Mbps)
802.11b	1 to 11	1, 6, 11	DSSS	DBPSK	1
802.11g	1 to 11	1, 6, 11	OFDM	BPSK	6
For 2.4 GHz 802.11n (HT20)	1 to 11	1, 6, 11	OFDM	BPSK	13
For 2.4 GHz 802.11n (HT40)	3 to 9	3, 6, 9	OFDM	BPSK	27
BT-LE	0 to 39	0, 19, 39	DTS	GFSK	1
802.11a	149 to 165	149, 157, 165	OFDM	BPSK	6
For 5 GHz 802.11ac (VHT20)	149 to 165	149, 157, 165	OFDM	BPSK	13
For 5 GHz 802.11ac (VHT40)	151 to 159	151, 159	OFDM	BPSK	27
For 5 GHz 802.11ac (VHT80)	155	155	OFDM	BPSK	58.5

TEST CONDITION:

APPLICABLE TO	ENVIRONMENTAL CONDITIONS	INPUT POWER (SYSTEM)	TESTED BY
PLC	26deg. 67C,%RH	120Vac, 60Hz	Ping Liu
RE<1G	23deg. C, 67%RH	120Vac, 60Hz	Robert Cheng
RE≥1G	22deg. C, 66%RH	120Vac, 60Hz	Andy Ho
	24deg. C, 67%RH	120Vac, 60Hz	Nelson Teng
APCM	25deg. C, 60%RH	120Vac, 60Hz	Chilin Lee
OB	25deg. C, 60%RH	120Vac, 60Hz	Chilin Lee

3.3 GENERAL DESCRIPTION OF APPLIED STANDARDS

The EUT is a RF product. According to the specifications of the manufacturer, it must comply with the requirements of the following standards:

FCC Part 15, Subpart C (15.247)

558074 D01 DTS Meas Guidance v03r01

662911 D01 Multiple Transmitter Output v02

ANSI C63.10-2009

All test items have been performed and recorded as per the above standards.

3.4 DUTY CYCLE OF TEST SIGNAL

Duty cycle of test signal is 100 %, duty factor is not required.

For 2.4GHz

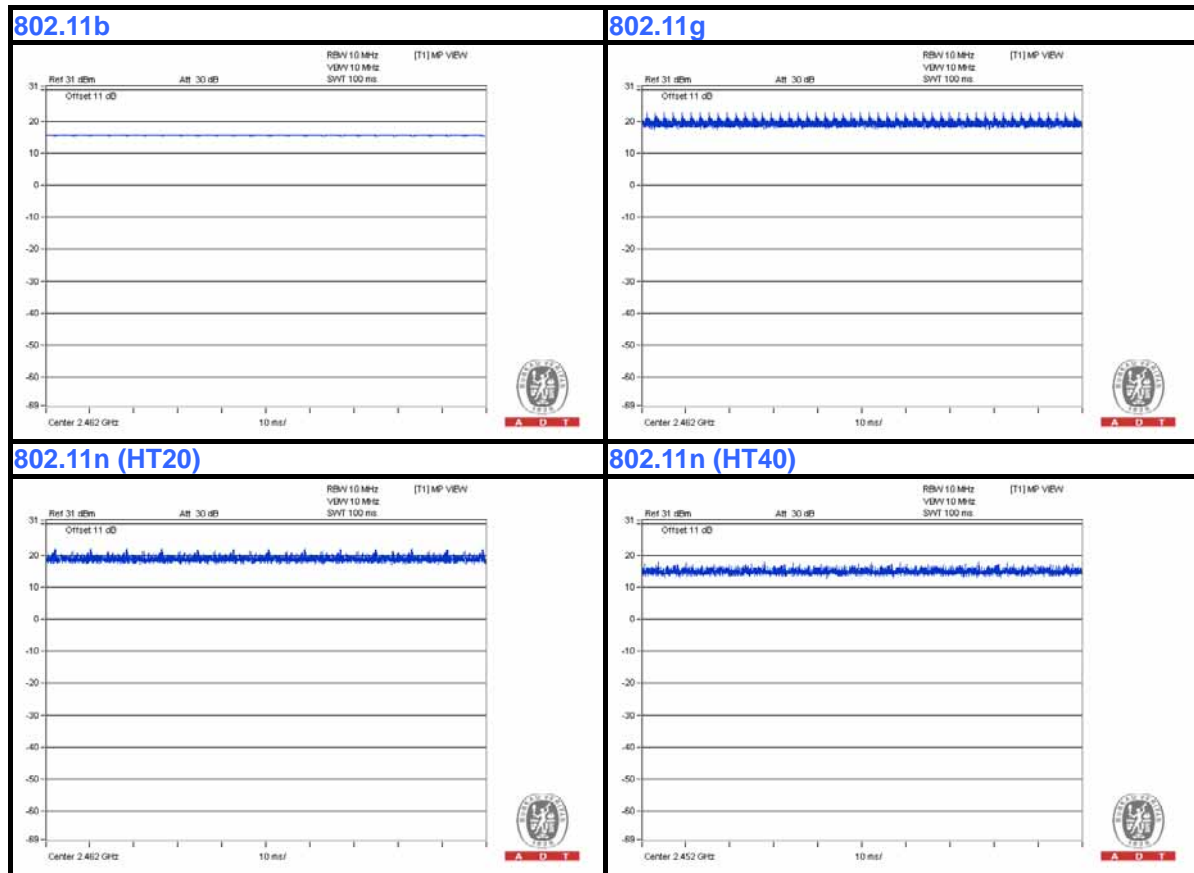

Duty cycle of test signal is < 98%, duty factor shall be considered.

For BT_LE-GFSK:

Duty cycle = $0.3775 \text{ ms} / 0.625 \text{ ms} = 0.604$, Duty factor = $10 * \log(1/0.604) = 2.2$

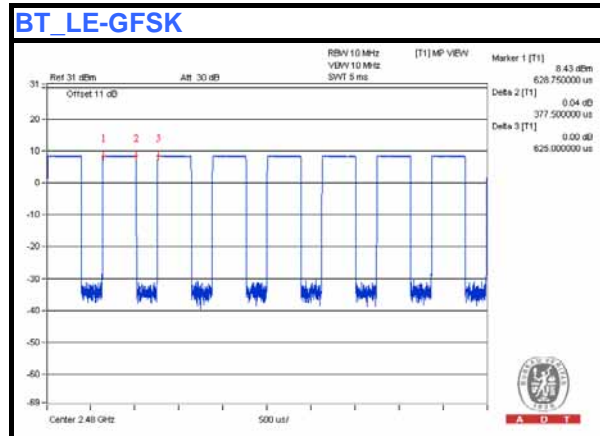



A D T

Duty cycle of test signal is 100 %, duty factor is not required.

For 5GHz

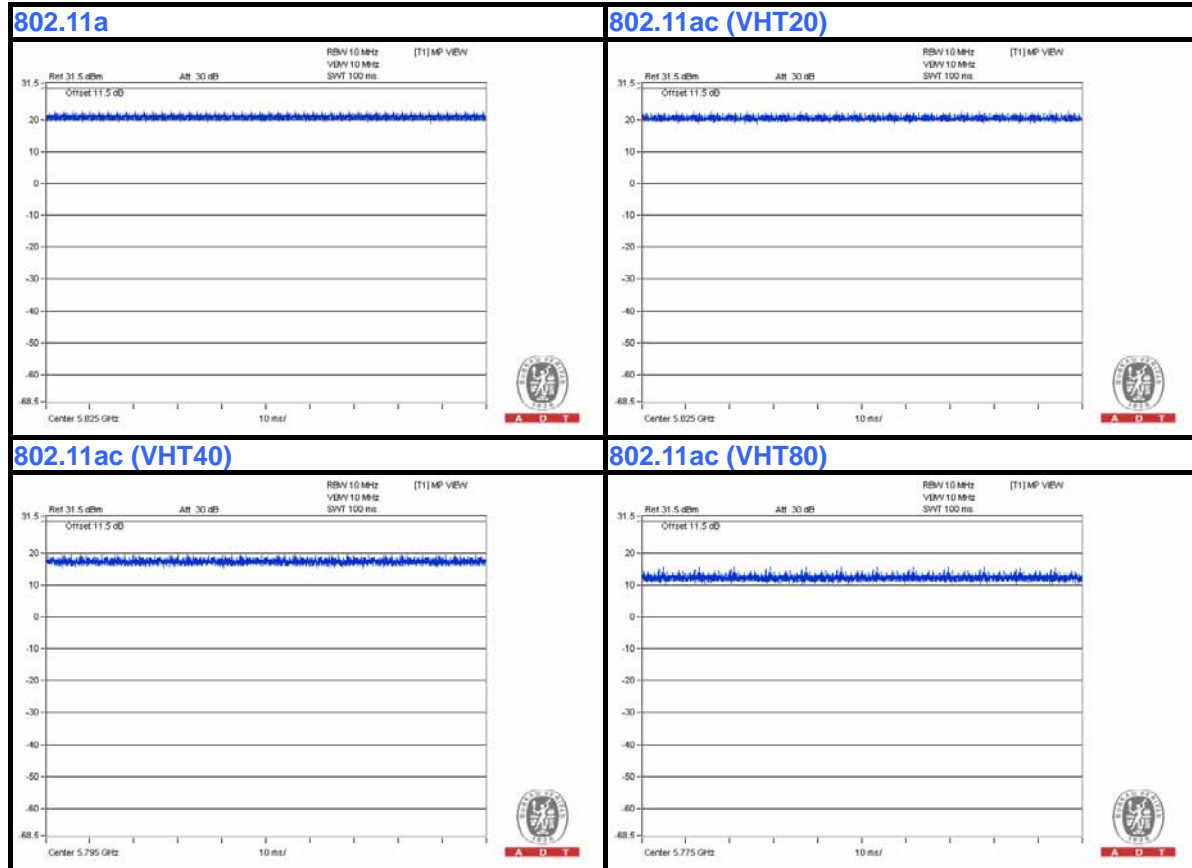



3.5 DESCRIPTION OF SUPPORT UNITS

The EUT has been tested as an independent unit together with other necessary accessories or support units. The following support units or accessories were used to form a representative test configuration during the tests.

No.	Product	Brand	Model No.	Serial No.	FCC ID
1	NOTEBOOK COMPUTER	ASUS	NA	NA	NA
2	NOTEBOOK COMPUTER	DELL	PP32LA	GSLB32S	FCC DoC
3	TEST TOOL	AzureWave	NA	NA	NA
4	SDIO Card	AzureWave	NA	NA	NA

No.	Signal cable description
1	NA
2	UTP Cable, 10m
3	NA
4	NA

Note: The power cords of the above support units were unshielded (1.8m).

3.6 CONFIGURATION OF SYSTEM UNDER TEST

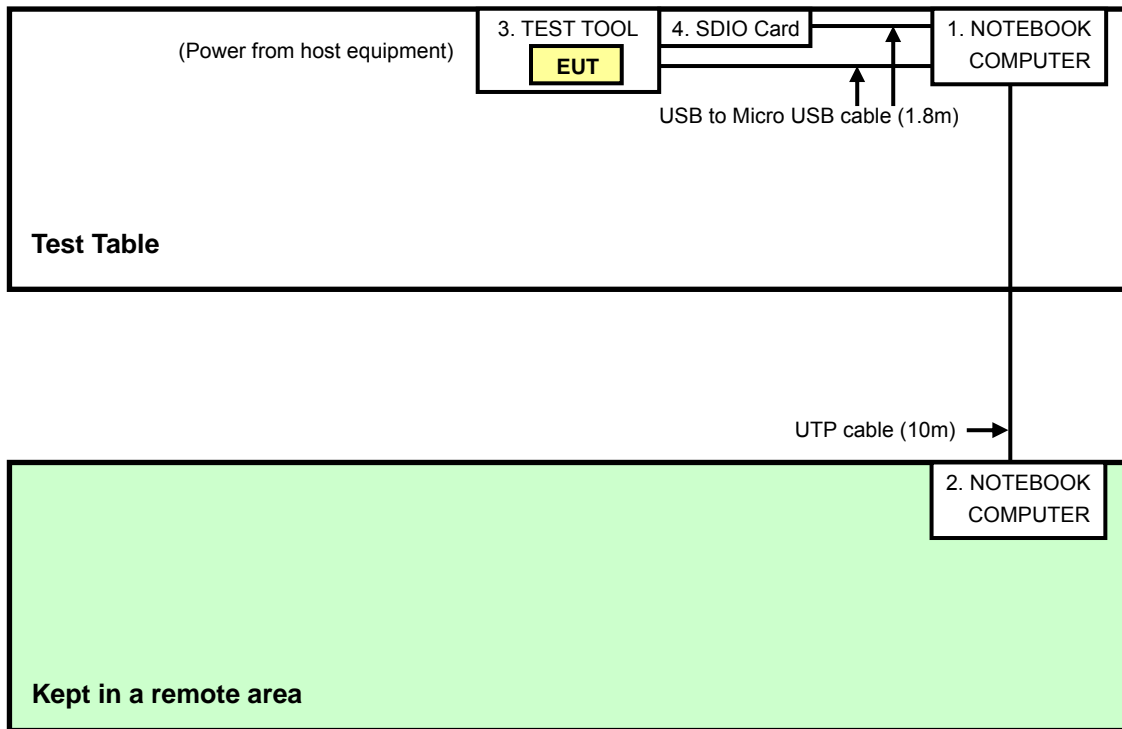



A D T

4. TEST TYPES AND RESULTS (FOR 2.4GHz, 2.400 ~ 2.4835GHz Band)

4.1 CONDUCTED EMISSION MEASUREMENT

4.1.1 LIMITS OF CONDUCTED EMISSION MEASUREMENT

FREQUENCY OF EMISSION (MHz)	CONDUCTED LIMIT (dB μ V)	
	Quasi-peak	Average
0.15-0.5	66 to 56	56 to 46
0.5-5	56	46
5-30	60	50

- NOTE:**
1. The lower limit shall apply at the transition frequencies.
 2. The limit decreases in line with the logarithm of the frequency in the range of 0.15 to 0.50 MHz.

4.1.2 TEST INSTRUMENTS

DESCRIPTION & MANUFACTURER	MODEL NO.	SERIAL NO.	CALIBRATED DATE	CALIBRATED UNTIL
Test Receiver ROHDE & SCHWARZ	ESCS 30	100375	Apr. 29, 2014	Apr. 28, 2015
Line-Impedance Stabilization Network (for EUT) SCHWARZBECK	NSLK8127	8127-522	Sep. 05, 2013	Sep. 04, 2014
Line-Impedance Stabilization Network (for Peripheral)	ENV216	100072	June 06, 2013	June 05, 2014
RF Cable (JYEBAO)	5DFB	CONCAB-003	Mar. 07, 2014	Mar. 06, 2015
50 ohms Terminator	50	EMC-03	Sep. 24, 2013	Sep. 23, 2014
Software ADT	BV ADT_Cond_V7.3.7. 3	NA	NA	NA

Note:

1. The calibration interval of the above test instruments is 12 months and the calibrations are traceable to NML/ROC and NIST/USA.
2. The test was performed in Shielded Room No. C.
3. The VCCI Con C Registration No. is C-3611.
4. Tested Date: Apr. 29, 2014

4.1.3 TEST PROCEDURES

- a. The EUT was placed 0.4 meters from the conducting wall of the shielded room with EUT being connected to the power mains through a line impedance stabilization network (LISN). Other support units were connected to the power mains through another LISN.
- b. The two LISNs provide 50 ohm/ 50uH of coupling impedance for the measuring instrument.
- c. Both lines of the power mains connected to the EUT were checked for maximum conducted interference.
- d. The frequency range from 150kHz to 30MHz was searched. Emission levels under (Limit - 20dB) were not recorded.

NOTE:

1. The resolution bandwidth of test receiver is 9kHz for Quasi-peak detection (QP) & Average detection (AV).

4.1.4 DEVIATION FROM TEST STANDARD

No deviation

4.1.5 TEST SETUP

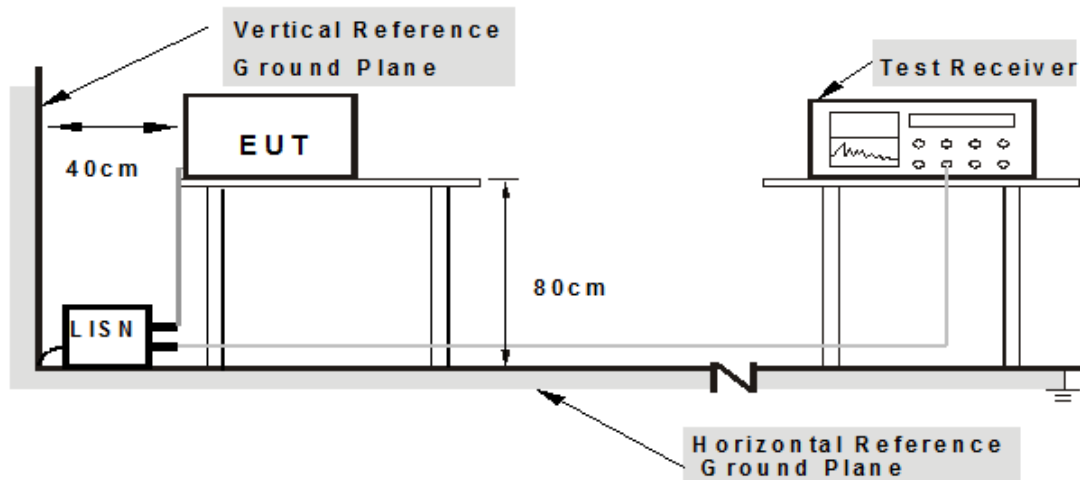

Note: 1. Support units were connected to second LISN.

For the actual test configuration, please refer to the related item – Photographs of the Test Configuration.



A D T

4.1.6 EUT OPERATING CONDITIONS

1. Connect the EUT with the support unit 2 (Notebook Computer) which is placed in a remote area.
2. The communication partner run test program “DutApiMimoBtFmBrdigeEth.exe[ver.2.0.0.43]” to enable EUT under transmission/receiving condition continuously at specific channel frequency.

4.1.7 TEST RESULTS (WLAN)

PHASE	Line (L)	DETECTOR FUNCTION	Quasi-Peak (QP) / Average (AV)
-------	----------	-------------------	--------------------------------

No	Freq.	Corr.	Reading Value		Emission Level		Limit		Margin	
	[MHz]	Factor (dB)	[dB (uV)]		[dB (uV)]		[dB (uV)]		(dB)	
			Q.P.	AV.	Q.P.	AV.	Q.P.	AV.	Q.P.	AV.
1	0.19687	0.06	49.77	40.71	49.83	40.77	63.74	53.74	-13.91	-12.97
2	0.25938	0.06	45.40	36.90	45.46	36.96	61.45	51.45	-15.99	-14.49
3	0.59141	0.08	37.26	26.16	37.34	26.24	56.00	46.00	-18.66	-19.76
4	0.71641	0.08	34.82	25.11	34.90	25.19	56.00	46.00	-21.10	-20.81
5	3.81641	0.19	36.35	26.52	36.54	26.71	56.00	46.00	-19.46	-19.29
6	22.25000	0.73	32.04	24.72	32.77	25.45	60.00	50.00	-27.23	-24.55

REMARKS:

1. Q.P. and AV. are abbreviations of quasi-peak and average individually.
2. The emission levels of other frequencies were very low against the limit.
3. Margin value = Emission Level – Limit value
4. Correction Factor = Insertion loss + Cable loss
5. Emission Level = Correction Factor + Reading Value

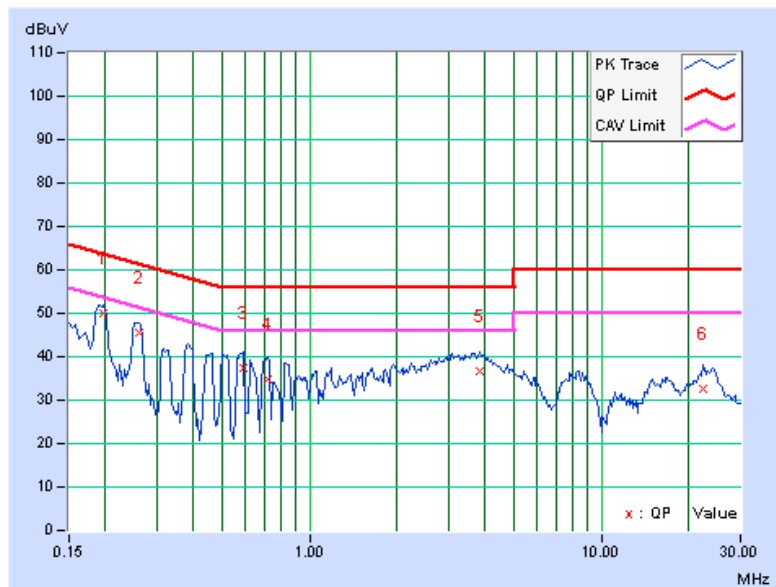

PHASE	Neutral (N)	DETECTOR FUNCTION	Quasi-Peak (QP) / Average (AV)
--------------	-------------	--------------------------	--------------------------------

No	Freq. [MHz]	Corr. Factor (dB)	Reading Value [dB (uV)]		Emission Level [dB (uV)]		Limit [dB (uV)]		Margin (dB)	
			Q.P.	AV.	Q.P.	AV.	Q.P.	AV.	Q.P.	AV.
1	0.19687	0.06	48.33	38.61	48.39	38.67	63.74	53.74	-15.35	-15.07
2	0.25938	0.06	44.42	36.10	44.48	36.16	61.45	51.45	-16.97	-15.29
3	0.45078	0.07	39.72	32.93	39.79	33.00	56.86	46.86	-17.07	-13.86
4	0.52500	0.07	39.42	29.98	39.49	30.05	56.00	46.00	-16.51	-15.95
5	0.56406	0.08	39.21	27.28	39.29	27.36	56.00	46.00	-16.71	-18.64
6	3.82031	0.19	35.83	25.72	36.02	25.91	56.00	46.00	-19.98	-20.09

REMARKS:

1. Q.P. and AV. are abbreviations of quasi-peak and average individually.
2. The emission levels of other frequencies were very low against the limit.
3. Margin value = Emission Level – Limit value
4. Correction Factor = Insertion loss + Cable loss
5. Emission Level = Correction Factor + Reading Value

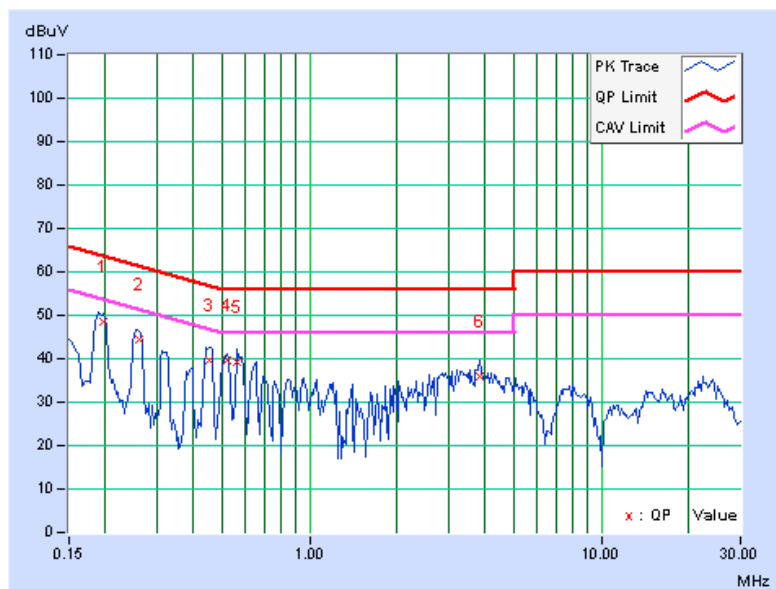

4.1.8 TEST RESULTS (BT<LE>)

PHASE	Line (L)	DETECTOR FUNCTION	Quasi-Peak (QP) / Average (AV)
-------	----------	-------------------	--------------------------------

No	Freq. [MHz]	Corr. Factor [dB]	Reading Value [dB (uV)]		Emission Level [dB (uV)]		Limit [dB (uV)]		Margin (dB)	
			Q.P.	AV.	Q.P.	AV.	Q.P.	AV.	Q.P.	AV.
			1	0.18906	0.06	48.81	38.31	48.87	38.37	64.08
2	0.25156	0.06	44.44	33.16	44.50	33.22	61.71	51.71	-17.20	-18.48
3	0.45078	0.07	39.43	32.60	39.50	32.67	56.86	46.86	-17.36	-14.19
4	0.56406	0.08	39.05	27.20	39.13	27.28	56.00	46.00	-16.87	-18.72
5	0.65000	0.08	35.98	26.94	36.06	27.02	56.00	46.00	-19.94	-18.98
6	3.82422	0.19	34.62	25.12	34.81	25.31	56.00	46.00	-21.19	-20.69

REMARKS:

1. Q.P. and AV. are abbreviations of quasi-peak and average individually.
2. The emission levels of other frequencies were very low against the limit.
3. Margin value = Emission Level – Limit value
4. Correction Factor = Insertion loss + Cable loss
5. Emission Level = Correction Factor + Reading Value

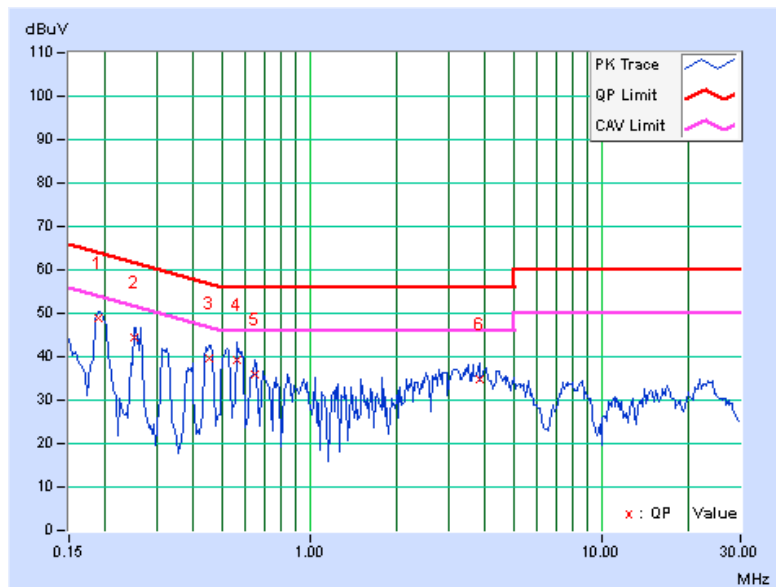

PHASE	Neutral (N)	DETECTOR FUNCTION	Quasi-Peak (QP) / Average (AV)
--------------	-------------	--------------------------	--------------------------------

No	Freq.	Corr.	Reading Value		Emission Level		Limit		Margin	
	[MHz]	Factor	[dB (uV)]		[dB (uV)]		[dB (uV)]		(dB)	
		(dB)	Q.P.	AV.	Q.P.	AV.	Q.P.	AV.	Q.P.	AV.
1	0.19297	0.06	48.43	41.85	48.49	41.91	63.91	53.91	-15.42	-12.00
2	0.25156	0.06	44.42	33.56	44.48	33.62	61.71	51.71	-17.22	-18.08
3	0.45469	0.07	40.19	33.36	40.26	33.43	56.79	46.79	-16.53	-13.36
4	0.52500	0.07	39.68	30.10	39.75	30.17	56.00	46.00	-16.25	-15.83
5	0.57578	0.08	38.43	29.63	38.51	29.71	56.00	46.00	-17.49	-16.29
6	3.21875	0.18	34.53	24.45	34.71	24.63	56.00	46.00	-21.29	-21.37

REMARKS:

1. Q.P. and AV. are abbreviations of quasi-peak and average individually.
2. The emission levels of other frequencies were very low against the limit.
3. Margin value = Emission Level – Limit value
4. Correction Factor = Insertion loss + Cable loss
5. Emission Level = Correction Factor + Reading Value

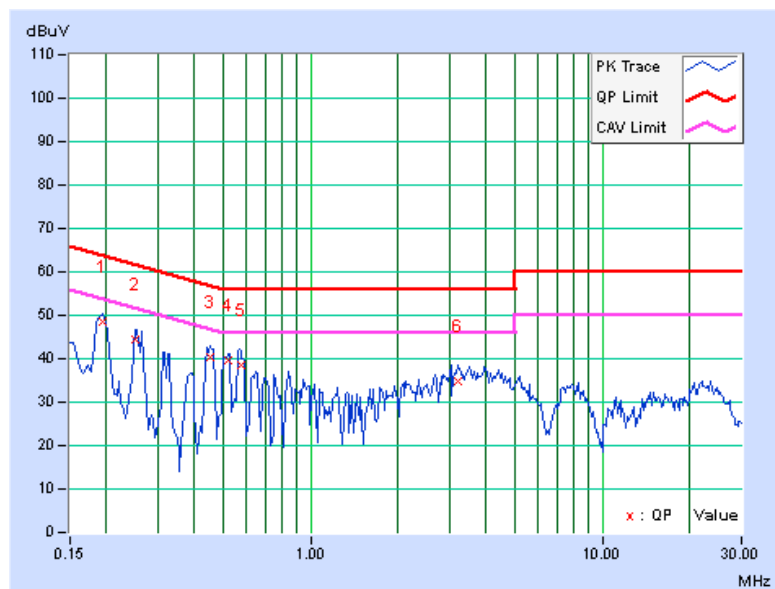



A D T

4.2 RADIATED EMISSION AND BANDEDGE MEASUREMENT

4.2.1 LIMITS OF RADIATED EMISSION AND BANDEDGE MEASUREMENT

Radiated emissions which fall in the restricted bands must comply with the radiated emission limits specified as below table. Other emissions shall be at least 20dB below the highest level of the desired power:

Frequencies (MHz)	Field strength (microvolts/meter)	Measurement distance (meters)
0.009-0.490	2400/F(kHz)	300
0.490-1.705	24000/F(kHz)	30
1.705-30.0	30	30
30-88	100	3
88-216	150	3
216-960	200	3
Above 960	500	3

NOTE:

1. The lower limit shall apply at the transition frequencies.
2. Emission level (dBuV/m) = 20 log Emission level (uV/m).
3. For frequencies above 1000MHz, the field strength limits are based on average detector, however, the peak field strength of any emission shall not exceed the maximum permitted average limits, specified above by more than 20dB under any condition of modulation.



A D T

4.2.2 TEST INSTRUMENTS

For Below 1GHz and Above 1GHz (WLAN mode):

DESCRIPTION & MANUFACTURER	MODEL NO.	SERIAL NO.	CALIBRATED DATE	CALIBRATED UNTIL
MXE EMI Receiver Agilent	N9038A	MY51210105	Jan. 21,2014	Jan. 20,2015
Pre-Amplifier Mini-Circuits	ZFL-1000VH2 B	AMP-ZFL-03	Nov. 13, 2013	Nov. 12, 2014
Trilog Broadband Antenna SCHWARZBECK	VULB 9168	9168-360	Feb. 26, 2014	Feb. 25, 2015
RF Cable	NA	CHGCAB_001	Oct. 05, 2013	Oct. 04, 2014
Spectrum Analyzer R&S	FSV40	100964	July 15, 2013	July 14, 2014
Horn_Antenna AISi	AIH.8018	0000320091110	Nov. 18, 2013	Nov. 17, 2014
Pre-Amplifier Agilent	8449B	3008A02578	June 25, 2013	June 24, 2014
RF Cable	NA	RF104-201 RF104-203 RF104-204	Dec. 12, 2013	Dec. 11, 2014
Spectrum Analyzer Agilent	E4446A	MY48250253	Aug. 28, 2013	Aug. 27, 2014
Pre-Amplifier SPACEK LABS	SLKka-48-6	9K16	Nov. 13, 2013	Nov. 12, 2014
Horn_Antenna SCHWARZBECK	BBHA 9170	9170-424	Oct. 08, 2013	Oct. 07, 2014
Software	ADT_Radiated _V8.7.07	NA	NA	NA
Antenna Tower & Turn Table CT	NA	NA	NA	NA

Note:

1. The calibration interval of the above test instruments is 12 months and the calibrations are traceable to NML/ROC and NIST/USA.
2. The horn antenna, preamplifier (model: 8449B) are used only for the measurement of emission frequency above 1GHz if tested.
3. The test was performed in 966 Chamber No. G.
4. The FCC Site Registration No. is 966073.
5. The VCCI Site Registration No. is G-137.
6. The CANADA Site Registration No. is IC 7450H-2.
7. Tested Date: May 16, 2014



A D T

For Above 1GHz (BT-LE mode):

DESCRIPTION & MANUFACTURER	MODEL NO.	SERIAL NO.	CALIBRATED DATE	CALIBRATED UNTIL
MXE EMI Receiver Agilent	N9038A	MY50010156	Jan. 15, 2014	Jan. 14, 2015
Pre-Amplifier Mini-Circuits	ZFL-1000VH2 B	AMP-ZFL-04	Nov. 13, 2013	Nov. 12, 2014
Trilog Broadband Antenna SCHWARZBECK	VULB 9168	9168-361	Feb. 27, 2014	Feb. 26, 2015
RF Cable	NA	CHHCAB_001	Oct. 06, 2013	Oct. 05, 2014
Spectrum Analyzer R&S	FSV40	100964	July 15, 2013	July 14, 2014
Horn_Antenna AISl	AIH.8018	0000220091110	Dec. 06, 2013	Dec. 05, 2014
Pre-Amplifier Agilent	8449B	3008A01923	Oct. 29, 2013	Oct. 28, 2014
RF Cable	NA	RF104-205 RF104-207 RF104-202	Dec. 12, 2013	Dec. 11, 2014
Spectrum Analyzer Agilent	E4446A	MY48250253	Aug. 28, 2013	Aug. 27, 2014
Pre-Amplifier SPACEK LABS	SLKKa-48-6	9K16	Nov. 13, 2013	Nov. 12, 2014
Horn_Antenna SCHWARZBECK	BBHA 9170	9170-424	Oct. 08, 2013	Oct. 07, 2014
Software	ADT_Radiated _V8.7.07	NA	NA	NA
Antenna Tower & Turn Table CT	NA	NA	NA	NA

Note:

1. The calibration interval of the above test instruments is 12 months and the calibrations are traceable to NML/ROC and NIST/USA.
2. The horn antenna, preamplifier (model: 8449B) are used only for the measurement of emission frequency above 1GHz if tested.
- 3 The test was performed in 966 Chamber No. H.
4. The FCC Site Registration No. is 797305.
- 5 The CANADA Site Registration No. is IC 7450H-3.
- 6 Tested Date: June 10, 2014

4.2.3 TEST PROCEDURES

- a. The EUT was placed on the top of a rotating table 0.8 meters above the ground at 3 meter chamber room for test. The table was rotated 360 degrees to determine the position of the highest radiation.
- b. The EUT was set 3 meters away from the interference-receiving antenna, which was mounted on the top of a variable-height antenna tower.
- c. The height of antenna is varied from one meter to four meters above the ground to determine the maximum value of the field strength. Both horizontal and vertical polarizations of the antenna are set to make the measurement.
- d. For each suspected emission, the EUT was arranged to its worst case and then the antenna was tuned to heights from 1 meter to 4 meters and the rotatable table was turned from 0 degrees to 360 degrees to find the maximum reading.
- e. The test-receiver system was set to quasi-peak detect function and specified bandwidth with maximum hold mode when the test frequency is below 1 GHz.
- f. The test-receiver system was set to peak and average detect function and specified bandwidth with maximum hold mode when the test frequency is above 1 GHz. If the peak reading value also meets average limit, measurement with the average detector is unnecessary.

For WLAN mode:

Note:

1. The resolution bandwidth and video bandwidth of test receiver/spectrum analyzer is 120kHz for Quasi-peak detection (QP) at frequency below 1GHz.
2. The resolution bandwidth of test receiver/spectrum analyzer is 1 MHz and the video bandwidth is 3 MHz for Peak detection (PK) at frequency above 1GHz.
3. The resolution bandwidth of test receiver/spectrum analyzer is 1MHz and the video bandwidth is 3MHz for RMS Average (Duty cycle < 98%) for Average detection (AV) at frequency above 1GHz, then the measurement results was added to a correction factor ($10 \log(1/\text{duty cycle})$).
4. The resolution bandwidth of test receiver/spectrum analyzer is 1MHz and the video bandwidth is 10Hz (Duty cycle $\geq 98\%$) for Average detection (AV) at frequency above 1GHz.
5. All modes of operation were investigated and the worst-case emissions are reported.

For BT-LE mode:

Note:

1. The resolution bandwidth and video bandwidth of test receiver/spectrum analyzer is 120kHz for Quasi-peak detection (QP) at frequency below 1GHz.
2. The resolution bandwidth of test receiver/spectrum analyzer is 1 MHz and the video bandwidth is 3 MHz for Peak detection (PK) at frequency above 1GHz.
3. The resolution bandwidth of test receiver/spectrum analyzer is 1MHz and the video bandwidth is $\geq 1/T$ (Duty cycle < 98%) or 10Hz (Duty cycle $\geq 98\%$) for Average detection (AV) at frequency above 1GHz.
4. All modes of operation were investigated and the worst-case emissions are reported.

4.2.4 DEVIATION FROM TEST STANDARD

No deviation

4.2.5 TEST SETUP

<Frequency Range below 1GHz>

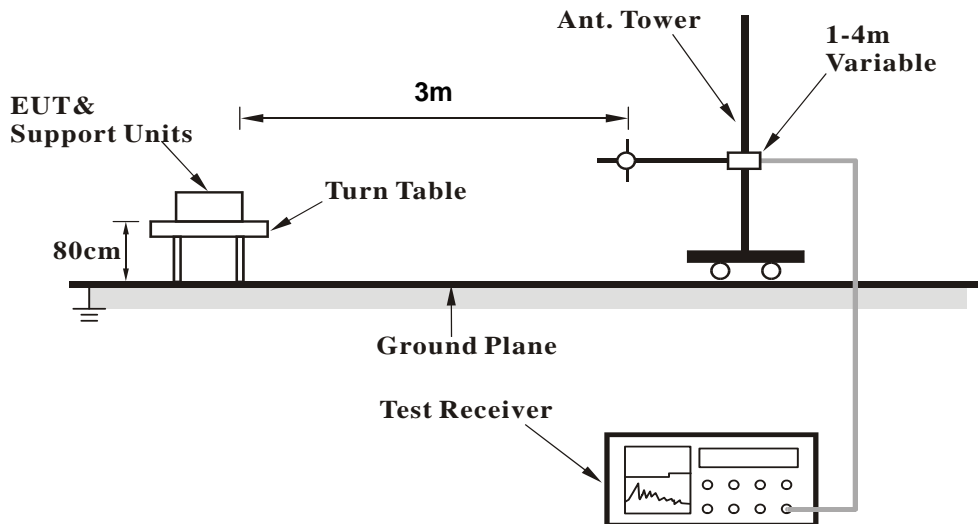

<Frequency Range above 1GHz>

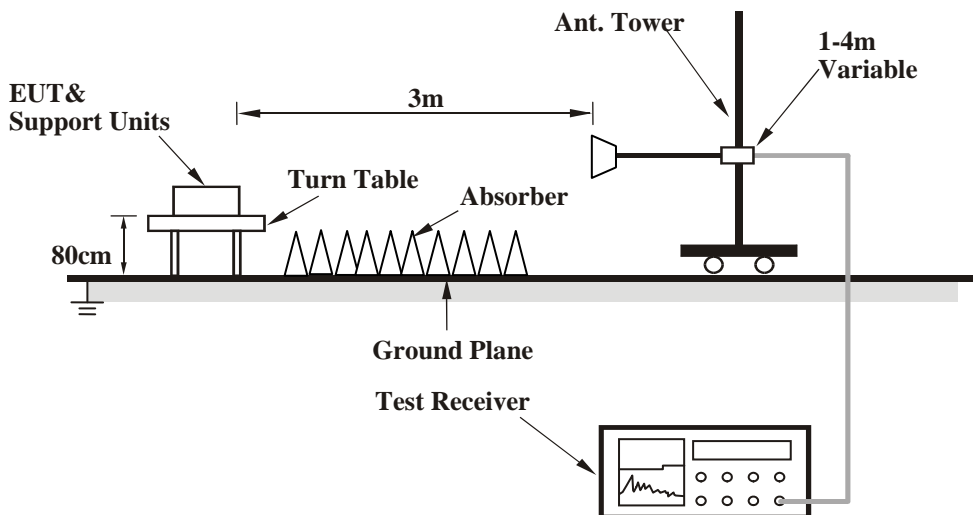

For the actual test configuration, please refer to the related item – Photographs of the Test Configuration.

4.2.6 EUT OPERATING CONDITIONS

Same as 4.1.6



A D T

4.2.7 TEST RESULTS (WLAN)

BELOW 1GHz WORST-CASE DATA

802.11g

CHANNEL	TX Channel 6	DETECTOR FUNCTION	Quasi-Peak (QP)
FREQUENCY RANGE	Below 1GHz		

ANTENNA POLARITY & TEST DISTANCE: HORIZONTAL AT 3 M								
NO.	FREQ. (MHz)	EMISSION LEVEL (dBuV/m)	LIMIT (dBuV/m)	MARGIN (dB)	ANTENNA HEIGHT (m)	TABLE ANGLE (Degree)	RAW VALUE (dBuV)	CORRECTION FACTOR (dB/m)
1	47.99	35.6 QP	40.0	-4.4	1.00 H	277	49.02	-13.46
2	72.00	33.6 QP	40.0	-6.4	1.00 H	247	49.63	-16.06
3	311.98	42.4 QP	46.0	-3.6	1.00 H	101	54.38	-11.98
4	359.99	38.4 QP	46.0	-7.6	1.00 H	126	49.19	-10.80
5	528.00	36.1 QP	46.0	-10.0	1.00 H	309	42.85	-6.80
6	935.98	40.0 QP	46.0	-6.0	1.00 H	110	39.18	0.86

ANTENNA POLARITY & TEST DISTANCE: VERTICAL AT 3 M								
NO.	FREQ. (MHz)	EMISSION LEVEL (dBuV/m)	LIMIT (dBuV/m)	MARGIN (dB)	ANTENNA HEIGHT (m)	TABLE ANGLE (Degree)	RAW VALUE (dBuV)	CORRECTION FACTOR (dB/m)
1	60.56	35.0 QP	40.0	-5.0	1.00 V	219	49.22	-14.19
2	312.03	37.8 QP	46.0	-8.2	1.00 V	302	49.80	-11.98
3	432.02	41.7 QP	46.0	-4.3	1.21 V	197	50.28	-8.61
4	527.99	39.3 QP	46.0	-6.7	1.14 V	165	46.14	-6.80
5	647.99	36.2 QP	46.0	-9.8	1.00 V	37	40.29	-4.09
6	935.99	42.9 QP	46.0	-3.2	1.07 V	221	41.99	0.86

REMARKS:

1. Emission Level(dBuV/m) = Raw Value(dBuV) + Correction Factor(dB/m)
2. Correction Factor(dB/m) = Antenna Factor(dB/m) + Cable Factor(dB) – Pre-Amplifier Factor(dB)
3. The other emission levels were very low against the limit.
4. Margin value = Emission Level – Limit value



A D T

ABOVE 1GHz DATA

802.11b

CHANNEL	TX Channel 1	DETECTOR FUNCTION	Peak (PK)
FREQUENCY RANGE	1GHz ~ 25GHz		Average (AV)

ANTENNA POLARITY & TEST DISTANCE: HORIZONTAL AT 3 M								
NO.	FREQ. (MHz)	EMISSION LEVEL (dBuV/m)	LIMIT (dBuV/m)	MARGIN (dB)	ANTENNA HEIGHT (m)	TABLE ANGLE (Degree)	RAW VALUE (dBuV)	CORRECTION FACTOR (dB/m)
1	2390.00	47.0 PK	74.0	-27.0	1.04 H	156	48.70	-1.70
2	2390.00	37.2 AV	54.0	-16.8	1.04 H	156	38.90	-1.70
3	*2412.00	104.2 PK			1.04 H	156	105.80	-1.60
4	*2412.00	101.2 AV			1.04 H	156	102.80	-1.60
5	4824.00	56.4 PK	74.0	-17.6	1.59 H	190	49.20	7.20
6	4824.00	53.9 AV	54.0	-0.1	1.59 H	190	46.70	7.20
ANTENNA POLARITY & TEST DISTANCE: VERTICAL AT 3 M								
NO.	FREQ. (MHz)	EMISSION LEVEL (dBuV/m)	LIMIT (dBuV/m)	MARGIN (dB)	ANTENNA HEIGHT (m)	TABLE ANGLE (Degree)	RAW VALUE (dBuV)	CORRECTION FACTOR (dB/m)
1	2390.00	47.7 PK	74.0	-26.3	1.00 V	45	49.40	-1.70
2	2390.00	36.9 AV	54.0	-17.1	1.00 V	45	38.60	-1.70
3	*2412.00	103.9 PK			1.00 V	45	105.50	-1.60
4	*2412.00	100.6 AV			1.00 V	45	102.20	-1.60
5	4824.00	54.6 PK	74.0	-19.4	1.30 V	262	47.40	7.20
6	4824.00	48.7 AV	54.0	-5.3	1.30 V	262	41.50	7.20

REMARKS:

1. Emission Level(dBuV/m) = Raw Value(dBuV) + Correction Factor(dB/m)
2. Correction Factor(dB/m) = Antenna Factor(dB/m) + Cable Factor(dB) – Pre-Amplifier Factor(dB)
3. The other emission levels were very low against the limit.
4. Margin value = Emission Level – Limit value
5. " * ": Fundamental frequency.



A D T

CHANNEL	TX Channel 6	DETECTOR FUNCTION	Peak (PK)
FREQUENCY RANGE	1GHz ~ 25GHz		Average (AV)

ANTENNA POLARITY & TEST DISTANCE: HORIZONTAL AT 3 M

NO.	FREQ. (MHz)	EMISSION LEVEL (dBuV/m)	LIMIT (dBuV/m)	MARGIN (dB)	ANTENNA HEIGHT (m)	TABLE ANGLE (Degree)	RAW VALUE (dBuV)	CORRECTION FACTOR (dB/m)
1	*2437.00	104.6 PK			1.30 H	115	106.09	-1.49
2	*2437.00	101.5 AV			1.30 H	115	102.99	-1.49
3	4874.00	56.5 PK	74.0	-17.5	1.64 H	190	49.17	7.33
4	4874.00	53.5 AV	54.0	-0.5	1.64 H	190	46.17	7.33
5	7311.00	50.5 PK	74.0	-23.5	1.05 H	154	35.54	14.96
6	7311.00	41.6 AV	54.0	-12.4	1.05 H	154	26.64	14.96

ANTENNA POLARITY & TEST DISTANCE: VERTICAL AT 3 M

NO.	FREQ. (MHz)	EMISSION LEVEL (dBuV/m)	LIMIT (dBuV/m)	MARGIN (dB)	ANTENNA HEIGHT (m)	TABLE ANGLE (Degree)	RAW VALUE (dBuV)	CORRECTION FACTOR (dB/m)
1	*2437.00	104.1 PK			1.00 V	50	105.59	-1.49
2	*2437.00	100.7 AV			1.00 V	50	102.19	-1.49
3	4874.00	51.5 PK	74.0	-22.5	1.10 V	258	44.17	7.33
4	4874.00	46.8 AV	54.0	-7.2	1.10 V	258	39.47	7.33
5	7311.00	53.6 PK	74.0	-20.4	1.04 V	210	38.64	14.96
6	7311.00	39.6 AV	54.0	-14.4	1.04 V	210	24.64	14.96

REMARKS:

1. Emission Level(dBuV/m) = Raw Value(dBuV) + Correction Factor(dB/m)
2. Correction Factor(dB/m) = Antenna Factor(dB/m) + Cable Factor(dB) – Pre-Amplifier Factor(dB)
3. The other emission levels were very low against the limit.
4. Margin value = Emission Level – Limit value
5. " * ": Fundamental frequency.



A D T

CHANNEL	TX Channel 11	DETECTOR FUNCTION	Peak (PK)
FREQUENCY RANGE	1GHz ~ 25GHz		Average (AV)

ANTENNA POLARITY & TEST DISTANCE: HORIZONTAL AT 3 M

NO.	FREQ. (MHz)	EMISSION LEVEL (dBuV/m)	LIMIT (dBuV/m)	MARGIN (dB)	ANTENNA HEIGHT (m)	TABLE ANGLE (Degree)	RAW VALUE (dBuV)	CORRECTION FACTOR (dB/m)
1	*2462.00	104.9 PK			1.04 H	155	106.28	-1.38
2	*2462.00	101.7 AV			1.04 H	155	103.08	-1.38
3	2483.50	50.7 PK	74.0	-23.3	1.04 H	155	51.98	-1.28
4	2483.50	41.8 AV	54.0	-12.2	1.04 H	155	43.08	-1.28
5	4924.00	56.1 PK	74.0	-17.9	1.62 H	192	48.63	7.47
6	4924.00	53.0 AV	54.0	-1.0	1.62 H	192	45.53	7.47
7	7386.00	53.4 PK	74.0	-20.6	1.00 H	115	38.51	14.89
8	7386.00	39.5 AV	54.0	-14.5	1.00 H	115	24.61	14.89

ANTENNA POLARITY & TEST DISTANCE: VERTICAL AT 3 M

NO.	FREQ. (MHz)	EMISSION LEVEL (dBuV/m)	LIMIT (dBuV/m)	MARGIN (dB)	ANTENNA HEIGHT (m)	TABLE ANGLE (Degree)	RAW VALUE (dBuV)	CORRECTION FACTOR (dB/m)
1	*2462.00	104.7 PK			1.00 V	41	106.08	-1.38
2	*2462.00	100.8 AV			1.00 V	41	102.18	-1.38
3	2483.50	49.3 PK	74.0	-24.7	1.00 V	41	50.58	-1.28
4	2483.50	39.7 AV	54.0	-14.3	1.00 V	41	40.98	-1.28
5	4924.00	55.5 PK	74.0	-18.5	1.42 V	276	48.03	7.47
6	4924.00	52.1 AV	54.0	-1.9	1.42 V	276	44.63	7.47
7	7386.00	53.3 PK	74.0	-20.7	1.00 V	216	38.41	14.89
8	7386.00	39.4 AV	54.0	-14.6	1.00 V	216	24.51	14.89

REMARKS:

1. Emission Level(dBuV/m) = Raw Value(dBuV) + Correction Factor(dB/m)
2. Correction Factor(dB/m) = Antenna Factor(dB/m) + Cable Factor(dB) – Pre-Amplifier Factor(dB)
3. The other emission levels were very low against the limit.
4. Margin value = Emission Level – Limit value
5. " * ": Fundamental frequency.



A D T

802.11g

CHANNEL	TX Channel 1	DETECTOR FUNCTION	Peak (PK)
FREQUENCY RANGE	1GHz ~ 25GHz		Average (AV)

ANTENNA POLARITY & TEST DISTANCE: HORIZONTAL AT 3 M

NO.	FREQ. (MHz)	EMISSION LEVEL (dBuV/m)	LIMIT (dBuV/m)	MARGIN (dB)	ANTENNA HEIGHT (m)	TABLE ANGLE (Degree)	RAW VALUE (dBuV)	CORRECTION FACTOR (dB/m)
1	2390.00	72.2 PK	74.0	-1.8	1.09 H	31	73.90	-1.70
2	2390.00	51.5 AV	54.0	-2.5	1.09 H	31	53.20	-1.70
3	*2412.00	108.5 PK			1.09 H	31	110.10	-1.60
4	*2412.00	98.9 AV			1.09 H	31	100.50	-1.60
5	4824.00	50.0 PK	74.0	-24.0	1.14 H	126	42.80	7.20
6	4824.00	37.1 AV	54.0	-16.9	1.14 H	126	29.90	7.20

ANTENNA POLARITY & TEST DISTANCE: VERTICAL AT 3 M

NO.	FREQ. (MHz)	EMISSION LEVEL (dBuV/m)	LIMIT (dBuV/m)	MARGIN (dB)	ANTENNA HEIGHT (m)	TABLE ANGLE (Degree)	RAW VALUE (dBuV)	CORRECTION FACTOR (dB/m)
1	2390.00	72.1 PK	74.0	-1.9	1.13 V	96	73.80	-1.70
2	2390.00	52.3 AV	54.0	-1.7	1.13 V	96	54.00	-1.70
3	*2412.00	108.6 PK			1.13 V	96	110.20	-1.60
4	*2412.00	98.2 AV			1.13 V	96	99.80	-1.60
5	4824.00	49.8 PK	74.0	-24.2	1.00 V	176	42.60	7.20
6	4824.00	37.0 AV	54.0	-17.0	1.00 V	176	29.80	7.20

REMARKS:

1. Emission Level(dBuV/m) = Raw Value(dBuV) + Correction Factor(dB/m)
2. Correction Factor(dB/m) = Antenna Factor(dB/m) + Cable Factor(dB) – Pre-Amplifier Factor(dB)
3. The other emission levels were very low against the limit.
4. Margin value = Emission Level – Limit value
5. " * ": Fundamental frequency.



A D T

CHANNEL	TX Channel 6	DETECTOR FUNCTION	Peak (PK)
FREQUENCY RANGE	1GHz ~ 25GHz		Average (AV)

ANTENNA POLARITY & TEST DISTANCE: HORIZONTAL AT 3 M

NO.	FREQ. (MHz)	EMISSION LEVEL (dBuV/m)	LIMIT (dBuV/m)	MARGIN (dB)	ANTENNA HEIGHT (m)	TABLE ANGLE (Degree)	RAW VALUE (dBuV)	CORRECTION FACTOR (dB/m)
1	*2437.00	110.8 PK			1.29 H	117	112.29	-1.49
2	*2437.00	101.5 AV			1.29 H	117	102.99	-1.49
3	2483.50	71.2 PK	74.0	-2.8	1.29 H	117	72.48	-1.28
4	2483.50	45.2 AV	54.0	-8.8	1.29 H	117	46.48	-1.28
5	4874.00	49.5 PK	74.0	-24.5	1.14 H	104	42.17	7.33
6	4874.00	37.0 AV	54.0	-17.0	1.14 H	104	29.67	7.33
7	7311.00	54.7 PK	74.0	-19.3	1.00 H	220	39.74	14.96
8	7311.00	41.9 AV	54.0	-12.1	1.00 H	220	26.94	14.96

ANTENNA POLARITY & TEST DISTANCE: VERTICAL AT 3 M

NO.	FREQ. (MHz)	EMISSION LEVEL (dBuV/m)	LIMIT (dBuV/m)	MARGIN (dB)	ANTENNA HEIGHT (m)	TABLE ANGLE (Degree)	RAW VALUE (dBuV)	CORRECTION FACTOR (dB/m)
1	*2437.00	109.9 PK			1.00 V	316	111.39	-1.49
2	*2437.00	100.7 AV			1.00 V	316	102.19	-1.49
3	2483.50	66.7 PK	74.0	-7.3	1.00 V	316	67.98	-1.28
4	2483.50	41.3 AV	54.0	-12.7	1.00 V	316	42.58	-1.28
5	4874.00	50.1 PK	74.0	-23.9	1.00 V	175	42.77	7.33
6	4874.00	36.9 AV	54.0	-17.1	1.00 V	175	29.57	7.33
7	7311.00	53.6 PK	74.0	-20.4	1.01 V	223	38.64	14.96
8	7311.00	39.5 AV	54.0	-14.5	1.01 V	223	24.54	14.96

REMARKS:

1. Emission Level(dBuV/m) = Raw Value(dBuV) + Correction Factor(dB/m)
2. Correction Factor(dB/m) = Antenna Factor(dB/m) + Cable Factor(dB) – Pre-Amplifier Factor(dB)
3. The other emission levels were very low against the limit.
4. Margin value = Emission Level – Limit value
5. " * ": Fundamental frequency.



A D T

CHANNEL	TX Channel 11	DETECTOR FUNCTION	Peak (PK)
FREQUENCY RANGE	1GHz ~ 25GHz		Average (AV)

ANTENNA POLARITY & TEST DISTANCE: HORIZONTAL AT 3 M

NO.	FREQ. (MHz)	EMISSION LEVEL (dBuV/m)	LIMIT (dBuV/m)	MARGIN (dB)	ANTENNA HEIGHT (m)	TABLE ANGLE (Degree)	RAW VALUE (dBuV)	CORRECTION FACTOR (dB/m)
1	*2462.00	108.4 PK			1.05 H	35	109.78	-1.38
2	*2462.00	99.0 AV			1.05 H	35	100.38	-1.38
3	2483.50	72.1 PK	74.0	-1.9	1.06 H	35	73.38	-1.28
4	2483.50	51.8 AV	54.0	-2.2	1.06 H	35	53.08	-1.28
5	4924.00	49.1 PK	74.0	-24.9	1.10 H	120	41.63	7.47
6	4924.00	36.7 AV	54.0	-17.3	1.10 H	120	29.23	7.47
7	7386.00	54.4 PK	74.0	-19.6	1.05 H	224	39.51	14.89
8	7386.00	41.7 AV	54.0	-12.3	1.05 H	224	26.81	14.89

ANTENNA POLARITY & TEST DISTANCE: VERTICAL AT 3 M

NO.	FREQ. (MHz)	EMISSION LEVEL (dBuV/m)	LIMIT (dBuV/m)	MARGIN (dB)	ANTENNA HEIGHT (m)	TABLE ANGLE (Degree)	RAW VALUE (dBuV)	CORRECTION FACTOR (dB/m)
1	*2462.00	107.6 PK			1.27 V	21	108.98	-1.38
2	*2462.00	98.1 AV			1.27 V	21	99.48	-1.38
3	2483.50	64.0 PK	74.0	-10.0	1.27 V	21	65.28	-1.28
4	2483.50	47.2 AV	54.0	-6.8	1.27 V	21	48.48	-1.28
5	4924.00	50.2 PK	74.0	-23.8	1.00 V	175	42.73	7.47
6	4924.00	37.5 AV	54.0	-16.5	1.00 V	175	30.03	7.47
7	7386.00	53.3 PK	74.0	-20.7	1.01 V	197	38.41	14.89
8	7386.00	39.2 AV	54.0	-14.8	1.01 V	197	24.31	14.89

REMARKS:

1. Emission Level(dBuV/m) = Raw Value(dBuV) + Correction Factor(dB/m)
2. Correction Factor(dB/m) = Antenna Factor(dB/m) + Cable Factor(dB) – Pre-Amplifier Factor(dB)
3. The other emission levels were very low against the limit.
4. Margin value = Emission Level – Limit value
5. " * ": Fundamental frequency.



A D T

802.11n (HT20)

CHANNEL	TX Channel 1	DETECTOR FUNCTION	Peak (PK)
FREQUENCY RANGE	1GHz ~ 25GHz		Average (AV)

ANTENNA POLARITY & TEST DISTANCE: HORIZONTAL AT 3 M

NO.	FREQ. (MHz)	EMISSION LEVEL (dBuV/m)	LIMIT (dBuV/m)	MARGIN (dB)	ANTENNA HEIGHT (m)	TABLE ANGLE (Degree)	RAW VALUE (dBuV)	CORRECTION FACTOR (dB/m)
1	2390.00	73.4 PK	74.0	-0.6	1.10 H	33	75.10	-1.70
2	2390.00	53.0 AV	54.0	-1.0	1.10 H	33	54.70	-1.70
3	*2412.00	108.9 PK			1.10 H	33	110.50	-1.60
4	*2412.00	97.4 AV			1.10 H	33	99.00	-1.60
5	4824.00	49.3 PK	74.0	-24.7	1.13 H	116	42.10	7.20
6	4824.00	36.9 AV	54.0	-17.1	1.13 H	116	29.70	7.20

ANTENNA POLARITY & TEST DISTANCE: VERTICAL AT 3 M

NO.	FREQ. (MHz)	EMISSION LEVEL (dBuV/m)	LIMIT (dBuV/m)	MARGIN (dB)	ANTENNA HEIGHT (m)	TABLE ANGLE (Degree)	RAW VALUE (dBuV)	CORRECTION FACTOR (dB/m)
1	2390.00	63.4 PK	74.0	-10.6	1.01 V	84	65.10	-1.70
2	2390.00	47.4 AV	54.0	-6.6	1.01 V	84	49.10	-1.70
3	*2412.00	107.6 PK			1.01 V	84	109.20	-1.60
4	*2412.00	96.3 AV			1.01 V	84	97.90	-1.60
5	4824.00	50.0 PK	74.0	-24.0	1.00 V	150	42.80	7.20
6	4824.00	36.9 AV	54.0	-17.1	1.00 V	150	29.70	7.20

REMARKS:

1. Emission Level(dBuV/m) = Raw Value(dBuV) + Correction Factor(dB/m)
2. Correction Factor(dB/m) = Antenna Factor(dB/m) + Cable Factor(dB) – Pre-Amplifier Factor(dB)
3. The other emission levels were very low against the limit.
4. Margin value = Emission Level – Limit value
5. " * ": Fundamental frequency.



A D T

CHANNEL	TX Channel 6	DETECTOR FUNCTION	Peak (PK)
FREQUENCY RANGE	1GHz ~ 25GHz		Average (AV)

ANTENNA POLARITY & TEST DISTANCE: HORIZONTAL AT 3 M

NO.	FREQ. (MHz)	EMISSION LEVEL (dBuV/m)	LIMIT (dBuV/m)	MARGIN (dB)	ANTENNA HEIGHT (m)	TABLE ANGLE (Degree)	RAW VALUE (dBuV)	CORRECTION FACTOR (dB/m)
1	2390.00	66.1 PK	74.0	-7.9	1.38 H	162	67.80	-1.70
2	2390.00	44.6 AV	54.0	-9.4	1.38 H	162	46.30	-1.70
3	*2437.00	110.5 PK			1.38 H	162	111.99	-1.49
4	*2437.00	100.1 AV			1.38 H	162	101.59	-1.49
5	2483.50	66.8 PK	74.0	-7.2	1.38 H	162	68.08	-1.28
6	2483.50	42.9 AV	54.0	-11.1	1.38 H	162	44.18	-1.28
7	4874.00	50.2 PK	74.0	-23.8	1.11 H	131	42.87	7.33
8	4874.00	37.4 AV	54.0	-16.6	1.11 H	131	30.07	7.33
9	7311.00	54.5 PK	74.0	-19.5	1.00 H	247	39.54	14.96
10	7311.00	42.0 AV	54.0	-12.0	1.00 H	247	27.04	14.96

ANTENNA POLARITY & TEST DISTANCE: VERTICAL AT 3 M

NO.	FREQ. (MHz)	EMISSION LEVEL (dBuV/m)	LIMIT (dBuV/m)	MARGIN (dB)	ANTENNA HEIGHT (m)	TABLE ANGLE (Degree)	RAW VALUE (dBuV)	CORRECTION FACTOR (dB/m)
1	2390.00	65.6 PK	74.0	-8.4	1.01 V	88	67.30	-1.70
2	2390.00	43.5 AV	54.0	-10.5	1.01 V	88	45.20	-1.70
3	*2437.00	109.4 PK			1.01 V	88	110.89	-1.49
4	*2437.00	98.9 AV			1.01 V	88	100.39	-1.49
5	2483.50	66.1 PK	74.0	-7.9	1.01 V	88	67.38	-1.28
6	2483.50	42.4 AV	54.0	-11.6	1.01 V	88	43.68	-1.28
7	4874.00	49.8 PK	74.0	-24.2	1.00 V	170	42.47	7.33
8	4874.00	37.1 AV	54.0	-16.9	1.00 V	170	29.77	7.33
9	7311.00	53.4 PK	74.0	-20.6	1.08 V	203	38.44	14.96
10	7311.00	39.2 AV	54.0	-14.8	1.08 V	203	24.24	14.96

REMARKS:

1. Emission Level(dBuV/m) = Raw Value(dBuV) + Correction Factor(dB/m)
2. Correction Factor(dB/m) = Antenna Factor(dB/m) + Cable Factor(dB) – Pre-Amplifier Factor(dB)
3. The other emission levels were very low against the limit.
4. Margin value = Emission Level – Limit value
5. " * ": Fundamental frequency.



A D T

CHANNEL	TX Channel 11	DETECTOR FUNCTION	Peak (PK)
FREQUENCY RANGE	1GHz ~ 25GHz		Average (AV)

ANTENNA POLARITY & TEST DISTANCE: HORIZONTAL AT 3 M

NO.	FREQ. (MHz)	EMISSION LEVEL (dBuV/m)	LIMIT (dBuV/m)	MARGIN (dB)	ANTENNA HEIGHT (m)	TABLE ANGLE (Degree)	RAW VALUE (dBuV)	CORRECTION FACTOR (dB/m)
1	*2462.00	109.4 PK			1.05 H	32	110.78	-1.38
2	*2462.00	97.7 AV			1.05 H	32	99.08	-1.38
3	2483.50	71.1 PK	74.0	-2.9	1.05 H	32	72.38	-1.28
4	2483.50	51.1 AV	54.0	-2.9	1.05 H	32	52.38	-1.28
5	4924.00	49.9 PK	74.0	-24.1	1.13 H	123	42.43	7.47
6	4924.00	37.3 AV	54.0	-16.7	1.13 H	123	29.83	7.47
7	7386.00	54.6 PK	74.0	-19.4	1.00 H	222	39.71	14.89
8	7386.00	41.8 AV	54.0	-12.2	1.00 H	222	26.91	14.89

ANTENNA POLARITY & TEST DISTANCE: VERTICAL AT 3 M

NO.	FREQ. (MHz)	EMISSION LEVEL (dBuV/m)	LIMIT (dBuV/m)	MARGIN (dB)	ANTENNA HEIGHT (m)	TABLE ANGLE (Degree)	RAW VALUE (dBuV)	CORRECTION FACTOR (dB/m)
1	*2462.00	107.8 PK			1.00 V	39	109.18	-1.38
2	*2462.00	96.4 AV			1.00 V	39	97.78	-1.38
3	2483.50	69.5 PK	74.0	-4.5	1.00 V	39	70.78	-1.28
4	2483.50	47.8 AV	54.0	-6.2	1.00 V	39	49.08	-1.28
5	4924.00	50.5 PK	74.0	-23.5	1.05 V	148	43.03	7.47
6	4924.00	37.5 AV	54.0	-16.5	1.05 V	148	30.03	7.47
7	7386.00	53.4 PK	74.0	-20.6	1.08 V	213	38.51	14.89
8	7386.00	39.3 AV	54.0	-14.7	1.08 V	213	24.41	14.89

REMARKS:

1. Emission Level(dBuV/m) = Raw Value(dBuV) + Correction Factor(dB/m)
2. Correction Factor(dB/m) = Antenna Factor(dB/m) + Cable Factor(dB) – Pre-Amplifier Factor(dB)
3. The other emission levels were very low against the limit.
4. Margin value = Emission Level – Limit value
5. " * ": Fundamental frequency.



A D T

802.11n (HT40)

CHANNEL	TX Channel 3	DETECTOR FUNCTION	Peak (PK)
FREQUENCY RANGE	1GHz ~ 25GHz		Average (AV)

ANTENNA POLARITY & TEST DISTANCE: HORIZONTAL AT 3 M

NO.	FREQ. (MHz)	EMISSION LEVEL (dBuV/m)	LIMIT (dBuV/m)	MARGIN (dB)	ANTENNA HEIGHT (m)	TABLE ANGLE (Degree)	RAW VALUE (dBuV)	CORRECTION FACTOR (dB/m)
1	2390.00	70.1 PK	74.0	-3.9	1.08 H	32	71.80	-1.70
2	2390.00	52.5 AV	54.0	-1.5	1.08 H	32	54.20	-1.70
3	*2422.00	103.8 PK			1.08 H	32	105.35	-1.55
4	*2422.00	92.6 AV			1.08 H	32	94.15	-1.55
5	4844.00	49.3 PK	74.0	-24.7	1.09 H	102	42.06	7.24
6	4844.00	36.5 AV	54.0	-17.5	1.09 H	102	29.26	7.24
7	7266.00	54.5 PK	74.0	-19.5	1.00 H	224	39.48	15.02
8	7266.00	41.9 AV	54.0	-12.1	1.00 H	224	26.88	15.02

ANTENNA POLARITY & TEST DISTANCE: VERTICAL AT 3 M

NO.	FREQ. (MHz)	EMISSION LEVEL (dBuV/m)	LIMIT (dBuV/m)	MARGIN (dB)	ANTENNA HEIGHT (m)	TABLE ANGLE (Degree)	RAW VALUE (dBuV)	CORRECTION FACTOR (dB/m)
1	2390.00	63.8 PK	74.0	-10.2	1.00 V	96	65.50	-1.70
2	2390.00	47.6 AV	54.0	-6.4	1.00 V	96	49.30	-1.70
3	*2422.00	102.7 PK			1.00 V	40	104.25	-1.55
4	*2422.00	91.8 AV			1.00 V	40	93.35	-1.55
5	4844.00	50.1 PK	74.0	-23.9	1.00 V	157	42.86	7.24
6	4844.00	37.5 AV	54.0	-16.5	1.00 V	157	30.26	7.24
7	7266.00	53.4 PK	74.0	-20.6	1.00 V	220	38.38	15.02
8	7266.00	39.3 AV	54.0	-14.7	1.00 V	220	24.28	15.02

REMARKS:

1. Emission Level(dBuV/m) = Raw Value(dBuV) + Correction Factor(dB/m)
2. Correction Factor(dB/m) = Antenna Factor(dB/m) + Cable Factor(dB) – Pre-Amplifier Factor(dB)
3. The other emission levels were very low against the limit.
4. Margin value = Emission Level – Limit value
5. " * ": Fundamental frequency.



A D T

CHANNEL	TX Channel 6	DETECTOR FUNCTION	Peak (PK)
FREQUENCY RANGE	1GHz ~ 25GHz		Average (AV)

ANTENNA POLARITY & TEST DISTANCE: HORIZONTAL AT 3 M

NO.	FREQ. (MHz)	EMISSION LEVEL (dBuV/m)	LIMIT (dBuV/m)	MARGIN (dB)	ANTENNA HEIGHT (m)	TABLE ANGLE (Degree)	RAW VALUE (dBuV)	CORRECTION FACTOR (dB/m)
1	2390.00	73.7 PK	74.0	-0.3	1.09 H	33	75.40	-1.70
2	2390.00	53.4 AV	54.0	-0.6	1.09 H	33	55.10	-1.70
3	*2437.00	106.5 PK			1.09 H	33	107.99	-1.49
4	*2437.00	95.4 AV			1.09 H	33	96.89	-1.49
5	4874.00	49.4 PK	74.0	-24.6	1.05 H	111	42.07	7.33
6	4874.00	37.1 AV	54.0	-16.9	1.05 H	111	29.77	7.33
7	7311.00	54.5 PK	74.0	-19.5	1.00 H	248	39.54	14.96
8	7311.00	41.9 AV	54.0	-12.1	1.00 H	248	26.94	14.96

ANTENNA POLARITY & TEST DISTANCE: VERTICAL AT 3 M

NO.	FREQ. (MHz)	EMISSION LEVEL (dBuV/m)	LIMIT (dBuV/m)	MARGIN (dB)	ANTENNA HEIGHT (m)	TABLE ANGLE (Degree)	RAW VALUE (dBuV)	CORRECTION FACTOR (dB/m)
1	2390.00	69.4 PK	74.0	-4.6	1.00 V	84	71.10	-1.70
2	2390.00	49.7 AV	54.0	-4.3	1.00 V	84	51.40	-1.70
3	*2437.00	105.1 PK			1.00 V	84	106.59	-1.49
4	*2437.00	94.2 AV			1.00 V	84	95.69	-1.49
5	4874.00	50.4 PK	74.0	-23.6	1.00 V	155	43.07	7.33
6	4874.00	37.6 AV	54.0	-16.4	1.00 V	155	30.27	7.33
7	7311.00	54.0 PK	74.0	-20.0	1.02 V	195	39.04	14.96
8	7311.00	40.0 AV	54.0	-14.0	1.02 V	195	25.04	14.96

REMARKS:

1. Emission Level(dBuV/m) = Raw Value(dBuV) + Correction Factor(dB/m)
2. Correction Factor(dB/m) = Antenna Factor(dB/m) + Cable Factor(dB) – Pre-Amplifier Factor(dB)
3. The other emission levels were very low against the limit.
4. Margin value = Emission Level – Limit value
5. " * ": Fundamental frequency.



A D T

CHANNEL	TX Channel 9	DETECTOR FUNCTION	Peak (PK)
FREQUENCY RANGE	1GHz ~ 25GHz		Average (AV)

ANTENNA POLARITY & TEST DISTANCE: HORIZONTAL AT 3 M

NO.	FREQ. (MHz)	EMISSION LEVEL (dBuV/m)	LIMIT (dBuV/m)	MARGIN (dB)	ANTENNA HEIGHT (m)	TABLE ANGLE (Degree)	RAW VALUE (dBuV)	CORRECTION FACTOR (dB/m)
1	*2452.00	105.2 PK			1.07 H	34	106.62	-1.42
2	*2452.00	93.9 AV			1.07 H	34	95.32	-1.42
3	2483.50	71.5 PK	74.0	-2.5	1.07 H	34	72.78	-1.28
4	2483.50	53.9 AV	54.0	-0.1	1.07 H	34	55.18	-1.28
5	4904.00	49.7 PK	74.0	-24.3	1.08 H	129	42.29	7.41
6	4904.00	37.2 AV	54.0	-16.8	1.08 H	129	29.79	7.41
7	7356.00	54.7 PK	74.0	-19.3	1.02 H	235	39.79	14.91
8	7356.00	42.1 AV	54.0	-11.9	1.02 H	235	27.19	14.91

ANTENNA POLARITY & TEST DISTANCE: VERTICAL AT 3 M

NO.	FREQ. (MHz)	EMISSION LEVEL (dBuV/m)	LIMIT (dBuV/m)	MARGIN (dB)	ANTENNA HEIGHT (m)	TABLE ANGLE (Degree)	RAW VALUE (dBuV)	CORRECTION FACTOR (dB/m)
1	*2452.00	104.7 PK			1.00 V	40	106.12	-1.42
2	*2452.00	92.8 AV			1.00 V	40	94.22	-1.42
3	2483.50	63.3 PK	74.0	-10.7	1.00 V	94	64.58	-1.28
4	2483.50	47.1 AV	54.0	-6.9	1.00 V	94	48.38	-1.28
5	4904.00	50.1 PK	74.0	-23.9	1.01 V	168	42.69	7.41
6	4904.00	37.1 AV	54.0	-16.9	1.01 V	168	29.69	7.41
7	7356.00	54.2 PK	74.0	-19.8	1.00 V	208	39.29	14.91
8	7356.00	40.1 AV	54.0	-13.9	1.00 V	208	25.19	14.91

REMARKS:

1. Emission Level(dBuV/m) = Raw Value(dBuV) + Correction Factor(dB/m)
2. Correction Factor(dB/m) = Antenna Factor(dB/m) + Cable Factor(dB) – Pre-Amplifier Factor(dB)
3. The other emission levels were very low against the limit.
4. Margin value = Emission Level – Limit value
5. " * ": Fundamental frequency.



A D T

4.2.8 TEST RESULTS (BT<LE>)

BELOW 1GHz WORST-CASE DATA

BT_LE-GFSK

CHANNEL	TX Channel 0	DETECTOR FUNCTION	Quasi-Peak (QP)
FREQUENCY RANGE	30MHz ~ 1GHz		

ANTENNA POLARITY & TEST DISTANCE: HORIZONTAL AT 3 M

NO.	FREQ. (MHz)	EMISSION LEVEL (dBuV/m)	LIMIT (dBuV/m)	MARGIN (dB)	ANTENNA HEIGHT (m)	TABLE ANGLE (Degree)	RAW VALUE (dBuV)	CORRECTION FACTOR (dB/m)
1	47.84	35.0 QP	40.0	-5.0	1.24 H	156	48.50	-13.49
2	72.12	33.3 QP	40.0	-6.7	1.77 H	164	49.43	-16.09
3	311.95	42.3 QP	46.0	-3.7	1.16 H	167	54.29	-11.98
4	359.98	38.4 QP	46.0	-7.6	1.34 H	145	49.17	-10.80
5	527.99	36.5 QP	46.0	-9.5	1.20 H	254	43.34	-6.80
6	935.98	40.2 QP	46.0	-5.8	1.24 H	198	39.35	0.86

ANTENNA POLARITY & TEST DISTANCE: VERTICAL AT 3 M

NO.	FREQ. (MHz)	EMISSION LEVEL (dBuV/m)	LIMIT (dBuV/m)	MARGIN (dB)	ANTENNA HEIGHT (m)	TABLE ANGLE (Degree)	RAW VALUE (dBuV)	CORRECTION FACTOR (dB/m)
1	60.51	34.3 QP	40.0	-5.7	1.24 V	167	48.53	-14.19
2	312.03	37.2 QP	46.0	-8.8	1.42 V	201	49.22	-11.98
3	432.44	41.2 QP	46.0	-4.8	1.24 V	304	49.81	-8.60
4	527.95	39.2 QP	46.0	-6.8	1.34 V	275	46.01	-6.80
5	647.95	36.4 QP	46.0	-9.6	1.34 V	179	40.51	-4.09
6	935.97	42.5 QP	46.0	-3.5	1.44 V	267	41.68	0.86

REMARKS:

1. Emission Level(dBuV/m) = Raw Value(dBuV) + Correction Factor(dB/m)
2. Correction Factor(dB/m) = Antenna Factor(dB/m) + Cable Factor(dB) – Pre-Amplifier Factor(dB)
3. The other emission levels were very low against the limit.
4. Margin value = Emission Level – Limit value



A D T

ABOVE 1GHz DATA

BT_LE-GFSK

CHANNEL	TX Channel 0	DETECTOR FUNCTION	Peak (PK)
FREQUENCY RANGE	1GHz ~ 25GHz		Average (AV)

ANTENNA POLARITY & TEST DISTANCE: HORIZONTAL AT 3 M								
NO.	FREQ. (MHz)	EMISSION LEVEL (dBuV/m)	LIMIT (dBuV/m)	MARGIN (dB)	ANTENNA HEIGHT (m)	TABLE ANGLE (Degree)	RAW VALUE (dBuV)	CORRECTION FACTOR (dB/m)
1	2390.00	54.5 PK	74.0	-19.5	1.36 H	123	59.97	-5.47
2	2390.00	40.0 AV	54.0	-14.0	1.36 H	123	45.47	-5.47
3	*2402.00	101.3 PK			1.36 H	123	106.74	-5.44
4	*2402.00	100.5 AV			1.36 H	123	105.94	-5.44
5	4804.00	47.1 PK	74.0	-26.9	1.01 H	232	43.31	3.79
6	4804.00	38.0 AV	54.0	-16.0	1.01 H	232	34.21	3.79

ANTENNA POLARITY & TEST DISTANCE: VERTICAL AT 3 M								
NO.	FREQ. (MHz)	EMISSION LEVEL (dBuV/m)	LIMIT (dBuV/m)	MARGIN (dB)	ANTENNA HEIGHT (m)	TABLE ANGLE (Degree)	RAW VALUE (dBuV)	CORRECTION FACTOR (dB/m)
1	2390.00	59.4 PK	74.0	-14.6	1.22 V	8	64.87	-5.47
2	2390.00	42.8 AV	54.0	-11.2	1.22 V	8	48.27	-5.47
3	*2402.00	105.1 PK			1.22 V	8	110.54	-5.44
4	*2402.00	104.4 AV			1.22 V	8	109.84	-5.44
5	4804.00	48.6 PK	74.0	-25.4	1.67 V	34	44.81	3.79
6	4804.00	38.6 AV	54.0	-15.4	1.67 V	34	34.81	3.79

REMARKS:

1. Emission Level(dBuV/m) = Raw Value(dBuV) + Correction Factor(dB/m)
2. Correction Factor(dB/m) = Antenna Factor(dB/m) + Cable Factor(dB) – Pre-Amplifier Factor(dB)
3. The other emission levels were very low against the limit.
4. Margin value = Emission Level – Limit value
5. " * ": Fundamental frequency.



A D T

CHANNEL	TX Channel 19	DETECTOR FUNCTION	Peak (PK)
FREQUENCY RANGE	1GHz ~ 25GHz		Average (AV)

ANTENNA POLARITY & TEST DISTANCE: HORIZONTAL AT 3 M

NO.	FREQ. (MHz)	EMISSION LEVEL (dBuV/m)	LIMIT (dBuV/m)	MARGIN (dB)	ANTENNA HEIGHT (m)	TABLE ANGLE (Degree)	RAW VALUE (dBuV)	CORRECTION FACTOR (dB/m)
1	*2440.00	103.1 PK			1.22 H	119	108.42	-5.32
2	*2440.00	102.0 AV			1.22 H	119	107.32	-5.32
3	4880.00	47.0 PK	74.0	-27.0	1.02 H	248	43.22	3.78
4	4880.00	38.2 AV	54.0	-15.8	1.02 H	248	34.42	3.78
5	7320.00	52.5 PK	74.0	-21.5	1.19 H	300	44.78	7.72
6	7320.00	43.5 AV	54.0	-10.5	1.19 H	300	35.78	7.72

ANTENNA POLARITY & TEST DISTANCE: VERTICAL AT 3 M

NO.	FREQ. (MHz)	EMISSION LEVEL (dBuV/m)	LIMIT (dBuV/m)	MARGIN (dB)	ANTENNA HEIGHT (m)	TABLE ANGLE (Degree)	RAW VALUE (dBuV)	CORRECTION FACTOR (dB/m)
1	*2440.00	104.6 PK			1.20 V	10	109.92	-5.32
2	*2440.00	103.6 AV			1.20 V	10	108.92	-5.32
3	4880.00	49.0 PK	74.0	-25.0	1.74 V	43	45.22	3.78
4	4880.00	39.0 AV	54.0	-15.0	1.74 V	43	35.22	3.78
5	7320.00	51.0 PK	74.0	-23.0	1.19 V	51	43.28	7.72
6	7320.00	43.5 AV	54.0	-10.5	1.19 V	51	35.78	7.72

REMARKS:

1. Emission Level(dBuV/m) = Raw Value(dBuV) + Correction Factor(dB/m)
2. Correction Factor(dB/m) = Antenna Factor(dB/m) + Cable Factor(dB) – Pre-Amplifier Factor(dB)
3. The other emission levels were very low against the limit.
4. Margin value = Emission Level – Limit value
5. " * ": Fundamental frequency.



A D T

CHANNEL	TX Channel 39	DETECTOR FUNCTION	Peak (PK)
FREQUENCY RANGE	1GHz ~ 25GHz		Average (AV)

ANTENNA POLARITY & TEST DISTANCE: HORIZONTAL AT 3 M

NO.	FREQ. (MHz)	EMISSION LEVEL (dBuV/m)	LIMIT (dBuV/m)	MARGIN (dB)	ANTENNA HEIGHT (m)	TABLE ANGLE (Degree)	RAW VALUE (dBuV)	CORRECTION FACTOR (dB/m)
1	*2480.00	102.9 PK			1.28 H	122	108.09	-5.19
2	*2480.00	102.1 AV			1.28 H	122	107.29	-5.19
3	2483.50	69.8 PK	74.0	-4.2	1.28 H	122	74.97	-5.17
4	2483.50	52.0 AV	54.0	-2.0	1.28 H	122	57.17	-5.17
5	4960.00	47.7 PK	74.0	-26.3	1.00 H	267	43.94	3.76
6	4960.00	38.8 AV	54.0	-15.2	1.00 H	267	35.04	3.76
7	7440.00	53.1 PK	74.0	-20.9	1.21 H	307	45.07	8.03
8	7440.00	44.1 AV	54.0	-9.9	1.21 H	307	36.07	8.03

ANTENNA POLARITY & TEST DISTANCE: VERTICAL AT 3 M

NO.	FREQ. (MHz)	EMISSION LEVEL (dBuV/m)	LIMIT (dBuV/m)	MARGIN (dB)	ANTENNA HEIGHT (m)	TABLE ANGLE (Degree)	RAW VALUE (dBuV)	CORRECTION FACTOR (dB/m)
1	*2480.00	105.3 PK			1.18 V	7	110.49	-5.19
2	*2480.00	104.5 AV			1.18 V	7	109.69	-5.19
3	2483.50	71.7 PK	74.0	-2.3	1.18 V	7	76.87	-5.17
4	2483.50	51.0 AV	54.0	-3.0	1.18 V	7	56.17	-5.17
5	4960.00	48.7 PK	74.0	-25.3	1.76 V	31	44.94	3.76
6	4960.00	38.9 AV	54.0	-15.1	1.76 V	31	35.14	3.76
7	7440.00	51.8 PK	74.0	-22.2	1.22 V	74	43.77	8.03
8	7440.00	44.0 AV	54.0	-10.0	1.22 V	74	35.97	8.03

REMARKS:

1. Emission Level(dBuV/m) = Raw Value(dBuV) + Correction Factor(dB/m)
2. Correction Factor(dB/m) = Antenna Factor(dB/m) + Cable Factor(dB) – Pre-Amplifier Factor(dB)
3. The other emission levels were very low against the limit.
4. Margin value = Emission Level – Limit value
5. " * ": Fundamental frequency.

4.3 6dB BANDWIDTH MEASUREMENT

4.3.1 LIMITS OF 6dB BANDWIDTH MEASUREMENT

The minimum of 6dB Bandwidth Measurement is 0.5 MHz.

4.3.2 TEST INSTRUMENTS

DESCRIPTION & MANUFACTURER	MODEL NO.	SERIAL NO.	CALIBRATED DATE	CALIBRATED UNTIL
SPECTRUM ANALYZER R&S	FSV 40	100964	July 15, 2013	July 14, 2014

Note:

1. The calibration interval of the above test instruments is 12 months and the calibrations are traceable to NML/ROC and NIST/USA.
2. Tested date : May 20, 2014

4.3.3 TEST PROCEDURE

1. Set resolution bandwidth (RBW) = 100kHz.
2. Set the video bandwidth (VBW) $\geq 3 \times$ RBW, Detector = Peak.
3. Trace mode = max hold.
4. Sweep = auto couple.
5. Measure the maximum width of the emission that is constrained by the frequencies associated with the two amplitude points (upper and lower) that are attenuated by 6 dB relative to the maximum level measured in the fundamental emission

4.3.4 DEVIATION FROM TEST STANDARD

No deviation

4.3.5 TEST SETUP



4.3.6 EUT OPERATING CONDITIONS

The software provided by client to enable the EUT under transmission condition continuously at lowest, middle and highest channel frequencies individually.



4.3.7 TEST RESULTS

802.11b

CHANNEL	CHANNEL FREQUENCY (MHz)	6dB BANDWIDTH (MHz)		MINIMUM LIMIT (MHz)	PASS / FAIL
		CHAIN 0	CHAIN 1		
1	2412	10.10	10.10	0.5	PASS
6	2437	10.09	10.09	0.5	PASS
11	2462	10.09	10.10	0.5	PASS

802.11g

CHANNEL	CHANNEL FREQUENCY (MHz)	6dB BANDWIDTH (MHz)		MINIMUM LIMIT (MHz)	PASS / FAIL
		CHAIN 0	CHAIN 1		
1	2412	16.48	16.59	0.5	PASS
6	2437	16.56	16.59	0.5	PASS
11	2462	16.59	16.53	0.5	PASS

802.11n (HT20)

CHANNEL	CHANNEL FREQUENCY (MHz)	6dB BANDWIDTH (MHz)		MINIMUM LIMIT (MHz)	PASS / FAIL
		CHAIN 0	CHAIN 1		
1	2412	17.71	17.73	0.5	PASS
6	2437	17.62	17.68	0.5	PASS
11	2462	17.72	17.74	0.5	PASS

802.11n (HT40)

CHANNEL	CHANNEL FREQUENCY (MHz)	6dB BANDWIDTH (MHz)		MINIMUM LIMIT (MHz)	PASS / FAIL
		CHAIN 0	CHAIN 1		
3	2422	36.51	36.49	0.5	PASS
6	2437	36.50	36.45	0.5	PASS
9	2452	36.49	36.56	0.5	PASS



A D T

SPECTRUM PLOT OF WORST VALUE

802.11b / Chain (0) : CH6

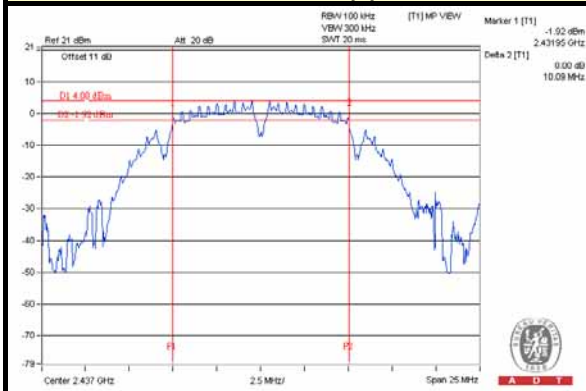

802.11g / Chain (0) : CH1

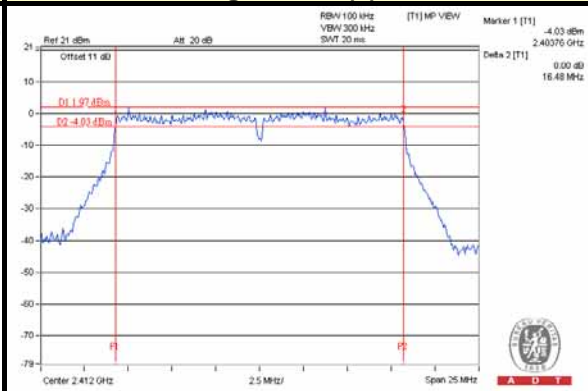

802.11n (HT20) / Chain (0) : CH6

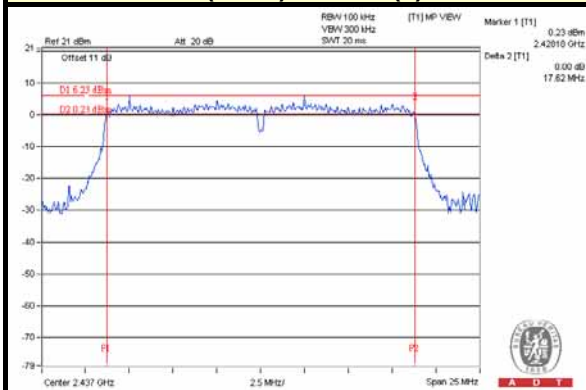

802.11n (HT40) / Chain (1) : CH6

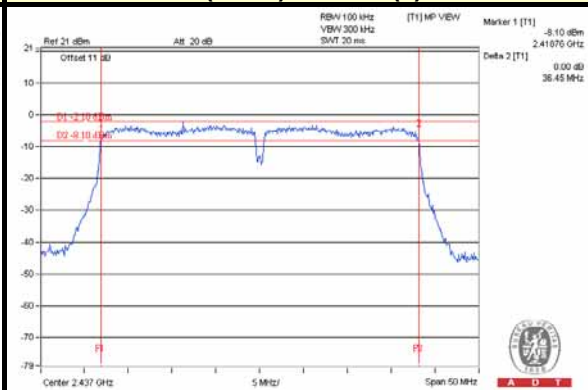



A D T

BT_LE-GFSK

CHANNEL	FREQUENCY (MHz)	6dB BANDWIDTH (MHz)	MINIMUM LIMIT (MHz)	PASS / FAIL
0	2402	0.72	0.5	PASS
19	2440	0.72	0.5	PASS
39	2480	0.72	0.5	PASS

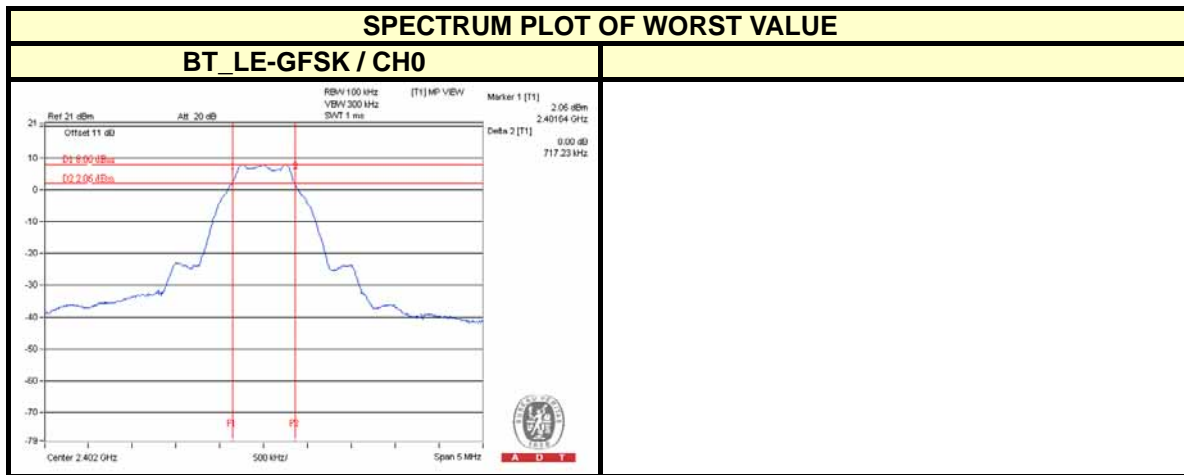



A D T

4.4 CONDUCTED OUTPUT POWER MEASUREMENT

4.4.1 LIMITS OF CONDUCTED OUTPUT POWER MEASUREMENT

For systems using digital modulation in the 2400–2483.5 MHz bands: 1 Watt (30dBm)

Per KDB 662911 D01 Multiple Transmitter Output Method of conducted output power measurement on IEEE 802.11 devices,

Array Gain = 0 dB (i.e., no array gain) for $NANT \leq 4$;

Array Gain = 0 dB (i.e., no array gain) for channel widths ≥ 40 MHz for any NANT;

Array Gain = $5 \log(NANT/NSS)$ dB or 3 dB, whichever is less for 20-MHz channel widths with $NANT \geq 5$.

For power measurements on all other devices: Array Gain = $10 \log(NANT/NSS)$ dB.

4.4.2 TEST INSTRUMENTS

DESCRIPTION & MANUFACTURER	MODEL NO.	SERIAL NO.	CALIBRATED DATE	CALIBRATED UNTIL
Power meter Anritsu	ML2495A	1014008	Apr. 30, 2014	Apr. 29, 2015
Power sensor Anritsu	MA2411B	0917122	Apr. 30, 2014	Apr. 29, 2015

Note:

1. The calibration interval of the above test instruments is 12 months and the calibrations are traceable to NML/ROC and NIST/USA.
2. Tested date : May 20, 2014

4.4.3 TEST PROCEDURES

The peak / average power sensor was used on the output port of the EUT. A power meter was used to read the response of the peak / average power sensor. Record the peak power level.

4.4.4 DEVIATION FROM TEST STANDARD

No deviation.

4.4.5 TEST SETUP

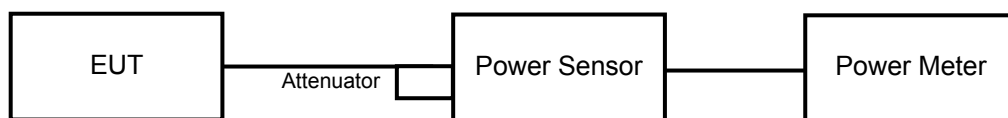

4.4.6 EUT OPERATING CONDITIONS

Same as Item 4.3.6



4.4.7 TEST RESULTS

FOR PEAK POWER

802.11b

CHANNEL	FREQUENCY (MHz)	PEAK POWER (dBm)		TOTAL POWER (mW)	TOTAL POWER (dBm)	LIMIT (dBm)	PASS / FAIL
		CHAIN 0	CHAIN 1				
1	2412	15.05	15.82	70.183	18.46	30	PASS
6	2437	14.85	15.59	66.773	18.25	30	PASS
11	2462	15.07	15.90	71.042	18.52	30	PASS

802.11g

CHANNEL	FREQUENCY (MHz)	PEAK POWER (dBm)		TOTAL POWER (mW)	TOTAL POWER (dBm)	LIMIT (dBm)	PASS / FAIL
		CHAIN 0	CHAIN 1				
1	2412	21.27	22.07	295.033	24.70	30	PASS
6	2437	25.33	25.48	694.376	28.42	30	PASS
11	2462	22.45	21.67	322.685	25.09	30	PASS

802.11n (HT20)

CHANNEL	FREQUENCY (MHz)	PEAK POWER (dBm)		TOTAL POWER (mW)	TOTAL POWER (dBm)	LIMIT (dBm)	PASS / FAIL
		CHAIN 0	CHAIN 1				
1	2412	21.30	22.62	317.706	25.02	30	PASS
6	2437	25.34	25.49	695.976	28.43	30	PASS
11	2462	21.28	22.26	302.543	24.81	30	PASS

802.11n (HT40)

CHANNEL	FREQUENCY (MHz)	PEAK POWER (dBm)		TOTAL POWER (mW)	TOTAL POWER (dBm)	LIMIT (dBm)	PASS / FAIL
		CHAIN 0	CHAIN 1				
3	2422	18.15	20.52	178.033	22.51	30	PASS
6	2437	21.51	21.60	286.123	24.57	30	PASS
9	2452	19.74	20.32	201.836	23.05	30	PASS

BT_LE-GFSK

CHANNEL	FREQUENCY (MHz)	PEAK POWER (mW)	PEAK POWER (dBm)	LIMIT (dBm)	PASS/FAIL
0	2402	7.709	8.87	30	PASS
19	2440	6.281	7.98	30	PASS
39	2480	5.047	7.03	30	PASS



A D T

FOR AVERAGE POWER

802.11b

CHANNEL	FREQUENCY (MHz)	AVERAGE POWER (dBm)		TOTAL POWER (mW)	TOTAL POWER (dBm)
		CHAIN 0	CHAIN 1		
1	2412	12.13	12.90	35.829	15.54
6	2437	12.01	12.60	34.082	15.33
11	2462	12.16	12.92	36.032	15.57

802.11g

CHANNEL	FREQUENCY (MHz)	AVERAGE POWER (dBm)		TOTAL POWER (mW)	TOTAL POWER (dBm)
		CHAIN 0	CHAIN 1		
1	2412	13.25	13.81	45.179	16.55
6	2437	16.99	17.42	105.211	20.22
11	2462	13.17	13.37	42.476	16.28

802.11n (HT20)

CHANNEL	FREQUENCY (MHz)	AVERAGE POWER (dBm)		TOTAL POWER (mW)	TOTAL POWER (dBm)
		CHAIN 0	CHAIN 1		
1	2412	13.23	13.40	42.916	16.33
6	2437	16.91	17.41	104.172	20.18
11	2462	13.01	13.24	41.085	16.14

802.11n (HT40)

CHANNEL	FREQUENCY (MHz)	AVERAGE POWER (dBm)		TOTAL POWER (mW)	TOTAL POWER (dBm)
		CHAIN 0	CHAIN 1		
3	2422	10.70	11.06	24.513	13.89
6	2437	13.33	13.56	44.227	16.46
9	2452	11.81	11.94	30.802	14.89

BT_LE-GFSK

CHANNEL	FREQUENCY (MHz)	AVERAGE POWER (mW)	AVERAGE POWER (dBm)
0	2402	5.212	7.17
19	2440	4.943	6.94
39	2480	4.699	6.72



A D T

4.5 POWER SPECTRAL DENSITY MEASUREMENT

4.5.1 LIMITS OF POWER SPECTRAL DENSITY MEASUREMENT

The Maximum of Power Spectral Density Measurement is 8dBm.

4.5.2 TEST INSTRUMENTS

DESCRIPTION & MANUFACTURER	MODEL NO.	SERIAL NO.	CALIBRATED DATE	CALIBRATED UNTIL
SPECTRUM ANALYZER R&S	FSV 40	100964	July 15, 2013	July 14, 2014

Note:

1. The calibration interval of the above test instruments is 12 months and the calibrations are traceable to NML/ROC and NIST/USA.
2. Tested date : May 20, 2014

4.5.3 TEST PROCEDURE

1. Set the RBW = 3 kHz, VBW =10 kHz, Detector = peak.
2. Sweep time = auto couple, Trace mode = max hold, allow trace to fully stabilize.
3. Use the peak marker function to determine the maximum amplitude level.

4.5.4 DEVIATION FROM TEST STANDARD

No deviation

4.5.5 TEST SETUP

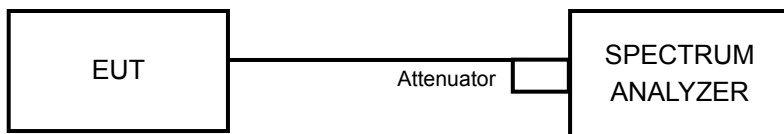

4.5.6 EUT OPERATING CONDITION

Same as Item 4.3.6



A D T

4.5.7 TEST RESULTS

802.11b

TX CHAIN	CHANNEL	FREQUENCY (MHz)	PSD (dBm)	10 log (N=2) dB	TOTAL PSD (dBm)	LIMIT (dBm)	PASS /FAIL
0	1	2412	-10.09	3.01	-7.08	8	PASS
	6	2437	-8.32	3.01	-5.31	8	PASS
	11	2462	-8.32	3.01	-5.31	8	PASS
1	1	2412	-8.88	3.01	-5.87	8	PASS
	6	2437	-10.08	3.01	-7.07	8	PASS
	11	2462	-9.25	3.01	-6.24	8	PASS

NOTE: Directional gain = 2.98dBi + 10log(2) = 5.99dBi < 6dBi , so the power density limit shall not be reduced.

802.11g

TX CHAIN	CHANNEL	FREQUENCY (MHz)	PSD (dBm)	10 log (N=2) dB	TOTAL PSD (dBm)	LIMIT (dBm)	PASS /FAIL
0	1	2412	-11.73	3.01	-8.72	8	PASS
	6	2437	-7.87	3.01	-4.86	8	PASS
	11	2462	-11.51	3.01	-8.50	8	PASS
1	1	2412	-11.19	3.01	-8.18	8	PASS
	6	2437	-8.11	3.01	-5.10	8	PASS
	11	2462	-11.65	3.01	-8.64	8	PASS

NOTE: Directional gain = 2.98dBi + 10log(2) = 5.99dBi < 6dBi , so the power density limit shall not be reduced.



A D T

802.11n (HT20)

TX CHAIN	CHANNEL	FREQUENCY (MHz)	PSD (dBm)	10 log (N=2) dB	Total PSD (dBm)	Limit (dBm)	PASS /FAIL
0	1	2412	-12.39	3.01	-9.38	8	PASS
	6	2437	-8.39	3.01	-5.38	8	PASS
	11	2462	-11.88	3.01	-8.87	8	PASS
1	1	2412	-12.25	3.01	-9.24	8	PASS
	6	2437	-9.27	3.01	-6.26	8	PASS
	11	2462	-12.51	3.01	-9.50	8	PASS

802.11n (HT40)

TX CHAIN	CHANNEL	FREQUENCY (MHz)	PSD (dBm)	10 log (N=2) dB	Total PSD (dBm)	Limit (dBm)	PASS /FAIL
0	3	2422	-16.78	3.01	-13.77	8	PASS
	6	2437	-14.07	3.01	-11.06	8	PASS
	9	2452	-16.11	3.01	-13.10	8	PASS
1	3	2422	-18.26	3.01	-15.25	8	PASS
	6	2437	-15.44	3.01	-12.43	8	PASS
	9	2452	-17.03	3.01	-14.02	8	PASS



A D T

SPECTRUM PLOT OF WORST VALUE

802.11b / Chain (0) : CH6

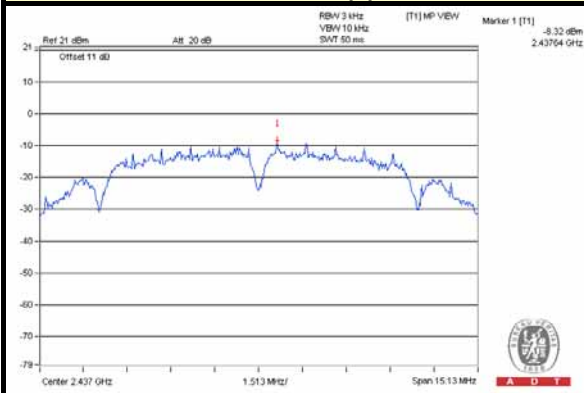

802.11g / Chain (0) : CH6

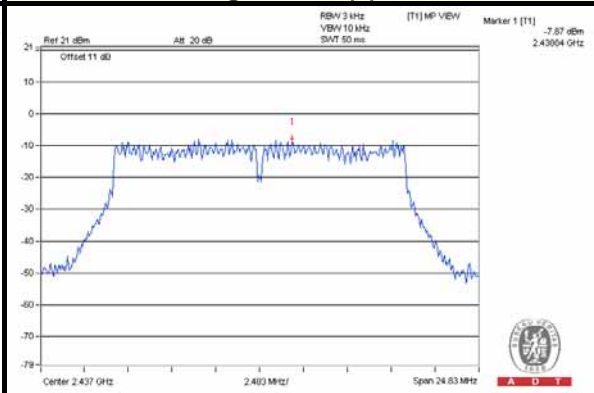

802.11n (HT20) / Chain(0) : CH6

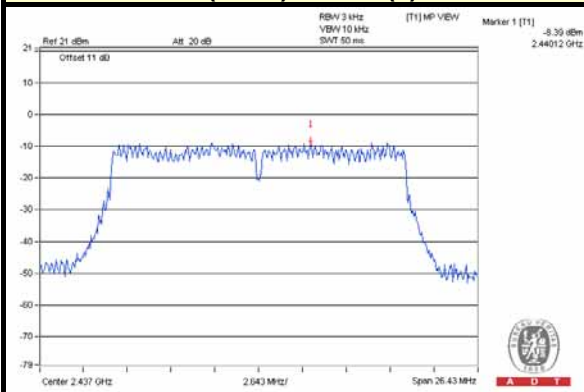

802.11n (HT40) / Chain(0) : CH6

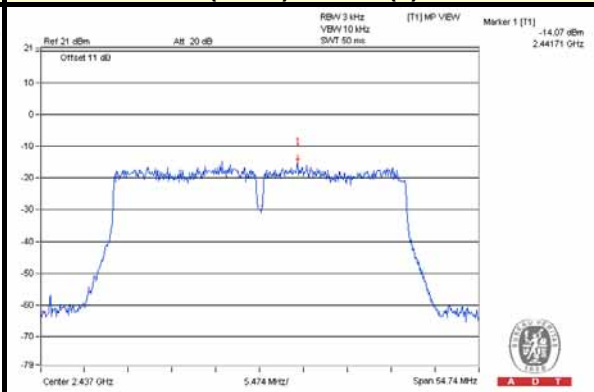



A D T

BT_LE-GFSK

Channel	FREQUENCY (MHz)	PSD (dBm)	LIMIT (dBm)	PASS /FAIL
0	2402	-6.90	8	PASS
19	2440	-7.13	8	PASS
39	2480	-7.53	8	PASS

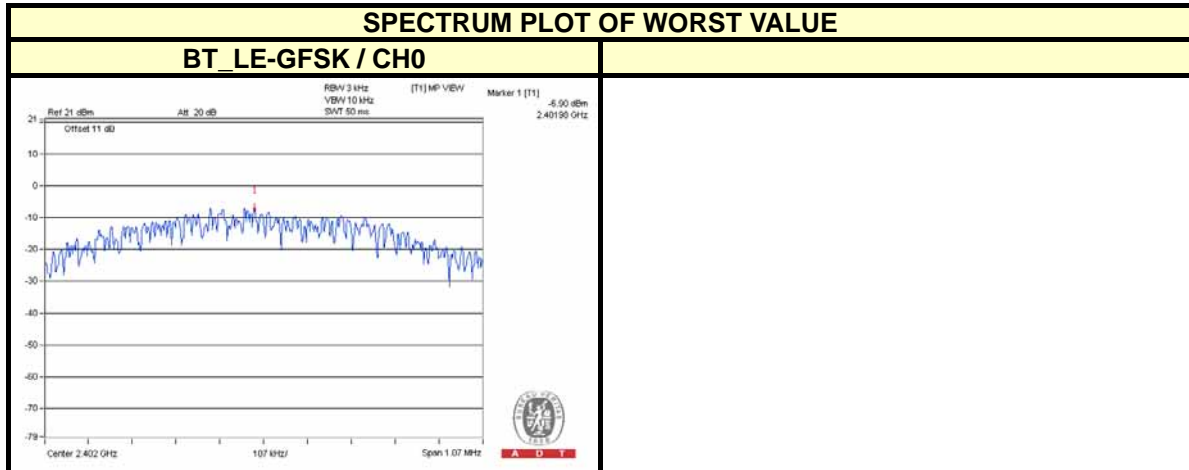



A D T

4.6 CONDUCTED OUT-BAND EMISSION MEASUREMENT

4.6.1 LIMITS OF CONDUCTED OUT-BAND EMISSION MEASUREMENT

Below 20dB of the highest emission level of operating band (in 100kHz Resolution Bandwidth).

4.6.2 TEST INSTRUMENTS

DESCRIPTION & MANUFACTURER	MODEL NO.	SERIAL NO.	CALIBRATED DATE	CALIBRATED UNTIL
SPECTRUM ANALYZER R&S	FSV 40	100964	July 15, 2013	July 14, 2014

Note:

1. The calibration interval of the above test instruments is 12 months and the calibrations are traceable to NML/ROC and NIST/USA.
2. Tested date : May 20, 2014

4.6.3 TEST PROCEDURE

Measurement Procedure - Reference Level

1. Set the RBW = 100 kHz.
2. Set the VBW \geq 300 kHz.
3. Detector = peak.
4. Sweep time = auto couple.
5. Trace mode = max hold.
6. Allow trace to fully stabilize.
7. Use the peak marker function to determine the maximum power level in any 100 kHz band segment within the fundamental EBW.

Measurement Procedure –Unwanted Emission Level

1. Set RBW = 100 kHz.
2. Set VBW \geq 300 kHz.
3. Set span to encompass the spectrum to be examined
4. Detector = peak.
5. Trace Mode = max hold.
6. Sweep = auto couple.

4.6.4 DEVIATION FROM TEST STANDARD

No deviation

4.6.5 TEST SETUP

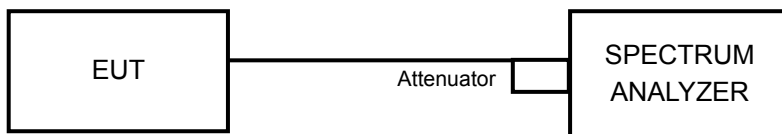

4.6.6 EUT OPERATING CONDITION

Same as Item 4.3.6

4.6.7 TEST RESULTS

The spectrum plots are attached on the following pages. D1 line indicates the highest level, and D2 line indicates the 20dB offset below D1. It shows compliance with the requirement.



A D T

802.11b

Chain (0)

CH 1

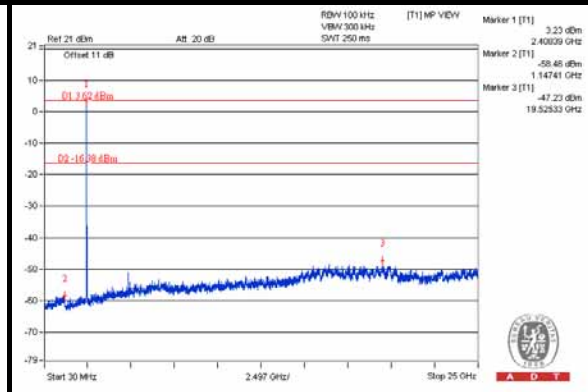
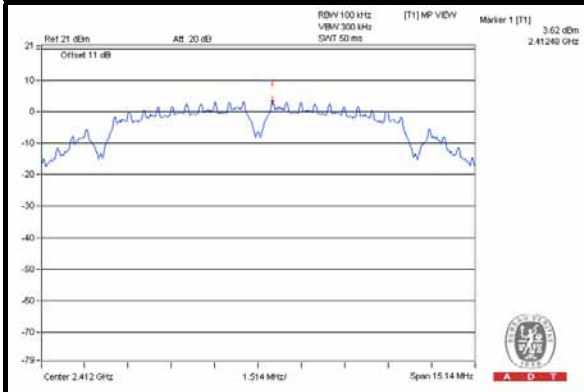

CH 6

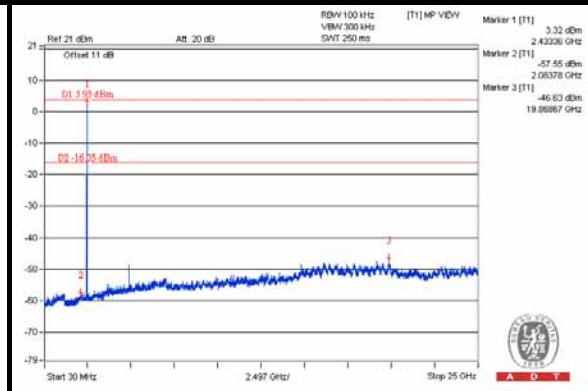
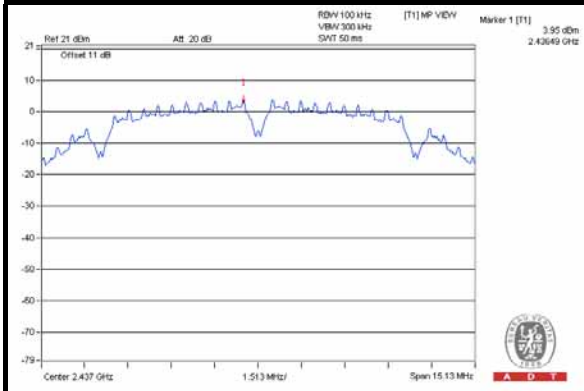

CH 11

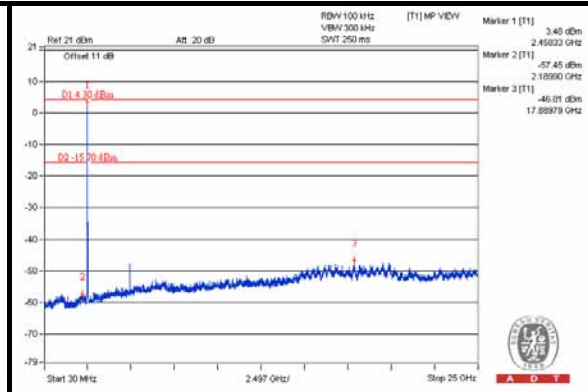
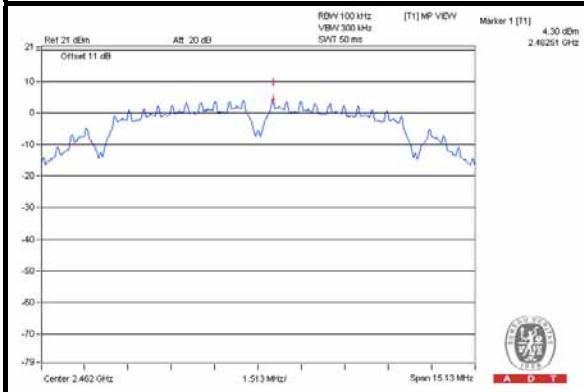

CH 1 Band edge

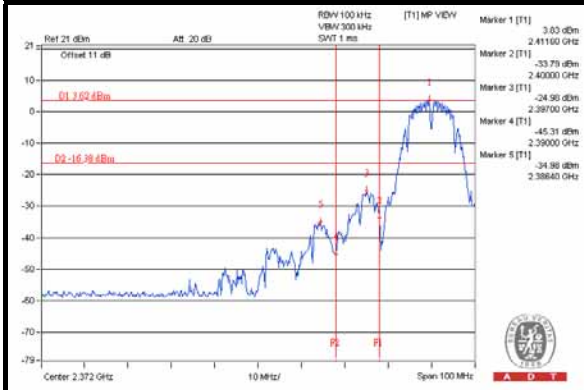

CH 11 Band edge

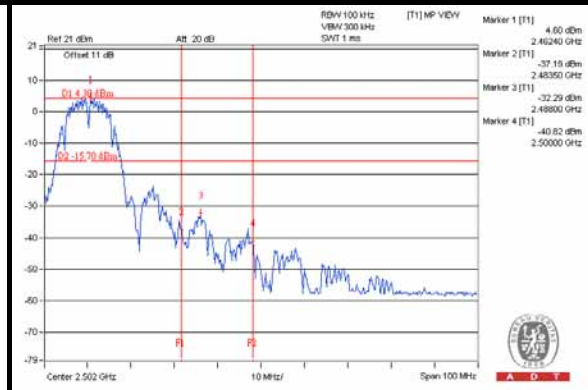



A D T

Chain (1) CH 1

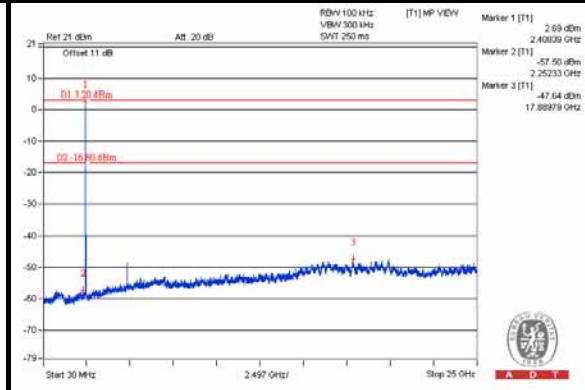
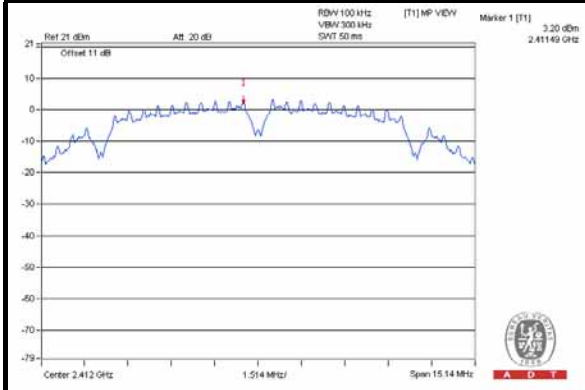

CH 6

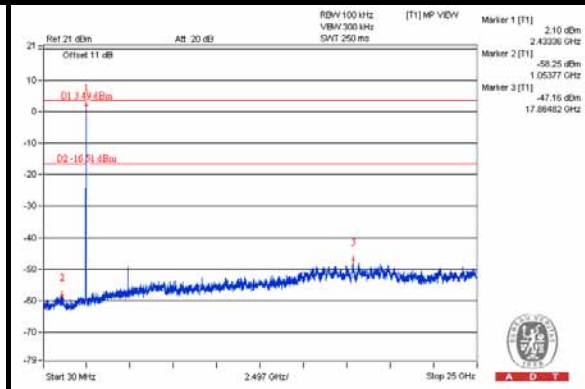
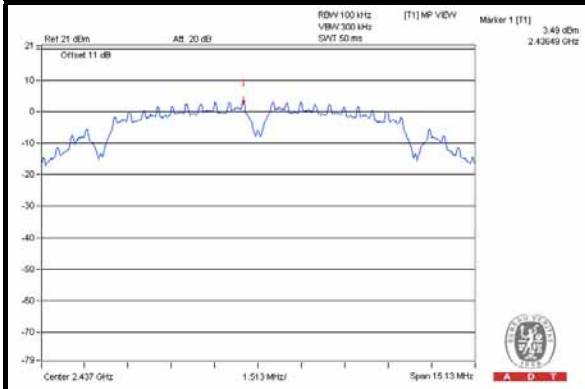

CH 11

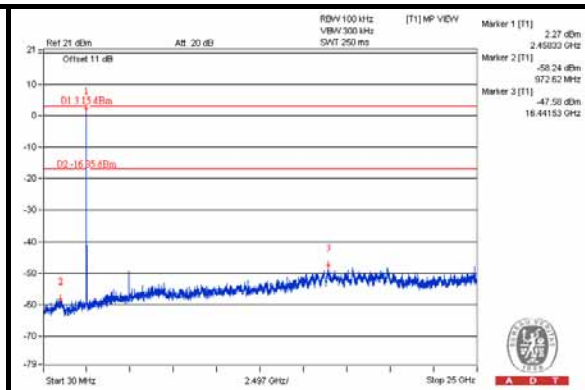
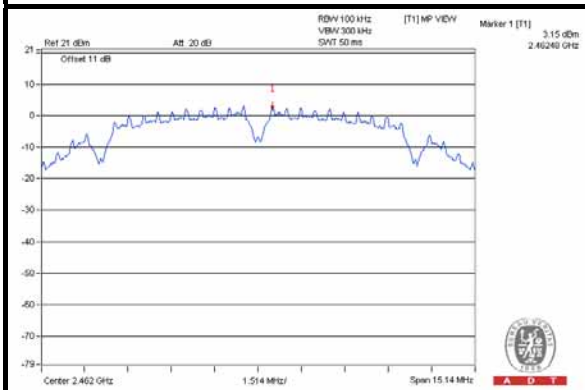

CH 1 Band edge

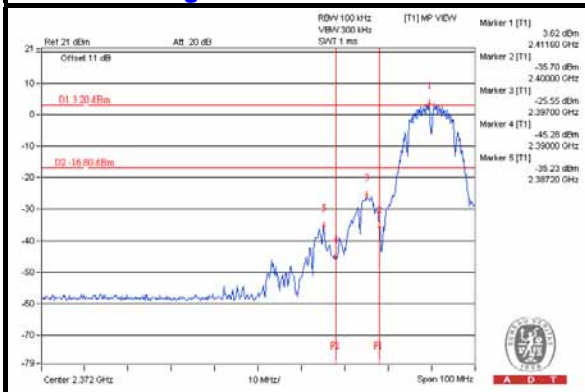

CH 11 Band edge

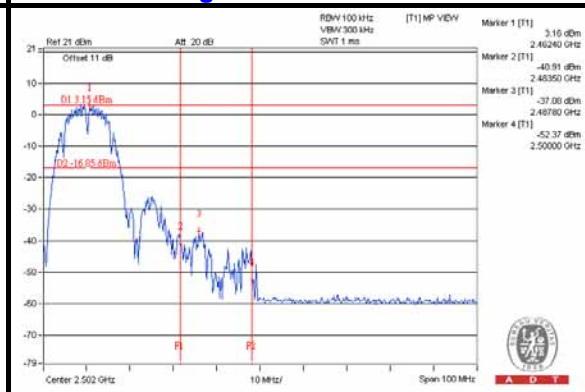



A D T

802.11g

Chain (0)

CH 1

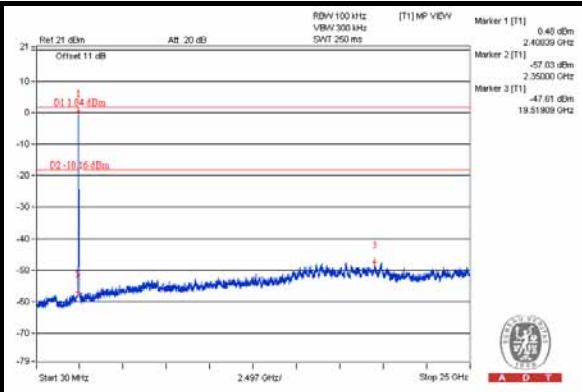
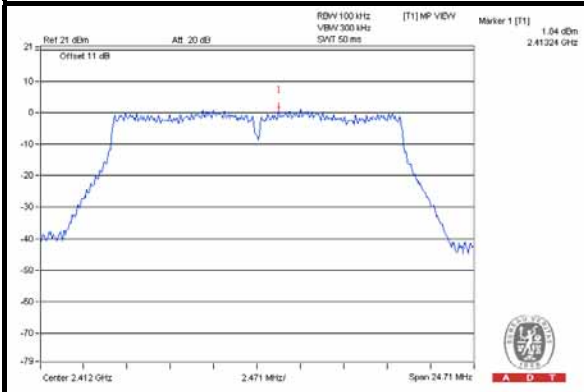

CH 6

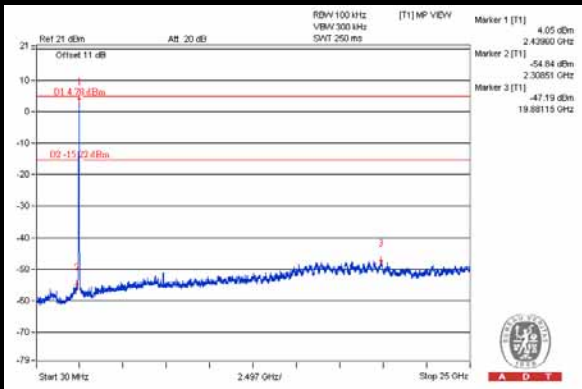
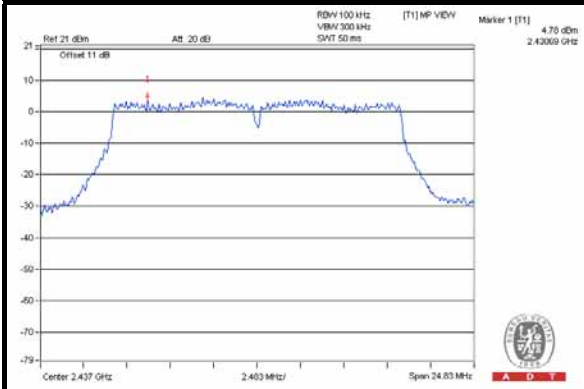

CH 11

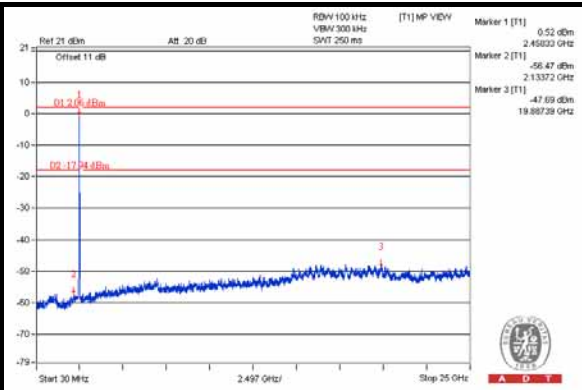
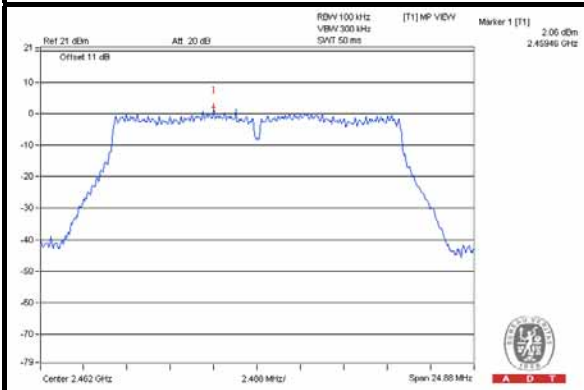

CH 1 Band edge

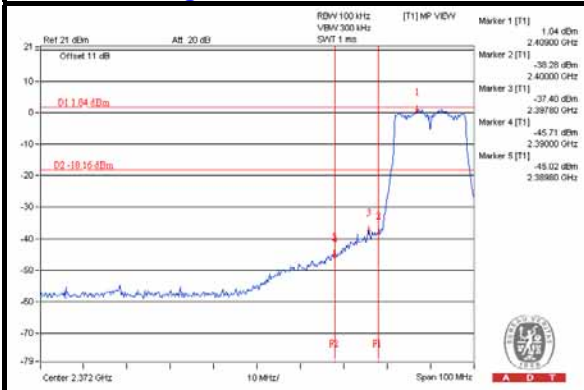

CH 11 Band edge

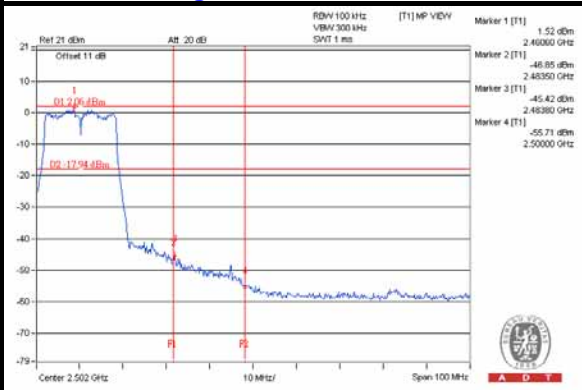



A D T

Chain (1)

CH 1

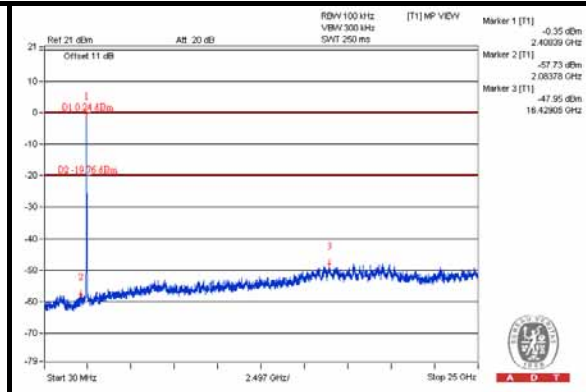
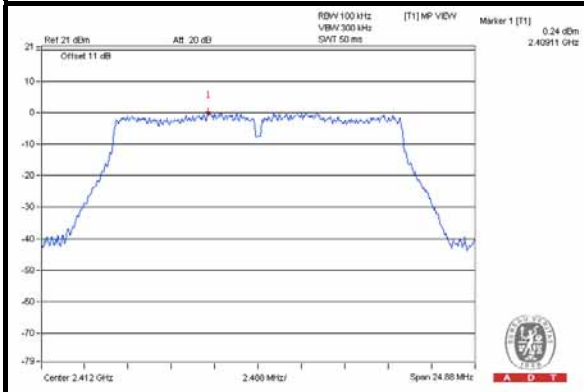

CH 6

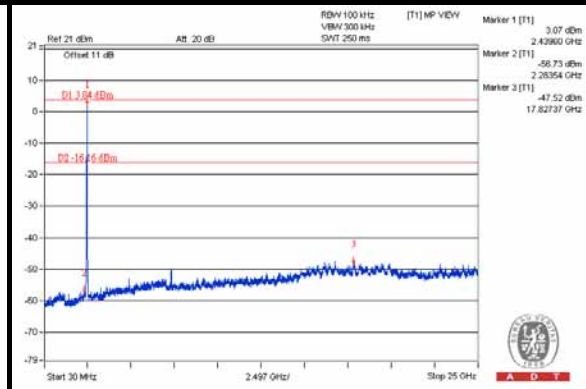
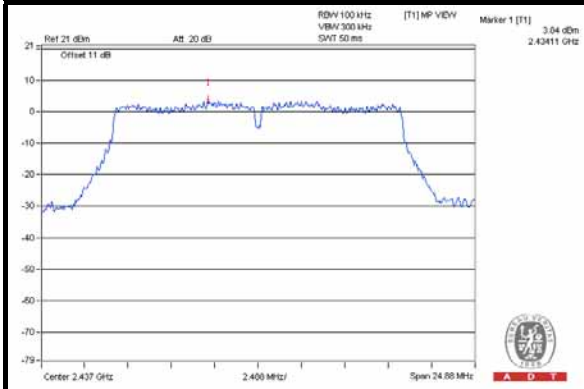

CH 11

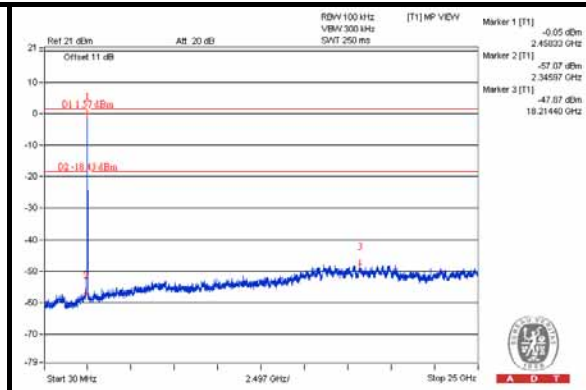
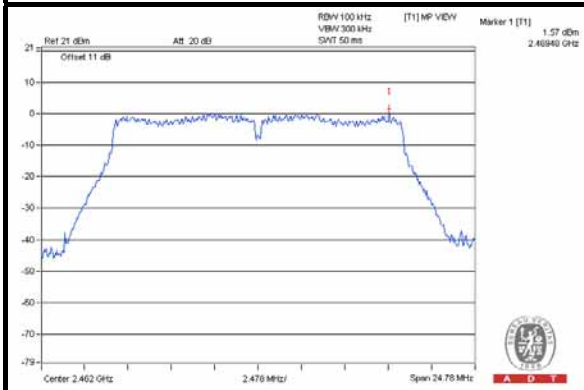

CH 1 Band edge

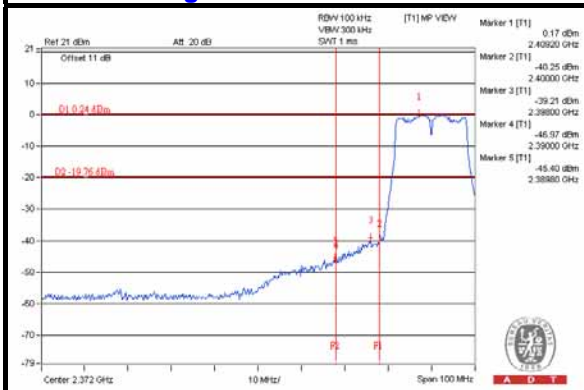

CH 11 Band edge

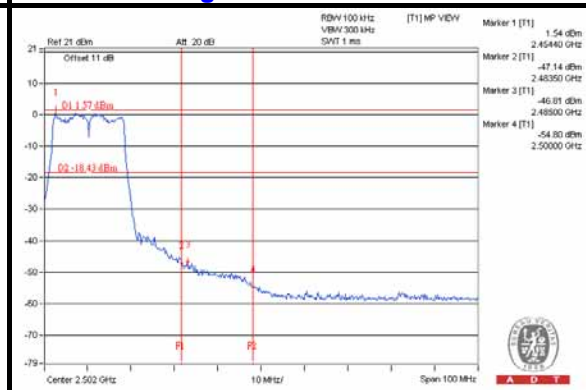



A D T

802.11n (HT20)

Chain (0)

CH 1

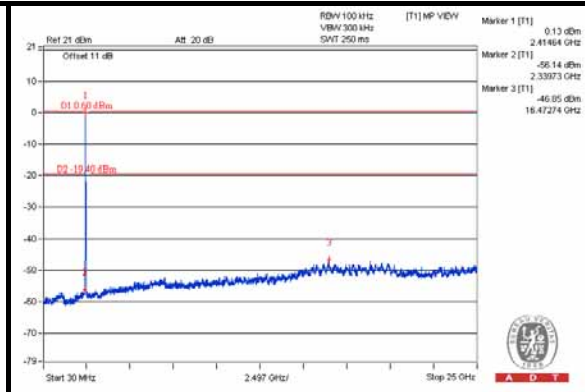
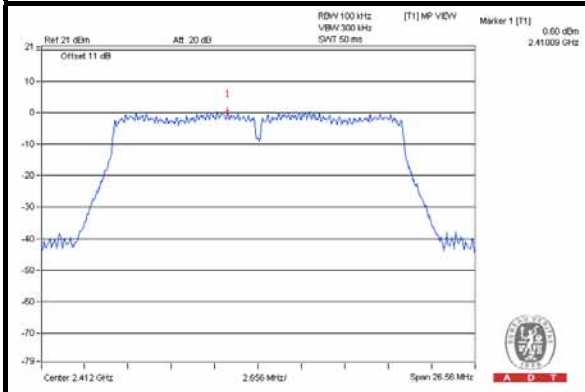

CH 6

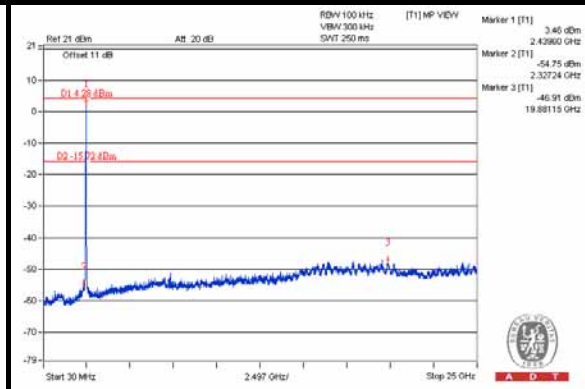
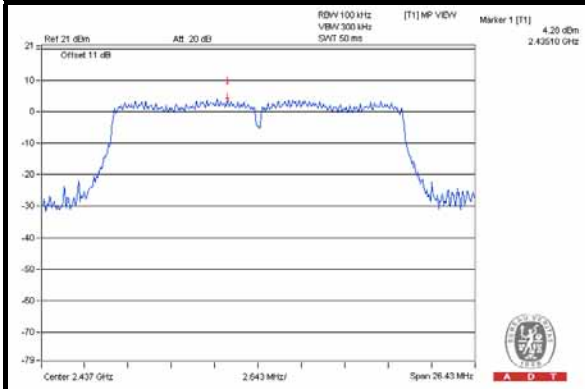

CH 11

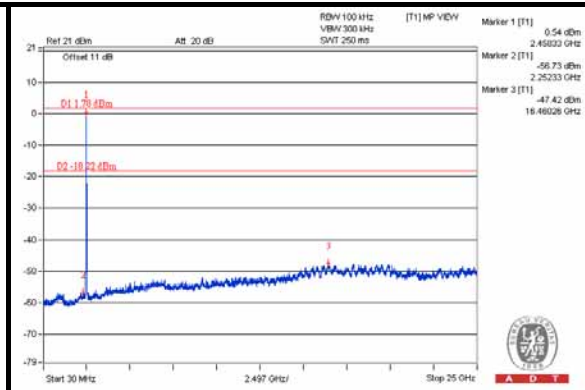
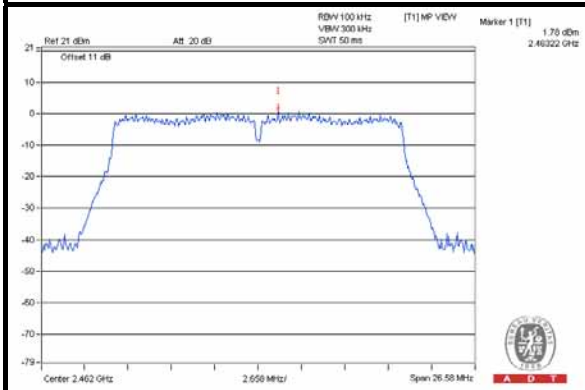

CH 1 Band edge

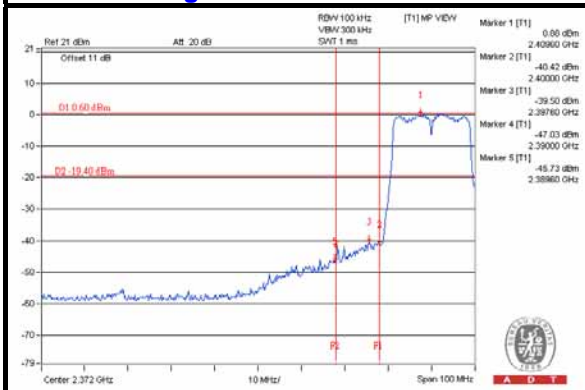

CH 11 Band edge

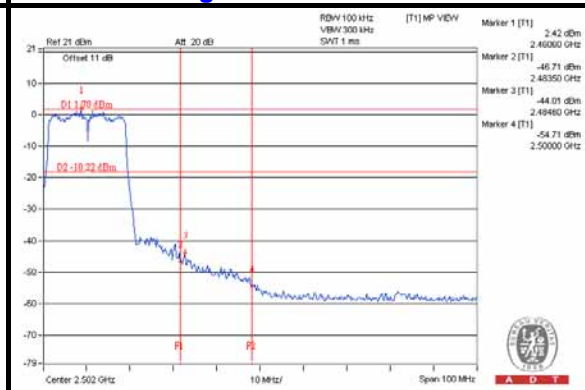

Chain (1)
CH 1

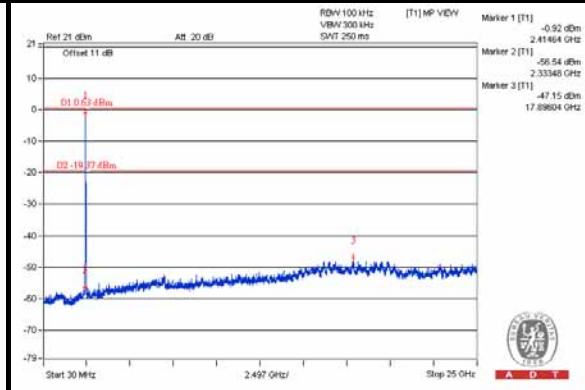
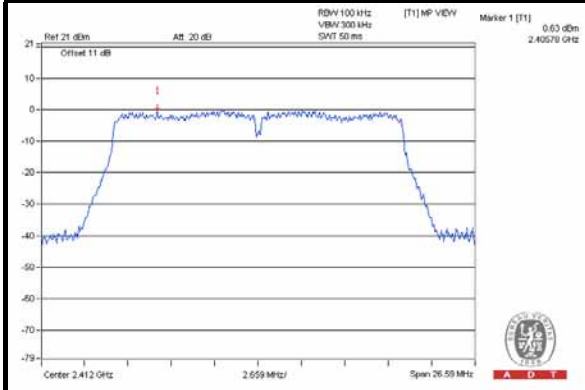

CH 6

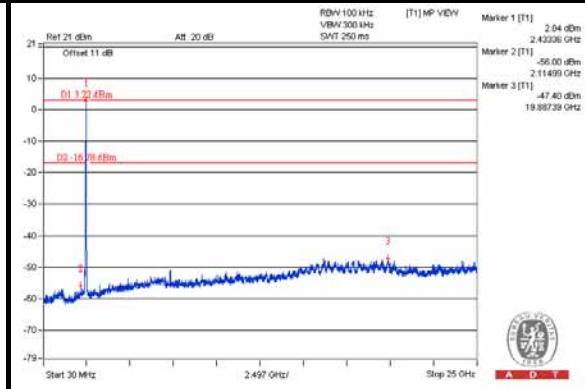
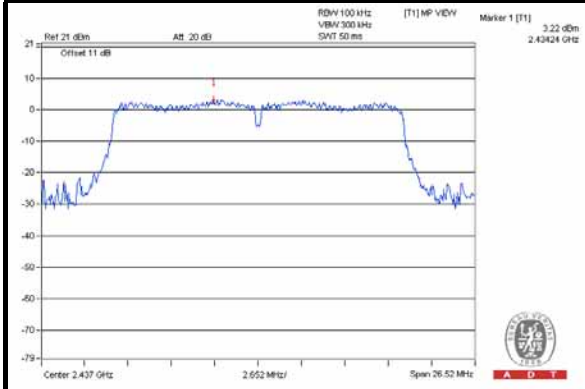

CH 11

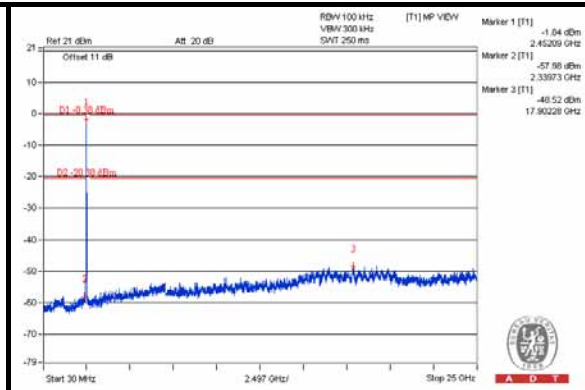
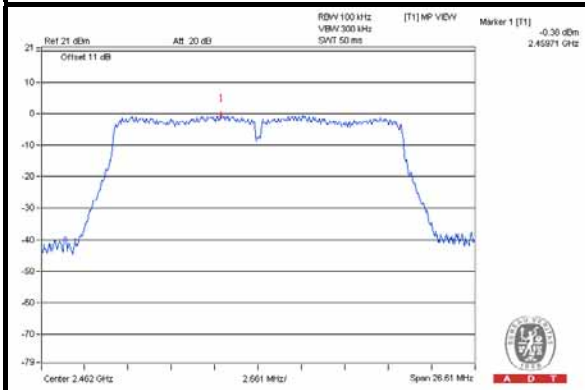

CH 1 Band edge

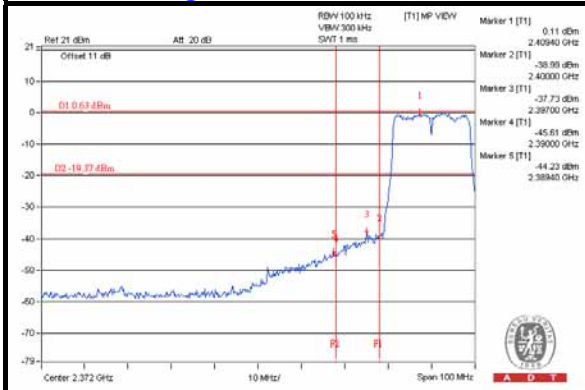

CH 11 Band edge

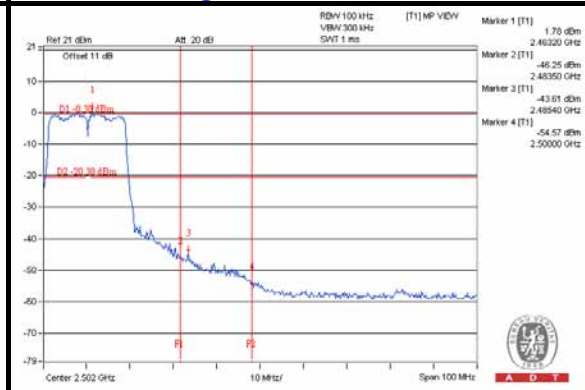



A D T

802.11n (HT40)

Chain (0)

CH 3

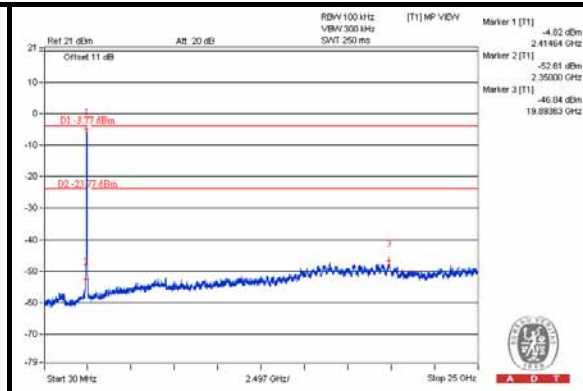
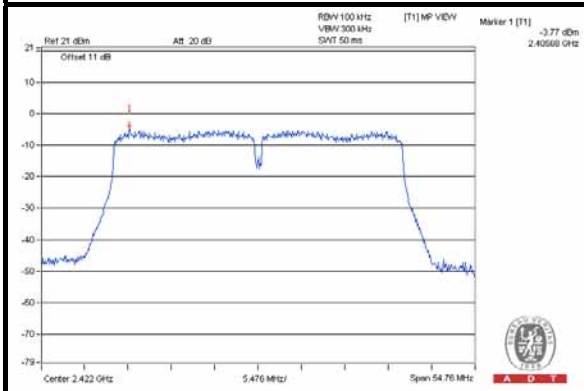

CH 6

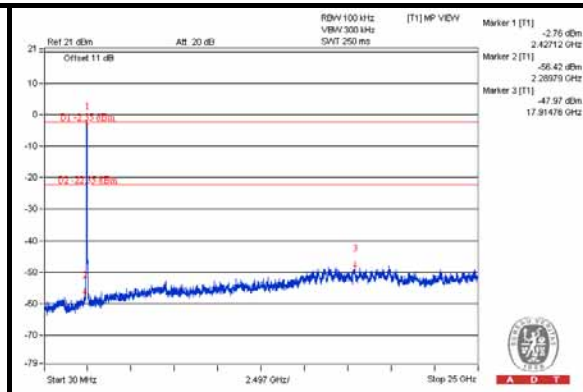
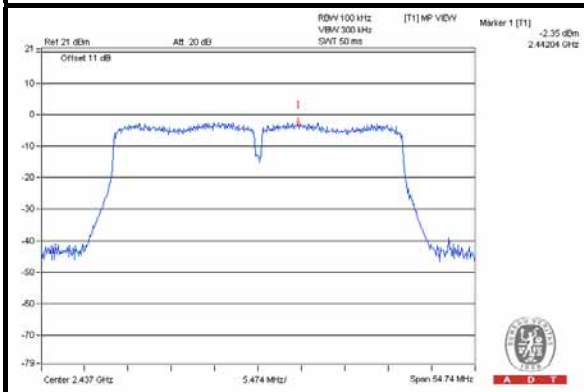

CH 9

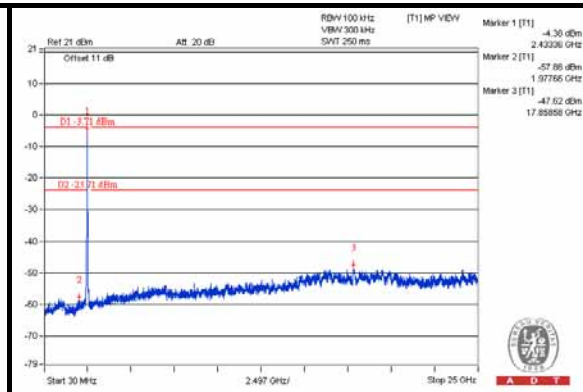
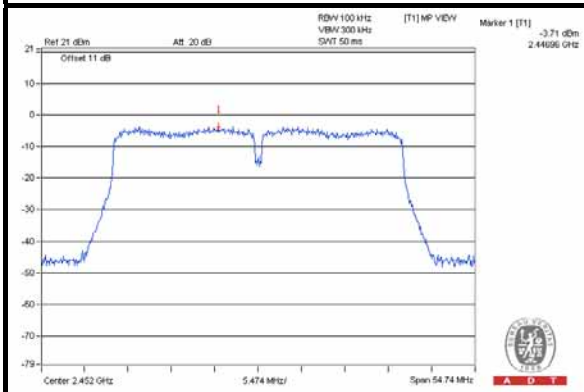

CH 3 Band edge

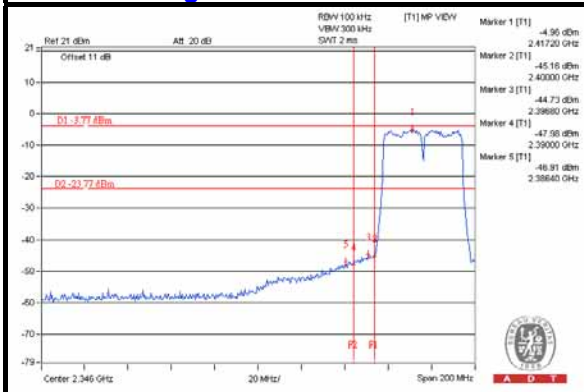

CH 9 Band edge

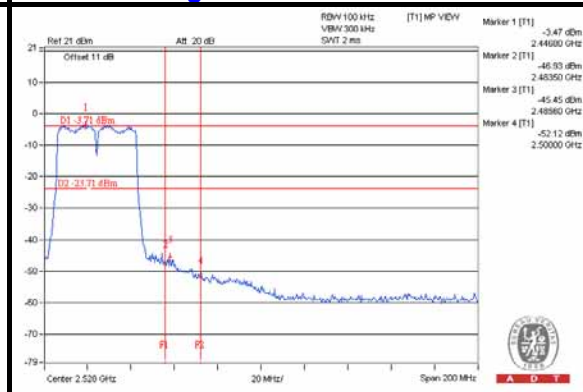



A D T

Chain (1)

CH 3

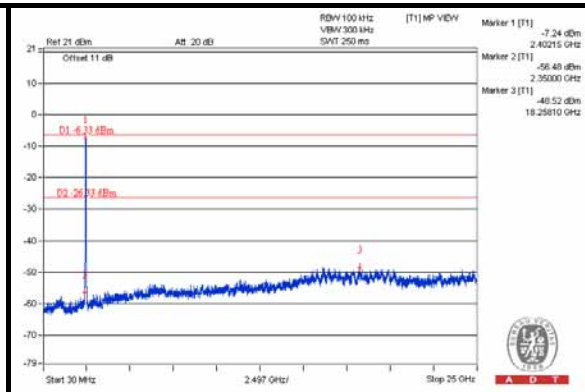
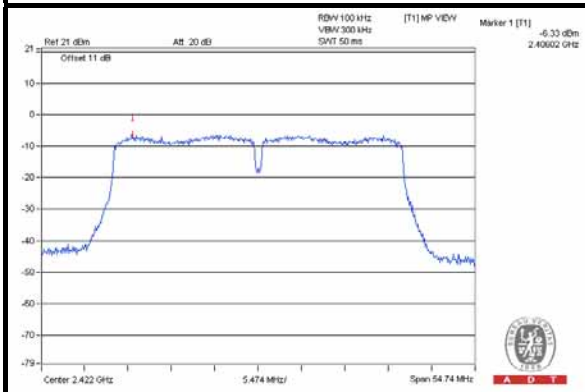

CH 6

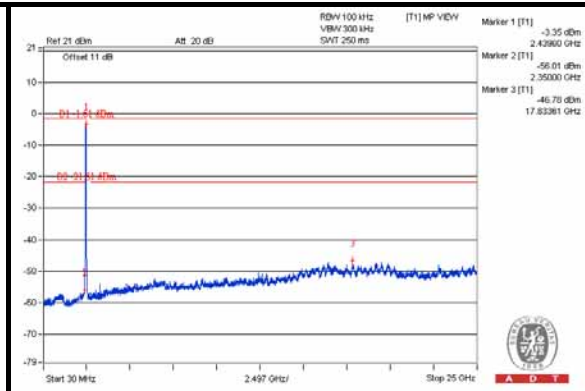
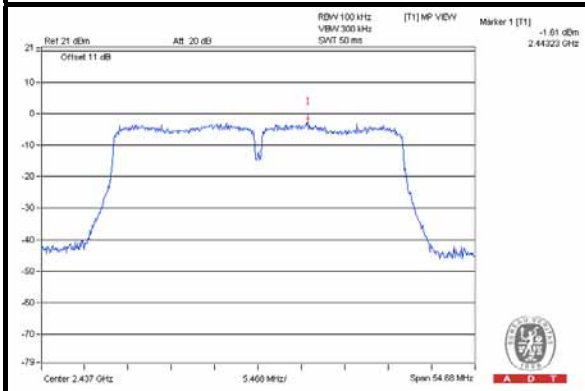

CH 9

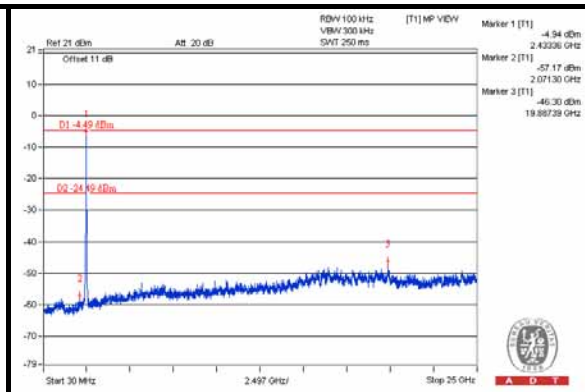
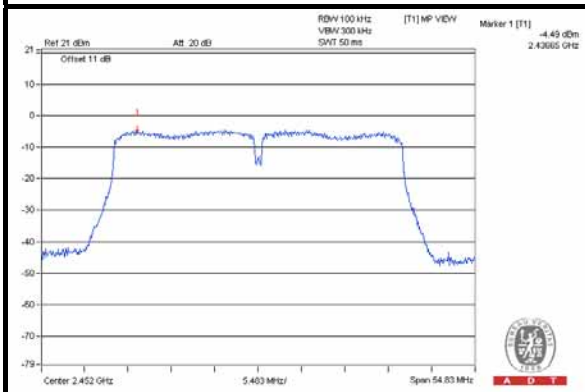

CH 3 Band edge

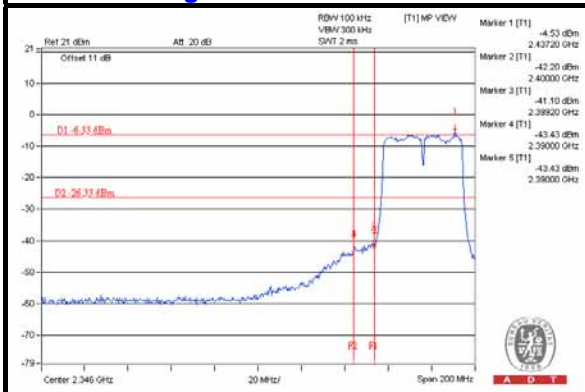

CH 9 Band edge

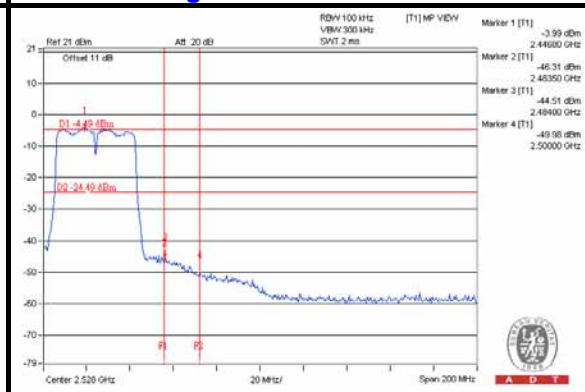



A D T

BT_LE-GFSK

CH 0

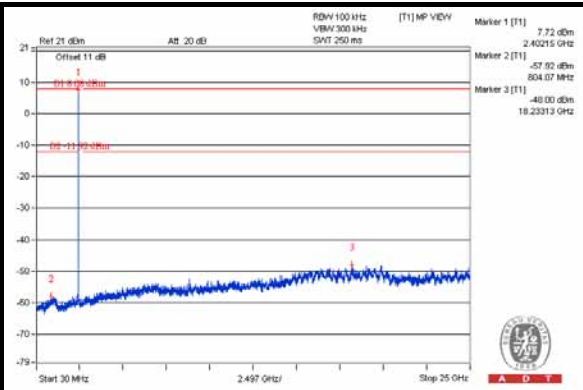
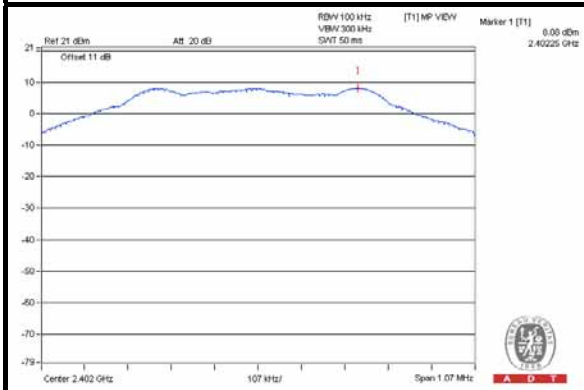

CH 19

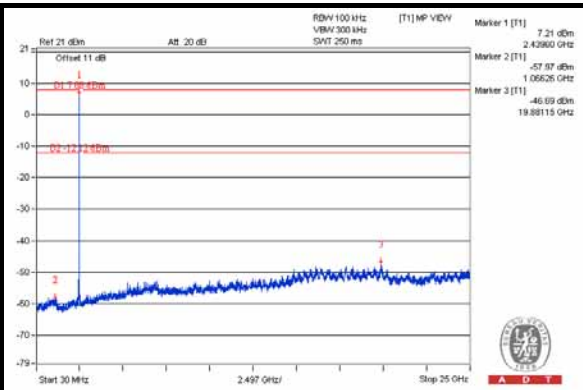
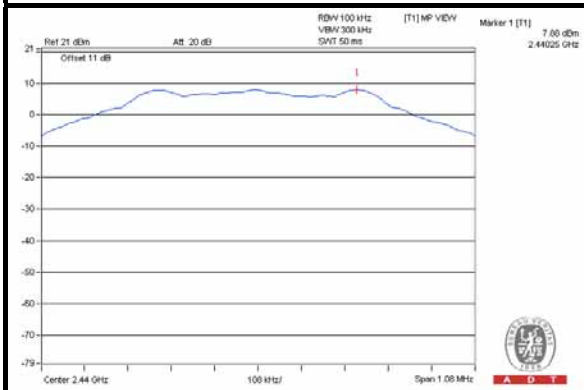

CH 39

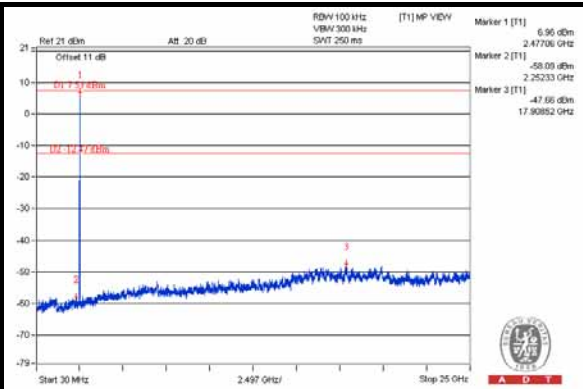
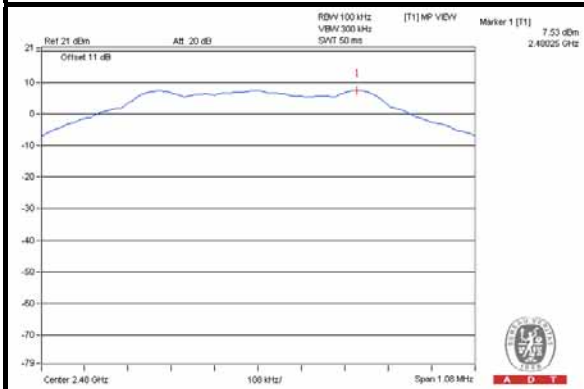

CH 0 Band edge

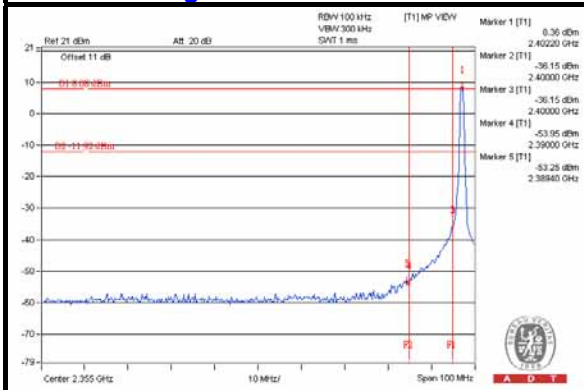

CH 39 Band edge

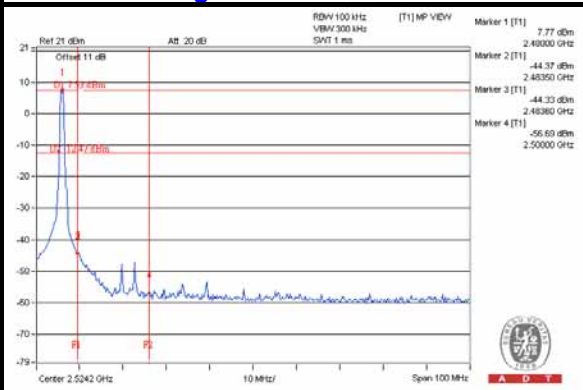



A D T

5. TEST TYPES AND RESULTS (FOR 5GHz, 5.725~5.850GHz Band)

5.1 CONDUCTED EMISSION MEASUREMENT

5.1.1 LIMITS OF CONDUCTED EMISSION MEASUREMENT

FREQUENCY OF EMISSION (MHz)	CONDUCTED LIMIT (dB μ V)	
	Quasi-peak	Average
0.15-0.5	66 to 56	56 to 46
0.5-5	56	46
5-30	60	50

- NOTE:** 1. The lower limit shall apply at the transition frequencies.
2. The limit decreases in line with the logarithm of the frequency in the range of 0.15 to 0.50 MHz.

5.1.2 TEST INSTRUMENTS

DESCRIPTION & MANUFACTURER	MODEL NO.	SERIAL NO.	CALIBRATED DATE	CALIBRATED UNTIL
Test Receiver ROHDE & SCHWARZ	ESCS 30	100375	Apr. 29, 2014	Apr. 28, 2015
Line-Impedance Stabilization Network (for EUT) SCHWARZBECK	NSLK8127	8127-522	Sep. 05, 2013	Sep. 04, 2014
Line-Impedance Stabilization Network (for Peripheral)	ENV216	100072	June 06, 2013	June 05, 2014
RF Cable (JYEBAO)	5DFB	CONCAB-003	Mar. 07, 2014	Mar. 06, 2015
50 ohms Terminator	50	EMC-03	Sep. 24, 2013	Sep. 23, 2014
Software ADT	BV ADT_Cond_V7.3.7. 3	NA	NA	NA

Note:

1. The calibration interval of the above test instruments is 12 months and the calibrations are traceable to NML/ROC and NIST/USA.
2. The test was performed in Shielded Room No. C.
3. The VCCI Con C Registration No. is C-3611.
4. Tested Date: Apr. 29, 2014

5.1.3 TEST PROCEDURES

- a. The EUT was placed 0.4 meters from the conducting wall of the shielded room with EUT being connected to the power mains through a line impedance stabilization network (LISN). Other support units were connected to the power mains through another LISN.
- b. The two LISNs provide 50 ohm/ 50uH of coupling impedance for the measuring instrument.
- c. Both lines of the power mains connected to the EUT were checked for maximum conducted interference.
- d. The frequency range from 150kHz to 30MHz was searched. Emission levels under (Limit – 20dB) were not recorded.

NOTE:

1. The resolution bandwidth of test receiver is 9kHz for Quasi-peak detection (QP) & Average detection (AV).

5.1.4 DEVIATION FROM TEST STANDARD

No deviation

5.1.5 TEST SETUP

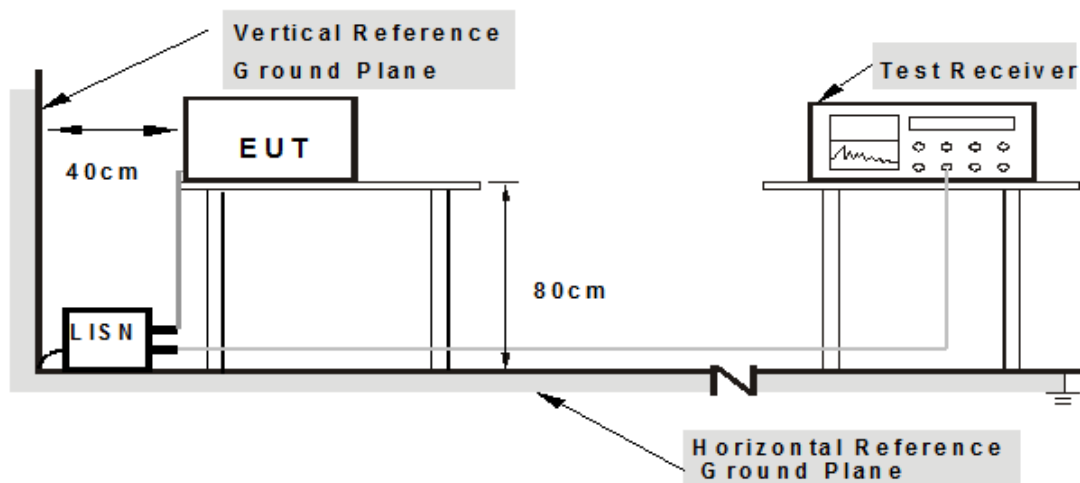

Note: 1. Support units were connected to second LISN.

For the actual test configuration, please refer to the related item – Photographs of the Test Configuration.



A D T

5.1.6 EUT OPERATING CONDITIONS

Same as the 4.1.6

5.1.7 TEST RESULTS

PHASE	Line (L)	DETECTOR FUNCTION	Quasi-Peak (QP) / Average (AV)
--------------	----------	--------------------------	--------------------------------

No	Freq.	Corr.	Reading Value		Emission Level		Limit		Margin	
	[MHz]	Factor (dB)	[dB (uV)]		[dB (uV)]		[dB (uV)]		(dB)	
			Q.P.	AV.	Q.P.	AV.	Q.P.	AV.	Q.P.	AV.
1	0.19687	0.06	49.06	39.91	49.12	39.97	63.74	53.74	-14.62	-13.77
2	0.25547	0.06	45.68	37.22	45.74	37.28	61.58	51.58	-15.83	-14.29
3	0.39219	0.07	39.94	31.87	40.01	31.94	58.02	48.02	-18.01	-16.08
4	0.50156	0.07	38.26	26.89	38.33	26.96	56.00	46.00	-17.67	-19.04
5	0.62656	0.08	38.79	25.70	38.87	25.78	56.00	46.00	-17.13	-20.22
6	3.71875	0.19	37.09	26.46	37.28	26.65	56.00	46.00	-18.72	-19.35

REMARKS:

1. Q.P. and AV. are abbreviations of quasi-peak and average individually.
2. The emission levels of other frequencies were very low against the limit.
3. Margin value = Emission Level – Limit value
4. Correction Factor = Insertion loss + Cable loss
5. Emission Level = Correction Factor + Reading Value

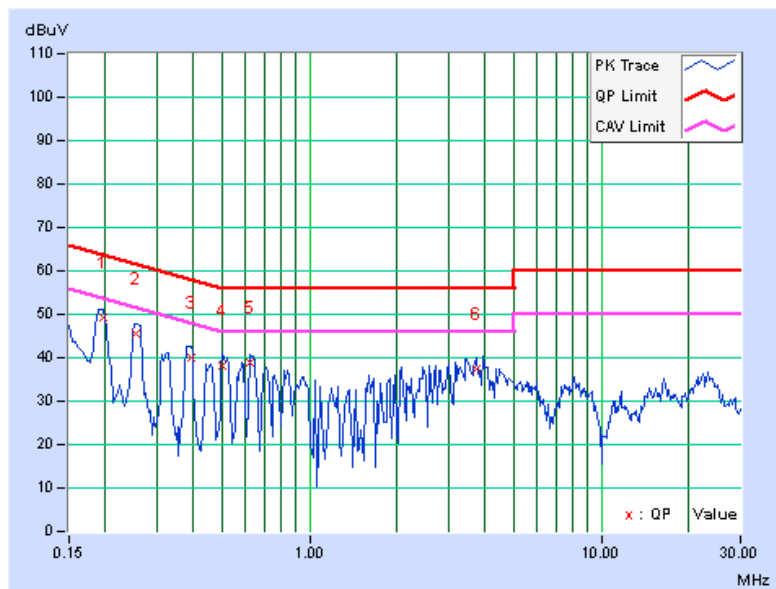

PHASE	Neutral (N)	DETECTOR FUNCTION	Quasi-Peak (QP) / Average (AV)
--------------	-------------	--------------------------	--------------------------------

No	Freq. [MHz]	Corr. Factor (dB)	Reading Value [dB (uV)]		Emission Level [dB (uV)]		Limit [dB (uV)]		Margin (dB)	
			Q.P.	AV.	Q.P.	AV.	Q.P.	AV.	Q.P.	AV.
1	0.18906	0.06	49.04	39.09	49.10	39.15	64.08	54.08	-14.98	-14.93
2	0.25938	0.06	44.56	35.96	44.62	36.02	61.45	51.45	-16.83	-15.43
3	0.44688	0.07	39.96	32.77	40.03	32.84	56.93	46.93	-16.90	-14.09
4	0.52500	0.07	39.44	29.98	39.51	30.05	56.00	46.00	-16.49	-15.95
5	0.56406	0.08	39.17	27.34	39.25	27.42	56.00	46.00	-16.75	-18.58
6	3.40234	0.18	35.21	23.45	35.39	23.63	56.00	46.00	-20.61	-22.37

REMARKS:

1. Q.P. and AV. are abbreviations of quasi-peak and average individually.
2. The emission levels of other frequencies were very low against the limit.
3. Margin value = Emission Level – Limit value
4. Correction Factor = Insertion loss + Cable loss
5. Emission Level = Correction Factor + Reading Value

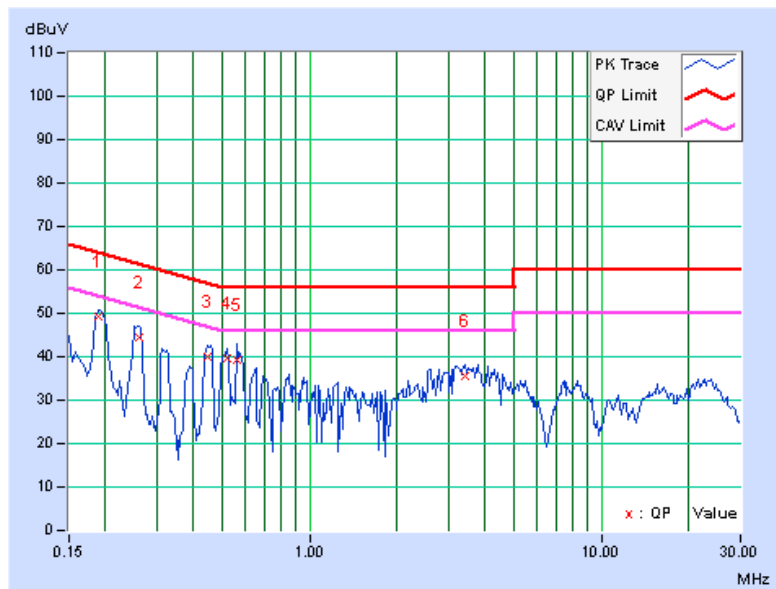



A D T

5.2 RADIATED AND BANDEGE EMISSION MEASUREMENT

5.2.1 LIMITS OF RADIATED AND BANDEGE EMISSION MEASUREMENT

Radiated emissions which fall in the restricted bands must comply with the radiated emission limits specified as below table. Other emissions shall be at least 20dB below the highest level of the desired power:

Frequencies (MHz)	Field strength (microvolts/meter)	Measurement distance (meters)
0.009-0.490	2400/F(kHz)	300
0.490-1.705	24000/F(kHz)	30
1.705-30.0	30	30
30-88	100	3
88-216	150	3
216-960	200	3
Above 960	500	3

NOTE:

1. The lower limit shall apply at the transition frequencies.
2. Emission level (dBuV/m) = 20 log Emission level (uV/m).
3. For frequencies above 1000MHz, the field strength limits are based on average detector, however, the peak field strength of any emission shall not exceed the maximum permitted average limits, specified above by more than 20dB under any condition of modulation.



A D T

5.2.2 TEST INSTRUMENTS

DESCRIPTION & MANUFACTURER	MODEL NO.	SERIAL NO.	CALIBRATED DATE	CALIBRATED UNTIL
MXE EMI Receiver Agilent	N9038A	MY51210105	Jan. 21,2014	Jan. 20,2015
Pre-Amplifier Mini-Circuits	ZFL-1000VH2 B	AMP-ZFL-03	Nov. 13, 2013	Nov. 12, 2014
Trilog Broadband Antenna SCHWARZBECK	VULB 9168	9168-360	Feb. 26, 2014	Feb. 25, 2015
RF Cable	NA	CHGCAB_001	Oct. 05, 2013	Oct. 04, 2014
Spectrum Analyzer R&S	FSV40	100964	July 15, 2013	July 14, 2014
Horn_Antenna AISI	AIH.8018	0000320091110	Nov. 18, 2013	Nov. 17, 2014
Pre-Amplifier Agilent	8449B	3008A02578	June 25, 2013	June 24, 2014
RF Cable	NA	RF104-201 RF104-203 RF104-204	Dec. 12, 2013	Dec. 11, 2014
Spectrum Analyzer Agilent	E4446A	MY48250253	Aug. 28, 2013	Aug. 27, 2014
Pre-Amplifier SPACEK LABS	SLKka-48-6	9K16	Nov. 13, 2013	Nov. 12, 2014
Horn_Antenna SCHWARZBECK	BBHA 9170	9170-424	Oct. 08, 2013	Oct. 07, 2014
Software	ADT_Radiated _V8.7.07	NA	NA	NA
Antenna Tower & Turn Table CT	NA	NA	NA	NA

Note:

1. The calibration interval of the above test instruments is 12 months and the calibrations are traceable to NML/ROC and NIST/USA.
2. The horn antenna, preamplifier (model: 8449B) are used only for the measurement of emission frequency above 1GHz if tested.
- 3 The test was performed in 966 Chamber No. G.
4. The FCC Site Registration No. is 966073.
- 5 The VCCI Site Registration No. is G-137.
- 6 The CANADA Site Registration No. is IC 7450H-2.
- 7 Tested Date: May 16 to 20, 2014

5.2.3 TEST PROCEDURES

- a. The EUT was placed on the top of a rotating table 0.8 meters above the ground at 3 meter chamber room for test. The table was rotated 360 degrees to determine the position of the highest radiation.
- b. The EUT was set 3 meters away from the interference-receiving antenna, which was mounted on the top of a variable-height antenna tower.
- c. The height of antenna is varied from one meter to four meters above the ground to determine the maximum value of the field strength. Both horizontal and vertical polarizations of the antenna are set to make the measurement.
- d. For each suspected emission, the EUT was arranged to its worst case and then the antenna was tuned to heights from 1 meter to 4 meters and the rotatable table was turned from 0 degrees to 360 degrees to find the maximum reading.
- e. The test-receiver system was set to quasi-peak detect function and specified bandwidth with maximum hold mode when the test frequency is below 1 GHz.
- f. The test-receiver system was set to peak and average detect function and specified bandwidth with maximum hold mode when the test frequency is above 1 GHz. If the peak reading value also meets average limit, measurement with the average detector is unnecessary.

Note:

1. The resolution bandwidth and video bandwidth of test receiver/spectrum analyzer is 120kHz for Quasi-peak detection (QP) at frequency below 1GHz.
2. The resolution bandwidth of test receiver/spectrum analyzer is 1 MHz and the video bandwidth is 3 MHz for Peak detection (PK) at frequency above 1GHz.
3. The resolution bandwidth of test receiver/spectrum analyzer is 1MHz and the video bandwidth is 3MHz for RMS Average (Duty cycle < 98%) for Average detection (AV) at frequency above 1GHz, then the measurement results was added to a correction factor ($10 \log(1/\text{duty cycle})$).
4. The resolution bandwidth of test receiver/spectrum analyzer is 1MHz and the video bandwidth is 10Hz (Duty cycle $\geq 98\%$) for Average detection (AV) at frequency above 1GHz.
5. All modes of operation were investigated and the worst-case emissions are reported.

5.2.4 DEVIATION FROM TEST STANDARD

No deviation

5.2.5 TEST SETUP

<Frequency Range below 1GHz>

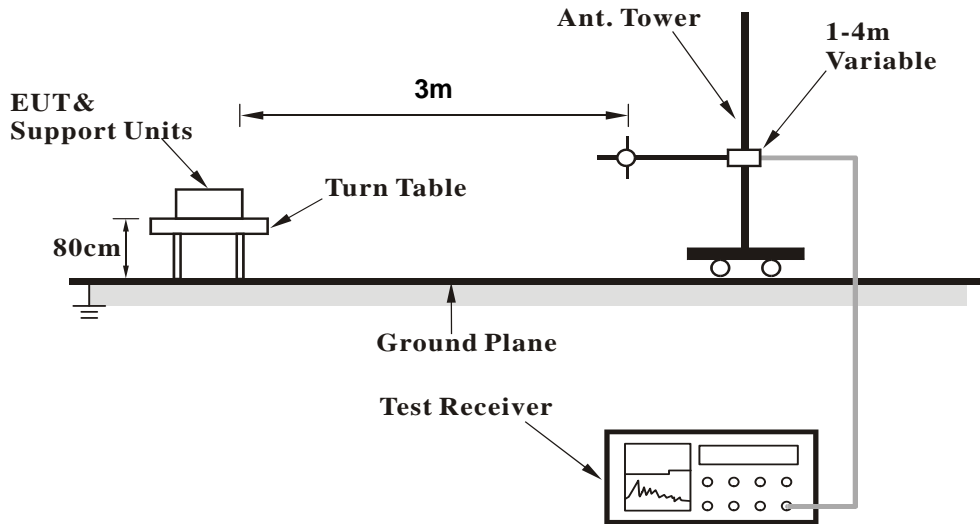

<Frequency Range above 1GHz>

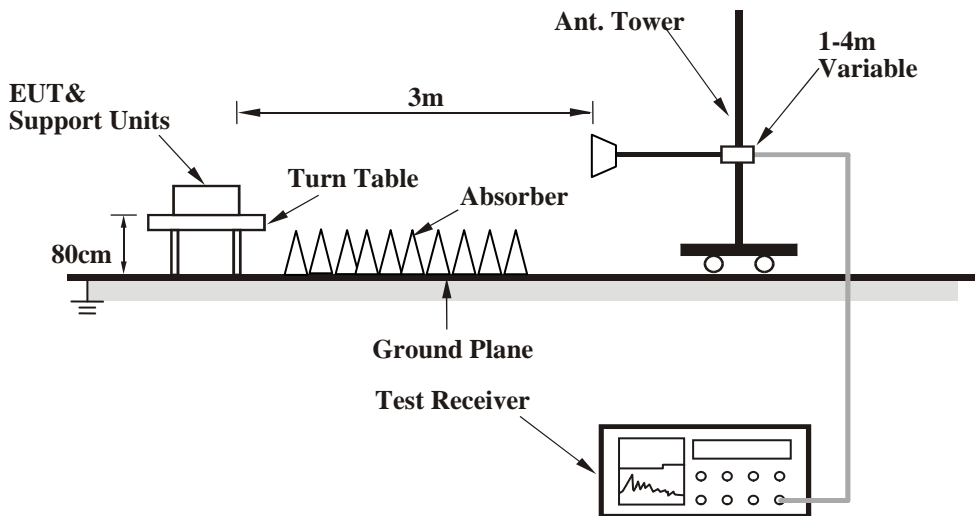

For the actual test configuration, please refer to the related item – Photographs of the Test Configuration.

5.2.6 EUT OPERATING CONDITIONS

Same as the 4.1.6



A D T

5.2.7 TEST RESULTS

BELOW 1GHz WORST-CASE DATA

802.11a

CHANNEL	TX Channel 149	DETECTOR FUNCTION	Quasi-Peak (QP)
FREQUENCY RANGE	30MHz ~ 1GHz		

ANTENNA POLARITY & TEST DISTANCE: HORIZONTAL AT 3 M

NO.	FREQ. (MHz)	EMISSION LEVEL (dBuV/m)	LIMIT (dBuV/m)	MARGIN (dB)	ANTENNA HEIGHT (m)	TABLE ANGLE (Degree)	RAW VALUE (dBuV)	CORRECTION FACTOR (dB/m)
1	47.88	35.4 QP	40.0	-4.6	1.24 H	201	48.84	-13.48
2	72.11	33.2 QP	40.0	-6.8	1.21 H	146	49.32	-16.09
3	311.94	42.3 QP	46.0	-3.7	1.11 H	104	54.32	-11.98
4	359.98	38.3 QP	46.0	-7.7	1.07 H	85	49.14	-10.80
5	527.97	36.2 QP	46.0	-9.8	1.07 H	275	43.01	-6.80
6	935.99	40.0 QP	46.0	-6.0	1.24 H	112	39.15	0.86

ANTENNA POLARITY & TEST DISTANCE: VERTICAL AT 3 M

NO.	FREQ. (MHz)	EMISSION LEVEL (dBuV/m)	LIMIT (dBuV/m)	MARGIN (dB)	ANTENNA HEIGHT (m)	TABLE ANGLE (Degree)	RAW VALUE (dBuV)	CORRECTION FACTOR (dB/m)
1	60.51	34.5 QP	40.0	-5.5	1.24 V	175	48.70	-14.19
2	312.02	37.5 QP	46.0	-8.5	1.34 V	204	49.50	-11.98
3	432.00	41.4 QP	46.0	-4.6	1.07 V	199	50.03	-8.61
4	527.96	39.0 QP	46.0	-7.0	1.24 V	197	45.82	-6.80
5	647.94	36.2 QP	46.0	-9.8	1.34 V	98	40.30	-4.09
6	935.92	42.6 QP	46.0	-3.4	1.19 V	285	41.78	0.86

REMARKS:

1. Emission Level(dBuV/m) = Raw Value(dBuV) + Correction Factor(dB/m)
2. Correction Factor(dB/m) = Antenna Factor(dB/m) + Cable Factor(dB) – Pre-Amplifier Factor(dB)
3. The other emission levels were very low against the limit.
4. Margin value = Emission Level – Limit value



A D T

ABOVE 1GHz DATA

802.11a

CHANNEL	TX Channel 149	DETECTOR FUNCTION	Peak (PK)
FREQUENCY RANGE	1GHz ~ 40GHz		Average (AV)

ANTENNA POLARITY & TEST DISTANCE: HORIZONTAL AT 3 M								
NO.	FREQ. (MHz)	EMISSION LEVEL (dBuV/m)	LIMIT (dBuV/m)	MARGIN (dB)	ANTENNA HEIGHT (m)	TABLE ANGLE (Degree)	RAW VALUE (dBuV)	CORRECTION FACTOR (dB/m)
1	*5745.00	111.5 PK			1.49 H	41	101.56	9.94
2	*5745.00	102.2 AV			1.49 H	41	92.26	9.94
3	7660.00	52.6 PK	74.0	-21.4	1.31 H	224	37.99	14.61
4	7660.00	40.9 AV	54.0	-13.1	1.31 H	224	26.29	14.61
5	11490.00	54.6 PK	74.0	-19.4	1.41 H	233	38.02	16.58
6	11490.00	43.8 AV	54.0	-10.2	1.41 H	233	27.22	16.58

ANTENNA POLARITY & TEST DISTANCE: VERTICAL AT 3 M								
NO.	FREQ. (MHz)	EMISSION LEVEL (dBuV/m)	LIMIT (dBuV/m)	MARGIN (dB)	ANTENNA HEIGHT (m)	TABLE ANGLE (Degree)	RAW VALUE (dBuV)	CORRECTION FACTOR (dB/m)
1	*5745.00	108.2 PK			1.10 V	331	98.26	9.94
2	*5745.00	98.7 AV			1.10 V	331	88.76	9.94
3	7660.00	53.4 PK	74.0	-20.6	1.31 V	51	38.79	14.61
4	7660.00	40.8 AV	54.0	-13.2	1.31 V	51	26.19	14.61
5	11490.00	55.5 PK	74.0	-18.5	1.81 V	21	38.92	16.58
6	11490.00	44.7 AV	54.0	-9.3	1.81 V	21	28.12	16.58

REMARKS:

1. Emission Level(dBuV/m) = Raw Value(dBuV) + Correction Factor(dB/m)
2. Correction Factor(dB/m) = Antenna Factor(dB/m) + Cable Factor(dB) – Pre-Amplifier Factor(dB)
3. The other emission levels were very low against the limit.
4. Margin value = Emission Level – Limit value
5. " * ": Fundamental frequency.



A D T

CHANNEL	TX Channel 157	DETECTOR FUNCTION	Peak (PK)
FREQUENCY RANGE	1GHz ~ 40GHz		Average (AV)

ANTENNA POLARITY & TEST DISTANCE: HORIZONTAL AT 3 M								
NO.	FREQ. (MHz)	EMISSION LEVEL (dBuV/m)	LIMIT (dBuV/m)	MARGIN (dB)	ANTENNA HEIGHT (m)	TABLE ANGLE (Degree)	RAW VALUE (dBuV)	CORRECTION FACTOR (dB/m)
1	*5785.00	111.5 PK			1.26 H	42	101.49	10.01
2	*5785.00	102.3 AV			1.26 H	42	92.29	10.01
3	11570.00	54.0 PK	74.0	-20.0	1.45 H	220	37.36	16.64
4	11570.00	43.1 AV	54.0	-10.9	1.45 H	220	26.46	16.64
ANTENNA POLARITY & TEST DISTANCE: VERTICAL AT 3 M								
NO.	FREQ. (MHz)	EMISSION LEVEL (dBuV/m)	LIMIT (dBuV/m)	MARGIN (dB)	ANTENNA HEIGHT (m)	TABLE ANGLE (Degree)	RAW VALUE (dBuV)	CORRECTION FACTOR (dB/m)
1	*5785.00	108.6 PK			1.02 V	320	98.59	10.01
2	*5785.00	99.1 AV			1.02 V	320	89.09	10.01
3	11570.00	55.4 PK	74.0	-18.6	1.83 V	12	38.76	16.64
4	11570.00	44.5 AV	54.0	-9.5	1.83 V	12	27.86	16.64

REMARKS:

1. Emission Level(dBuV/m) = Raw Value(dBuV) + Correction Factor(dB/m)
2. Correction Factor(dB/m) = Antenna Factor(dB/m) + Cable Factor(dB) – Pre-Amplifier Factor(dB)
3. The other emission levels were very low against the limit.
4. Margin value = Emission Level – Limit value
5. " * ": Fundamental frequency.



A D T

CHANNEL	TX Channel 165	DETECTOR FUNCTION	Peak (PK)
FREQUENCY RANGE	1GHz ~ 40GHz		Average (AV)

ANTENNA POLARITY & TEST DISTANCE: HORIZONTAL AT 3 M

NO.	FREQ. (MHz)	EMISSION LEVEL (dBuV/m)	LIMIT (dBuV/m)	MARGIN (dB)	ANTENNA HEIGHT (m)	TABLE ANGLE (Degree)	RAW VALUE (dBuV)	CORRECTION FACTOR (dB/m)
1	*5825.00	110.8 PK			1.18 H	49	100.70	10.10
2	*5825.00	102.1 AV			1.18 H	49	92.00	10.10
3	11650.00	53.4 PK	74.0	-20.6	1.44 H	222	36.55	16.85
4	11650.00	42.8 AV	54.0	-11.2	1.44 H	222	25.95	16.85

ANTENNA POLARITY & TEST DISTANCE: VERTICAL AT 3 M

NO.	FREQ. (MHz)	EMISSION LEVEL (dBuV/m)	LIMIT (dBuV/m)	MARGIN (dB)	ANTENNA HEIGHT (m)	TABLE ANGLE (Degree)	RAW VALUE (dBuV)	CORRECTION FACTOR (dB/m)
1	*5825.00	107.8 PK			1.11 V	318	97.70	10.10
2	*5825.00	98.3 AV			1.11 V	318	88.20	10.10
3	11650.00	55.5 PK	74.0	-18.5	1.86 V	22	38.65	16.85
4	11650.00	44.8 AV	54.0	-9.2	1.86 V	22	27.95	16.85

REMARKS:

1. Emission Level(dBuV/m) = Raw Value(dBuV) + Correction Factor(dB/m)
2. Correction Factor(dB/m) = Antenna Factor(dB/m) + Cable Factor(dB) – Pre-Amplifier Factor(dB)
3. The other emission levels were very low against the limit.
4. Margin value = Emission Level – Limit value
5. " * " : Fundamental frequency.



A D T

802.11ac (VHT20)

CHANNEL	TX Channel 149	DETECTOR FUNCTION	Peak (PK)
FREQUENCY RANGE	1GHz ~ 40GHz		Average (AV)

ANTENNA POLARITY & TEST DISTANCE: HORIZONTAL AT 3 M

NO.	FREQ. (MHz)	EMISSION LEVEL (dBuV/m)	LIMIT (dBuV/m)	MARGIN (dB)	ANTENNA HEIGHT (m)	TABLE ANGLE (Degree)	RAW VALUE (dBuV)	CORRECTION FACTOR (dB/m)
1	*5745.00	110.2 PK			1.48 H	37	100.26	9.94
2	*5745.00	101.5 AV			1.48 H	37	91.56	9.94
3	11490.00	54.4 PK	74.0	-19.6	1.46 H	214	37.82	16.58
4	11490.00	44.0 AV	54.0	-10.0	1.46 H	214	27.42	16.58

ANTENNA POLARITY & TEST DISTANCE: VERTICAL AT 3 M

NO.	FREQ. (MHz)	EMISSION LEVEL (dBuV/m)	LIMIT (dBuV/m)	MARGIN (dB)	ANTENNA HEIGHT (m)	TABLE ANGLE (Degree)	RAW VALUE (dBuV)	CORRECTION FACTOR (dB/m)
1	*5745.00	108.6 PK			1.05 V	316	98.66	9.94
2	*5745.00	99.0 AV			1.05 V	316	89.06	9.94
3	11490.00	55.3 PK	74.0	-18.7	1.83 V	32	38.72	16.58
4	11490.00	44.3 AV	54.0	-9.7	1.83 V	32	27.72	16.58

REMARKS:

1. Emission Level(dBuV/m) = Raw Value(dBuV) + Correction Factor(dB/m)
2. Correction Factor(dB/m) = Antenna Factor(dB/m) + Cable Factor(dB) – Pre-Amplifier Factor(dB)
3. The other emission levels were very low against the limit.
4. Margin value = Emission Level – Limit value
5. " * ": Fundamental frequency.



A D T

CHANNEL	TX Channel 157	DETECTOR FUNCTION	Peak (PK)
FREQUENCY RANGE	1GHz ~ 40GHz		Average (AV)

ANTENNA POLARITY & TEST DISTANCE: HORIZONTAL AT 3 M

NO.	FREQ. (MHz)	EMISSION LEVEL (dBuV/m)	LIMIT (dBuV/m)	MARGIN (dB)	ANTENNA HEIGHT (m)	TABLE ANGLE (Degree)	RAW VALUE (dBuV)	CORRECTION FACTOR (dB/m)
1	*5785.00	111.9 PK			1.53 H	39	101.89	10.01
2	*5785.00	102.6 AV			1.53 H	39	92.59	10.01
3	11570.00	54.8 PK	74.0	-19.2	1.45 H	228	38.16	16.64
4	11570.00	44.2 AV	54.0	-9.8	1.45 H	228	27.56	16.64

ANTENNA POLARITY & TEST DISTANCE: VERTICAL AT 3 M

NO.	FREQ. (MHz)	EMISSION LEVEL (dBuV/m)	LIMIT (dBuV/m)	MARGIN (dB)	ANTENNA HEIGHT (m)	TABLE ANGLE (Degree)	RAW VALUE (dBuV)	CORRECTION FACTOR (dB/m)
1	*5785.00	108.2 PK			1.14 V	337	98.19	10.01
2	*5785.00	98.9 AV			1.14 V	337	88.89	10.01
3	11570.00	56.0 PK	74.0	-18.0	1.78 V	7	39.36	16.64
4	11570.00	45.0 AV	54.0	-9.0	1.78 V	7	28.36	16.64

REMARKS:

1. Emission Level(dBuV/m) = Raw Value(dBuV) + Correction Factor(dB/m)
2. Correction Factor(dB/m) = Antenna Factor(dB/m) + Cable Factor(dB) – Pre-Amplifier Factor(dB)
3. The other emission levels were very low against the limit.
4. Margin value = Emission Level – Limit value
5. " * " : Fundamental frequency.



A D T

CHANNEL	TX Channel 165	DETECTOR FUNCTION	Peak (PK)
FREQUENCY RANGE	1GHz ~ 40GHz		Average (AV)

ANTENNA POLARITY & TEST DISTANCE: HORIZONTAL AT 3 M

NO.	FREQ. (MHz)	EMISSION LEVEL (dBuV/m)	LIMIT (dBuV/m)	MARGIN (dB)	ANTENNA HEIGHT (m)	TABLE ANGLE (Degree)	RAW VALUE (dBuV)	CORRECTION FACTOR (dB/m)
1	*5825.00	111.1 PK			1.41 H	36	101.00	10.10
2	*5825.00	102.0 AV			1.41 H	36	91.90	10.10
3	11650.00	54.5 PK	74.0	-19.5	1.35 H	235	37.65	16.85
4	11650.00	43.9 AV	54.0	-10.1	1.35 H	235	27.05	16.85

ANTENNA POLARITY & TEST DISTANCE: VERTICAL AT 3 M

NO.	FREQ. (MHz)	EMISSION LEVEL (dBuV/m)	LIMIT (dBuV/m)	MARGIN (dB)	ANTENNA HEIGHT (m)	TABLE ANGLE (Degree)	RAW VALUE (dBuV)	CORRECTION FACTOR (dB/m)
1	*5825.00	108.0 PK			1.08 V	317	97.90	10.10
2	*5825.00	98.5 AV			1.08 V	317	88.40	10.10
3	11650.00	55.1 PK	74.0	-18.9	1.84 V	36	38.25	16.85
4	11650.00	44.5 AV	54.0	-9.5	1.84 V	36	27.65	16.85

REMARKS:

1. Emission Level(dBuV/m) = Raw Value(dBuV) + Correction Factor(dB/m)
2. Correction Factor(dB/m) = Antenna Factor(dB/m) + Cable Factor(dB) – Pre-Amplifier Factor(dB)
3. The other emission levels were very low against the limit.
4. Margin value = Emission Level – Limit value
5. " * ": Fundamental frequency.



A D T

802.11ac (VHT40)

CHANNEL	TX Channel 151	DETECTOR FUNCTION	Peak (PK)
FREQUENCY RANGE	1GHz ~ 40GHz		Average (AV)

ANTENNA POLARITY & TEST DISTANCE: HORIZONTAL AT 3 M

NO.	FREQ. (MHz)	EMISSION LEVEL (dBuV/m)	LIMIT (dBuV/m)	MARGIN (dB)	ANTENNA HEIGHT (m)	TABLE ANGLE (Degree)	RAW VALUE (dBuV)	CORRECTION FACTOR (dB/m)
1	*5755.00	108.8 PK			1.36 H	18	98.84	9.96
2	*5755.00	99.4 AV			1.36 H	18	89.44	9.96
3	11510.00	53.7 PK	74.0	-20.3	1.32 H	236	37.14	16.56
4	11510.00	43.3 AV	54.0	-10.7	1.32 H	236	26.74	16.56

ANTENNA POLARITY & TEST DISTANCE: VERTICAL AT 3 M

NO.	FREQ. (MHz)	EMISSION LEVEL (dBuV/m)	LIMIT (dBuV/m)	MARGIN (dB)	ANTENNA HEIGHT (m)	TABLE ANGLE (Degree)	RAW VALUE (dBuV)	CORRECTION FACTOR (dB/m)
1	*5755.00	105.1 PK			1.15 V	320	95.14	9.96
2	*5755.00	95.8 AV			1.15 V	320	85.84	9.96
3	11510.00	55.2 PK	74.0	-18.8	1.86 V	8	38.64	16.56
4	11510.00	44.6 AV	54.0	-9.4	1.86 V	8	28.04	16.56

REMARKS:

1. Emission Level(dBuV/m) = Raw Value(dBuV) + Correction Factor(dB/m)
2. Correction Factor(dB/m) = Antenna Factor(dB/m) + Cable Factor(dB) – Pre-Amplifier Factor(dB)
3. The other emission levels were very low against the limit.
4. Margin value = Emission Level – Limit value
5. " * ": Fundamental frequency.



A D T

CHANNEL	TX Channel 159	DETECTOR FUNCTION	Peak (PK)
FREQUENCY RANGE	1GHz ~ 40GHz		Average (AV)

ANTENNA POLARITY & TEST DISTANCE: HORIZONTAL AT 3 M								
NO.	FREQ. (MHz)	EMISSION LEVEL (dBuV/m)	LIMIT (dBuV/m)	MARGIN (dB)	ANTENNA HEIGHT (m)	TABLE ANGLE (Degree)	RAW VALUE (dBuV)	CORRECTION FACTOR (dB/m)
1	*5795.00	108.6 PK			1.29 H	11	98.59	10.01
2	*5795.00	99.9 AV			1.29 H	11	89.89	10.01
3	11590.00	53.1 PK	74.0	-20.9	1.26 H	215	36.43	16.67
4	11590.00	43.3 AV	54.0	-10.7	1.26 H	215	26.63	16.67
ANTENNA POLARITY & TEST DISTANCE: VERTICAL AT 3 M								
NO.	FREQ. (MHz)	EMISSION LEVEL (dBuV/m)	LIMIT (dBuV/m)	MARGIN (dB)	ANTENNA HEIGHT (m)	TABLE ANGLE (Degree)	RAW VALUE (dBuV)	CORRECTION FACTOR (dB/m)
1	*5795.00	104.2 PK			1.13 V	297	94.19	10.01
2	*5795.00	95.3 AV			1.13 V	297	85.29	10.01
3	11590.00	55.4 PK	74.0	-18.6	1.79 V	11	38.73	16.67
4	11590.00	44.8 AV	54.0	-9.2	1.79 V	11	28.13	16.67

REMARKS:

1. Emission Level(dBuV/m) = Raw Value(dBuV) + Correction Factor(dB/m)
2. Correction Factor(dB/m) = Antenna Factor(dB/m) + Cable Factor(dB) – Pre-Amplifier Factor(dB)
3. The other emission levels were very low against the limit.
4. Margin value = Emission Level – Limit value
5. " * ": Fundamental frequency.



A D T

802.11ac (VHT80)

CHANNEL	TX Channel 155	DETECTOR FUNCTION	Peak (PK)
FREQUENCY RANGE	1GHz ~ 40GHz		Average (AV)

ANTENNA POLARITY & TEST DISTANCE: HORIZONTAL AT 3 M

NO.	FREQ. (MHz)	EMISSION LEVEL (dBuV/m)	LIMIT (dBuV/m)	MARGIN (dB)	ANTENNA HEIGHT (m)	TABLE ANGLE (Degree)	RAW VALUE (dBuV)	CORRECTION FACTOR (dB/m)
1	*5775.00	106.5 PK			1.41 H	24	96.51	9.99
2	*5775.00	97.7 AV			1.41 H	24	87.71	9.99
3	11550.00	52.3 PK	74.0	-21.7	1.28 H	217	35.68	16.62
4	11550.00	42.4 AV	54.0	-11.6	1.28 H	217	25.78	16.62

ANTENNA POLARITY & TEST DISTANCE: VERTICAL AT 3 M

NO.	FREQ. (MHz)	EMISSION LEVEL (dBuV/m)	LIMIT (dBuV/m)	MARGIN (dB)	ANTENNA HEIGHT (m)	TABLE ANGLE (Degree)	RAW VALUE (dBuV)	CORRECTION FACTOR (dB/m)
1	*5775.00	103.1 PK			1.13 V	302	93.11	9.99
2	*5775.00	94.2 AV			1.13 V	302	84.21	9.99
3	11550.00	55.7 PK	74.0	-18.3	1.84 V	25	39.08	16.62
4	11550.00	45.1 AV	54.0	-8.9	1.84 V	25	28.48	16.62

REMARKS:

1. Emission Level(dBuV/m) = Raw Value(dBuV) + Correction Factor(dB/m)
2. Correction Factor(dB/m) = Antenna Factor(dB/m) + Cable Factor(dB) – Pre-Amplifier Factor(dB)
3. The other emission levels were very low against the limit.
4. Margin value = Emission Level – Limit value
5. " * ": Fundamental frequency.

5.3 6dB BANDWIDTH MEASUREMENT

5.3.1 LIMITS OF 6dB BANDWIDTH MEASUREMENT

The minimum of 6dB Bandwidth Measurement is 0.5 MHz.

5.3.2 TEST INSTRUMENTS

DESCRIPTION & MANUFACTURER	MODEL NO.	SERIAL NO.	CALIBRATED DATE	CALIBRATED UNTIL
SPECTRUM ANALYZER R&S	FSV 40	100964	July 15, 2013	July 14, 2014

Note:

1. The calibration interval of the above test instruments is 12 months and the calibrations are traceable to NML/ROC and NIST/USA.
2. Tested date : May 20, 2014

5.3.3 TEST PROCEDURE

1. Set resolution bandwidth (RBW) = 100kHz
2. Set the video bandwidth (VBW) $\geq 3 \times$ RBW, Detector = Peak.
3. Trace mode = max hold.
4. Sweep = auto couple.
5. Measure the maximum width of the emission that is constrained by the frequencies associated with the two amplitude points (upper and lower) that are attenuated by 6 dB relative to the maximum level measured in the fundamental emission

5.3.4 DEVIATION FROM TEST STANDARD

No deviation

5.3.5 TEST SETUP

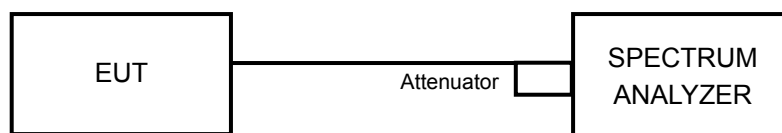

5.3.6 EUT OPERATING CONDITIONS

The software provided by client to enable the EUT under transmission condition continuously at lowest, middle and highest channel frequencies individually.



A D T

5.3.7 TEST RESULTS

802.11a

CHANNEL	CHANNEL FREQUENCY (MHz)	6dB BANDWIDTH (MHz)		MINIMUM LIMIT (MHz)	PASS / FAIL
		CHAIN 0	CHAIN 1		
149	5745	16.59	16.51	0.5	PASS
157	5785	16.58	16.57	0.5	PASS
165	5825	16.59	16.56	0.5	PASS

802.11ac (VHT20)

CHANNEL	CHANNEL FREQUENCY (MHz)	6dB BANDWIDTH (MHz)		MINIMUM LIMIT (MHz)	PASS / FAIL
		CHAIN 0	CHAIN 1		
149	5745	17.56	17.73	0.5	PASS
157	5785	17.64	17.74	0.5	PASS
165	5825	17.74	17.72	0.5	PASS

802.11ac (VHT40)

CHANNEL	CHANNEL FREQUENCY (MHz)	6dB BANDWIDTH (MHz)		MINIMUM LIMIT (MHz)	PASS / FAIL
		CHAIN 0	CHAIN 1		
151	5755	36.54	36.48	0.5	PASS
159	5795	36.52	36.45	0.5	PASS

802.11ac (VHT80)

CHANNEL	CHANNEL FREQUENCY (MHz)	6dB BANDWIDTH (MHz)		MINIMUM LIMIT (MHz)	PASS / FAIL
		CHAIN 0	CHAIN 1		
155	5775	76.48	76.71	0.5	PASS



A D T

SPECTRUM PLOT OF WORST VALUE

802.11a / Chain (1) : CH149

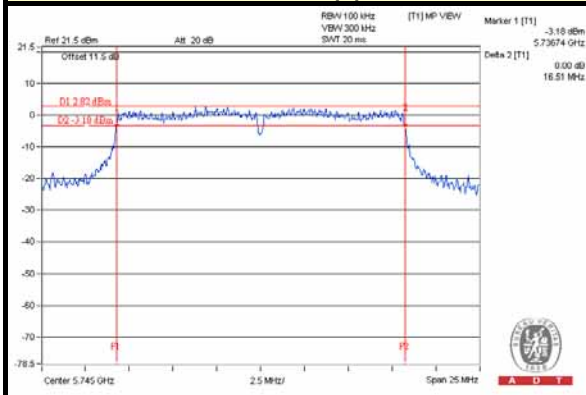

802.11ac (VHT20) / Chain(0) : CH149

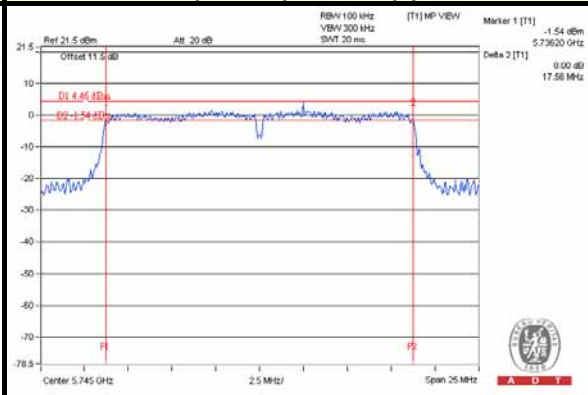

802.11ac (VHT40) / Chain(1) : CH159

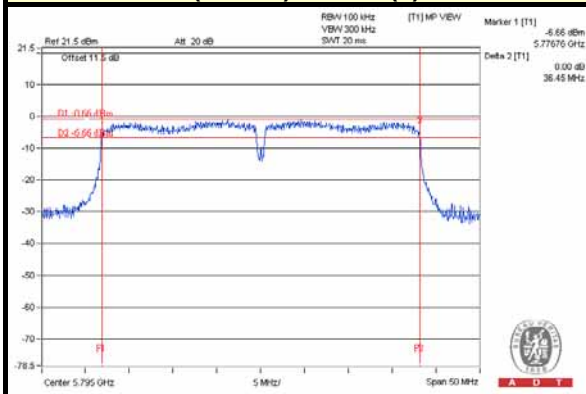

802.11ac (VHT80) / Chain(0) : CH155

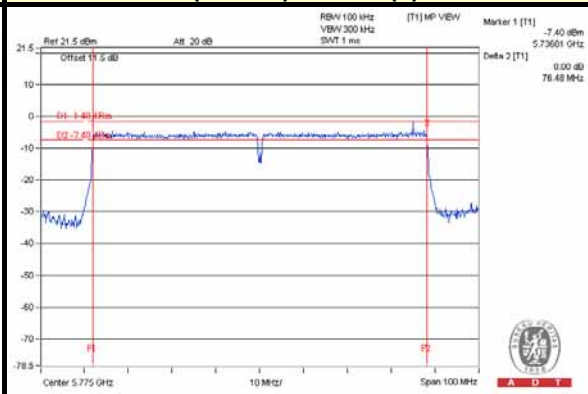



A D T

5.4 CONDUCTED OUTPUT POWER MEASUREMENT

5.4.1 LIMITS OF CONDUCTED OUTPUT POWER MEASUREMENT

For systems using digital modulation in the 5725 –5850 MHz band: 1 Watt (30dBm)

Per KDB 662911 D01 Multiple Transmitter Output Method of conducted output power measurement on IEEE 802.11 devices,

Array Gain = 0 dB (i.e., no array gain) for $NANT \leq 4$;

Array Gain = 0 dB (i.e., no array gain) for channel widths ≥ 40 MHz for any NANT;

Array Gain = $5 \log(NANT/NSS)$ dB or 3 dB, whichever is less for 20-MHz channel widths with $NANT \geq 5$.

For power measurements on all other devices: Array Gain = $10 \log(NANT/NSS)$ dB.

5.4.2 INSTRUMENTS

For 802.11a, 802.11ac (VHT20), 802.11ac (VHT40)

DESCRIPTION & MANUFACTURER	MODEL NO.	SERIAL NO.	CALIBRATED DATE	CALIBRATED UNTIL
Power meter Anritsu	ML2495A	1014008	Apr. 30, 2014	Apr. 29, 2015
Power sensor Anritsu	MA2411B	0917122	Apr. 30, 2014	Apr. 29, 2015

Note:

1. The calibration interval of the above test instruments is 12 months and the calibrations are traceable to NML/ROC and NIST/USA.
2. Tested date : May 20, 2014

For 802.11ac (VHT80)

DESCRIPTION & MANUFACTURER	MODEL NO.	SERIAL NO.	CALIBRATED DATE	CALIBRATED UNTIL
SPECTRUM ANALYZER R&S	FSV 40	100964	July 15, 2013	July 14, 2014

Note:

1. The calibration interval of the above test instruments is 12 months and the calibrations are traceable to NML/ROC and NIST/USA.
2. Tested date : May 20, 2014



A D T

5.4.3 TEST PROCEDURES

For 802.11a, 802.11ac (VHT20), 802.11ac (VHT40)

The peak / average power sensor was used on the output port of the EUT. A power meter was used to read the response of the peak / average power sensor. Record the peak power level.

For 802.11ac (VHT80)

Follow FCC KDB 558074 DTS test procedure:

Measurement Procedure Peak 2

1. Set the RBW = 1 MHz.
2. Set the VBW \geq 3 RBW.
3. Set the span \geq 1.5 x DTS bandwidth.
4. Detector = peak.
5. Sweep time = auto couple.
6. Trace mode = max hold.
7. Allow trace to fully stabilize.
8. Use the spectrum analyzer's integrated band power measurement function with band limits set equal to the DTS bandwidth edges.

5.4.4 DEVIATION FROM TEST STANDARD

No deviation.

5.4.5 TEST SETUP

For 802.11a, 802.11ac (VHT20), 802.11ac (VHT40)

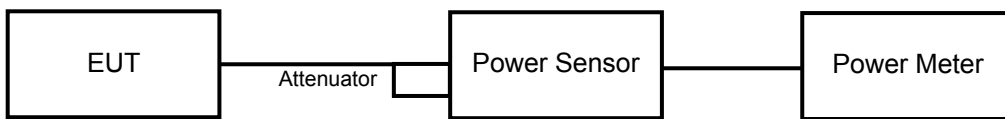

For 802.11ac (VHT80)

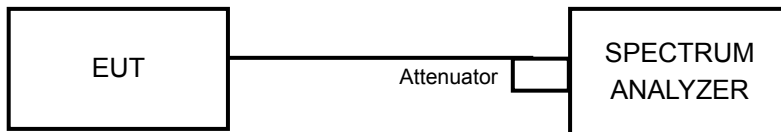

5.4.6 EUT OPERATING CONDITIONS

Same as Item 5.3.6

5.4.7 TEST RESULTS

FOR PEAK POWER

802.11a

CHANNEL	FREQUENCY (MHz)	PEAK POWER (dBm)		TOTAL POWER (mW)	TOTAL POWER (dBm)	LIMIT (dBm)	PASS / FAIL
		CHAIN 0	CHAIN 1				
149	5745	22.49	22.91	372.853	25.72	30	PASS
157	5785	22.31	22.92	366.1	25.64	30	PASS
165	5825	22.32	22.95	367.85	25.66	30	PASS

802.11ac (VHT20)

CHANNEL	FREQUENCY (MHz)	PEAK POWER (dBm)		TOTAL POWER (mW)	TOTAL POWER (dBm)	LIMIT (dBm)	PASS / FAIL
		CHAIN 0	CHAIN 1				
149	5745	22.46	22.87	369.84	25.68	30	PASS
157	5785	22.31	23.01	370.202	25.68	30	PASS
165	5825	22.27	22.91	364.089	25.61	30	PASS

802.11ac (VHT40)

CHANNEL	FREQUENCY (MHz)	PEAK POWER (dBm)		TOTAL POWER (mW)	TOTAL POWER (dBm)	LIMIT (dBm)	PASS / FAIL
		CHAIN 0	CHAIN 1				
151	5755	22.02	22.45	335.013	25.25	30	PASS
159	5795	21.57	22.54	323.022	25.09	30	PASS

802.11ac (VHT80)

CHANNEL	FREQUENCY (MHz)	PEAK POWER (dBm)		TOTAL POWER (mW)	TOTAL POWER (dBm)	LIMIT (dBm)	PASS / FAIL
		CHAIN 0	CHAIN 1				
155	5775	23.97	24.66	541.874	27.34	30	PASS



A D T

FOR AVERAGE POWER

802.11a

CHANNEL	FREQUENCY (MHz)	AVERAGE POWER (dBm)		TOTAL POWER (mW)	TOTAL POWER (dBm)
		CHAIN 0	CHAIN 1		
149	5745	15.13	15.33	66.703	18.24
157	5785	14.72	15.31	63.611	18.04
165	5825	14.73	15.29	63.523	18.03

802.11n (VHT20)

CHANNEL	FREQUENCY (MHz)	AVERAGE POWER (dBm)		TOTAL POWER (mW)	TOTAL POWER (dBm)
		CHAIN 0	CHAIN 1		
149	5745	15.48	15.76	72.988	18.63
157	5785	14.96	15.56	67.308	18.28
165	5825	14.75	15.54	65.664	18.17

802.11n (VHT40)

CHANNEL	FREQUENCY (MHz)	AVERAGE POWER (dBm)		TOTAL POWER (mW)	TOTAL POWER (dBm)
		CHAIN 0	CHAIN 1		
151	5755	14.51	14.92	59.295	17.73
159	5795	14.41	14.82	57.945	17.63

802.11n (VHT80)

CHANNEL	FREQUENCY (MHz)	AVERAGE POWER (dBm)		TOTAL POWER (mW)	TOTAL POWER (dBm)
		CHAIN 0	CHAIN 1		
155	5775	16.51	16.54	89.853	19.54

5.5 POWER SPECTRAL DENSITY MEASUREMENT

5.5.1 LIMITS OF POWER SPECTRAL DENSITY MEASUREMENT

The Maximum of Power Spectral Density Measurement is 8dBm.

5.5.2 TEST INSTRUMENTS

DESCRIPTION & MANUFACTURER	MODEL NO.	SERIAL NO.	CALIBRATED DATE	CALIBRATED UNTIL
SPECTRUM ANALYZER R&S	FSV 40	100964	July 15, 2013	July 14, 2014

Note:

1. The calibration interval of the above test instruments is 12 months and the calibrations are traceable to NML/ROC and NIST/USA.
2. Tested date : May 20, 2014

5.5.3 TEST PROCEDURE

1. Set the RBW = 3 kHz, VBW =10 kHz, Detector = peak.
2. Sweep time = auto couple, Trace mode = max hold, allow trace to fully stabilize.
3. Use the peak marker function to determine the maximum amplitude level.

5.5.4 DEVIATION FROM TEST STANDARD

No deviation

5.5.5 TEST SETUP

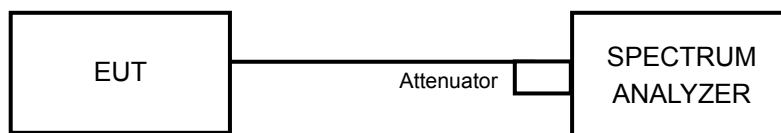

5.5.6 EUT OPERATING CONDITION

Same as Item 4.3.6



A D T

5.5.7 TEST RESULTS

802.11a

TX CHAIN	CHANNEL	FREQUENCY (MHz)	PSD (dBm)	10 log (N=2) dB	Total PSD (dBm)	Limit (dBm)	PASS /FAIL
0	149	5745	-9.89	3.01	-6.88	5.83	PASS
	157	5785	-9.90	3.01	-6.89	5.83	PASS
	165	5825	-9.09	3.01	-6.08	5.83	PASS
1	149	5745	-9.92	3.01	-6.91	5.83	PASS
	157	5785	-9.47	3.01	-6.46	5.83	PASS
	165	5825	-9.52	3.01	-6.51	5.83	PASS

NOTE: Directional gain = $5.16\text{dBi} + 10\log(2) = 8.17\text{dBi} > 6\text{dBi}$, so the power density limit shall be reduced to $8 - (8.17 - 6) = 5.83\text{dBm}$.

802.11ac (VHT20)

TX CHAIN	CHANNEL	FREQUENCY (MHz)	PSD (dBm)	10 log (N=2) dB	Total PSD (dBm)	Limit (dBm)	PASS /FAIL
0	149	5745	-9.53	3.01	-6.52	8	PASS
	157	5785	-9.93	3.01	-6.92	8	PASS
	165	5825	-9.78	3.01	-6.77	8	PASS
1	149	5745	-10.85	3.01	-7.84	8	PASS
	157	5785	-9.48	3.01	-6.47	8	PASS
	165	5825	-10.03	3.01	-7.02	8	PASS

802.11ac (VHT40)

TX CHAIN	CHANNEL	FREQUENCY (MHz)	PSD (dBm)	10 log (N=2) dB	Total PSD (dBm)	Limit (dBm)	PASS /FAIL
0	151	5755	-14.70	3.01	-11.69	8	PASS
	159	5795	-14.16	3.01	-11.15	8	PASS
1	151	5755	-13.72	3.01	-10.71	8	PASS
	159	5795	-13.18	3.01	-10.17	8	PASS

802.11ac (VHT80)

TX CHAIN	CHANNEL	FREQUENCY (MHz)	PSD (dBm)	10 log (N=2) dB	Total PSD (dBm)	Limit (dBm)	PASS /FAIL
0	155	5775	-17.58	3.01	-14.57	8	PASS
1	155	5775	-18.14	3.01	-15.13	8	PASS



A D T

SPECTRUM PLOT OF WORST VALUE

802.11a / Chain(0) : CH165

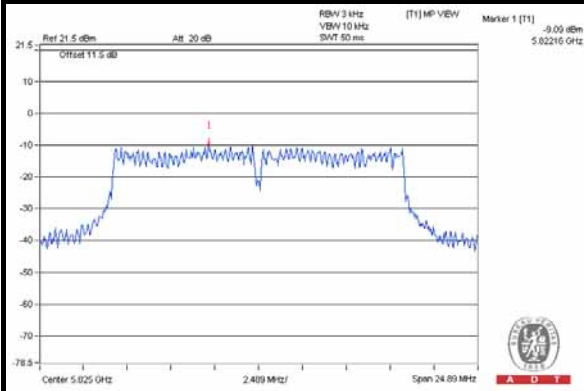

802.11ac (VHT20) / Chain(1) : CH157

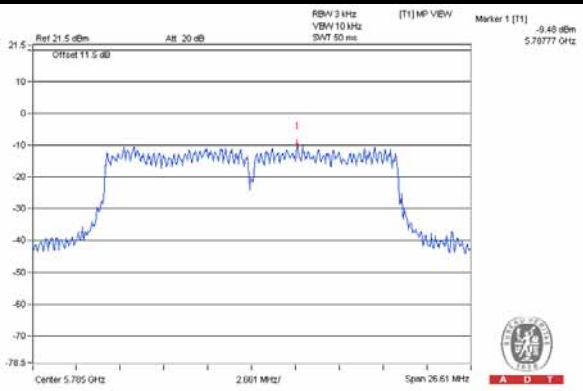

802.11ac (VHT40) / Chain(1) : CH159

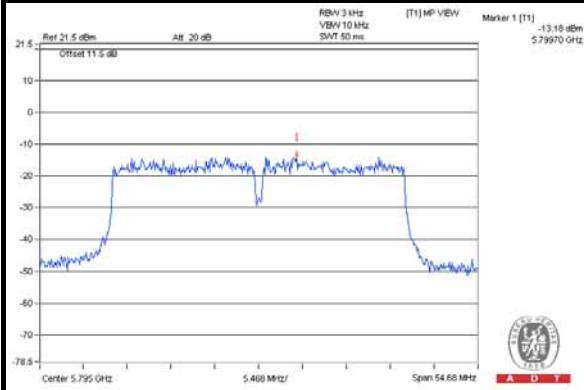

802.11ac (VHT80) / Chain(0) : CH155

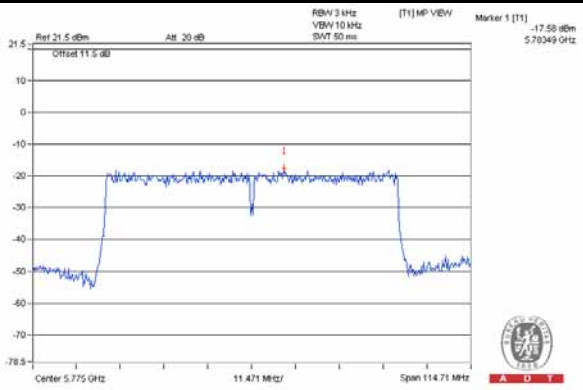



A D T

5.6 CONDUCTED OUT-BAND EMISSION MEASUREMENT

5.6.1 LIMITS OF CONDUCTED OUT-BAND EMISSION MEASUREMENT

Below 20dB of the highest emission level of operating band (in 100kHz Resolution Bandwidth).

5.6.2 TEST INSTRUMENTS

DESCRIPTION & MANUFACTURER	MODEL NO.	SERIAL NO.	CALIBRATED DATE	CALIBRATED UNTIL
SPECTRUM ANALYZER R&S	FSV 40	100964	July 15, 2013	July 14, 2014

Note:

1. The calibration interval of the above test instruments is 12 months and the calibrations are traceable to NML/ROC and NIST/USA.
2. Tested date : May 20, 2014

5.6.3 TEST PROCEDURE

Measurement Procedure - Reference Level

1. Set the RBW = 100 kHz.
2. Set the VBW \geq 300 kHz.
3. Detector = peak.
4. Sweep time = auto couple.
5. Trace mode = max hold.
6. Allow trace to fully stabilize.
7. Use the peak marker function to determine the maximum power level in any 100 kHz band segment within the fundamental EBW.

Measurement Procedure –Unwanted Emission Level

1. Set RBW = 100 kHz.
2. Set VBW \geq 300 kHz.
3. Set span to encompass the spectrum to be examined
4. Detector = peak.
5. Trace Mode = max hold.
6. Sweep = auto couple.

5.6.4 DEVIATION FROM TEST STANDARD

No deviation

5.6.5 TEST SETUP

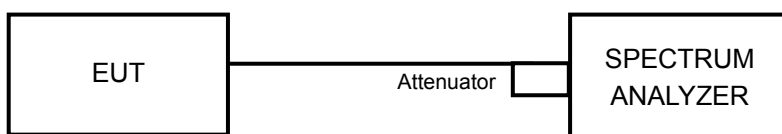

5.6.6 EUT OPERATING CONDITION

Same as Item 4.3.6

5.6.7 TEST RESULTS

The spectrum plots are attached on the following pages. D1 line indicates the highest level, and D2 line indicates the 20dB offset below D1. It shows compliance with the requirement.



A D T

802.11a

Chain (0)

CH 149

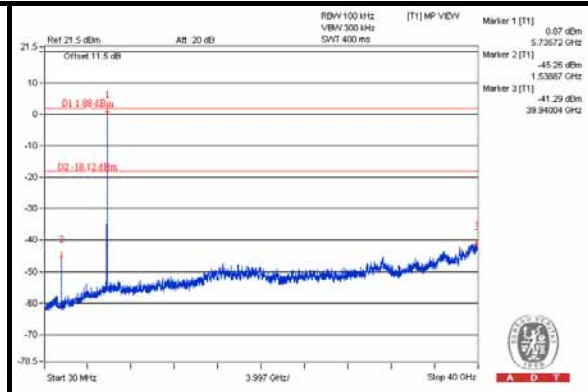
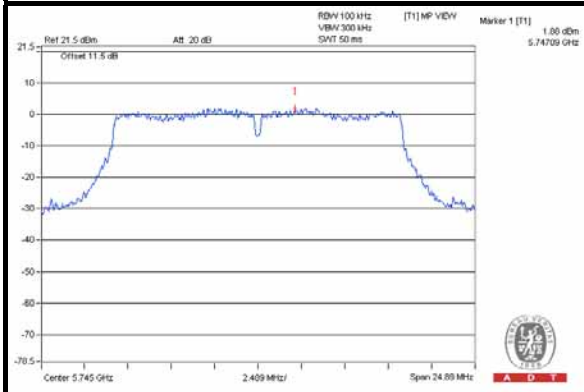

CH 157

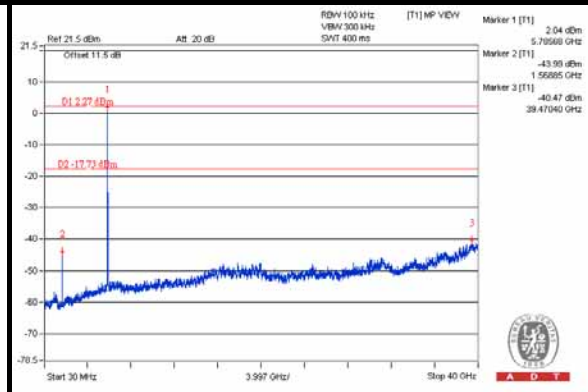
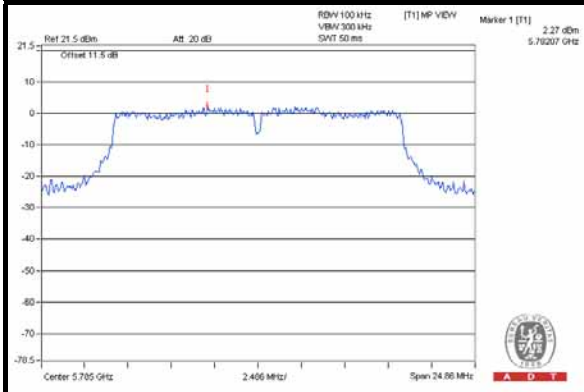

CH 165

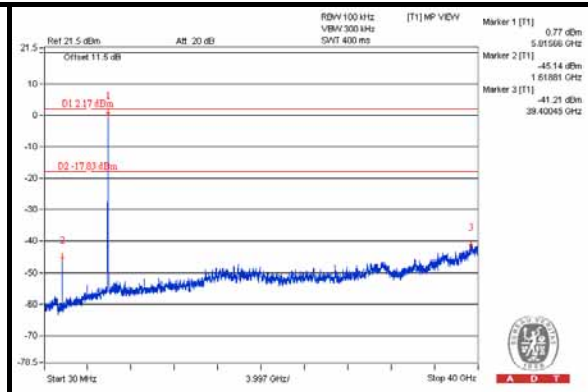
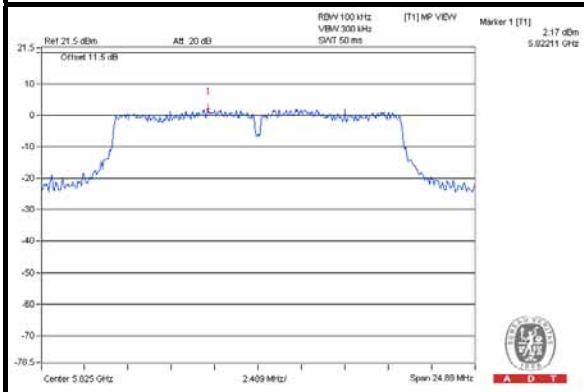

H 149 Band edge

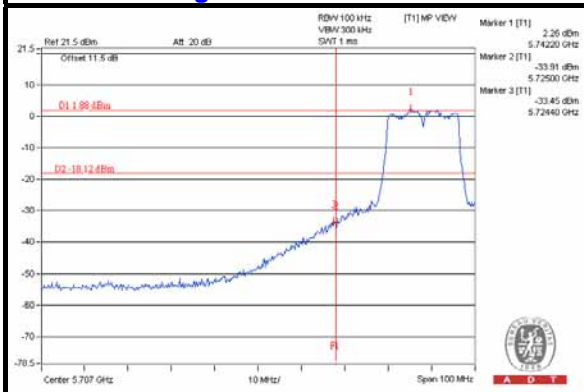

CH 165 Band edge

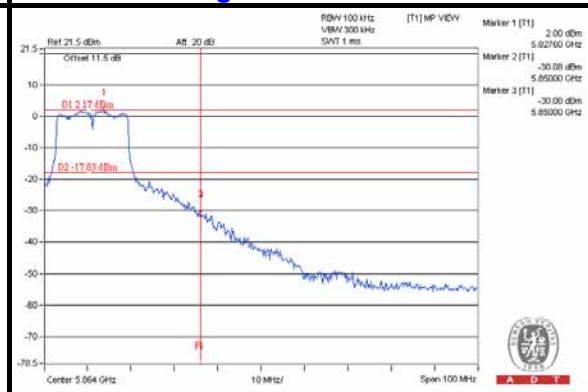



A D T

Chain (1) CH 149

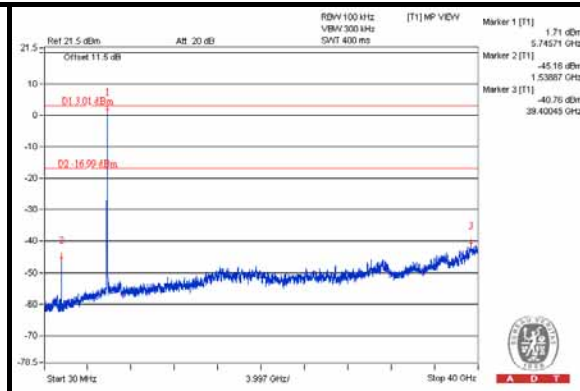
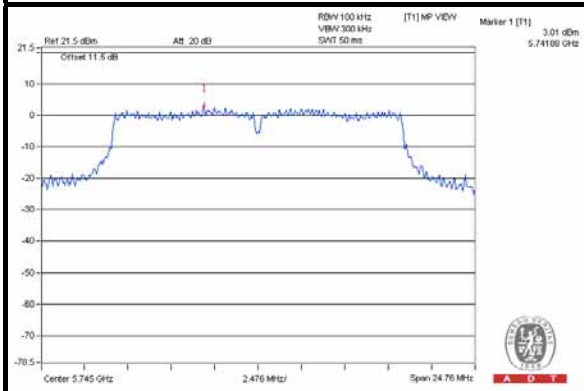

CH 157

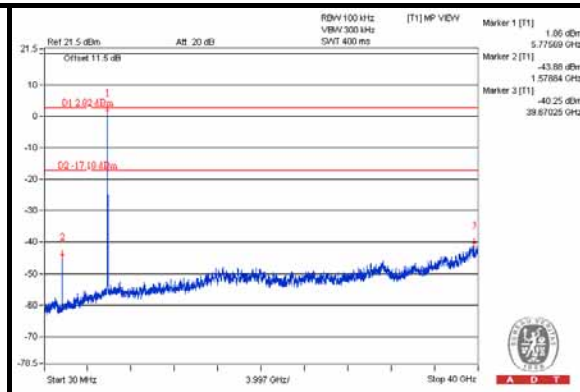
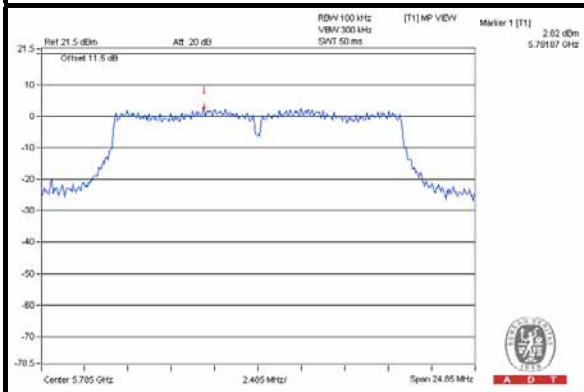

CH 165

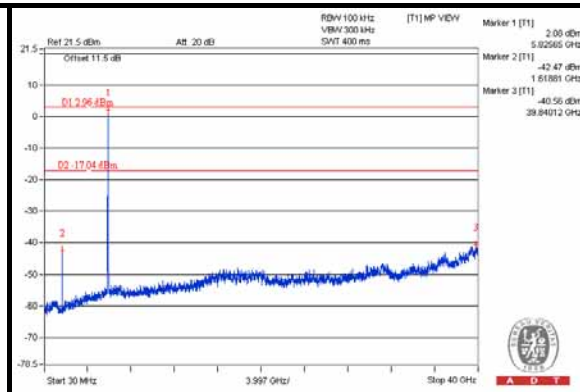
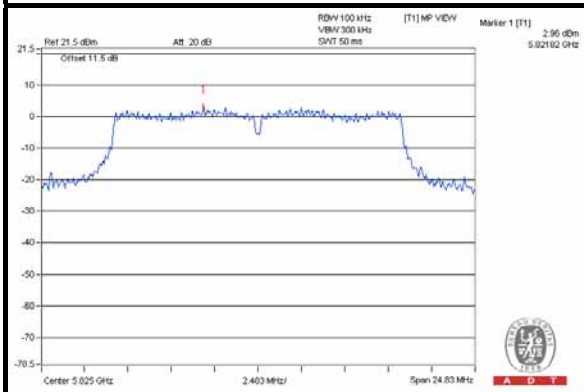

CH 149 Band edge

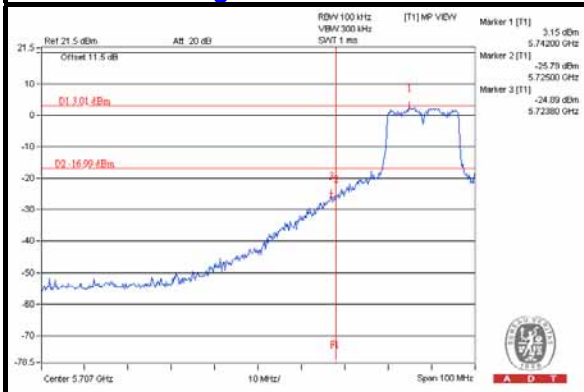

CH 165 Band edge

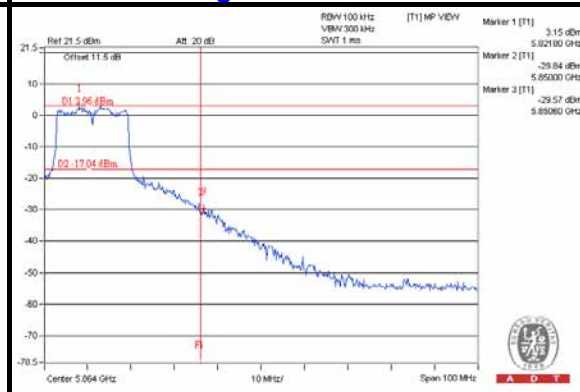



A D T

802.11ac (VHT20)

Chain (0)

CH 149

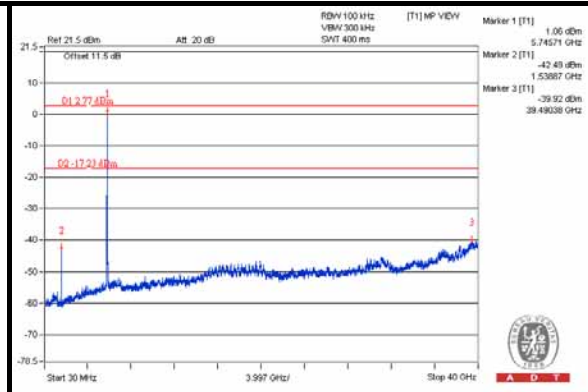
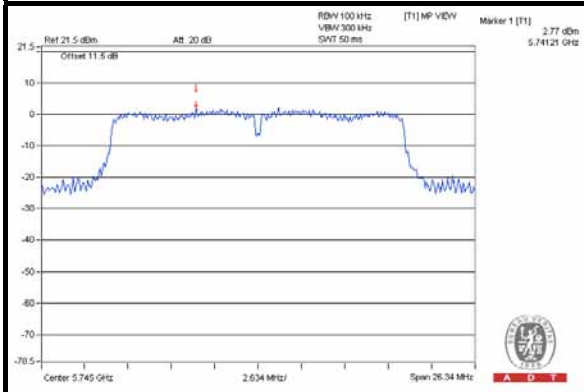

CH 157

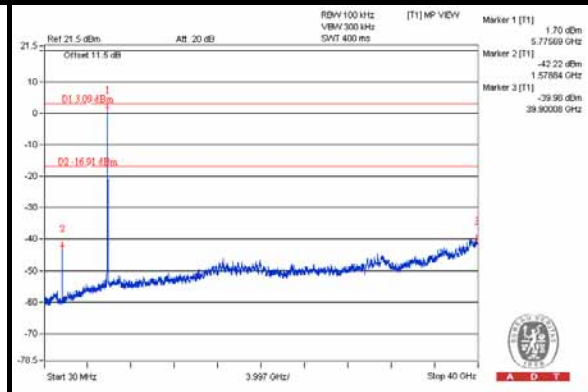
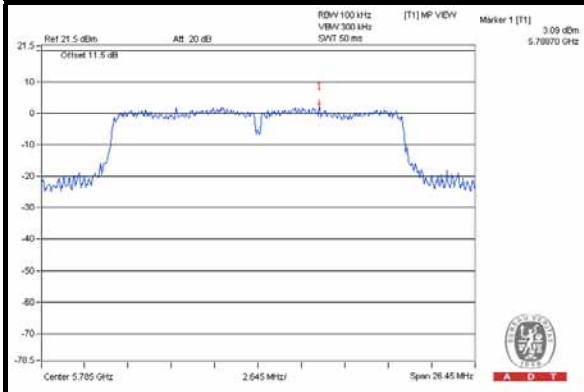

CH 165

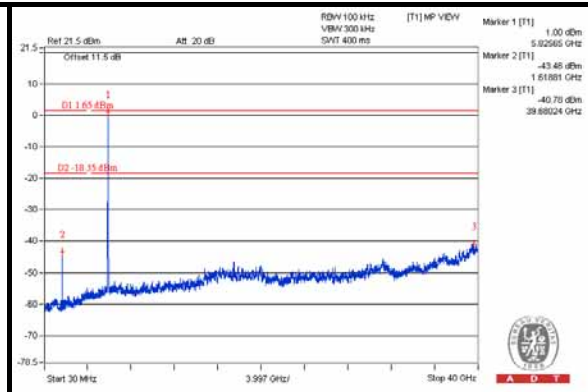
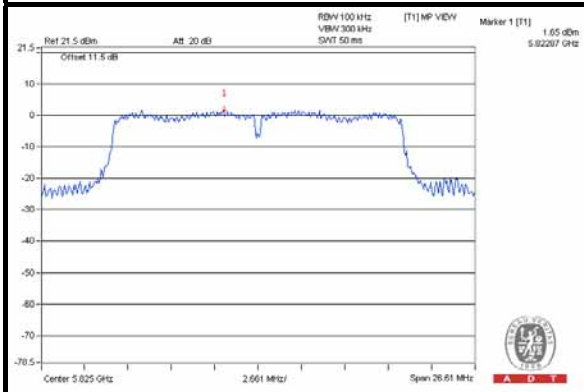

CH 149 Band edge

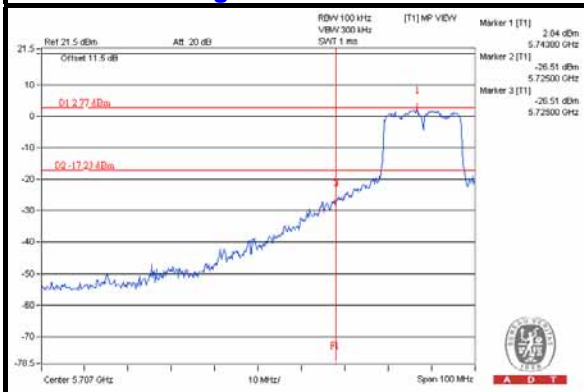

CH 165 Band edge

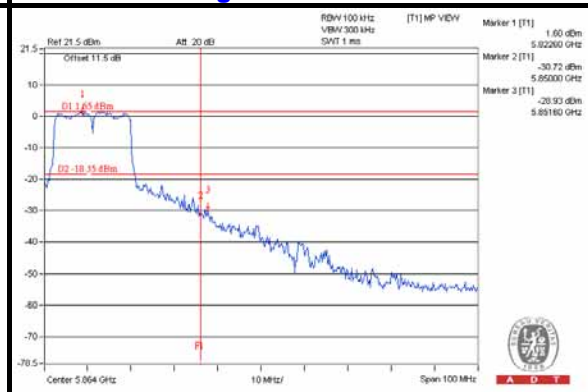



A D T

Chain (1) CH 149

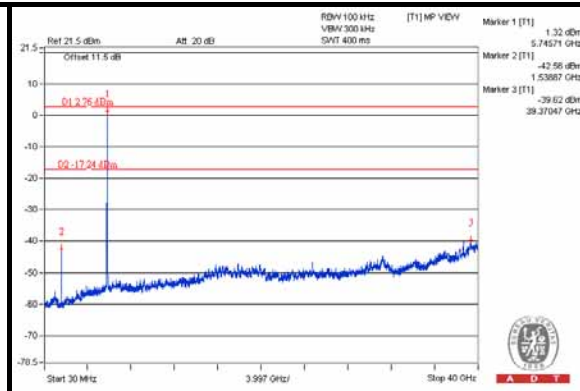
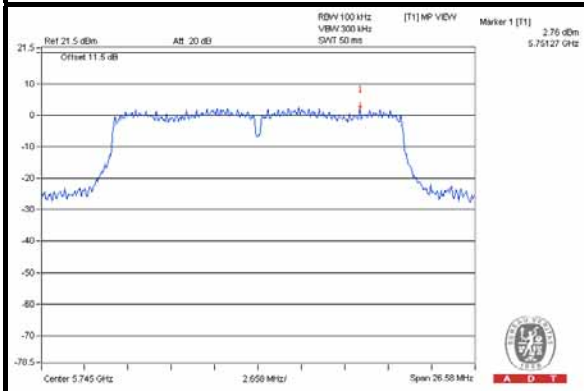

CH 157

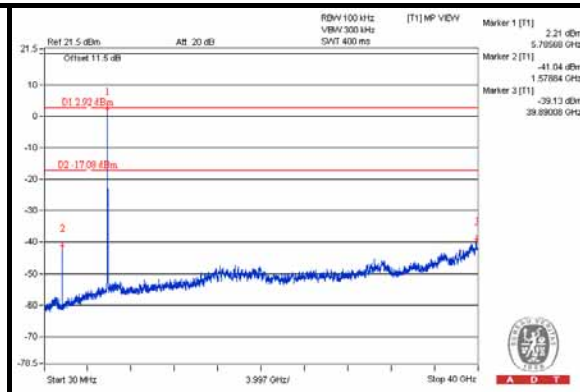
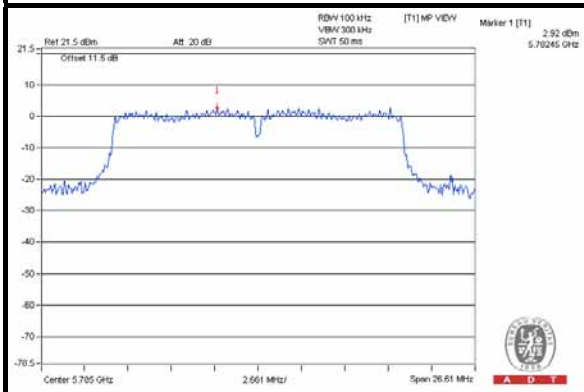

CH 165

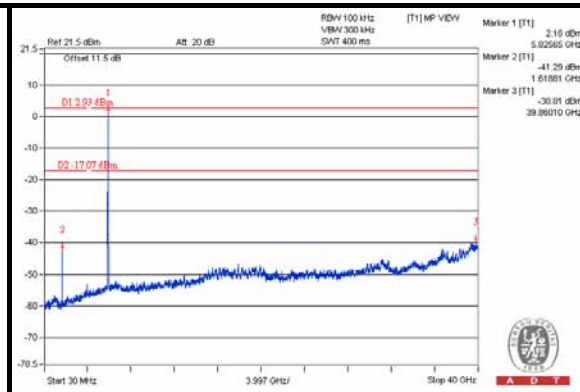
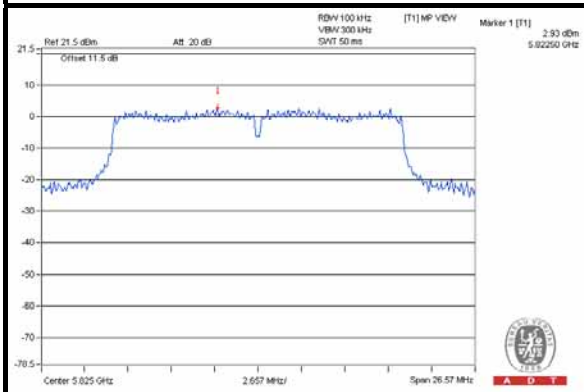

CH 149 Band edge

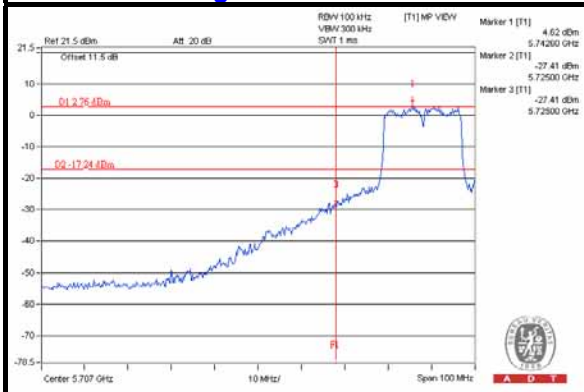

CH 165 Band edge

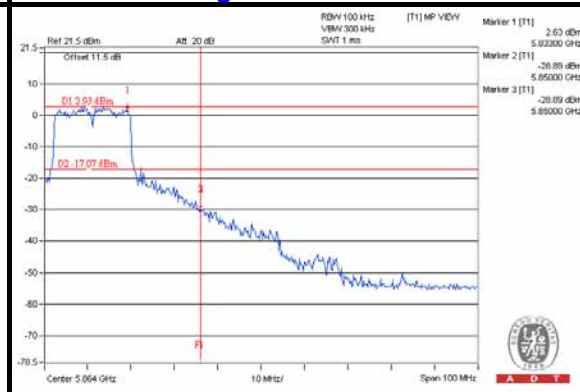



A D T

802.11ac (VHT40)

Chain (0)

CH 151

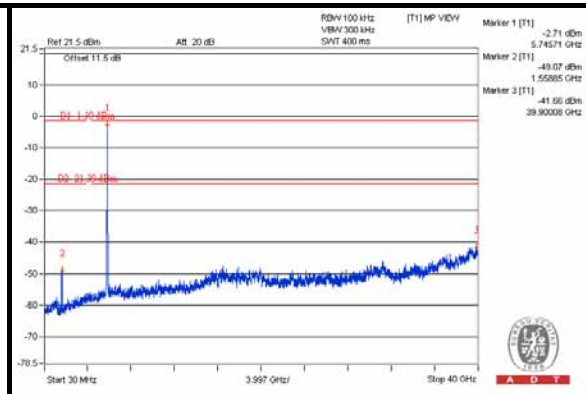
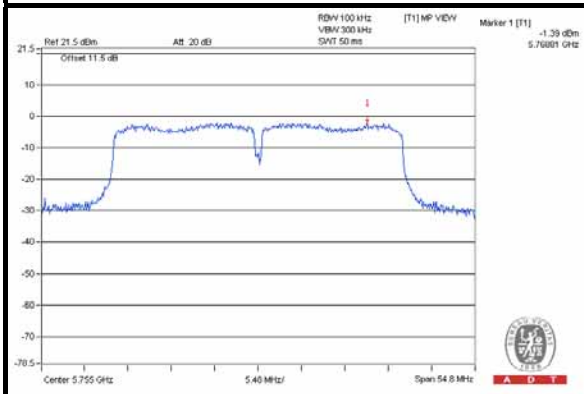

CH 159

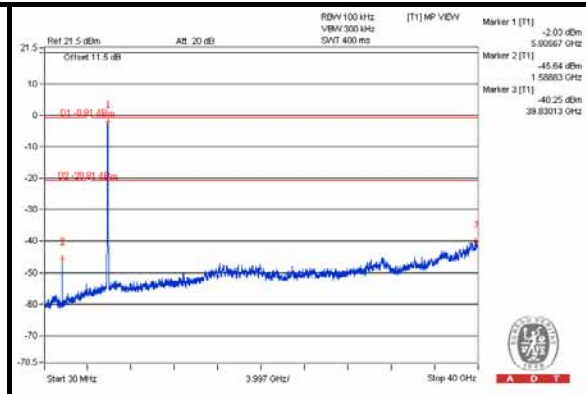
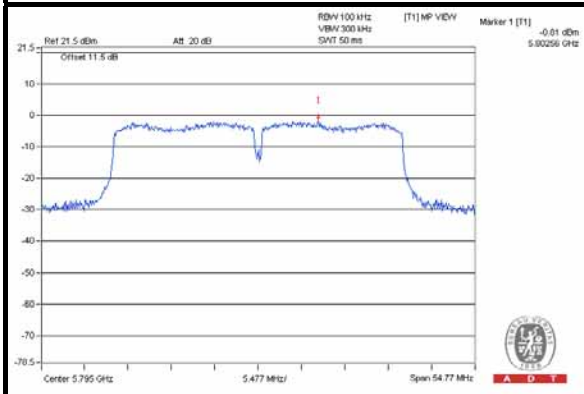

CH 151 Band edge

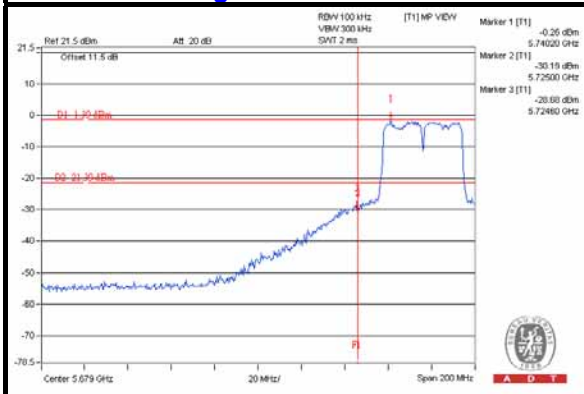

CH 159 Band edge

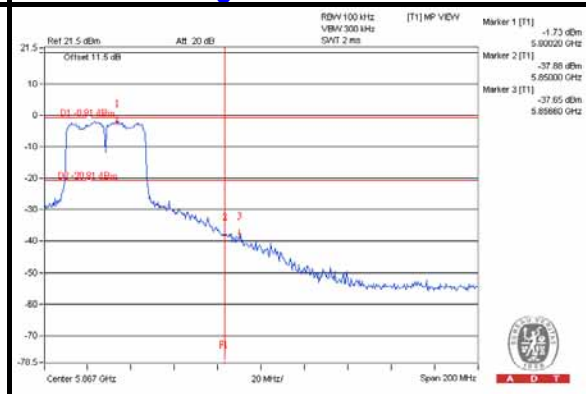

Chain (1)

CH 151

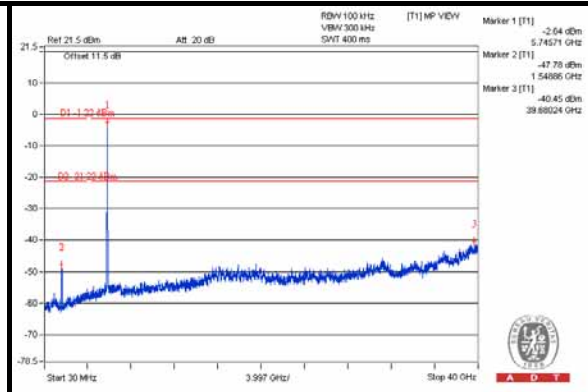
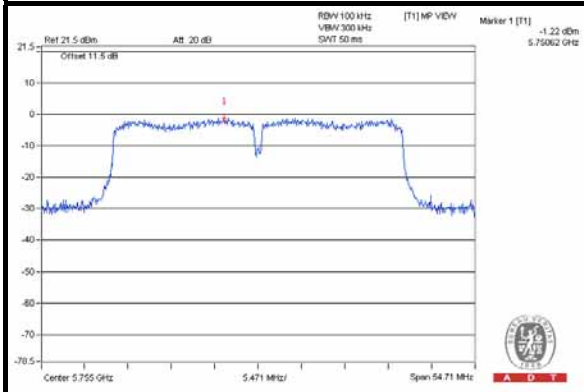

CH 159

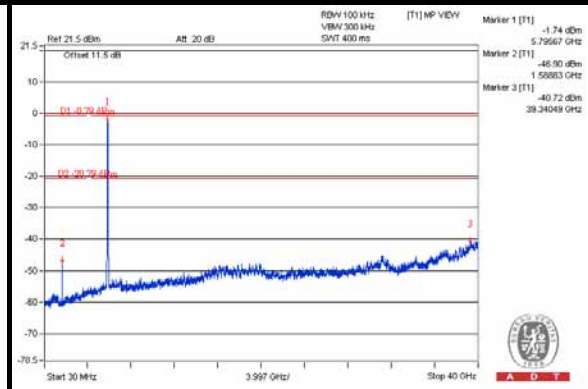
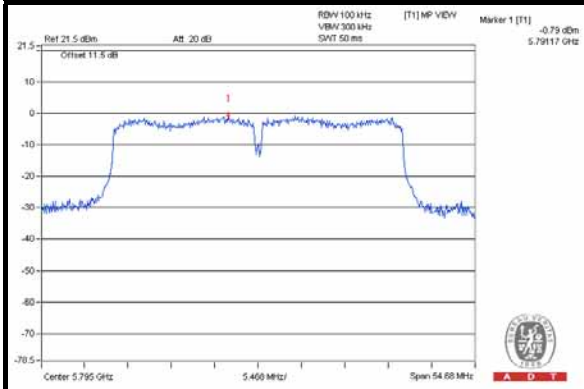

CH 151 Band edge

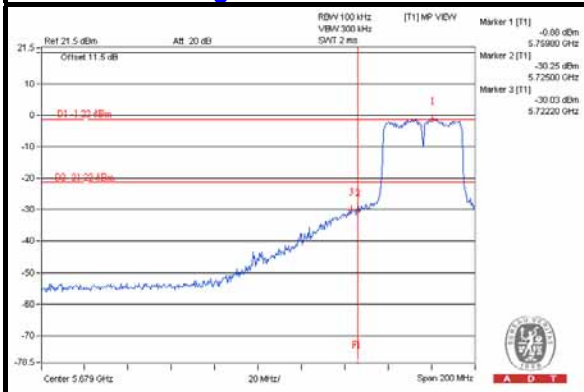

CH 159 Band edge

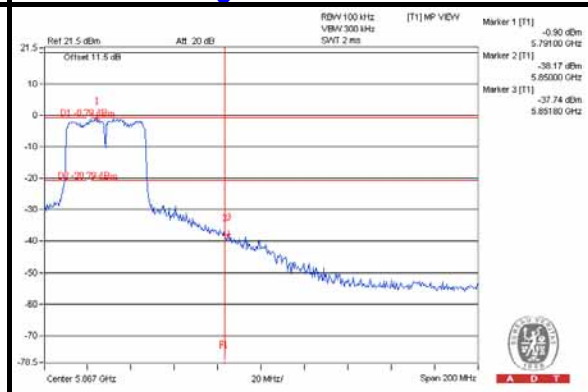



A D T

802.11ac (VHT80)

Chain (0)

CH 155

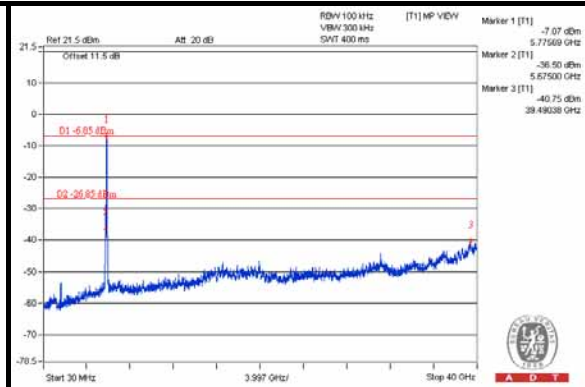
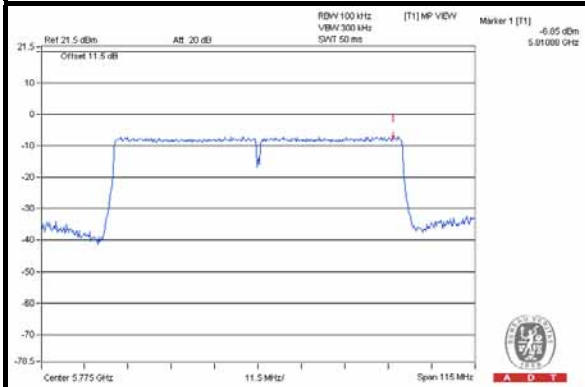

CH 155 Band edge

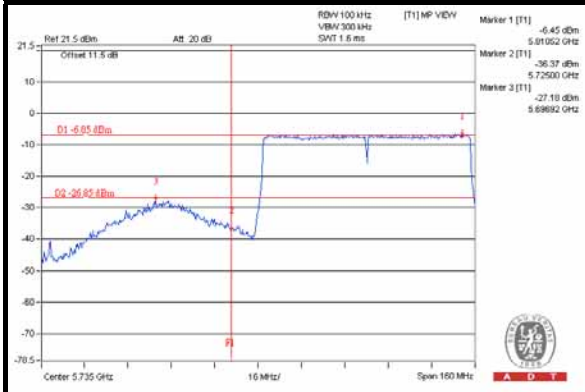

CH 155 Band edge

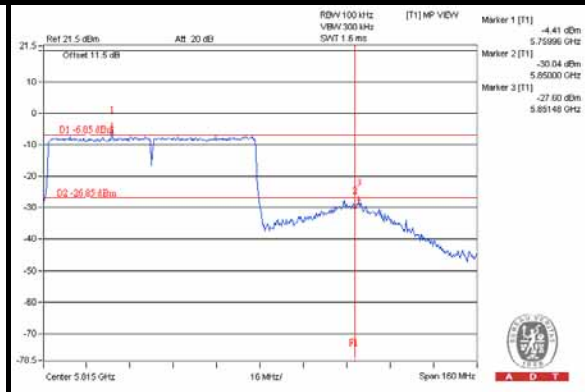

Chain (1)

CH 155

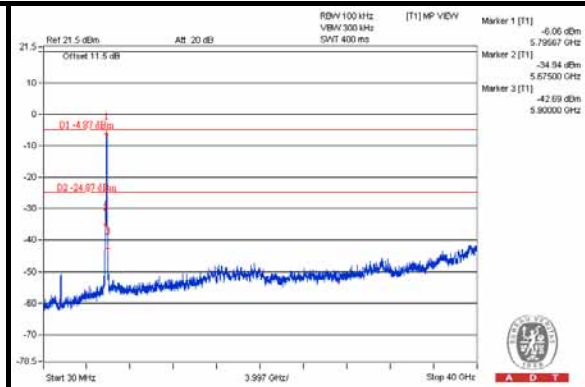
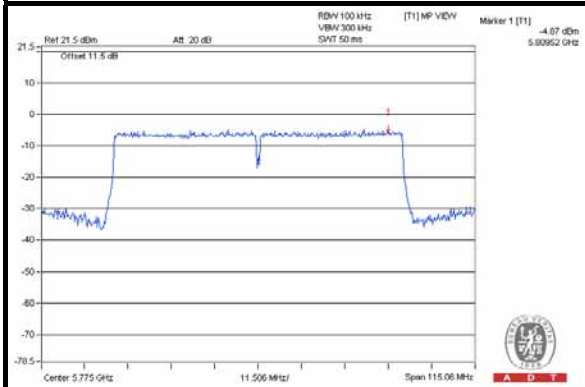

CH 155 Band edge

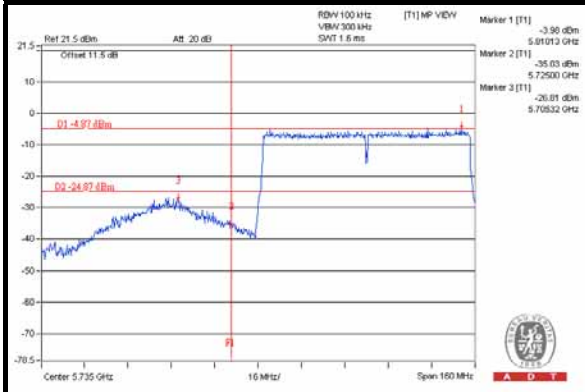

CH 155 Band edge

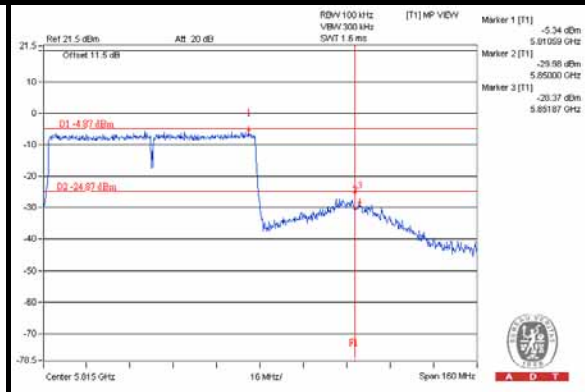



A D T

6. PHOTOGRAPHS OF THE TEST CONFIGURATION

Please refer to the attached file (Test Setup Photo).





A D T

7. INFORMATION ON THE TESTING LABORATORIES

We, Bureau Veritas Consumer Products Services (H.K.) Ltd., Taoyuan Branch, were founded in 1988 to provide our best service in EMC, Radio, Telecom and Safety consultation. Our laboratories are accredited and approved according to ISO/IEC 17025.

If you have any comments, please feel free to contact us at the following:

Linko EMC/RF Lab:

Tel: 886-2-26052180

Fax: 886-2-26052943

Hsin Chu EMC/RF Lab:

Tel: 886-3-5935343

Fax: 886-3-5935342

Hwa Ya EMC/RF/Safety/Telecom Lab:

Tel: 886-3-3183232

Fax: 886-3-3270892

Email: service.adt@tw.bureauveritas.com

Web Site: www.bureauveritas-adt.com

The address and road map of all our labs can be found in our web site also.



A D T

8. APPENDIX A - MODIFICATIONS RECORDERS FOR ENGINEERING CHANGES TO THE EUT BY THE LAB

No modifications were made to the EUT by the lab during the test.

--- END ---