

Det Le1_802.11ax_20MHz_CF 6135MHz_6135MHz_-70.6dBm



Det Le1_802.11ax_20MHz_CF 6455MHz_6455MHz_-73.08dBm



Det Le1_802.11ax_20MHz_CF 6135MHz_6135MHz_-71.6dBm



Det Le1_802.11ax_20MHz_CF 6695MHz_6695MHz_-71.2dBm



Det Le1_802.11ax_20MHz_CF 6455MHz_6455MHz_-72.08dBm



Det Le1_802.11ax_20MHz_CF 6695MHz_6695MHz_-72.2dBm



Unless otherwise stated the results shown in this test report refer only to the sample(s) tested and such sample(s) are retained for 90 days only.

除非另有說明，此報告結果僅對測試之樣品負責，同時此樣品僅保留90天。本報告未經本公司書面許可，不可部份複製。

This document is issued by the Company subject to its General Conditions of Service printed overleaf, available on request or accessible at <http://www.sgs.com.tw/Terms-and-Conditions> and for electronic format documents, subject to Terms and Conditions for Electronic Documents at <http://www.sgs.com.tw/Terms-and-Conditions>. Attention is drawn to the limitation of liability, indemnification and jurisdiction issues defined therein. Any holder of this document is advised that information contained herein reflects the Company's findings at the time of its intervention only and within the limits of Client's instructions, if any. The Company's sole responsibility is to its Client and this document does not exonerate parties to a transaction from exercising all their rights and obligations under the transaction documents. This document cannot be reproduced except in full, without prior written approval of the Company. Any unauthorized alteration, forgery or falsification of the content or appearance of this document is unlawful and offenders may be prosecuted to the fullest extent of the law.

Det Lel_802.11ax_20MHz_CF 7015MHz_7015MHz_-69.28dBm



Det Lel_802.11ax_160MHz_CF 6185MHz_6110MHz_-72.6dBm



Det Lel_802.11ax_20MHz_CF 7015MHz_7015MHz_-70.28dBm



Det Lel_802.11ax_160MHz_CF 6185MHz_6185MHz_-70.6dBm



Det Lel_802.11ax_160MHz_CF 6185MHz_6110MHz_-71.6dBm



Det Lel_802.11ax_160MHz_CF 6185MHz_6185MHz_-71.6dBm



Unless otherwise stated the results shown in this test report refer only to the sample(s) tested and such sample(s) are retained for 90 days only.

除非另有說明，此報告結果僅對測試之樣品負責，同時此樣品僅保留90天。本報告未經本公司書面許可，不可部份複製。

This document is issued by the Company subject to its General Conditions of Service printed overleaf, available on request or accessible at <http://www.sgs.com.tw/Terms-and-Conditions> and for electronic format documents, subject to Terms and Conditions for Electronic Documents at <http://www.sgs.com.tw/Terms-and-Conditions>. Attention is drawn to the limitation of liability, indemnification and jurisdiction issues defined therein. Any holder of this document is advised that information contained herein reflects the Company's findings at the time of its intervention only and within the limits of Client's instructions, if any. The Company's sole responsibility is to its Client and this document does not exonerate parties to a transaction from exercising all their rights and obligations under the transaction documents. This document cannot be reproduced except in full, without prior written approval of the Company. Any unauthorized alteration, forgery or falsification of the content or appearance of this document is unlawful and offenders may be prosecuted to the fullest extent of the law.

Det Lel_802.11ax_160MHz_CF 6185MHz_6260MHz_-64.6dBm



Det Lel_802.11ax_160MHz_CF 6505MHz_6430MHz_-72.17dBm

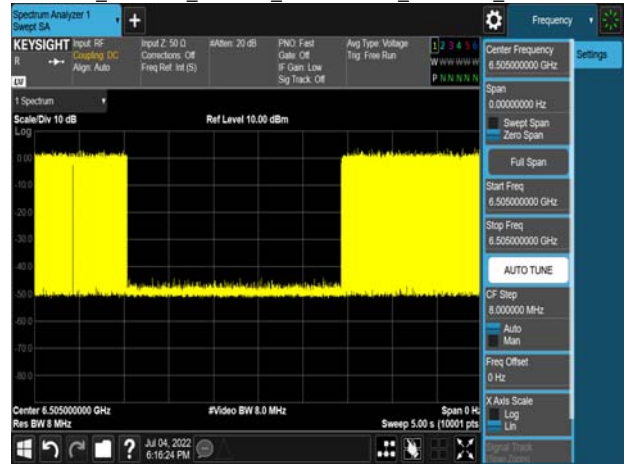

Det Lel_802.11ax_160MHz_CF 6185MHz_6260MHz_-65.6.pngdBm



Det Lel_802.11ax_160MHz_CF 6505MHz_6505MHz-69.11dBm

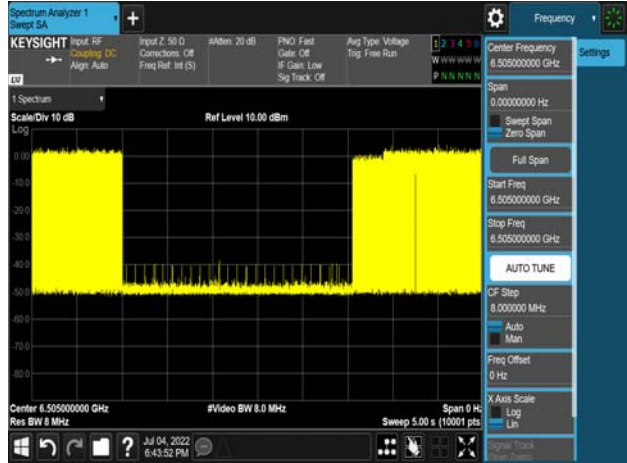

Det Lel_802.11ax_160MHz_CF 6505MHz_6430MHz-73.17dBm

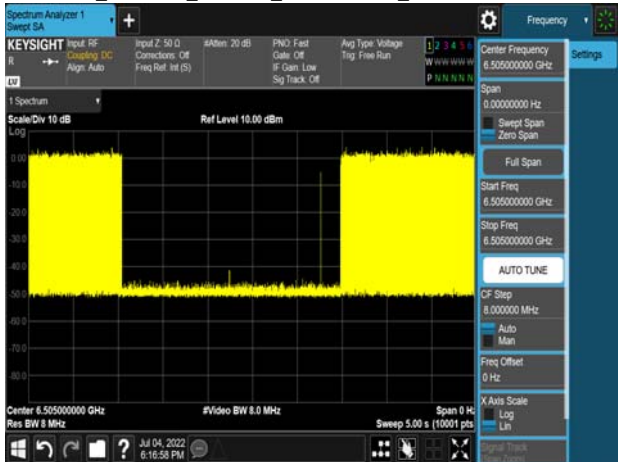

Det Lel_802.11ax_160MHz_CF 6505MHz_6505MHz-70.11dBm

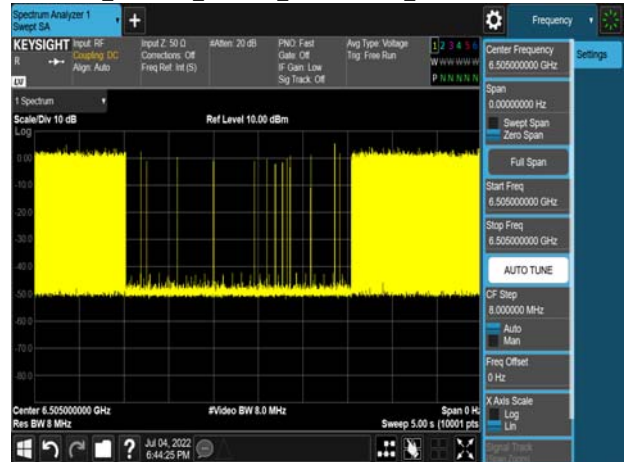

Unless otherwise stated the results shown in this test report refer only to the sample(s) tested and such sample(s) are retained for 90 days only.

除非另有說明，此報告結果僅對測試之樣品負責，同時此樣品僅保留90天。本報告未經本公司書面許可，不可部份複製。

This document is issued by the Company subject to its General Conditions of Service printed overleaf, available on request or accessible at <http://www.sgs.com.tw/Terms-and-Conditions> and for electronic format documents, subject to Terms and Conditions for Electronic Documents at <http://www.sgs.com.tw/Terms-and-Conditions>. Attention is drawn to the limitation of liability, indemnification and jurisdiction issues defined therein. Any holder of this document is advised that information contained herein reflects the Company's findings at the time of its intervention only and within the limits of Client's instructions, if any. The Company's sole responsibility is to its Client and this document does not exonerate parties to a transaction from exercising all their rights and obligations under the transaction documents. This document cannot be reproduced except in full, without prior written approval of the Company. Any unauthorized alteration, forgery or falsification of the content or appearance of this document is unlawful and offenders may be prosecuted to the fullest extent of the law.

Det Le1_802.11ax_160MHz_CF 6505MHz_6580MHz_-75.29dBm

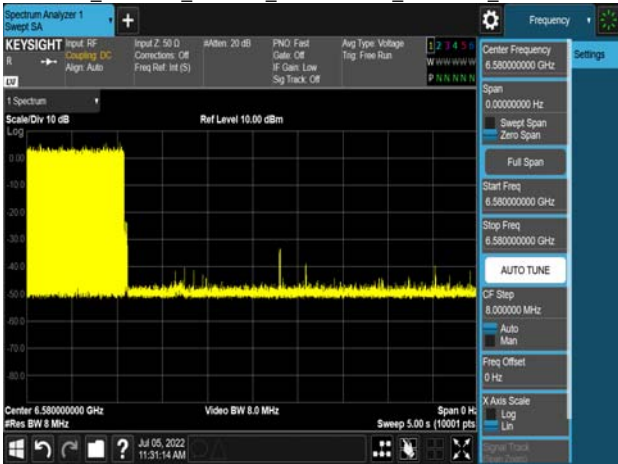

Det Le1_802.11ax_160MHz_CF 6665MHz_6590MHz_-70.33dBm

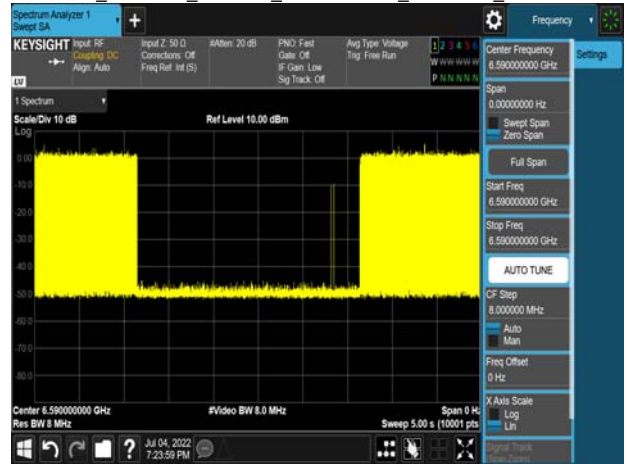

Det Le1_802.11ax_160MHz_CF 6505MHz_6580MHz_-76.29dBm



Det Le1_802.11ax_160MHz_CF 6665MHz_6665MHz_-68.06dBm



Det Le1_802.11ax_160MHz_CF 6665MHz_6590MHz_-69.33dBm

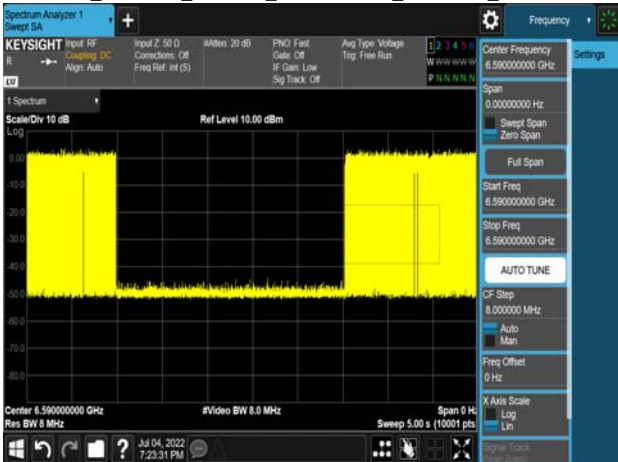

Det Le1_802.11ax_160MHz_CF 6665MHz_6665MHz_-69.06dBm



Unless otherwise stated the results shown in this test report refer only to the sample(s) tested and such sample(s) are retained for 90 days only.

除另有說明，此報告結果僅對測試之樣品負責，同時此樣品僅保留90天。本報告未經本公司書面許可，不可部份複製。

This document is issued by the Company subject to its General Conditions of Service printed overleaf, available on request or accessible at <http://www.sgs.com.tw/Terms-and-Conditions> and for electronic format documents, subject to Terms and Conditions for Electronic Documents at <http://www.sgs.com.tw/Terms-and-Conditions>. Attention is drawn to the limitation of liability, indemnification and jurisdiction issues defined therein. Any holder of this document is advised that information contained herein reflects the Company's findings at the time of its intervention only and within the limits of Client's instructions, if any. The Company's sole responsibility is to its Client and this document does not exonerate parties to a transaction from exercising all their rights and obligations under the transaction documents. This document cannot be reproduced except in full, without prior written approval of the Company. Any unauthorized alteration, forgery or falsification of the content or appearance of this document is unlawful and offenders may be prosecuted to the fullest extent of the law.

Det Le1_802.11ax_160MHz_CF 6665MHz_6740MHz_-73.02dBm

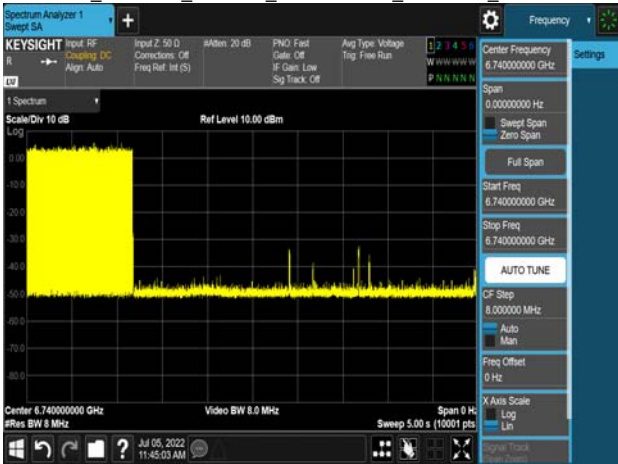

Det Le1_802.11ax_160MHz_CF 6985MHz_6910MHz_-67.14dBm

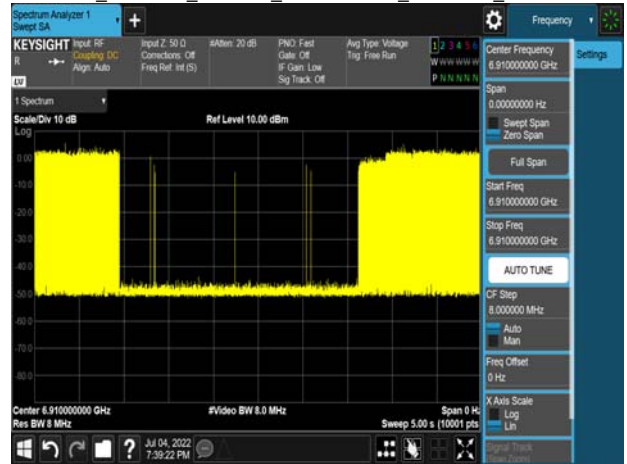

Det Le1_802.11ax_160MHz_CF 6665MHz_6740MHz_-74.02dBm

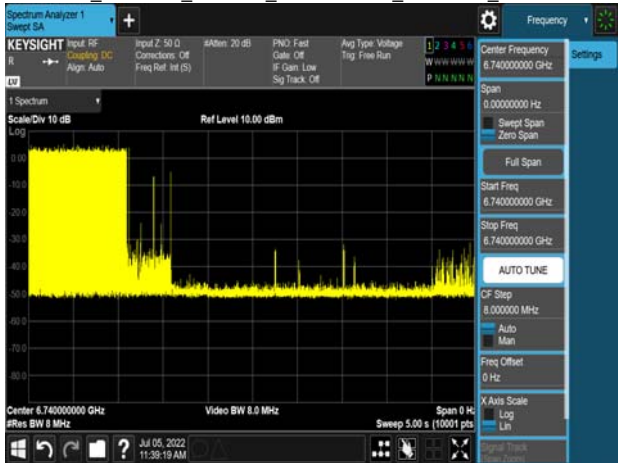

Det Le1_802.11ax_160MHz_CF 6985MHz_6985MHz_-66.35dBm

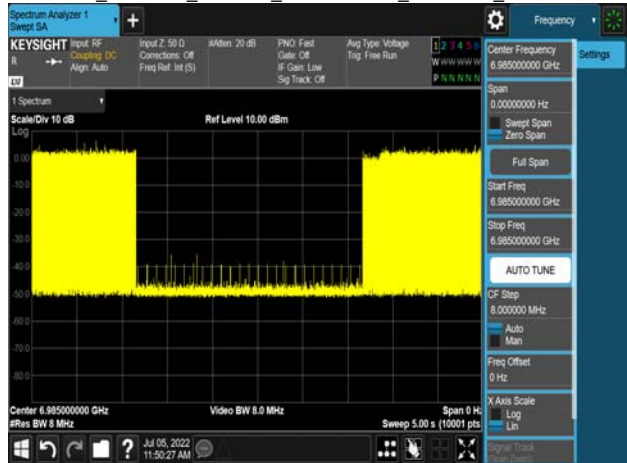

Det Le1_802.11ax_160MHz_CF 6985MHz_6910MHz_-66.14dBm

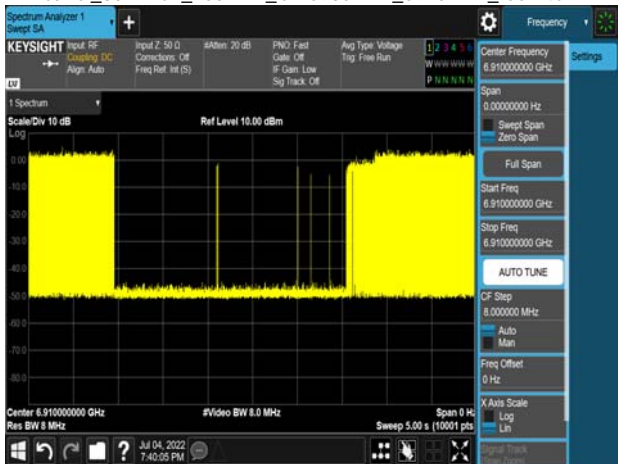

Det Le1_802.11ax_160MHz_CF 6985MHz_6985MHz_-67.35dBm

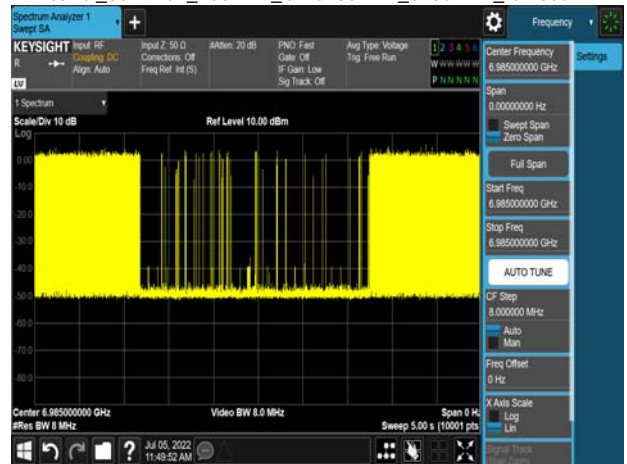

Unless otherwise stated the results shown in this test report refer only to the sample(s) tested and such sample(s) are retained for 90 days only.

除非另有說明，此報告結果僅對測試之樣品負責，同時此樣品僅保留90天。本報告未經本公司書面許可，不可部份複製。

This document is issued by the Company subject to its General Conditions of Service printed overleaf, available on request or accessible at <http://www.sgs.com.tw/Terms-and-Conditions> and for electronic format documents, subject to Terms and Conditions for Electronic Documents at <http://www.sgs.com.tw/Terms-and-Conditions>. Attention is drawn to the limitation of liability, indemnification and jurisdiction issues defined therein. Any holder of this document is advised that information contained herein reflects the Company's findings at the time of its intervention only and within the limits of Client's instructions, if any. The Company's sole responsibility is to its Client and this document does not exonerate parties to a transaction from exercising all their rights and obligations under the transaction documents. This document cannot be reproduced except in full, without prior written approval of the Company. Any unauthorized alteration, forgery or falsification of the content or appearance of this document is unlawful and offenders may be prosecuted to the fullest extent of the law.

Det Le1_802.11ax_160MHz_CF 6985MHz_7060MHz_-71.18dBm

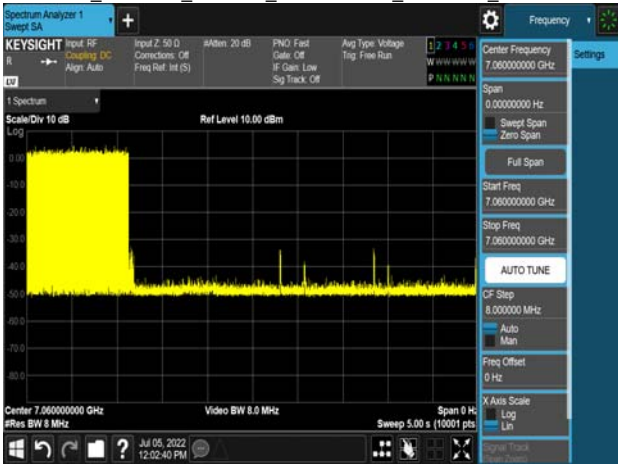

Det Le1_802.11ax_160MHz_CF 6985MHz_7060MHz_-72.18dBm

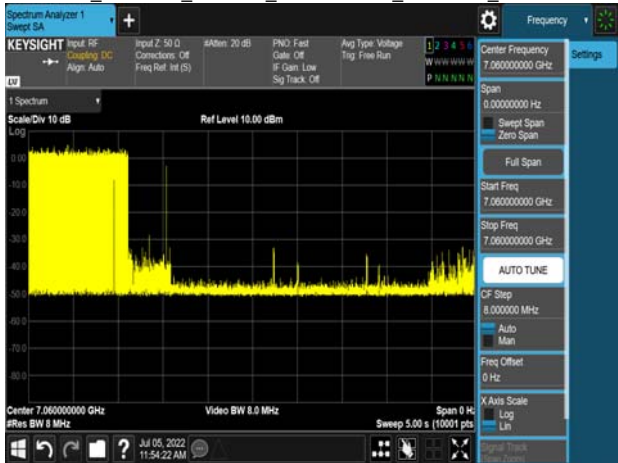

Unless otherwise stated the results shown in this test report refer only to the sample(s) tested and such sample(s) are retained for 90 days only.

除非另有說明，此報告結果僅對測試之樣品負責，同時此樣品僅保留90天。本報告未經本公司書面許可，不可部份複製。
This document is issued by the Company subject to its General Conditions of Service printed overleaf, available on request or accessible at <http://www.sgs.com.tw/Terms-and-Conditions> and for electronic format documents, subject to Terms and Conditions for Electronic Documents at <http://www.sgs.com.tw/Terms-and-Conditions>. Attention is drawn to the limitation of liability, indemnification and jurisdiction issues defined therein. Any holder of this document is advised that information contained hereon reflects the Company's findings at the time of its intervention only and within the limits of Client's instructions, if any. The Company's sole responsibility is to its Client and this document does not exonerate parties to a transaction from exercising all their rights and obligations under the transaction documents. This document cannot be reproduced except in full, without prior written approval of the Company. Any unauthorized alteration, forgery or falsification of the content or appearance of this document is unlawful and offenders may be prosecuted to the fullest extent of the law.

13.4.3 Incumbent_signal

802.11ax_20MHz_6135MHz_AWGN:6135MHz



802.11ax_20MHz_7015MHz_AWGN:7015MHz

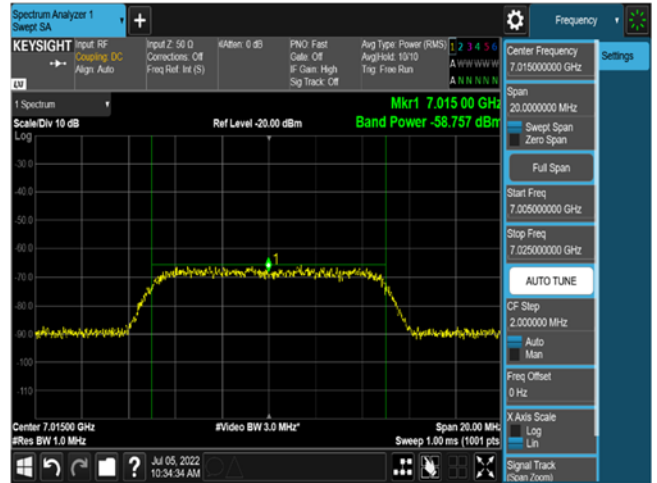

802.11ax_20MHz_6455MHz_AWGN:6455MHz



802.11ax_160MHz_6185MHz_AWGN:6110



802.11ax_20MHz_6695MHz_AWGN:6695MHz



802.11ax_160MHz_6185MHz_AWGN:6185MHz



Unless otherwise stated the results shown in this test report refer only to the sample(s) tested and such sample(s) are retained for 90 days only.

除非另有說明，此報告結果僅對測試之樣品負責，同時此樣品僅保留90天。本報告未經本公司書面許可，不可部份複製。
This document is issued by the Company subject to its General Conditions of Service printed overleaf, available on request or accessible at <http://www.sgs.com.tw/Terms-and-Conditions> and for electronic format documents, subject to Terms and Conditions for Electronic Documents at <http://www.sgs.com.tw/Terms-and-Conditions>. Attention is drawn to the limitation of liability, indemnification and jurisdiction issues defined therein. Any holder of this document is advised that information contained herein reflects the Company's findings at the time of its intervention only and within the limits of Client's instructions, if any. The Company's sole responsibility is to its Client and this document does not exonerate parties to a transaction from exercising all their rights and obligations under the transaction documents. This document cannot be reproduced except in full, without prior written approval of the Company. Any unauthorized alteration, forgery or falsification of the content or appearance of this document is unlawful and offenders may be prosecuted to the fullest extent of the law.

802.11ax_160MHz_6185MHz_AWGN:6260



802.11ax_160MHz_6505MHz_AWGN:6580

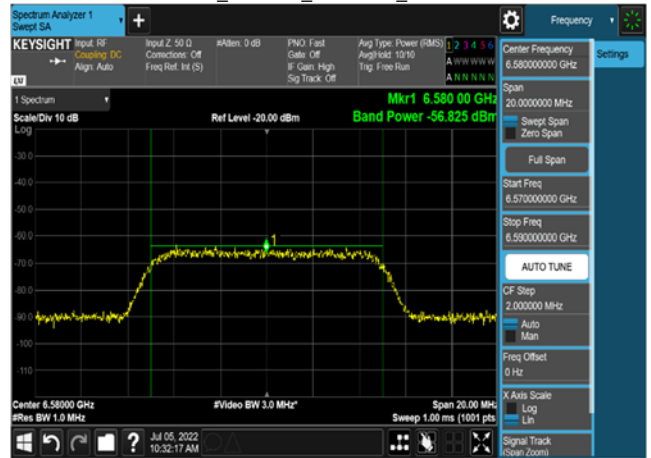

802.11ax_160MHz_6505MHz_AWGN:6430

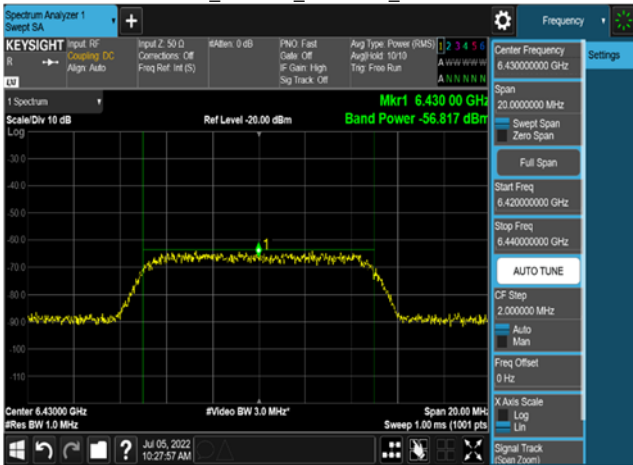

802.11ax_160MHz_6665MHz_AWGN:6590

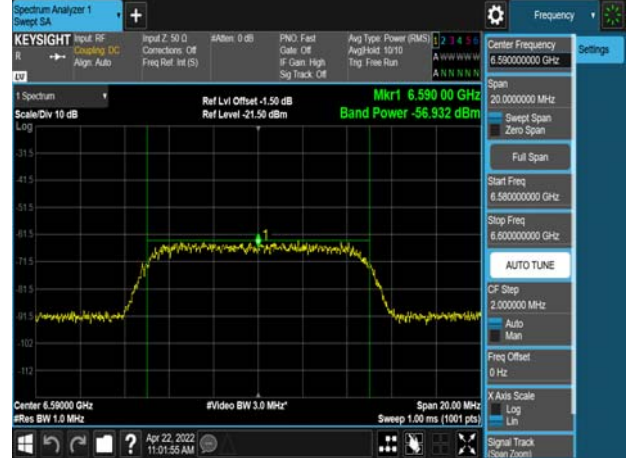

802.11ax_160MHz_6505MHz_AWGN:6505MHz

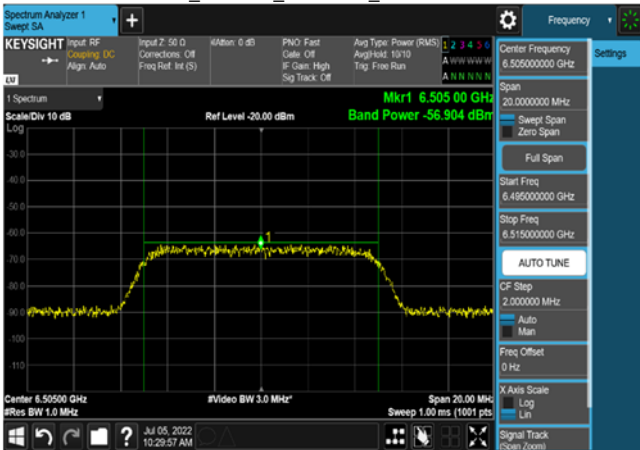

802.11ax_160MHz_6665MHz_AWGN:6665MHz



Unless otherwise stated the results shown in this test report refer only to the sample(s) tested and such sample(s) are retained for 90 days only.

除非另有說明，此報告結果僅對測試之樣品負責，同時此樣品僅保留90天。本報告未經本公司書面許可，不可部份複製。

This document is issued by the Company subject to its General Conditions of Service printed overleaf, available on request or accessible at <http://www.sgs.com.tw/Terms-and-Conditions> and for electronic format documents, subject to Terms and Conditions for Electronic Documents at <http://www.sgs.com.tw/Terms-and-Conditions>. Attention is drawn to the limitation of liability, indemnification and jurisdiction issues defined therein. Any holder of this document is advised that information contained herein reflects the Company's findings at the time of its intervention only and within the limits of Client's instructions, if any. The Company's sole responsibility is to its Client and this document does not exonerate parties to a transaction from exercising all their rights and obligations under the transaction documents. This document cannot be reproduced except in full, without prior written approval of the Company. Any unauthorized alteration, forgery or falsification of the content or appearance of this document is unlawful and offenders may be prosecuted to the fullest extent of the law.

802.11ax_160MHz_6665MHz_AWGN:6740



802.11ax_160MHz_6985MHz_AWGN:7060

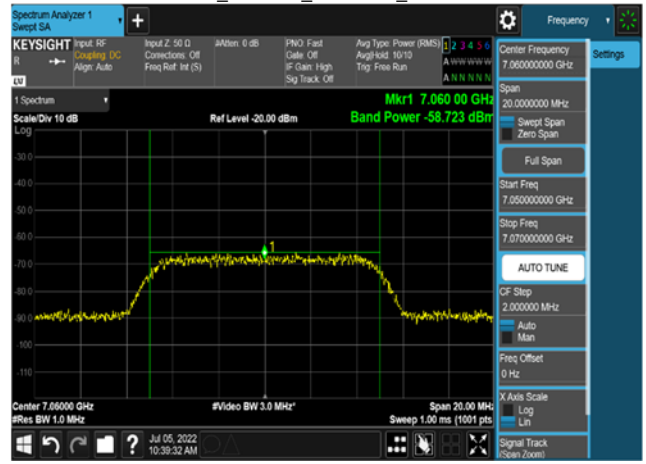

802.11ax_160MHz_6985MHz_AWGN:6910

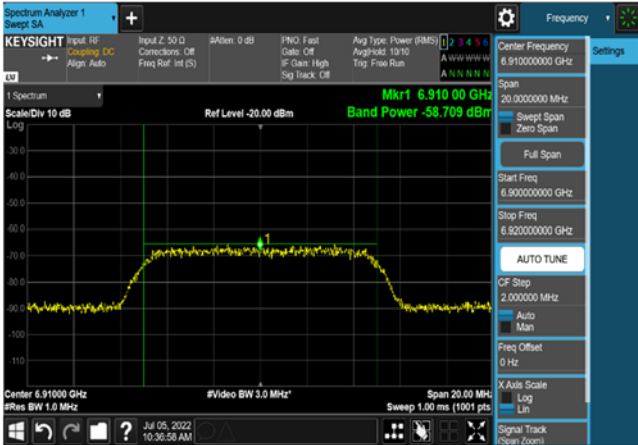

802.11ax_160MHz_6985MHz_AWGN:6985MHz

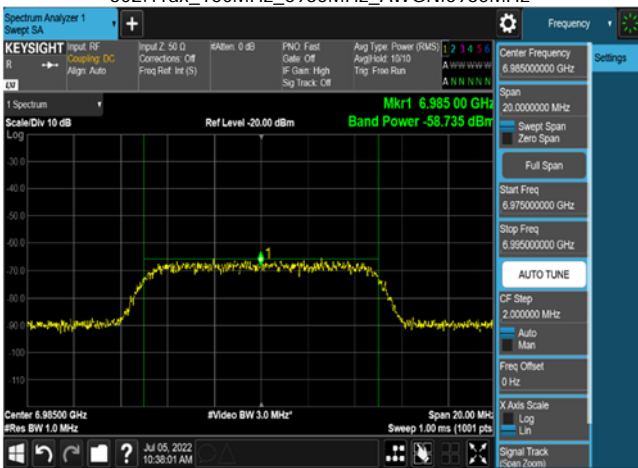

Unless otherwise stated the results shown in this test report refer only to the sample(s) tested and such sample(s) are retained for 90 days only.

除非另有說明，此報告結果僅對測試之樣品負責，同時此樣品僅保留90天。本報告未經本公司書面許可，不可部份複製。

This document is issued by the Company subject to its General Conditions of Service printed overleaf, available on request or accessible at <http://www.sgs.com.tw/Terms-and-Conditions> and for electronic format documents, subject to Terms and Conditions for Electronic Documents at <http://www.sgs.com.tw/Terms-and-Conditions>. Attention is drawn to the limitation of liability, indemnification and jurisdiction issues defined therein. Any holder of this document is advised that information contained herein reflects the Company's findings at the time of its intervention only and within the limits of Client's instructions, if any. The Company's sole responsibility is to its Client and this document does not exonerate parties to a transaction from exercising all their rights and obligations under the transaction documents. This document cannot be reproduced except in full, without prior written approval of the Company. Any unauthorized alteration, forgery or falsification of the content or appearance of this document is unlawful and offenders may be prosecuted to the fullest extent of the law.

13.5 Measurement Result_Client Mode

13.5.1 CBP Detection

Contention Based Protocol											
Band	Bandwidth (MHz)	Channel	Frequency (MHz)	Interference Freq (MHz)	The interference level	Antenna Gain (dBi)	Detection Level of AWGN Interference (dBm)	Detection Trials	AWGN Detection Probability (%)	Limit Probability (%)	Result
U-NII-5	20	37	6135	6135	-62	5.30	-56.70	10	100	90	PASS
	160	47	6185	6110	-62	5.30	-56.70	10	100	90	PASS
				6185	-62	5.30	-56.70	10	100	90	PASS
				6260	-62	5.30	-56.70	10	100	90	PASS
U-NII-6	20	101	6455	6455	-62	5.20	-56.80	10	100	90	PASS
	160	111	6505	6430	-62	5.20	-56.80	10	100	90	PASS
				6505	-62	5.20	-56.80	10	100	90	PASS
				6580	-62	5.20	-56.80	10	100	90	PASS
U-NII-7	20	149	6695	6695	-62	5.20	-56.80	10	100	90	PASS
	160	143	6665	6590	-62	5.20	-56.80	10	100	90	PASS
				6665	-62	5.20	-56.80	10	100	90	PASS
				6740	-62	5.20	-56.80	10	100	90	PASS
U-NII-8	20	213	7015	7015	-62	3.30	-58.70	10	100	90	PASS
	160	207	6985	6910	-62	3.30	-58.70	10	100	90	PASS
				6985	-62	3.30	-58.70	10	100	90	PASS
				7060	-62	3.30	-58.70	10	100	90	PASS

Note : Detection Level of AWGN Interference :-62+min Gain

13.5.2 CBP_Threshold_Level

Contention Based Protocol Threshold Level Verify						
Band	Bandwidth (MHz)	Channel	Frequency (MHz)	Interference Freq (MHz)	Detection Power Level (dBm)	Situation of EUT
U-NII-5	20	37	6135	6135	-69.60	Start transmission
	160	47	6185	6110	-72.60	Start transmission
				6185	-66.60	Start transmission
				6260	-72.60	Start transmission
U-NII-6	20	101	6455	6455	-74.07	Start transmission
	160	111	6505	6430	-76.17	Start transmission
				6505	-70.11	Start transmission
				6580	-75.29	Start transmission
U-NII-7	20	149	6695	6695	-72.20	Start transmission
	160	143	6665	6590	-75.34	Start transmission
				6665	-69.06	Start transmission
				6740	-73.02	Start transmission
U-NII-8	20	213	7015	7015	-71.28	Start transmission
	160	207	6985	6910	-74.14	Start transmission
				6985	-68.35	Start transmission
				7060	-71.18	Start transmission

Unless otherwise stated the results shown in this test report refer only to the sample(s) tested and such sample(s) are retained for 90 days only.

除非另有說明，此報告結果僅對測試之樣品負責，同時此樣品僅保留90天。本報告未經本公司書面許可，不可部份複製。

This document is issued by the Company subject to its General Conditions of Service printed overleaf, available on request or accessible at <http://www.sgs.com.tw/Terms-and-Conditions> and for electronic format documents, subject to Terms and Conditions for Electronic Documents at <http://www.sgs.com.tw/Terms-and-Conditions>. Attention is drawn to the limitation of liability, indemnification and jurisdiction issues defined therein. Any holder of this document is advised that information contained herein reflects the Company's findings at the time of its intervention only and within the limits of Client's instructions, if any. The Company's sole responsibility is to its Client and this document does not exonerate parties to a transaction from exercising all their rights and obligations under the transaction documents. This document cannot be reproduced except in full, without prior written approval of the Company. Any unauthorized alteration, forgery or falsification of the content or appearance of this document is unlawful and offenders may be prosecuted to the fullest extent of the law.

Det LeI_802.11ax_20MHz_CF 6135MHz_6135MHzMHz_-68.6dBm



Det LeI_802.11ax_20MHz_CF 6455MHz_6455MHzMHz_-74.07dBm



Det LeI_802.11ax_20MHz_CF 6135MHz_6135MHzMHz_-69.6dBm



Det LeI_802.11ax_20MHz_CF 6695MHz_6695MHzMHz_-71.2dBm



Det LeI_802.11ax_20MHz_CF 6455MHz_6455MHzMHz_-73.07dBm



Det LeI_802.11ax_20MHz_CF 6695MHz_6695MHzMHz_-72.2dBm



Unless otherwise stated the results shown in this test report refer only to the sample(s) tested and such sample(s) are retained for 90 days only.

除非另有說明，此報告結果僅對測試之樣品負責，同時此樣品僅保留90天。本報告未經本公司書面許可，不可部份複製。

This document is issued by the Company subject to its General Conditions of Service printed overleaf, available on request or accessible at <http://www.sgs.com.tw/Terms-and-Conditions> and for electronic format documents, subject to Terms and Conditions for Electronic Documents at <http://www.sgs.com.tw/Terms-and-Conditions>. Attention is drawn to the limitation of liability, indemnification and jurisdiction issues defined therein. Any holder of this document is advised that information contained herein reflects the Company's findings at the time of its intervention only and within the limits of Client's instructions, if any. The Company's sole responsibility is to its Client and this document does not exonerate parties to a transaction from exercising all their rights and obligations under the transaction documents. This document cannot be reproduced except in full, without prior written approval of the Company. Any unauthorized alteration, forgery or falsification of the content or appearance of this document is unlawful and offenders may be prosecuted to the fullest extent of the law.

Det Le1_802.11ax_20MHz_CF 7015MHz_7015MHz_-70.28dBm



Det Le1_802.11ax_160MHz_CF 6185MHz_6110MHz_-72.6dBm



Det Le1_802.11ax_20MHz_CF 7015MHz_7015MHz_-71.28dBm



Det Le1_802.11ax_160MHz_CF 6185MHz_6185MHz_-65.6dBm



Det Le1_802.11ax_160MHz_CF 6185MHz_6110MHz_-71.6dBm



Det Le1_802.11ax_160MHz_CF 6185MHz_6185MHz_-66.6dBm

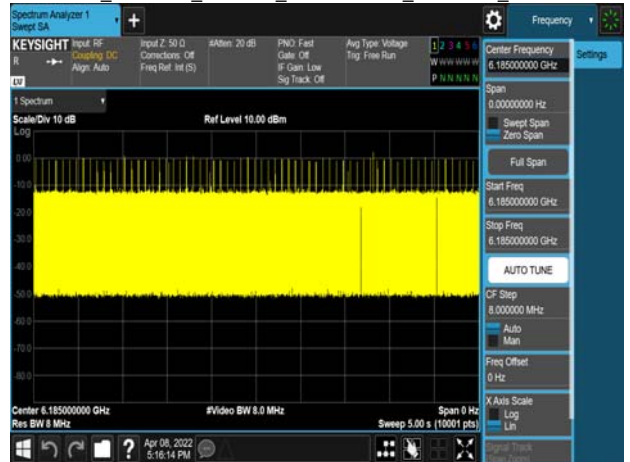

Unless otherwise stated the results shown in this test report refer only to the sample(s) tested and such sample(s) are retained for 90 days only.

除非另有說明，此報告結果僅對測試之樣品負責，同時此樣品僅保留90天。本報告未經本公司書面許可，不可部份複製。

This document is issued by the Company subject to its General Conditions of Service printed overleaf, available on request or accessible at <http://www.sgs.com.tw/Terms-and-Conditions> and for electronic format documents, subject to Terms and Conditions for Electronic Documents at <http://www.sgs.com.tw/Terms-and-Conditions>. Attention is drawn to the limitation of liability, indemnification and jurisdiction issues defined therein. Any holder of this document is advised that information contained herein reflects the Company's findings at the time of its intervention only and within the limits of Client's instructions, if any. The Company's sole responsibility is to its Client and this document does not exonerate parties to a transaction from exercising all their rights and obligations under the transaction documents. This document cannot be reproduced except in full, without prior written approval of the Company. Any unauthorized alteration, forgery or falsification of the content or appearance of this document is unlawful and offenders may be prosecuted to the fullest extent of the law.

Det Le1_802.11ax_160MHz_CF 6185MHz_6260MHz_-71.6dBm



Det Le1_802.11ax_160MHz_CF 6505MHz_6430MHz_-76.17dBm

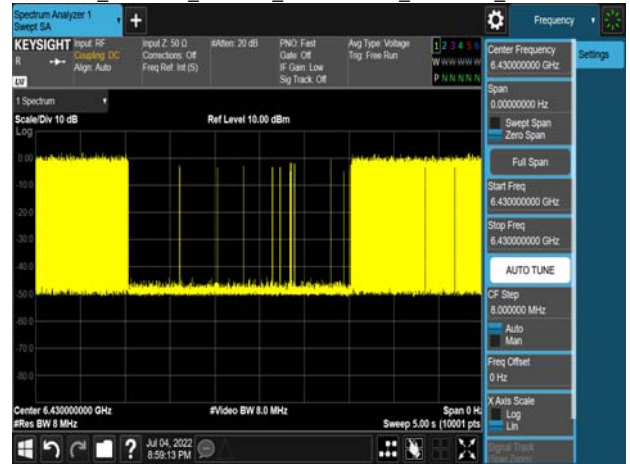

Det Le1_802.11ax_160MHz_CF 6185MHz_6260MHz_-72.6dBm



Det Le1_802.11ax_160MHz_CF 6505MHz_6505MHz_-69.11dBm



Det Le1_802.11ax_160MHz_CF 6505MHz_6430MHz_-75.17dBm

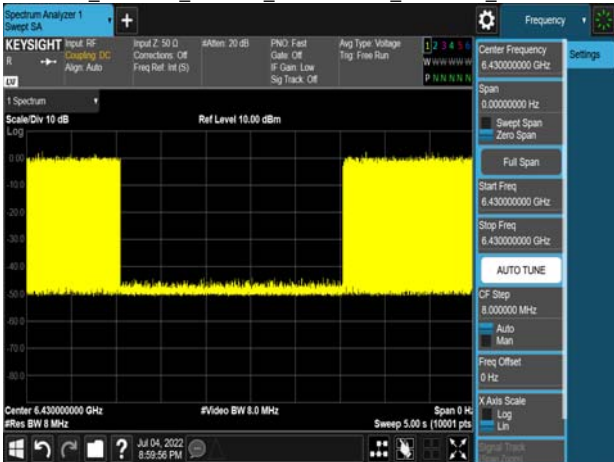

Det Le1_802.11ax_160MHz_CF 6505MHz_6505MHz_-70.11dBm



Unless otherwise stated the results shown in this test report refer only to the sample(s) tested and such sample(s) are retained for 90 days only.

除非另有說明，此報告結果僅對測試之樣品負責，同時此樣品僅保留90天。本報告未經本公司書面許可，不可部份複製。

This document is issued by the Company subject to its General Conditions of Service printed overleaf, available on request or accessible at <http://www.sgs.com.tw/Terms-and-Conditions> and for electronic format documents, subject to Terms and Conditions for Electronic Documents at <http://www.sgs.com.tw/Terms-and-Conditions>. Attention is drawn to the limitation of liability, indemnification and jurisdiction issues defined therein. Any holder of this document is advised that information contained herein reflects the Company's findings at the time of its intervention only and within the limits of Client's instructions, if any. The Company's sole responsibility is to its Client and this document does not exonerate parties to a transaction from exercising all their rights and obligations under the transaction documents. This document cannot be reproduced except in full, without prior written approval of the Company. Any unauthorized alteration, forgery or falsification of the content or appearance of this document is unlawful and offenders may be prosecuted to the fullest extent of the law.

Det Le1_802.11ax_160MHz_CF 6505MHz_6580MHz_-74.29dBm

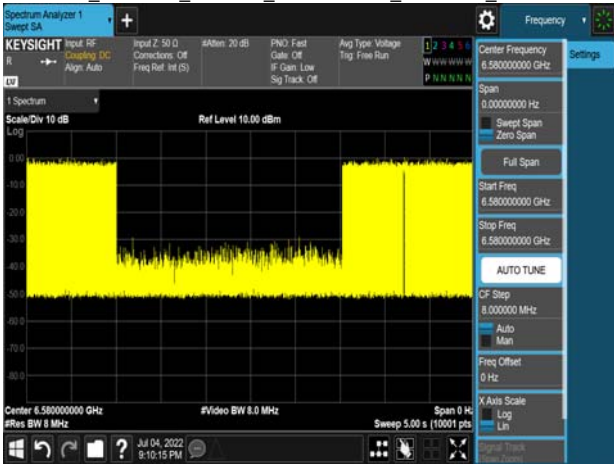

Det Le1_802.11ax_160MHz_CF 6665MHz_6590MHz_-75.339dBm



Det Le1_802.11ax_160MHz_CF 6505MHz_6580MHz_-75.29dBm

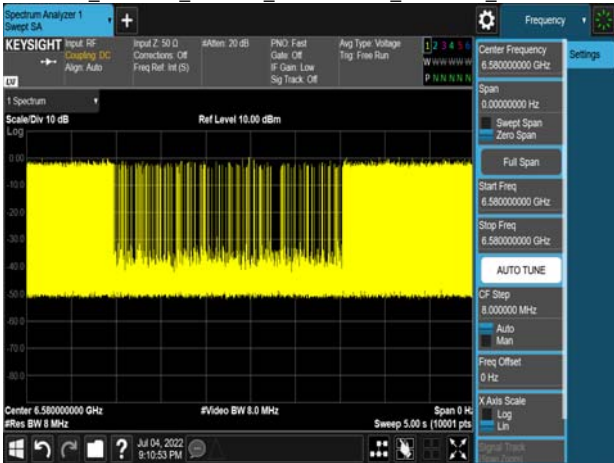

Det Le1_802.11ax_160MHz_CF 6665MHz_6665MHz_-68.06dBm



Det Le1_802.11ax_160MHz_CF 6665MHz_6590MHz_-74.339dBm

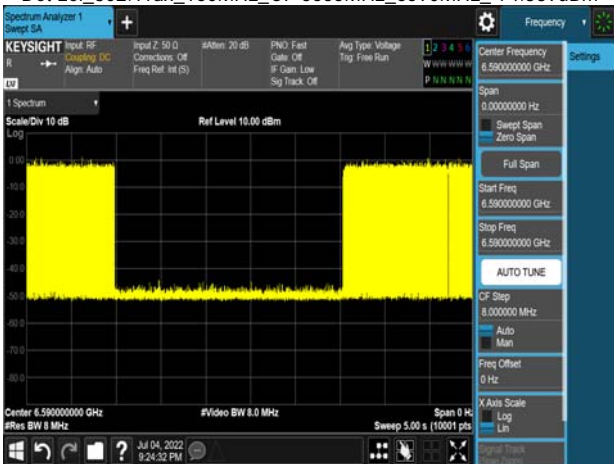

Det Le1_802.11ax_160MHz_CF 6665MHz_6665MHz_-69.06dBm

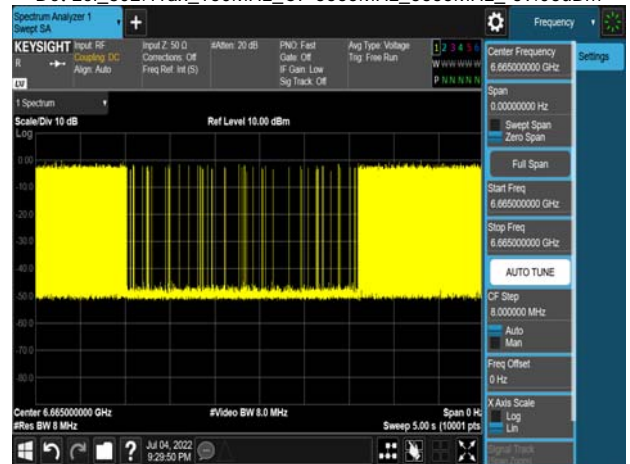

Unless otherwise stated the results shown in this test report refer only to the sample(s) tested and such sample(s) are retained for 90 days only.

除非另有說明，此報告結果僅對測試之樣品負責，同時此樣品僅保留90天。本報告未經本公司書面許可，不可部份複製。

This document is issued by the Company subject to its General Conditions of Service printed overleaf, available on request or accessible at <http://www.sgs.com.tw/Terms-and-Conditions> and for electronic format documents, subject to Terms and Conditions for Electronic Documents at <http://www.sgs.com.tw/Terms-and-Conditions>. Attention is drawn to the limitation of liability, indemnification and jurisdiction issues defined therein. Any holder of this document is advised that information contained herein reflects the Company's findings at the time of its intervention only and within the limits of Client's instructions, if any. The Company's sole responsibility is to its Client and this document does not exonerate parties to a transaction from exercising all their rights and obligations under the transaction documents. This document cannot be reproduced except in full, without prior written approval of the Company. Any unauthorized alteration, forgery or falsification of the content or appearance of this document is unlawful and offenders may be prosecuted to the fullest extent of the law.

Det Lel_802.11ax_160MHz_CF 6665MHz_6740MHz_-72.02dBm

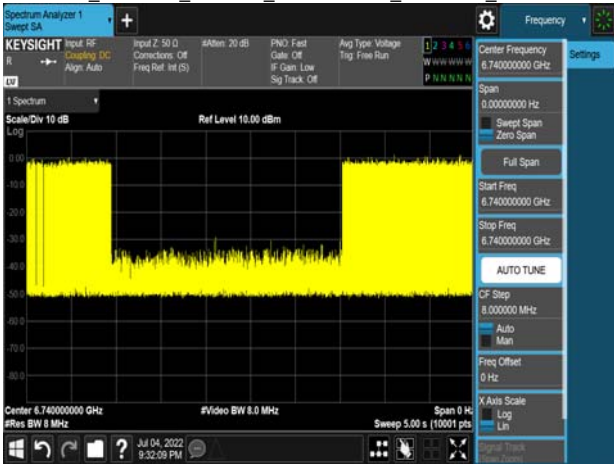

Det Lel_802.11ax_160MHz_CF 6985MHz_6910MHz_-74.14dBm



Det Lel_802.11ax_160MHz_CF 6665MHz_6740MHz_-73.02dBm



Det Lel_802.11ax_160MHz_CF 6985MHz_6985MHz_-67.35dBm

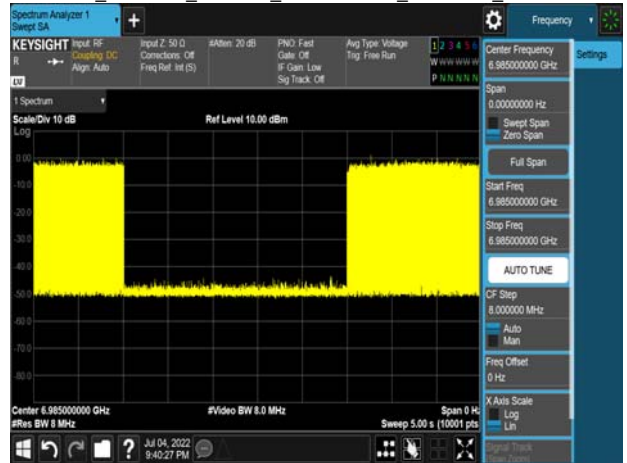

Det Lel_802.11ax_160MHz_CF 6985MHz_6910MHz_-73.14dBm



Det Lel_802.11ax_160MHz_CF 6985MHz_6985MHz_-68.35dBm

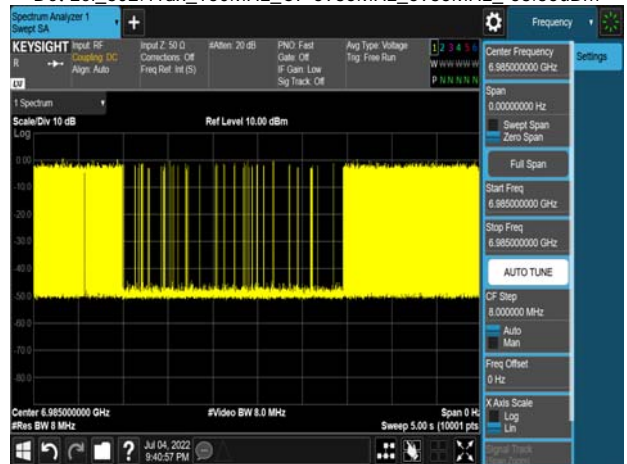

Unless otherwise stated the results shown in this test report refer only to the sample(s) tested and such sample(s) are retained for 90 days only.

除非另有說明，此報告結果僅對測試之樣品負責，同時此樣品僅保留90天。本報告未經本公司書面許可，不可部份複製。

This document is issued by the Company subject to its General Conditions of Service printed overleaf, available on request or accessible at <http://www.sgs.com.tw/Terms-and-Conditions> and for electronic format documents, subject to Terms and Conditions for Electronic Documents at <http://www.sgs.com.tw/Terms-and-Conditions>. Attention is drawn to the limitation of liability, indemnification and jurisdiction issues defined therein. Any holder of this document is advised that information contained herein reflects the Company's findings at the time of its intervention only and within the limits of Client's instructions, if any. The Company's sole responsibility is to its Client and this document does not exonerate parties to a transaction from exercising all their rights and obligations under the transaction documents. This document cannot be reproduced except in full, without prior written approval of the Company. Any unauthorized alteration, forgery or falsification of the content or appearance of this document is unlawful and offenders may be prosecuted to the fullest extent of the law.

Det Lel_802.11ax_160MHz_CF 6985MHz_7060MHz_-70.18dBm

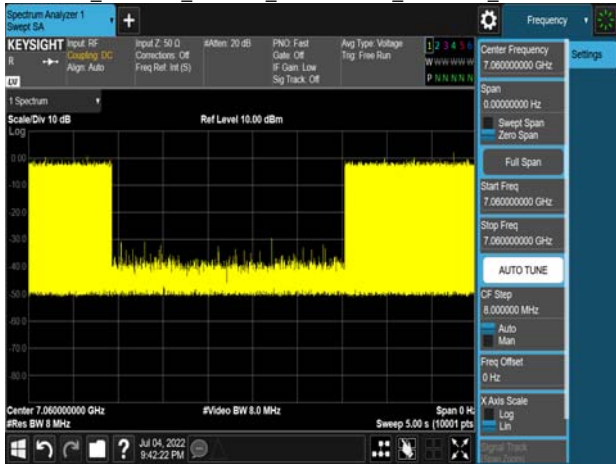

Det Lel_802.11ax_160MHz_CF 6985MHz_7060MHz_-71.18dBm



Unless otherwise stated the results shown in this test report refer only to the sample(s) tested and such sample(s) are retained for 90 days only.

除非另有說明，此報告結果僅對測試之樣品負責，同時此樣品僅保留90天。本報告未經本公司書面許可，不可部份複製。

This document is issued by the Company subject to its General Conditions of Service printed overleaf, available on request or accessible at <http://www.sgs.com.tw/Terms-and-Conditions> and for electronic format documents, subject to Terms and Conditions for Electronic Documents at <http://www.sgs.com.tw/Terms-and-Conditions>. Attention is drawn to the limitation of liability, indemnification and jurisdiction issues defined therein. Any holder of this document is advised that information contained hereon reflects the Company's findings at the time of its intervention only and within the limits of Client's instructions, if any. The Company's sole responsibility is to its Client and this document does not exonerate parties to a transaction from exercising all their rights and obligations under the transaction documents. This document cannot be reproduced except in full, without prior written approval of the Company. Any unauthorized alteration, forgery or falsification of the content or appearance of this document is unlawful and offenders may be prosecuted to the fullest extent of the law.

13.5.3 Incumbent_signal

802.11ax_20MHz_6135MHz_AWGN:6135MHz



802.11ax_20MHz_7015MHz_AWGN:7015MHz

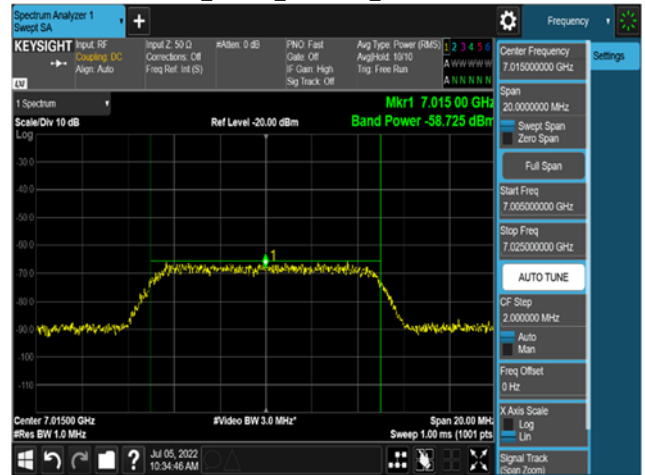

802.11ax_20MHz_6455MHz_AWGN:6455MHz

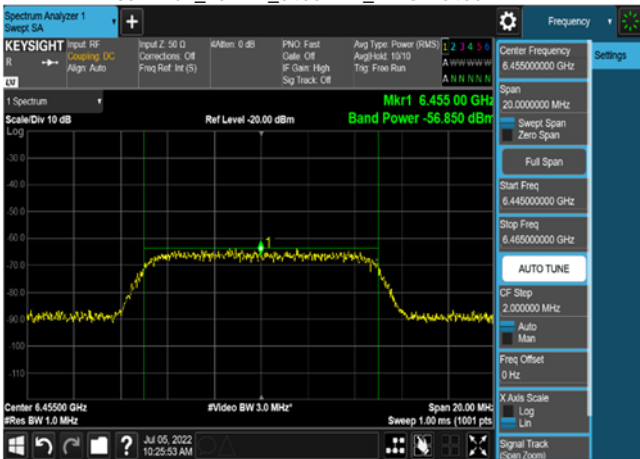

802.11ax_160MHz_6185MHz_AWGN:6110

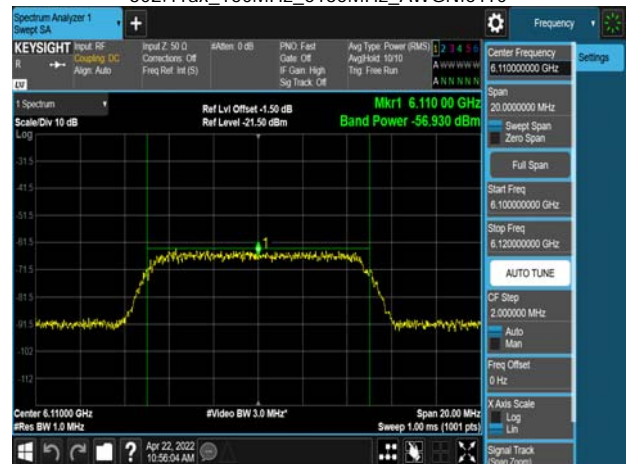

802.11ax_20MHz_6695MHz_AWGN:6695MHz



802.11ax_160MHz_6185MHz_AWGN:6185MHz



Unless otherwise stated the results shown in this test report refer only to the sample(s) tested and such sample(s) are retained for 90 days only.

除非另有說明，此報告結果僅對測試之樣品負責，同時此樣品僅保留90天。本報告未經本公司書面許可，不可部份複製。

This document is issued by the Company subject to its General Conditions of Service printed overleaf, available on request or accessible at <http://www.sgs.com.tw/Terms-and-Conditions> and for electronic format documents, subject to Terms and Conditions for Electronic Documents at <http://www.sgs.com.tw/Terms-and-Conditions>. Attention is drawn to the limitation of liability, indemnification and jurisdiction issues defined therein. Any holder of this document is advised that information contained herein reflects the Company's findings at the time of its intervention only and within the limits of Client's instructions, if any. The Company's sole responsibility is to its Client and this document does not exonerate parties to a transaction from exercising all their rights and obligations under the transaction documents. This document cannot be reproduced except in full, without prior written approval of the Company. Any unauthorized alteration, forgery or falsification of the content or appearance of this document is unlawful and offenders may be prosecuted to the fullest extent of the law.

802.11ax_160MHz_6185MHz_AWGN:6260



802.11ax_160MHz_6505MHz_AWGN:6580

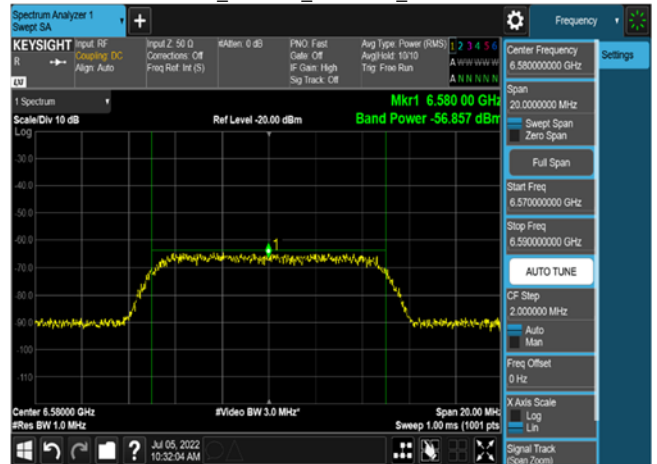

802.11ax_160MHz_6505MHz_AWGN:6430

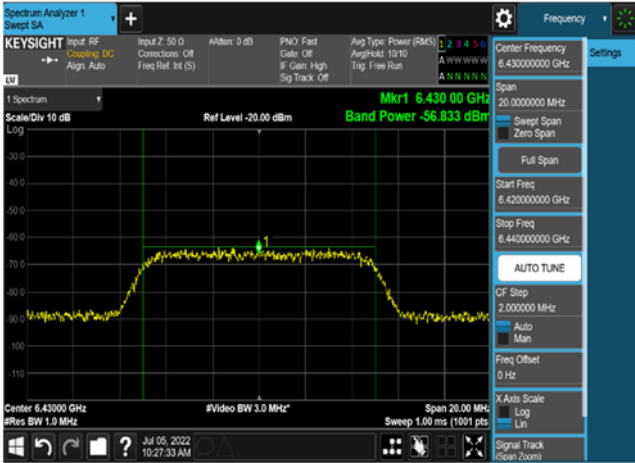

802.11ax_160MHz_6665MHz_AWGN:6590

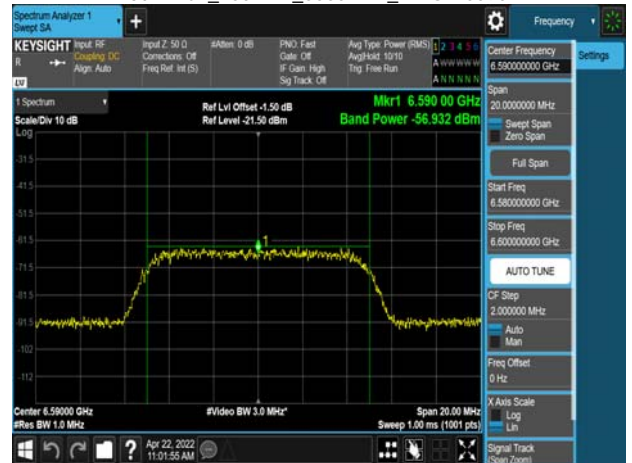

802.11ax_160MHz_6505MHz_AWGN:6505MHz

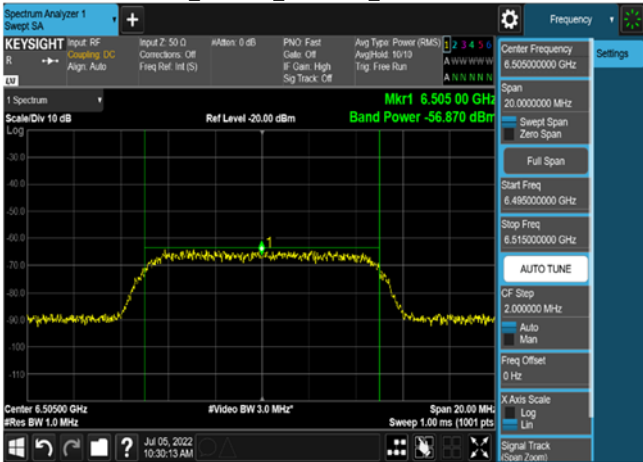

802.11ax_160MHz_6665MHz_AWGN:6665MHz



Unless otherwise stated the results shown in this test report refer only to the sample(s) tested and such sample(s) are retained for 90 days only.

除非另有說明，此報告結果僅對測試之樣品負責，同時此樣品僅保留90天。本報告未經本公司書面許可，不可部份複製。

This document is issued by the Company subject to its General Conditions of Service printed overleaf, available on request or accessible at <http://www.sgs.com.tw/Terms-and-Conditions> and for electronic format documents, subject to Terms and Conditions for Electronic Documents at <http://www.sgs.com.tw/Terms-and-Conditions>. Attention is drawn to the limitation of liability, indemnification and jurisdiction issues defined therein. Any holder of this document is advised that information contained herein reflects the Company's findings at the time of its intervention only and within the limits of Client's instructions, if any. The Company's sole responsibility is to its Client and this document does not exonerate parties to a transaction from exercising all their rights and obligations under the transaction documents. This document cannot be reproduced except in full, without prior written approval of the Company. Any unauthorized alteration, forgery or falsification of the content or appearance of this document is unlawful and offenders may be prosecuted to the fullest extent of the law.

802.11ax_160MHz_6665MHz_AWGN:6740



802.11ax_160MHz_6985MHz_AWGN:7060

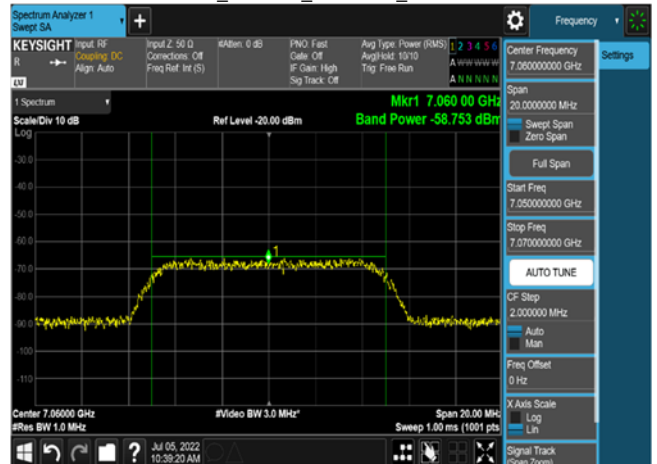

802.11ax_160MHz_6985MHz_AWGN:6910

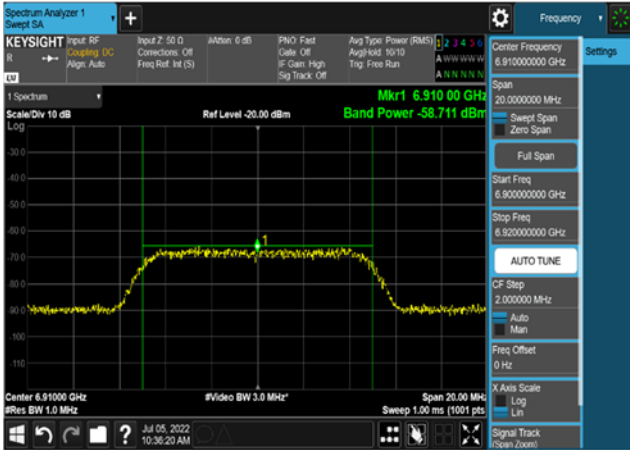

802.11ax_160MHz_6985MHz_AWGN:6985MHz

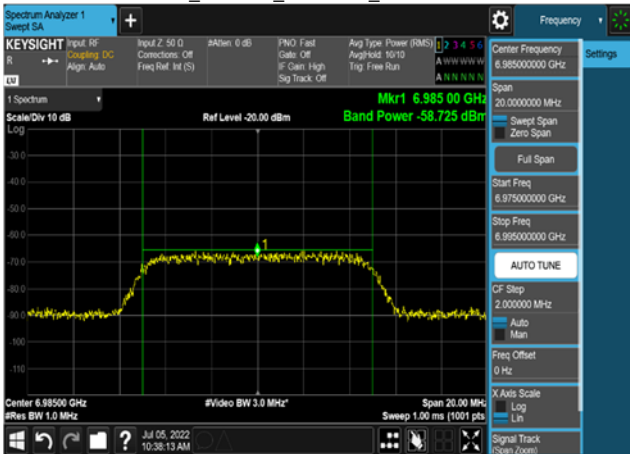

Unless otherwise stated the results shown in this test report refer only to the sample(s) tested and such sample(s) are retained for 90 days only.

除非另有說明，此報告結果僅對測試之樣品負責，同時此樣品僅保留90天。本報告未經本公司書面許可，不可部份複製。

This document is issued by the Company subject to its General Conditions of Service printed overleaf, available on request or accessible at <http://www.sgs.com.tw/Terms-and-Conditions> and for electronic format documents, subject to Terms and Conditions for Electronic Documents at <http://www.sgs.com.tw/Terms-and-Conditions>. Attention is drawn to the limitation of liability, indemnification and jurisdiction issues defined therein. Any holder of this document is advised that information contained herein reflects the Company's findings at the time of its intervention only and within the limits of Client's instructions, if any. The Company's sole responsibility is to its Client and this document does not exonerate parties to a transaction from exercising all their rights and obligations under the transaction documents. This document cannot be reproduced except in full, without prior written approval of the Company. Any unauthorized alteration, forgery or falsification of the content or appearance of this document is unlawful and offenders may be prosecuted to the fullest extent of the law.

14 DUAL CLIENT TEST, DEMONSTRATION OF PROPER POWER ADJUSTMENT BASED ON ASSOCIATED AP

14.1 Standard Applicable

A client device may connect to a Standard Power AP with a maximum power level of 30 dBm EIRP. A client may also connect to a Low Power indoor AP, but the power level is limited to a maximum of 24 dBm EIRP. If a client has the flexibility to connect to both APs, verification is needed to show that it can distinguish between the two configurations, and then control the power levels accordingly.

14.2 Measurement Procedure

1. Connect equipment as shown in Figure 6 below.
2. Adjust Atten 2 to Std Power AP so as to facilitate error free communication with the Client (Atten 1 should be set to High on the RF path to the Low Power AP).
3. Configure the Client and APs so that they associate and start sending data (stream data). It is important that the client is configured to transmit at its highest power level. Initially, because the attenuation on Atten 1 is set high, the Client will only associate with the Std Power AP.
4. Verify transmission between Client and Std Power AP. Additional attenuators may be required to protect measurement equipment. Measure the Client RF power using any of the methods in C63.10 for NII devices. Note – if the client RF power has been certified to never operate above 24 dBm EIRP then this test is not necessary.
5. Gradually increase Atten 2 while at the same time decreasing Atten 1. This simulates the Client moving from outdoors to indoors. At some level of attenuation the Client should associate with the Low Power indoor AP. Verify transmission between Client and Low Power AP.
6. Measure the RF power of the Client device using the same method as in step 4. Verify the power is no more than 24 dBm EIRP.

Note – measuring Client RF power reliably from a directional coupler measurement port may be tricky. Due to coupling, some energy from the AP will show up on the measurement port. Signal isolation techniques on the measurement analyzer will need to be used.

Unless otherwise stated the results shown in this test report refer only to the sample(s) tested and such sample(s) are retained for 90 days only.

除非另有說明，此報告結果僅對測試之樣品負責，同時此樣品僅保留90天。本報告未經本公司書面許可，不可部份複製。

This document is issued by the Company subject to its General Conditions of Service printed overleaf, available on request or accessible at <http://www.sgs.com.tw/Terms-and-Conditions> and for electronic format documents, subject to Terms and Conditions for Electronic Documents at <http://www.sgs.com.tw/Terms-and-Conditions>. Attention is drawn to the limitation of liability, indemnification and jurisdiction issues defined therein. Any holder of this document is advised that information contained hereon reflects the Company's findings at the time of its intervention only and within the limits of Client's instructions, if any. The Company's sole responsibility is to its Client and this document does not exonerate parties to a transaction from exercising all their rights and obligations under the transaction documents. This document cannot be reproduced except in full, without prior written approval of the Company. Any unauthorized alteration, forgery or falsification of the content or appearance of this document is unlawful and offenders may be prosecuted to the fullest extent of the law.

14.3 Test Setup

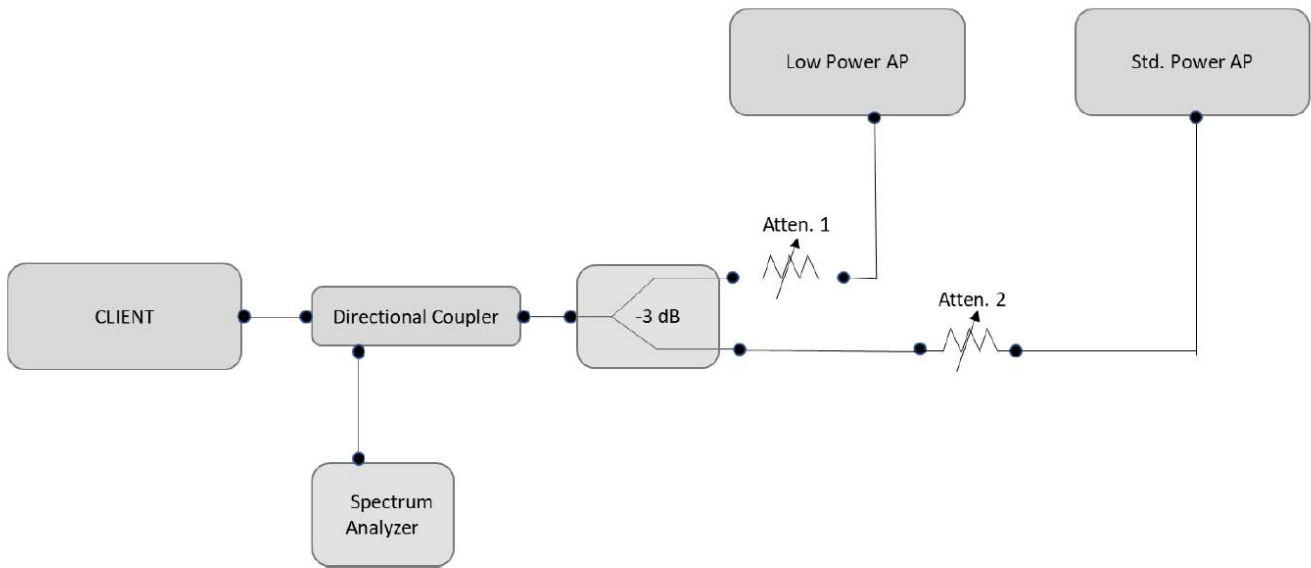

Figure 6. Test setup for conducted testing

14.4 Measurement Result

N/A, Device only associates with indoor AP.

Unless otherwise stated the results shown in this test report refer only to the sample(s) tested and such sample(s) are retained for 90 days only.

除非另有說明，此報告結果僅對測試之樣品負責，同時此樣品僅保留90天。本報告未經本公司書面許可，不可部份複製。

This document is issued by the Company subject to its General Conditions of Service printed overleaf, available on request or accessible at <http://www.sgs.com.tw/Terms-and-Conditions> and for electronic format documents, subject to Terms and Conditions for Electronic Documents at <http://www.sgs.com.tw/Terms-and-Conditions>. Attention is drawn to the limitation of liability, indemnification and jurisdiction issues defined therein. Any holder of this document is advised that information contained hereon reflects the Company's findings at the time of its intervention only and within the limits of Client's instructions, if any. The Company's sole responsibility is to its Client and this document does not exonerate parties to a transaction from exercising all their rights and obligations under the transaction documents. This document cannot be reproduced except in full, without prior written approval of the Company. Any unauthorized alteration, forgery or falsification of the content or appearance of this document is unlawful and offenders may be prosecuted to the fullest extent of the law.

15 ANTENNA REQUIREMENT

15.1 Standard Applicable

An intentional radiator shall be designed to ensure that no antenna other than that furnished by the responsible party shall be used with the device. The use of a permanently attached antenna or of an antenna that uses a unique coupling to the intentional radiator shall be considered sufficient to comply with the provisions of this section. The manufacturer may design the unit so that a broken antenna can be replaced by the user, but the use of a standard antenna jack or electrical connector is prohibited. This requirement does not apply to carrier current devices or to devices operated under the provisions of §§ 15.211, 15.213, 15.217, 15.219, 15.221, or § 15.236. Further, this requirement does not apply to intentional radiators that must be professionally installed, such as perimeter protection systems and some field disturbance sensors, or to other intentional radiators which, in accordance with § 15.31(d), must be measured at the installation site. However, the installer shall be responsible for ensuring that the proper antenna is employed so that the limits in this part are not exceeded.

15.2 Antenna Connected Construction

The antenna is designed as permanently attached and no consideration of replacement. Please see EUT photo for details.

~ End of Report ~

Unless otherwise stated the results shown in this test report refer only to the sample(s) tested and such sample(s) are retained for 90 days only.

除非另有說明，此報告結果僅對測試之樣品負責，同時此樣品僅保留90天。本報告未經本公司書面許可，不可部份複製。

This document is issued by the Company subject to its General Conditions of Service printed overleaf, available on request or accessible at <http://www.sgs.com.tw/Terms-and-Conditions> and for electronic format documents, subject to Terms and Conditions for Electronic Documents at <http://www.sgs.com.tw/Terms-and-Conditions>. Attention is drawn to the limitation of liability, indemnification and jurisdiction issues defined therein. Any holder of this document is advised that information contained hereon reflects the Company's findings at the time of its intervention only and within the limits of Client's instructions, if any. The Company's sole responsibility is to its Client and this document does not exonerate parties to a transaction from exercising all their rights and obligations under the transaction documents. This document cannot be reproduced except in full, without prior written approval of the Company. Any unauthorized alteration, forgery or falsification of the content or appearance of this document is unlawful and offenders may be prosecuted to the fullest extent of the law.