

# ELECTROMAGNETIC EMISSIONS COMPLIANCE REPORT



**Applicant:** GOOGLE LLC  
1600 Amphitheatre Parkway Mountain View, CA 94043

**Manufacturer:** GOOGLE LLC  
1600 Amphitheatre Parkway Mountain View, CA 94043

**Product Name:** Wireless product

**Brand Name:** GOOGLE

**Model No.:** G6ZUC

**Report Number:** ER/2022/30038

**FCC ID** A4R-G6ZUC

**Date of EUT Received:** March 10, 2022

**Date of Test:** March 15, 2022 ~ May 12, 2022

**Issue Date:** June 14, 2022

Approved By \_\_\_\_\_

**Blue Yang**

## We hereby certify that:

The above equipment was tested by SGS Taiwan Ltd. Central RF Lab The test data, data evaluation, test procedures, and equipment configurations shown in this report were made in accordance with the procedures given in ANSI C63.10:2013 and the energy emitted by the sample EUT comply with FCC rule part §15.407.

The results of this report relate only to the sample identified in this report.

Unless otherwise stated the results shown in this test report refer only to the sample(s) tested and such sample(s) are retained for 90 days only.

除非另有說明，此報告結果僅對測試之樣品負責，同時此樣品僅保留90天。本報告未經本公司書面許可，不可部份複製。

This document is issued by the Company subject to its General Conditions of Service printed overleaf, available on request or accessible at <http://www.sgs.com.tw/Terms-and-Conditions> and for electronic format documents, subject to Terms and Conditions for Electronic Documents at <http://www.sgs.com.tw/Terms-and-Conditions>. Attention is drawn to the limitation of liability, indemnification and jurisdiction issues defined therein. Any holder of this document is advised that information contained hereon reflects the Company's findings at the time of its intervention only and within the limits of Client's instructions, if any. The Company's sole responsibility is to its Client and this document does not exonerate parties to a transaction from exercising all their rights and obligations under the transaction documents. This document cannot be reproduced except in full, without prior written approval of the Company. Any unauthorized alteration, forgery or falsification of the content or appearance of this document is unlawful and offenders may be prosecuted to the fullest extent of the law.

Revision History					
Report Number	Revision	Description	Issue Date	Revised By	Remark
ER/2022/30038	00	Original	May 24, 2022	Violetta Tang	*
ER/2022/30038	01	Update test procedure on page 61, 86	June 1, 2022	Violetta Tang	*
ER/2022/30038	02	1. Update summary of test items on page 12 2. Remove transmission in the absence of data chapter	June 14, 2022	Violetta Tang	

**Note:**

- 1、The remark "\*" indicates modification of the report upon requests from certification body.

Unless otherwise stated the results shown in this test report refer only to the sample(s) tested and such sample(s) are retained for 90 days only.

除非另有說明，此報告結果僅對測試之樣品負責，同時此樣品僅保留90天。本報告未經本公司書面許可，不可部份複製。

This document is issued by the Company subject to its General Conditions of Service printed overleaf, available on request or accessible at <http://www.sgs.com.tw/Terms-and-Conditions> and for electronic format documents, subject to Terms and Conditions for Electronic Documents at <http://www.sgs.com.tw/Terms-and-Conditions>. Attention is drawn to the limitation of liability, indemnification and jurisdiction issues defined therein. Any holder of this document is advised that information contained hereon reflects the Company's findings at the time of its intervention only and within the limits of Client's instructions, if any. The Company's sole responsibility is to its Client and this document does not exonerate parties to a transaction from exercising all their rights and obligations under the transaction documents. This document cannot be reproduced except in full, without prior written approval of the Company. Any unauthorized alteration, forgery or falsification of the content or appearance of this document is unlawful and offenders may be prosecuted to the fullest extent of the law.

## Contents

1	GENERAL INFORMATION .....	4
2	SYSTEM TEST CONFIGURATION .....	8
3	SUMMARY OF TEST RESULT .....	12
4	DESCRIPTION OF TEST MODES .....	13
5	MEASUREMENT UNCERTAINTY .....	17
6	MEASUREMENT EQUIPMENT USED .....	18
7	CONDUCTED EMISSION TEST .....	20
8	EMISSION BANDWIDTH MEASUREMENT .....	23
9	MAXIMUM CONDUCTED OUTPUT POWER MEASUREMENT .....	52
10	MAXIMUM POWER SPECTRAL DENSITY .....	60
11	UNDESIRABLE RADIATED EMISSION MEASUREMENT .....	83
12	ANTENNA REQUIREMENT .....	308

Unless otherwise stated the results shown in this test report refer only to the sample(s) tested and such sample(s) are retained for 90 days only.

除非另有說明，此報告結果僅對測試之樣品負責，同時此樣品僅保留90天。本報告未經本公司書面許可，不可部份複製。  
This document is issued by the Company subject to its General Conditions of Service printed overleaf, available on request or accessible at <http://www.sgs.com.tw/Terms-and-Conditions> and for electronic format documents, subject to Terms and Conditions for Electronic Documents at <http://www.sgs.com.tw/Terms-and-Conditions>. Attention is drawn to the limitation of liability, indemnification and jurisdiction issues defined therein. Any holder of this document is advised that information contained hereon reflects the Company's findings at the time of its intervention only and within the limits of Client's instructions, if any. The Company's sole responsibility is to its Client and this document does not exonerate parties to a transaction from exercising all their rights and obligations under the transaction documents. This document cannot be reproduced except in full, without prior written approval of the Company. Any unauthorized alteration, forgery or falsification of the content or appearance of this document is unlawful and offenders may be prosecuted to the fullest extent of the law.

# 1 GENERAL INFORMATION

## 1.1 Product Description

Product Name:	Wireless product
Brand Name:	GOOGLE
Model No.:	G6ZUC
EUT Series No.:	GG1937366 / GG1935428
Power Supply:	10V from AC Adapter
Test Software (Name/Version)	Qualcomm Radio Control Tool /V4.0.00195

## 1.2 Modulation & Data Rate

Modulation type:	64QAM, 16QAM, QPSK, BPSK for OFDM
	256QAM for OFDM in 802.11ac
	256QAM, 1024QAM for OFDMA in 802.11ax
Transition Rate:	802.11 a: 6 - 54 Mbps
	802.11 n_20MHz: 6.5 - 144.4 Mbps
	802.11 n_40MHz: 13.5 - 300 Mbps
	802.11 ac_20MHz: 6.5 - 173.4 Mbps
	802.11 ac_40MHz: 13.5 - 400 Mbps
	802.11 ac_80MHz: 29.3 - 866.6 Mbps
	802.11 ac_160MHz: 58.5 - 1733.4 Mbps
	802.11 ax_20MHz: 8.6 - 286.8 Mbps
	802.11 ax_40MHz: 17.2 - 573.6 Mbps
	802.11 ax_80MHz: 36 - 1201 Mbps
802.11 ax_160MHz: 68 - 2402 Mbps	

Unless otherwise stated the results shown in this test report refer only to the sample(s) tested and such sample(s) are retained for 90 days only.

除非另有說明，此報告結果僅對測試之樣品負責，同時此樣品僅保留90天。本報告未經本公司書面許可，不可部份複製。

This document is issued by the Company subject to its General Conditions of Service printed overleaf, available on request or accessible at <http://www.sgs.com.tw/Terms-and-Conditions> and for electronic format documents, subject to Terms and Conditions for Electronic Documents at <http://www.sgs.com.tw/Terms-and-Conditions>. Attention is drawn to the limitation of liability, indemnification and jurisdiction issues defined therein. Any holder of this document is advised that information contained hereon reflects the Company's findings at the time of its intervention only and within the limits of Client's instructions, if any. The Company's sole responsibility is to its Client and this document does not exonerate parties to a transaction from exercising all their rights and obligations under the transaction documents. This document cannot be reproduced except in full, without prior written approval of the Company. Any unauthorized alteration, forgery or falsification of the content or appearance of this document is unlawful and offenders may be prosecuted to the fullest extent of the law.

### 1.3 Antenna Designation

Antenna Type	Part No.	Freq.(MHz)	Peak Gain (dBi)	Worst combination
PIFA	ANT1	5150~5250	4.80	V
		5725~5850	5.00	V
		5850~5895	5.00	V
PIFA	ANT3	5150~5250	4.50	V
		5725~5850	3.30	V
		5850~5895	3.30	V
PIFA	ANT2	5150~5250	3.70	
		5725~5850	3.30	
		5850~5895	3.30	
PIFA	ANT4	5150~5250	3.70	
		5725~5850	3.30	
		5850~5895	3.30	

**Note:**

1. Pre-scanned was done on the above antenna combination, measurements were demonstrated by using the antenna with the highest gain as the worst case scenarios.
2. Antenna information is provided by the applicant.
3. The EUT antenna combination is cross polarization.

Unless otherwise stated the results shown in this test report refer only to the sample(s) tested and such sample(s) are retained for 90 days only.

除非另有說明，此報告結果僅對測試之樣品負責，同時此樣品僅保留90天。本報告未經本公司書面許可，不可部份複製。  
 This document is issued by the Company subject to its General Conditions of Service printed overleaf, available on request or accessible at <http://www.sgs.com.tw/Terms-and-Conditions> and for electronic format documents, subject to Terms and Conditions for Electronic Documents at <http://www.sgs.com.tw/Terms-and-Conditions>. Attention is drawn to the limitation of liability, indemnification and jurisdiction issues defined therein. Any holder of this document is advised that information contained hereon reflects the Company's findings at the time of its intervention only and within the limits of Client's instructions, if any. The Company's sole responsibility is to its Client and this document does not exonerate parties to a transaction from exercising all their rights and obligations under the transaction documents. This document cannot be reproduced except in full, without prior written approval of the Company. Any unauthorized alteration, forgery or falsification of the content or appearance of this document is unlawful and offenders may be prosecuted to the fullest extent of the law.

1.4 FCC

Wi-Fi	Frequency Range	Channels	Rated Power(Avg) (dBm) (Worst Case)	Modulation Technology
a n_HT ac_VHT ax_HE 20M	5180~5240	4	26.23 dBm	OFDM, OFDMA
	5745-5825	5	28.18 dBm	
	5850-5895	3	28.01 dBm	
n_HT ac_VHT ax_HE 40M	5190~5230	2	28.44 dBm	OFDM, OFDMA
	5755-5795	2	28.55 dBm	
	5850-5895	2	28.48 dBm	
ac_VHT ax_HE 80M	5210	1	21.37 dBm	OFDM, OFDMA
	5775	1	25.29 dBm	
	5850-5895	1	27.90 dBm	
ac_VHT ax_HE 160M	5815	1	25.73 dBm	OFDM, OFDMA

Unless otherwise stated the results shown in this test report refer only to the sample(s) tested and such sample(s) are retained for 90 days only.

除非另有說明，此報告結果僅對測試之樣品負責，同時此樣品僅保留90天。本報告未經本公司書面許可，不可部份複製。

This document is issued by the Company subject to its General Conditions of Service printed overleaf, available on request or accessible at <http://www.sgs.com.tw/Terms-and-Conditions> and for electronic format documents, subject to Terms and Conditions for Electronic Documents at <http://www.sgs.com.tw/Terms-and-Conditions>. Attention is drawn to the limitation of liability, indemnification and jurisdiction issues defined therein. Any holder of this document is advised that information contained hereon reflects the Company's findings at the time of its intervention only and within the limits of Client's instructions, if any. The Company's sole responsibility is to its Client and this document does not exonerate parties to a transaction from exercising all their rights and obligations under the transaction documents. This document cannot be reproduced except in full, without prior written approval of the Company. Any unauthorized alteration, forgery or falsification of the content or appearance of this document is unlawful and offenders may be prosecuted to the fullest extent of the law.

### 1.5 Test Methodology of Applied Standards

FCC Part 15, Subpart E §15.407  
 FCC KDB 789033 D02 General UNII Test Procedures New Rules v02r01  
 FCC KDB 662911 D01 Multiple Transmitter Output v02r01  
 FCC KDB 291074 D02 EMC Measurement v01  
 ANSI C63.10:2013

### 1.6 Test Facility

Laboratory	Test Site Address	Test Site Name	FCC Designation number	IC CAB identifier
SGS Taiwan Ltd. Central RF Lab. (TAF code 3702)	No.134, Wu Kung Road, New Taipei Industrial Park, Wuku District, New Taipei City, Taiwan.	SAC 1	TW0027	
		SAC 3		
		Conduction 1		
		Conducted 1		
		Conducted 2		
		Conducted 3		
		Conducted 4		
		Conducted 5		
		Conducted 6		
	No.2, Keji 1st Rd., Guishan District, Taoyuan City, Taiwan 333	Conduction C	TW0028	
		SAC C		
		SAC D		
		SAC G		
		Conducted A		
		Conducted B		
		Conducted C		
		Conducted D		
		Conducted E		
		Conducted F		
Conducted G				

**Note:** Test site name is remarked on the equipment list in each section of this report as an indication where measurements occurred in specific test site and address.

### 1.7 Special Accessories

There are no special accessories used while test was conducted.

### 1.8 Equipment Modifications

There was no modification incorporated into the EUT.

Unless otherwise stated the results shown in this test report refer only to the sample(s) tested and such sample(s) are retained for 90 days only.

除非另有說明，此報告結果僅對測試之樣品負責，同時此樣品僅保留90天。本報告未經本公司書面許可，不可部份複製。

This document is issued by the Company subject to its General Conditions of Service printed overleaf, available on request or accessible at <http://www.sgs.com.tw/Terms-and-Conditions> and for electronic format documents, subject to Terms and Conditions for Electronic Documents at <http://www.sgs.com.tw/Terms-and-Conditions>. Attention is drawn to the limitation of liability, indemnification and jurisdiction issues defined therein. Any holder of this document is advised that information contained hereon reflects the Company's findings at the time of its intervention only and within the limits of Client's instructions, if any. The Company's sole responsibility is to its Client and this document does not exonerate parties to a transaction from exercising all their rights and obligations under the transaction documents. This document cannot be reproduced except in full, without prior written approval of the Company. Any unauthorized alteration, forgery or falsification of the content or appearance of this document is unlawful and offenders may be prosecuted to the fullest extent of the law.

## 2 SYSTEM TEST CONFIGURATION

### 2.1 EUT Configuration

The EUT configuration for testing is installed on RF field strength measurement to meet the Commissions requirement and operating in a manner which intends to maximize its emission characteristics in a continuous normal application.

### 2.2 EUT Exercise

An engineering test mode (software/firmware) that applicant provided was utilized to manipulate the EUT into transmit, selection of the test channel, and modulation scheme.

### 2.3 Test Procedure

#### 2.3.1 Conducted Emissions

The EUT is placed on a table which is 0.8 m above ground plane. Conducted emissions from the EUT measured in the frequency range between 0.15 MHz and 30MHz. The CISPR Quasi-Peak and Average detector mode is employed. The two LISNs provide 50uH/50 ohm of coupling impedance for the measuring instrument. Both lines of the power mains connected to the EUT were checked for maximum conducted interference.

#### 2.3.2 Conducted Test (RF)

The active antenna port of the unlicensed wireless device is connected to the spectrum analyzer with attenuator to protect the instrumentation. If a second antenna port is available, it is tested at one operating frequency, with other port(s) appropriately terminated, to verify it has similar output characteristics as the fully tested port.

#### 2.3.3 Radiated Emissions

The EUT is placed on a turn table. For emissions testing at or below 1 GHz, the table height shall be 0.8 m above the reference ground plane. For emission measurements above 1 GHz, the table height shall be 1.5 m. The turn table shall rotate 360 degrees to determine the position of maximum emission level. EUT is set 3m away from the receiving antenna which varied from 1m to 4m to find out the highest emission. And also, each emission was to be maximized by changing the polarization of receiving antenna both horizontal and vertical. In order to find out the max. emission, the relative positions of this transmitter (EUT) was rotated through three orthogonal axes and measurement procedures for electric field radiated emissions above 1 GHz the EUT measurement is to be made "while keeping the antenna in the 'cone of radiation' from that area and pointed at the area both in azimuth and elevation, with polarization oriented for maximum response." is still within the 3dB illumination BW of the measurement antenna.

Unless otherwise stated the results shown in this test report refer only to the sample(s) tested and such sample(s) are retained for 90 days only.

除非另有說明，此報告結果僅對測試之樣品負責，同時此樣品僅保留90天。本報告未經本公司書面許可，不可部份複製。

This document is issued by the Company subject to its General Conditions of Service printed overleaf, available on request or accessible at <http://www.sgs.com.tw/Terms-and-Conditions> and for electronic format documents, subject to Terms and Conditions for Electronic Documents at <http://www.sgs.com.tw/Terms-and-Conditions>. Attention is drawn to the limitation of liability, indemnification and jurisdiction issues defined therein. Any holder of this document is advised that information contained hereon reflects the Company's findings at the time of its intervention only and within the limits of Client's instructions, if any. The Company's sole responsibility is to its Client and this document does not exonerate parties to a transaction from exercising all their rights and obligations under the transaction documents. This document cannot be reproduced except in full, without prior written approval of the Company. Any unauthorized alteration, forgery or falsification of the content or appearance of this document is unlawful and offenders may be prosecuted to the fullest extent of the law.



## 2.4 Measurement Results Explanation Example

### 2.4.1 Radiated Emission Test Sites For Measurements From 9 kHz To 30 MHz

Radiated emission below 30MHz is measured in a 9m\*6m\*6m semi-anechoic chamber, the measurements correspond to those obtained at an open-field test site.

There is a comparison data of both open-field test site and semi-Anechoic chamber, and the result came out very similar.

### 2.4.2 For all conducted test items:

The offset level is set in the spectrum analyzer to compensate the RF cable loss and attenuation factor between EUT conducted port and spectrum analyzer. With the offset compensation, the spectrum analyzer reading level is exactly EUT RF output level.

Unless otherwise stated the results shown in this test report refer only to the sample(s) tested and such sample(s) are retained for 90 days only.

除非另有說明，此報告結果僅對測試之樣品負責，同時此樣品僅保留90天。本報告未經本公司書面許可，不可部份複製。

This document is issued by the Company subject to its General Conditions of Service printed overleaf, available on request or accessible at <http://www.sgs.com.tw/Terms-and-Conditions> and for electronic format documents, subject to Terms and Conditions for Electronic Documents at <http://www.sgs.com.tw/Terms-and-Conditions>. Attention is drawn to the limitation of liability, indemnification and jurisdiction issues defined therein. Any holder of this document is advised that information contained hereon reflects the Company's findings at the time of its intervention only and within the limits of Client's instructions, if any. The Company's sole responsibility is to its Client and this document does not exonerate parties to a transaction from exercising all their rights and obligations under the transaction documents. This document cannot be reproduced except in full, without prior written approval of the Company. Any unauthorized alteration, forgery or falsification of the content or appearance of this document is unlawful and offenders may be prosecuted to the fullest extent of the law.

## 2.5 Test Configuration

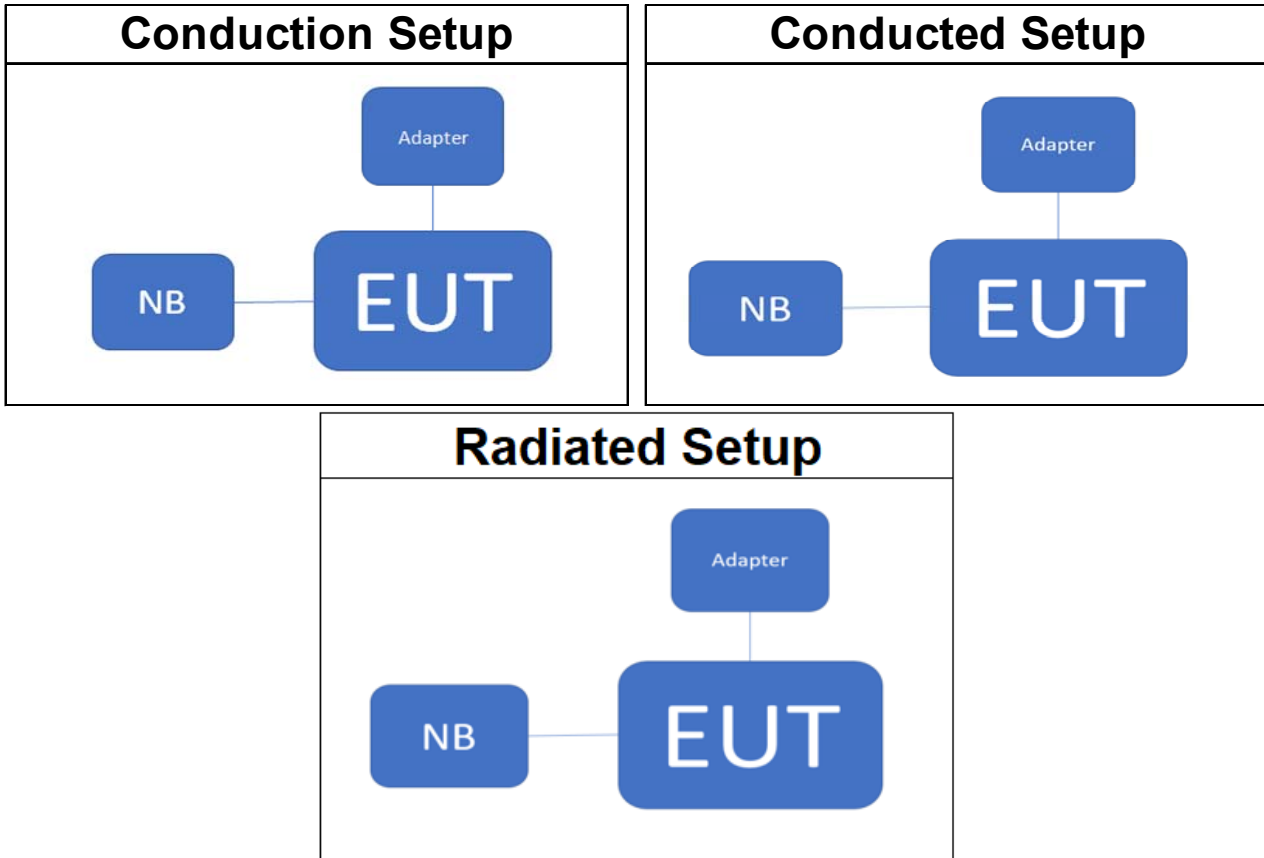

Unless otherwise stated the results shown in this test report refer only to the sample(s) tested and such sample(s) are retained for 90 days only.

除非另有說明，此報告結果僅對測試之樣品負責，同時此樣品僅保留90天。本報告未經本公司書面許可，不可部份複製。

This document is issued by the Company subject to its General Conditions of Service printed overleaf, available on request or accessible at <http://www.sgs.com.tw/Terms-and-Conditions> and for electronic format documents, subject to Terms and Conditions for Electronic Documents at <http://www.sgs.com.tw/Terms-and-Conditions>. Attention is drawn to the limitation of liability, indemnification and jurisdiction issues defined therein. Any holder of this document is advised that information contained hereon reflects the Company's findings at the time of its intervention only and within the limits of Client's instructions, if any. The Company's sole responsibility is to its Client and this document does not exonerate parties to a transaction from exercising all their rights and obligations under the transaction documents. This document cannot be reproduced except in full, without prior written approval of the Company. Any unauthorized alteration, forgery or falsification of the content or appearance of this document is unlawful and offenders may be prosecuted to the fullest extent of the law.

2.6 Control Unit(s)

AC Power-Line Conducted Emission Test Site: Conduction 1					
EQUIPMENT TYPE	MFR	MODEL NUMBER	SERIAL NUMBER	LAST CAL.	CAL DUE.
Notebook	Lenovo	T440P	PC-01FYE9	N/A	N/A
Adapter	Shenzhen Honor Electronic Co., Ltd.	GKC2H	1HV00217NO00F011B	N/A	N/A
Test Software	Audix	e3	Ver. 9.210322	N.C.R	N.C.R

Conducted Emission Test Site: Conducted 2					
EQUIPMENT TYPE	MFR	MODEL NUMBER	SERIAL NUMBER	LAST CAL.	CAL DUE.
Test Software	SGS	Radio Test Software	Ver. 21	N.C.R	N.C.R
Adapter	Shenzhen Honor Electronic Co., Ltd.	GKC2H	1HV0021NO00A891B	N/A	N/A
Notebook	Lenovo	L480	PF-1S9NT5	N/A	N/A

Radiated Emission Test Site: SAC 1					
EQUIPMENT TYPE	MFR	MODEL NUMBER	SERIAL NUMBER	LAST CAL.	CAL DUE.
Test Software	Audix	e3	Ver. 9.210322	N.C.R	N.C.R
Adapter	Shenzhen Honor Electronic Co. Ltd.	GKC2H	1HV00217NO00F011B	N/A	N/A
Notebook	Lenovo	T440P	PC-01FYE9	N/A	N/A

Unless otherwise stated the results shown in this test report refer only to the sample(s) tested and such sample(s) are retained for 90 days only.

除非另有說明，此報告結果僅對測試之樣品負責，同時此樣品僅保留90天。本報告未經本公司書面許可，不可部份複製。

This document is issued by the Company subject to its General Conditions of Service printed overleaf, available on request or accessible at <http://www.sgs.com.tw/Terms-and-Conditions> and for electronic format documents, subject to Terms and Conditions for Electronic Documents at <http://www.sgs.com.tw/Terms-and-Conditions>. Attention is drawn to the limitation of liability, indemnification and jurisdiction issues defined therein. Any holder of this document is advised that information contained hereon reflects the Company's findings at the time of its intervention only and within the limits of Client's instructions, if any. The Company's sole responsibility is to its Client and this document does not exonerate parties to a transaction from exercising all their rights and obligations under the transaction documents. This document cannot be reproduced except in full, without prior written approval of the Company. Any unauthorized alteration, forgery or falsification of the content or appearance of this document is unlawful and offenders may be prosecuted to the fullest extent of the law.

### 3 SUMMARY OF TEST RESULT

FCC Rules	Description Of Test	Result
§15.207	AC Power Line Conducted Emission	Compliant
§15.407(e)	Emission Bandwidth	Compliant
§15.407(a)	Maximum Conducted Output Power	Compliant
§15.407(a)	Power Spectral Density	Compliant
§15.205 §15.209 §15.407(b)	Undesirable Radiated Emissions	Compliant
§15.203	Antenna Requirement	Compliant

Unless otherwise stated the results shown in this test report refer only to the sample(s) tested and such sample(s) are retained for 90 days only.

除非另有說明，此報告結果僅對測試之樣品負責，同時此樣品僅保留90天。本報告未經本公司書面許可，不可部份複製。

This document is issued by the Company subject to its General Conditions of Service printed overleaf, available on request or accessible at <http://www.sgs.com.tw/Terms-and-Conditions> and for electronic format documents, subject to Terms and Conditions for Electronic Documents at <http://www.sgs.com.tw/Terms-and-Conditions>. Attention is drawn to the limitation of liability, indemnification and jurisdiction issues defined therein. Any holder of this document is advised that information contained hereon reflects the Company's findings at the time of its intervention only and within the limits of Client's instructions, if any. The Company's sole responsibility is to its Client and this document does not exonerate parties to a transaction from exercising all their rights and obligations under the transaction documents. This document cannot be reproduced except in full, without prior written approval of the Company. Any unauthorized alteration, forgery or falsification of the content or appearance of this document is unlawful and offenders may be prosecuted to the fullest extent of the law.

## 4 DESCRIPTION OF TEST MODES

### 4.1 Operating Frequencies

Operated band in 5150 MHz ~5250 MHz:

20 M		40 M		80 M	
CH	Freq (MHz)	CH	Freq (MHz)	CH	Freq (MHz)
36	5180	38	5190	42	5210
40	5200	46	5230		
44	5220				
48	5240				

Operated band in 5725 MHz ~5850 MHz:

20 M		40 M		80 M	
CH	Freq (MHz)	CH	Freq (MHz)	CH	Freq (MHz)
149	5745	151	5755	155	5775
153	5765	159	5795		
157	5785				
161	5805				
165	5825				

Operated band in 5850 MHz ~5895 MHz:

20 M		40 M		80 M		160 M	
CH	Freq (MHz)	CH	Freq (MHz)	CH	Freq (MHz)	CH	Freq (MHz)
169	5845	167	5835	171	5855	163	5815
173	5865	175	5875				
177	5885						

Unless otherwise stated the results shown in this test report refer only to the sample(s) tested and such sample(s) are retained for 90 days only.

除非另有說明，此報告結果僅對測試之樣品負責，同時此樣品僅保留90天。本報告未經本公司書面許可，不可部份複製。

This document is issued by the Company subject to its General Conditions of Service printed overleaf, available on request or accessible at <http://www.sgs.com.tw/Terms-and-Conditions> and for electronic format documents, subject to Terms and Conditions for Electronic Documents at <http://www.sgs.com.tw/Terms-and-Conditions>. Attention is drawn to the limitation of liability, indemnification and jurisdiction issues defined therein. Any holder of this document is advised that information contained hereon reflects the Company's findings at the time of its intervention only and within the limits of Client's instructions, if any. The Company's sole responsibility is to its Client and this document does not exonerate parties to a transaction from exercising all their rights and obligations under the transaction documents. This document cannot be reproduced except in full, without prior written approval of the Company. Any unauthorized alteration, forgery or falsification of the content or appearance of this document is unlawful and offenders may be prosecuted to the fullest extent of the law.

#### 4.2 The Worst Test Modes and Channel Details

1. The EUT has been tested under operating condition.
2. Test program used to control the EUT for staying in continuous transmitting mode is programmed.
3. Investigation has been done on all the possible configurations for searching the worst case. The given UE is pre-scanned among below modes.

Modulation		Multiple Transmission Spatial					
v	802.11 a	v	2TX				
v	802.11 n	v	2TX	v	BF	v	MIMO
v	802.11 ac	v	2TX	v	BF	v	MIMO
v	802.11 ax	v	2TX	v	BF	v	MIMO

4. Since the EUT antenna combination is cross polarization, the power and PSD of CDD mode is covering the BF mode.
5. Therefore, below summary is the modes of test configuration that yield the highest reading and generate the highest emission chosen to carry out the relevantly mandatory test items.

Unless otherwise stated the results shown in this test report refer only to the sample(s) tested and such sample(s) are retained for 90 days only.

除非另有說明，此報告結果僅對測試之樣品負責，同時此樣品僅保留90天。本報告未經本公司書面許可，不可部份複製。  
 This document is issued by the Company subject to its General Conditions of Service printed overleaf, available on request or accessible at <http://www.sgs.com.tw/Terms-and-Conditions> and for electronic format documents, subject to Terms and Conditions for Electronic Documents at <http://www.sgs.com.tw/Terms-and-Conditions>. Attention is drawn to the limitation of liability, indemnification and jurisdiction issues defined therein. Any holder of this document is advised that information contained hereon reflects the Company's findings at the time of its intervention only and within the limits of Client's instructions, if any. The Company's sole responsibility is to its Client and this document does not exonerate parties to a transaction from exercising all their rights and obligations under the transaction documents. This document cannot be reproduced except in full, without prior written approval of the Company. Any unauthorized alteration, forgery or falsification of the content or appearance of this document is unlawful and offenders may be prosecuted to the fullest extent of the law.

CONDUCTED TEST							
MODE	FREQUENCY BAND (MHz)	AVAILABLE CHANNEL	TESTED CHANNEL	MODULATION	DATA RATE (Mbps)	ANTENNA PORT	
802.11a	5180~5240	36 to 48	36,44,48	OFDM	6	2TX	
	5745~5825	149 to 165	149,157,165				
	5845~5885	169 to 177	169,173,177				
802.11n_HT20	5180~5240	36 to 48	36,44,48	OFDM	MCS0	2TX	
	5745~5825	149 to 165	149,157,165				
	5845~5885	169 to 177	169,173,177				
802.11n_HT40	5190~5230	38 to 46	38,46	OFDM	MCS0	2TX	
	5755~5795	151 to 159	151,159				
	5835~5875	167 to 175	167,175				
802.11ac_VHT80	5210	42	42	OFDM	MCS0	2TX	
	5775	155	155				
	5855	171	171				
802.11ac_VHT160	5815	163	163	OFDM	MCS0	2TX	
CONDUCTED TEST							
MODE	FREQUENCY BAND (MHz)	AVAILABLE CHANNEL	TESTED CHANNEL	MODULATION	RU CONFIGURATION	DATA RATE (Mbps)	ANTENNA PORT
802.11ax_HE20	5180~5240	36 to 48	36,44,48	OFDMA	FULL RU	MCS0	2TX
	5745~5825	149 to 165	149,157,165				
	5845~5885	169 to 177	169,173,177				
802.11ax_HE40	5190~5230	38 to 46	38,46	OFDMA	FULL RU	MCS0	2TX
	5755~5795	151 to 159	151,159				
	5835~5875	167 to 175	167,175				
802.11ax_HE80	5210	42	42	OFDMA	FULL RU	MCS0	2TX
	5775	155	155				
	5855	171	171				
802.11ax_HE160	5815	163	163	OFDMA	FULL RU	MCS0	2TX

Unless otherwise stated the results shown in this test report refer only to the sample(s) tested and such sample(s) are retained for 90 days only.

除非另有說明，此報告結果僅對測試之樣品負責，同時此樣品僅保留90天。本報告未經本公司書面許可，不可部份複製。

This document is issued by the Company subject to its General Conditions of Service printed overleaf, available on request or accessible at <http://www.sgs.com.tw/Terms-and-Conditions> and for electronic format documents, subject to Terms and Conditions for Electronic Documents at <http://www.sgs.com.tw/Terms-and-Conditions>. Attention is drawn to the limitation of liability, indemnification and jurisdiction issues defined therein. Any holder of this document is advised that information contained hereon reflects the Company's findings at the time of its intervention only and within the limits of Client's instructions, if any. The Company's sole responsibility is to its Client and this document does not exonerate parties to a transaction from exercising all their rights and obligations under the transaction documents. This document cannot be reproduced except in full, without prior written approval of the Company. Any unauthorized alteration, forgery or falsification of the content or appearance of this document is unlawful and offenders may be prosecuted to the fullest extent of the law.

RADIATED EMISSION TEST (BELOW 1 GHz)							
MODE	FREQUENCY BAND (MHz)	AVAILABLE CHANNEL	TESTED CHANNEL	MODULATION	DATA RATE (Mbps)	ANTENNA PORT	
802.11a	5180~5240	36 to 48	44	OFDM	6	2TX	
	5745~5825	149 to 165	157				
	5845~5885	169 to 177	177				
RADIATED EMISSION TEST (ABOVE 1 GHz)							
MODE	FREQUENCY BAND (MHz)	AVAILABLE CHANNEL	TESTED CHANNEL	MODULATION	DATA RATE (Mbps)	ANTENNA PORT	
802.11a	5180~5240	36 to 48	36,44,48	OFDM	6	2TX	
	5745~5825	149 to 165	149,157,165				
	5845~5885	169 to 177	169,173,177				
802.11n_HT20	5180~5240	36 to 48	36,44,48	OFDM	MCS0	2TX	
	5745~5825	149 to 165	149,157,165				
	5845~5885	169 to 177	169,173,177				
802.11n_HT40	5190~5230	38 to 46	38,46	OFDM	MCS0	2TX	
	5755~5795	151 to 159	151,159				
	5835~5875	167 to 175	167,175				
802.11ac_VHT80	5210	42	42	OFDM	MCS0	2TX	
	5775	155	155				
	5855	171	171				
802.11ac_VHT160	5815	163	163	OFDM	MCS0	2TX	
RADIATED EMISSION TEST (ABOVE 1 GHz)							
MODE	FREQUENCY BAND (MHz)	AVAILABLE CHANNEL	TESTED CHANNEL	MODULATION	RU CONFIGURATION	DATA RATE (Mbps)	ANTENNA PORT
802.11ax_HE20	5180~5240	36 to 48	36,44,48	OFDMA	FULL RU	MCS0	2TX
	5745~5825	149 to 165	149,157,165				
	5845~5885	169 to 177	169,173,177				
802.11ax_HE40	5190~5230	38 to 46	38,46	OFDMA	FULL RU	MCS0	2TX
	5755~5795	151 to 159	151,159				
	5835~5875	167 to 175	167,175				
802.11ax_HE80	5210	42	42	OFDMA	FULL RU	MCS0	2TX
	5775	155	155				
	5855	171	171				
802.11ax_HE160	5815	163	163	OFDMA	FULL RU	MCS0	2TX

**Note:**

The field strength of radiated emission was measured as the EUT positioned in different orthogonal planes (E1/E2/H) based on actual usage of the EUT to pre-scan the emissions for determining the worst case scenario.

Unless otherwise stated the results shown in this test report refer only to the sample(s) tested and such sample(s) are retained for 90 days only.

除非另有說明，此報告結果僅對測試之樣品負責，同時此樣品僅保留90天。本報告未經本公司書面許可，不可部份複製。

This document is issued by the Company subject to its General Conditions of Service printed overleaf, available on request or accessible at <http://www.sgs.com.tw/Terms-and-Conditions> and for electronic format documents, subject to Terms and Conditions for Electronic Documents at <http://www.sgs.com.tw/Terms-and-Conditions>. Attention is drawn to the limitation of liability, indemnification and jurisdiction issues defined therein. Any holder of this document is advised that information contained hereon reflects the Company's findings at the time of its intervention only and within the limits of Client's instructions, if any. The Company's sole responsibility is to its Client and this document does not exonerate parties to a transaction from exercising all their rights and obligations under the transaction documents. This document cannot be reproduced except in full, without prior written approval of the Company. Any unauthorized alteration, forgery or falsification of the content or appearance of this document is unlawful and offenders may be prosecuted to the fullest extent of the law.



## 5 MEASUREMENT UNCERTAINTY

Test Items	Uncertainty
AC Power Line Conducted Emission	+/- 2.34 dB
Output Power measurement	+/- 1 dB
Emission Bandwidth	+/- 1.53 Hz
Undesignable radiated emission measurement	+/- 1.68 dB
Peak Power Density	+/- 1.62 dB
Temperature	+/- 0.4 °C
Humidity	+/- 3.5 %
DC / AC Power Source	+/- 1 %

Radiated Spurious Emission Measurement Uncertainty		
Polarization: Vertical	+/- 2.57 dB	9kHz~30MHz
	+/- 4.85 dB	30MHz - 1000MHz
	+/- 4.45 dB	1GHz - 18GHz
	+/- 4.24 dB	18GHz - 40GHz
Polarization: Horizontal	+/- 2.57 dB	9kHz~30MHz
	+/- 4.37 dB	30MHz - 1000MHz
	+/- 4.45 dB	1GHz - 18GHz
	+/- 4.24 dB	18GHz - 40GHz

**Note:**

1. This uncertainty represents an expanded uncertainty expressed at approximately the 95% confidence level using a coverage factor of k=2.
2. The conformity assessment statement in this report is based solely on the test results, measurement uncertainty is excluded.

Unless otherwise stated the results shown in this test report refer only to the sample(s) tested and such sample(s) are retained for 90 days only.

除非另有說明，此報告結果僅對測試之樣品負責，同時此樣品僅保留90天。本報告未經本公司書面許可，不可部份複製。

This document is issued by the Company subject to its General Conditions of Service printed overleaf, available on request or accessible at <http://www.sgs.com.tw/Terms-and-Conditions> and for electronic format documents, subject to Terms and Conditions for Electronic Documents at <http://www.sgs.com.tw/Terms-and-Conditions>. Attention is drawn to the limitation of liability, indemnification and jurisdiction issues defined therein. Any holder of this document is advised that information contained hereon reflects the Company's findings at the time of its intervention only and within the limits of Client's instructions, if any. The Company's sole responsibility is to its Client and this document does not exonerate parties to a transaction from exercising all their rights and obligations under the transaction documents. This document cannot be reproduced except in full, without prior written approval of the Company. Any unauthorized alteration, forgery or falsification of the content or appearance of this document is unlawful and offenders may be prosecuted to the fullest extent of the law.

## 6 MEASUREMENT EQUIPMENT USED

### 6.1 Emission from AC power line

AC Power-Line Conducted Emission Test Site: Conduction 1					
EQUIPMENT TYPE	MFR	MODEL NUMBER	SERIAL NUMBER	LAST CAL.	CAL DUE.
LISN	SCHWARZBECK	NSLK 8127	1040	08/10/2021	08/09/2022
Coaxial Cables	N/A	Coaxial Cable	161207	12/07/2021	12/06/2022
EMI Test Receiver	R&S	ESCI 7	100759	08/26/2021	08/25/2022

### 6.2 Conducted Measurement

Conducted Emission Test Site: Conducted 2					
EQUIPMENT TYPE	MFR	MODEL NUMBER	SERIAL NUMBER	LAST CAL.	CAL DUE.
EXA Spectrum Analyzer	KEYSIGHT	N9010B	MY60242081	09/30/2021	09/29/2022
PXA Spectrum Analyzer	KEYSIGHT	N9030A	MY53120760	04/28/2022	04/27/2023
Power Meter	Anritsu	ML2496A	2138003	11/12/2021	11/11/2022
Power Sensor	Anritsu	MA2411B	1911393	09/21/2021	09/20/2022
Power Sensor	Anritsu	MA2411B	1911394	09/21/2021	09/20/2022
Attenuator	Mini-Circuit	BW-S10W2+	4	12/14/2021	12/13/2022
DC Block	Mini-Circuits	BLK-18-S+	1	12/14/2021	12/13/2022

Unless otherwise stated the results shown in this test report refer only to the sample(s) tested and such sample(s) are retained for 90 days only.

除非另有說明，此報告結果僅對測試之樣品負責，同時此樣品僅保留90天。本報告未經本公司書面許可，不可部份複製。

This document is issued by the Company subject to its General Conditions of Service printed overleaf, available on request or accessible at <http://www.sgs.com.tw/Terms-and-Conditions> and for electronic format documents, subject to Terms and Conditions for Electronic Documents at <http://www.sgs.com.tw/Terms-and-Conditions>. Attention is drawn to the limitation of liability, indemnification and jurisdiction issues defined therein. Any holder of this document is advised that information contained hereon reflects the Company's findings at the time of its intervention only and within the limits of Client's instructions, if any. The Company's sole responsibility is to its Client and this document does not exonerate parties to a transaction from exercising all their rights and obligations under the transaction documents. This document cannot be reproduced except in full, without prior written approval of the Company. Any unauthorized alteration, forgery or falsification of the content or appearance of this document is unlawful and offenders may be prosecuted to the fullest extent of the law.

**6.3 Radiated Measurement**

Radiated Emission Test Site: SAC 1					
EQUIPMENT TYPE	MFR	MODEL NUMBER	SERIAL NUMBER	LAST CAL.	CAL DUE.
Horn Antenna	SCHWARZBECK	BBHA9120D	D803	12/20/2021	12/19/2022
Bi-log Antenna	TESEO	CBL 6112D	35242 & AT-N0555	01/03/2022	01/02/2023
Horn Antenna	SCHWARZBECK	BBHA9170	184	12/16/2021	12/15/2022
Loop Antenna	ETS.LINDGREN	6502	148045	09/29/2021	09/28/2022
Site Cal	SGS	SAC I chamber	N/A	01/01/2022	12/31/2022
EXA Spectrum Analyzer	Agilent	N9010A	MY50420195	05/12/2021	05/11/2022
EMI Test Receiver	R&S	ESCI 7	100759	08/26/2021	08/25/2022
Pre-Amplifier	EMC Instruments	EMC184045B	980135	10/27/2021	10/26/2022
Pre-Amplifier	HP	8449B	3008A01973	12/16/2021	12/15/2022
Pre-Amplifier	HP	8447D	2944A09469	12/16/2021	12/15/2022
Attenuator	Mini-Circuit	BW-S10W2+	4	12/14/2021	12/13/2022
Bandreject Filter 2400-2483.5	EWT	EWT-14-0166	M1	12/14/2021	12/13/2022
3.2GHz High Pass Filter	WI	WHKX10-2624-80SS	3	12/14/2021	12/13/2022
Coaxial Cable	Huber Suhner	succoflex 102	MY2622/2	12/16/2021	12/15/2022
Coaxial Cable	Huber Suhner	succoflex 104A	800086/4a	12/16/2021	12/15/2022
Coaxial Cable	Huber Suhner	EMC 104-SM-SM-2000	160123	12/16/2021	12/15/2022
Coaxial Cable	Huber Suhner	SUCOFLEX 102	MY2630/2	12/16/2021	12/15/2022
Coaxial Cable	Huber Suhner	SUCOFLEX 102	MY22962/2	12/16/2021	12/15/2022

Unless otherwise stated the results shown in this test report refer only to the sample(s) tested and such sample(s) are retained for 90 days only.

除非另有說明，此報告結果僅對測試之樣品負責，同時此樣品僅保留90天。本報告未經本公司書面許可，不可部份複製。

This document is issued by the Company subject to its General Conditions of Service printed overleaf, available on request or accessible at <http://www.sgs.com.tw/Terms-and-Conditions> and for electronic format documents, subject to Terms and Conditions for Electronic Documents at <http://www.sgs.com.tw/Terms-and-Conditions>. Attention is drawn to the limitation of liability, indemnification and jurisdiction issues defined therein. Any holder of this document is advised that information contained hereon reflects the Company's findings at the time of its intervention only and within the limits of Client's instructions, if any. The Company's sole responsibility is to its Client and this document does not exonerate parties to a transaction from exercising all their rights and obligations under the transaction documents. This document cannot be reproduced except in full, without prior written approval of the Company. Any unauthorized alteration, forgery or falsification of the content or appearance of this document is unlawful and offenders may be prosecuted to the fullest extent of the law.

## 7 CONDUCTED EMISSION TEST

### 7.1 Standard Applicable

Frequency range within 150 kHz to 30 MHz shall not exceed the Limit table as below.

Frequency range MHz	Limits (dBuV)	
	Quasi-peak	Average
0.15 to 0.50	66 to 56	56 to 46
0.50 to 5	56	46
5 to 30	60	50

Note

- The lower limit shall apply at the transition frequencies
- The limit decreases linearly with the logarithm of the frequency in the range 0.15 MHz to 0.50 MHz.

### 7.2 EUT Setup

- The conducted emission tests were performed in the test site, using the setup in accordance with the ANSI C63.10:2013.
- The AC/DC Power adaptor of EUT was plug-in LISN. The rear of the EUT and peripherals were placed flushed with the rear of the tabletop.
- The LISN was connected with 120Vac/60Hz power source.

### 7.3 Test SET-UP

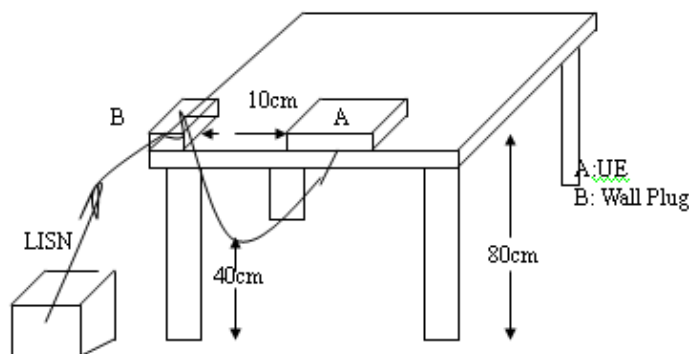

### 7.4 Measurement Procedure

- The EUT was placed on a table which is 0.8m above ground plane.
- Maximum procedure was performed on the six highest emissions to ensure EUT compliance.
- Repeat above procedures until all phases of power being supplied by given UE are completed.

### 7.5 Measurement Result

Note: Refer to next page for measurement data and plots.

Note2: The \* reveals the worst-case results that closet to the limit.

Unless otherwise stated the results shown in this test report refer only to the sample(s) tested and such sample(s) are retained for 90 days only.

除非另有說明，此報告結果僅對測試之樣品負責，同時此樣品僅保留90天。本報告未經本公司書面許可，不可部份複製。

This document is issued by the Company subject to its General Conditions of Service printed overleaf, available on request or accessible at <http://www.sgs.com.tw/Terms-and-Conditions> and for electronic format documents, subject to Terms and Conditions for Electronic Documents at <http://www.sgs.com.tw/Terms-and-Conditions>. Attention is drawn to the limitation of liability, indemnification and jurisdiction issues defined therein. Any holder of this document is advised that information contained hereon reflects the Company's findings at the time of its intervention only and within the limits of Client's instructions, if any. The Company's sole responsibility is to its Client and this document does not exonerate parties to a transaction from exercising all their rights and obligations under the transaction documents. This document cannot be reproduced except in full, without prior written approval of the Company. Any unauthorized alteration, forgery or falsification of the content or appearance of this document is unlawful and offenders may be prosecuted to the fullest extent of the law.

### AC POWER LINE CONDUCTED EMISSION TEST DATA

Report Number :ER/2022/30038

Test Site :Conduction 1

Test Mode :WIFI 5G

Test Date :2022-03-15

Power :120V/60Hz

Temp./Humi. :22.5/57

Probe :L

Engineer :GN Lin

Note: :

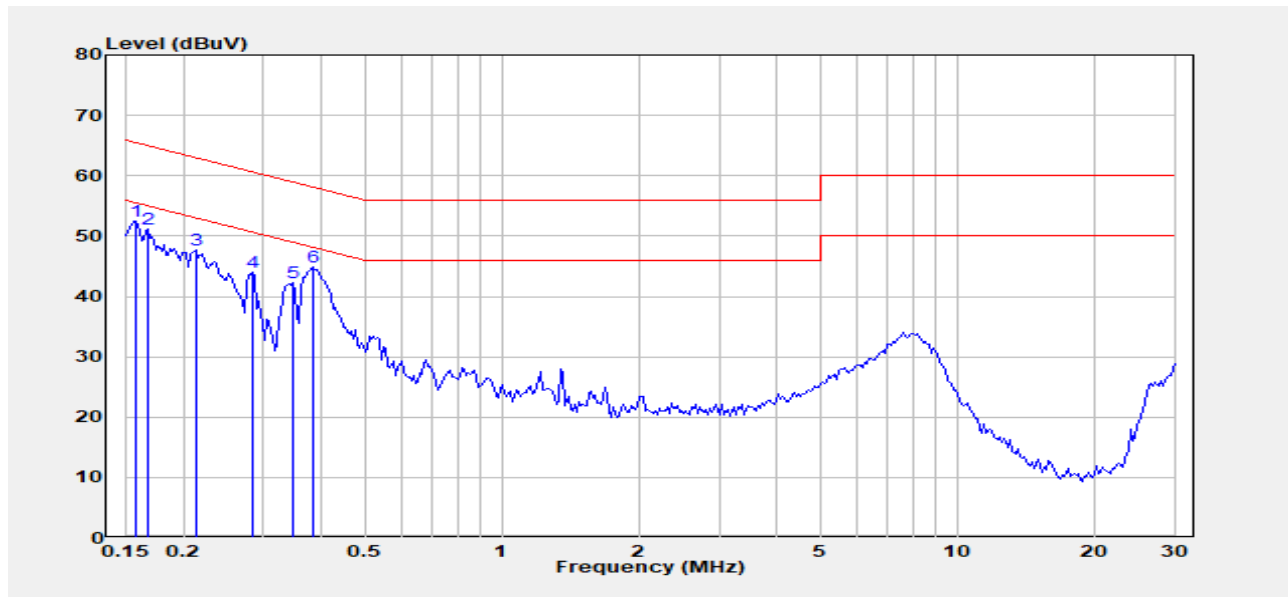

Freq. MHz	Detector Mode PK/QP/AV	Spectrum Reading Level dB $\mu$ V	Factor dB	Actual FS dB $\mu$ V	Limit dB $\mu$ V	Margin dB
0.156	Peak	52.49	0.02	52.51	65.65	-13.14
0.167	Peak	51.11	0.02	51.13	65.12	-13.99
0.213	Peak	47.65	0.02	47.67	63.10	-15.42
0.283	Peak	43.95	0.02	43.97	60.72	-16.75
0.346	Peak	42.14	0.05	42.19	59.05	-16.86
0.385	Peak	44.73	0.07	44.79	58.17	-13.37

Unless otherwise stated the results shown in this test report refer only to the sample(s) tested and such sample(s) are retained for 90 days only.

除非另有說明，此報告結果僅對測試之樣品負責，同時此樣品僅保留90天。本報告未經本公司書面許可，不可部份複製。

This document is issued by the Company subject to its General Conditions of Service printed overleaf, available on request or accessible at <http://www.sgs.com.tw/Terms-and-Conditions> and for electronic format documents, subject to Terms and Conditions for Electronic Documents at <http://www.sgs.com.tw/Terms-and-Conditions>. Attention is drawn to the limitation of liability, indemnification and jurisdiction issues defined therein. Any holder of this document is advised that information contained hereon reflects the Company's findings at the time of its intervention only and within the limits of Client's instructions, if any. The Company's sole responsibility is to its Client and this document does not exonerate parties to a transaction from exercising all their rights and obligations under the transaction documents. This document cannot be reproduced except in full, without prior written approval of the Company. Any unauthorized alteration, forgery or falsification of the content or appearance of this document is unlawful and offenders may be prosecuted to the fullest extent of the law.

Report Number :ER/2022/30038

Test Site :Conduction 1

Test Mode :WIFI 5G

Test Date :2022-03-15

Power :120V/60Hz

Temp./Humi. :22.5/57

Probe :N

Engineer :GN Lin

Note: :

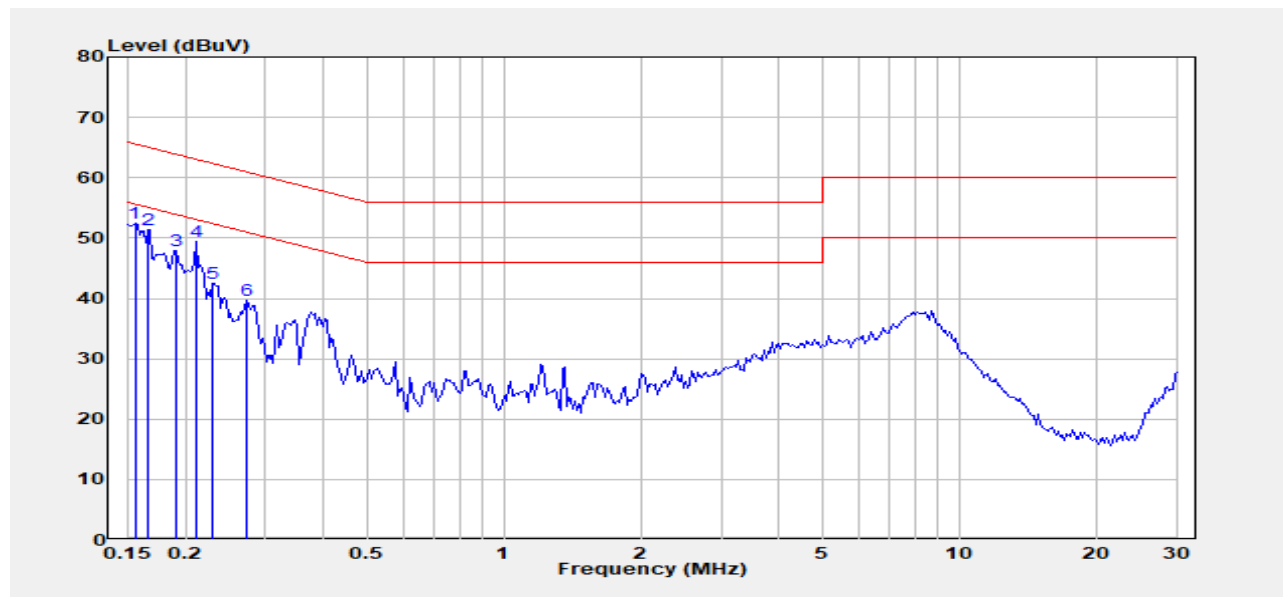

Freq. MHz	Detector Mode PK/QP/AV	Spectrum Reading Level dBμV	Factor dB	Actual FS dBμV	Limit dBμV	Margin dB
0.155	Peak	52.35	0.04	52.39	65.74	-13.34
0.165	Peak	51.33	0.08	51.41	65.21	-13.80
0.191	Peak	47.77	0.17	47.95	63.98	-16.03
0.211	Peak	49.31	0.19	49.50	63.18	-13.69
0.229	Peak	42.32	0.16	42.48	62.48	-20.00
0.272	Peak	39.48	0.12	39.60	61.07	-21.47

Unless otherwise stated the results shown in this test report refer only to the sample(s) tested and such sample(s) are retained for 90 days only.

除非另有說明，此報告結果僅對測試之樣品負責，同時此樣品僅保留90天。本報告未經本公司書面許可，不可部份複製。

This document is issued by the Company subject to its General Conditions of Service printed overleaf, available on request or accessible at <http://www.sgs.com.tw/Terms-and-Conditions> and for electronic format documents, subject to Terms and Conditions for Electronic Documents at <http://www.sgs.com.tw/Terms-and-Conditions>. Attention is drawn to the limitation of liability, indemnification and jurisdiction issues defined therein. Any holder of this document is advised that information contained hereon reflects the Company's findings at the time of its intervention only and within the limits of Client's instructions, if any. The Company's sole responsibility is to its Client and this document does not exonerate parties to a transaction from exercising all their rights and obligations under the transaction documents. This document cannot be reproduced except in full, without prior written approval of the Company. Any unauthorized alteration, forgery or falsification of the content or appearance of this document is unlawful and offenders may be prosecuted to the fullest extent of the law.

## 8 EMISSION BANDWIDTH MEASUREMENT

### 8.1 Standard Applicable

There is no limit bandwidth for U-NII-1.

The minimum of 6dB Bandwidth measurement is 0.5 MHz for U-NII-3 & UNII-4.

### 8.2 Test Setup

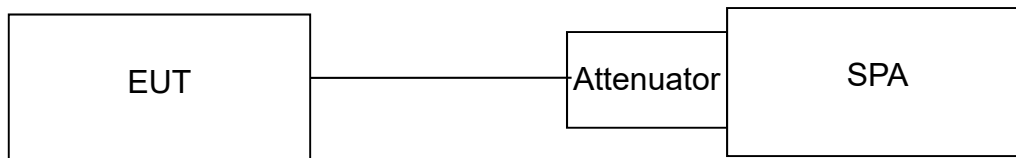

### 8.3 Measurement Procedure

1. Place the EUT on the table and set it in transmitting mode.
2. The testing follows FCC KDB 789033 D02 General UNII Test Procedures New Rules.
3. Remove the antenna from the EUT and then connect a low loss RF cable from the Antenna port to the spectrum analyzer.
  - 3.a. 26dB Band width Measurement: Set the spectrum analyzer as 1% of emission BW  
Sweep=auto,  
Detector = Peak,  
Trace Mode = Max Hold,  
Manually readjust RBW until the RBW/EBW ratio is 1% based on EBW as observed on the result of pre-sequence measurement.
  - 3.b. Mark the peak frequency and -26dB (upper and lower) frequency.
4. Repeat the procedures as list above until all test default channels (low, middle, and high) are completed.
5. Minimum Emission Bandwidth for the band 5.725-5.850GHz.
  - a. Set the spectrum analyzer as  
RBW = 100 kHz,  
VBW = 3\*RBW,  
Span = large enough to capture all products of the modulation process,  
Detector=Peak,  
Sweep=auto
  - b. Mark the peak frequency and -6dB (upper and lower) frequency.
6. Repeat above procedures until all frequency of interest measured was complete.

Unless otherwise stated the results shown in this test report refer only to the sample(s) tested and such sample(s) are retained for 90 days only.

除非另有說明，此報告結果僅對測試之樣品負責，同時此樣品僅保留90天。本報告未經本公司書面許可，不可部份複製。

This document is issued by the Company subject to its General Conditions of Service printed overleaf, available on request or accessible at <http://www.sgs.com.tw/Terms-and-Conditions> and for electronic format documents, subject to Terms and Conditions for Electronic Documents at <http://www.sgs.com.tw/Terms-and-Conditions>. Attention is drawn to the limitation of liability, indemnification and jurisdiction issues defined therein. Any holder of this document is advised that information contained hereon reflects the Company's findings at the time of its intervention only and within the limits of Client's instructions, if any. The Company's sole responsibility is to its Client and this document does not exonerate parties to a transaction from exercising all their rights and obligations under the transaction documents. This document cannot be reproduced except in full, without prior written approval of the Company. Any unauthorized alteration, forgery or falsification of the content or appearance of this document is unlawful and offenders may be prosecuted to the fullest extent of the law.

## 8.4 Measurement Result

### 8.4.1 FCC Occupied Bandwidth

802.11a\_Ch0

Freq. (MHz)	26dB BW (MHz)	10 Log (B) (dB)
5180	18.38	12.640
5220	18.33	12.630
5240	19.48	12.900

802.11a\_Ch0

Freq. (MHz)	6dB BW (MHz)	10 Log (B) (dB)
5745	15.40	11.880
5785	15.11	11.790
5825	15.15	11.800
5845	15.15	11.800
5865	15.11	11.790
5885	16.32	12.130

802.11a\_Ch0

Freq. (MHz)	Measured Freq. (MHz)	Limit (MHz)
5240	5248.15	< 5250
5745	5736.80	> 5725

Unless otherwise stated the results shown in this test report refer only to the sample(s) tested and such sample(s) are retained for 90 days only.

除非另有說明，此報告結果僅對測試之樣品負責，同時此樣品僅保留90天。本報告未經本公司書面許可，不可部份複製。

This document is issued by the Company subject to its General Conditions of Service printed overleaf, available on request or accessible at <http://www.sgs.com.tw/Terms-and-Conditions> and for electronic format documents, subject to Terms and Conditions for Electronic Documents at <http://www.sgs.com.tw/Terms-and-Conditions>. Attention is drawn to the limitation of liability, indemnification and jurisdiction issues defined therein. Any holder of this document is advised that information contained hereon reflects the Company's findings at the time of its intervention only and within the limits of Client's instructions, if any. The Company's sole responsibility is to its Client and this document does not exonerate parties to a transaction from exercising all their rights and obligations under the transaction documents. This document cannot be reproduced except in full, without prior written approval of the Company. Any unauthorized alteration, forgery or falsification of the content or appearance of this document is unlawful and offenders may be prosecuted to the fullest extent of the law.



802.11a\_Ch1

Freq. (MHz)	26dB BW (MHz)	10 Log (B) (dB)
5180	18.60	12.700
5220	18.61	12.700
5240	18.60	12.700

802.11a\_Ch1

Freq. (MHz)	6dB BW (MHz)	10 Log (B) (dB)
5745	11.95	10.770
5785	15.07	11.780
5825	14.34	11.570
5845	13.82	11.410
5865	15.03	11.770
5885	14.72	11.680

802.11a\_Ch1

Freq. (MHz)	Measured Freq. (MHz)	Limit (MHz)
5240	5248.18	< 5250
5745	5736.72	> 5725

Unless otherwise stated the results shown in this test report refer only to the sample(s) tested and such sample(s) are retained for 90 days only.

除非另有說明，此報告結果僅對測試之樣品負責，同時此樣品僅保留90天。本報告未經本公司書面許可，不可部份複製。

This document is issued by the Company subject to its General Conditions of Service printed overleaf, available on request or accessible at <http://www.sgs.com.tw/Terms-and-Conditions> and for electronic format documents, subject to Terms and Conditions for Electronic Documents at <http://www.sgs.com.tw/Terms-and-Conditions>. Attention is drawn to the limitation of liability, indemnification and jurisdiction issues defined therein. Any holder of this document is advised that information contained hereon reflects the Company's findings at the time of its intervention only and within the limits of Client's instructions, if any. The Company's sole responsibility is to its Client and this document does not exonerate parties to a transaction from exercising all their rights and obligations under the transaction documents. This document cannot be reproduced except in full, without prior written approval of the Company. Any unauthorized alteration, forgery or falsification of the content or appearance of this document is unlawful and offenders may be prosecuted to the fullest extent of the law.

802.11n\_HT20\_Ch0

Freq. (MHz)	26dB BW (MHz)	10 Log (B) (dB)
5180	19.51	12.900
5220	19.77	12.960
5240	19.63	12.930

802.11n\_HT20\_Ch0

Freq. (MHz)	6dB BW (MHz)	10 Log (B) (dB)
5745	15.35	11.860
5785	17.35	12.390
5825	17.46	12.420
5845	16.86	12.270
5865	17.31	12.380
5885	15.27	11.840

802.11n\_HT20\_Ch0

Freq. (MHz)	Measured Freq. (MHz)	Limit (MHz)
5240	5248.74	< 5250
5745	5736.20	> 5725

Unless otherwise stated the results shown in this test report refer only to the sample(s) tested and such sample(s) are retained for 90 days only.

除非另有說明，此報告結果僅對測試之樣品負責，同時此樣品僅保留90天。本報告未經本公司書面許可，不可部份複製。

This document is issued by the Company subject to its General Conditions of Service printed overleaf, available on request or accessible at <http://www.sgs.com.tw/Terms-and-Conditions> and for electronic format documents, subject to Terms and Conditions for Electronic Documents at <http://www.sgs.com.tw/Terms-and-Conditions>. Attention is drawn to the limitation of liability, indemnification and jurisdiction issues defined therein. Any holder of this document is advised that information contained hereon reflects the Company's findings at the time of its intervention only and within the limits of Client's instructions, if any. The Company's sole responsibility is to its Client and this document does not exonerate parties to a transaction from exercising all their rights and obligations under the transaction documents. This document cannot be reproduced except in full, without prior written approval of the Company. Any unauthorized alteration, forgery or falsification of the content or appearance of this document is unlawful and offenders may be prosecuted to the fullest extent of the law.

802.11n\_HT20\_Ch1

Freq. (MHz)	26dB BW (MHz)	10 Log (B) (dB)
5180	19.56	12.910
5220	20.07	13.030
5240	19.32	12.860

802.11n\_HT20\_Ch1

Freq. (MHz)	6dB BW (MHz)	10 Log (B) (dB)
5745	17.56	12.450
5785	16.92	12.280
5825	17.22	12.360
5845	16.64	12.210
5865	16.69	12.220
5885	16.34	12.130

802.11n\_HT20\_Ch1

Freq. (MHz)	Measured Freq. (MHz)	Limit (MHz)
5240	5248.76	< 5250
5745	5736.17	> 5725

Unless otherwise stated the results shown in this test report refer only to the sample(s) tested and such sample(s) are retained for 90 days only.

除非另有說明，此報告結果僅對測試之樣品負責，同時此樣品僅保留90天。本報告未經本公司書面許可，不可部份複製。

This document is issued by the Company subject to its General Conditions of Service printed overleaf, available on request or accessible at <http://www.sgs.com.tw/Terms-and-Conditions> and for electronic format documents, subject to Terms and Conditions for Electronic Documents at <http://www.sgs.com.tw/Terms-and-Conditions>. Attention is drawn to the limitation of liability, indemnification and jurisdiction issues defined therein. Any holder of this document is advised that information contained hereon reflects the Company's findings at the time of its intervention only and within the limits of Client's instructions, if any. The Company's sole responsibility is to its Client and this document does not exonerate parties to a transaction from exercising all their rights and obligations under the transaction documents. This document cannot be reproduced except in full, without prior written approval of the Company. Any unauthorized alteration, forgery or falsification of the content or appearance of this document is unlawful and offenders may be prosecuted to the fullest extent of the law.

802.11n\_HT40\_Ch0

Freq. (MHz)	26dB BW (MHz)	10 Log (B) (dB)
5190	38.68	15.870
5230	38.79	15.890

802.11n\_HT40\_Ch0

Freq. (MHz)	6dB BW (MHz)	10 Log (B) (dB)
5755	34.31	15.350
5795	35.67	15.520
5835	33.19	15.210
5875	32.62	15.130

802.11n\_HT40\_Ch0

Freq. (MHz)	Measured Freq. (MHz)	Limit (MHz)
5230	5247.93	< 5250
5755	5736.84	> 5725

Unless otherwise stated the results shown in this test report refer only to the sample(s) tested and such sample(s) are retained for 90 days only.

除非另有說明，此報告結果僅對測試之樣品負責，同時此樣品僅保留90天。本報告未經本公司書面許可，不可部份複製。

This document is issued by the Company subject to its General Conditions of Service printed overleaf, available on request or accessible at <http://www.sgs.com.tw/Terms-and-Conditions> and for electronic format documents, subject to Terms and Conditions for Electronic Documents at <http://www.sgs.com.tw/Terms-and-Conditions>. Attention is drawn to the limitation of liability, indemnification and jurisdiction issues defined therein. Any holder of this document is advised that information contained hereon reflects the Company's findings at the time of its intervention only and within the limits of Client's instructions, if any. The Company's sole responsibility is to its Client and this document does not exonerate parties to a transaction from exercising all their rights and obligations under the transaction documents. This document cannot be reproduced except in full, without prior written approval of the Company. Any unauthorized alteration, forgery or falsification of the content or appearance of this document is unlawful and offenders may be prosecuted to the fullest extent of the law.

802.11n\_HT40\_Ch1

Freq. (MHz)	26dB BW (MHz)	10 Log (B) (dB)
5190	38.40	15.840
5230	38.44	15.850

802.11n\_HT40\_Ch1

Freq. (MHz)	6dB BW (MHz)	10 Log (B) (dB)
5755	30.77	14.880
5795	29.46	14.690
5835	36.32	15.600
5875	30.10	14.790

802.11n\_HT40\_Ch1

Freq. (MHz)	Measured Freq. (MHz)	Limit (MHz)
5230	5247.93	< 5250
5755	5736.83	> 5725

802.11ac\_VHT80\_Ch0

Freq. (MHz)	26dB BW (MHz)	10 Log (B) (dB)
5210	80.08	19.040

802.11ac\_VHT80\_Ch0

Freq. (MHz)	6dB BW (MHz)	10 Log (B) (dB)
5775	72.64	18.610
5855	73.87	18.680

802.11ac\_VHT80\_Ch0

Freq. (MHz)	Measured Freq. (MHz)	Limit (MHz)
5210	5247.44	< 5250
5775	5737.05	> 5725

Unless otherwise stated the results shown in this test report refer only to the sample(s) tested and such sample(s) are retained for 90 days only.

除非另有說明，此報告結果僅對測試之樣品負責，同時此樣品僅保留90天。本報告未經本公司書面許可，不可部份複製。

This document is issued by the Company subject to its General Conditions of Service printed overleaf, available on request or accessible at <http://www.sgs.com.tw/Terms-and-Conditions> and for electronic format documents, subject to Terms and Conditions for Electronic Documents at <http://www.sgs.com.tw/Terms-and-Conditions>. Attention is drawn to the limitation of liability, indemnification and jurisdiction issues defined therein. Any holder of this document is advised that information contained hereon reflects the Company's findings at the time of its intervention only and within the limits of Client's instructions, if any. The Company's sole responsibility is to its Client and this document does not exonerate parties to a transaction from exercising all their rights and obligations under the transaction documents. This document cannot be reproduced except in full, without prior written approval of the Company. Any unauthorized alteration, forgery or falsification of the content or appearance of this document is unlawful and offenders may be prosecuted to the fullest extent of the law.

802.11ac\_VHT80\_Ch1

Freq. (MHz)	26dB BW (MHz)	10 Log (B) (dB)
5210	79.89	19.020

802.11ac\_VHT80\_Ch1

Freq. (MHz)	6dB BW (MHz)	10 Log (B) (dB)
5775	65.66	18.170
5855	71.42	18.540

802.11ac\_VHT80\_Ch1

Freq. (MHz)	Measured Freq. (MHz)	Limit (MHz)
5210	5247.46	< 5250
5775	5736.95	> 5725

802.11ac\_VHT160\_Ch0

Freq. (MHz)	6dB BW (MHz)	10 Log (B) (dB)
5815(U-NII 3)	99.45	19.980
5815(U-NII 4)	29.45	14.690

802.11ac\_VHT160\_Ch1

Freq. (MHz)	6dB BW (MHz)	10 Log (B) (dB)
5815(U-NII 3)	108.34	20.350
5815(U-NII 4)	38.34	15.840

Unless otherwise stated the results shown in this test report refer only to the sample(s) tested and such sample(s) are retained for 90 days only.

除非另有說明，此報告結果僅對測試之樣品負責，同時此樣品僅保留90天。本報告未經本公司書面許可，不可部份複製。

This document is issued by the Company subject to its General Conditions of Service printed overleaf, available on request or accessible at <http://www.sgs.com.tw/Terms-and-Conditions> and for electronic format documents, subject to Terms and Conditions for Electronic Documents at <http://www.sgs.com.tw/Terms-and-Conditions>. Attention is drawn to the limitation of liability, indemnification and jurisdiction issues defined therein. Any holder of this document is advised that information contained hereon reflects the Company's findings at the time of its intervention only and within the limits of Client's instructions, if any. The Company's sole responsibility is to its Client and this document does not exonerate parties to a transaction from exercising all their rights and obligations under the transaction documents. This document cannot be reproduced except in full, without prior written approval of the Company. Any unauthorized alteration, forgery or falsification of the content or appearance of this document is unlawful and offenders may be prosecuted to the fullest extent of the law.

802.11ax\_HE20\_Ch0

Freq. (MHz)	RU config	26dB BW (MHz)	10 Log (B) (dB)
5180	full	20.37	13.090
5220	full	20.11	13.030
5240	full	20.68	13.160

802.11ax\_HE20\_Ch0

Freq. (MHz)	RU config	6dB BW (MHz)	10 Log (B) (dB)
5745	full	18.23	12.610
5785	full	13.52	11.310
5825	full	17.44	12.420
5845	full	18.39	12.650
5865	full	17.19	12.350
5885	full	17.34	12.390

802.11ax\_HE20\_Ch0

Freq. (MHz)	Measured Freq. (MHz)	Limit (MHz)
5240	5249.43	< 5250
5745	5735.50	> 5725

Unless otherwise stated the results shown in this test report refer only to the sample(s) tested and such sample(s) are retained for 90 days only.

除非另有說明，此報告結果僅對測試之樣品負責，同時此樣品僅保留90天。本報告未經本公司書面許可，不可部份複製。

This document is issued by the Company subject to its General Conditions of Service printed overleaf, available on request or accessible at <http://www.sgs.com.tw/Terms-and-Conditions> and for electronic format documents, subject to Terms and Conditions for Electronic Documents at <http://www.sgs.com.tw/Terms-and-Conditions>. Attention is drawn to the limitation of liability, indemnification and jurisdiction issues defined therein. Any holder of this document is advised that information contained hereon reflects the Company's findings at the time of its intervention only and within the limits of Client's instructions, if any. The Company's sole responsibility is to its Client and this document does not exonerate parties to a transaction from exercising all their rights and obligations under the transaction documents. This document cannot be reproduced except in full, without prior written approval of the Company. Any unauthorized alteration, forgery or falsification of the content or appearance of this document is unlawful and offenders may be prosecuted to the fullest extent of the law.

802.11ax\_HE20\_Ch1

Freq. (MHz)	RU config	26dB BW (MHz)	10 Log (B) (dB)
5180	full	20.19	13.050
5220	full	20.20	13.050
5240	full	20.04	13.020

802.11ax\_HE20\_Ch1

Freq. (MHz)	RU config	6dB BW (MHz)	10 Log (B) (dB)
5745	full	18.78	12.740
5785	full	18.18	12.600
5825	full	17.62	12.460
5845	full	18.16	12.590
5865	full	18.57	12.690
5885	full	18.01	12.560

802.11ax\_HE20\_Ch1

Freq. (MHz)	Measured Freq. (MHz)	Limit (MHz)
5240	5249.42	< 5250
5745	5735.46	> 5725

Unless otherwise stated the results shown in this test report refer only to the sample(s) tested and such sample(s) are retained for 90 days only.

除非另有說明，此報告結果僅對測試之樣品負責，同時此樣品僅保留90天。本報告未經本公司書面許可，不可部份複製。

This document is issued by the Company subject to its General Conditions of Service printed overleaf, available on request or accessible at <http://www.sgs.com.tw/Terms-and-Conditions> and for electronic format documents, subject to Terms and Conditions for Electronic Documents at <http://www.sgs.com.tw/Terms-and-Conditions>. Attention is drawn to the limitation of liability, indemnification and jurisdiction issues defined therein. Any holder of this document is advised that information contained hereon reflects the Company's findings at the time of its intervention only and within the limits of Client's instructions, if any. The Company's sole responsibility is to its Client and this document does not exonerate parties to a transaction from exercising all their rights and obligations under the transaction documents. This document cannot be reproduced except in full, without prior written approval of the Company. Any unauthorized alteration, forgery or falsification of the content or appearance of this document is unlawful and offenders may be prosecuted to the fullest extent of the law.



802.11ax\_HE40\_Ch0

Freq. (MHz)	RU config	26dB BW (MHz)	10 Log (B) (dB)
5190	full	39.64	15.980
5230	full	39.78	16.000

802.11ax\_HE40\_Ch0

Freq. (MHz)	RU config	6dB BW (MHz)	10 Log (B) (dB)
5755	full	27.89	14.450
5795	full	31.35	14.960
5835	full	37.25	15.710
5875	full	37.49	15.740

802.11ax\_HE40\_Ch0

Freq. (MHz)	Measured Freq. (MHz)	Limit (MHz)
5230	5248.69	< 5250
5755	5736.10	> 5725

Unless otherwise stated the results shown in this test report refer only to the sample(s) tested and such sample(s) are retained for 90 days only.

除非另有說明，此報告結果僅對測試之樣品負責，同時此樣品僅保留90天。本報告未經本公司書面許可，不可部份複製。

This document is issued by the Company subject to its General Conditions of Service printed overleaf, available on request or accessible at <http://www.sgs.com.tw/Terms-and-Conditions> and for electronic format documents, subject to Terms and Conditions for Electronic Documents at <http://www.sgs.com.tw/Terms-and-Conditions>. Attention is drawn to the limitation of liability, indemnification and jurisdiction issues defined therein. Any holder of this document is advised that information contained hereon reflects the Company's findings at the time of its intervention only and within the limits of Client's instructions, if any. The Company's sole responsibility is to its Client and this document does not exonerate parties to a transaction from exercising all their rights and obligations under the transaction documents. This document cannot be reproduced except in full, without prior written approval of the Company. Any unauthorized alteration, forgery or falsification of the content or appearance of this document is unlawful and offenders may be prosecuted to the fullest extent of the law.

802.11ax\_HE40\_Ch1

Freq. (MHz)	RU config	26dB BW (MHz)	10 Log (B) (dB)
5190	full	39.73	15.990
5230	full	39.44	15.960

802.11ax\_HE40\_Ch1

Freq. (MHz)	RU config	6dB BW (MHz)	10 Log (B) (dB)
5755	full	31.31	14.960
5795	full	36.78	15.660
5835	full	37.50	15.740
5875	full	36.38	15.610

802.11ax\_HE40\_Ch1

Freq. (MHz)	Measured Freq. (MHz)	Limit (MHz)
5230	5248.69	< 5250
5755	5736.06	> 5725

802.11ax\_HE80\_Ch0

Freq. (MHz)	RU config	26dB BW (MHz)	10 Log (B) (dB)
5210	full	81.07	19.090

802.11ax\_HE80\_Ch0

Freq. (MHz)	RU config	6dB BW (MHz)	10 Log (B) (dB)
5775	full	71.17	18.520
5855	full	75.83	18.800

802.11ax\_HE80\_Ch0

Freq. (MHz)	Measured Freq. (MHz)	Limit (MHz)
5210	5248.20	< 5250
5775	5736.23	> 5725

Unless otherwise stated the results shown in this test report refer only to the sample(s) tested and such sample(s) are retained for 90 days only.

除非另有說明，此報告結果僅對測試之樣品負責，同時此樣品僅保留90天。本報告未經本公司書面許可，不可部份複製。

This document is issued by the Company subject to its General Conditions of Service printed overleaf, available on request or accessible at <http://www.sgs.com.tw/Terms-and-Conditions> and for electronic format documents, subject to Terms and Conditions for Electronic Documents at <http://www.sgs.com.tw/Terms-and-Conditions>. Attention is drawn to the limitation of liability, indemnification and jurisdiction issues defined therein. Any holder of this document is advised that information contained hereon reflects the Company's findings at the time of its intervention only and within the limits of Client's instructions, if any. The Company's sole responsibility is to its Client and this document does not exonerate parties to a transaction from exercising all their rights and obligations under the transaction documents. This document cannot be reproduced except in full, without prior written approval of the Company. Any unauthorized alteration, forgery or falsification of the content or appearance of this document is unlawful and offenders may be prosecuted to the fullest extent of the law.

802.11ax\_HE80\_Ch1

Freq. (MHz)	RU config	26dB BW (MHz)	10 Log (B) (dB)
5210	full	79.91	19.030

802.11ax\_HE80\_Ch1

Freq. (MHz)	RU config	6dB BW (MHz)	10 Log (B) (dB)
5775	full	75.63	18.790
5855	full	75.59	18.780

802.11ax\_HE80\_Ch1

Freq. (MHz)	Measured Freq. (MHz)	Limit (MHz)
5210	5248.22	< 5250
5775	5736.14	> 5725

802.11ax\_HE160\_Ch0

Freq. (MHz)		6dB BW (MHz)	10 Log (B) (dB)
5815 (U-NII 3)	full	95.31	19.790
5815 (U-NII 4)	full	25.31	14.030

802.11ax\_HE160\_Ch1

Freq. (MHz)		6dB BW (MHz)	10 Log (B) (dB)
5815 (U-NII 3)	full	102.82	20.120
5815 (U-NII 4)	full	32.81	15.160

Unless otherwise stated the results shown in this test report refer only to the sample(s) tested and such sample(s) are retained for 90 days only.

除非另有說明，此報告結果僅對測試之樣品負責，同時此樣品僅保留90天。本報告未經本公司書面許可，不可部份複製。

This document is issued by the Company subject to its General Conditions of Service printed overleaf, available on request or accessible at <http://www.sgs.com.tw/Terms-and-Conditions> and for electronic format documents, subject to Terms and Conditions for Electronic Documents at <http://www.sgs.com.tw/Terms-and-Conditions>. Attention is drawn to the limitation of liability, indemnification and jurisdiction issues defined therein. Any holder of this document is advised that information contained hereon reflects the Company's findings at the time of its intervention only and within the limits of Client's instructions, if any. The Company's sole responsibility is to its Client and this document does not exonerate parties to a transaction from exercising all their rights and obligations under the transaction documents. This document cannot be reproduced except in full, without prior written approval of the Company. Any unauthorized alteration, forgery or falsification of the content or appearance of this document is unlawful and offenders may be prosecuted to the fullest extent of the law.

802.11a\_20MHz\_Chain0\_5180MHz

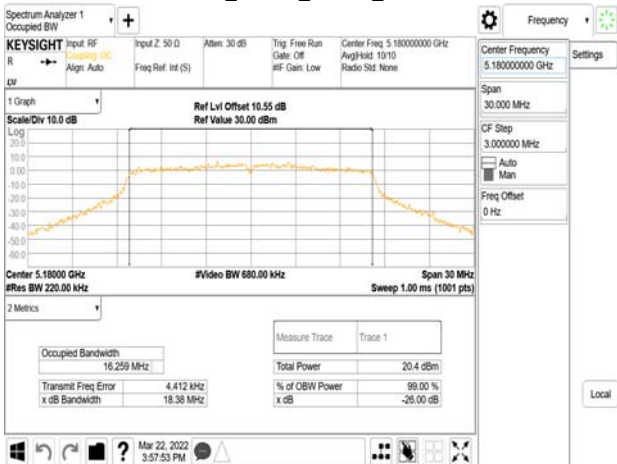

802.11a\_20MHz\_Chain0\_5745MHz



802.11a\_20MHz\_Chain0\_5220MHz

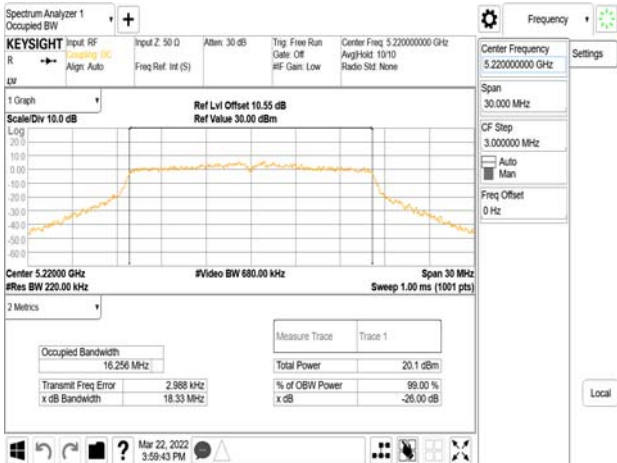

802.11a\_20MHz\_Chain0\_5785MHz

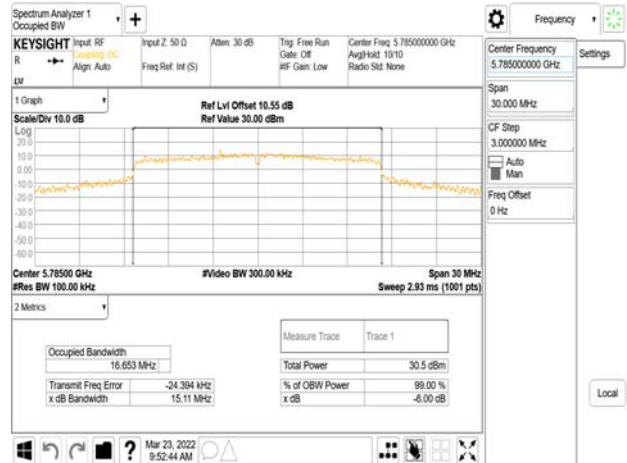

802.11a\_20MHz\_Chain0\_5240MHz



802.11a\_20MHz\_Chain0\_5825MHz



Unless otherwise stated the results shown in this test report refer only to the sample(s) tested and such sample(s) are retained for 90 days only.

除非另有說明，此報告結果僅對測試之樣品負責，同時此樣品僅保留90天。本報告未經本公司書面許可，不可部份複製。

This document is issued by the Company subject to its General Conditions of Service printed overleaf, available on request or accessible at <http://www.sgs.com.tw/Terms-and-Conditions> and for electronic format documents, subject to Terms and Conditions for Electronic Documents at <http://www.sgs.com.tw/Terms-and-Conditions>. Attention is drawn to the limitation of liability, indemnification and jurisdiction issues defined therein. Any holder of this document is advised that information contained herein reflects the Company's findings at the time of its intervention only and within the limits of Client's instructions, if any. The Company's sole responsibility is to its Client and this document does not exonerate parties to a transaction from exercising all their rights and obligations under the transaction documents. This document cannot be reproduced except in full, without prior written approval of the Company. Any unauthorized alteration, forgery or falsification of the content or appearance of this document is unlawful and offenders may be prosecuted to the fullest extent of the law.

802.11a\_20MHz\_Chain0\_5845MHz

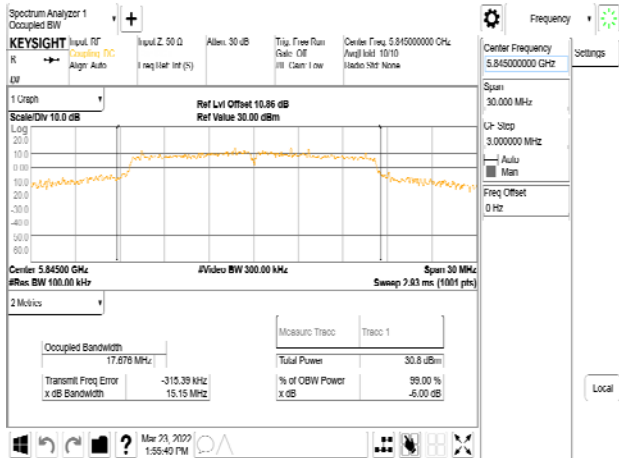

802.11a\_20MHz\_Chain1\_5180MHz

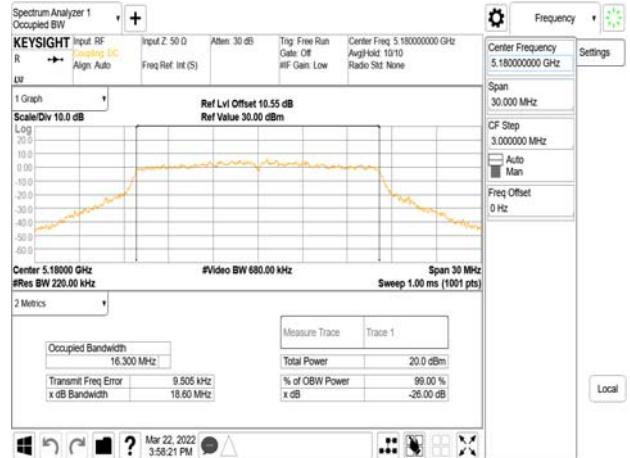

802.11a\_20MHz\_Chain0\_5865MHz

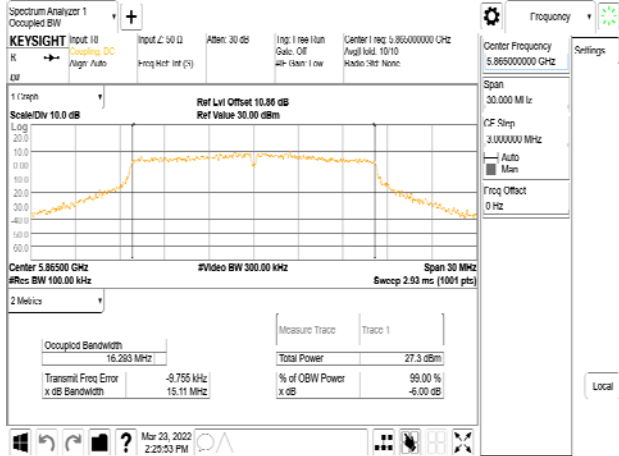

802.11a\_20MHz\_Chain1\_5220MHz

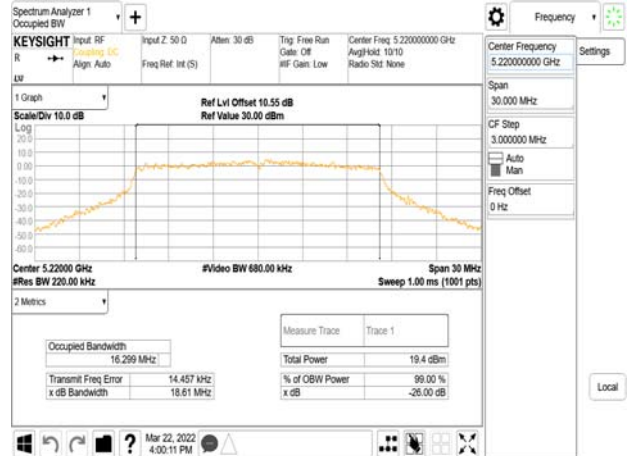

802.11a\_20MHz\_Chain0\_5885MHz

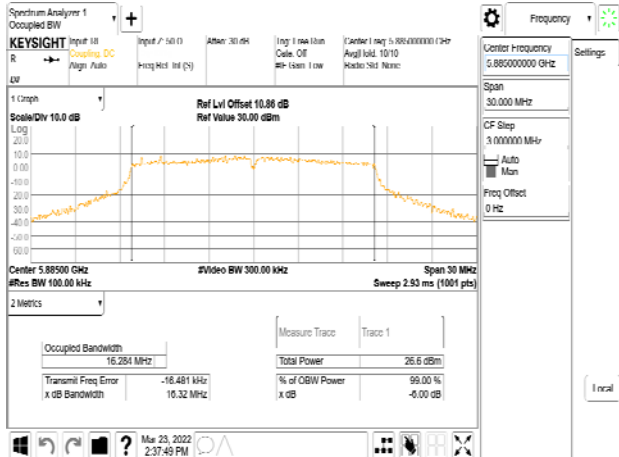

802.11a\_20MHz\_Chain1\_5240MHz



Unless otherwise stated the results shown in this test report refer only to the sample(s) tested and such sample(s) are retained for 90 days only.

除非另有說明，此報告結果僅對測試之樣品負責，同時此樣品僅保留90天。本報告未經本公司書面許可，不可部份複製。

This document is issued by the Company subject to its General Conditions of Service printed overleaf, available on request or accessible at <http://www.sgs.com.tw/Terms-and-Conditions> and for electronic format documents, subject to Terms and Conditions for Electronic Documents at <http://www.sgs.com.tw/Terms-and-Conditions>. Attention is drawn to the limitation of liability, indemnification and jurisdiction issues defined therein. Any holder of this document is advised that information contained herein reflects the Company's findings at the time of its intervention only and within the limits of Client's instructions, if any. The Company's sole responsibility is to its Client and this document does not exonerate parties to a transaction from exercising all their rights and obligations under the transaction documents. This document cannot be reproduced except in full, without prior written approval of the Company. Any unauthorized alteration, forgery or falsification of the content or appearance of this document is unlawful and offenders may be prosecuted to the fullest extent of the law.

802.11a\_20MHz\_Chain1\_5745MHz



802.11a\_20MHz\_Chain1\_5845MHz

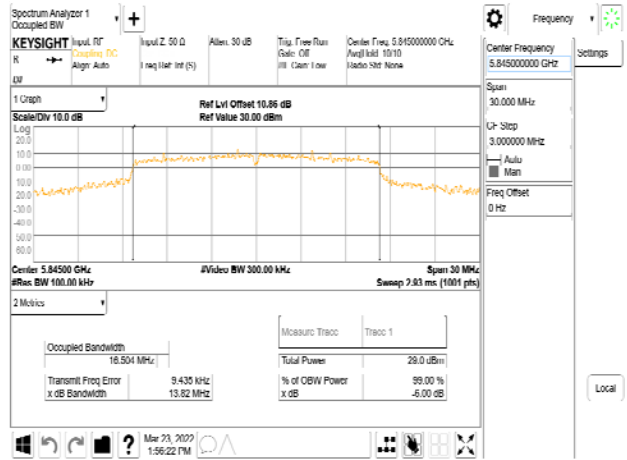

802.11a\_20MHz\_Chain1\_5785MHz

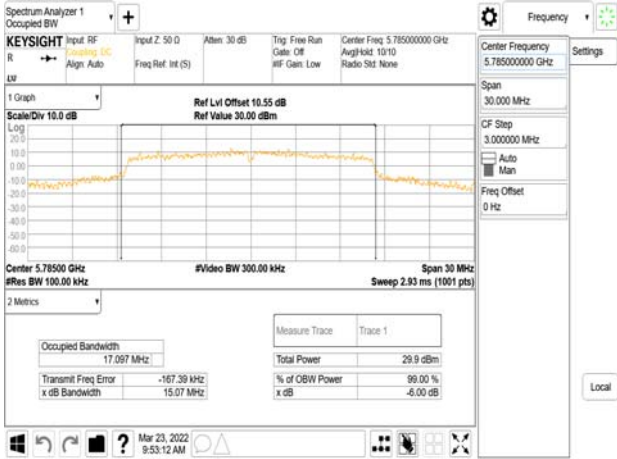

802.11a\_20MHz\_Chain1\_5865MHz

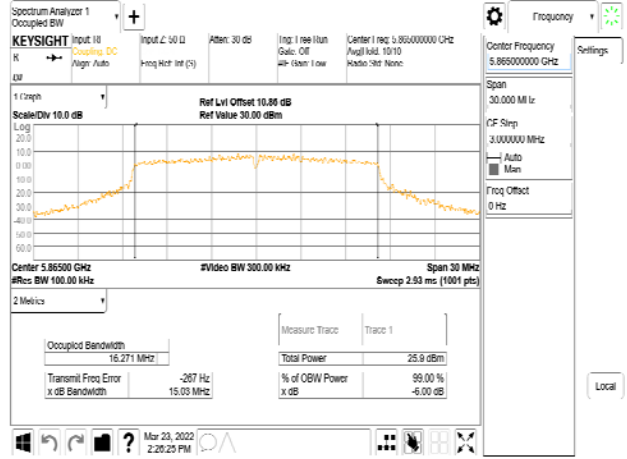

802.11a\_20MHz\_Chain1\_5825MHz

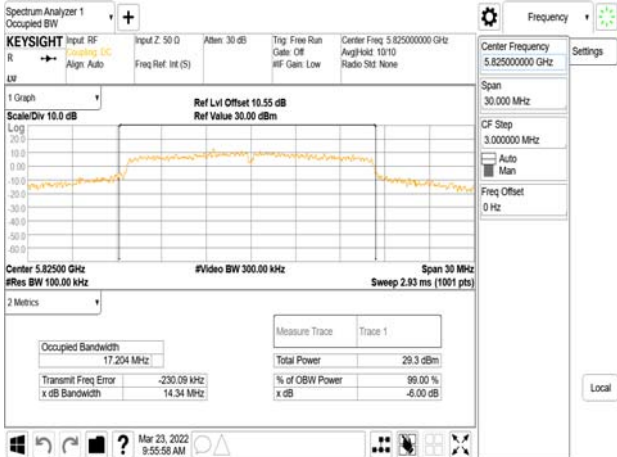

802.11a\_20MHz\_Chain1\_5885MHz

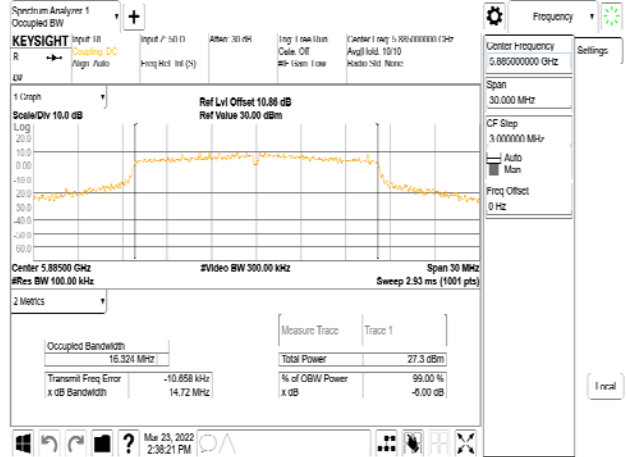

Unless otherwise stated the results shown in this test report refer only to the sample(s) tested and such sample(s) are retained for 90 days only.

除非另有說明，此報告結果僅對測試之樣品負責，同時此樣品僅保留90天。本報告未經本公司書面許可，不可部份複製。

This document is issued by the Company subject to its General Conditions of Service printed overleaf, available on request or accessible at <http://www.sgs.com.tw/Terms-and-Conditions> and for electronic format documents, subject to Terms and Conditions for Electronic Documents at <http://www.sgs.com.tw/Terms-and-Conditions>. Attention is drawn to the limitation of liability, indemnification and jurisdiction issues defined therein. Any holder of this document is advised that information contained herein reflects the Company's findings at the time of its intervention only and within the limits of Client's instructions, if any. The Company's sole responsibility is to its Client and this document does not exonerate parties to a transaction from exercising all their rights and obligations under the transaction documents. This document cannot be reproduced except in full, without prior written approval of the Company. Any unauthorized alteration, forgery or falsification of the content or appearance of this document is unlawful and offenders may be prosecuted to the fullest extent of the law.



802.11n\_20MHz\_Chain0\_5180MHz

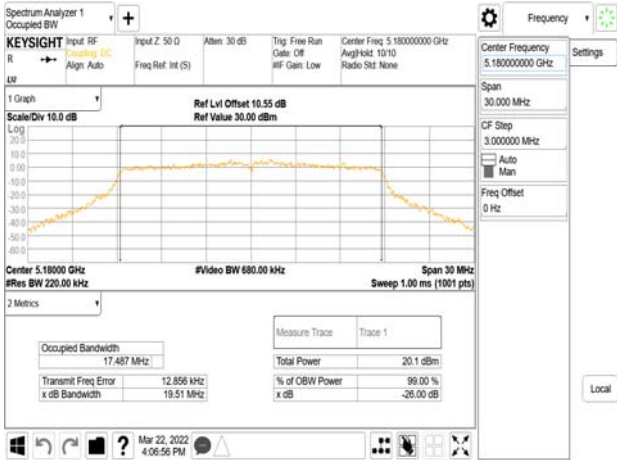

802.11n\_20MHz\_Chain0\_5745MHz



802.11n\_20MHz\_Chain0\_5220MHz



802.11n\_20MHz\_Chain0\_5785MHz

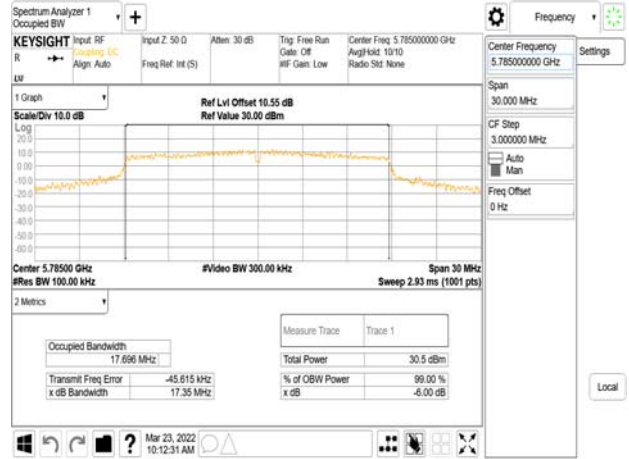

802.11n\_20MHz\_Chain0\_5240MHz



802.11n\_20MHz\_Chain0\_5825MHz

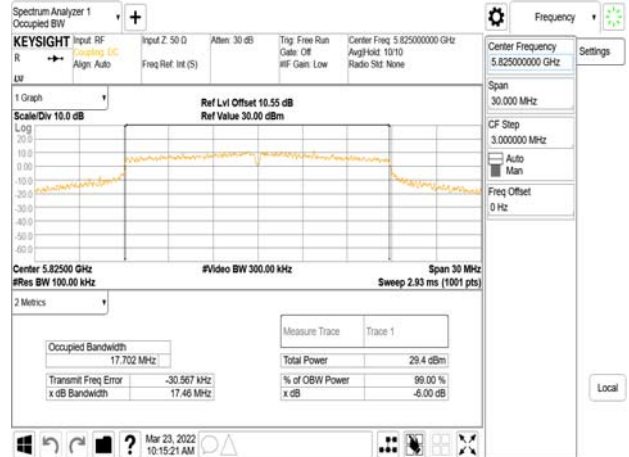

Unless otherwise stated the results shown in this test report refer only to the sample(s) tested and such sample(s) are retained for 90 days only.

除非另有說明，此報告結果僅對測試之樣品負責，同時此樣品僅保留90天。本報告未經本公司書面許可，不可部份複製。

This document is issued by the Company subject to its General Conditions of Service printed overleaf, available on request or accessible at <http://www.sgs.com.tw/Terms-and-Conditions> and for electronic format documents, subject to Terms and Conditions for Electronic Documents at <http://www.sgs.com.tw/Terms-and-Conditions>. Attention is drawn to the limitation of liability, indemnification and jurisdiction issues defined therein. Any holder of this document is advised that information contained herein reflects the Company's findings at the time of its intervention only and within the limits of Client's instructions, if any. The Company's sole responsibility is to its Client and this document does not exonerate parties to a transaction from exercising all their rights and obligations under the transaction documents. This document cannot be reproduced except in full, without prior written approval of the Company. Any unauthorized alteration, forgery or falsification of the content or appearance of this document is unlawful and offenders may be prosecuted to the fullest extent of the law.

802.11n\_20MHz\_Chain0\_5845MHz

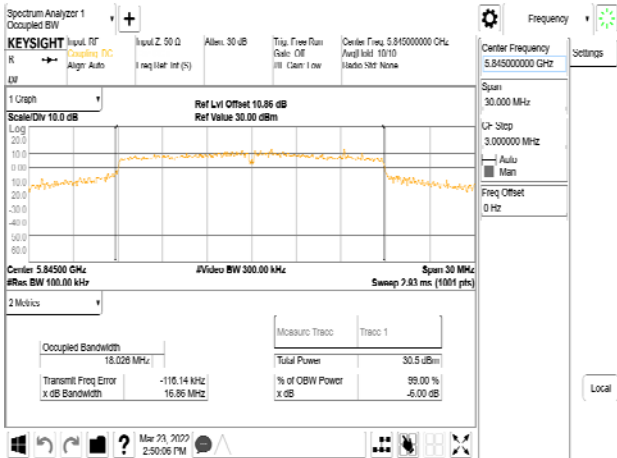

802.11n\_20MHz\_Chain1\_5180MHz

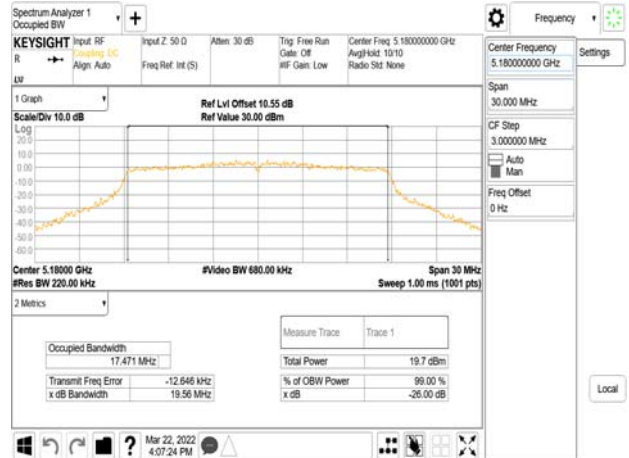

802.11n\_20MHz\_Chain0\_5865MHz

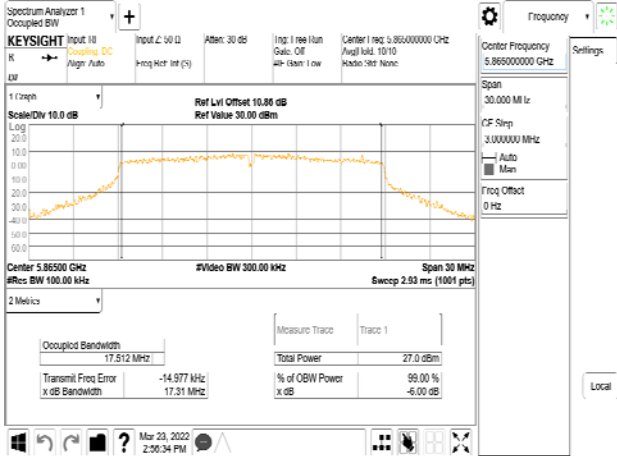

802.11n\_20MHz\_Chain1\_5220MHz

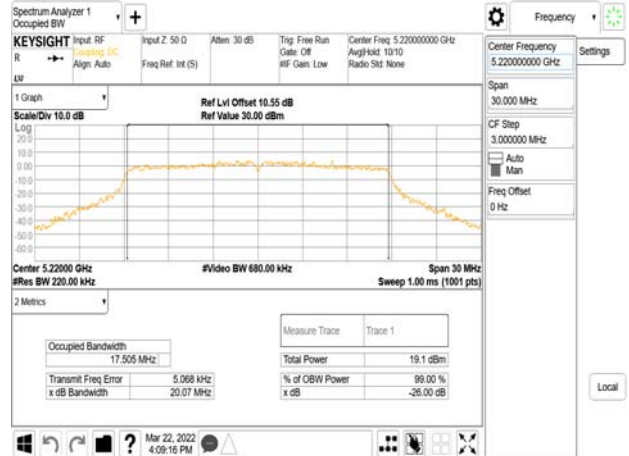

802.11n\_20MHz\_Chain0\_5885MHz

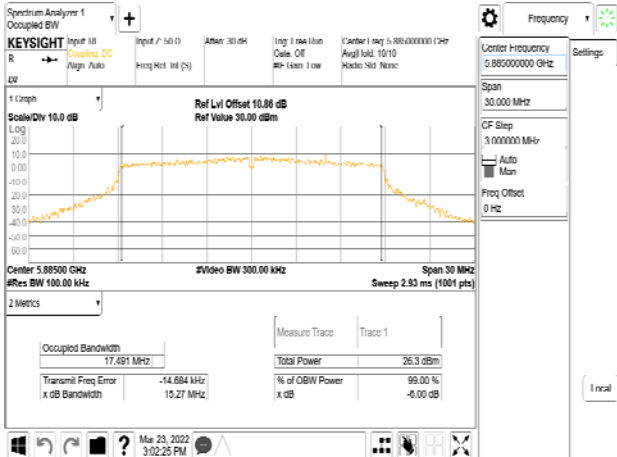

802.11n\_20MHz\_Chain1\_5240MHz



Unless otherwise stated the results shown in this test report refer only to the sample(s) tested and such sample(s) are retained for 90 days only.

除非另有說明，此報告結果僅對測試之樣品負責，同時此樣品僅保留90天。本報告未經本公司書面許可，不可部份複製。

This document is issued by the Company subject to its General Conditions of Service printed overleaf, available on request or accessible at <http://www.sgs.com.tw/Terms-and-Conditions> and for electronic format documents, subject to Terms and Conditions for Electronic Documents at <http://www.sgs.com.tw/Terms-and-Conditions>. Attention is drawn to the limitation of liability, indemnification and jurisdiction issues defined therein. Any holder of this document is advised that information contained herein reflects the Company's findings at the time of its intervention only and within the limits of Client's instructions, if any. The Company's sole responsibility is to its Client and this document does not exonerate parties to a transaction from exercising all their rights and obligations under the transaction documents. This document cannot be reproduced except in full, without prior written approval of the Company. Any unauthorized alteration, forgery or falsification of the content or appearance of this document is unlawful and offenders may be prosecuted to the fullest extent of the law.



802.11n\_20MHz\_Chain1\_5745MHz



802.11n\_20MHz\_Chain1\_5845MHz

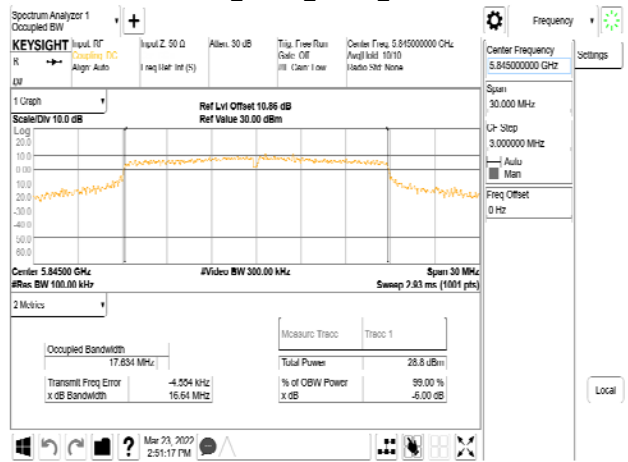

802.11n\_20MHz\_Chain1\_5785MHz

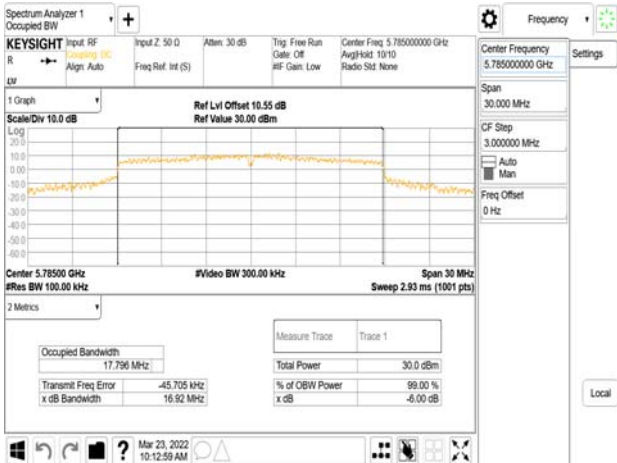

802.11n\_20MHz\_Chain1\_5865MHz

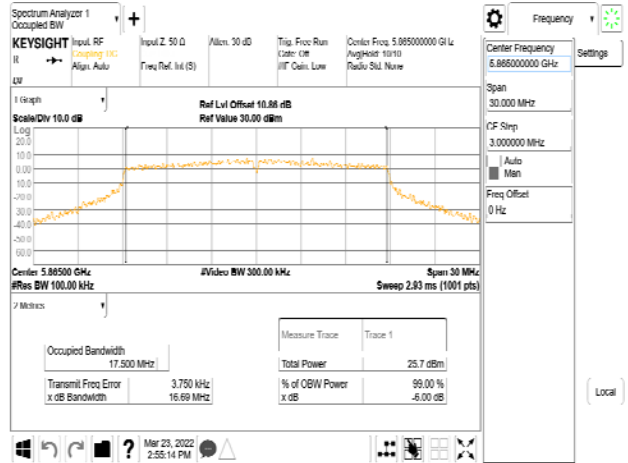

802.11n\_20MHz\_Chain1\_5825MHz



802.11n\_20MHz\_Chain1\_5885MHz

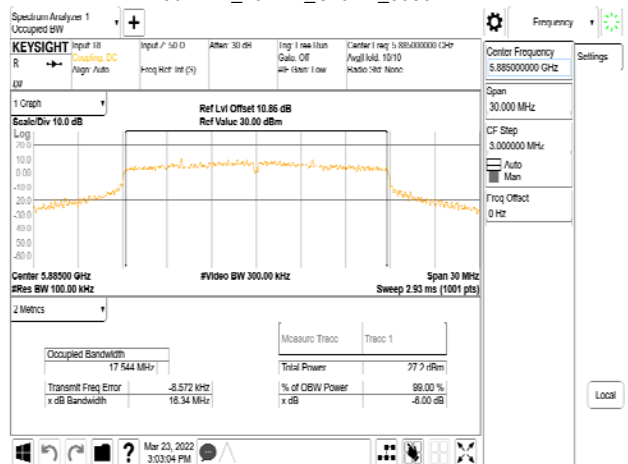

Unless otherwise stated the results shown in this test report refer only to the sample(s) tested and such sample(s) are retained for 90 days only.

除非另有說明，此報告結果僅對測試之樣品負責，同時此樣品僅保留90天。本報告未經本公司書面許可，不可部份複製。

This document is issued by the Company subject to its General Conditions of Service printed overleaf, available on request or accessible at <http://www.sgs.com.tw/Terms-and-Conditions> and for electronic format documents, subject to Terms and Conditions for Electronic Documents at <http://www.sgs.com.tw/Terms-and-Conditions>. Attention is drawn to the limitation of liability, indemnification and jurisdiction issues defined therein. Any holder of this document is advised that information contained herein reflects the Company's findings at the time of its intervention only and within the limits of Client's instructions, if any. The Company's sole responsibility is to its Client and this document does not exonerate parties to a transaction from exercising all their rights and obligations under the transaction documents. This document cannot be reproduced except in full, without prior written approval of the Company. Any unauthorized alteration, forgery or falsification of the content or appearance of this document is unlawful and offenders may be prosecuted to the fullest extent of the law.

802.11n\_40MHz\_Chain0\_5190MHz

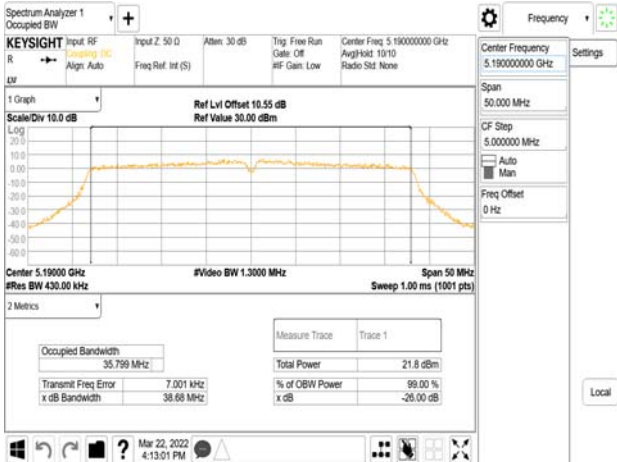

802.11n\_40MHz\_Chain0\_5795MHz

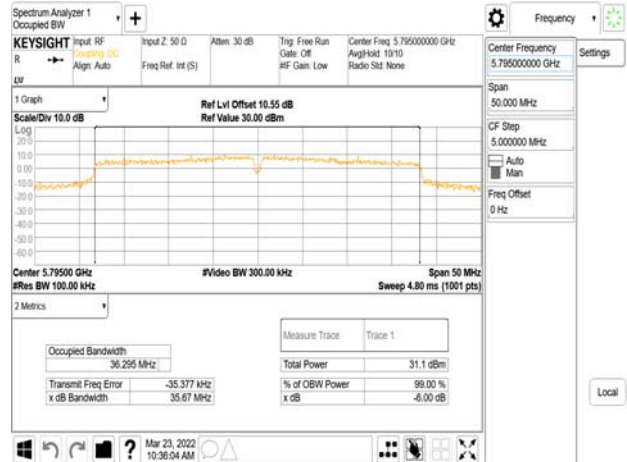

802.11n\_40MHz\_Chain0\_5230MHz



802.11n\_40MHz\_Chain0\_5835MHz

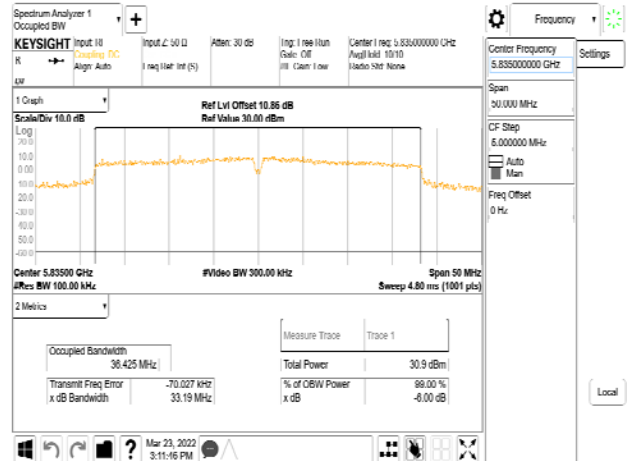

802.11n\_40MHz\_Chain0\_5755MHz



802.11n\_40MHz\_Chain0\_5875MHz

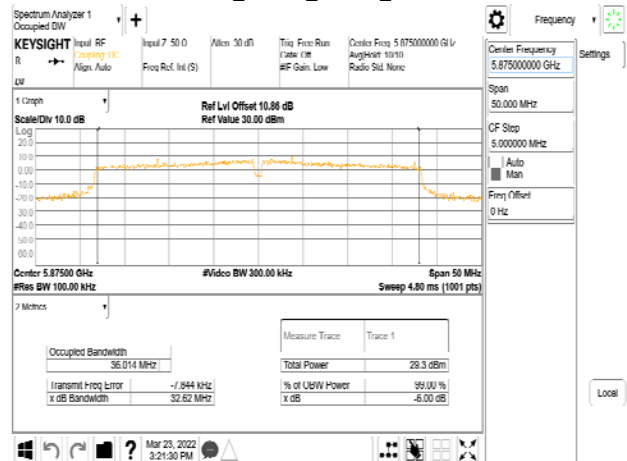

Unless otherwise stated the results shown in this test report refer only to the sample(s) tested and such sample(s) are retained for 90 days only.

除非另有說明，此報告結果僅對測試之樣品負責，同時此樣品僅保留90天。本報告未經本公司書面許可，不可部份複製。

This document is issued by the Company subject to its General Conditions of Service printed overleaf, available on request or accessible at <http://www.sgs.com.tw/Terms-and-Conditions> and for electronic format documents, subject to Terms and Conditions for Electronic Documents at <http://www.sgs.com.tw/Terms-and-Conditions>. Attention is drawn to the limitation of liability, indemnification and jurisdiction issues defined therein. Any holder of this document is advised that information contained herein reflects the Company's findings at the time of its intervention only and within the limits of Client's instructions, if any. The Company's sole responsibility is to its Client and this document does not exonerate parties to a transaction from exercising all their rights and obligations under the transaction documents. This document cannot be reproduced except in full, without prior written approval of the Company. Any unauthorized alteration, forgery or falsification of the content or appearance of this document is unlawful and offenders may be prosecuted to the fullest extent of the law.

802.11n\_40MHz\_Chain1\_5190MHz

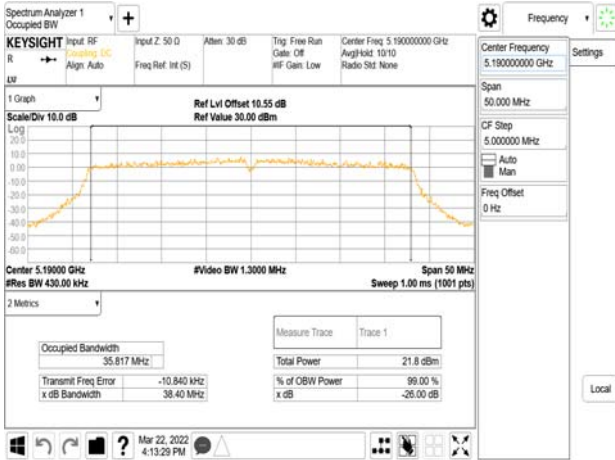

802.11n\_40MHz\_Chain1\_5795MHz

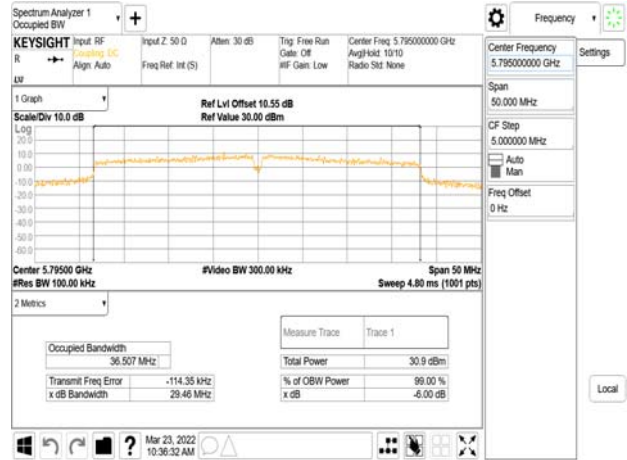

802.11n\_40MHz\_Chain1\_5230MHz



802.11n\_40MHz\_Chain1\_5835MHz

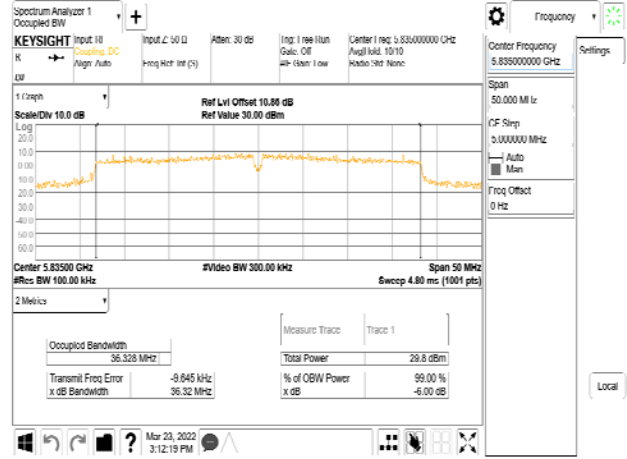

802.11n\_40MHz\_Chain1\_5755MHz

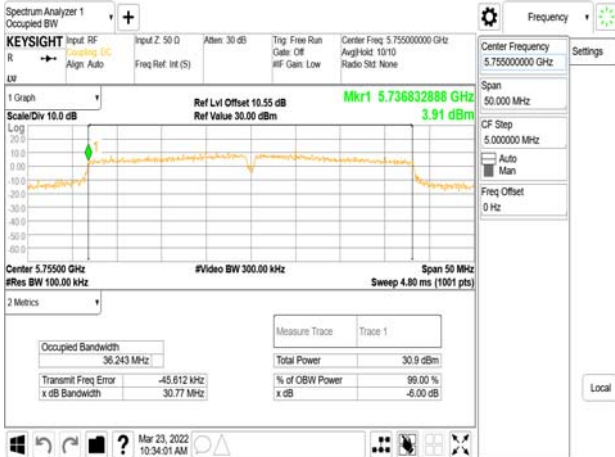

802.11n\_40MHz\_Chain1\_5875MHz

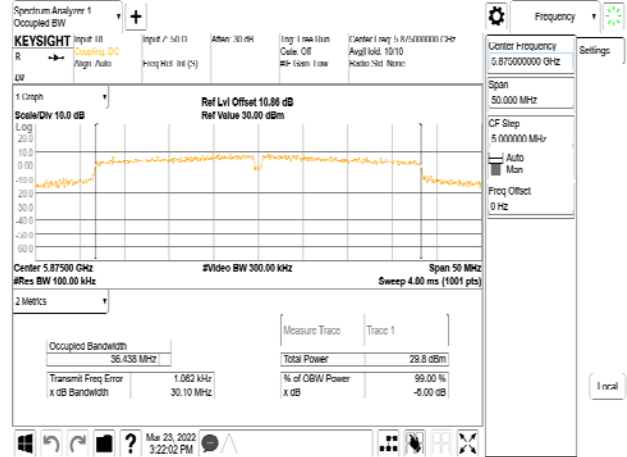

Unless otherwise stated the results shown in this test report refer only to the sample(s) tested and such sample(s) are retained for 90 days only.

除非另有說明，此報告結果僅對測試之樣品負責，同時此樣品僅保留90天。本報告未經本公司書面許可，不可部份複製。

This document is issued by the Company subject to its General Conditions of Service printed overleaf, available on request or accessible at <http://www.sgs.com.tw/Terms-and-Conditions> and for electronic format documents, subject to Terms and Conditions for Electronic Documents at <http://www.sgs.com.tw/Terms-and-Conditions>. Attention is drawn to the limitation of liability, indemnification and jurisdiction issues defined therein. Any holder of this document is advised that information contained herein reflects the Company's findings at the time of its intervention only and within the limits of Client's instructions, if any. The Company's sole responsibility is to its Client and this document does not exonerate parties to a transaction from exercising all their rights and obligations under the transaction documents. This document cannot be reproduced except in full, without prior written approval of the Company. Any unauthorized alteration, forgery or falsification of the content or appearance of this document is unlawful and offenders may be prosecuted to the fullest extent of the law.

802.11ac\_80MHz\_Chain0\_5210MHz



802.11ac\_80MHz\_Chain1\_5210MHz



802.11ac\_80MHz\_Chain0\_5775MHz



802.11ac\_80MHz\_Chain1\_5775MHz



802.11ac\_80MHz\_Chain0\_5855MHz

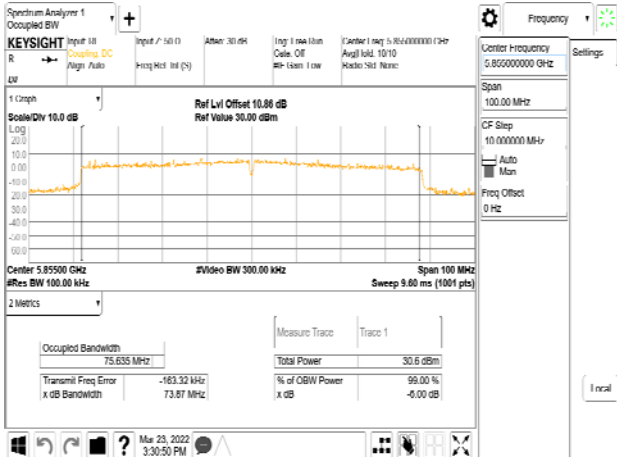

802.11ac\_80MHz\_Chain1\_5855MHz

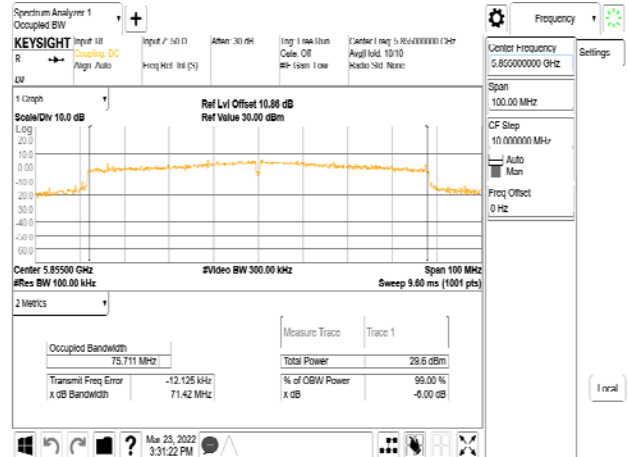

Unless otherwise stated the results shown in this test report refer only to the sample(s) tested and such sample(s) are retained for 90 days only.

除非另有說明，此報告結果僅對測試之樣品負責，同時此樣品僅保留90天。本報告未經本公司書面許可，不可部份複製。

This document is issued by the Company subject to its General Conditions of Service printed overleaf, available on request or accessible at <http://www.sgs.com.tw/Terms-and-Conditions> and for electronic format documents, subject to Terms and Conditions for Electronic Documents at <http://www.sgs.com.tw/Terms-and-Conditions>. Attention is drawn to the limitation of liability, indemnification and jurisdiction issues defined therein. Any holder of this document is advised that information contained herein reflects the Company's findings at the time of its intervention only and within the limits of Client's instructions, if any. The Company's sole responsibility is to its Client and this document does not exonerate parties to a transaction from exercising all their rights and obligations under the transaction documents. This document cannot be reproduced except in full, without prior written approval of the Company. Any unauthorized alteration, forgery or falsification of the content or appearance of this document is unlawful and offenders may be prosecuted to the fullest extent of the law.