

## FCC Test Report

**Report No.:** RF160518C01A R1

**FCC ID:** A4R-G015A

**Test Model:** G015A

**Received Date:** Jun. 22, 2017

**Test Date:** Jun. 30, 2017 ~ Sep. 08, 2017

**Issued Date:** Oct. 17, 2017

**Applicant:** Google LLC

**Address:** 1600 Amphitheatre Parkway Mountain View, CA 94043 USA

**Issued By:** Bureau Veritas Consumer Products Services (H.K.) Ltd., Taoyuan Branch

**Lab Address:** No. 47-2, 14th Ling, Chia Pau Vil., Lin Kou Dist., New Taipei City, Taiwan  
( R.O.C )

**Test Location:** No.19, Hwa Ya 2nd Rd., Wen Hwa Vil., Kwei Shan Dist., Taoyuan City  
33383, Taiwan, R.O.C.



This report is for your exclusive use. Any copying or replication of this report to or for any other person or entity, or use of our name or trademark, is permitted only with our prior written permission. This report sets forth our findings solely with respect to the test samples identified herein. The results set forth in this report are not indicative or representative of the quality or characteristics of the lot from which a test sample was taken or any similar or identical product unless specifically and expressly noted. Our report includes all of the tests requested by you and the results thereof based upon the information that you provided to us. You have 60 days from date of issuance of this report to notify us of any material error or omission caused by our negligence, provided, however, that such notice shall be in writing and shall specifically address the issue you wish to raise. A failure to raise such issue within the prescribed time shall constitute your unqualified acceptance of the completeness of this report, the tests conducted and the correctness of the report contents. Unless specifically mentioned, the uncertainty of measurement has been explicitly taken into account to declare the compliance or non-compliance to the specification.

## Table of Contents

<b>Release Control Record</b> .....	<b>4</b>
<b>1 Certificate of Conformity</b> .....	<b>5</b>
<b>2 Summary of Test Results</b> .....	<b>6</b>
2.1 Measurement Uncertainty .....	6
2.2 Modification Record .....	6
<b>3 General Information</b> .....	<b>7</b>
3.1 General Description of EUT .....	7
3.2 Description of Test Modes .....	8
3.2.1 Test Mode Applicability and Tested Channel Detail .....	9
3.3 Duty Cycle of Test Signal .....	11
3.4 Description of Support Units .....	12
3.4.1 Configuration of System under Test .....	12
3.5 General Description of Applied Standards .....	12
<b>4 Test Types and Results</b> .....	<b>13</b>
4.1 Radiated Emission and Bandedge Measurement .....	13
4.1.1 Limits of Radiated Emission and Bandedge Measurement .....	13
4.1.2 Test Instruments .....	14
4.1.3 Test Procedures .....	15
4.1.4 Deviation from Test Standard .....	15
4.1.5 Test Set Up .....	16
4.1.6 EUT Operating Conditions .....	16
4.1.7 Test Results .....	17
4.2 Conducted Emission Measurement .....	43
4.2.1 Limits of Conducted Emission Measurement .....	43
4.2.2 Test Instruments .....	43
4.2.3 Test Procedures .....	44
4.2.4 Deviation from Test Standard .....	44
4.2.5 Test Setup .....	44
4.2.6 EUT Operating Conditions .....	44
4.2.7 Test Results .....	45
4.3 6 dB Bandwidth Measurement .....	47
4.3.1 Limits of 6 dB Bandwidth Measurement .....	47
4.3.2 Test Setup .....	47
4.3.3 Test Instruments .....	47
4.3.4 Test Procedure .....	47
4.3.5 Deviation from Test Standard .....	47
4.3.6 EUT Operating Conditions .....	47
4.3.7 Test Result .....	48
4.4 Occupied Bandwidth Measurement .....	50
4.4.1 Test Setup .....	50
4.4.2 Test Instruments .....	50
4.4.3 Test Procedure .....	50
4.4.4 Deviation From Test Standard .....	50
4.4.5 EUT Operating Conditions .....	50
4.4.6 Test Results .....	51
4.5 Conducted Output Power Measurement .....	53
4.5.1 Limits of Conducted Output Power Measurement .....	53
4.5.2 Test Setup .....	53
4.5.3 Test Instruments .....	53
4.5.4 Test Procedures .....	53
4.5.5 Deviation from Test Standard .....	53
4.5.6 EUT Operating Conditions .....	53
4.5.7 Test Results .....	54

4.6	Power Spectral Density Measurement .....	55
4.6.1	Limits of Power Spectral Density Measurement.....	55
4.6.2	Test Setup.....	55
4.6.3	Test Instruments .....	55
4.6.4	Test Procedure .....	55
4.6.5	Deviation from Test Standard .....	55
4.6.6	EUT Operating Condition .....	55
4.6.7	Test Results .....	56
4.7	Conducted Out of Band Emission Measurement .....	58
4.7.1	Limits of Conducted Out of Band Emission Measurement.....	58
4.7.2	Test Setup.....	58
4.7.3	Test Instruments .....	58
4.7.4	Test Procedure .....	58
4.7.5	Deviation from Test Standard .....	58
4.7.6	EUT Operating Condition .....	58
4.7.7	Test Results .....	59
	<b>Annex A- Radiated Bandedge Plots.....</b>	<b>67</b>
	<b>5 Pictures of Test Arrangements.....</b>	<b>71</b>
	<b>Appendix – Information on the Testing Laboratories .....</b>	<b>72</b>

### Release Control Record

Issue No.	Description	Date Issued
RF160518C01A	Original Release	Sep. 13, 2017
RF160518C01A R1	Revise information of applicant.	Oct. 17, 2017

## 1 Certificate of Conformity

**Product:** Wireless Device  
**Test Model:** G015A  
**Sample Status:** Identical Prototype  
**Applicant:** Google LLC  
**Test Date:** Jun. 30, 2017 ~ Sep. 08, 2017  
**Standards:** 47 CFR FCC Part 15, Subpart C (Section 15.247)  
ANSI C63.10:2013

The above equipment has been tested by **Bureau Veritas Consumer Products Services (H.K.) Ltd., Taoyuan Branch**, and found compliance with the requirement of the above standards. The test record, data evaluation & Equipment Under Test (EUT) configurations represented herein are true and accurate accounts of the measurements of the sample's EMC characteristics under the conditions specified in this report.

**Prepared by :** Rona Chen , **Date:** Oct. 17, 2017  
Rona Chen / Specialist

**Approved by :** Dylan Chiou , **Date:** Oct. 17, 2017  
Dylan Chiou / Project Engineer

## 2 Summary of Test Results

47 CFR FCC Part 15, Subpart C (Section 15.247)			
FCC Clause	Test Item	Result	Remarks
15.207	AC Power Conducted Emission	Pass	Meet the requirement of limit. Minimum passing margin is -21.15 dB at 0.64600 MHz.
15.205 / 15.209 / 15.247(d)	Radiated Emissions and Band Edge Measurement	Pass	Meet the requirement of limit. Minimum passing margin is -7.33 dB at 2389 MHz.
15.247(d)	Antenna Port Emission	Pass	Meet the requirement of limit.
15.247(a)(2)	6 dB Bandwidth	Pass	Meet the requirement of limit.
---	Occupied Bandwidth Measurement	Pass	Reference only
15.247(b)	Conducted power	Pass	Meet the requirement of limit.
15.247(e)	Power Spectral Density	Pass	Meet the requirement of limit.
15.203	Antenna Requirement	Pass	No antenna connector is used.

### 2.1 Measurement Uncertainty

Where relevant, the following measurement uncertainty levels have been estimated for tests performed on the EUT:

The listed uncertainties are the worst case uncertainty for the entire range of measurement. Please note that the uncertainty values are provided for informational purposes only and are not used in determining the PASS/FAIL results.

Measurement	Frequency	Expanded Uncertainty (k=2) (±)
Conducted Emissions at mains ports	150 kHz ~ 30 MHz	2.44 dB
Radiated Emissions up to 1 GHz	30 MHz ~ 200 MHz	2.93 dB
	200 MHz ~ 1000 MHz	2.95 dB
Radiated Emissions above 1 GHz	1 GHz ~ 18 GHz	2.26 dB
	18 GHz ~ 40 GHz	1.94 dB

### 2.2 Modification Record

There were no modifications required for compliance.

### 3 General Information

#### 3.1 General Description of EUT

<b>Product</b>	Wireless Device
<b>Test Model</b>	G015A
<b>Status of EUT</b>	Identical Prototype
<b>Power Supply Rating</b>	5.0 Vdc (adapter or host equipment) 3.8 Vdc (Li-ion battery)
<b>Modulation Type</b>	CCK, DQPSK, DBPSK for DSSS 64QAM, 16QAM, QPSK, BPSK for OFDM
<b>Modulation Technology</b>	DSSS, OFDM
<b>Transfer Rate</b>	802.11b: 11.0 / 5.5 / 2.0 / 1.0 Mbps 802.11g: 54.0 / 48.0 / 36.0 / 24.0 / 18.0 / 12.0 / 9.0 / 6.0 Mbps 802.11n: up to MCS7
<b>Operating Frequency</b>	2412 ~ 2462 MHz
<b>Number of Channel</b>	11 for 802.11b, 802.11g, 802.11n (HT20) 7 for 802.11n (HT40)
<b>Output Power</b>	319.89 mW
<b>Antenna Type</b>	Loop antenna with 0.65 dBi gain
<b>Antenna Connector</b>	N/A
<b>Accessory Device</b>	Refer to Note as below
<b>Data Cable Supplied</b>	Refer to Note as below

Note:

- The EUT provides 1 completed transmitter and 1 receiver.

Modulation Mode	Tx Function
802.11b	1TX
802.11g	1TX
802.11n (HT20)	1TX
802.11n (HT40)	1TX

- The EUT contains following accessory devices.

Product	Brand	Model	Description
USB Cable	FOXCONN	SD0EY3AD000	0.93 m shielded cable w/o core
Clip	N/A	N/A	--

- The above EUT information is declared by manufacturer and for more detailed features description, please refer to the manufacturer's specifications or user's manual.

### 3.2 Description of Test Modes

11 channels are provided for 802.11b, 802.11g and 802.11n (HT20):

Channel	Frequency (MHz)	Channel	Frequency (MHz)
1	2412	7	2442
2	2417	8	2447
3	2422	9	2452
4	2427	10	2457
5	2432	11	2462
6	2437		

7 channels are provided for 802.11n (HT40):

Channel	Frequency (MHz)	Channel	Frequency (MHz)
3	2422	7	2442
4	2427	8	2447
5	2432	9	2452
6	2437		



### 3.2.1 Test Mode Applicability and Tested Channel Detail

EUT Configure Mode	Applicable To				Description
	RE $\geq$ 1G	RE<1G	PLC	APCM	
-	√	√	√	√	-

Where **RE $\geq$ 1G**: Radiated Emission above 1 GHz      **RE<1G**: Radiated Emission below 1 GHz  
**PLC**: Power Line Conducted Emission      **APCM**: Antenna Port Conducted Measurement

**NOTE:** The EUT had been pre-tested on the positioned of each 3 axis. The worst case was found when positioned on **Z-plane**.

Pre-test Mode	Test Condition
A	EUT + USB Cable + Adapter
B	EUT + USB Cable + Notebook

\* For Radiated Emission and Power Link Conducted Emission tests, the EUT has been verified on above test modes. The pre-test result of Mode A was worse. Therefore, only Mode A was chosen for final test and recorded in this report.

#### **Radiated Emission Test (Above 1 GHz):**

- Pre-Scan has been conducted to determine the worst-case mode from all possible combinations between available modulations, data rates and antenna ports (if EUT with antenna diversity architecture).
- Following channel(s) was (were) selected for the final test as listed below.

EUT Configure Mode	Mode	Available Channel	Tested Channel	Modulation Technology	Modulation Type	Data Rate (Mbps)
-	802.11b	1 to 11	1, 6, 11	DSSS	DBPSK	1.0
-	802.11g	1 to 11	1, 6, 11	OFDM	BPSK	6.0
-	802.11n (HT20)	1 to 11	1, 6, 11	OFDM	BPSK	MCS0
-	802.11n (HT40)	3 to 9	3, 6, 9	OFDM	BPSK	MCS0

#### **Radiated Emission Test (Below 1 GHz):**

- Pre-Scan has been conducted to determine the worst-case mode from all possible combinations between available modulations, data rates and antenna ports (if EUT with antenna diversity architecture).
- Following channel(s) was (were) selected for the final test as listed below.

EUT Configure Mode	Mode	Available Channel	Tested Channel	Modulation Technology	Modulation Type	Data Rate (Mbps)
-	802.11n (HT40)	3 to 9	3	OFDM	BPSK	MCS0

#### **Power Line Conducted Emission Test:**

- Pre-Scan has been conducted to determine the worst-case mode from all possible combinations between available modulations, data rates and antenna ports (if EUT with antenna diversity architecture).
- Following channel(s) was (were) selected for the final test as listed below.

EUT Configure Mode	Mode	Available Channel	Tested Channel	Modulation Technology	Modulation Type	Data Rate (Mbps)
-	802.11n (HT40)	3 to 9	3	OFDM	BPSK	MCS0

### Bandedge Measurement:

- Pre-Scan has been conducted to determine the worst-case mode from all possible combinations between available modulations, data rates and antenna ports (if EUT with antenna diversity architecture).
- Following channel(s) was (were) selected for the final test as listed below.

EUT Configure Mode	Mode	Available Channel	Tested Channel	Modulation Technology	Modulation Type	Data Rate (Mbps)
-	802.11b	1 to 11	1, 11	DSSS	DBPSK	1.0
-	802.11g	1 to 11	1, 11	OFDM	BPSK	6.0
-	802.11n (HT20)	1 to 11	1, 11	OFDM	BPSK	MCS0
-	802.11n (HT40)	3 to 9	3, 9	OFDM	BPSK	MCS0

### Antenna Port Conducted Measurement:

- This item includes all test value of each mode, but only includes spectrum plot of worst value of each mode.
- Pre-Scan has been conducted to determine the worst-case mode from all possible combinations between available modulations, data rates and antenna ports (if EUT with antenna diversity architecture).
- Following channel(s) was (were) selected for the final test as listed below.

EUT Configure Mode	Mode	Available Channel	Tested Channel	Modulation Technology	Modulation Type	Data Rate (Mbps)
-	802.11b	1 to 11	1, 6, 11	DSSS	DBPSK	1.0
-	802.11g	1 to 11	1, 6, 11	OFDM	BPSK	6.0
-	802.11n (HT20)	1 to 11	1, 6, 11	OFDM	BPSK	MCS0
-	802.11n (HT40)	3 to 9	3, 6, 9	OFDM	BPSK	MCS0

### Test Condition:

Applicable To	Environmental Conditions	Input Power	Tested by
RE $\geq$ 1G	25 deg. C, 65 % RH	120 Vac, 60 Hz	Gavin Wu
RE $<$ 1G	25 deg. C, 65 % RH	120 Vac, 60 Hz	Gavin Wu
PLC	25 deg. C, 65 % RH	120 Vac, 60 Hz	Han Wu
APCM	25 deg. C, 65 % RH	3.8 Vdc	Anson Lin

### 3.3 Duty Cycle of Test Signal

**802.11b:** Duty cycle =  $4.294/9.183 = 0.468$ , Duty factor =  $10 * \log(1/0.468) = 3.30$

**802.11g:** Duty cycle =  $4.797/11.214 = 0.428$ , Duty factor =  $10 * \log(1/0.428) = 3.69$

**802.11n (HT20):** Duty cycle =  $3.09/7.67 = 0.403$ , Duty factor =  $10 * \log(1/0.403) = 3.95$

**802.11n (HT40):** Duty cycle =  $2.30/11.30 = 0.204$ , Duty factor =  $10 * \log(1/0.204) = 6.91$

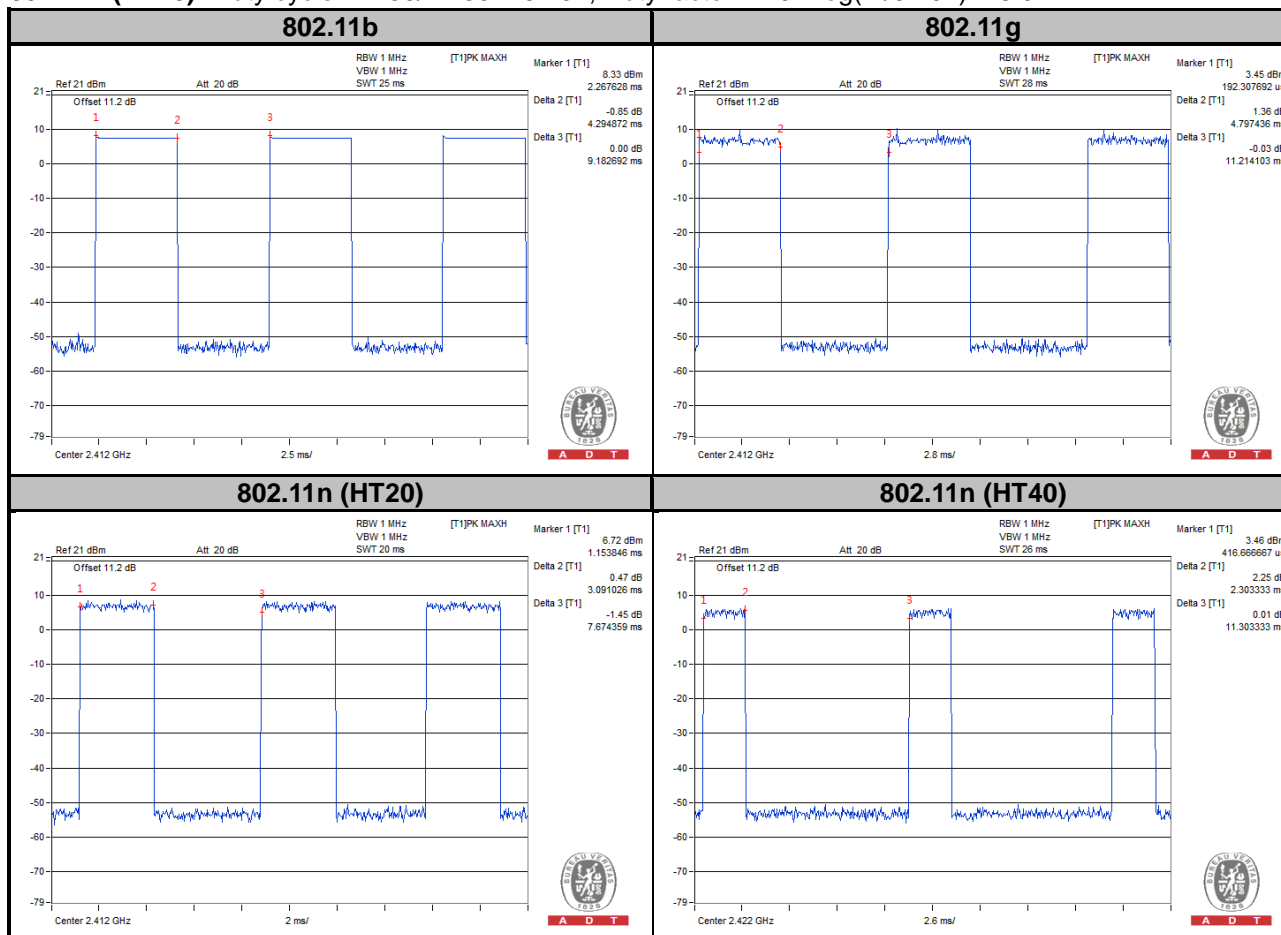

### 3.4 Description of Support Units

The EUT has been tested as an independent unit together with other necessary accessories or support units. The following support units or accessories were used to form a representative test configuration during the tests.

No.	Product	Brand	Model No.	Serial No.	FCC ID
1.	Adapter	N/A	N/A	N/A	N/A

No.	Signal Cable Description Of The Above Support Units
1.	N/A

Note:

1. All power cords of the above support units are non-shielded (1.8m).

#### 3.4.1 Configuration of System under Test

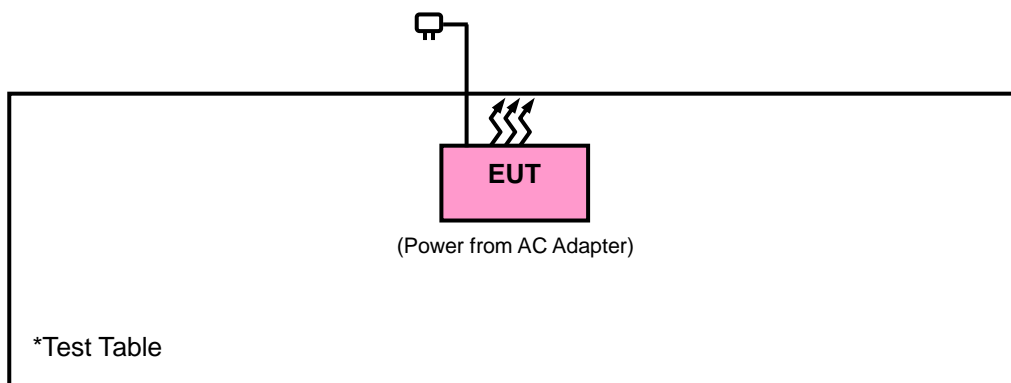

### 3.5 General Description of Applied Standards

The EUT is a RF Product. According to the specifications of the manufacturer, it must comply with the requirements of the following standards:

**FCC Part 15, Subpart C (15.247)**

**558074 D01 DTS Meas Guidance v04**

**662911 D01 Multiple Transmitter Output v02r01**

ANSI C63.10-2013

All test items have been performed and recorded as per the above standards.

**NOTE:** The EUT has been verified to comply with the requirements of FCC Part 15, Subpart B, Class B (DoC). The test report has been issued separately.

## 4 Test Types and Results

### 4.1 Radiated Emission and Bandedge Measurement

#### 4.1.1 Limits of Radiated Emission and Bandedge Measurement

Radiated emissions which fall in the restricted bands must comply with the radiated emission limits specified as below table. Other emissions shall be at least 20 dB below the highest level of the desired power:

Frequencies (MHz)	Field Strength (microvolts/meter)	Measurement Distance (meters)
0.009 ~ 0.490	2400/F (kHz)	300
0.490 ~ 1.705	24000/F (kHz)	30
1.705 ~ 30.0	30	30
30 ~ 88	100	3
88 ~ 216	150	3
216 ~ 960	200	3
Above 960	500	3

**NOTE:**

1. The lower limit shall apply at the transition frequencies.
2. Emission level (dBuV/m) = 20 log Emission level (uV/m).
3. For frequencies above 1000 MHz, the field strength limits are based on average detector, however, the peak field strength of any emission shall not exceed the maximum permitted average limits, specified above by more than 20 dB under any condition of modulation.

#### 4.1.2 Test Instruments

Description & Manufacturer	Model No.	Serial No.	Date of Calibration	Due Date of Calibration
Test Receiver Agilent	N9038A	MY51210203	Feb. 17, 2017	Feb. 16, 2018
Spectrum Analyzer Agilent	N9010A	MY52220314	Dec. 16, 2016	Dec. 15, 2017
Spectrum Analyzer ROHDE & SCHWARZ	FSU43	101261	Dec. 13, 2016	Dec. 12, 2017
BILOG Antenna SCHWARZBECK	VULB9168	9168-472	Dec. 26, 2016	Dec. 27, 2017
HORN Antenna SCHWARZBECK	BBHA 9120 D	9120D-969	Dec. 12, 2016	Dec. 13, 2017
HORN Antenna SCHWARZBECK	BBHA 9170	9170-480	Dec. 14, 2016	Dec. 13, 2017
Fixed Attenuator Mini-Circuits	MDCS18N-10	MDCS18N-10-01	Apr. 17, 2017	Apr. 16, 2018
Loop Antenna	HLA 6121	45745	May 19, 2017	May 18, 2018
Preamplifier EMCI	EMC001340	980201	Nov. 02, 2016	Nov. 01, 2017
Preamplifier EMCI	EMC 012645	980115	Oct. 21, 2016	Oct. 20, 2017
Preamplifier EMCI	EMC 184045	980116	Oct. 21, 2016	Oct. 20, 2017
Preamplifier EMCI	EMC 330H	980112	Oct. 21, 2016	Oct. 20, 2017
Power Meter Anritsu	ML2495A	1232002	Sep. 08, 2016	Sep. 07, 2017
Power Sensor Anritsu	MA2411B	1207325	Sep. 08, 2016	Sep. 07, 2017
RF signal cable HUBER+SUHNNER	SUCOFLEX 104	309219/4 2950114	Oct. 21, 2016	Oct. 20, 2017
RF signal cable HUBER+SUHNNER	SUCOFLEX 104	250130/4	Oct. 21, 2016	Oct. 20, 2017
RF Coaxial Cable Worken	8D-FB	Cable-Ch10-01	Oct. 21, 2016	Oct. 20, 2017
Software BV ADT	E3 6.120103	NA	NA	NA
Antenna Tower MF	MFA-440H	NA	NA	NA
Turn Table MF	MFT-201SS	NA	NA	NA
Antenna Tower & Turn Table Controller MF	MF-7802	NA	NA	NA

- Note: 1. The calibration interval of the above test instruments is 12 months and the calibrations are traceable to NML/ROC and NIST/USA.
2. The test was performed in HwaYa Chamber 10.
3. The horn antenna and preamplifier (model: EMC 184045) are used only for the measurement of emission frequency above 1 GHz if tested.
4. The FCC Designation Number is TW0003. The number will be varied with the Lab location and scope as attached.
5. The IC Site Registration No. is IC7450F-10.

#### 4.1.3 Test Procedures

- a. The EUT was placed on the top of a rotating table 0.8 meters (for below 1 GHz) / 1.5 meters (for above 1 GHz) above the ground at 3 meter chamber room for test. The table was rotated 360 degrees to determine the position of the highest radiation.
- b. The EUT was set 3 meters away from the interference-receiving antenna, which was mounted on the top of a variable-height antenna tower.
- c. The height of antenna is varied from one meter to four meters above the ground to determine the maximum value of the field strength. Both horizontal and vertical polarizations of the antenna are set to make the measurement.
- d. For each suspected emission, the EUT was arranged to its worst case and then the antenna was tuned to heights from 1 meter to 4 meters and the rotatable table was turned from 0 degrees to 360 degrees to find the maximum reading.
- e. The test-receiver system was set to quasi-peak detect function and specified bandwidth with maximum hold mode when the test frequency is below 1 GHz.
- f. The test-receiver system was set to peak and average detected function and specified bandwidth with maximum hold mode when the test frequency is above 1 GHz. If the peak reading value also meets average limit, measurement with the average detector is unnecessary.

**Note:**

1. The resolution bandwidth and video bandwidth of test receiver/spectrum analyzer is 120 kHz & 360 KHz for Quasi-peak detection (QP) at frequency below 1 GHz.
2. The resolution bandwidth of test receiver/spectrum analyzer is 1 MHz and the video bandwidth is 3 MHz for Peak detection (PK) at frequency above 1 GHz.
3. The resolution bandwidth of test receiver/spectrum analyzer is 1 MHz and the video bandwidth is 1/T for Average (Duty cycle < 98 %) detection at frequency above 1 GHz.
4. The resolution bandwidth of test receiver/spectrum analyzer is 1 MHz and the video bandwidth is 10 Hz (Duty cycle ≥ 98 %) for Average detection (AV) at frequency above 1 GHz.
5. All modes of operation were investigated and the worst-case emissions are reported.

Test Setting	
Bandedge Emissions	RBW / VBW
(Non-restricted Band)	100kHz / 300kHz
(Restricted Band)	Average: 1MHz / 1kHz Peak: 1MHz / 3MHz

#### 4.1.4 Deviation from Test Standard

No deviation.

#### 4.1.5 Test Set Up

##### <Frequency Range below 1 GHz>

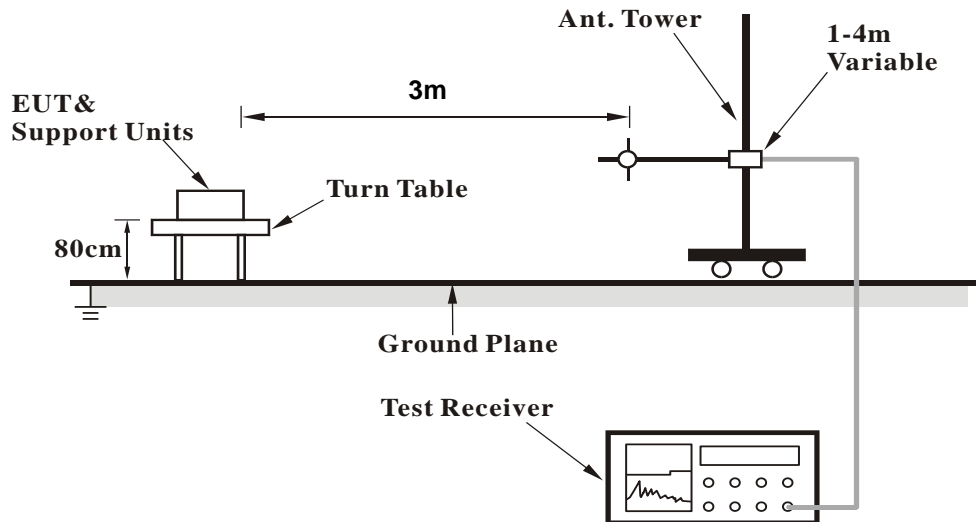

##### <Frequency Range above 1 GHz>

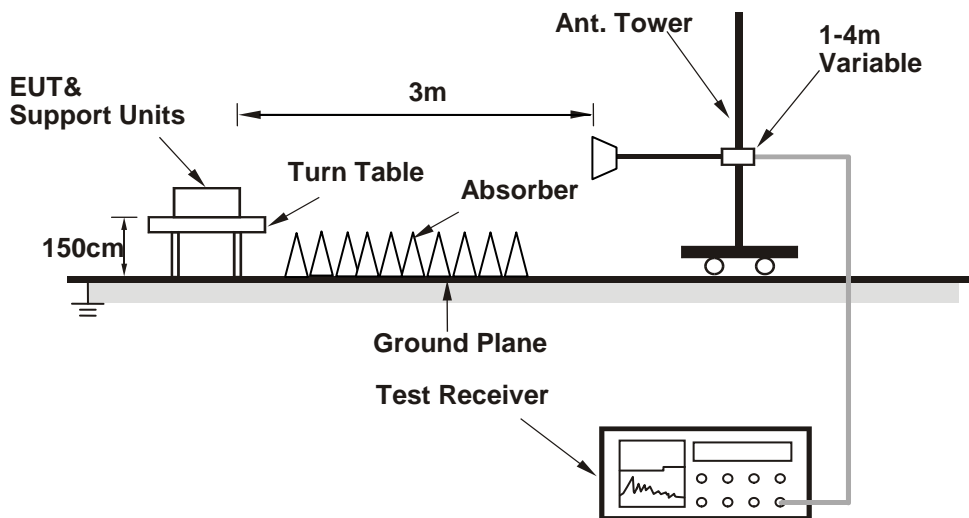

For the actual test configuration, please refer to the attached file (Test Setup Photo).

#### 4.1.6 EUT Operating Conditions

- Placed the EUT on a testing table.
- Use the software to control the EUT under transmission condition continuously at specific channel frequency.



4.1.7 Test Results

Above 1 GHz Data :

802.11b

EUT Test Condition		Measurement Detail	
Channel	Channel 1	Frequency Range	1 GHz ~ 25 GHz
Input Power	120 Vac, 60 Hz	Detector Function	Peak (PK) Average (AV)
Environmental Conditions	25 deg. C, 65 % RH	Tested By	Gavin Wu

Horizontal

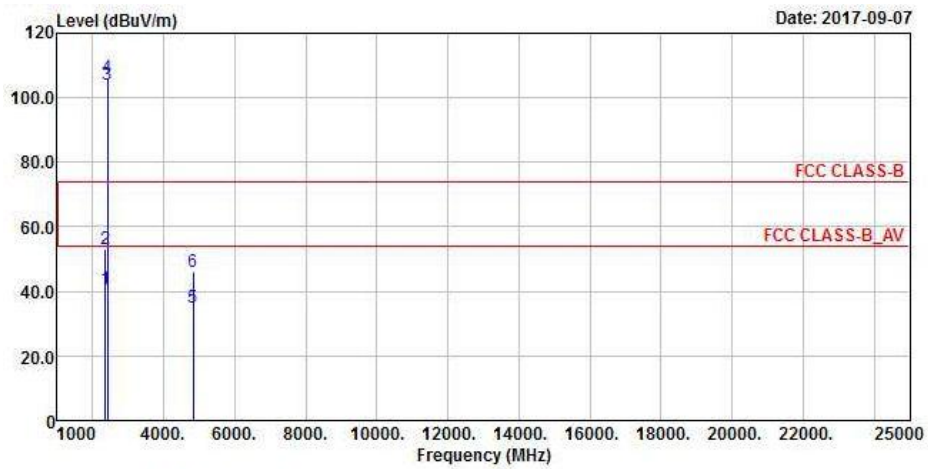

Vertical

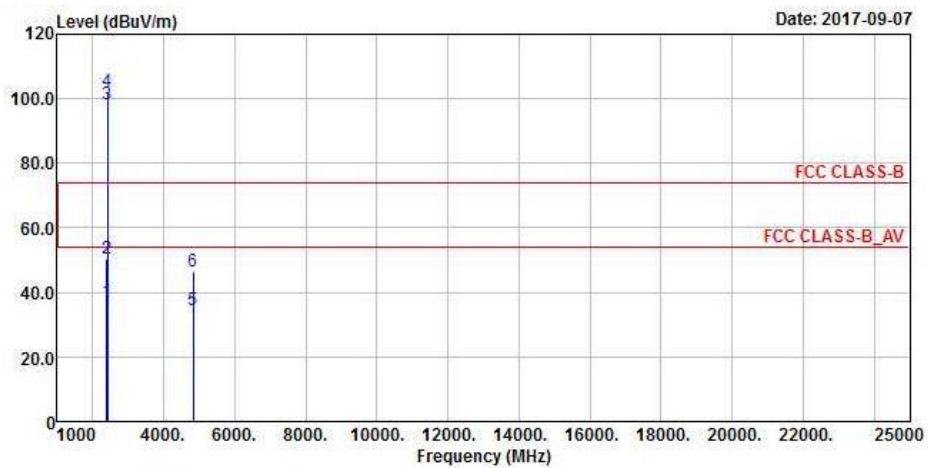

Antennal Polarity & Test Distance: Horizontal at 3 m										
Frequency (MHz)	Emission Level (dBuV/m)	Read Level (dBuV)	Limit (dBuV/m)	Margin (dB)	Antenna Factor (dB/m)	Cable Loss (dB)	Preamp Factor (dB)	Antenna Height (cm)	Table Angle (Degree)	Remark
2356	40.94	47.57	54	-13.06	26.81	4.05	37.49	224	164	Average
2356	53.27	59.9	74	-20.73	26.81	4.05	37.49	224	164	Peak
2412	104.21	110.68			26.96	4.09	37.52	224	164	Average
2412	106.45	112.92			26.96	4.09	37.52	224	164	Peak
4824	35.18	50.48	54	-18.82	30.99	6.79	53.08	155	138	Average
4824	46.06	61.36	74	-27.94	30.99	6.79	53.08	155	138	Peak
Antennal Polarity & Test Distance: Vertical at 3 m										
Frequency (MHz)	Emission Level (dBuV/m)	Read Level (dBuV)	Limit (dBuV/m)	Margin (dB)	Antenna Factor (dB/m)	Cable Loss (dB)	Preamp Factor (dB)	Antenna Height (cm)	Table Angle (Degree)	Remark
2386	37.31	43.82	54	-16.69	26.91	4.08	37.5	300	215	Average
2386	50.66	57.17	74	-23.34	26.91	4.08	37.5	300	215	Peak
2412	98.21	104.68			26.96	4.09	37.52	300	215	Average
2412	102.26	108.73			26.96	4.09	37.52	300	215	Peak
4824	34.58	49.88	54	-19.42	30.99	6.79	53.08	107	131	Average
4824	46.55	61.85	74	-27.45	30.99	6.79	53.08	107	131	Peak

Remarks:

- Emission Level = Read Level + Antenna Factor + Cable Loss - Preamp Factor  
Margin value = Emission level – Limit value
- 2412 MHz: Fundamental frequency.

EUT Test Condition		Measurement Detail	
Channel	Channel 6	Frequency Range	1 GHz ~ 25 GHz
Input Power	120 Vac, 60 Hz	Detector Function	Peak (PK) Average (AV)
Environmental Conditions	25 deg. C, 65 % RH	Tested By	Gavin Wu

### Horizontal

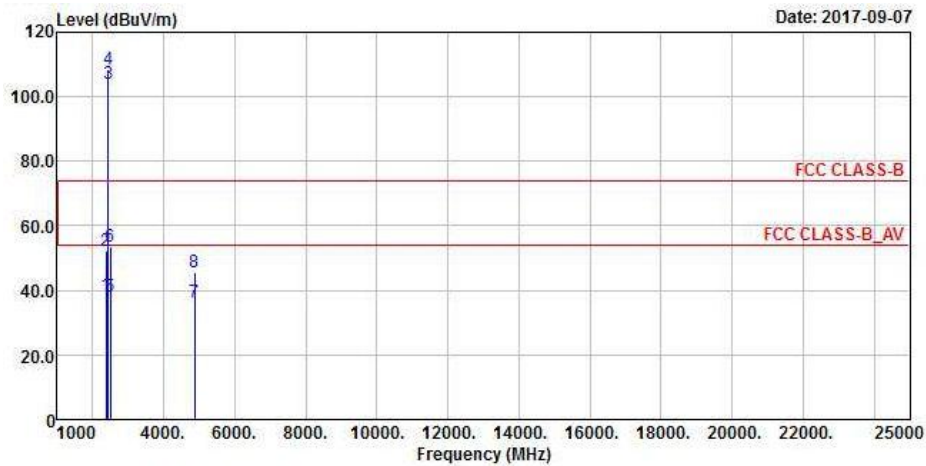

### Vertical

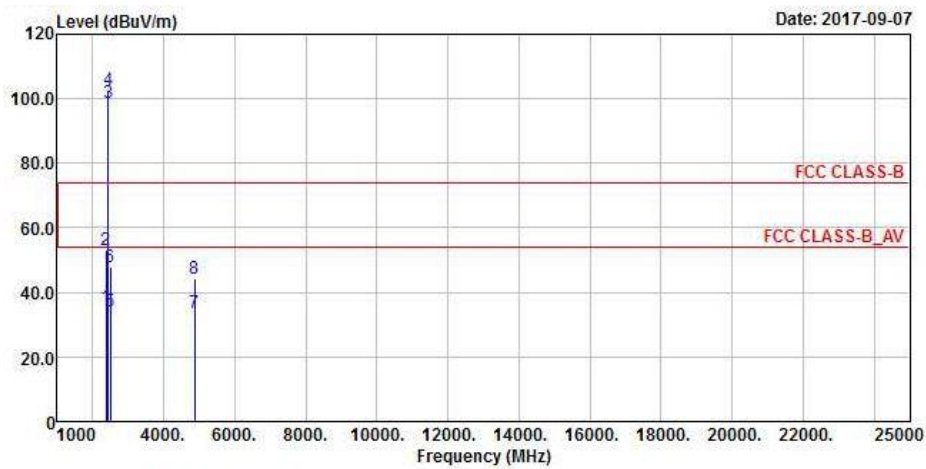

**Antennal Polarity & Test Distance: Horizontal at 3 m**

Frequency (MHz)	Emission Level (dBuV/m)	Read Level (dBuV)	Limit (dBuV/m)	Margin (dB)	Antenna Factor (dB/m)	Cable Loss (dB)	Preamp Factor (dB)	Antenna Height (cm)	Table Angle (Degree)	Remark
2373	38.36	44.93	54	-15.64	26.86	4.07	37.5	200	168	Average
2373	52.44	59.01	74	-21.56	26.86	4.07	37.5	200	168	Peak
2437	103.86	110.14			27.06	4.12	37.46	200	168	Average
2437	108.62	114.9			27.06	4.12	37.46	200	168	Peak
2487	37.95	43.97	54	-16.05	27.15	4.15	37.32	200	168	Average
2487	53.49	59.51	74	-20.51	27.15	4.15	37.32	200	168	Peak
4874	36.49	51.63	54	-17.51	31.06	6.85	53.05	101	165	Average
4874	45.62	60.76	74	-28.38	31.06	6.85	53.05	101	165	Peak

**Antennal Polarity & Test Distance: Vertical at 3 m**

Frequency (MHz)	Emission Level (dBuV/m)	Read Level (dBuV)	Limit (dBuV/m)	Margin (dB)	Antenna Factor (dB/m)	Cable Loss (dB)	Preamp Factor (dB)	Antenna Height (cm)	Table Angle (Degree)	Remark
2371	35.25	41.82	54	-18.75	26.86	4.07	37.5	301	254	Average
2371	53	59.57	74	-21	26.86	4.07	37.5	301	254	Peak
2437	98.88	105.16			27.06	4.12	37.46	301	254	Average
2437	102.66	108.94			27.06	4.12	37.46	301	254	Peak
2488	34.17	40.13	54	-19.83	27.2	4.16	37.32	301	254	Average
2488	47.78	53.74	74	-26.22	27.2	4.16	37.32	301	254	Peak
4874	33.71	48.85	54	-20.29	31.06	6.85	53.05	113	162	Average
4874	44.31	59.45	74	-29.69	31.06	6.85	53.05	113	162	Peak

Remarks:

- Emission Level = Read Level + Antenna Factor + Cable Loss - Preamp Factor  
Margin value = Emission level – Limit value
- 2437 MHz: Fundamental frequency.

EUT Test Condition		Measurement Detail	
Channel	Channel 11	Frequency Range	1 GHz ~ 25 GHz
Input Power	120 Vac, 60 Hz	Detector Function	Peak (PK) Average (AV)
Environmental Conditions	25 deg. C, 65 % RH	Tested By	Gavin Wu

### Horizontal

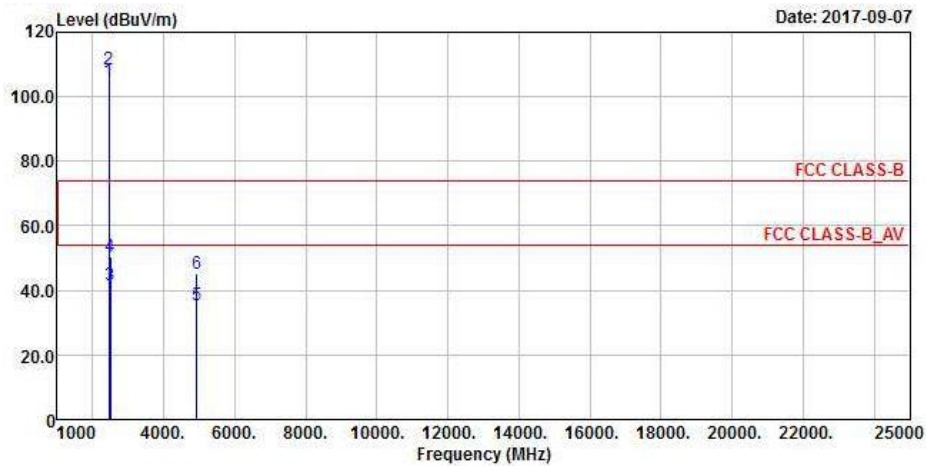

### Vertical

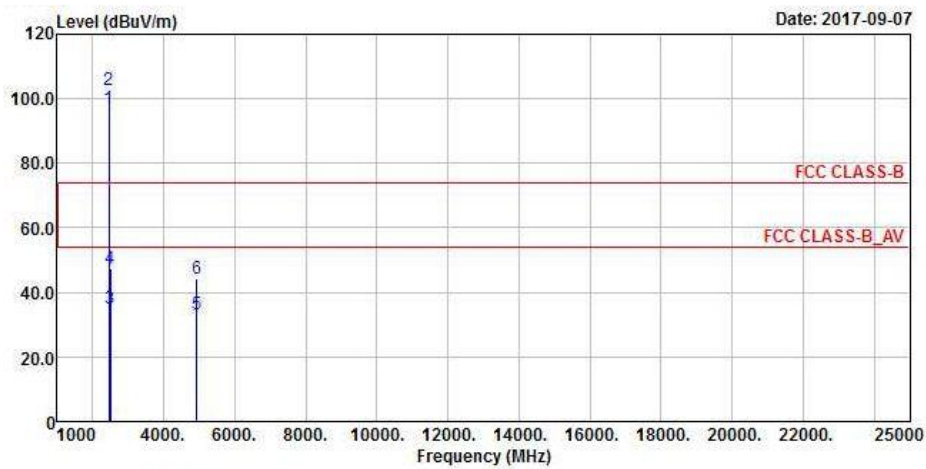

**Antennal Polarity & Test Distance: Horizontal at 3 m**

Frequency (MHz)	Emission Level (dBuV/m)	Read Level (dBuV)	Limit (dBuV/m)	Margin (dB)	Antenna Factor (dB/m)	Cable Loss (dB)	Preamp Factor (dB)	Antenna Height (cm)	Table Angle (Degree)	Remark
2462	105.06	111.22			27.1	4.13	37.39	198	133	Average
2462	108.56	114.72			27.1	4.13	37.39	198	133	Peak
2488	41.69	47.65	54	-12.31	27.2	4.16	37.32	198	133	Average
2488	50.35	56.31	74	-23.65	27.2	4.16	37.32	198	133	Peak
4924	35.43	50.46	54	-18.57	31.12	6.88	53.03	115	122	Average
4924	45.09	60.12	74	-28.91	31.12	6.88	53.03	115	122	Peak

**Antennal Polarity & Test Distance: Vertical at 3 m**

Frequency (MHz)	Emission Level (dBuV/m)	Read Level (dBuV)	Limit (dBuV/m)	Margin (dB)	Antenna Factor (dB/m)	Cable Loss (dB)	Preamp Factor (dB)	Antenna Height (cm)	Table Angle (Degree)	Remark
2462	97.11	103.27			27.1	4.13	37.39	300	298	Average
2462	102.59	108.75			27.1	4.13	37.39	300	298	Peak
2498	35.09	40.98	54	-18.91	27.2	4.16	37.25	300	298	Average
2498	47.41	53.3	74	-26.59	27.2	4.16	37.25	300	298	Peak
4924	33.3	48.33	54	-20.7	31.12	6.88	53.03	107	122	Average
4924	44.22	59.25	74	-29.78	31.12	6.88	53.03	107	122	Peak

Remarks:

1. Emission Level = Read Level + Antenna Factor + Cable Loss - Preamp Factor

Margin value = Emission level – Limit value

2. 2462 MHz: Fundamental frequency.

802.11g

EUT Test Condition		Measurement Detail	
Channel	Channel 1	Frequency Range	1 GHz ~ 25 GHz
Input Power	120 Vac, 60 Hz	Detector Function	Peak (PK) Average (AV)
Environmental Conditions	25 deg. C, 65 % RH	Tested By	Gavin Wu

Horizontal

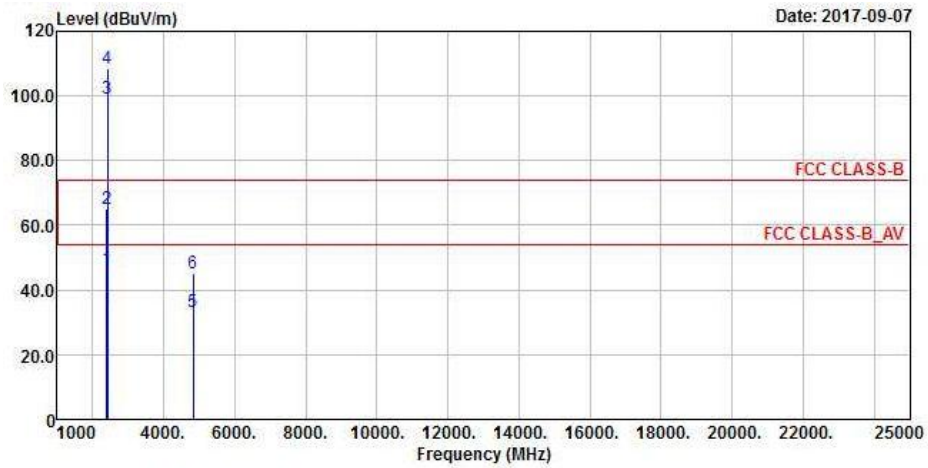

Vertical

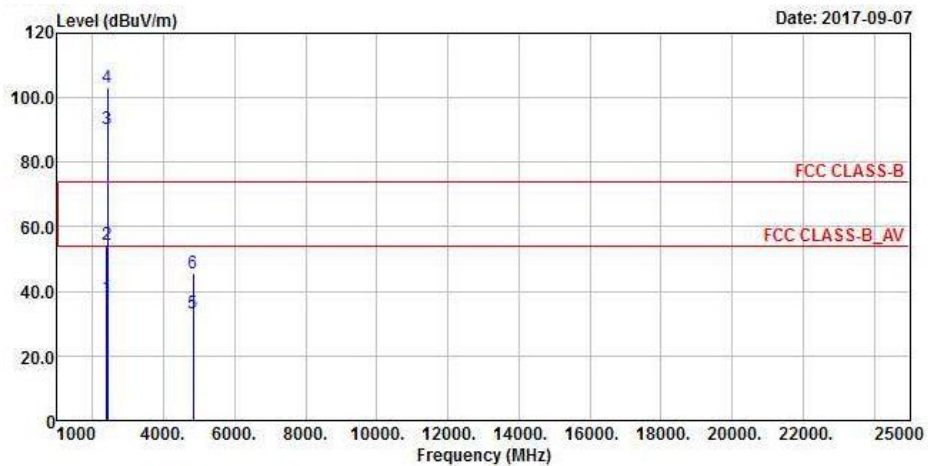

**Antennal Polarity & Test Distance: Horizontal at 3 m**

Frequency (MHz)	Emission Level (dBuV/m)	Read Level (dBuV)	Limit (dBuV/m)	Margin (dB)	Antenna Factor (dB/m)	Cable Loss (dB)	Preamp Factor (dB)	Antenna Height (cm)	Table Angle (Degree)	Remark
2388	46.3	52.81	54	-7.7	26.91	4.08	37.5	200	176	Average
2388	64.98	71.49	74	-9.02	26.91	4.08	37.5	200	176	Peak
2412	99.21	105.68			26.96	4.09	37.52	200	176	Average
2412	108.63	115.1			26.96	4.09	37.52	200	176	Peak
4824	33.05	48.35	54	-20.95	30.99	6.79	53.08	118	109	Average
4824	45.1	60.4	74	-28.9	30.99	6.79	53.08	118	109	Peak

**Antennal Polarity & Test Distance: Vertical at 3 m**

Frequency (MHz)	Emission Level (dBuV/m)	Read Level (dBuV)	Limit (dBuV/m)	Margin (dB)	Antenna Factor (dB/m)	Cable Loss (dB)	Preamp Factor (dB)	Antenna Height (cm)	Table Angle (Degree)	Remark
2390	38.19	44.72	54	-15.81	26.91	4.08	37.52	219	46	Average
2390	54.38	60.91	74	-19.62	26.91	4.08	37.52	219	46	Peak
2412	90.48	96.95			26.96	4.09	37.52	219	46	Average
2412	103.18	109.65			26.96	4.09	37.52	219	46	Peak
4824	33.12	48.42	54	-20.88	30.99	6.79	53.08	110	149	Average
4824	45.75	61.05	74	-28.25	30.99	6.79	53.08	110	149	Peak

Remarks:

- Emission Level = Read Level + Antenna Factor + Cable Loss - Preamp Factor  
Margin value = Emission level – Limit value
- 2412 MHz: Fundamental frequency.



EUT Test Condition		Measurement Detail	
Channel	Channel 6	Frequency Range	1 GHz ~ 25 GHz
Input Power	120 Vac, 60 Hz	Detector Function	Peak (PK) Average (AV)
Environmental Conditions	25 deg. C, 65 % RH	Tested By	Gavin Wu

### Horizontal

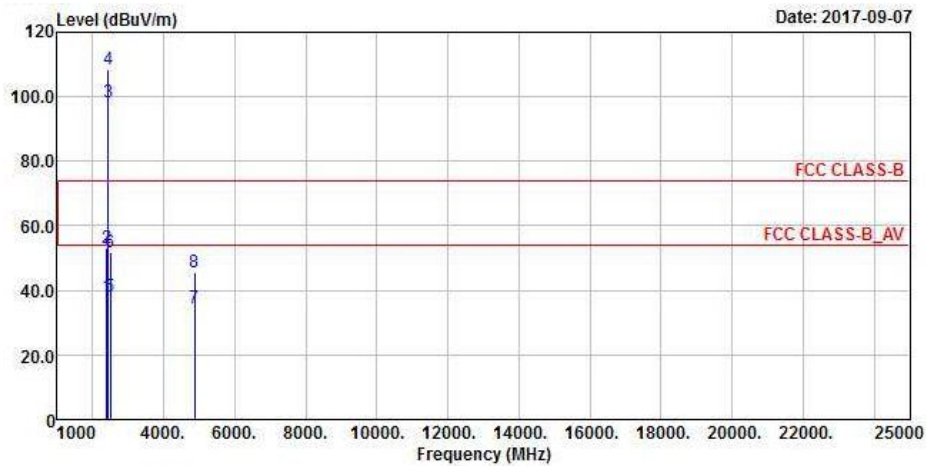

### Vertical

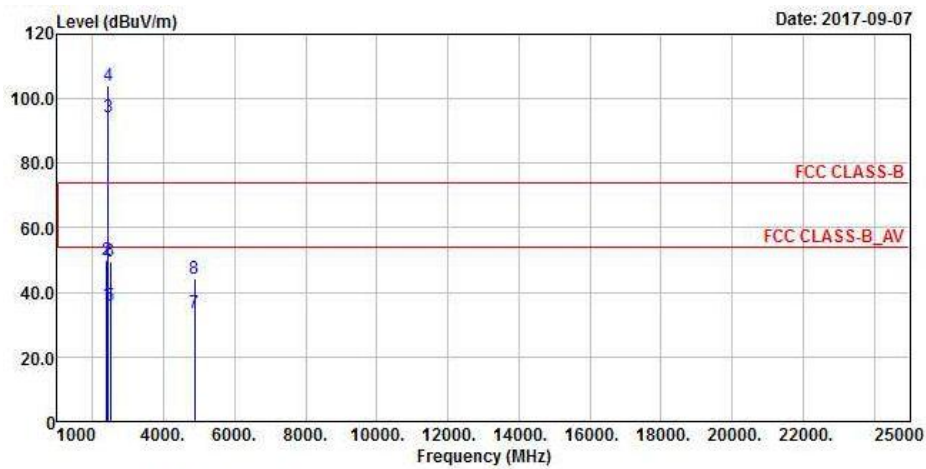

**Antennal Polarity & Test Distance: Horizontal at 3 m**

Frequency (MHz)	Emission Level (dBUV/m)	Read Level (dBUV)	Limit (dBUV/m)	Margin (dB)	Antenna Factor (dB/m)	Cable Loss (dB)	Preamp Factor (dB)	Antenna Height (cm)	Table Angle (Degree)	Remark
2387	38.05	44.56	54	-15.95	26.91	4.08	37.5	199	149	Average
2387	53.04	59.55	74	-20.96	26.91	4.08	37.5	199	149	Peak
2437	98.28	104.56			27.06	4.12	37.46	199	149	Average
2437	108.49	114.77			27.06	4.12	37.46	199	149	Peak
2493	37.93	43.82	54	-16.07	27.2	4.16	37.25	199	149	Average
2493	51.76	57.65	74	-22.24	27.2	4.16	37.25	199	149	Peak
4874	34.39	49.53	54	-19.61	31.06	6.85	53.05	117	180	Average
4874	45.51	60.65	74	-28.49	31.06	6.85	53.05	117	180	Peak

**Antennal Polarity & Test Distance: Vertical at 3 m**

Frequency (MHz)	Emission Level (dBUV/m)	Read Level (dBUV)	Limit (dBUV/m)	Margin (dB)	Antenna Factor (dB/m)	Cable Loss (dB)	Preamp Factor (dB)	Antenna Height (cm)	Table Angle (Degree)	Remark
2388	36.1	42.61	54	-17.9	26.91	4.08	37.5	238	57	Average
2388	50.18	56.69	74	-23.82	26.91	4.08	37.5	238	57	Peak
2437	94.38	100.66			27.06	4.12	37.46	238	57	Average
2437	103.87	110.15			27.06	4.12	37.46	238	57	Peak
2488	36	41.96	54	-18	27.2	4.16	37.32	238	57	Average
2488	49.78	55.74	74	-24.22	27.2	4.16	37.32	238	57	Peak
4874	33.83	48.97	54	-20.17	31.06	6.85	53.05	108	133	Average
4874	44.09	59.23	74	-29.91	31.06	6.85	53.05	108	133	Peak

Remarks:

- Emission Level = Read Level + Antenna Factor + Cable Loss - Preamp Factor  
Margin value = Emission level – Limit value
- 2437 MHz: Fundamental frequency.

EUT Test Condition		Measurement Detail	
Channel	Channel 11	Frequency Range	1 GHz ~ 25 GHz
Input Power	120 Vac, 60 Hz	Detector Function	Peak (PK) Average (AV)
Environmental Conditions	25 deg. C, 65 % RH	Tested By	Gavin Wu

### Horizontal

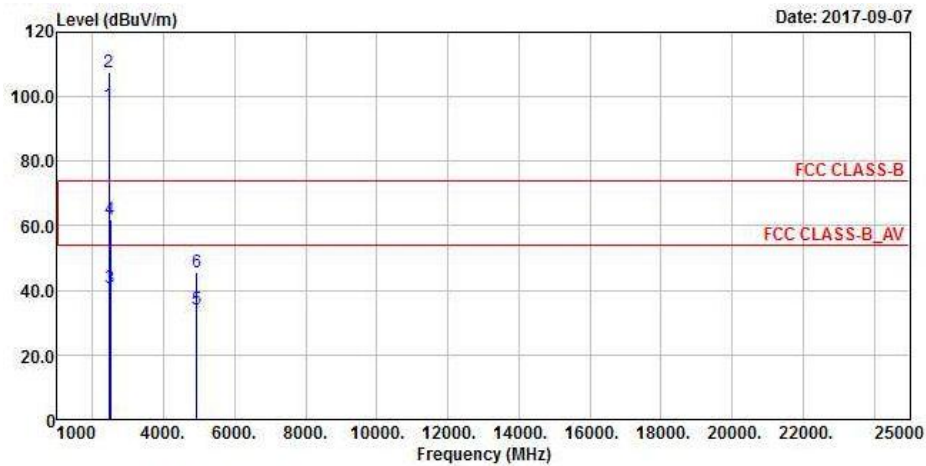

### Vertical

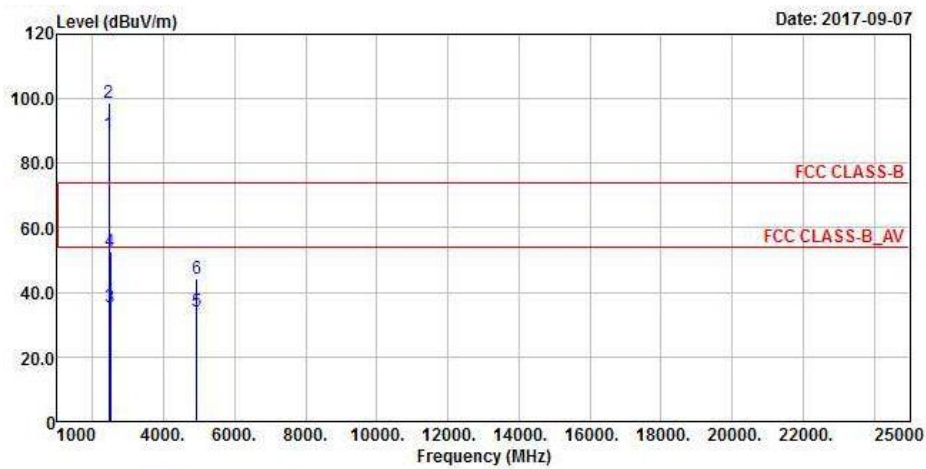

**Antennal Polarity & Test Distance: Horizontal at 3 m**

Frequency (MHz)	Emission Level (dBuV/m)	Read Level (dBuV)	Limit (dBuV/m)	Margin (dB)	Antenna Factor (dB/m)	Cable Loss (dB)	Preamp Factor (dB)	Antenna Height (cm)	Table Angle (Degree)	Remark
2462	97.36	103.52			27.1	4.13	37.39	203	158	Average
2462	107.82	113.98			27.1	4.13	37.39	203	158	Peak
2485	40.73	46.75	54	-13.27	27.15	4.15	37.32	203	158	Average
2485	61.95	67.97	74	-12.05	27.15	4.15	37.32	203	158	Peak
4924	33.96	48.99	54	-20.04	31.12	6.88	53.03	109	135	Average
4924	45.71	60.74	74	-28.29	31.12	6.88	53.03	109	135	Peak

**Antennal Polarity & Test Distance: Vertical at 3 m**

Frequency (MHz)	Emission Level (dBuV/m)	Read Level (dBuV)	Limit (dBuV/m)	Margin (dB)	Antenna Factor (dB/m)	Cable Loss (dB)	Preamp Factor (dB)	Antenna Height (cm)	Table Angle (Degree)	Remark
2462	89.12	95.28			27.1	4.13	37.39	239	69	Average
2462	98.8	104.96			27.1	4.13	37.39	239	69	Peak
2485	35.4	41.42	54	-18.6	27.15	4.15	37.32	239	69	Average
2485	52.73	58.75	74	-21.27	27.15	4.15	37.32	239	69	Peak
4924	33.96	48.99	54	-20.04	31.12	6.88	53.03	118	144	Average
4924	44.33	59.36	74	-29.67	31.12	6.88	53.03	118	144	Peak

**Remarks:**

- Emission Level = Read Level + Antenna Factor + Cable Loss - Preamp Factor  
Margin value = Emission level – Limit value
- 2462 MHz: Fundamental frequency.

802.11n (HT20)

EUT Test Condition		Measurement Detail	
Channel	Channel 1	Frequency Range	1 GHz ~ 25 GHz
Input Power	120 Vac, 60 Hz	Detector Function	Peak (PK) Average (AV)
Environmental Conditions	25 deg. C, 65 % RH	Tested By	Gavin Wu

Horizontal

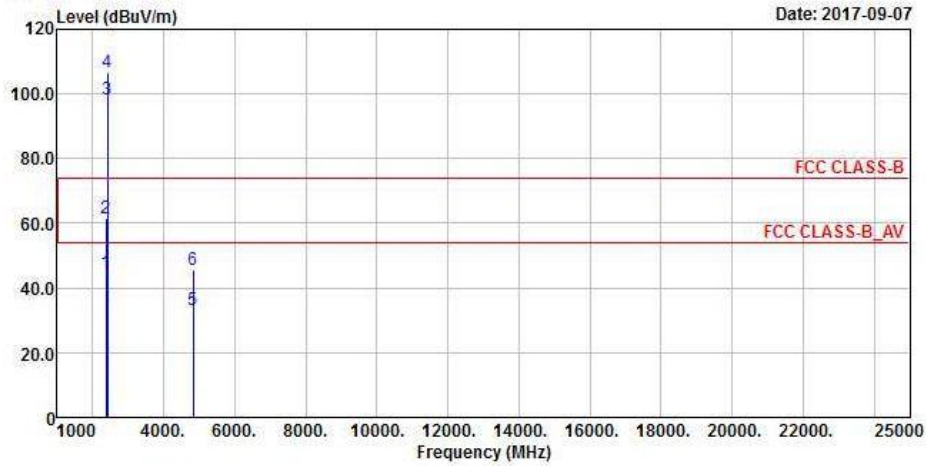

Vertical

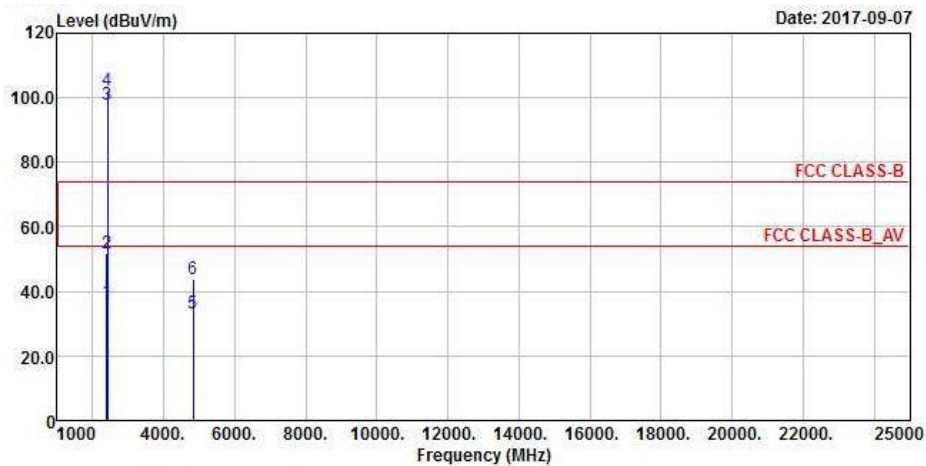

**Antennal Polarity & Test Distance: Horizontal at 3 m**

Frequency (MHz)	Emission Level (dBuV/m)	Read Level (dBuV)	Limit (dBuV/m)	Margin (dB)	Antenna Factor (dB/m)	Cable Loss (dB)	Preamp Factor (dB)	Antenna Height (cm)	Table Angle (Degree)	Remark
2375	44.74	51.31	54	-9.26	26.86	4.07	37.5	199	150	Average
2375	61.74	68.31	74	-12.26	26.86	4.07	37.5	199	150	Peak
2412	98.3	104.77			26.96	4.09	37.52	199	150	Average
2412	106.79	113.26			26.96	4.09	37.52	199	150	Peak
4824	33.12	48.42	54	-20.88	30.99	6.79	53.08	110	121	Average
4824	45.65	60.95	74	-28.35	30.99	6.79	53.08	110	121	Peak

**Antennal Polarity & Test Distance: Vertical at 3 m**

Frequency (MHz)	Emission Level (dBuV/m)	Read Level (dBuV)	Limit (dBuV/m)	Margin (dB)	Antenna Factor (dB/m)	Cable Loss (dB)	Preamp Factor (dB)	Antenna Height (cm)	Table Angle (Degree)	Remark
2387	36.69	43.2	54	-17.31	26.91	4.08	37.5	242	96	Average
2387	51.95	58.46	74	-22.05	26.91	4.08	37.5	242	96	Peak
2412	97.71	104.18			26.96	4.09	37.52	242	96	Average
2412	102.31	108.78			26.96	4.09	37.52	242	96	Peak
4824	33.12	48.42	54	-20.88	30.99	6.79	53.08	115	152	Average
4824	43.9	59.2	74	-30.1	30.99	6.79	53.08	115	152	Peak

**Remarks:**

- Emission Level = Read Level + Antenna Factor + Cable Loss - Preamp Factor  
Margin value = Emission level – Limit value
- 2412 MHz: Fundamental frequency.

EUT Test Condition		Measurement Detail	
Channel	Channel 6	Frequency Range	1 GHz ~ 25 GHz
Input Power	120 Vac, 60 Hz	Detector Function	Peak (PK) Average (AV)
Environmental Conditions	25 deg. C, 65 % RH	Tested By	Gavin Wu

### Horizontal

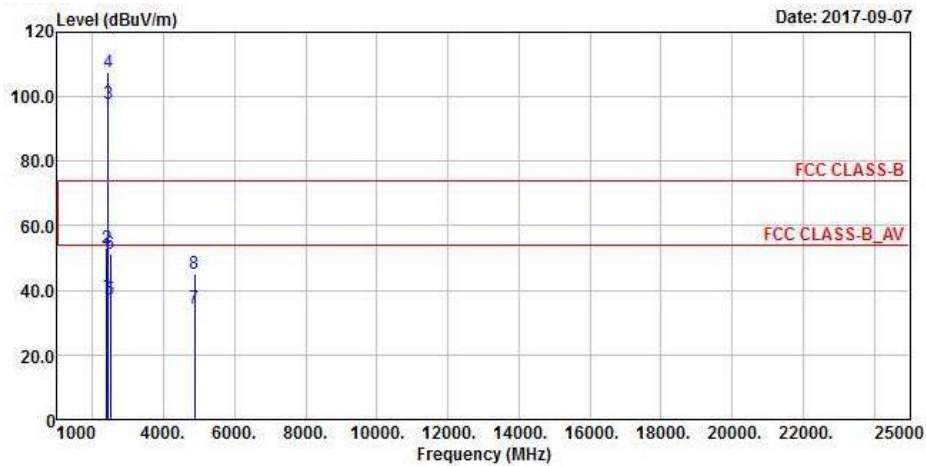

### Vertical

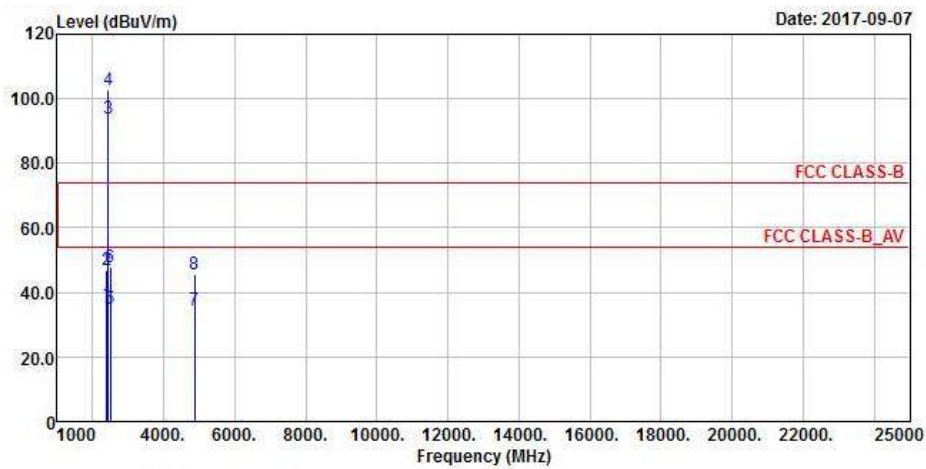

**Antennal Polarity & Test Distance: Horizontal at 3 m**

Frequency (MHz)	Emission Level (dBuV/m)	Read Level (dBuV)	Limit (dBuV/m)	Margin (dB)	Antenna Factor (dB/m)	Cable Loss (dB)	Preamp Factor (dB)	Antenna Height (cm)	Table Angle (Degree)	Remark
2390	38.32	44.85	54	-15.68	26.91	4.08	37.52	201	125	Average
2390	52.97	59.5	74	-21.03	26.91	4.08	37.52	201	125	Peak
2437	97.71	103.99			27.06	4.12	37.46	201	125	Average
2437	107.55	113.83			27.06	4.12	37.46	201	125	Peak
2486	37.31	43.33	54	-16.69	27.15	4.15	37.32	201	125	Average
2486	51.43	57.45	74	-22.57	27.15	4.15	37.32	201	125	Peak
4874	34.71	49.85	54	-19.29	31.06	6.85	53.05	102	201	Average
4874	44.97	60.11	74	-29.03	31.06	6.85	53.05	102	201	Peak

**Antennal Polarity & Test Distance: Vertical at 3 m**

Frequency (MHz)	Emission Level (dBuV/m)	Read Level (dBuV)	Limit (dBuV/m)	Margin (dB)	Antenna Factor (dB/m)	Cable Loss (dB)	Preamp Factor (dB)	Antenna Height (cm)	Table Angle (Degree)	Remark
2388	36.38	42.89	54	-17.62	26.91	4.08	37.5	200	48	Average
2388	47.01	53.52	74	-26.99	26.91	4.08	37.5	200	48	Peak
2437	93.81	100.09			27.06	4.12	37.46	200	48	Average
2437	102.8	109.08			27.06	4.12	37.46	200	48	Peak
2498	34.76	40.65	54	-19.24	27.2	4.16	37.25	200	48	Average
2498	47.84	53.73	74	-26.16	27.2	4.16	37.25	200	48	Peak
4874	34.71	49.85	54	-19.29	31.06	6.85	53.05	107	151	Average
4874	45.83	60.97	74	-28.17	31.06	6.85	53.05	107	151	Peak

Remarks:

- Emission Level = Read Level + Antenna Factor + Cable Loss - Preamp Factor  
Margin value = Emission level – Limit value
- 2437 MHz: Fundamental frequency.



EUT Test Condition		Measurement Detail	
Channel	Channel 11	Frequency Range	1 GHz ~ 25 GHz
Input Power	120 Vac, 60 Hz	Detector Function	Peak (PK) Average (AV)
Environmental Conditions	25 deg. C, 65 % RH	Tested By	Gavin Wu

### Horizontal

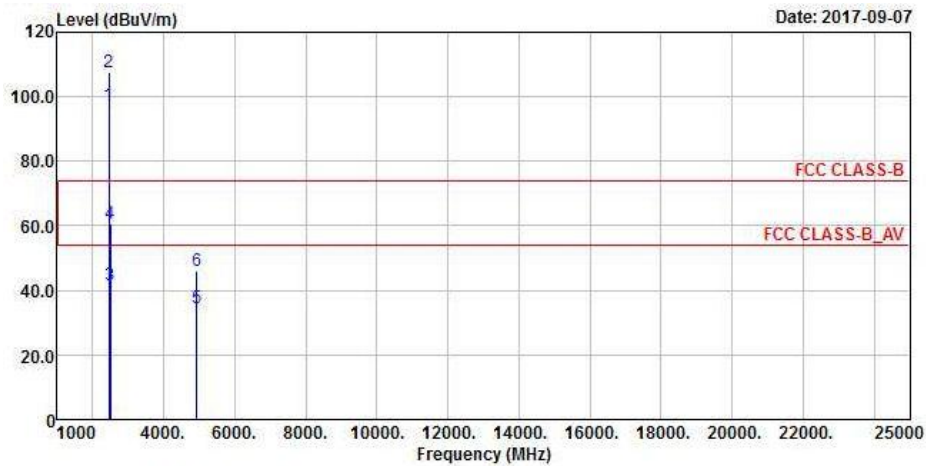

### Vertical

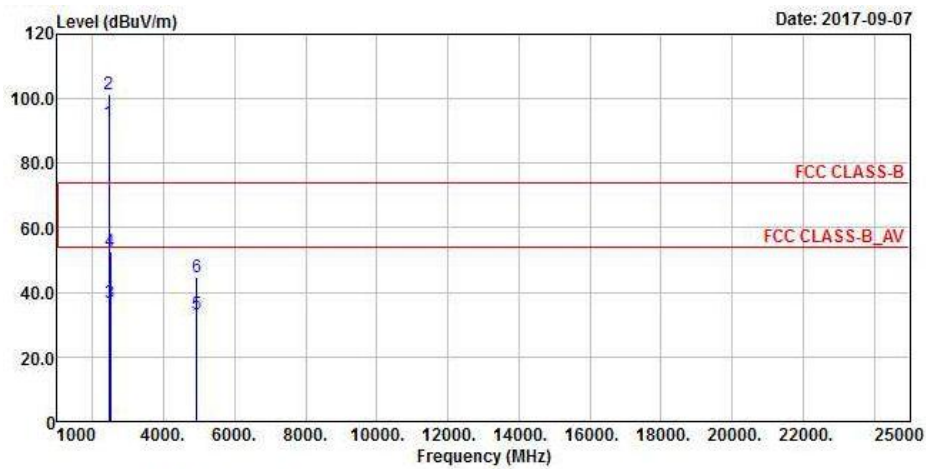

**Antennal Polarity & Test Distance: Horizontal at 3 m**

Frequency (MHz)	Emission Level (dBuV/m)	Read Level (dBuV)	Limit (dBuV/m)	Margin (dB)	Antenna Factor (dB/m)	Cable Loss (dB)	Preamp Factor (dB)	Antenna Height (cm)	Table Angle (Degree)	Remark
2462	97.51	103.67			27.1	4.13	37.39	201	176	Average
2462	107.56	113.72			27.1	4.13	37.39	201	176	Peak
2485	41.72	47.74	54	-12.28	27.15	4.15	37.32	226	152	Average
2485	60.75	66.77	74	-13.25	27.15	4.15	37.32	201	176	Peak
4924	34.43	49.46	54	-19.57	31.12	6.88	53.03	111	195	Average
4924	45.89	60.92	74	-28.11	31.12	6.88	53.03	111	195	Peak

**Antennal Polarity & Test Distance: Vertical at 3 m**

Frequency (MHz)	Emission Level (dBuV/m)	Read Level (dBuV)	Limit (dBuV/m)	Margin (dB)	Antenna Factor (dB/m)	Cable Loss (dB)	Preamp Factor (dB)	Antenna Height (cm)	Table Angle (Degree)	Remark
2462	92.51	98.67			27.1	4.13	37.39	202	136	Average
2462	101.53	107.69			27.1	4.13	37.39	202	136	Peak
2486	36.73	42.75	54	-17.27	27.15	4.15	37.32	202	136	Average
2486	52.87	58.89	74	-21.13	27.15	4.15	37.32	202	136	Peak
4924	33.43	48.46	54	-20.57	31.12	6.88	53.03	111	131	Average
4924	44.73	59.76	74	-29.27	31.12	6.88	53.03	111	131	Peak

Remarks:

- Emission Level = Read Level + Antenna Factor + Cable Loss - Preamp Factor  
Margin value = Emission level – Limit value
- 2462 MHz: Fundamental frequency.

### 802.11n (HT40)

EUT Test Condition		Measurement Detail	
Channel	Channel 3	Frequency Range	1 GHz ~ 25 GHz
Input Power	120 Vac, 60 Hz	Detector Function	Peak (PK) Average (AV)
Environmental Conditions	25 deg. C, 65 % RH	Tested By	Gavin Wu

#### Horizontal

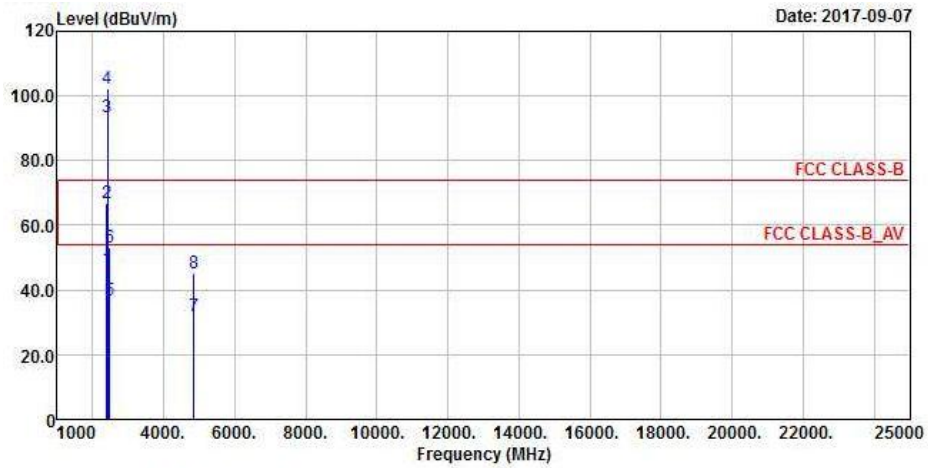

#### Vertical

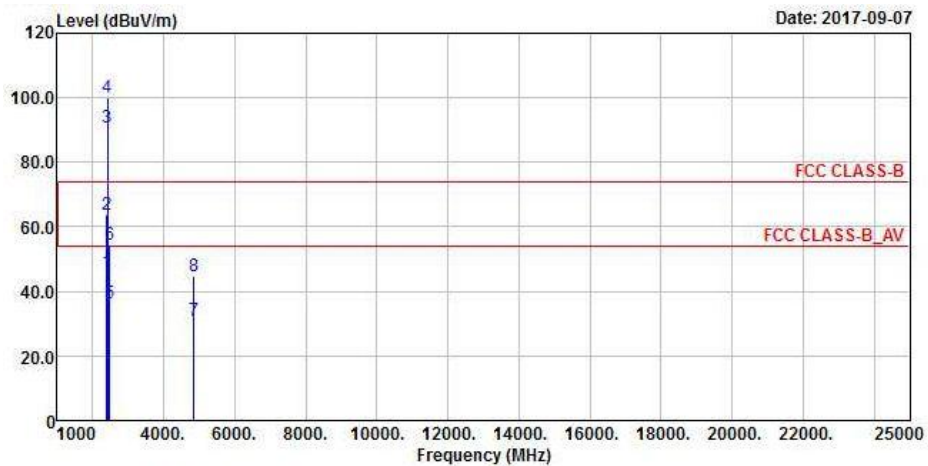

**Antennal Polarity & Test Distance: Horizontal at 3 m**

Frequency (MHz)	Emission Level (dBuV/m)	Read Level (dBuV)	Limit (dBuV/m)	Margin (dB)	Antenna Factor (dB/m)	Cable Loss (dB)	Preamp Factor (dB)	Antenna Height (cm)	Table Angle (Degree)	Remark
2389	46.4	68.51	54	-7.6	26.91	4.85	53.87	217	188	Average
<b>2389</b>	<b>66.67</b>	<b>88.78</b>	<b>74</b>	<b>-7.33</b>	<b>26.91</b>	<b>4.85</b>	<b>53.87</b>	<b>217</b>	<b>188</b>	<b>Peak</b>
2422	93.33	99.39			27.01	4.39	37.46	217	188	Average
2422	102.45	108.51			27.01	4.39	37.46	217	188	Peak
2484	36.78	58.65	54	-17.22	27.15	4.94	53.96	217	188	Average
2484	53.11	74.98	74	-20.89	27.15	4.94	53.96	217	188	Peak
4844	31.84	46.88	54	-22.16	31.01	6.83	52.88	176	38	Average
4844	45.1	60.14	74	-28.9	31.01	6.83	52.88	176	38	Peak

**Antennal Polarity & Test Distance: Vertical at 3 m**

Frequency (MHz)	Emission Level (dBuV/m)	Read Level (dBuV)	Limit (dBuV/m)	Margin (dB)	Antenna Factor (dB/m)	Cable Loss (dB)	Preamp Factor (dB)	Antenna Height (cm)	Table Angle (Degree)	Remark
2389	46	67.91	54	-8	26.91	4.85	53.67	238	78	Average
2389	63.86	85.77	74	-10.14	26.91	4.85	53.67	238	78	Peak
2422	90.91	96.97			27.01	4.39	37.46	238	78	Average
2422	100.27	106.33			27.01	4.39	37.46	238	78	Peak
2483.5	36.5	58.02	54	-17.5	27.15	4.94	53.61	238	78	Average
2483.5	54.25	75.77	74	-19.75	27.15	4.94	53.61	238	78	Peak
4844	30.95	46.17	54	-23.05	31.01	6.83	53.06	153	225	Average
4844	44.62	59.84	74	-29.38	31.01	6.83	53.06	153	225	Peak

Remarks:

- Emission Level = Read Level + Antenna Factor + Cable Loss - Preamp Factor  
Margin value = Emission level – Limit value
- 2422 MHz: Fundamental frequency.

EUT Test Condition		Measurement Detail	
Channel	Channel 6	Frequency Range	1 GHz ~ 25 GHz
Input Power	120 Vac, 60 Hz	Detector Function	Peak (PK) Average (AV)
Environmental Conditions	25 deg. C, 65 % RH	Tested By	Gavin Wu

### Horizontal

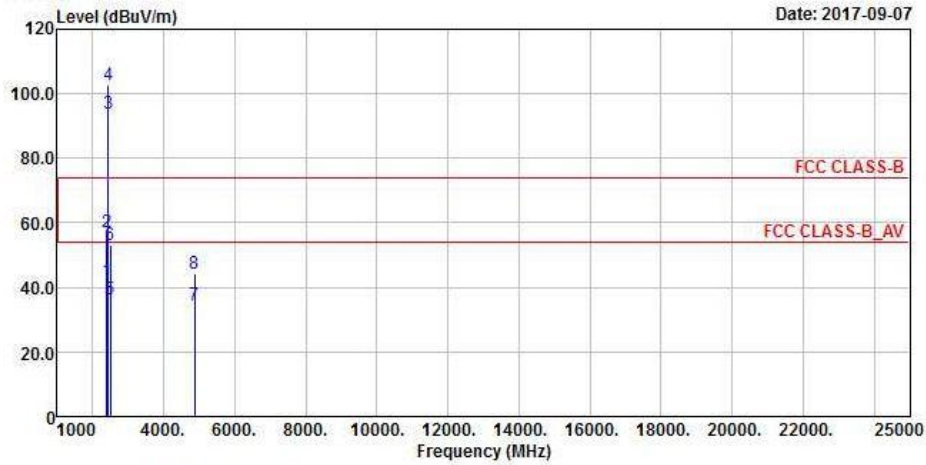

### Vertical

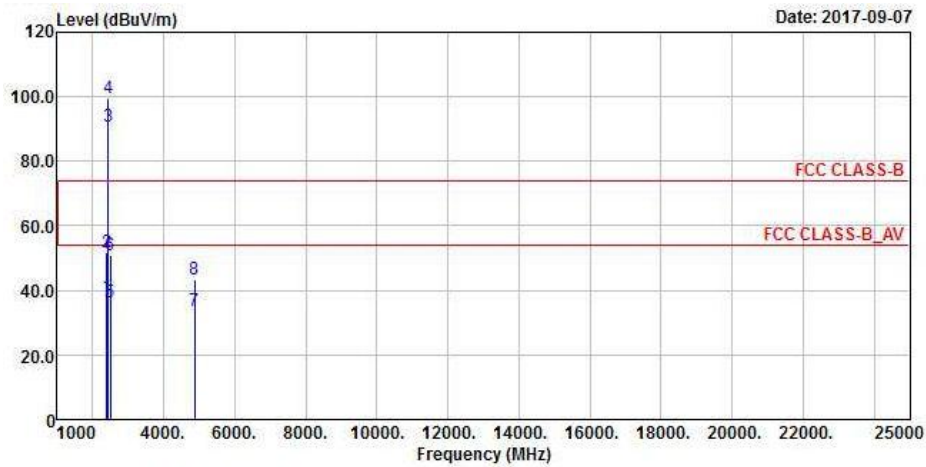

**Antennal Polarity & Test Distance: Horizontal at 3 m**

Frequency (MHz)	Emission Level (dBuV/m)	Read Level (dBuV)	Limit (dBuV/m)	Margin (dB)	Antenna Factor (dB/m)	Cable Loss (dB)	Preamp Factor (dB)	Antenna Height (cm)	Table Angle (Degree)	Remark
2389	41.92	48.43	54	-12.08	26.91	4.08	37.5	227	168	Average
2389	57.27	63.78	74	-16.73	26.91	4.08	37.5	227	168	Peak
2437	93.71	99.99			27.06	4.12	37.46	227	168	Average
2437	102.53	108.81			27.06	4.12	37.46	227	168	Peak
2489	36.49	42.45	54	-17.51	27.2	4.16	37.32	227	168	Average
2489	52.94	58.9	74	-21.06	27.2	4.16	37.32	227	168	Peak
4874	34.71	49.85	54	-19.29	31.06	6.85	53.05	109	118	Average
4874	44.23	59.37	74	-29.77	31.06	6.85	53.05	109	118	Peak

**Antennal Polarity & Test Distance: Vertical at 3 m**

Frequency (MHz)	Emission Level (dBuV/m)	Read Level (dBuV)	Limit (dBuV/m)	Margin (dB)	Antenna Factor (dB/m)	Cable Loss (dB)	Preamp Factor (dB)	Antenna Height (cm)	Table Angle (Degree)	Remark
2389	38.15	44.66	54	-15.85	26.91	4.08	37.5	228	146	Average
2389	51.95	58.46	74	-22.05	26.91	4.08	37.5	228	146	Peak
2437	90.81	97.09			27.06	4.12	37.46	228	146	Average
2437	99.71	105.99			27.06	4.12	37.46	228	146	Peak
2492	36.5	42.39	54	-17.5	27.2	4.16	37.25	228	146	Average
2492	51.01	56.9	74	-22.99	27.2	4.16	37.25	228	146	Peak
4874	33.71	48.85	54	-20.29	31.06	6.85	53.05	109	101	Average
4874	43.27	58.41	74	-30.73	31.06	6.85	53.05	109	101	Peak

Remarks:

- Emission Level = Read Level + Antenna Factor + Cable Loss - Preamp Factor  
Margin value = Emission level – Limit value
- 2437 MHz: Fundamental frequency.

EUT Test Condition		Measurement Detail	
Channel	Channel 9	Frequency Range	1 GHz ~ 25 GHz
Input Power	120 Vac, 60 Hz	Detector Function	Peak (PK) Average (AV)
Environmental Conditions	25 deg. C, 65 % RH	Tested By	Gavin Wu

### Horizontal

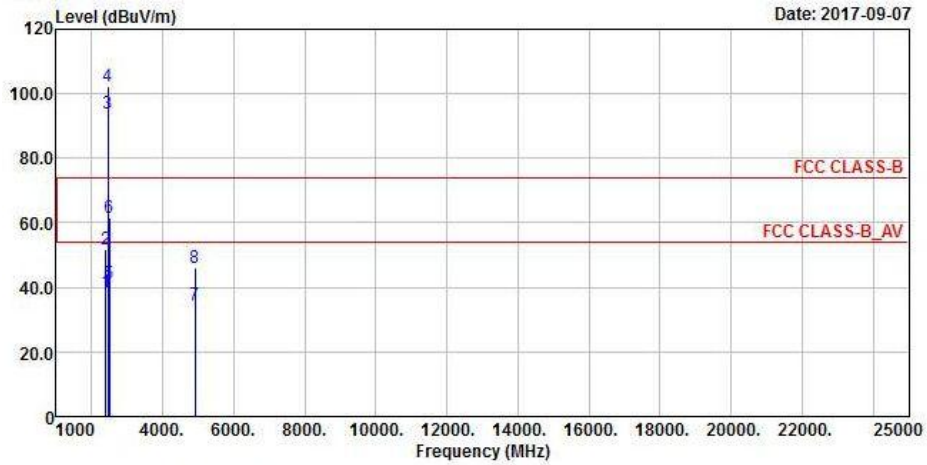

### Vertical

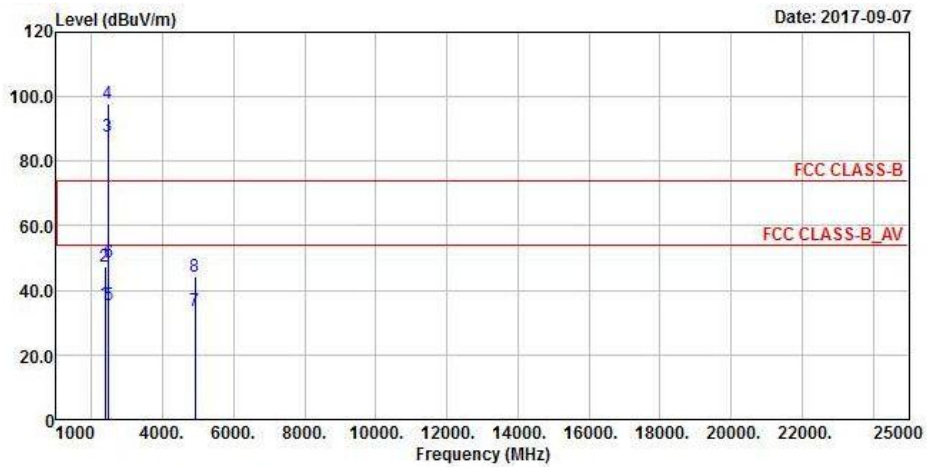

**Antennal Polarity & Test Distance: Horizontal at 3 m**

Frequency (MHz)	Emission Level (dBuV/m)	Read Level (dBuV)	Limit (dBuV/m)	Margin (dB)	Antenna Factor (dB/m)	Cable Loss (dB)	Preamp Factor (dB)	Antenna Height (cm)	Table Angle (Degree)	Remark
2388	38.35	44.86	54	-15.65	26.91	4.08	37.5	224	181	Average
2388	51.91	58.42	74	-22.09	26.91	4.08	37.5	224	181	Peak
2452	93.88	100.08			27.06	4.13	37.39	254	181	Average
2452	102.21	108.41			27.06	4.13	37.39	254	181	Peak
2489	41.3	47.26	54	-12.7	27.2	4.16	37.32	224	181	Average
2489	61.64	67.6	74	-12.36	27.2	4.16	37.32	224	181	Peak
4904	34.55	49.6	54	-19.45	31.1	6.88	53.03	112	206	Average
4904	46.14	61.19	74	-27.86	31.1	6.88	53.03	112	206	Peak

**Antennal Polarity & Test Distance: Vertical at 3 m**

Frequency (MHz)	Emission Level (dBuV/m)	Read Level (dBuV)	Limit (dBuV/m)	Margin (dB)	Antenna Factor (dB/m)	Cable Loss (dB)	Preamp Factor (dB)	Antenna Height (cm)	Table Angle (Degree)	Remark
2383	35.93	42.49	54	-18.07	26.86	4.08	37.5	226	222	Average
2383	47.49	54.05	74	-26.51	26.86	4.08	37.5	226	222	Peak
2452	87.78	93.98			27.06	4.13	37.39	226	222	Average
2452	97.76	103.96			27.06	4.13	37.39	226	222	Peak
2484	35.59	41.61	54	-18.41	27.15	4.15	37.32	226	222	Average
2484	48.62	54.64	74	-25.38	27.15	4.15	37.32	226	222	Peak
4904	33.55	48.6	54	-20.45	31.1	6.88	53.03	115	215	Average
4904	44.43	59.48	74	-29.57	31.1	6.88	53.03	115	215	Peak

Remarks:

- Emission Level = Read Level + Antenna Factor + Cable Loss - Preamp Factor  
Margin value = Emission level – Limit value
- 2452 MHz: Fundamental frequency.



**9 kHz ~ 30 MHz DATA:**

The amplitude of spurious emissions attenuated more than 20 dB below the permissible value is not required to be report.

**30 MHz ~ 1 GHz WORST-CASE DATA:**

**802.11n (HT40)**

EUT Test Condition		Measurement Detail	
Channel	Channel 3	Frequency Range	30 MHz ~ 1 GHz
Input Power	120 Vac, 60 Hz	Detector Function	Peak (PK) Quasi-peak (QP)
Environmental Conditions	25 deg. C, 65 % RH	Tested By	Gavin Wu

**Horizontal**

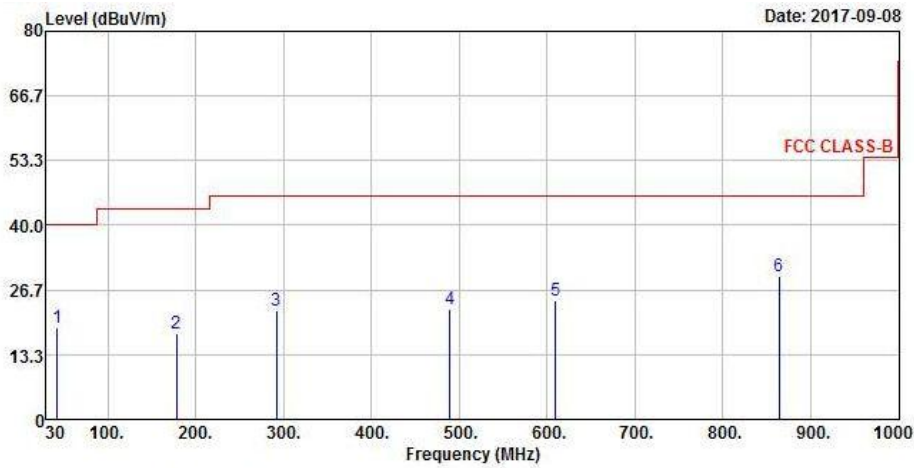

**Vertical**

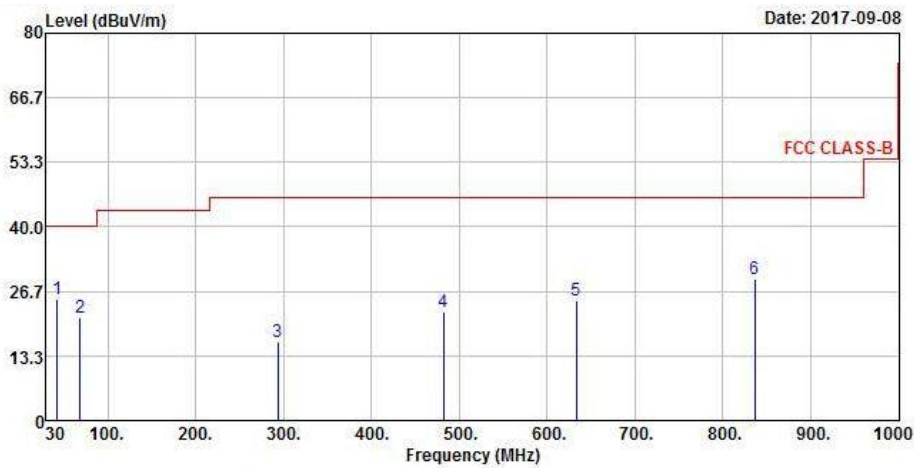

Antennal Polarity & Test Distance: Horizontal at 3 m										
Frequency (MHz)	Emission Level (dBuV/m)	Read Level (dBuV)	Limit (dBuV/m)	Margin (dB)	Antenna Factor (dB/m)	Cable Loss (dB)	Preamp Factor (dB)	Antenna Height (cm)	Table Angle (Degree)	Remark
42.61	18.77	35.77	40	-21.23	13.58	0.5	31.08	109	225	Peak
178.41	17.68	37.47	43.5	-25.82	10.92	1.11	31.82	128	183	Peak
291.9	22.39	39.75	46	-23.61	12.71	1.63	31.7	113	110	Peak
489.78	22.86	35.07	46	-23.14	17.12	2.44	31.77	139	181	Peak
610.06	24.54	33.95	46	-21.46	19.73	2.94	32.08	116	312	Peak
864.2	29.46	34.45	46	-16.54	23.05	3.9	31.94	103	153	Peak
Antennal Polarity & Test Distance: Vertical at 3 m										
Frequency (MHz)	Emission Level (dBuV/m)	Read Level (dBuV)	Limit (dBuV/m)	Margin (dB)	Antenna Factor (dB/m)	Cable Loss (dB)	Preamp Factor (dB)	Antenna Height (cm)	Table Angle (Degree)	Remark
42.61	24.97	41.97	40	-15.03	13.58	0.5	31.08	134	93	Peak
68.8	21.14	41.39	40	-18.86	10.89	0.63	31.77	123	295	Peak
293.84	16.25	33.59	46	-29.75	12.77	1.63	31.74	119	33	Peak
482.02	22.43	34.88	46	-23.57	16.96	2.42	31.83	123	272	Peak
633.34	24.92	33.99	46	-21.08	20.01	3.04	32.12	135	291	Peak
836.07	29.22	34.51	46	-16.78	22.69	3.79	31.77	118	360	Peak

Remarks:

- Emission Level = Read Level + Antenna Factor + Cable Loss - Preamp Factor  
Margin value = Emission level – Limit value

## 4.2 Conducted Emission Measurement

### 4.2.1 Limits of Conducted Emission Measurement

Frequency (MHz)	Conducted Limit (dBuV)	
	Quasi-peak	Average
0.15 - 0.5	66 - 56	56 - 46
0.50 - 5.0	56	46
5.0 - 30.0	60	50

Note: 1. The lower limit shall apply at the transition frequencies.

2. The limit decreases in line with the logarithm of the frequency in the range of 0.15 to 0.50 MHz.

### 4.2.2 Test Instruments

Description & Manufacturer	Model No.	Serial No.	Date of Calibration	Due Date of Calibration
Test Receiver ROHDE & SCHWARZ	ESCI	100613	Nov. 21, 2016	Nov. 20, 2017
RF signal cable Woken	5D-FB	Cable-cond1-01	Sep. 05, 2017	Sep. 04, 2018
LISN ROHDE & SCHWARZ (EUT)	ESH3-Z5	835239/001	Mar. 10, 2017	Mar. 09, 2018
LISN ROHDE & SCHWARZ (Peripheral)	ESH3-Z5	100311	Aug. 15, 2017	Aug. 14, 2018
Software ADT	BV ADT_Cond_ V7.3.7.3	NA	NA	NA

Note: 1. The calibration interval of the above test instruments is 12 months and the calibrations are traceable to NML/ROC and NIST/USA.

2. The test was performed in HwaYa Shielded Room 1.

3. The VCCI Site Registration No. is C-2040.

#### 4.2.3 Test Procedures

- a. The EUT was placed 0.4 meters from the conducting wall of the shielded room with EUT being connected to the power mains through a line impedance stabilization network (LISN). Other support units were connected to the power mains through another LISN. The two LISNs provide 50 ohm/50 uH of coupling impedance for the measuring instrument.
- b. Both lines of the power mains connected to the EUT were checked for maximum conducted interference.
- c. The frequency range from 150 kHz to 30 MHz was searched. Emission levels under (Limit – 20 dB) was not recorded.

**NOTE:** All modes of operation were investigated and the worst-case emissions are reported.

#### 4.2.4 Deviation from Test Standard

No deviation.

#### 4.2.5 Test Setup

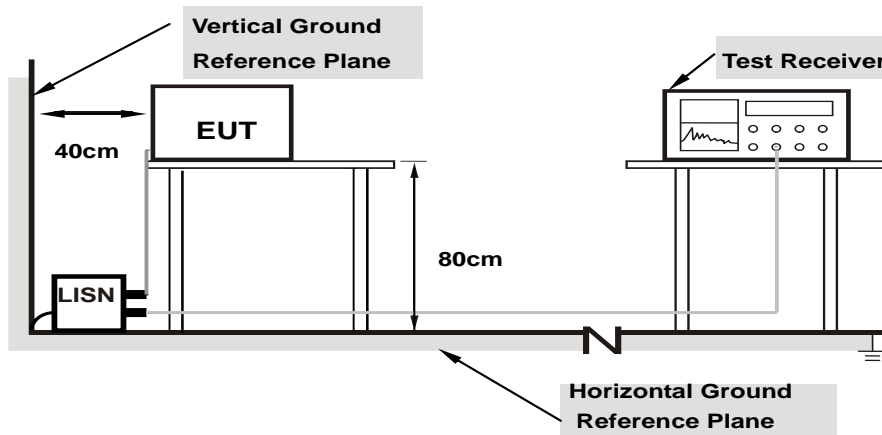

**Note:** 1.Support units were connected to second LISN.

For the actual test configuration, please refer to the attached file (Test Setup Photo).

#### 4.2.6 EUT Operating Conditions

- a. Placed the EUT on a testing table.
- b. Use the software to control the EUT under transmission condition continuously at specific channel frequency.

#### 4.2.7 Test Results

Frequency Range	150kHz ~ 30MHz	Detector Function & Resolution Bandwidth	Quasi-Peak (QP) / Average (AV), 9kHz
Input Power	120Vac, 60Hz	Environmental Conditions	25°C, 75%RH
Tested by	Han Wu	Test Date	2017/9/5

Phase Of Power : Line (L)										
No	Frequency (MHz)	Correction Factor (dB)	Reading Value (dBuV)		Emission Level (dBuV)		Limit (dBuV)		Margin (dB)	
			Q.P.	AV.	Q.P.	AV.	Q.P.	AV.	Q.P.	AV.
1	0.15400	10.39	29.42	15.84	39.81	26.23	65.78	55.78	-25.97	-29.55
2	0.18200	10.39	25.68	12.72	36.07	23.11	64.39	54.39	-28.32	-31.28
3	0.21406	10.39	24.90	12.28	35.29	22.67	63.05	53.05	-27.76	-30.38
4	0.23785	10.40	10.00	-0.29	20.40	10.11	62.17	52.17	-41.77	-42.06
5	0.25006	10.40	18.20	6.43	28.60	16.83	61.76	51.76	-33.16	-34.93
<b>6</b>	<b>0.64600</b>	<b>10.41</b>	<b>18.39</b>	<b>14.44</b>	<b>28.80</b>	<b>24.85</b>	<b>56.00</b>	<b>46.00</b>	<b>-27.20</b>	<b>-21.15</b>

Remarks:

1. Q.P. and AV. are abbreviations of quasi-peak and average individually.
2. The emission levels of other frequencies were very low against the limit.
3. Margin value = Emission level – Limit value
4. Correction factor = Insertion loss + Cable loss
5. Emission Level = Correction Factor + Reading Value

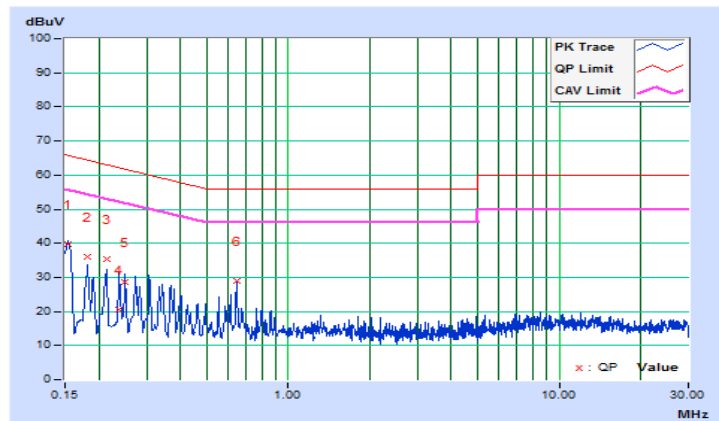

Frequency Range	150kHz ~ 30MHz	Detector Function & Resolution Bandwidth	Quasi-Peak (QP) / Average (AV), 9kHz
Input Power	120Vac, 60Hz	Environmental Conditions	25°C, 75%RH
Tested by	Han Wu	Test Date	2017/9/5

Phase Of Power : Neutral (N)										
No	Frequency (MHz)	Correction Factor (dB)	Reading Value (dBuV)		Emission Level (dBuV)		Limit (dBuV)		Margin (dB)	
			Q.P.	AV.	Q.P.	AV.	Q.P.	AV.	Q.P.	AV.
1	0.15000	10.15	26.04	12.74	36.19	22.89	66.00	56.00	-29.81	-33.11
2	0.19000	10.16	16.87	4.60	27.03	14.76	64.04	54.04	-37.01	-39.28
3	0.21400	10.16	24.01	11.61	34.17	21.77	63.05	53.05	-28.88	-31.28
4	0.30955	10.17	18.67	6.46	28.84	16.63	59.98	49.98	-31.14	-33.35
5	0.40179	10.17	15.83	2.83	26.00	13.00	57.82	47.82	-31.82	-34.82
6	0.63800	10.18	12.78	4.67	22.96	14.85	56.00	46.00	-33.04	-31.15

Remarks:

1. Q.P. and AV. are abbreviations of quasi-peak and average individually.
2. The emission levels of other frequencies were very low against the limit.
3. Margin value = Emission level – Limit value
4. Correction factor = Insertion loss + Cable loss
5. Emission Level = Correction Factor + Reading Value

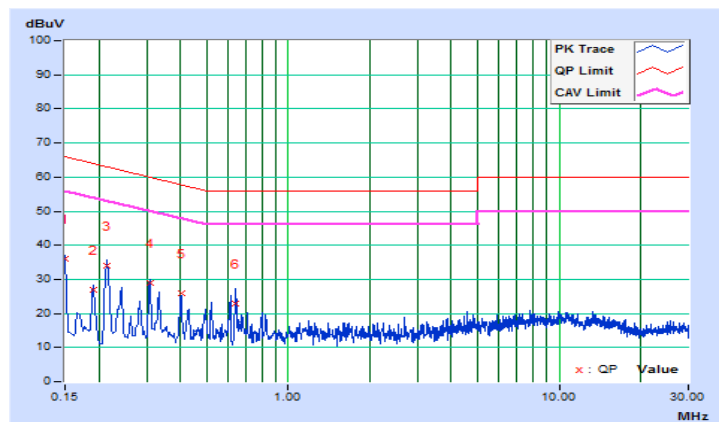

### 4.3 6 dB Bandwidth Measurement

#### 4.3.1 Limits of 6 dB Bandwidth Measurement

The minimum of 6 dB Bandwidth Measurement is 0.5 MHz.

#### 4.3.2 Test Setup

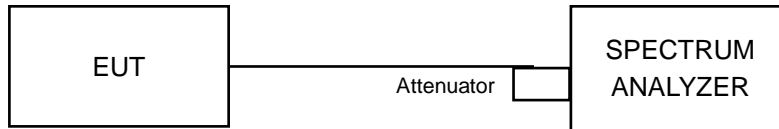

#### 4.3.3 Test Instruments

Refer to section 4.1.2 to get information of above instrument.

#### 4.3.4 Test Procedure

- Set resolution bandwidth (RBW) = 100 kHz
- Set the video bandwidth (VBW)  $\geq 3 \times$  RBW, Detector = Peak.
- Trace mode = max hold.
- Sweep = auto couple.
- Measure the maximum width of the emission that is constrained by the frequencies associated with the two amplitude points (upper and lower) that are attenuated by 6 dB relative to the maximum level measured in the fundamental emission

#### 4.3.5 Deviation from Test Standard

No deviation.

#### 4.3.6 EUT Operating Conditions

The software provided by client to enable the EUT under transmission condition continuously at lowest, middle and highest channel frequencies individually.

#### 4.3.7 Test Result

##### 802.11b

Channel	Frequency (MHz)	6 dB Bandwidth (MHz)	Minimum Limit (MHz)	Pass / Fail
1	2412	10.09	0.5	Pass
6	2437	10.11	0.5	Pass
11	2462	10.12	0.5	Pass

##### 802.11g

Channel	Frequency (MHz)	6 dB Bandwidth (MHz)	Minimum Limit (MHz)	Pass / Fail
1	2412	16.39	0.5	Pass
6	2437	16.40	0.5	Pass
11	2462	16.40	0.5	Pass

##### 802.11n (HT20)

Channel	Frequency (MHz)	6 dB Bandwidth (MHz)	Minimum Limit (MHz)	Pass / Fail
1	2412	17.59	0.5	Pass
6	2437	17.60	0.5	Pass
11	2462	17.63	0.5	Pass

##### 802.11n (HT40)

Channel	Frequency (MHz)	6 dB Bandwidth (MHz)	Minimum Limit (MHz)	Pass / Fail
3	2422	35.41	0.5	Pass
6	2437	36.11	0.5	Pass
9	2452	36.29	0.5	Pass



### Spectrum Plot of Worst Value

#### 802.11b

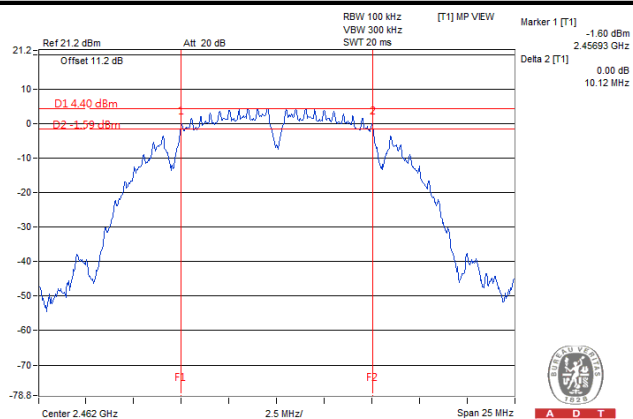

#### 802.11g

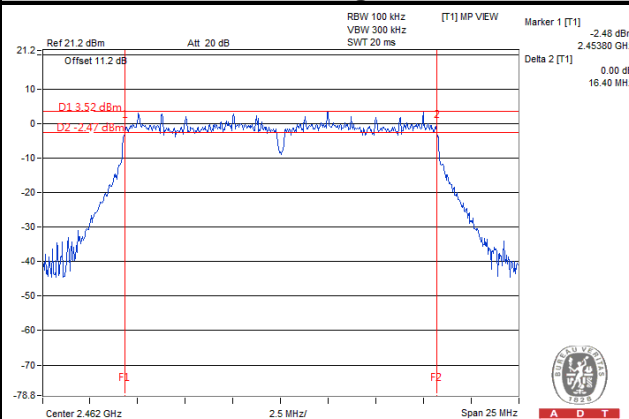

#### 802.11n (HT20)

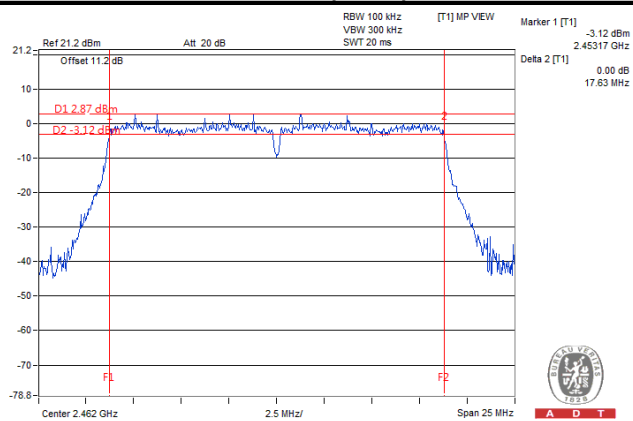

#### 802.11n (HT40)

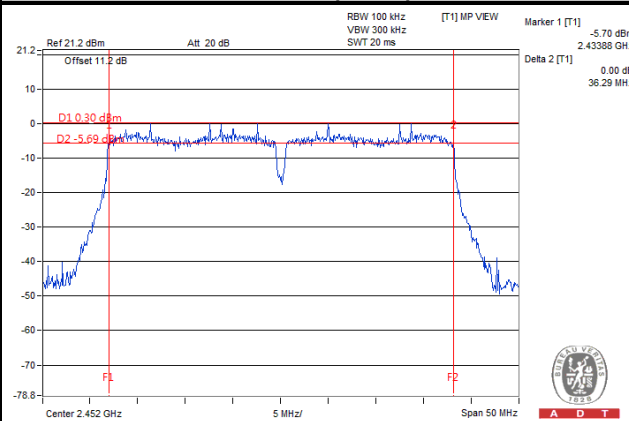

## 4.4 Occupied Bandwidth Measurement

### 4.4.1 Test Setup

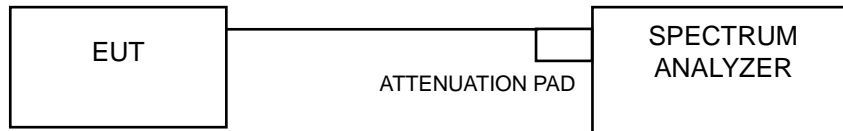

### 4.4.2 Test Instruments

Refer to section 4.1.2 to get information of above instrument.

### 4.4.3 Test Procedure

The transmitter output was connected to the spectrum analyzer through an attenuator. The bandwidth of the fundamental frequency was measured by spectrum analyzer with resolution bandwidth in the range of 1 % to 5 % of the anticipated emission bandwidth, and a video bandwidth at least 3x the resolution bandwidth and set the detector to PEAK. The width of a frequency band such that, below the lower and above the upper frequency limits, the mean powers emitted are each equal to a specified percentage 0.5 % of the total mean power of a given emission.

### 4.4.4 Deviation From Test Standard

No deviation.

### 4.4.5 EUT Operating Conditions

The software provided by client to enable the EUT under transmission condition continuously at lowest, middle and highest channel frequencies individually.

#### 4.4.6 Test Results

##### 802.11b

Channel	Frequency (MHz)	Occupied Bandwidth (MHz)	Pass / Fail
1	2412	13.46	Pass
6	2437	13.45	Pass
11	2462	13.50	Pass

##### 802.11g

Channel	Frequency (MHz)	Occupied Bandwidth (MHz)	Pass / Fail
1	2412	16.73	Pass
6	2437	16.77	Pass
11	2462	16.80	Pass

##### 802.11n (HT20)

Channel	Frequency (MHz)	Occupied Bandwidth (MHz)	Pass / Fail
1	2412	17.78	Pass
6	2437	17.70	Pass
11	2462	17.80	Pass

##### 802.11n (HT40)

Channel	Frequency (MHz)	Occupied Bandwidth (MHz)	Pass / Fail
3	2422	36.53	Pass
6	2437	36.50	Pass
9	2452	36.50	Pass

### Spectrum Plot of Worst Value

#### 802.11b

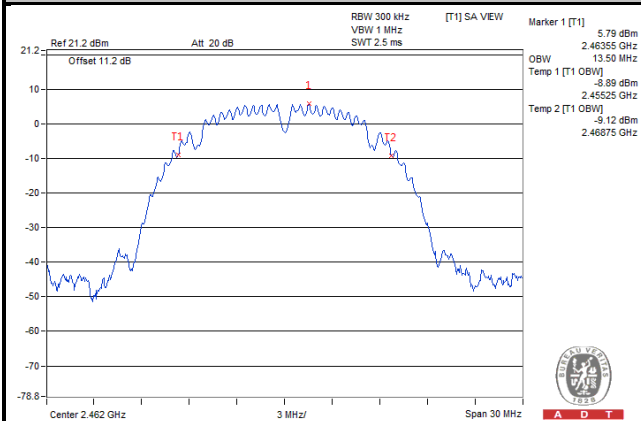

#### 802.11g

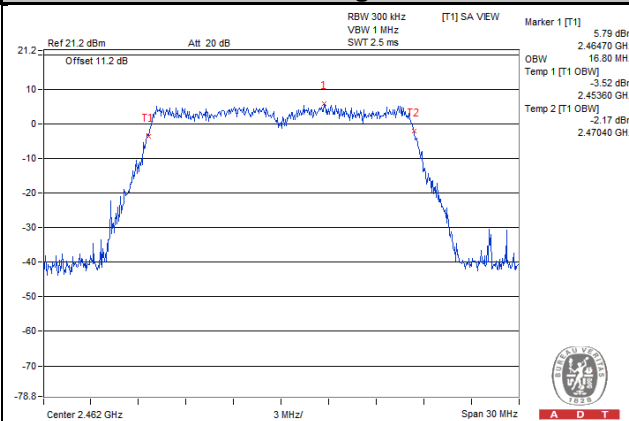

#### 802.11n (HT20)

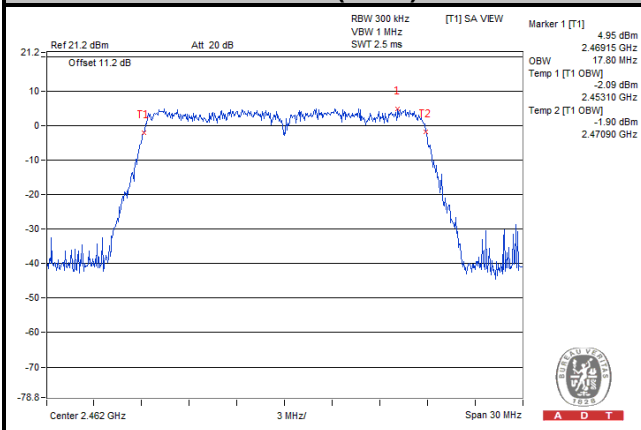

#### 802.11n (HT40)

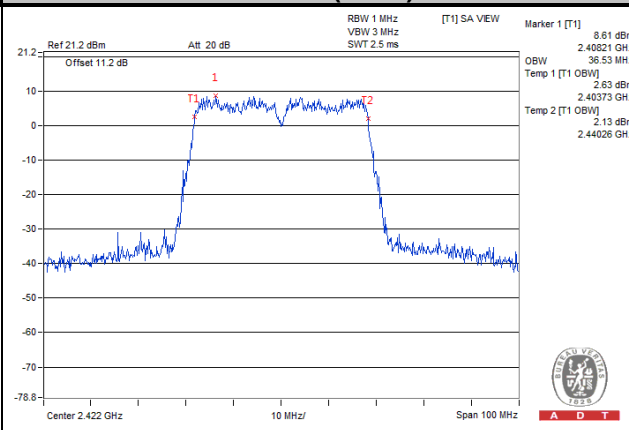

## 4.5 Conducted Output Power Measurement

### 4.5.1 Limits of Conducted Output Power Measurement

For systems using digital modulation in the 2400–2483.5 MHz bands: 1 Watt (30 dBm)

### 4.5.2 Test Setup

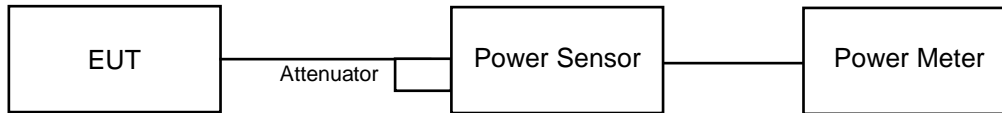

### 4.5.3 Test Instruments

Refer to section 4.1.2 to get information of above instrument.

### 4.5.4 Test Procedures

A peak power sensor was used on the output port of the EUT. A power meter was used to read the response of the peak power sensor. Record the power level.

### 4.5.5 Deviation from Test Standard

No deviation.

### 4.5.6 EUT Operating Conditions

The software provided by client to enable the EUT under transmission condition continuously at lowest, middle and highest channel frequencies individually.

#### 4.5.7 Test Results

##### 802.11b

Channel	Frequency (MHz)	Peak Power (mW)	Peak Power (dBm)	Limit (dBm)	Pass / Fail
1	2412	53.333	17.27	30	Pass
6	2437	51.286	17.10	30	Pass
11	2462	49.317	16.93	30	Pass

##### 802.11g

Channel	Frequency (MHz)	Peak Power (mW)	Peak Power (dBm)	Limit (dBm)	Pass / Fail
1	2412	299.916	24.77	30	Pass
6	2437	295.121	24.70	30	Pass
11	2462	289.068	24.61	30	Pass

##### 802.11n (HT20)

Channel	Frequency (MHz)	Peak Power (mW)	Peak Power (dBm)	Limit (dBm)	Pass / Fail
1	2412	304.789	24.84	30	Pass
6	2437	291.743	24.65	30	Pass
11	2462	283.139	24.52	30	Pass

##### 802.11n (HT40)

Channel	Frequency (MHz)	Peak Power (mW)	Peak Power (dBm)	Limit (dBm)	Pass / Fail
3	2422	319.89	25.05	30	Pass
6	2437	307.61	24.88	30	Pass
9	2452	296.483	24.72	30	Pass

## 4.6 Power Spectral Density Measurement

### 4.6.1 Limits of Power Spectral Density Measurement

The Maximum of Power Spectral Density Measurement is 8 dBm.

### 4.6.2 Test Setup

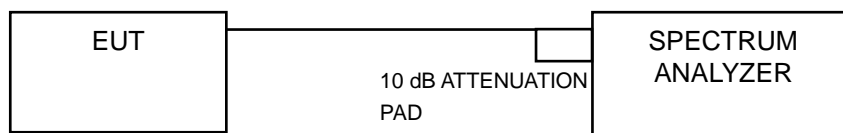

### 4.6.3 Test Instruments

Refer to section 4.1.2 to get information of above instrument.

### 4.6.4 Test Procedure

- Set analyzer center frequency to DTS channel center frequency.
- Set the span to 1.5 times the DTS bandwidth.
- Set the RBW to:  $3 \text{ kHz} \leq \text{RBW} \leq 100 \text{ kHz}$ .
- Set the VBW  $\geq 3 \times \text{RBW}$ .
- Detector = peak.
- Sweep time = auto couple.
- Trace mode = max hold.
- Allow trace to fully stabilize.
- Use the peak marker function to determine the maximum amplitude level within the RBW.

### 4.6.5 Deviation from Test Standard

No deviation.

### 4.6.6 EUT Operating Condition

The software provided by client to enable the EUT under transmission condition continuously at lowest, middle and highest channel frequencies individually.

#### 4.6.7 Test Results

##### 802.11b

Channel	Frequency (MHz)	PSD (dBm/3 kHz)	Limit (dBm/3 kHz)	Pass / Fail
1	2412	-8.20	8	Pass
6	2437	-8.90	8	Pass
11	2462	-8.46	8	Pass

##### 802.11g

Channel	Frequency (MHz)	PSD (dBm/3 kHz)	Limit (dBm/3 kHz)	Pass / Fail
1	2412	-12.26	8	Pass
6	2437	-11.78	8	Pass
11	2462	-12.42	8	Pass

##### 802.11n (HT20)

Channel	Frequency (MHz)	PSD (dBm/3 kHz)	Limit (dBm/3 kHz)	Pass / Fail
1	2412	-11.33	8	Pass
6	2437	-11.31	8	Pass
11	2462	-12.01	8	Pass

##### 802.11n (HT40)

Channel	Frequency (MHz)	PSD (dBm/3 kHz)	Limit (dBm/3 kHz)	Pass / Fail
3	2422	-13.87	8	Pass
6	2437	-14.22	8	Pass
9	2452	-14.44	8	Pass



### Spectrum Plot of Worst Value

#### 802.11b

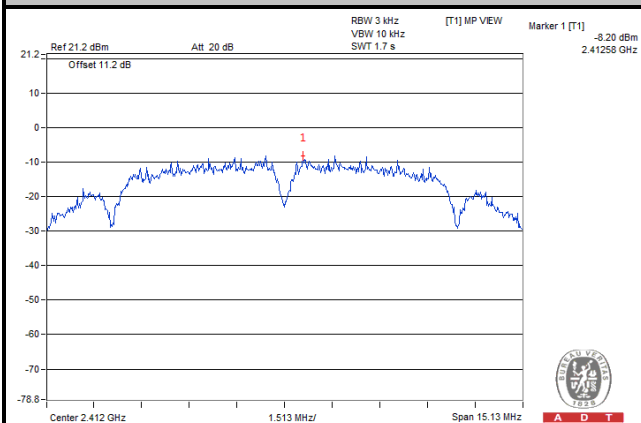

#### 802.11g

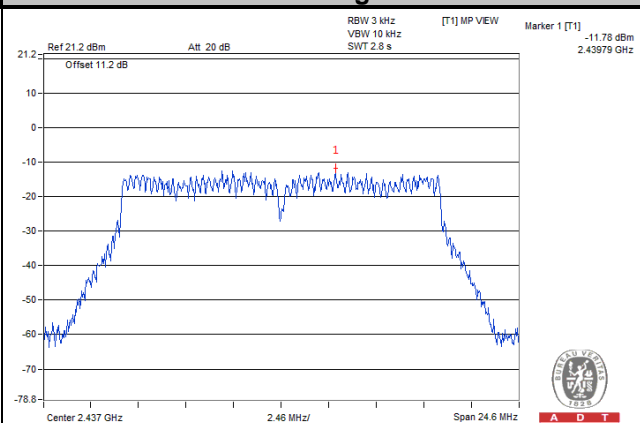

#### 802.11n (HT20)

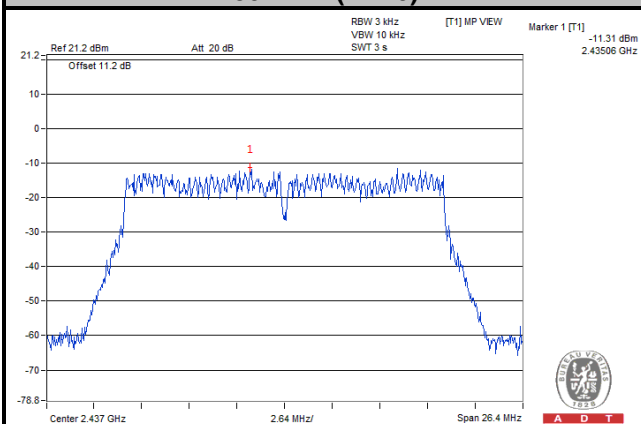

#### 802.11n (HT40)

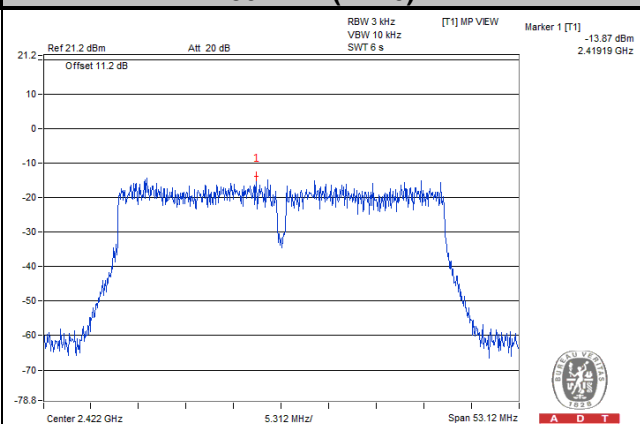

## 4.7 Conducted Out of Band Emission Measurement

### 4.7.1 Limits of Conducted Out of Band Emission Measurement

Below 20 dB of the highest emission level of operating band (in 100 kHz Resolution Bandwidth).

### 4.7.2 Test Setup

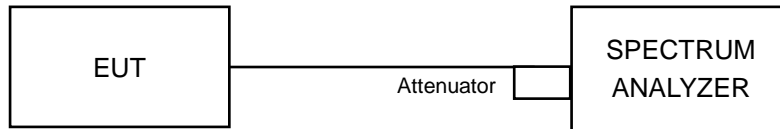

### 4.7.3 Test Instruments

Refer to section 4.1.2 to get information of above instrument.

### 4.7.4 Test Procedure

#### MEASUREMENT PROCEDURE REF

1. Set the RBW = 100 kHz.
2. Set the VBW  $\geq$  300 kHz.
3. Detector = peak.
4. Sweep time = auto couple.
5. Trace mode = max hold.
6. Allow trace to fully stabilize.
7. Use the peak marker function to determine the maximum power level in any 100 kHz band segment within the fundamental EBW.

#### MEASUREMENT PROCEDURE OOB

1. Set RBW = 100 kHz.
2. Set VBW  $\geq$  300 kHz.
3. Detector = peak.
4. Sweep = auto couple.
5. Trace Mode = max hold.
6. Allow trace to fully stabilize.
7. Use the peak marker function to determine the maximum amplitude level.

### 4.7.5 Deviation from Test Standard

No deviation.

### 4.7.6 EUT Operating Condition

The software provided by client to enable the EUT under transmission condition continuously at lowest, middle and highest channel frequencies individually.

### 4.7.7 Test Results

The spectrum plots are attached on the following images. D1 line indicates the highest level, and D2 line indicates the 20 dB offset below D1. It shows compliance with the requirement.

#### 802.11b

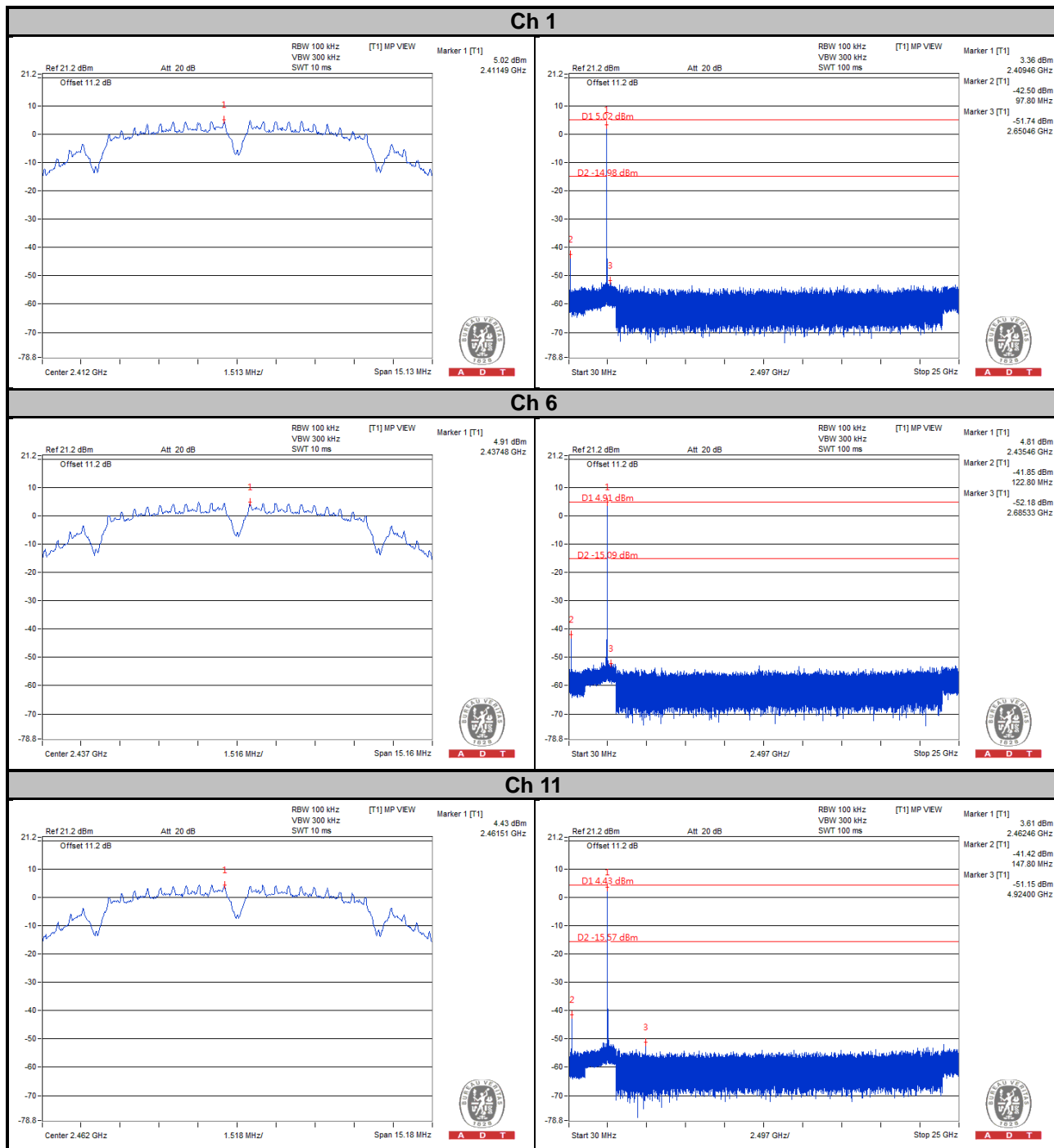

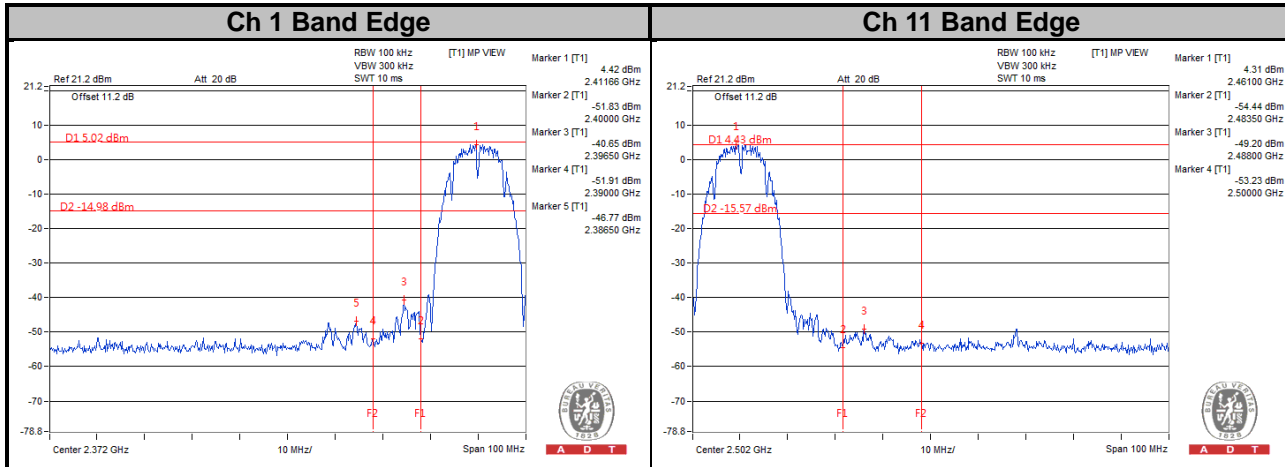

# 802.11g

## Ch 1

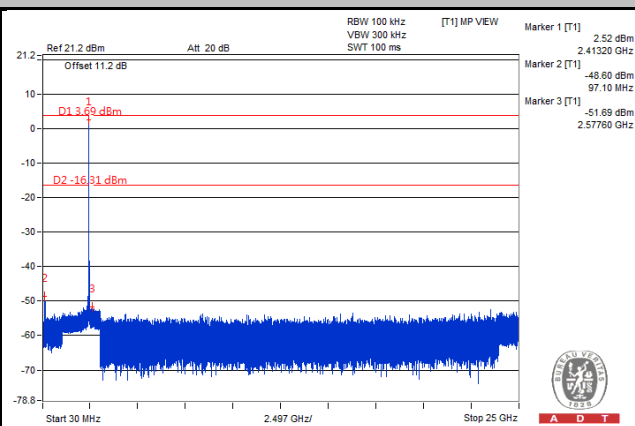
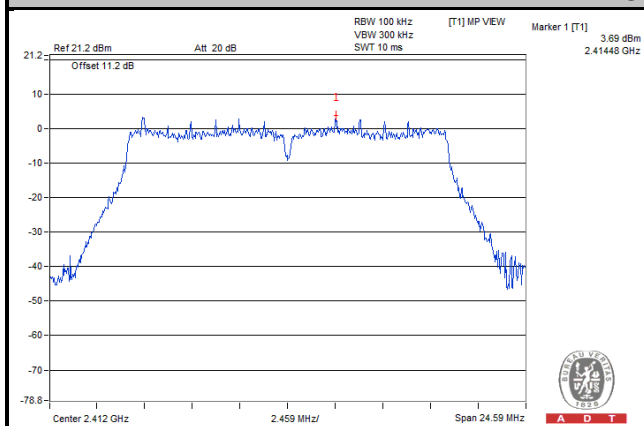

## Ch 6

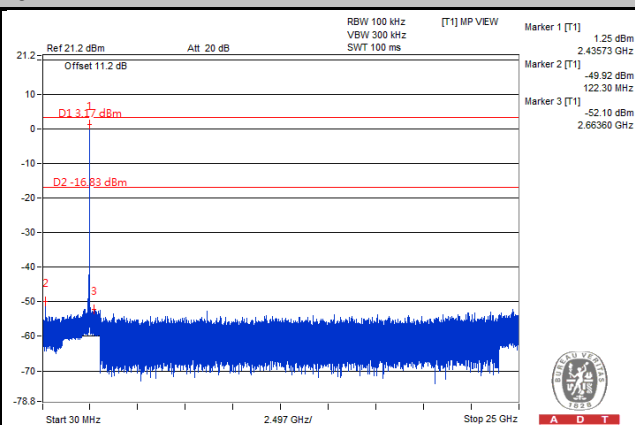
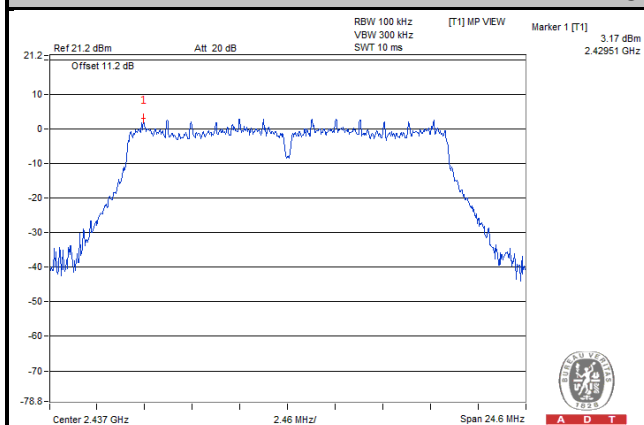

## Ch 11

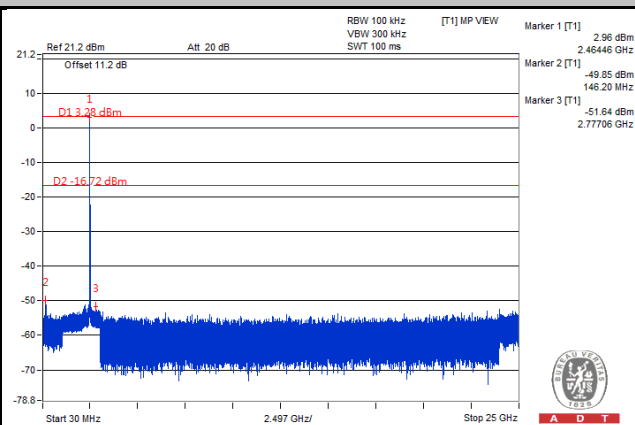
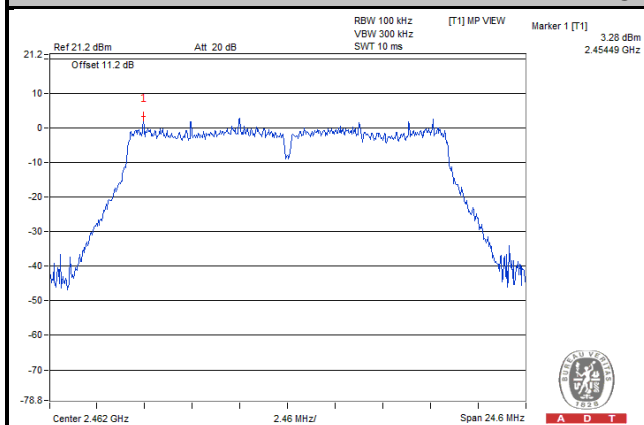

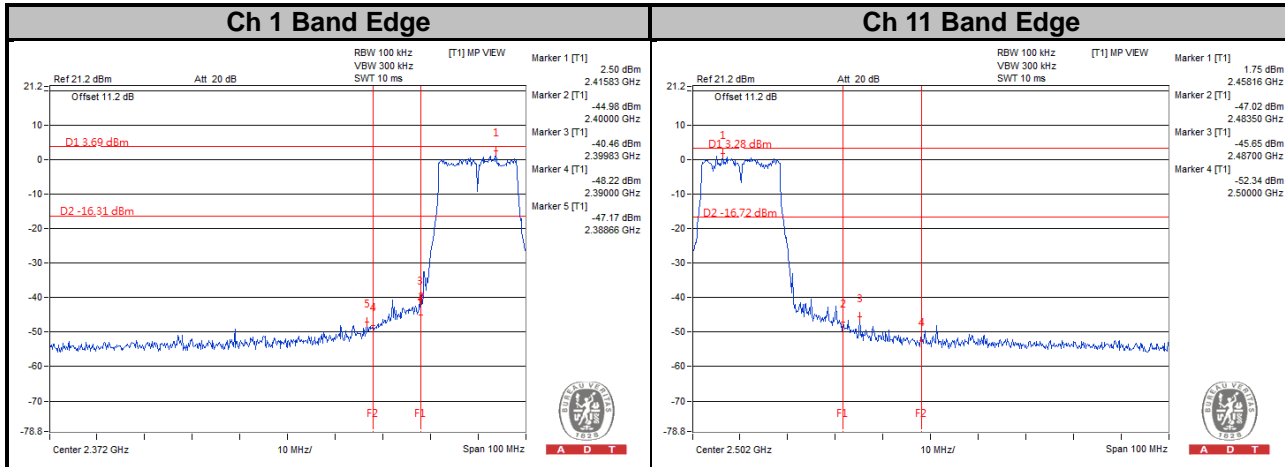

# 802.11n (HT20)

## Ch 1

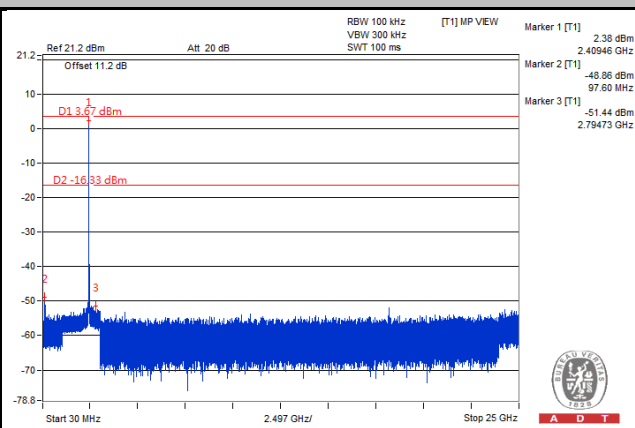
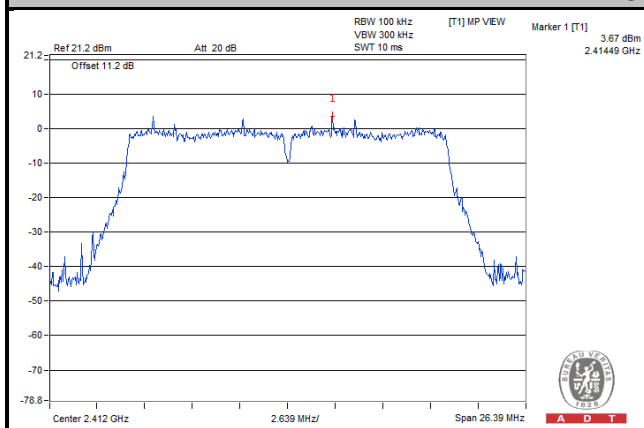

## Ch 6

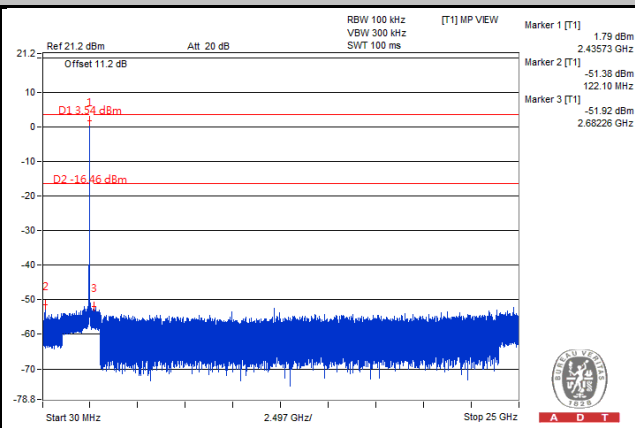
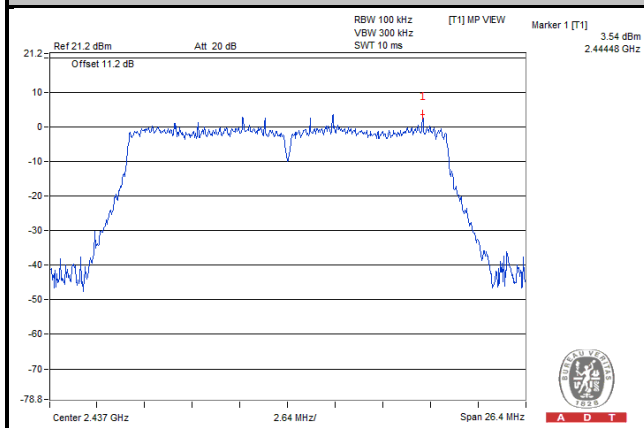

## Ch 11

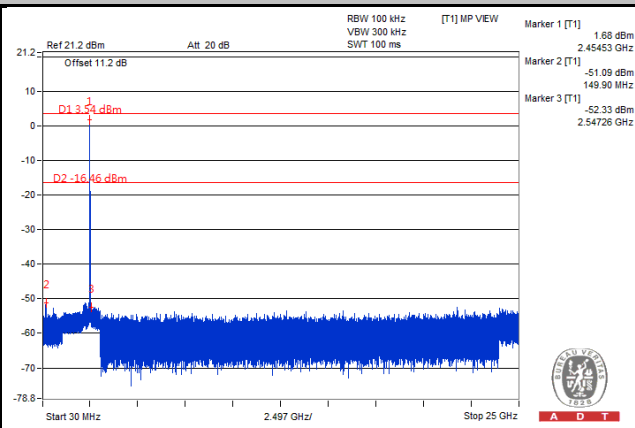
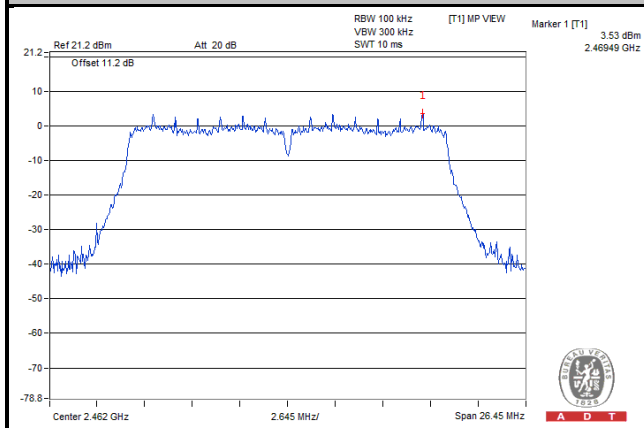

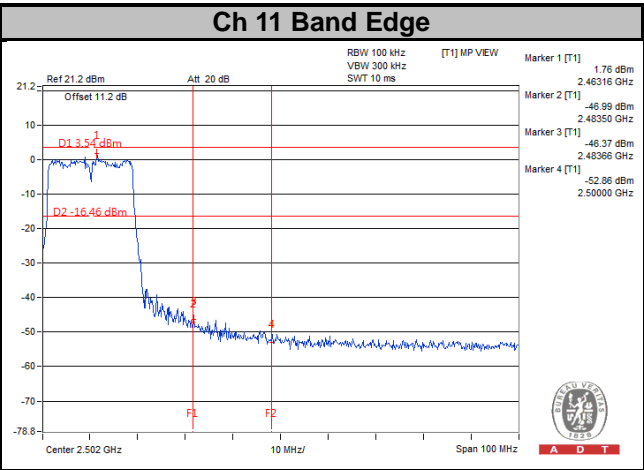
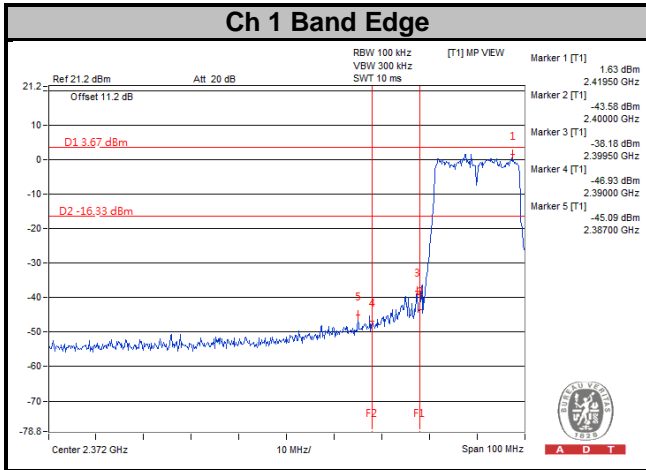



### 802.11n (HT40)

#### Ch 3

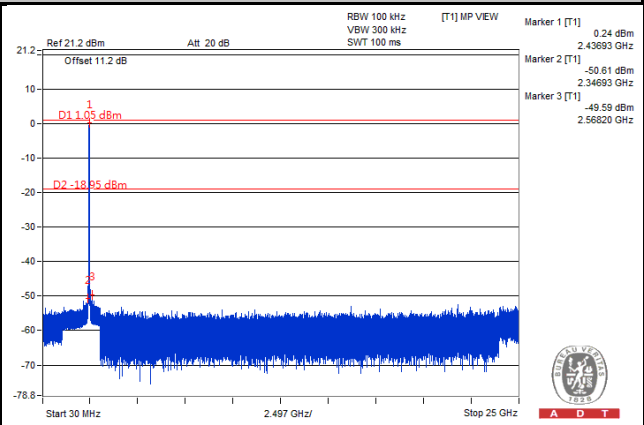
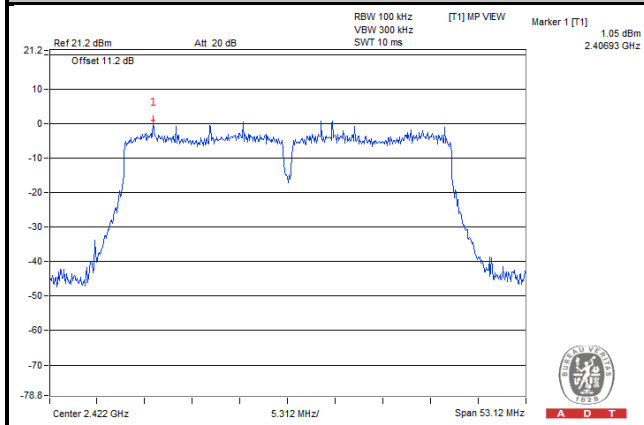

#### Ch 6

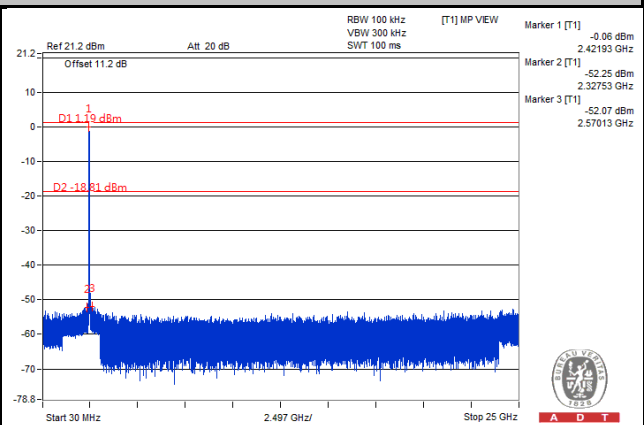
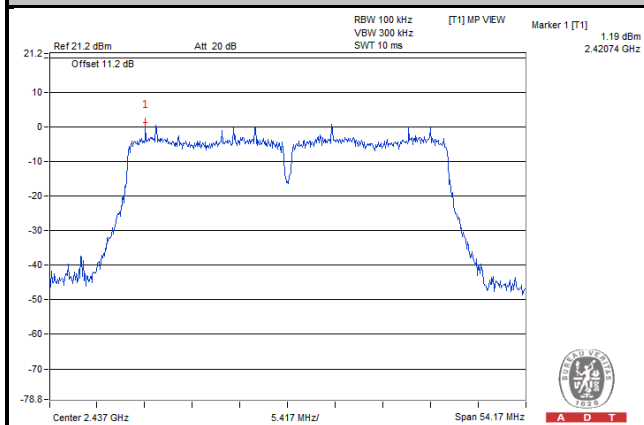

#### Ch 9

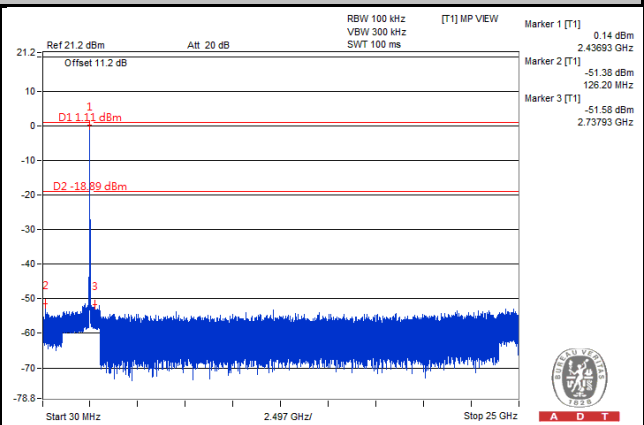
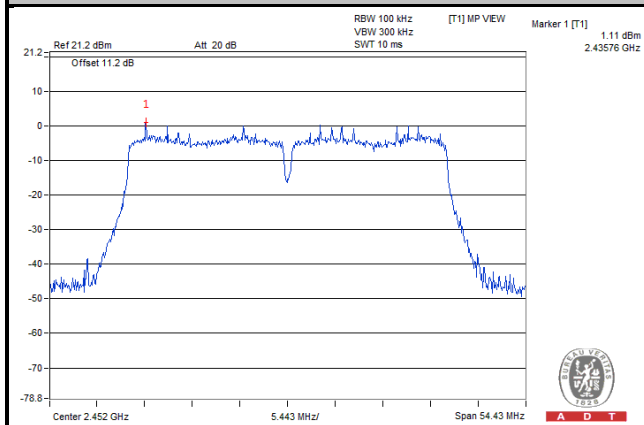

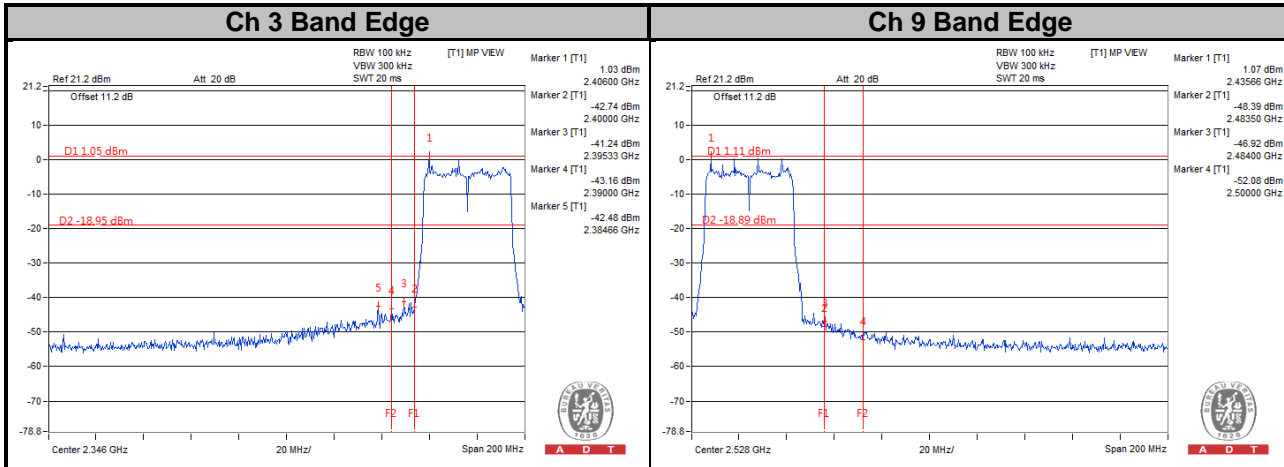

# Annex A- Radiated Bandedge Plots

## 802.11b

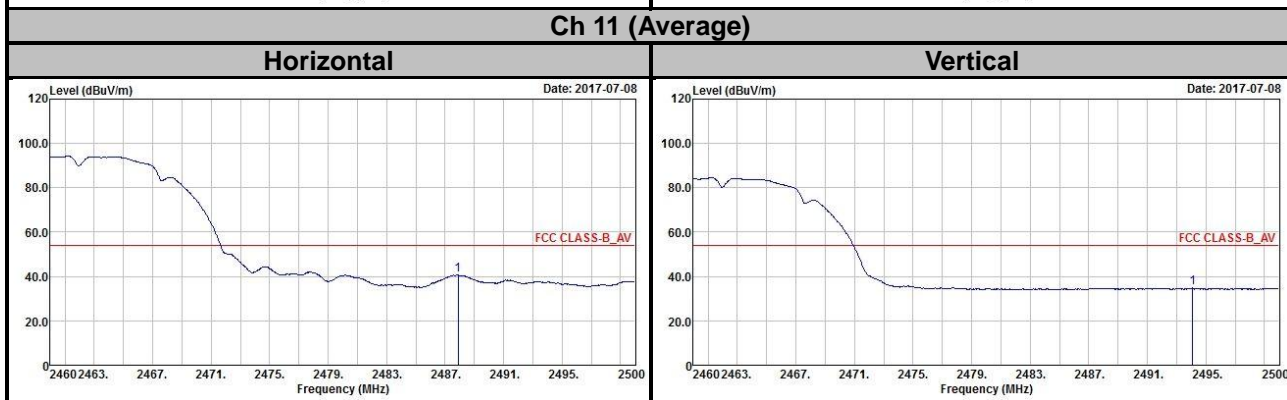
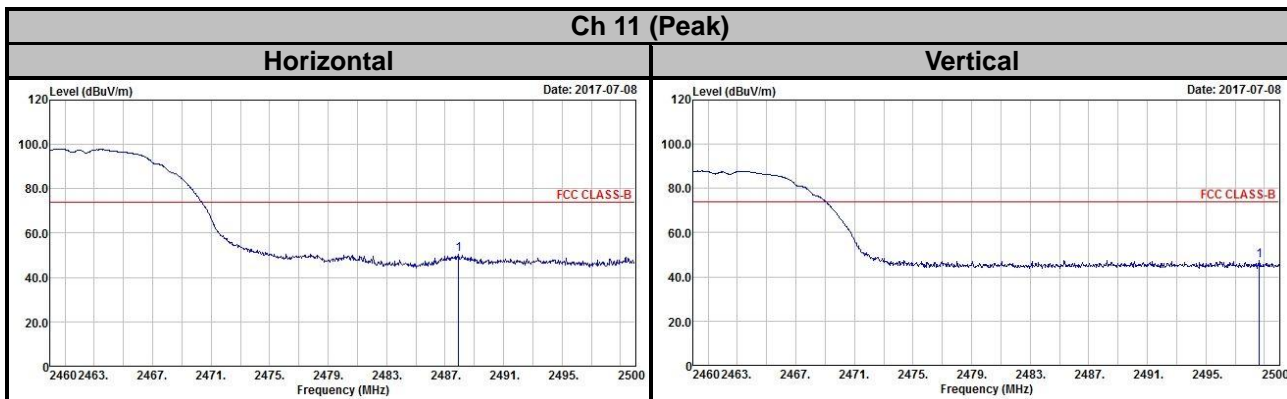
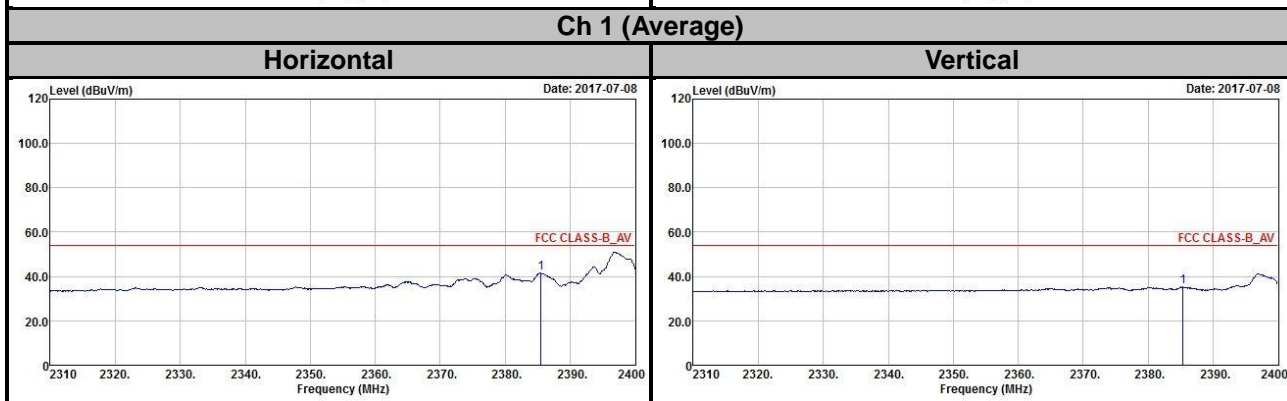
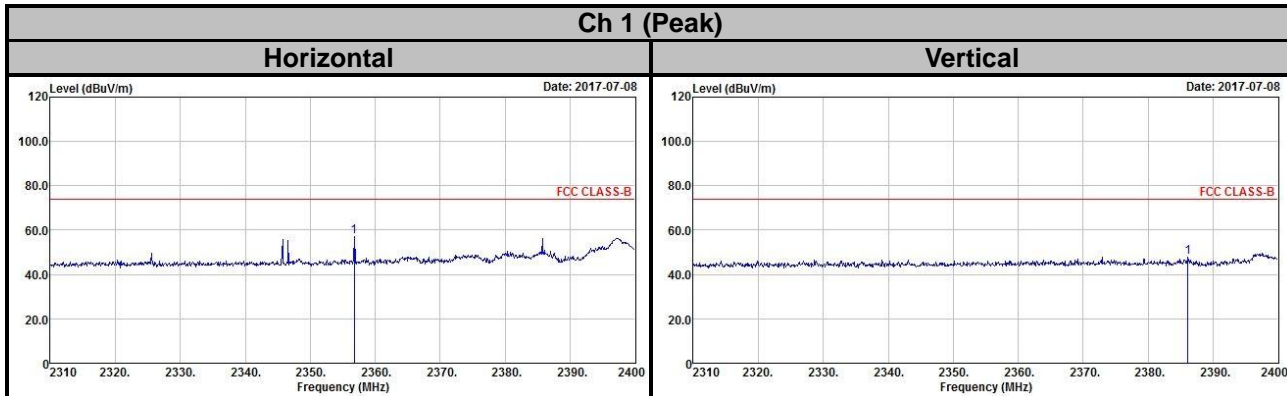

802.11g

Ch 1 (Peak)

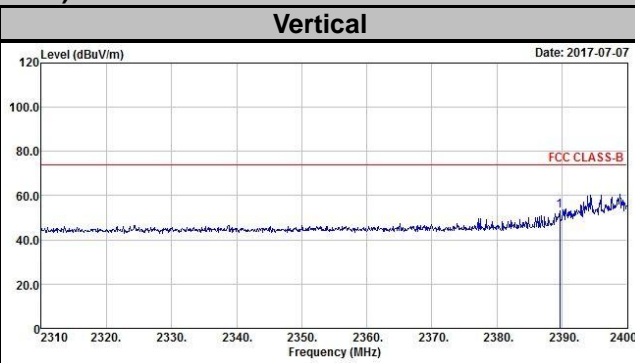
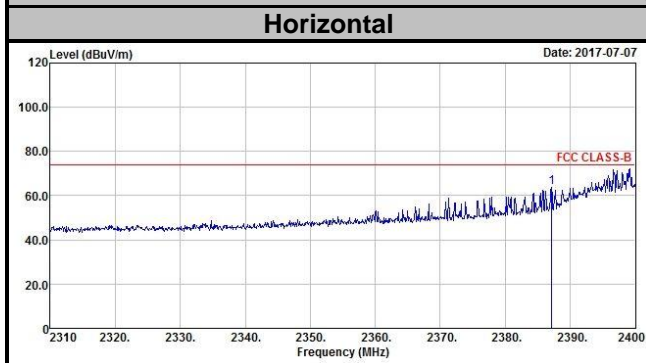

Ch 1 (Average)

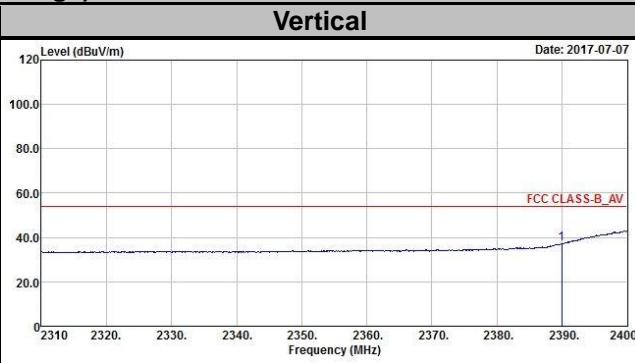
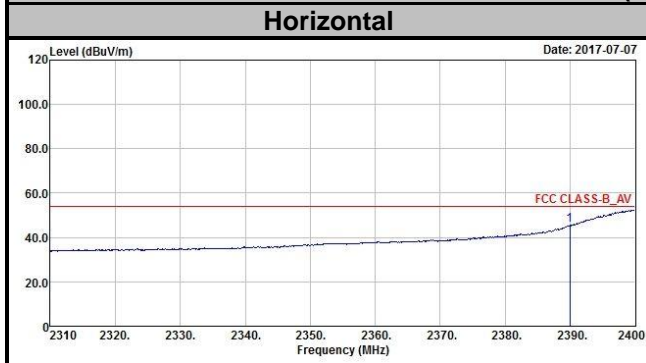

Ch 11 (Peak)

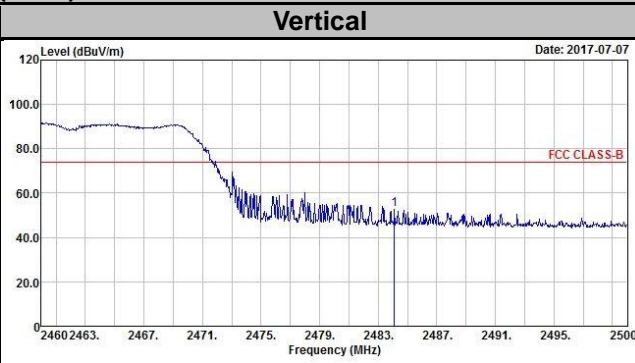
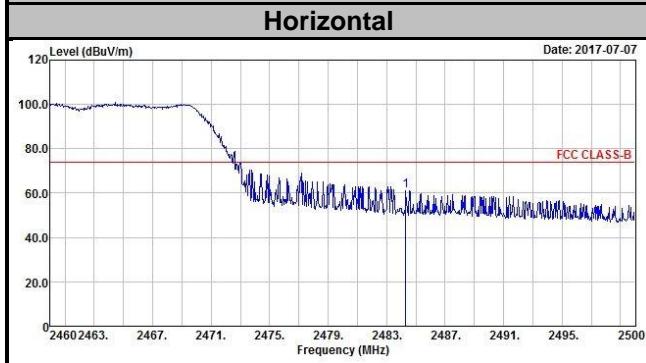

Ch 11 (Average)

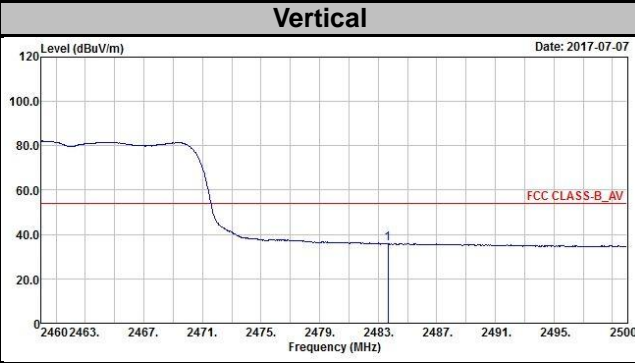
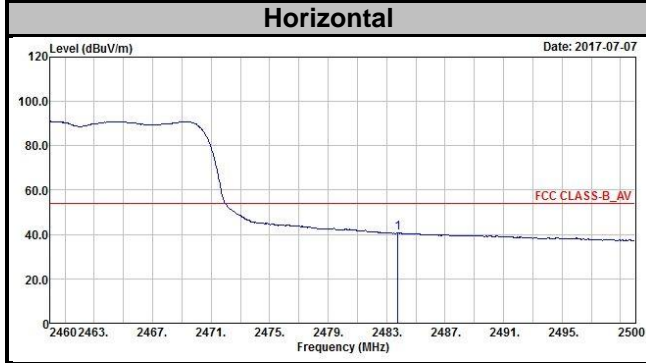

802.11n (HT20)

Ch 1 (Peak)

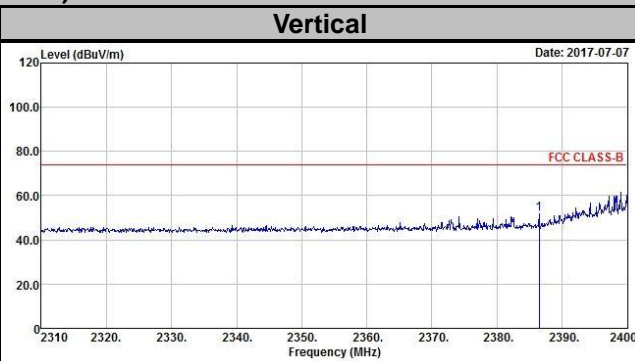
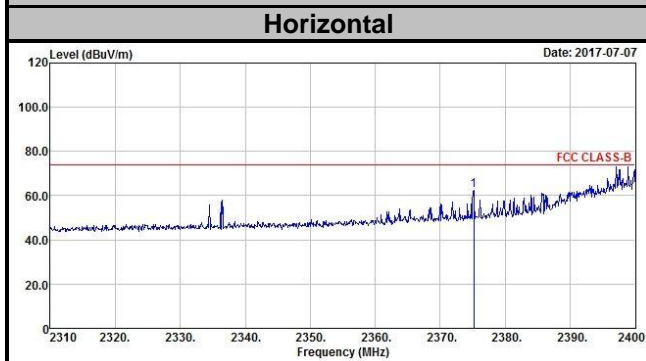

Ch 1 (Average)

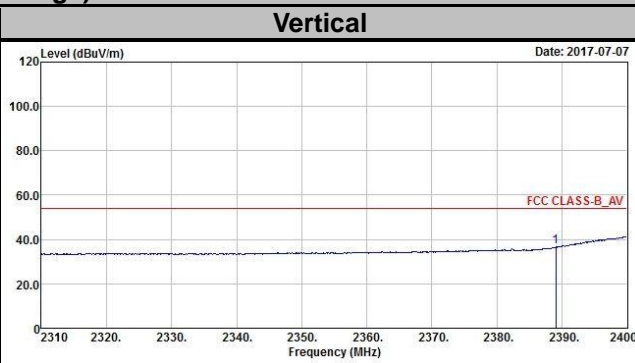
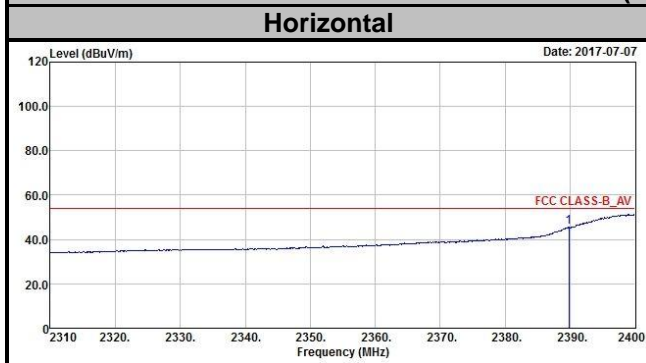

Ch 11 (Peak)

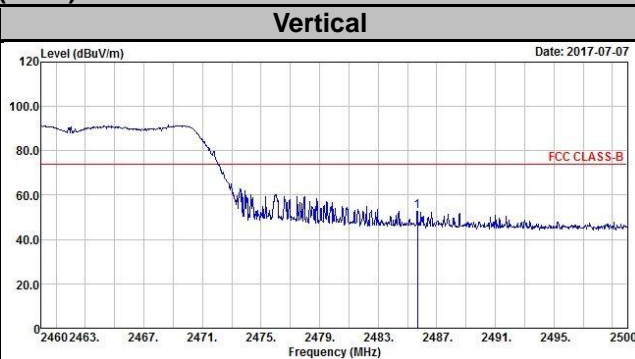
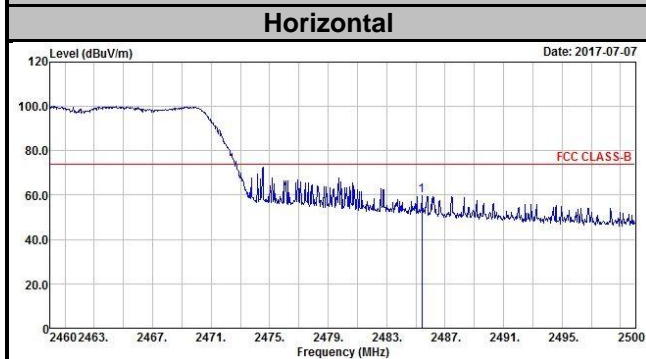

Ch 11 (Average)

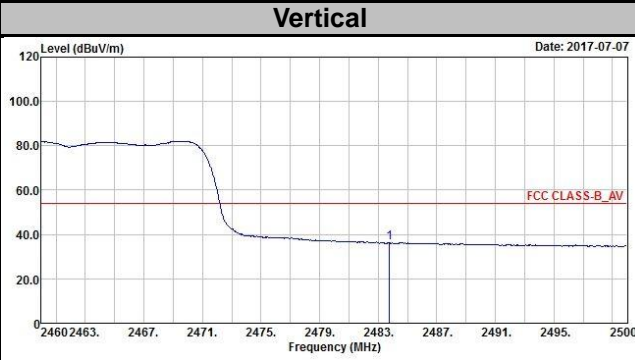
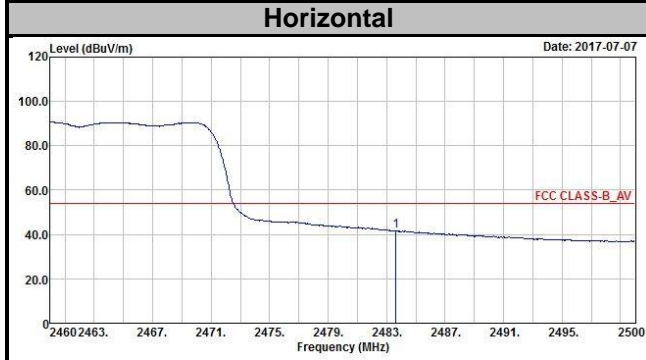

802.11n (HT40)

Ch 3 (Peak)

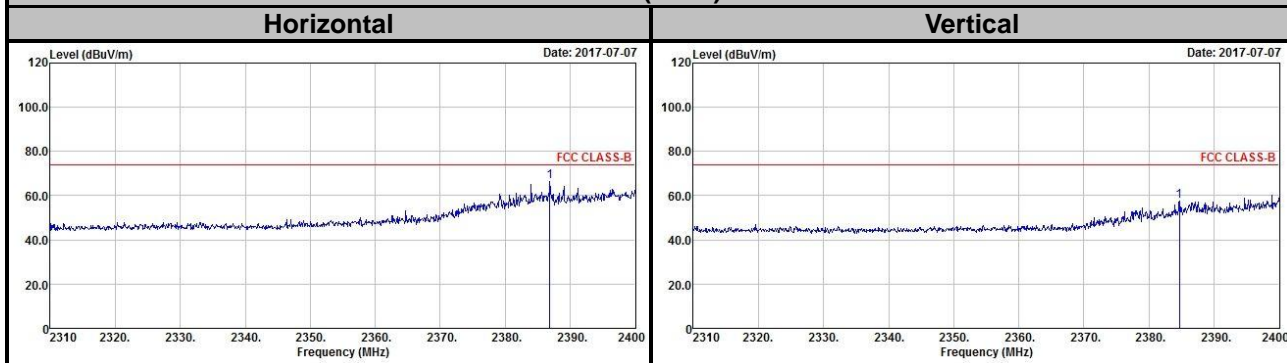

Ch 3 (Average)

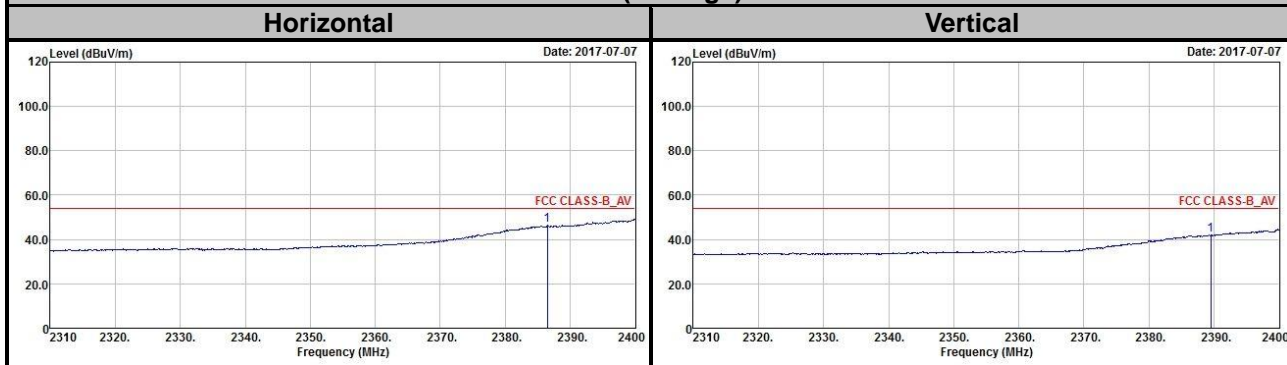

Ch 9 (Peak)

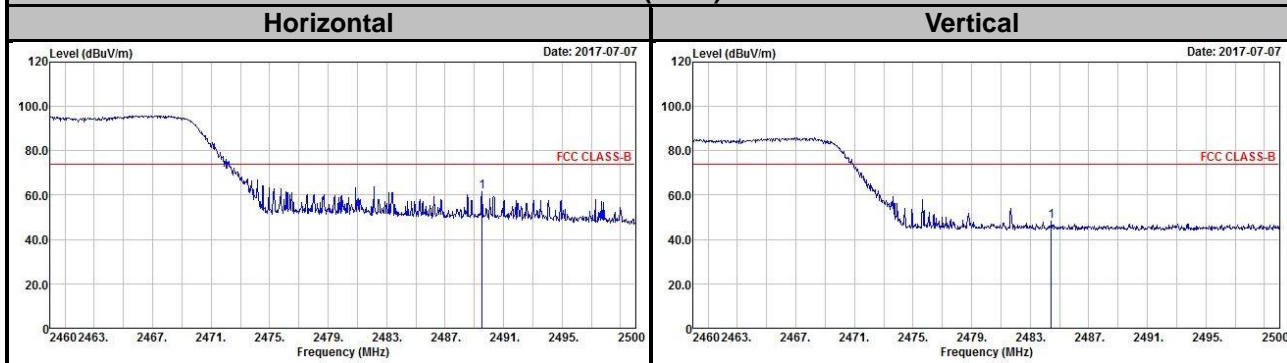

Ch 9 (Average)



## 5 Pictures of Test Arrangements

Please refer to the attached file (Test Setup Photo).

## Appendix – Information on the Testing Laboratories

We, Bureau Veritas Consumer Products Services (H.K.) Ltd., Taoyuan Branch, were founded in 1988 to provide our best service in EMC, Radio, Telecom and Safety consultation. Our laboratories are FCC recognized accredited test firms and accredited according to ISO/IEC 17025.

If you have any comments, please feel free to contact us at the following:

**Linko EMC/RF Lab**

Tel: 886-2-26052180

Fax: 886-2-26051924

**Hsin Chu EMC/RF/Telecom Lab**

Tel: 886-3-6668565

Fax: 886-3-6668323

**Hwa Ya EMC/RF/Safety Lab**

Tel: 886-3-3183232

Fax: 886-3-3270892

**Email:** [service.adt@tw.bureauveritas.com](mailto:service.adt@tw.bureauveritas.com)

**Web Site:** [www.bureauveritas-adt.com](http://www.bureauveritas-adt.com)

The address and road map of all our labs can be found in our web site also.

--- END ---