

FCC Test Report

Report No.: RF160518C01A-1 R1

FCC ID: A4R-G015A

Test Model: G015A

Received Date: Jun. 22, 2017

Test Date: Aug. 31, 2017 ~ Sep. 08, 2017

Issued Date: Oct. 17, 2017

Applicant: Google LLC

Address: 1600 Amphitheatre Parkway Mountain View, CA 94043 USA

Issued By: Bureau Veritas Consumer Products Services (H.K.) Ltd., Taoyuan Branch

Lab Address: No. 47-2, 14th Ling, Chia Pau Vil., Lin Kou Dist., New Taipei City, Taiwan
(R.O.C)

Test Location: No.19, Hwa Ya 2nd Rd., Wen Hwa Vil., Kwei Shan Dist., Taoyuan City
33383, Taiwan, R.O.C.



This report is for your exclusive use. Any copying or replication of this report to or for any other person or entity, or use of our name or trademark, is permitted only with our prior written permission. This report sets forth our findings solely with respect to the test samples identified herein. The results set forth in this report are not indicative or representative of the quality or characteristics of the lot from which a test sample was taken or any similar or identical product unless specifically and expressly noted. Our report includes all of the tests requested by you and the results thereof based upon the information that you provided to us. You have 60 days from date of issuance of this report to notify us of any material error or omission caused by our negligence, provided, however, that such notice shall be in writing and shall specifically address the issue you wish to raise. A failure to raise such issue within the prescribed time shall constitute your unqualified acceptance of the completeness of this report, the tests conducted and the correctness of the report contents. Unless specific mention, the uncertainty of measurement has been explicitly taken into account to declare the compliance or non-compliance to the specification. The report must not be used by the client to claim product certification, approval, or endorsement by TAF or any government agencies.

Table of Contents

Release Control Record	4
1 Certificate of Conformity	5
2 Summary of Test Results	6
2.1 Measurement Uncertainty	6
2.2 Modification Record	6
3 General Information	7
3.1 General Description of EUT	7
3.2 Description of Test Modes	8
3.2.1 Test Mode Applicability and Tested Channel Detail	9
3.3 Duty Cycle of Test Signal	11
3.4 Description of Support Units	12
3.4.1 Configuration of System under Test	12
3.5 General Description of Applied Standards	12
4 Test Types and Results	13
4.1 Radiated Emission and Bandedge Measurement	13
4.1.1 Limits of Radiated Emission and Bandedge Measurement	13
4.1.2 Limits of Unwanted Emission Out of the Restricted Bands	14
4.1.3 Test Instruments	15
4.1.4 Test Procedures	17
4.1.5 Deviation from Test Standard	17
4.1.6 Test Set Up	18
4.1.7 EUT Operating Conditions	19
4.1.8 Test Results	20
4.2 Conducted Emission Measurement	64
4.2.1 Limits of Conducted Emission Measurement	64
4.2.2 Test Instruments	64
4.2.3 Test Procedures	65
4.2.4 Deviation from Test Standard	65
4.2.5 Test Setup	65
4.2.6 EUT Operating Conditions	65
4.2.7 Test Results	66
4.3 Transmit Power Measurement	68
4.3.1 Limits of Transmit Power Measurement	68
4.3.2 Test Setup	68
4.3.3 Test Instruments	69
4.3.4 Test Procedure	69
4.3.5 Deviation from Test Standard	69
4.3.6 EUT Operating Conditions	69
4.3.7 Test Result	70
4.4 Occupied Bandwidth Measurement	73
4.4.1 Test Setup	73
4.4.2 Test Instruments	73
4.4.3 Test Procedure	73
4.4.4 Test Results	74
4.5 Peak Power Spectral Density Measurement	76
4.5.1 Limits of Peak Power Spectral Density Measurement	76
4.5.2 Test Setup	76
4.5.3 Test Instruments	76
4.5.4 Test Procedures	76
4.5.5 Deviation from Test Standard	77
4.5.6 EUT Operating Conditions	77
4.5.7 Test Results	78
4.6 Frequency Stability	82

4.6.1	Limit of Frequency Stability Measurement	82
4.6.2	Test Setup	82
4.6.3	Test Instruments	82
4.6.4	Test Procedure	82
4.6.5	Deviation from Test Standard	82
4.6.6	EUT Operating Condition	82
4.6.7	Test Results	83
4.7	6 dB Bandwidth Measurement.....	84
4.7.1	Limits of 6 dB Bandwidth Measurement.....	84
4.7.2	Test Setup.....	84
4.7.3	Test Instruments	84
4.7.4	Test Procedure	84
4.7.5	Deviation from Test Standard	84
4.7.6	EUT Operating Condition	84
4.7.7	Test Results	85
5	Pictures of Test Arrangements.....	87
	Annex A- Radiated Bandedge Plots.....	88
	Appendix – Information on the Testing Laboratories	91

Release Control Record

Issue No.	Description	Date Issued
RF160518C01A-1	Original Release	Sep. 13, 2017
RF160518C01A-1 R1	Revise information of applicant.	Oct. 17, 2017

1 Certificate of Conformity

Product: Wireless Device
Test Model: G015A
Sample Status: Identical Prototype
Applicant: Google LLC
Test Date: Aug. 31, 2017 ~ Sep. 08, 2017
Standards: 47 CFR FCC Part 15, Subpart E (Section 15.407)
ANSI C63.10:2013

The above equipment has been tested by **Bureau Veritas Consumer Products Services (H.K.) Ltd., Taoyuan Branch**, and found compliance with the requirement of the above standards. The test record, data evaluation & Equipment Under Test (EUT) configurations represented herein are true and accurate accounts of the measurements of the sample's EMC characteristics under the conditions specified in this report.

Prepared by : Rona Chen , **Date:** Oct. 17, 2017
Rona Chen / Specialist

Approved by : Dylan Chiou , **Date:** Oct. 17, 2017
Dylan Chiou / Project Engineer

2 Summary of Test Results

47 CFR FCC Part 15, Subpart E (Section 15.407)			
FCC Clause	Test Item	Result	Remarks
15.407(b)(6)	AC Power Conducted Emissions	Pass	Meet the requirement of limit. Minimum passing margin is -20.41 dB at 0.64220 MHz.
15.407(b) (1/2/3/4(i/ii)/6)	Radiated Emissions & Band Edge Measurement	Pass	Meet the requirement of limit. Minimum passing margin is -7.04 dB at 5149.1 MHz.
15.407(a)(1/2/3)	Max Average Transmit Power	Pass	Meet the requirement of limit.
---	Occupied Bandwidth Measurement	-	Reference only
15.407(a)(1/2/3)	Peak Power Spectral Density	Pass	Meet the requirement of limit.
15.407(e)	6 dB Bandwidth	Pass	Meet the requirement of limit. (U-NII-3 Band only)
15.407(g)	Frequency Stability	Pass	Meet the requirement of limit.
15.203	Antenna Requirement	Pass	No antenna connector is used.

2.1 Measurement Uncertainty

Where relevant, the following measurement uncertainty levels have been estimated for tests performed on the EUT as specified in CISPR 16-4-2:

Measurement	Frequency	Expanded Uncertainty (k=2) (±)
Conducted Emissions at mains ports	150 kHz ~ 30 MHz	2.44 dB
Radiated Emissions up to 1 GHz	30 MHz ~ 200 MHz	2.93 dB
	200 MHz ~ 1000 MHz	2.95 dB
Radiated Emissions above 1 GHz	1 GHz ~ 18 GHz	2.26 dB
	18 GHz ~ 40 GHz	1.94 dB

2.2 Modification Record

There were no modifications required for compliance.

3 General Information

3.1 General Description of EUT

Product	Wireless Device
Test Model	G015A
Status of EUT	Identical Prototype
Power Supply Rating	5.0 Vdc (adapter or host equipment) 3.8 Vdc (Li-ion battery)
Modulation Type	64QAM, 16QAM, QPSK, BPSK
Modulation Technology	OFDM
Transfer Rate	802.11a: 54.0/ 48.0/ 36.0/ 24.0/ 18.0/ 12.0/ 9.0/ 6.0 Mbps 802.11n: up to MCS7
Operating Frequency	5180 ~ 5240 MHz, 5745 ~ 5825 MHz
Number of Channel	5180 ~ 5240 MHz: 4 for 802.11a, 802.11n (HT20) 2 for 802.11n (HT40) 5745 ~ 5825 MHz: 5 for 802.11a, 802.11n (HT20) 2 for 802.11n (HT40)
Output Power	26.792 mW for 5180 ~ 5240 MHz 16.634 mW for 5745 ~ 5825 MHz
Antenna Type	Loop antenna with 2.98 dBi gain (5180 ~ 5240 MHz) Loop antenna with 3.15 dBi gain (5745 ~ 5825 MHz)
Antenna Connector	N/A
Accessory Device	Refer to Note as below
Data Cable Supplied	Refer to Note as below

Note:

1. The EUT provides 1 completed transmitter and 1 receiver.

Modulation Mode	Tx Function
802.11a	1TX
802.11n (HT20)	1TX
802.11n (HT40)	1TX

2. The EUT contains following accessory devices.

Product	Brand	Model	Description
USB Cable	FOXCONN	SD0EY3AD000	0.93 m shielded cable w/o core
Clip	N/A	N/A	--

3. The above EUT information is declared by manufacturer and for more detailed features description, please refer to the manufacturer's specifications or user's manual.

3.2 Description of Test Modes

For 5180 ~ 5240 MHz

4 channels are provided for 802.11a, 802.11n (HT20):

Channel	Frequency (MHz)	Channel	Frequency (MHz)
36	5180	44	5220
40	5200	48	5240

2 channels are provided for 802.11n (HT40):

Channel	Frequency (MHz)	Channel	Frequency (MHz)
38	5190	46	5230

For 5745 ~ 5825 MHz:

5 channels are provided for 802.11a, 802.11n (HT20):

Channel	Frequency (MHz)	Channel	Frequency (MHz)
149	5745	161	5805
153	5765	165	5825
157	5785		

2 channels are provided for 802.11n (HT40):

Channel	Frequency (MHz)	Channel	Frequency (MHz)
151	5755	159	5795

3.2.1 Test Mode Applicability and Tested Channel Detail

EUT Configure Mode	Applicable To				Description
	RE \geq 1G	RE $<$ 1G	PLC	APCM	
-	√	√	√	√	-

Where **RE \geq 1G**: Radiated Emission above 1 GHz **RE $<$ 1G**: Radiated Emission below 1 GHz
PLC: Power Line Conducted Emission **APCM**: Antenna Port Conducted Measurement

Note:

1. The EUT had been pre-tested on the positioned of each 3 axis. The worst case was found when positioned on **Z-plane**.

Pre-test Mode	Test Condition
A	EUT + USB Cable + Adapter
B	EUT + USB Cable + Notebook

* For Radiated Emission and Power Link Conducted Emission tests, the EUT has been verified on above test modes. The pre-test result of Mode A was worse. Therefore, only Mode A was chosen for final test and recorded in this report.

Radiated Emission Test (Above 1 GHz):

- Pre-Scan has been conducted to determine the worst-case mode from all possible combinations between available modulations, data rates and antenna ports (if EUT with antenna diversity architecture).
- Following channel(s) was (were) selected for the final test as listed below.

EUT Configure Mode	Frequency Band (MHz)	Mode	Available Channel	Tested Channel	Modulation Technology	Modulation Type	Data Rate (Mbps)
-	5180-5240	802.11a	36 to 48	36, 44, 48	OFDM	BPSK	6.0
-		802.11n (HT20)	36 to 48	36, 44, 48	OFDM	BPSK	MCS0
-		802.11n (HT40)	38 to 46	38, 46	38, 46	OFDM	BPSK
-	5745-5825	802.11a	149 to 165	149, 157, 165	OFDM	BPSK	6.0
-		802.11n (HT20)	149 to 165	149, 157, 165	OFDM	BPSK	MCS0
-		802.11n (HT40)	151 to 159	151, 159	151, 159	OFDM	BPSK

Radiated Emission Test (Below 1 GHz):

- Pre-Scan has been conducted to determine the worst-case mode from all possible combinations between available modulations, data rates and antenna ports (if EUT with antenna diversity architecture).
- Following channel(s) was (were) selected for the final test as listed below.

EUT Configure Mode	Frequency Band (MHz)	Mode	Available Channel	Tested Channel	Modulation Technology	Modulation Type	Data Rate (Mbps)
-	5180-5240	802.11n (HT40)	38 to 46	38	OFDM	BPSK	MCS0
-	5745-5825	802.11a	149 to 165	149	OFDM	BPSK	6.0

Power Line Conducted Emission Test:

- Pre-Scan has been conducted to determine the worst-case mode from all possible combinations between available modulations, data rates and antenna ports (if EUT with antenna diversity architecture).
- Following channel(s) was (were) selected for the final test as listed below.

EUT Configure Mode	Frequency Band (MHz)	Mode	Available Channel	Tested Channel	Modulation Technology	Modulation Type	Data Rate (Mbps)
-	5180-5240	802.11n (HT40)	38 to 46	38	OFDM	BPSK	MCS0

Antenna Port Conducted Measurement:

- This item includes all test value of each mode, but only includes spectrum plot of worst value of each mode.
- Pre-Scan has been conducted to determine the worst-case mode from all possible combinations between available modulations, data rates and antenna ports (if EUT with antenna diversity architecture).
- Following channel(s) was (were) selected for the final test as listed below.

EUT Configure Mode	Frequency Band (MHz)	Mode	Available Channel	Tested Channel	Modulation Technology	Modulation Type	Data Rate (Mbps)
-	5180-5240	802.11a	36 to 48	36, 44, 48	OFDM	BPSK	6.0
-		802.11n (HT20)	36 to 48	36, 44, 48	OFDM	BPSK	MCS0
-		802.11n (HT40)	38 to 46	38, 46	38, 46	OFDM	BPSK
-	5745-5825	802.11a	149 to 165	149, 157, 165	OFDM	BPSK	6.0
-		802.11n (HT20)	149 to 165	149, 157, 165	OFDM	BPSK	MCS0
-		802.11n (HT40)	151 to 159	151, 159	151, 159	OFDM	BPSK

Test Condition:

Applicable To	Environmental Conditions	Input Power	Tested by
RE \geq 1G	25 deg. C, 65 % RH	120 Vac, 60 Hz	Han Wu
RE<1G	25 deg. C, 65 % RH	120 Vac, 60 Hz	Han Wu
PLC	25 deg. C, 65 % RH	120 Vac, 60 Hz	Han Wu
APCM	25 deg. C, 65 % RH	3.8 Vdc	Anson Lin

3.3 Duty Cycle of Test Signal

MODULATION TYPE: BPSK

802.11a: Duty cycle = $3.102/7.129 = 0.435$, Duty factor = $10 * \log(1/0.435) = 3.61$

802.11n (HT20): Duty cycle = $4.760/11.360 = 0.419$, Duty factor = $10 * \log(1/0.419) = 3.78$

802.11n (HT40): Duty cycle = $2.310/11.330 = 0.204$, Duty factor = $10 * \log(1/0.204) = 6.91$

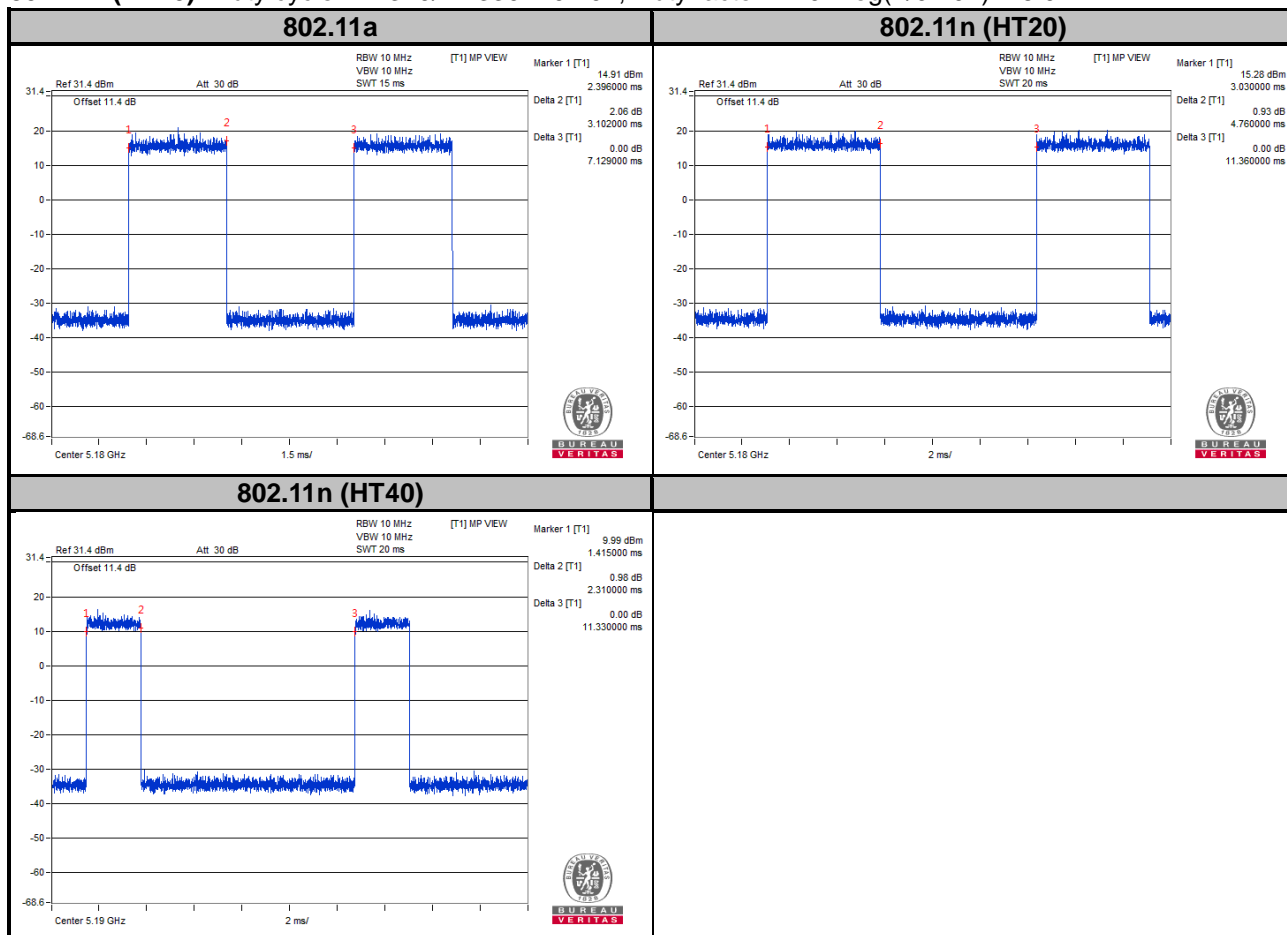

3.4 Description of Support Units

The EUT has been tested as an independent unit together with other necessary accessories or support units. The following support units or accessories were used to form a representative test configuration during the tests.

No.	Product	Brand	Model No.	Serial No.	FCC ID
1.	Adapter	N/A	N/A	N/A	N/A

No.	Signal Cable Description Of The Above Support Units
1.	N/A

Note:

1. All power cords of the above support units are non-shielded (1.8m).

3.4.1 Configuration of System under Test

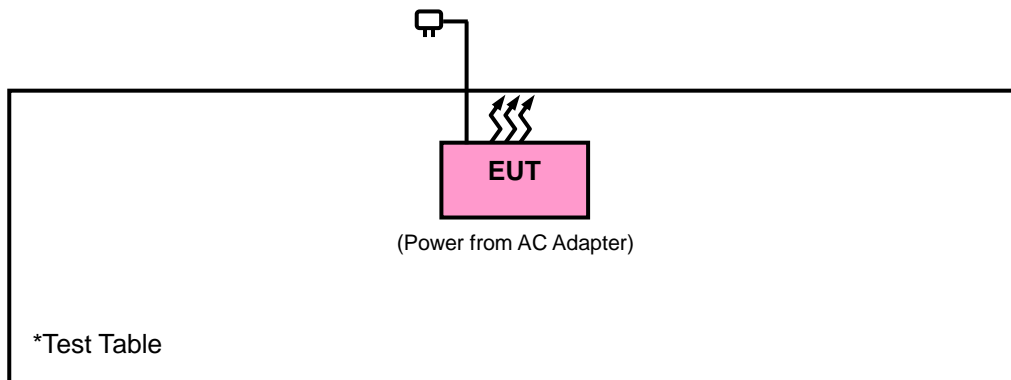

3.5 General Description of Applied Standards

The EUT is a RF Product. According to the specifications of the manufacturer, it must comply with the requirements of the following standards:

FCC Part 15, Subpart E (15.407)

789033 D02 General UNII Test Procedures New Rules v01r04

ANSI C63.10-2013

All test items have been performed and recorded as per the above standards.

Note: The EUT has been verified to comply with the requirements of FCC Part 15, Subpart B, Class B (DoC). The test report has been issued separately.

4 Test Types and Results

4.1 Radiated Emission and Bandedge Measurement

4.1.1 Limits of Radiated Emission and Bandedge Measurement

Radiated emissions which fall in the restricted bands must comply with the radiated emission limits specified as below table. Other emissions shall be at least 20 dB below the highest level of the desired power:

Frequencies (MHz)	Field Strength (microvolts/meter)	Measurement Distance (meters)
0.009 ~ 0.490	2400/F (kHz)	300
0.490 ~ 1.705	24000/F (kHz)	30
1.705 ~ 30.0	30	30
30 ~ 88	100	3
88 ~ 216	150	3
216 ~ 960	200	3
Above 960	500	3

Note:

1. The lower limit shall apply at the transition frequencies.
2. Emission level (dBuV/m) = 20 log Emission level (uV/m).
3. For frequencies above 1000 MHz, the field strength limits are based on average detector, however, the peak field strength of any emission shall not exceed the maximum permitted average limits, specified above by more than 20 dB under any condition of modulation.

4.1.2 Limits of Unwanted Emission Out of the Restricted Bands

Applicable To		Limit	
789033 D02 General UNII Test Procedures New Rules v01r04		Field Strength at 3 m	
		PK: 74 (dBµV/m)	AV: 54 (dBµV/m)
Frequency Band	Applicable To	EIRP Limit	Equivalent Field Strength at 3 m
5150~5250 MHz	15.407(b)(1)	PK: -27 (dBm/MHz)	PK: 68.2 (dBµV/m)
5250~5350 MHz	15.407(b)(2)		
5470~5725 MHz	15.407(b)(3)		
5725~5850 MHz	15.407(b)(4)(i)	PK:-27 (dBm/MHz) ^{*1} PK:10 (dBm/MHz) ^{*2} PK:15.6 (dBm/MHz) ^{*3} PK:27 (dBm/MHz) ^{*4}	PK: 68.2 (dBµV/m) ^{*1} PK:105.2 (dBµV/m) ^{*2} PK: 110.8 (dBµV/m) ^{*3} PK:122.2 (dBµV/m) ^{*4}
	15.407(b)(4)(ii)	Emission limits in section 15.247(d)	

^{*1} beyond 75 MHz or more above of the band edge.

^{*2} below the band edge increasing linearly to 10 dBm/MHz at 25 MHz above.

^{*3} below the band edge increasing linearly to a level of 15.6 dBm/MHz at 5 MHz above.

^{*4} from 5 MHz above or below the band edge increasing linearly to a level of 27 dBm/MHz at the band edge.

Note:

The following formula is used to convert the equipment isotropic radiated power (eirp) to field strength:

$$E = \frac{1000000\sqrt{30P}}{3} \mu\text{V/m, where P is the eirp (Watts).$$

4.1.3 Test Instruments

Description & Manufacturer	Model No.	Serial No.	Date of Calibration	Due Date of Calibration
Test Receiver Agilent	N9038A	MY51210203	Feb. 17, 2017	Feb. 16, 2018
Spectrum Analyzer Agilent	N9010A	MY52220314	Dec. 16, 2016	Dec. 15, 2017
Spectrum Analyzer ROHDE & SCHWARZ	FSU43	101261	Dec. 13, 2016	Dec. 12, 2017
BILOG Antenna SCHWARZBECK	VULB9168	9168-472	Dec. 26, 2016	Dec. 27, 2017
HORN Antenna SCHWARZBECK	BBHA 9120 D	9120D-969	Dec. 12, 2016	Dec. 13, 2017
HORN Antenna SCHWARZBECK	BBHA 9170	9170-480	Dec. 14, 2016	Dec. 13, 2017
Fixed Attenuator Mini-Circuits	MDCS18N-10	MDCS18N-10-01	Apr. 17, 2017	Apr. 16, 2018
Loop Antenna	HLA 6121	45745	May 19, 2017	May 18, 2018
Preamplifier EMCI	EMC001340	980201	Nov. 02, 2016	Nov. 01, 2017
Preamplifier EMCI	EMC 012645	980115	Oct. 21, 2016	Oct. 20, 2017
Preamplifier EMCI	EMC 184045	980116	Oct. 21, 2016	Oct. 20, 2017
Preamplifier EMCI	EMC 330H	980112	Oct. 21, 2016	Oct. 20, 2017
Power Meter Anritsu	ML2495A	1232002	Sep. 08, 2016	Sep. 07, 2017
Power Sensor Anritsu	MA2411B	1207325	Sep. 08, 2016	Sep. 07, 2017
RF signal cable HUBER+SUHNNER	SUCOFLEX 104	309219/4 2950114	Oct. 21, 2016	Oct. 20, 2017
RF signal cable HUBER+SUHNNER	SUCOFLEX 104	250130/4	Oct. 21, 2016	Oct. 20, 2017
RF Coaxial Cable Worken	8D-FB	Cable-Ch10-01	Oct. 21, 2016	Oct. 20, 2017
Software BV ADT	E3 6.120103	NA	NA	NA
Antenna Tower MF	MFA-440H	NA	NA	NA
Turn Table MF	MFT-201SS	NA	NA	NA
Antenna Tower & Turn Table Controller MF	MF-7802	NA	NA	NA
Temperature & Humidity Chamber	HRM-120RF	931022	Nov. 11, 2016	Nov. 10, 2017
DC Power Supply Topward	33010D	807748	Oct. 25, 2016	Oct. 24, 2018
Digital Multimeter Fluke	87-III	70360742	Jun. 30, 2017	Jun. 29, 2018

- Note:
1. The calibration interval of the above test instruments is 12 / 24 months and the calibrations are traceable to NML/ROC and NIST/USA.
 2. The test was performed in HwaYa Chamber 10.
 3. The horn antenna and preamplifier (model: EMC 184045) are used only for the measurement of emission frequency above 1 GHz if tested.
 4. The FCC Designation Number is TW0003. The number will be varied with the Lab location and scope as attached.
 5. The IC Site Registration No. is IC7450F-10.

4.1.4 Test Procedures

- a. The EUT was placed on the top of a rotating table 0.8 meters (for below 1 GHz) / 1.5 meters (for above 1 GHz) above the ground at 3 meter chamber room for test. The table was rotated 360 degrees to determine the position of the highest radiation.
- b. The EUT was set 3 meters away from the interference-receiving antenna, which was mounted on the top of a variable-height antenna tower.
- c. The height of antenna is varied from one meter to four meters above the ground to determine the maximum value of the field strength. Both horizontal and vertical polarizations of the antenna are set to make the measurement.
- d. For each suspected emission, the EUT was arranged to its worst case and then the antenna was tuned to heights from 1 meter to 4 meters and the rotatable table was turned from 0 degrees to 360 degrees to find the maximum reading.
- e. The test-receiver system was set to quasi-peak detect function and specified bandwidth with maximum hold mode when the test frequency is below 1 GHz.
- f. The test-receiver system was set to peak and average detected function and specified bandwidth with maximum hold mode when the test frequency is above 1 GHz. If the peak reading value also meets average limit, measurement with the average detector is unnecessary.

Note:

1. The resolution bandwidth and video bandwidth of test receiver/spectrum analyzer is 120 kHz & 360 kHz for Quasi-peak detection (QP) at frequency below 1 GHz.
2. The resolution bandwidth of test receiver/spectrum analyzer is 1 MHz and the video bandwidth is 3 MHz for Peak detection (PK) at frequency above 1 GHz.
3. The resolution bandwidth of test receiver/spectrum analyzer is 1 MHz and the video bandwidth is 1/T for Average (Duty cycle < 98 %) detection at frequency above 1 GHz.
4. The resolution bandwidth of test receiver/spectrum analyzer is 1 MHz and the video bandwidth is 10 Hz (Duty cycle ≥ 98 %) for Average detection (AV) at frequency above 1 GHz.
5. All modes of operation were investigated and the worst-case emissions are reported.

Test Setting	
Bandedge Emissions	RBW / VBW
(Non-restricted Band)	100kHz / 300kHz
(Restricted Band)	Average: 1MHz / 1kHz Peak: 1MHz / 3MHz

4.1.5 Deviation from Test Standard

No deviation.

4.1.6 Test Set Up

<Radiated emission below 30MHz>

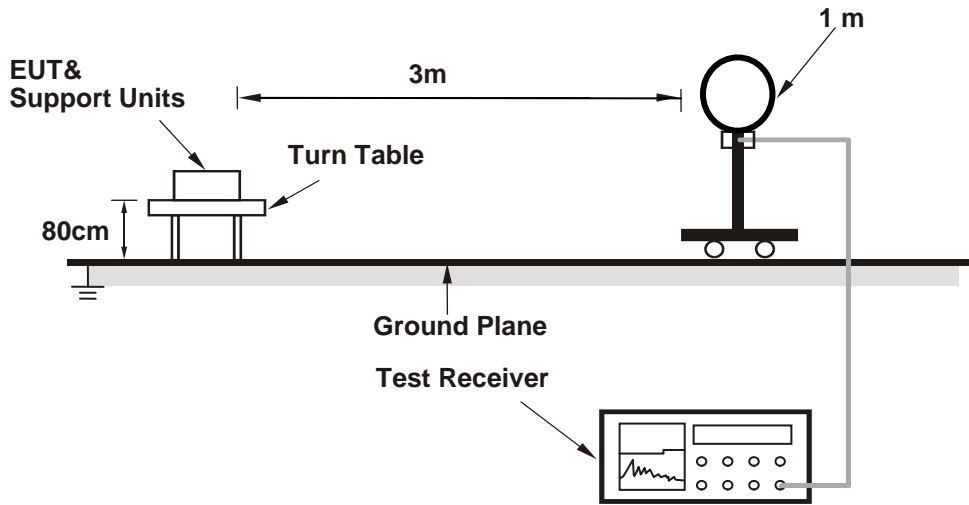

<Frequency Range below 1 GHz>

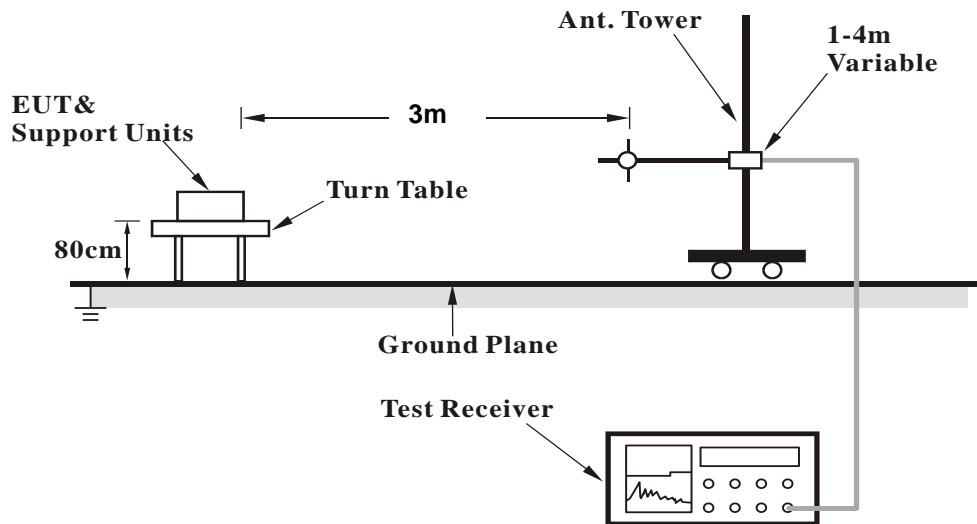

<Frequency Range above 1 GHz>

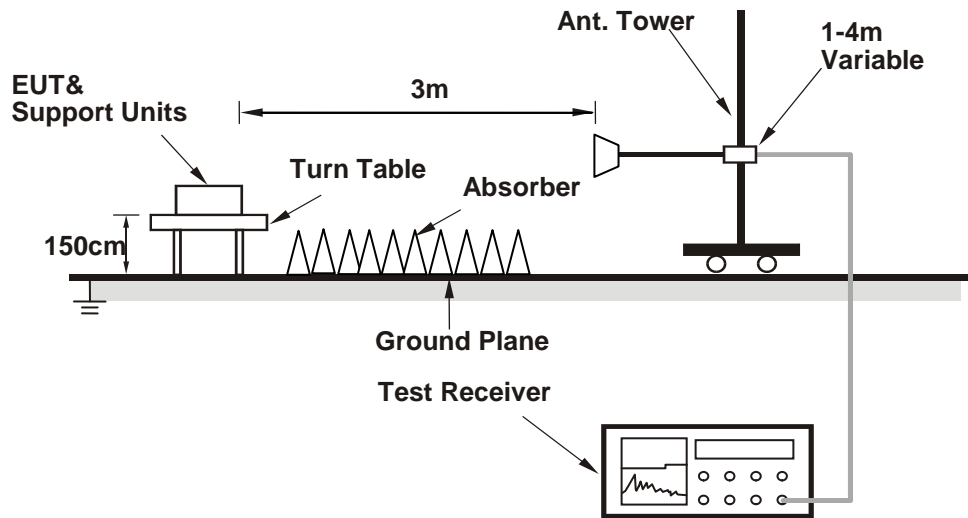

For the actual test configuration, please refer to the attached file (Test Setup Photo).

4.1.7 EUT Operating Conditions

- a. Placed the EUT on a testing table.
- b. Use the software to control the EUT under transmission condition continuously at specific channel frequency.

4.1.8 Test Results
 Above 1 GHz Data :
 802.11a

EUT Test Condition		Measurement Detail	
Channel	Channel 36	Frequency Range	1 GHz ~ 40 GHz
Input Power	120 Vac, 60 Hz	Detector Function	Peak (PK) Average (AV)
Environmental Conditions	25 deg. C, 65 % RH	Tested By	Han Wu

Horizontal

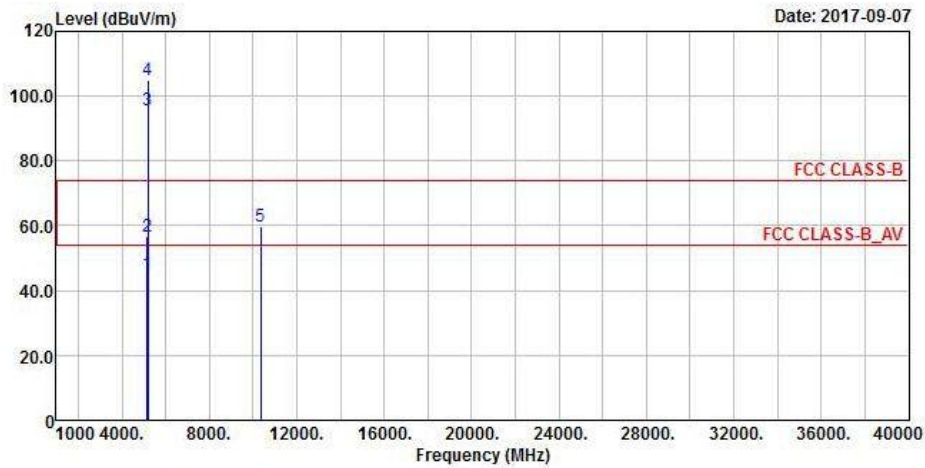

Vertical

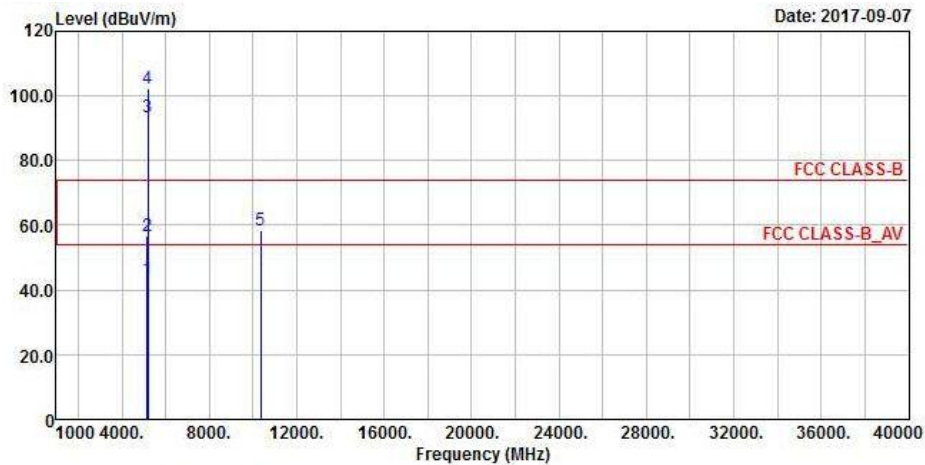

Antenna Polarity & Test Distance: Horizontal at 3 m

Frequency (MHz)	Emission Level (dBuV/m)	Read Level (dBuV)	Limit (dBuV/m)	Margin (dB)	Antenna Factor (dB/m)	Cable Loss (dB)	Preamp Factor (dB)	Antenna Height (cm)	Table Angle (Degree)	Remark
5150	44.96	44.62	54	-9.04	31.32	6.34	37.32	198	153	Average
5150	56.89	56.55	74	-17.11	31.32	6.34	37.32	198	153	Peak
5180	95.59	95.21			31.35	6.37	37.34	198	153	Average
5180	105	104.62			31.35	6.37	37.34	198	153	Peak
*10360	59.58	62.63	68.2	-8.62	39.19	10.21	52.45	180	109	Peak

Antenna Polarity & Test Distance: Vertical at 3 m

Frequency (MHz)	Emission Level (dBuV/m)	Read Level (dBuV)	Limit (dBuV/m)	Margin (dB)	Antenna Factor (dB/m)	Cable Loss (dB)	Preamp Factor (dB)	Antenna Height (cm)	Table Angle (Degree)	Remark
5150	43.21	42.87	54	-10.79	31.32	6.34	37.32	199	267	Average
5150	56.49	56.15	74	-17.51	31.32	6.34	37.32	199	267	Peak
5180	93.45	93.07			31.35	6.37	37.34	199	267	Average
5180	102.47	102.09			31.35	6.37	37.34	199	267	Peak
*10360	58.55	61.29	68.2	-9.65	39.19	10.21	52.14	163	85	Peak

Remarks:

- Emission Level = Read Level + Antenna Factor + Cable Loss - Preamp Factor
Margin value = Emission level – Limit value
- 5180 MHz: Fundamental Frequency
- *: Out of Restricted Band

EUT Test Condition		Measurement Detail	
Channel	Channel 44	Frequency Range	1 GHz ~ 40 GHz
Input Power	120 Vac, 60 Hz	Detector Function	Peak (PK) Average (AV)
Environmental Conditions	25 deg. C, 65 % RH	Tested By	Han Wu

Horizontal

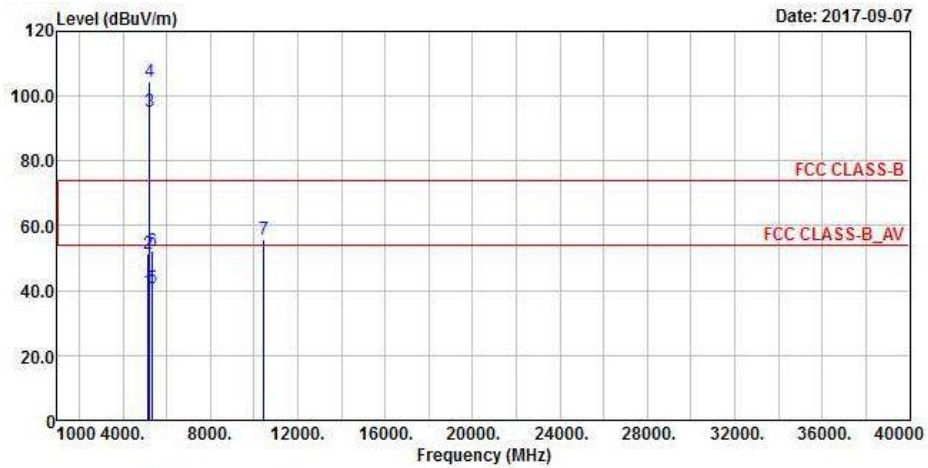

Vertical

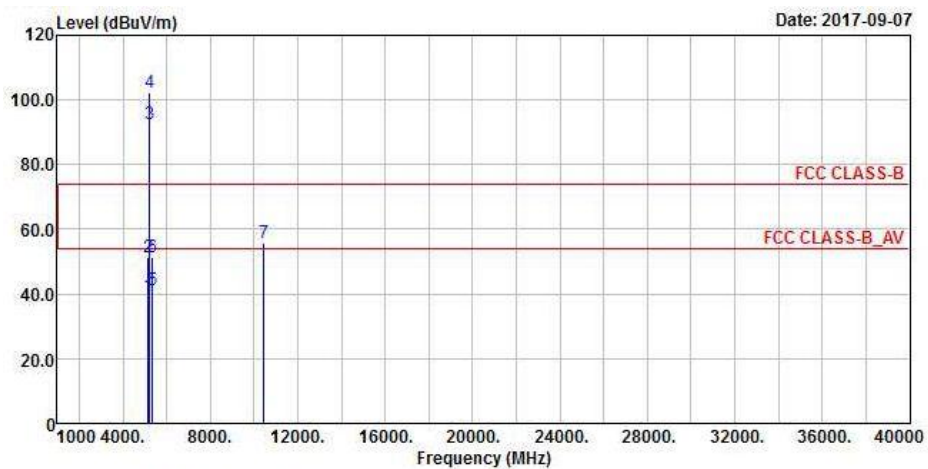

Antenna Polarity & Test Distance: Horizontal at 3 m

Frequency (MHz)	Emission Level (dBuV/m)	Read Level (dBuV)	Limit (dBuV/m)	Margin (dB)	Antenna Factor (dB/m)	Cable Loss (dB)	Preamp Factor (dB)	Antenna Height (cm)	Table Angle (Degree)	Remark
5150	39.94	39.6	54	-14.06	31.32	6.34	37.32	200	152	Average
5150	51.58	51.24	74	-22.42	31.32	6.34	37.32	200	152	Peak
5220	95.27	94.86			31.37	6.4	37.36	200	152	Average
5220	104.45	104.04			31.37	6.4	37.36	200	152	Peak
5350	40.66	39.89	54	-13.34	31.48	6.47	37.18	200	152	Average
5350	52.2	51.43	74	-21.8	31.48	6.47	37.18	200	152	Peak
*10440	55.9	58.92	68.2	-12.3	39.29	10.21	52.52	129	187	Peak

Antenna Polarity & Test Distance: Vertical at 3 m

Frequency (MHz)	Emission Level (dBuV/m)	Read Level (dBuV)	Limit (dBuV/m)	Margin (dB)	Antenna Factor (dB/m)	Cable Loss (dB)	Preamp Factor (dB)	Antenna Height (cm)	Table Angle (Degree)	Remark
5150	39.33	38.99	54	-14.67	31.32	6.34	37.32	198	268	Average
5150	51.31	50.97	74	-22.69	31.32	6.34	37.32	198	268	Peak
5220	92.74	92.33			31.37	6.4	37.36	198	268	Average
5220	102.4	101.99			31.37	6.4	37.36	198	268	Peak
5350	41.15	40.38	54	-12.85	31.48	6.47	37.18	198	268	Average
5350	51.26	50.49	74	-22.74	31.48	6.47	37.18	198	268	Peak
*10440	55.83	58.81	68.2	-12.37	39.29	10.21	52.48	197	171	Peak

Remarks:

- Emission Level = Read Level + Antenna Factor + Cable Loss - Preamp Factor
Margin value = Emission level – Limit value
- 5220 MHz: Fundamental Frequency
- *: Out of Restricted Band

EUT Test Condition		Measurement Detail	
Channel	Channel 48	Frequency Range	1 GHz ~ 40 GHz
Input Power	120 Vac, 60 Hz	Detector Function	Peak (PK) Average (AV)
Environmental Conditions	25 deg. C, 65 % RH	Tested By	Han Wu

Horizontal

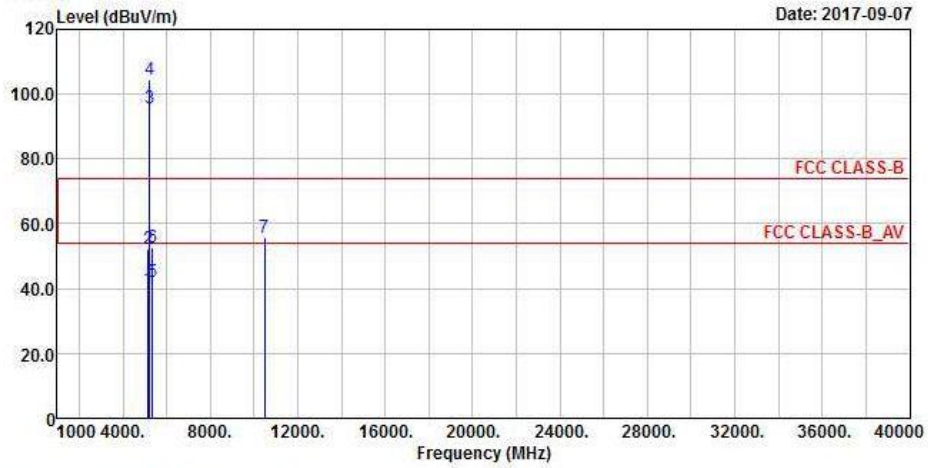

Vertical

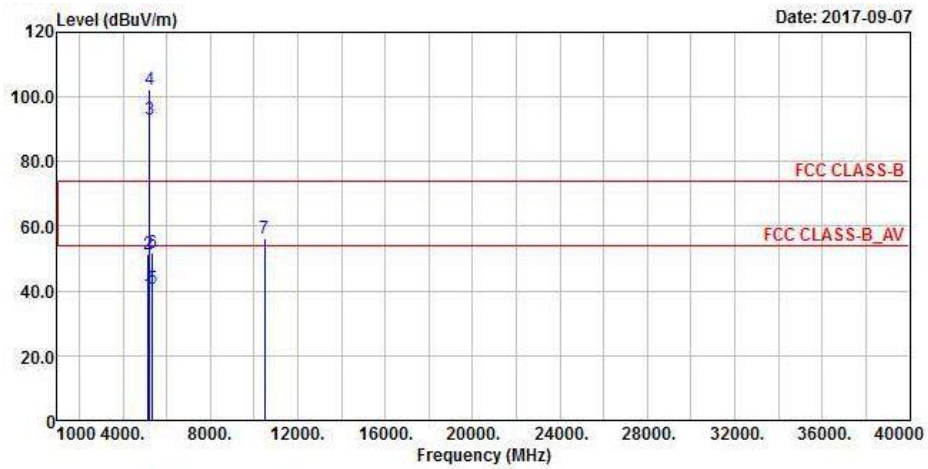

Antenna Polarity & Test Distance: Horizontal at 3 m

Frequency (MHz)	Emission Level (dBuV/m)	Read Level (dBuV)	Limit (dBuV/m)	Margin (dB)	Antenna Factor (dB/m)	Cable Loss (dB)	Preamp Factor (dB)	Antenna Height (cm)	Table Angle (Degree)	Remark
5150	39.8	39.46	54	-14.2	31.32	6.34	37.32	199	150	Average
5150	52.42	52.08	74	-21.58	31.32	6.34	37.32	199	150	Peak
5240	95.55	95.06			31.39	6.42	37.32	199	150	Average
5240	104.28	103.79			31.39	6.42	37.32	199	150	Peak
5350	42.12	41.35	54	-11.88	31.48	6.47	37.18	199	150	Average
5350	52.78	52.01	74	-21.22	31.48	6.47	37.18	199	150	Peak
*10480	55.77	58.84	68.2	-12.43	39.37	10.22	52.66	184	85	Peak

Antenna Polarity & Test Distance: Vertical at 3 m

Frequency (MHz)	Emission Level (dBuV/m)	Read Level (dBuV)	Limit (dBuV/m)	Margin (dB)	Antenna Factor (dB/m)	Cable Loss (dB)	Preamp Factor (dB)	Antenna Height (cm)	Table Angle (Degree)	Remark
5150	39.11	38.77	54	-14.89	31.32	6.34	37.32	197	270	Average
5150	51.43	51.09	74	-22.57	31.32	6.34	37.32	197	270	Peak
5240	93.07	92.58			31.39	6.42	37.32	197	270	Average
5240	102.36	101.87			31.39	6.42	37.32	197	270	Peak
5350	40.72	39.95	54	-13.28	31.48	6.47	37.18	197	270	Average
5350	51.92	51.15	74	-22.08	31.48	6.47	37.18	197	270	Peak
*10480	56.19	59.31	68.2	-12.01	39.37	10.22	52.71	117	0	Peak

Remarks:

- Emission Level = Read Level + Antenna Factor + Cable Loss - Preamp Factor
Margin value = Emission level – Limit value
- 5240 MHz: Fundamental Frequency
- *: Out of Restricted Band

EUT Test Condition		Measurement Detail	
Channel	Channel 149	Frequency Range	1 GHz ~ 40 GHz
Input Power	120 Vac, 60 Hz	Detector Function	Peak (PK) Average (AV)
Environmental Conditions	25 deg. C, 65 % RH	Tested By	Han Wu

**<Spurious Emission>
Horizontal**

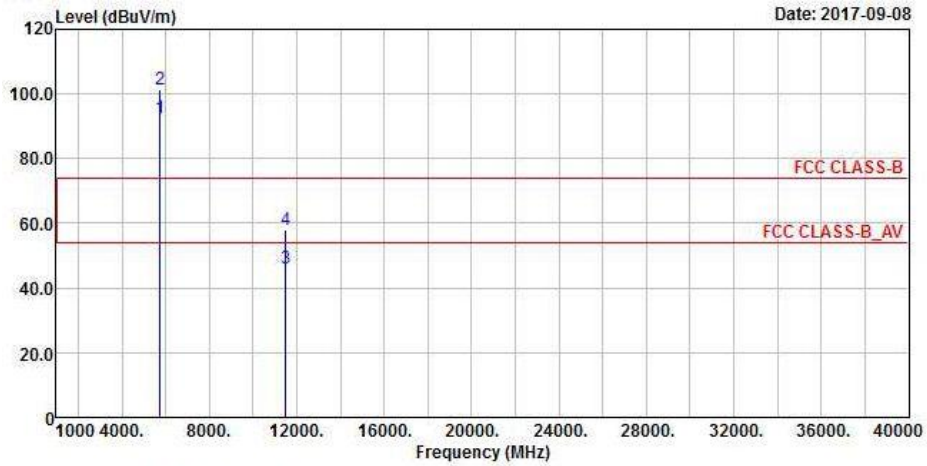

Vertical

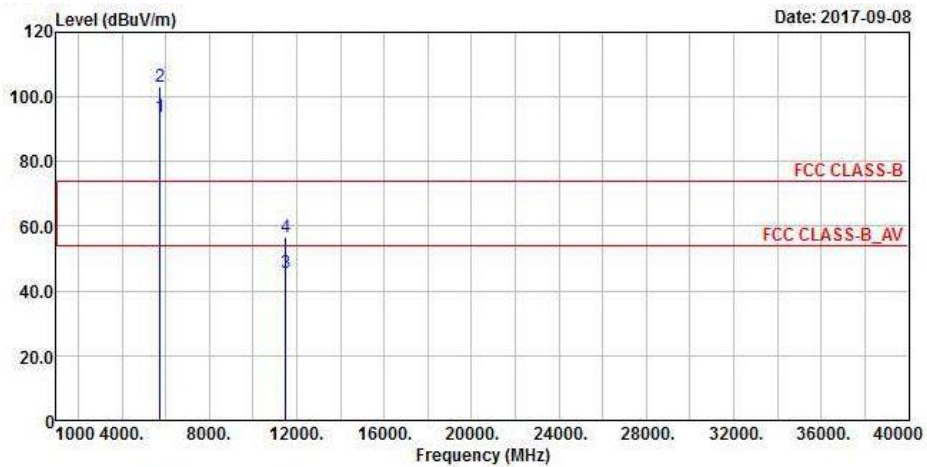

**<Out of Band Emission (OOBE)>
Horizontal**

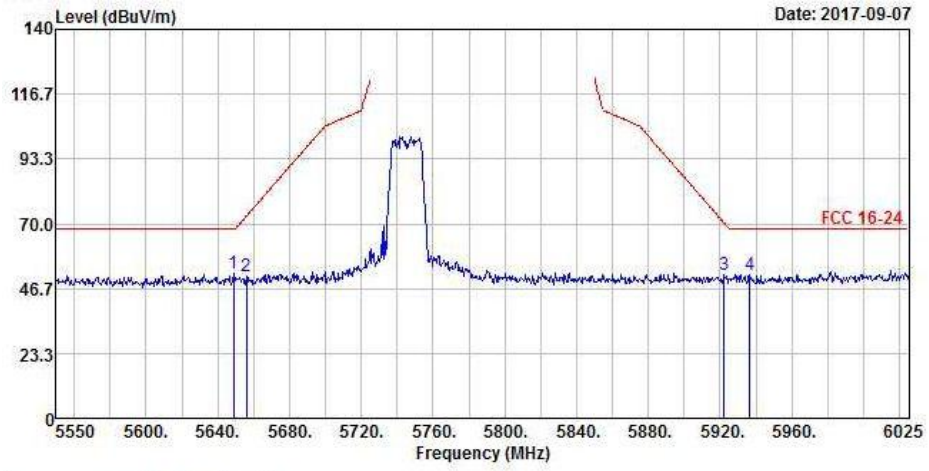

Vertical

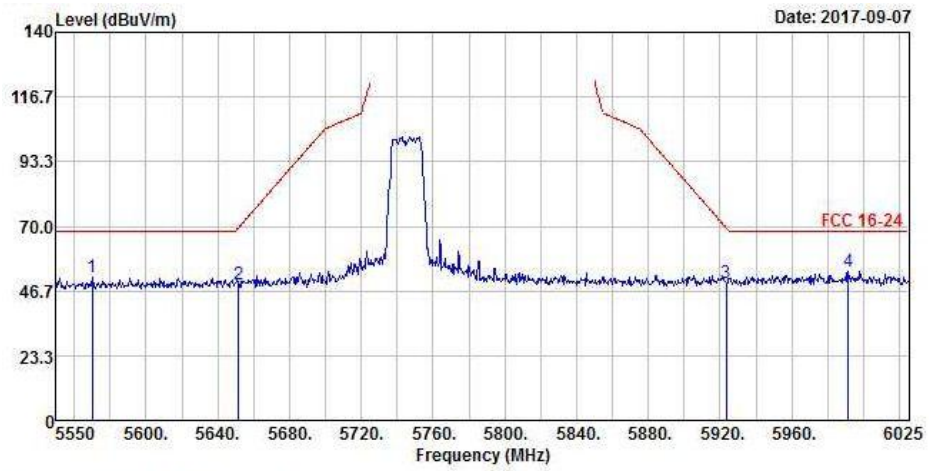

<Spurious Emission>

Antenna Polarity & Test Distance: Horizontal at 3 m										
Frequency (MHz)	Emission Level (dBuV/m)	Read Level (dBuV)	Limit (dBuV/m)	Margin (dB)	Antenna Factor (dB/m)	Cable Loss (dB)	Preamp Factor (dB)	Antenna Height (cm)	Table Angle (Degree)	Remark
5745	92.57	91.27			31.99	6.78	37.47	198	153	Average
5745	101.59	100.29			31.99	6.78	37.47	198	153	Peak
11490	45.97	48.18	54	-8.03	39.91	10.66	52.78	173	341	Average
11490	58.03	60.24	74	-15.97	39.91	10.66	52.78	173	341	Peak
Antenna Polarity & Test Distance: Vertical at 3 m										
Frequency (MHz)	Emission Level (dBuV/m)	Read Level (dBuV)	Limit (dBuV/m)	Margin (dB)	Antenna Factor (dB/m)	Cable Loss (dB)	Preamp Factor (dB)	Antenna Height (cm)	Table Angle (Degree)	Remark
5745	93.76	92.49			31.99	6.75	37.47	207	260	Average
5745	103.09	101.82			31.99	6.75	37.47	207	260	Peak
11490	45.4	47.66	54	-8.6	39.91	10.66	52.83	118	28	Average
11490	56.9	59.16	74	-17.1	39.91	10.66	52.83	118	28	Peak

<Out of Band Emission (OOBE)>

Antenna Polarity & Test Distance: Horizontal at 3 m										
Frequency (MHz)	Emission Level (dBuV/m)	Read Level (dBuV)	Limit (dBuV/m)	Margin (dB)	Antenna Factor (dB/m)	Cable Loss (dB)	Preamp Factor (dB)	Antenna Height (cm)	Table Angle (Degree)	Remark
5648.8	52.15	50.99	68.2	-16.05	31.82	6.62	37.28	198	153	Peak
5655.925	50.9	49.77	72.6	-21.7	31.85	6.62	37.34	198	153	Peak
5922.4	51.54	49.74	70.12	-18.58	32.29	7.01	37.5	198	153	Peak
5936.65	51.58	49.78	68.2	-16.62	32.29	7.01	37.5	198	153	Peak
Antenna Polarity & Test Distance: Vertical at 3 m										
Frequency (MHz)	Emission Level (dBuV/m)	Read Level (dBuV)	Limit (dBuV/m)	Margin (dB)	Antenna Factor (dB/m)	Cable Loss (dB)	Preamp Factor (dB)	Antenna Height (cm)	Table Angle (Degree)	Remark
5569.95	51.77	50.69	68.2	-16.43	31.71	6.49	37.12	207	260	Peak
5651.65	49.24	48.05	69.43	-20.19	31.85	6.62	37.28	207	260	Peak
5923.35	49.45	47.65	69.42	-19.97	32.29	7.01	37.5	207	260	Peak
5991.275	53.98	51.95	68.2	-14.22	32.4	7.14	37.51	207	260	Peak

Remarks:

- Emission Level = Read Level + Antenna Factor + Cable Loss - Preamp Factor
Margin value = Emission level – Limit value
- 5745 MHz: Fundamental Frequency
- *: Out of Restricted Band

EUT Test Condition		Measurement Detail	
Channel	Channel 157	Frequency Range	1 GHz ~ 40 GHz
Input Power	120 Vac, 60 Hz	Detector Function	Peak (PK) Average (AV)
Environmental Conditions	25 deg. C, 65 % RH	Tested By	Han Wu

**<Spurious Emission>
Horizontal**

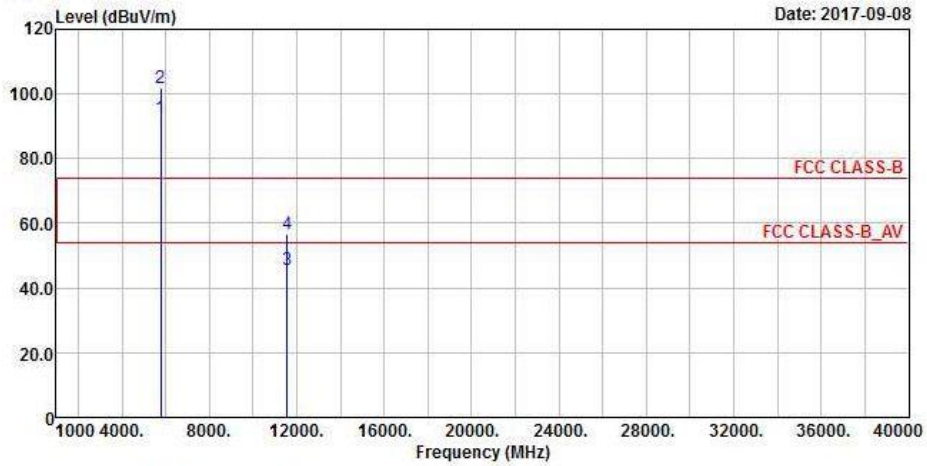

Vertical

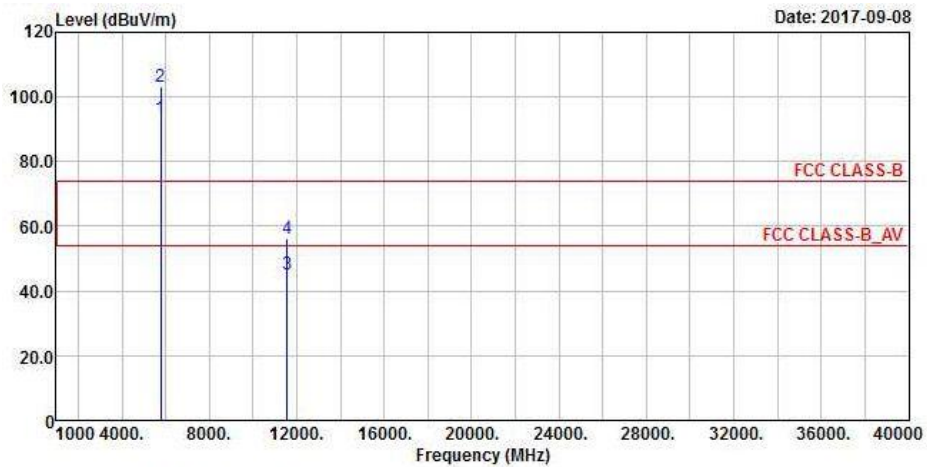

**<Out of Band Emission (OOBE)>
Horizontal**

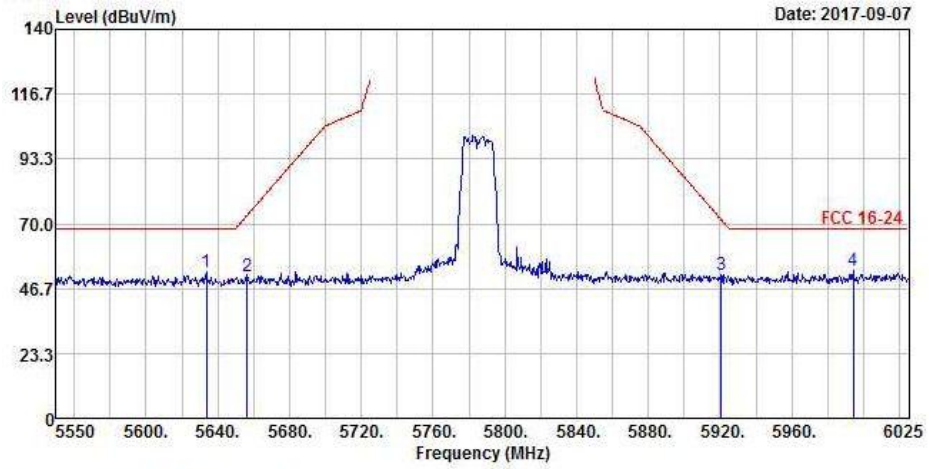

Vertical

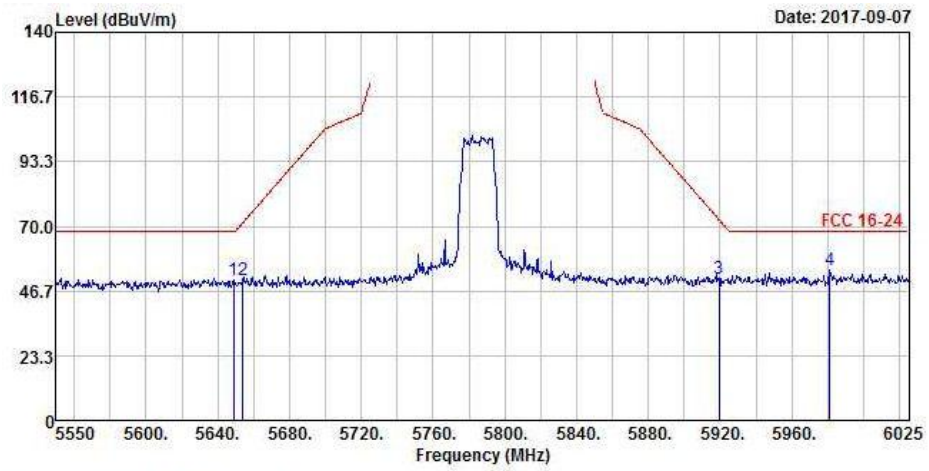

<Spurious Emission>

Antenna Polarity & Test Distance: Horizontal at 3 m										
Frequency (MHz)	Emission Level (dBuV/m)	Read Level (dBuV)	Limit (dBuV/m)	Margin (dB)	Antenna Factor (dB/m)	Cable Loss (dB)	Preamp Factor (dB)	Antenna Height (cm)	Table Angle (Degree)	Remark
5785	92.61	91.29			32.04	6.82	37.54	195	151	Average
5785	101.96	100.64			32.04	6.82	37.54	195	151	Peak
11570	45.62	48.09	54	-8.38	39.78	10.76	53.01	199	147	Average
11570	56.52	58.99	74	-17.48	39.78	10.76	53.01	119	147	Peak
Antenna Polarity & Test Distance: Vertical at 3 m										
Frequency (MHz)	Emission Level (dBuV/m)	Read Level (dBuV)	Limit (dBuV/m)	Margin (dB)	Antenna Factor (dB/m)	Cable Loss (dB)	Preamp Factor (dB)	Antenna Height (cm)	Table Angle (Degree)	Remark
5785	93.65	92.33			32.04	6.82	37.54	206	260	Average
5785	103.39	102.07			32.04	6.82	37.54	206	260	Peak
11570	45.09	47.88	54	-8.91	39.78	10.76	53.33	207	159	Average
11570	56.42	59.21	74	-17.58	39.78	10.76	53.33	207	159	Peak

<Out of Band Emission (OOBE)>

Antenna Polarity & Test Distance: Horizontal at 3 m										
Frequency (MHz)	Emission Level (dBuV/m)	Read Level (dBuV)	Limit (dBuV/m)	Margin (dB)	Antenna Factor (dB/m)	Cable Loss (dB)	Preamp Factor (dB)	Antenna Height (cm)	Table Angle (Degree)	Remark
5633.6	52.55	51.45	68.2	-15.65	31.82	6.56	37.28	195	151	Peak
5656.4	50.9	49.77	72.95	-22.05	31.85	6.62	37.34	195	151	Peak
5920.5	51.74	49.97	71.52	-19.78	32.26	7.01	37.5	195	151	Peak
5994.13	53.01	50.98	68.2	-15.19	32.4	7.14	37.51	195	151	Peak
Antenna Polarity & Test Distance: Vertical at 3 m										
Frequency (MHz)	Emission Level (dBuV/m)	Read Level (dBuV)	Limit (dBuV/m)	Margin (dB)	Antenna Factor (dB/m)	Cable Loss (dB)	Preamp Factor (dB)	Antenna Height (cm)	Table Angle (Degree)	Remark
5648.8	50.37	49.21	68.2	-17.83	31.82	6.62	37.28	206	260	Peak
5654.03	50.75	49.62	71.19	-20.44	31.85	6.62	37.34	206	260	Peak
5919.55	51.32	49.55	72.22	-20.9	32.26	7.01	37.50	206	260	Peak
5981.3	54.45	52.51	68.2	-13.75	32.37	7.08	37.51	206	260	Peak

Remarks:

- Emission Level = Read Level + Antenna Factor + Cable Loss - Preamp Factor
Margin value = Emission level – Limit value
- 5785 MHz: Fundamental Frequency
- *: Out of Restricted Band

EUT Test Condition		Measurement Detail	
Channel	Channel 165	Frequency Range	1 GHz ~ 40 GHz
Input Power	120 Vac, 60 Hz	Detector Function	Peak (PK) Average (AV)
Environmental Conditions	25 deg. C, 65 % RH	Tested By	Han Wu

**<Spurious Emission>
Horizontal**

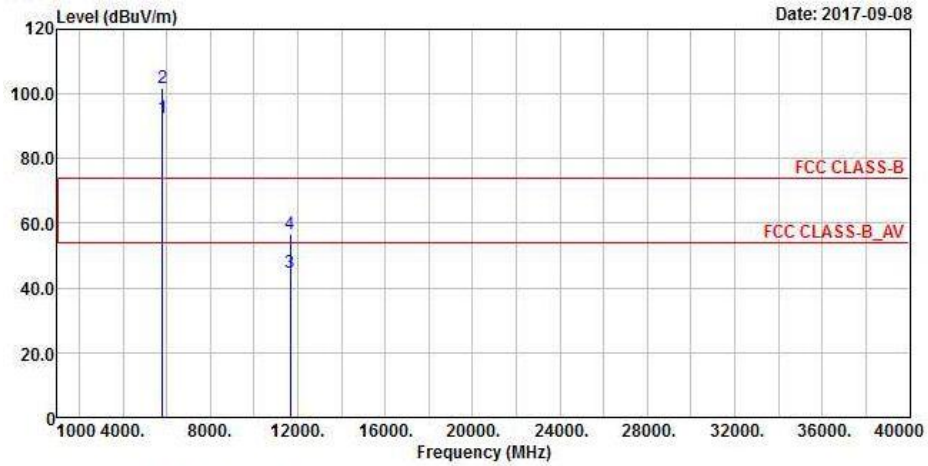

Vertical

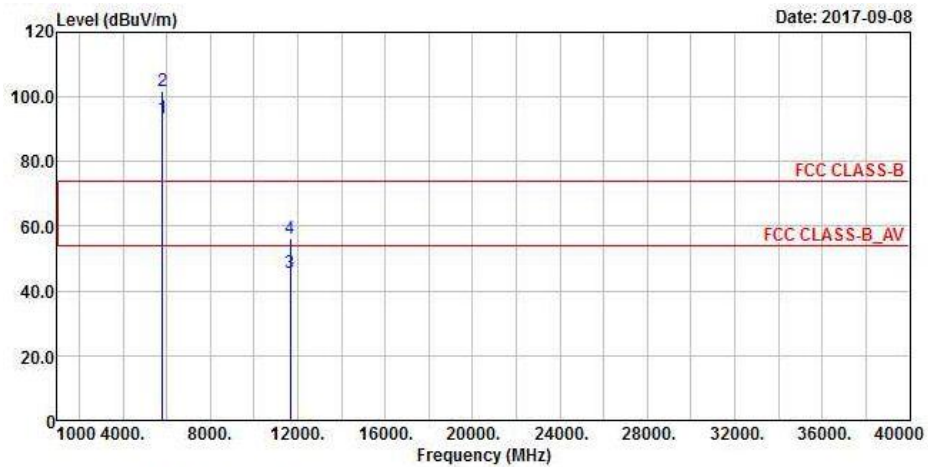

<Out of Band Emission (OOBE)>
Horizontal

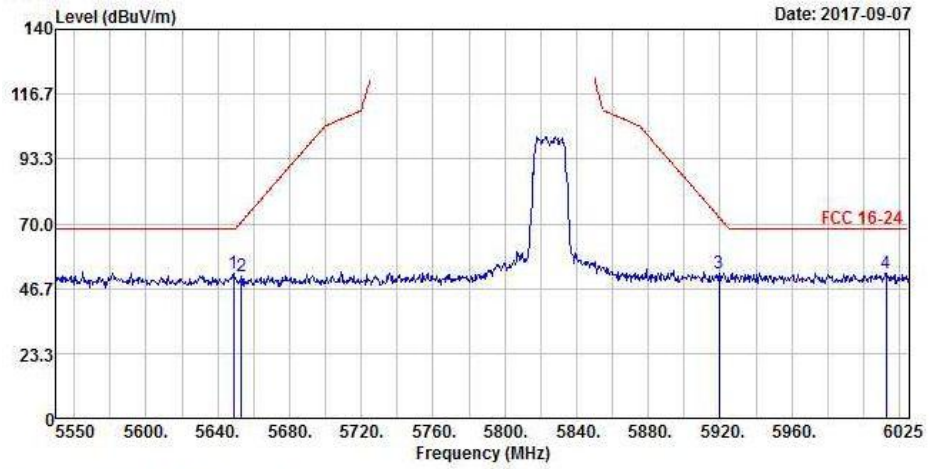

Vertical

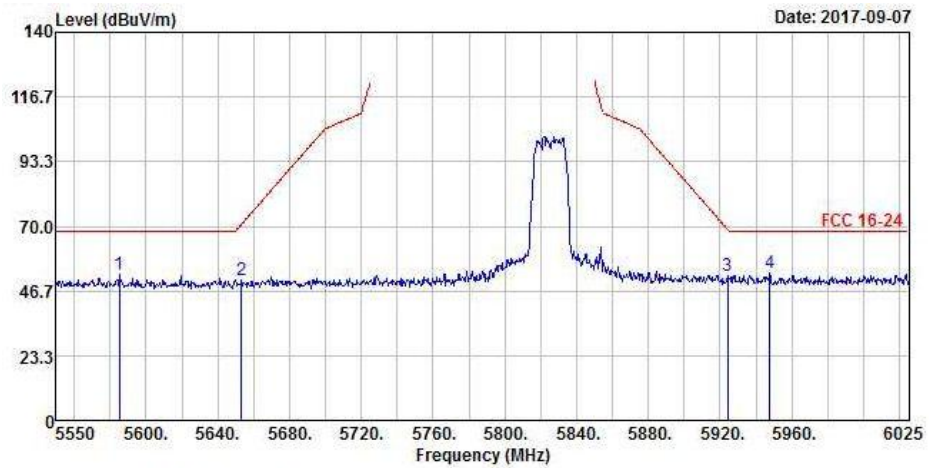

<Spurious Emission>

Antenna Polarity & Test Distance: Horizontal at 3 m										
Frequency (MHz)	Emission Level (dBuV/m)	Read Level (dBuV)	Limit (dBuV/m)	Margin (dB)	Antenna Factor (dB/m)	Cable Loss (dB)	Preamp Factor (dB)	Antenna Height (cm)	Table Angle (Degree)	Remark
5825	92.54	91.07			32.12	6.88	37.53	193	153	Average
5825	101.98	100.51			32.12	6.88	37.53	193	153	Peak
11650	44.82	47.51	54	-9.18	39.65	10.8	53.14	198	67	Average
11650	56.48	59.17	74	-17.52	39.65	10.8	53.14	198	67	Peak
Antenna Polarity & Test Distance: Vertical at 3 m										
Frequency (MHz)	Emission Level (dBuV/m)	Read Level (dBuV)	Limit (dBuV/m)	Margin (dB)	Antenna Factor (dB/m)	Cable Loss (dB)	Preamp Factor (dB)	Antenna Height (cm)	Table Angle (Degree)	Remark
5825	93.3	91.83			32.12	6.88	37.53	201	241	Average
5825	101.93	100.46			32.12	6.88	37.53	201	241	Peak
11650	45.56	48.46	54	-8.44	39.65	10.8	53.35	230	89	Average
11650	56.3	59.2	74	-17.7	39.65	10.8	53.35	230	89	Peak

<Out of Band Emission (OOBE)>

Antenna Polarity & Test Distance: Horizontal at 3 m										
Frequency (MHz)	Emission Level (dBuV/m)	Read Level (dBuV)	Limit (dBuV/m)	Margin (dB)	Antenna Factor (dB/m)	Cable Loss (dB)	Preamp Factor (dB)	Antenna Height (cm)	Table Angle (Degree)	Remark
5648.8	52.12	50.96	68.2	-16.08	31.82	6.62	37.28	193	153	Peak
5653.075	50.96	49.77	70.49	-19.53	31.85	6.62	37.28	193	153	Peak
5919.55	52.05	50.28	72.22	-20.17	32.26	7.01	37.5	193	153	Peak
6012.65	52.36	50.27	68.2	-15.84	32.45	7.14	37.5	193	153	Peak
Antenna Polarity & Test Distance: Vertical at 3 m										
Frequency (MHz)	Emission Level (dBuV/m)	Read Level (dBuV)	Limit (dBuV/m)	Margin (dB)	Antenna Factor (dB/m)	Cable Loss (dB)	Preamp Factor (dB)	Antenna Height (cm)	Table Angle (Degree)	Remark
5585.15	52.95	51.88	68.2	-15.25	31.74	6.49	37.16	201	241	Peak
5653.075	50.5	49.31	70.49	-19.99	31.85	6.62	37.28	201	241	Peak
5924.3	52.03	50.23	68.72	-16.69	32.29	7.01	37.5	201	241	Peak
5947.575	53.06	51.16	68.2	-15.14	32.32	7.08	37.5	201	241	Peak

Remarks:

- Emission Level = Read Level + Antenna Factor + Cable Loss - Preamp Factor
Margin value = Emission level – Limit value
- 5825 MHz: Fundamental Frequency
- *: Out of Restricted Band

802.11n (HT20)

EUT Test Condition		Measurement Detail	
Channel	Channel 36	Frequency Range	1 GHz ~ 40 GHz
Input Power	120 Vac, 60 Hz	Detector Function	Peak (PK) Average (AV)
Environmental Conditions	25 deg. C, 65 % RH	Tested By	Han Wu

Horizontal

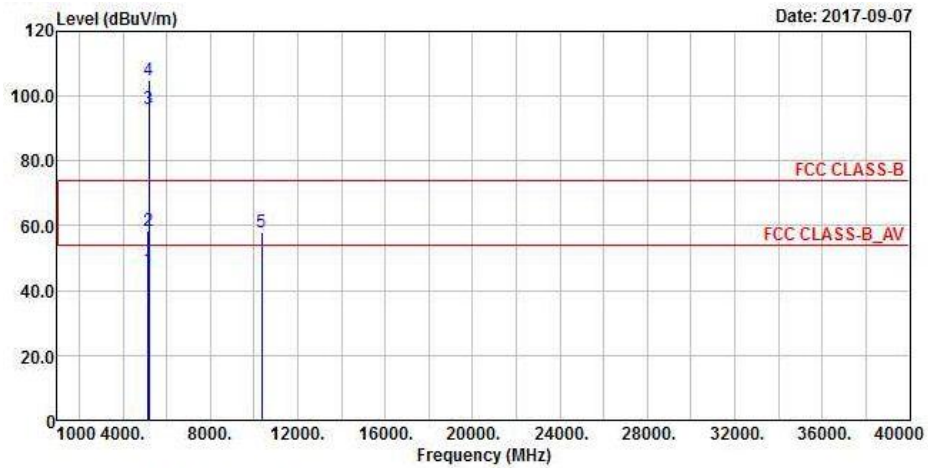

Vertical

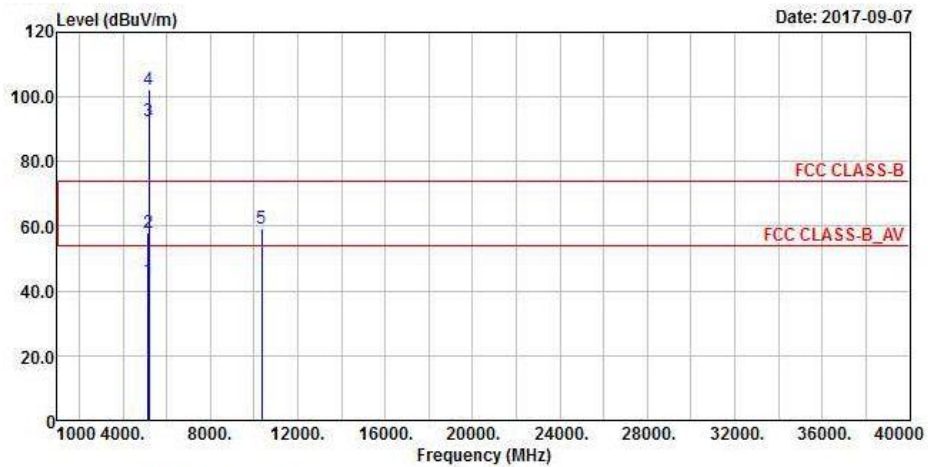

Antenna Polarity & Test Distance: Horizontal at 3 m										
Frequency (MHz)	Emission Level (dBuV/m)	Read Level (dBuV)	Limit (dBuV/m)	Margin (dB)	Antenna Factor (dB/m)	Cable Loss (dB)	Preamp Factor (dB)	Antenna Height (cm)	Table Angle (Degree)	Remark
5150	46.34	46	54	-7.66	31.32	6.34	37.32	183	154	Average
5150	58.54	58.2	74	-15.46	31.32	6.34	37.32	183	154	Peak
5180	95.92	95.54			31.35	6.37	37.34	183	154	Average
5180	105.14	104.76			31.35	6.37	37.34	183	154	Peak
*10360	58.02	61.07	68.2	-10.18	39.19	10.21	52.45	195	345	Peak
Antenna Polarity & Test Distance: Vertical at 3 m										
Frequency (MHz)	Emission Level (dBuV/m)	Read Level (dBuV)	Limit (dBuV/m)	Margin (dB)	Antenna Factor (dB/m)	Cable Loss (dB)	Preamp Factor (dB)	Antenna Height (cm)	Table Angle (Degree)	Remark
5150	43.39	43.05	54	-10.61	31.32	6.34	37.32	211	249	Average
5150	57.9	57.56	74	-16.1	31.32	6.34	37.32	211	249	Peak
5180	92.72	92.34			31.35	6.37	37.34	211	249	Average
5180	102.28	101.9			31.35	6.37	37.34	211	249	Peak
*10360	59.22	61.96	68.2	-8.98	39.19	10.21	52.14	171	75	Peak

Remarks:

1. Emission Level = Read Level + Antenna Factor + Cable Loss - Preamp Factor
Margin value = Emission level – Limit value
2. 5180 MHz: Fundamental Frequency
3. *: Out of Restricted Band

EUT Test Condition		Measurement Detail	
Channel	Channel 44	Frequency Range	1 GHz ~ 40 GHz
Input Power	120 Vac, 60 Hz	Detector Function	Peak (PK) Average (AV)
Environmental Conditions	25 deg. C, 65 % RH	Tested By	Han Wu

Horizontal

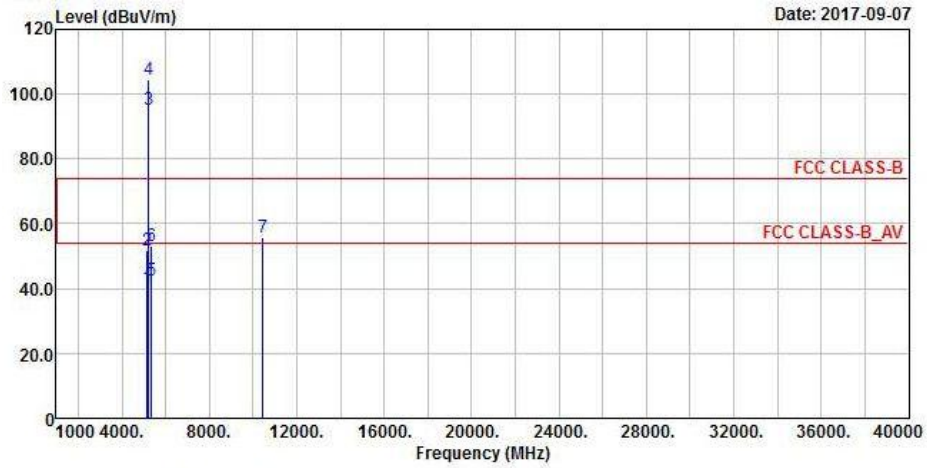

Vertical

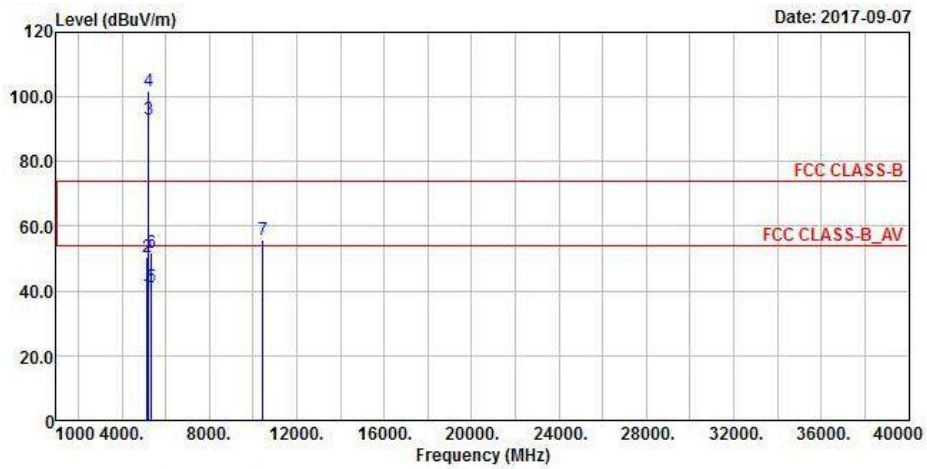

Antenna Polarity & Test Distance: Horizontal at 3 m

Frequency (MHz)	Emission Level (dBuV/m)	Read Level (dBuV)	Limit (dBuV/m)	Margin (dB)	Antenna Factor (dB/m)	Cable Loss (dB)	Preamp Factor (dB)	Antenna Height (cm)	Table Angle (Degree)	Remark
5150	40.27	39.93	54	-13.73	31.32	6.34	37.32	203	151	Average
5150	51.87	51.53	74	-22.13	31.32	6.34	37.32	203	151	Peak
5220	95.26	94.85			31.37	6.4	37.36	203	151	Average
5220	104.64	104.23			31.37	6.4	37.36	203	151	Peak
5350	42.4	41.63	54	-11.6	31.48	6.47	37.18	203	151	Average
5350	53.25	52.48	74	-20.75	31.48	6.47	37.18	203	151	Peak
*10440	55.82	58.84	68.2	-12.38	39.29	10.21	52.52	245	157	Peak

Antenna Polarity & Test Distance: Vertical at 3 m

Frequency (MHz)	Emission Level (dBuV/m)	Read Level (dBuV)	Limit (dBuV/m)	Margin (dB)	Antenna Factor (dB/m)	Cable Loss (dB)	Preamp Factor (dB)	Antenna Height (cm)	Table Angle (Degree)	Remark
5150	39.16	38.82	54	-14.84	31.32	6.34	37.32	196	268	Average
5150	50.68	50.34	74	-23.32	31.32	6.34	37.32	196	268	Peak
5220	93.15	92.74			31.37	6.4	37.36	196	268	Average
5220	102.02	101.61			31.37	6.4	37.36	196	268	Peak
5350	41.12	40.35	54	-12.88	31.48	6.47	37.18	196	268	Average
5350	51.97	51.2	74	-22.03	31.48	6.47	37.18	196	268	Peak
*10440	55.58	58.56	68.2	-12.62	39.29	10.21	52.48	205	94	Peak

Remarks:

- Emission Level = Read Level + Antenna Factor + Cable Loss - Preamp Factor
Margin value = Emission level – Limit value
- 5220 MHz: Fundamental Frequency
- *: Out of Restricted Band

EUT Test Condition		Measurement Detail	
Channel	Channel 48	Frequency Range	1 GHz ~ 40 GHz
Input Power	120 Vac, 60 Hz	Detector Function	Peak (PK) Average (AV)
Environmental Conditions	25 deg. C, 65 % RH	Tested By	Han Wu

Horizontal

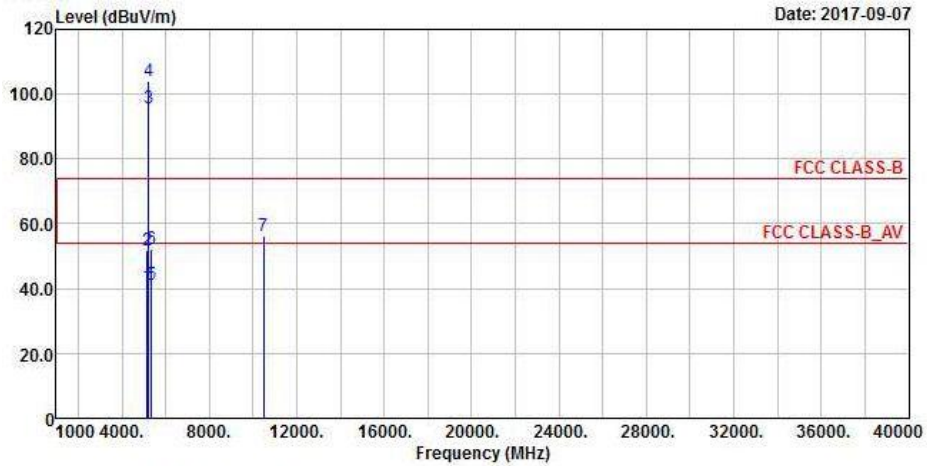

Vertical

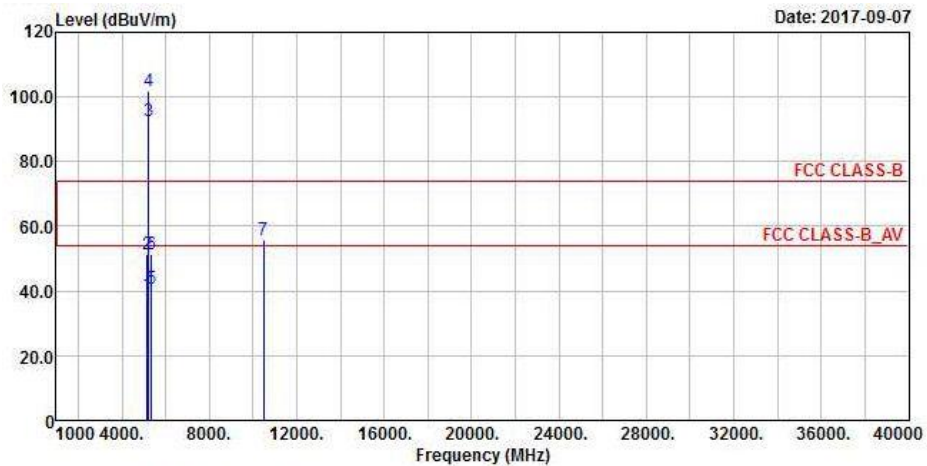

Antenna Polarity & Test Distance: Horizontal at 3 m

Frequency (MHz)	Emission Level (dBuV/m)	Read Level (dBuV)	Limit (dBuV/m)	Margin (dB)	Antenna Factor (dB/m)	Cable Loss (dB)	Preamp Factor (dB)	Antenna Height (cm)	Table Angle (Degree)	Remark
5150	40.73	40.39	54	-13.27	31.32	6.34	37.32	199	149	Average
5150	51.9	51.56	74	-22.1	31.32	6.34	37.32	199	149	Peak
5240	95.61	95.12			31.39	6.42	37.32	199	149	Average
5240	103.97	103.48			31.39	6.42	37.32	199	149	Peak
5350	40.99	40.22	54	-13.01	31.48	6.47	37.18	199	149	Average
5350	52.22	51.45	74	-21.78	31.48	6.47	37.18	199	149	Peak
*10480	56.03	59.1	68.2	-12.17	39.37	10.22	52.66	218	175	Peak

Antenna Polarity & Test Distance: Vertical at 3 m

Frequency (MHz)	Emission Level (dBuV/m)	Read Level (dBuV)	Limit (dBuV/m)	Margin (dB)	Antenna Factor (dB/m)	Cable Loss (dB)	Preamp Factor (dB)	Antenna Height (cm)	Table Angle (Degree)	Remark
5150	39.11	38.77	54	-14.89	31.32	6.34	37.32	197	270	Average
5150	51.57	51.23	74	-22.43	31.32	6.34	37.32	197	270	Peak
5240	92.51	92.02			31.39	6.42	37.32	197	270	Average
5240	101.77	101.28			31.39	6.42	37.32	197	270	Peak
5350	40.9	40.13	54	-13.1	31.48	6.47	37.18	197	270	Average
5350	51.34	50.57	74	-22.66	31.48	6.47	37.18	197	270	Peak
*10480	55.84	58.96	68.2	-12.36	39.37	10.22	52.71	123	249	Peak

Remarks:

- Emission Level = Read Level + Antenna Factor + Cable Loss - Preamp Factor
Margin value = Emission level – Limit value
- 5240 MHz: Fundamental Frequency
- *: Out of Restricted Band

EUT Test Condition		Measurement Detail	
Channel	Channel 149	Frequency Range	1 GHz ~ 40 GHz
Input Power	120 Vac, 60 Hz	Detector Function	Peak (PK) Average (AV)
Environmental Conditions	25 deg. C, 65 % RH	Tested By	Han Wu

**<Spurious Emission>
Horizontal**

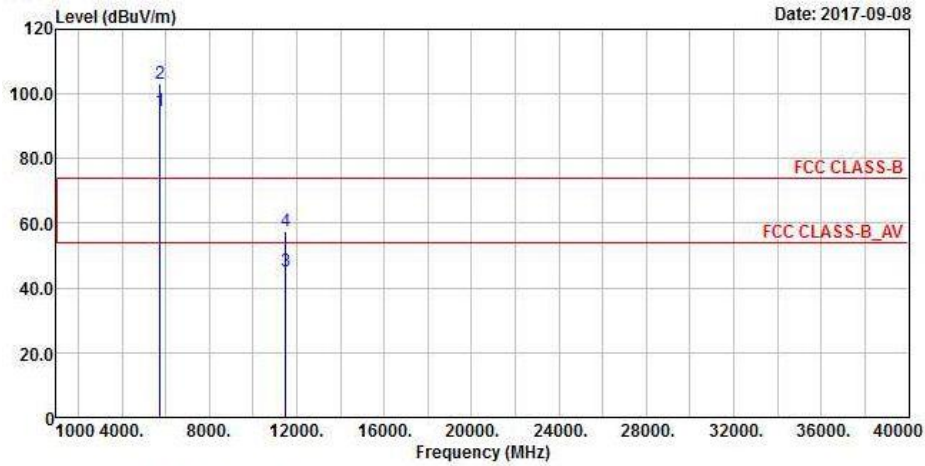

Vertical

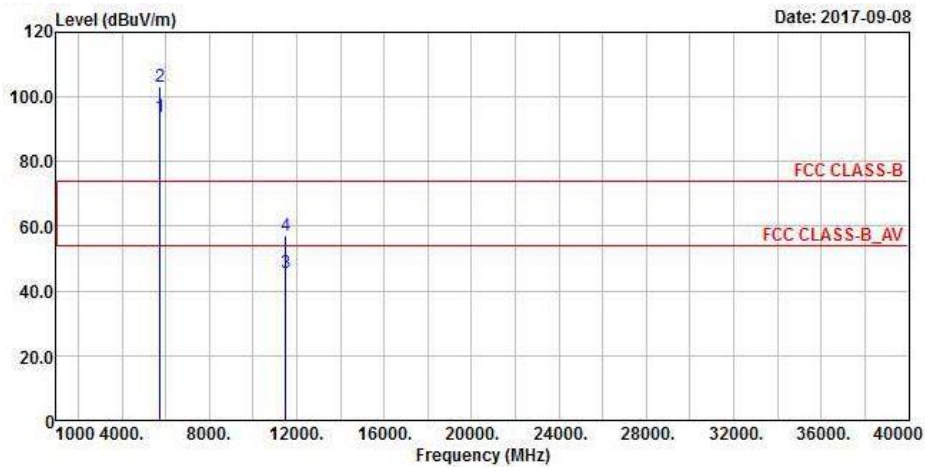

**<Out of Band Emission (OOBE)>
Horizontal**

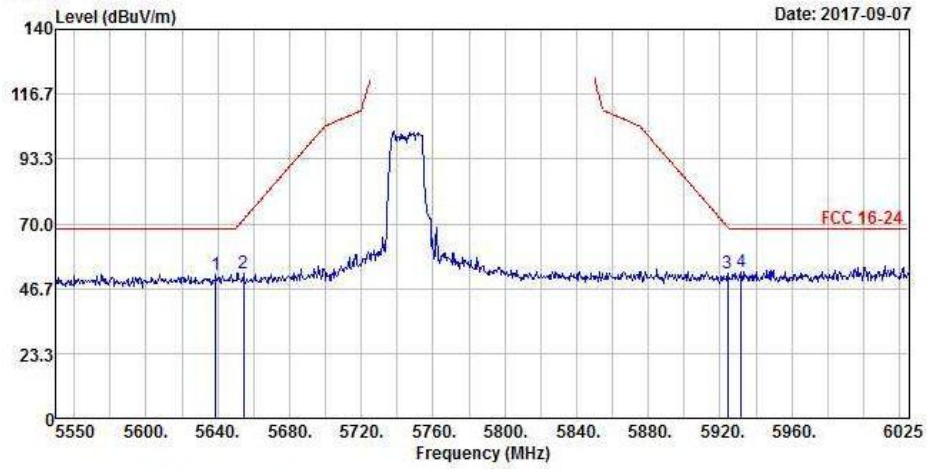

Vertical

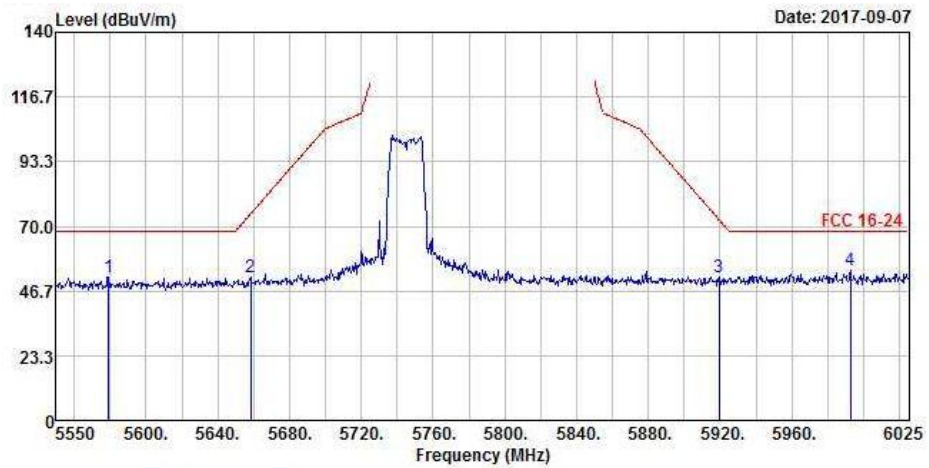

<Spurious Emission>

Antenna Polarity & Test Distance: Horizontal at 3 m										
Frequency (MHz)	Emission Level (dBuV/m)	Read Level (dBuV)	Limit (dBuV/m)	Margin (dB)	Antenna Factor (dB/m)	Cable Loss (dB)	Preamp Factor (dB)	Antenna Height (cm)	Table Angle (Degree)	Remark
5745	94.8	93.5			31.99	6.78	37.47	200	341	Average
5745	103.28	101.98			31.99	6.78	37.47	200	341	Peak
11490	45.37	47.58	54	-8.63	39.91	10.66	52.78	213	41	Average
11490	57.35	59.56	74	-16.65	39.91	10.66	52.78	213	41	Peak
Antenna Polarity & Test Distance: Vertical at 3 m										
Frequency (MHz)	Emission Level (dBuV/m)	Read Level (dBuV)	Limit (dBuV/m)	Margin (dB)	Antenna Factor (dB/m)	Cable Loss (dB)	Preamp Factor (dB)	Antenna Height (cm)	Table Angle (Degree)	Remark
5745	93.84	92.57			31.99	6.75	37.47	200	246	Average
5745	103.25	101.98			31.99	6.75	37.47	200	246	Peak
11490	45.39	47.65	54	-8.61	39.91	10.66	52.83	103	128	Average
11490	57.25	59.51	74	-16.75	39.91	10.66	52.83	103	128	Peak

<Out of Band Emission (OOBE)>

Antenna Polarity & Test Distance: Horizontal at 3 m										
Frequency (MHz)	Emission Level (dBuV/m)	Read Level (dBuV)	Limit (dBuV/m)	Margin (dB)	Antenna Factor (dB/m)	Cable Loss (dB)	Preamp Factor (dB)	Antenna Height (cm)	Table Angle (Degree)	Remark
5638.825	51.69	50.59	68.2	-16.51	31.82	6.56	37.28	200	341	Peak
5654.5	52.29	51.16	71.54	-19.25	31.85	6.62	37.34	200	341	Peak
5924.3	52.21	50.41	68.72	-16.51	32.29	7.01	37.5	200	341	Peak
5931.9	52.67	50.87	68.2	-15.53	32.29	7.01	37.5	200	341	Peak
Antenna Polarity & Test Distance: Vertical at 3 m										
Frequency (MHz)	Emission Level (dBuV/m)	Read Level (dBuV)	Limit (dBuV/m)	Margin (dB)	Antenna Factor (dB/m)	Cable Loss (dB)	Preamp Factor (dB)	Antenna Height (cm)	Table Angle (Degree)	Remark
5578.975	51.5	50.46	68.2	-16.7	31.71	6.49	37.16	200	246	Peak
5658.3	51.75	50.62	74.36	-22.61	31.85	6.62	37.34	200	246	Peak
5919.55	51.68	49.91	72.22	-20.54	32.26	7.01	37.5	200	246	Peak
5992.7	54	51.97	68.2	-14.2	32.4	7.14	37.51	200	246	Peak

Remarks:

- Emission Level = Read Level + Antenna Factor + Cable Loss - Preamp Factor
Margin value = Emission level – Limit value
- 5745 MHz: Fundamental Frequency
- *: Out of Restricted Band

EUT Test Condition		Measurement Detail	
Channel	Channel 157	Frequency Range	1 GHz ~ 40 GHz
Input Power	120 Vac, 60 Hz	Detector Function	Peak (PK) Average (AV)
Environmental Conditions	25 deg. C, 65 % RH	Tested By	Han Wu

**<Spurious Emission>
Horizontal**

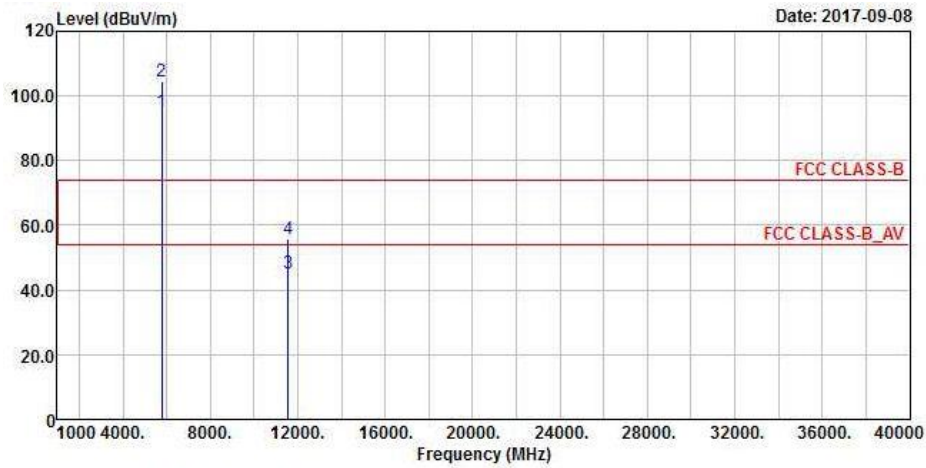

Vertical

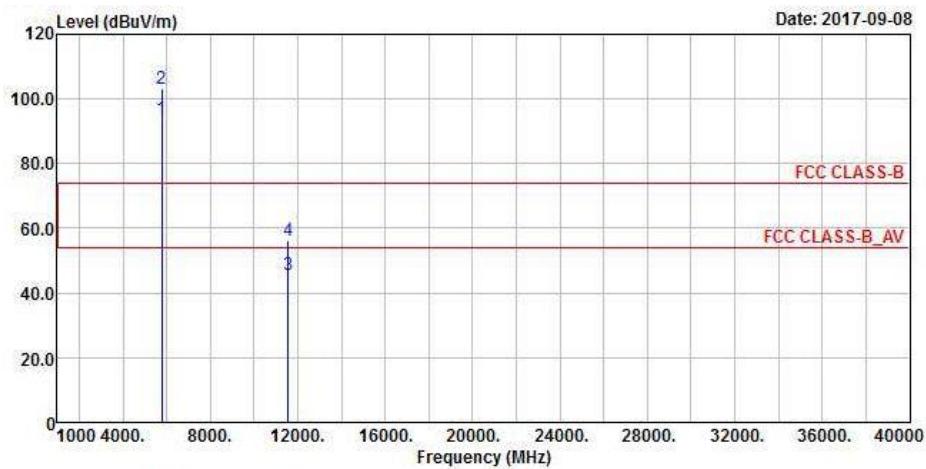

**<Out of Band Emission (OOBE)>
Horizontal**

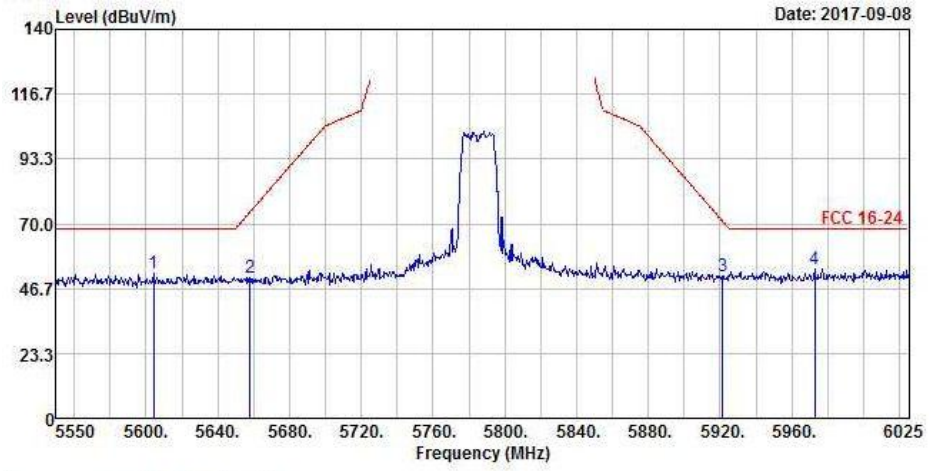

Vertical

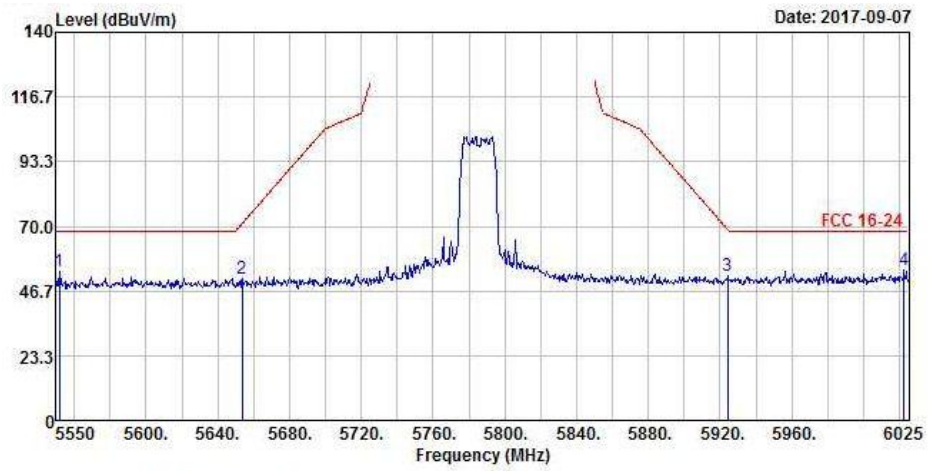

<Spurious Emission>

Antenna Polarity & Test Distance: Horizontal at 3 m										
Frequency (MHz)	Emission Level (dBuV/m)	Read Level (dBuV)	Limit (dBuV/m)	Margin (dB)	Antenna Factor (dB/m)	Cable Loss (dB)	Preamp Factor (dB)	Antenna Height (cm)	Table Angle (Degree)	Remark
5785	95.1	93.78			32.04	6.82	37.54	201	342	Average
5785	104.4	103.08			32.04	6.82	37.54	201	342	Peak
11570	45.36	47.83	54	-8.64	39.78	10.76	53.01	221	214	Average
11570	56	58.47	74	-18	39.78	10.76	53.01	221	214	Peak
Antenna Polarity & Test Distance: Vertical at 3 m										
Frequency (MHz)	Emission Level (dBuV/m)	Read Level (dBuV)	Limit (dBuV/m)	Margin (dB)	Antenna Factor (dB/m)	Cable Loss (dB)	Preamp Factor (dB)	Antenna Height (cm)	Table Angle (Degree)	Remark
5785	93.9	92.58			32.04	6.82	37.54	198	246	Average
5785	103.02	101.7			32.04	6.82	37.54	198	246	Peak
11570	45.6	48.39	54	-8.4	39.78	10.76	53.33	184	79	Average
11570	56.33	59.12	74	-17.67	39.78	10.76	53.33	184	79	Peak

<Out of Band Emission (OOBE)>

Antenna Polarity & Test Distance: Horizontal at 3 m										
Frequency (MHz)	Emission Level (dBuV/m)	Read Level (dBuV)	Limit (dBuV/m)	Margin (dB)	Antenna Factor (dB/m)	Cable Loss (dB)	Preamp Factor (dB)	Antenna Height (cm)	Table Angle (Degree)	Remark
5604.15	51.94	50.83	68.2	-16.26	31.77	6.56	37.22	201	342	Peak
5657.825	50.66	49.53	74.01	-23.35	31.85	6.62	37.34	201	342	Peak
5921.45	51.33	49.56	70.82	-19.49	32.26	7.01	37.5	201	342	Peak
5972.75	53.96	52.02	68.2	-14.24	32.37	7.08	37.51	201	342	Peak
Antenna Polarity & Test Distance: Vertical at 3 m										
Frequency (MHz)	Emission Level (dBuV/m)	Read Level (dBuV)	Limit (dBuV/m)	Margin (dB)	Antenna Factor (dB/m)	Cable Loss (dB)	Preamp Factor (dB)	Antenna Height (cm)	Table Angle (Degree)	Remark
5551.9	53.76	52.78	68.2	-14.44	31.68	6.42	37.12	198	246	Peak
5653.55	50.98	49.79	70.84	-19.86	31.85	6.62	37.28	198	246	Peak
5924.3	52.25	50.45	68.72	-16.47	32.29	7.01	37.5	198	246	Peak
6022.625	54.38	52.29	68.2	-13.82	32.45	7.14	37.5	198	246	Peak

Remarks:

- Emission Level = Read Level + Antenna Factor + Cable Loss - Preamp Factor
Margin value = Emission level – Limit value
- 5785 MHz: Fundamental Frequency
- *: Out of Restricted Band

EUT Test Condition		Measurement Detail	
Channel	Channel 165	Frequency Range	1 GHz ~ 40 GHz
Input Power	120 Vac, 60 Hz	Detector Function	Peak (PK) Average (AV)
Environmental Conditions	25 deg. C, 65 % RH	Tested By	Han Wu

**<Spurious Emission>
Horizontal**

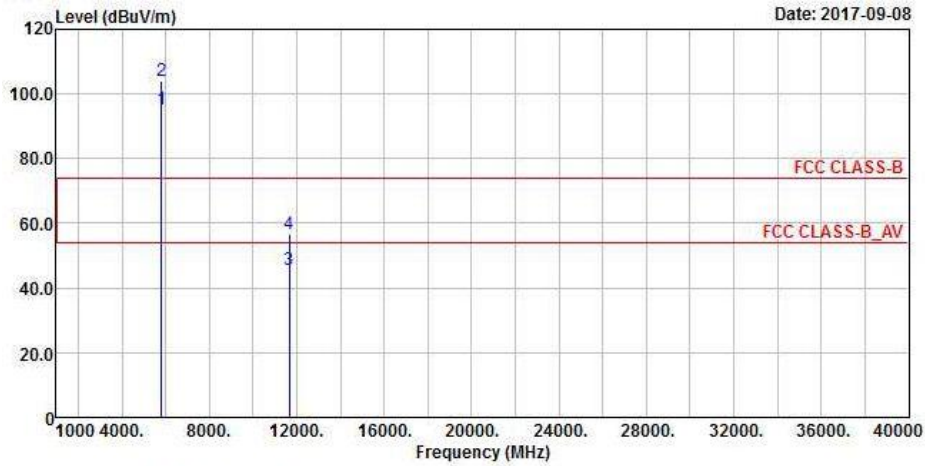

Vertical

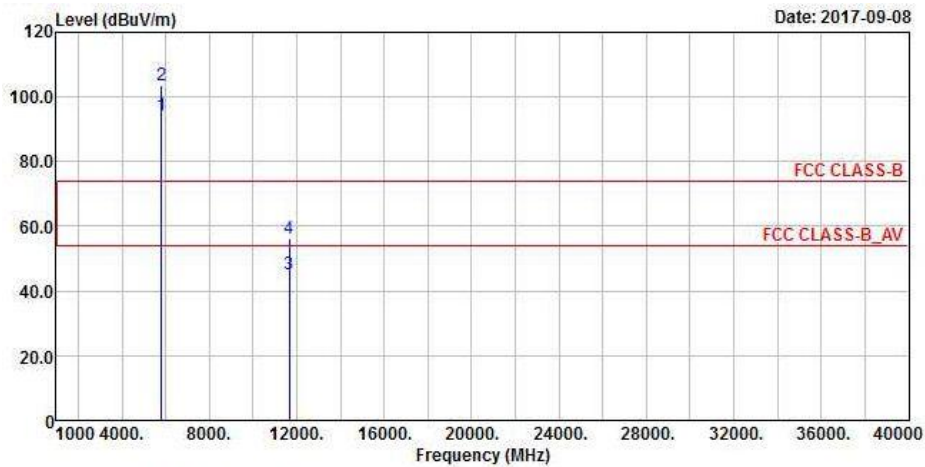

**<Out of Band Emission (OOBE)>
Horizontal**

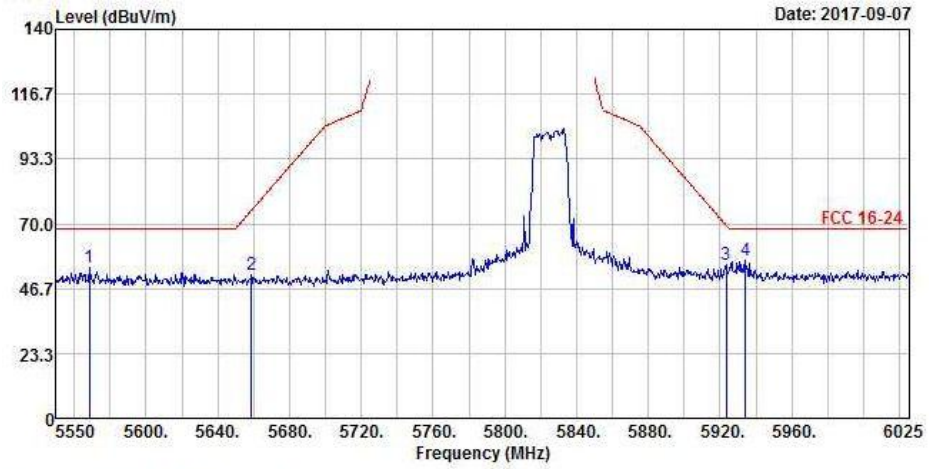

Vertical

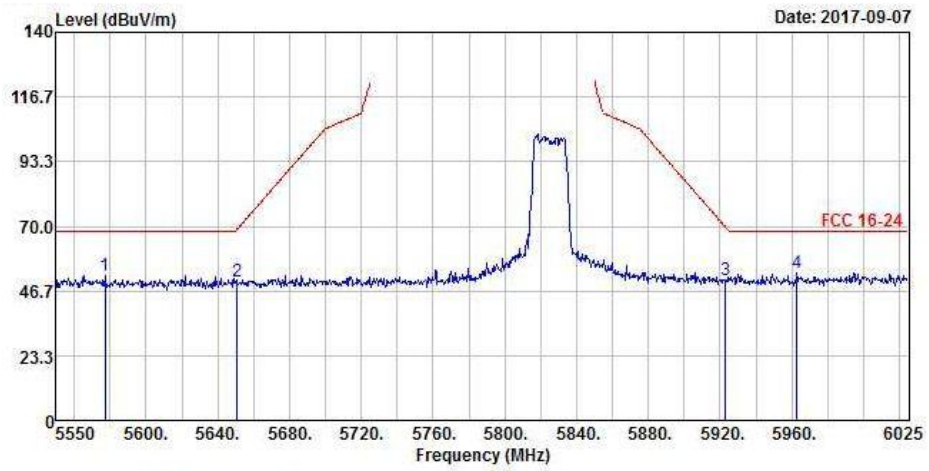

<Spurious Emission>

Antenna Polarity & Test Distance: Horizontal at 3 m										
Frequency (MHz)	Emission Level (dBuV/m)	Read Level (dBuV)	Limit (dBuV/m)	Margin (dB)	Antenna Factor (dB/m)	Cable Loss (dB)	Preamp Factor (dB)	Antenna Height (cm)	Table Angle (Degree)	Remark
5825	95.2	93.73			32.12	6.88	37.53	197	343	Average
5825	104.16	102.69			32.12	6.88	37.53	197	343	Peak
11650	45.73	48.42	54	-8.27	39.65	10.8	53.14	247	131	Average
11650	56.76	59.45	74	-17.24	39.65	10.8	53.14	247	131	Peak
Antenna Polarity & Test Distance: Vertical at 3 m										
Frequency (MHz)	Emission Level (dBuV/m)	Read Level (dBuV)	Limit (dBuV/m)	Margin (dB)	Antenna Factor (dB/m)	Cable Loss (dB)	Preamp Factor (dB)	Antenna Height (cm)	Table Angle (Degree)	Remark
5825	94.22	92.75			32.12	6.88	37.53	190	246	Average
5825	103.65	102.18			32.12	6.88	37.53	190	246	Peak
11650	45.12	48.02	54	-8.88	39.65	10.8	53.35	203	178	Average
11650	56.29	59.19	74	-17.71	39.65	10.8	53.35	203	178	Peak

<Out of Band Emission (OOBE)>

Antenna Polarity & Test Distance: Horizontal at 3 m										
Frequency (MHz)	Emission Level (dBuV/m)	Read Level (dBuV)	Limit (dBuV/m)	Margin (dB)	Antenna Factor (dB/m)	Cable Loss (dB)	Preamp Factor (dB)	Antenna Height (cm)	Table Angle (Degree)	Remark
5568.525	54.13	53.05	68.2	-14.07	31.71	6.49	37.12	197	343	Peak
5658.775	51.87	50.74	74.72	-22.85	31.85	6.62	37.34	197	343	Peak
5923.35	55.46	53.66	69.42	-13.96	32.29	7.01	37.5	197	343	Peak
5934.275	56.6	54.8	68.2	-11.6	32.29	7.01	37.5	197	343	Peak
Antenna Polarity & Test Distance: Vertical at 3 m										
Frequency (MHz)	Emission Level (dBuV/m)	Read Level (dBuV)	Limit (dBuV/m)	Margin (dB)	Antenna Factor (dB/m)	Cable Loss (dB)	Preamp Factor (dB)	Antenna Height (cm)	Table Angle (Degree)	Remark
5577.075	51.99	50.91	68.2	-16.21	31.71	6.49	37.12	190	246	Peak
5650.7	49.91	48.72	68.72	-18.81	31.85	6.62	37.28	190	246	Peak
5922.875	50.8	49	69.77	-18.97	32.29	7.01	37.5	190	246	Peak
5962.775	53.3	51.39	68.2	-14.9	32.34	7.08	37.51	190	246	Peak

Remarks:

- Emission Level = Read Level + Antenna Factor + Cable Loss - Preamp Factor
Margin value = Emission level – Limit value
- 5825 MHz: Fundamental Frequency
- *: Out of Restricted Band

802.11n (HT40)

EUT Test Condition		Measurement Detail	
Channel	Channel 38	Frequency Range	1 GHz ~ 40 GHz
Input Power	120 Vac, 60 Hz	Detector Function	Peak (PK) Average (AV)
Environmental Conditions	25 deg. C, 65 % RH	Tested By	Han Wu

Horizontal

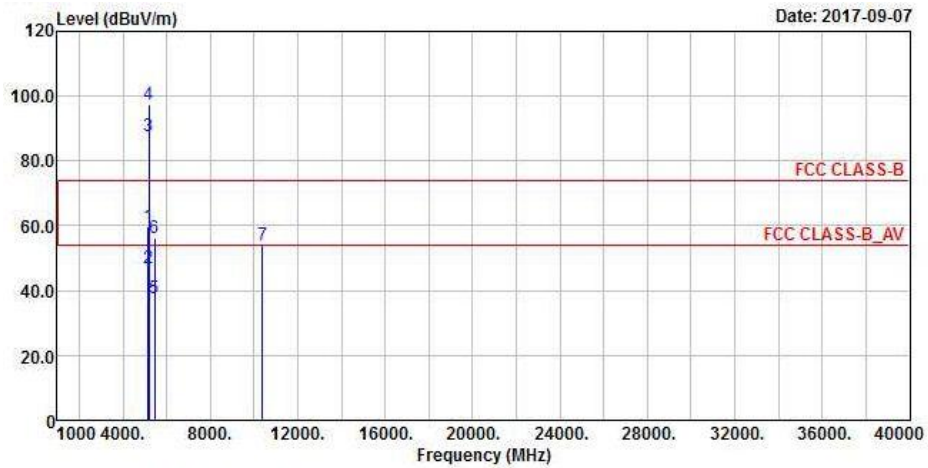

Vertical

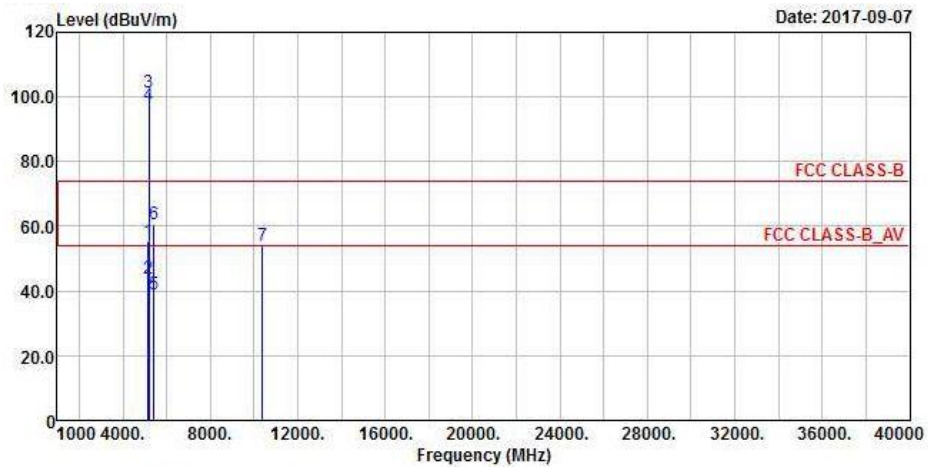

Antenna Polarity & Test Distance: Horizontal at 3 m

Frequency (MHz)	Emission Level (dBuV/m)	Read Level (dBuV)	Limit (dBuV/m)	Margin (dB)	Antenna Factor (dB/m)	Cable Loss (dB)	Preamp Factor (dB)	Antenna Height (cm)	Table Angle (Degree)	Remark
5148.8	59.65	59.31	74	-14.35	31.32	6.34	37.32	178	147	Peak
5149.1	46.96	46.62	54	-7.04	31.32	6.34	37.32	178	147	Average
5190	87.88	87.65			31.35	6.22	37.34	178	147	Average
5190	97.5	97.27			31.35	6.22	37.34	178	147	Peak
5456	37.74	36.92	54	-16.26	31.56	6.34	37.08	178	147	Average
5456	56.27	55.45	74	-17.73	31.56	6.34	37.08	178	147	Peak
*10380	53.81	57.8	68.2	-14.39	39.21	9.05	52.25	201	55	Peak

Antenna Polarity & Test Distance: Vertical at 3 m

Frequency (MHz)	Emission Level (dBuV/m)	Read Level (dBuV)	Limit (dBuV/m)	Margin (dB)	Antenna Factor (dB/m)	Cable Loss (dB)	Preamp Factor (dB)	Antenna Height (cm)	Table Angle (Degree)	Remark
5148.95	55.5	55.16	74	-18.5	31.32	6.34	37.32	200	259	Peak
5149.4	43.87	43.53	54	-10.13	31.32	6.34	37.32	200	259	Average
5190	101.38	100.99			31.35	6.38	37.34	200	259	Average
5190	97.52	97.13			31.35	6.38	37.34	200	259	Peak
5422	39.13	38.29	54	-14.87	31.53	6.49	37.18	200	259	Average
5422	60.71	59.87	74	-13.29	31.53	6.49	37.18	200	259	Peak
*10380	53.87	57.86	68.2	-14.33	39.21	9.05	52.25	125	44	Peak

Remarks:

- Emission Level = Read Level + Antenna Factor + Cable Loss - Preamp Factor
Margin value = Emission level – Limit value
- 5190 MHz: Fundamental Frequency
- *: Out of Restricted Band

EUT Test Condition		Measurement Detail	
Channel	Channel 46	Frequency Range	1 GHz ~ 40 GHz
Input Power	120 Vac, 60 Hz	Detector Function	Peak (PK) Average (AV)
Environmental Conditions	25 deg. C, 65 % RH	Tested By	Han Wu

Horizontal

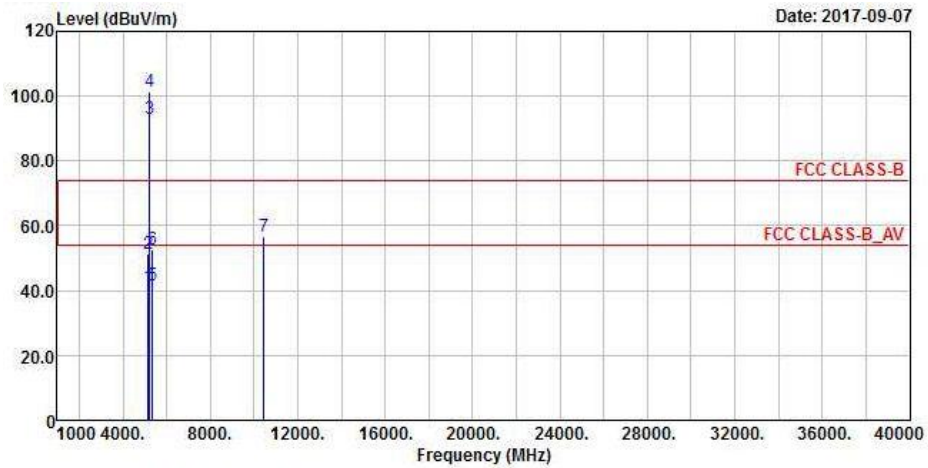

Vertical

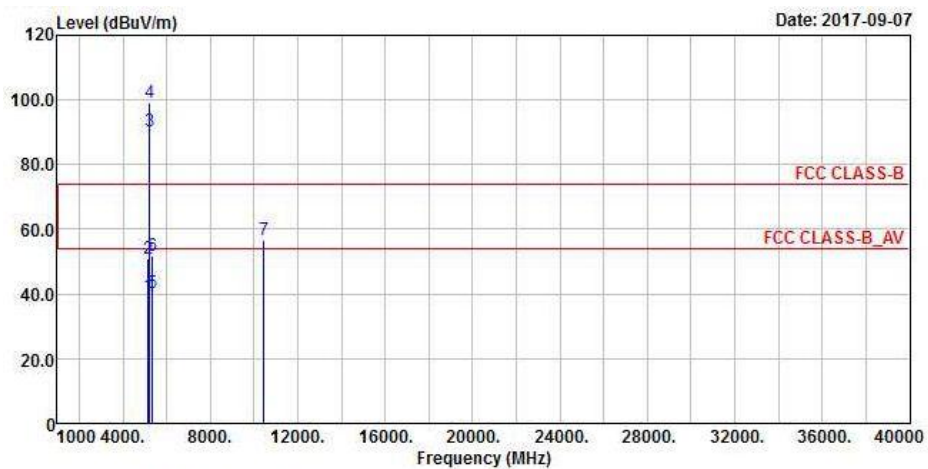

Antenna Polarity & Test Distance: Horizontal at 3 m

Frequency (MHz)	Emission Level (dBuV/m)	Read Level (dBuV)	Limit (dBuV/m)	Margin (dB)	Antenna Factor (dB/m)	Cable Loss (dB)	Preamp Factor (dB)	Antenna Height (cm)	Table Angle (Degree)	Remark
5150	41	40.66	54	-13	31.32	6.34	37.32	194	153	Average
5150	51.38	51.04	74	-22.62	31.32	6.34	37.32	194	153	Peak
5230	92.84	92.36			31.39	6.41	37.32	194	153	Average
5230	101.49	101.01			31.39	6.41	37.32	194	153	Peak
5350	41.79	41.02	54	-12.21	31.48	6.47	37.18	194	153	Average
5350	52.86	52.09	74	-21.14	31.48	6.47	37.18	194	153	Peak
*10460	56.58	59.63	68.2	-11.62	39.32	10.22	52.59	228	70	Peak

Antenna Polarity & Test Distance: Vertical at 3 m

Frequency (MHz)	Emission Level (dBuV/m)	Read Level (dBuV)	Limit (dBuV/m)	Margin (dB)	Antenna Factor (dB/m)	Cable Loss (dB)	Preamp Factor (dB)	Antenna Height (cm)	Table Angle (Degree)	Remark
5150	39.63	39.29	54	-14.37	31.32	6.34	37.32	198	268	Average
5150	51	50.66	74	-23	31.32	6.34	37.32	198	268	Peak
5230	90.28	89.8			31.39	6.41	37.32	198	268	Average
5230	99.17	98.69			31.39	6.41	37.32	198	268	Peak
5350	40.42	39.65	54	-13.58	31.48	6.47	37.18	198	268	Average
5350	51.73	50.96	74	-22.27	31.48	6.47	37.18	198	268	Peak
*10460	56.65	59.71	68.2	-11.55	39.32	10.22	52.6	158	278	Peak

Remarks:

- Emission Level = Read Level + Antenna Factor + Cable Loss - Preamp Factor
Margin value = Emission level – Limit value
- 5230 MHz: Fundamental Frequency
- *: Out of Restricted Band

EUT Test Condition		Measurement Detail	
Channel	Channel 151	Frequency Range	1 GHz ~ 40 GHz
Input Power	120 Vac, 60 Hz	Detector Function	Peak (PK) Average (AV)
Environmental Conditions	25 deg. C, 65 % RH	Tested By	Han Wu

**<Spurious Emission>
Horizontal**

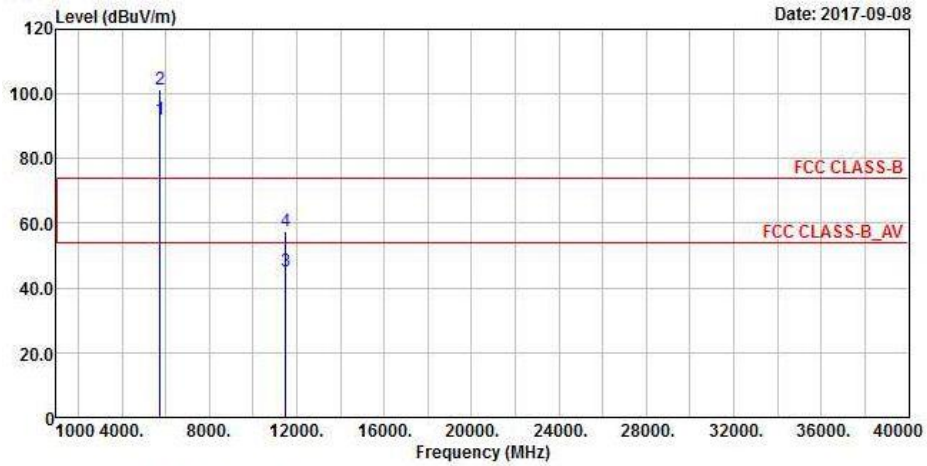

Vertical

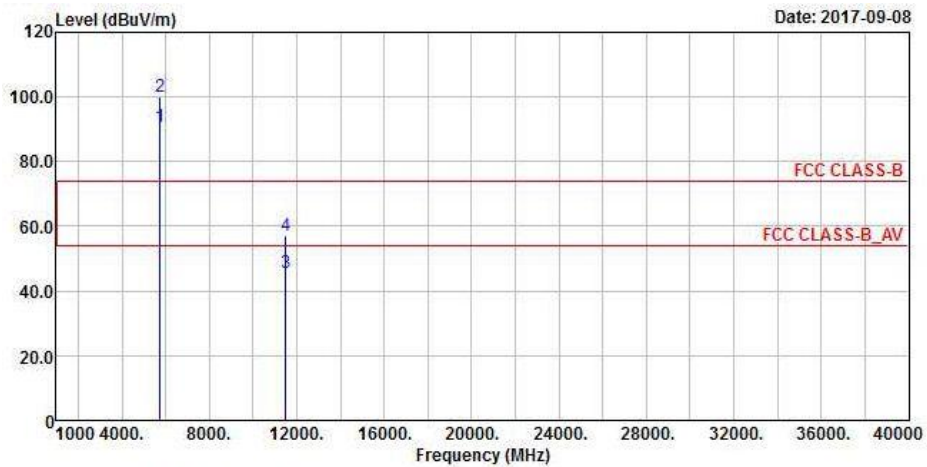

**<Out of Band Emission (OOBE)>
Horizontal**

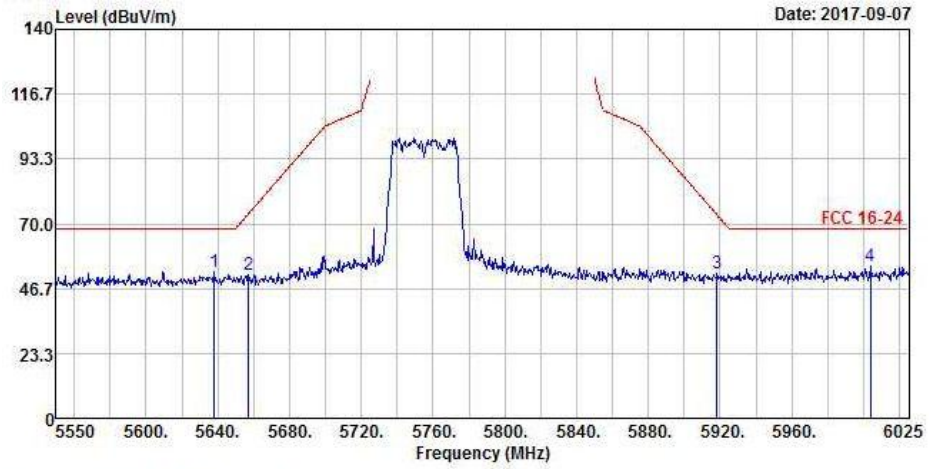

Vertical

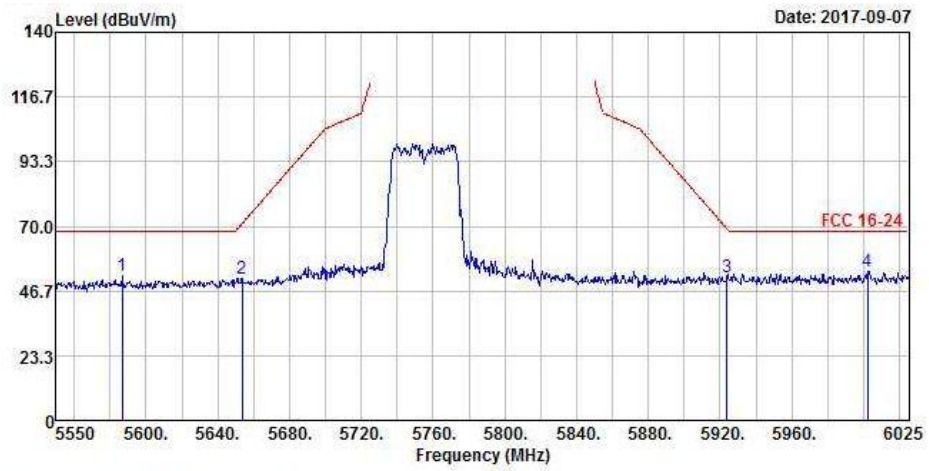

<Spurious Emission>

Antenna Polarity & Test Distance: Horizontal at 3 m										
Frequency (MHz)	Emission Level (dBuV/m)	Read Level (dBuV)	Limit (dBuV/m)	Margin (dB)	Antenna Factor (dB/m)	Cable Loss (dB)	Preamp Factor (dB)	Antenna Height (cm)	Table Angle (Degree)	Remark
5755	92.26	90.93			32.01	6.79	37.47	202	341	Average
5755	101.43	100.1			32.01	6.79	37.47	202	341	Peak
11510	45.28	47.5	54	-8.72	39.9	10.69	52.81	100	247	Average
11510	57.66	59.88	74	-16.34	39.9	10.69	52.81	100	247	Peak
Antenna Polarity & Test Distance: Vertical at 3 m										
Frequency (MHz)	Emission Level (dBuV/m)	Read Level (dBuV)	Limit (dBuV/m)	Margin (dB)	Antenna Factor (dB/m)	Cable Loss (dB)	Preamp Factor (dB)	Antenna Height (cm)	Table Angle (Degree)	Remark
5755	90.96	89.67			32.01	6.75	37.47	200	246	Average
5755	100.03	98.74			32.01	6.75	37.47	200	246	Peak
11510	45.61	48.09	54	-8.39	39.9	10.69	53.07	111	158	Average
11510	57.28	59.76	74	-16.72	39.9	10.69	53.07	111	158	Peak

<Out of Band Emission (OOBE)>

Antenna Polarity & Test Distance: Horizontal at 3 m										
Frequency (MHz)	Emission Level (dBuV/m)	Read Level (dBuV)	Limit (dBuV/m)	Margin (dB)	Antenna Factor (dB/m)	Cable Loss (dB)	Preamp Factor (dB)	Antenna Height (cm)	Table Angle (Degree)	Remark
5637.875	52.93	51.83	68.2	-15.27	31.82	6.56	37.28	202	341	Peak
5657.35	51.74	50.61	73.66	-21.92	31.85	6.62	37.34	202	341	Peak
5918.125	51.98	50.21	73.27	-21.29	32.26	7.01	37.5	202	341	Peak
6003.625	54.8	52.77	68.2	-13.4	32.4	7.14	37.51	202	341	Peak
Antenna Polarity & Test Distance: Vertical at 3 m										
Frequency (MHz)	Emission Level (dBuV/m)	Read Level (dBuV)	Limit (dBuV/m)	Margin (dB)	Antenna Factor (dB/m)	Cable Loss (dB)	Preamp Factor (dB)	Antenna Height (cm)	Table Angle (Degree)	Remark
5586.575	52.11	51.04	68.2	-16.09	31.74	6.49	37.16	200	246	Peak
5653.55	51.06	49.87	70.84	-19.78	31.85	6.62	37.28	200	246	Peak
5923.825	51.67	49.87	69.07	-17.4	32.29	7.01	37.5	200	246	Peak
6002.2	53.77	51.74	68.2	-14.43	32.4	7.14	37.51	200	246	Peak

Remarks:

- Emission Level = Read Level + Antenna Factor + Cable Loss - Preamp Factor
Margin value = Emission level – Limit value
- 5755 MHz: Fundamental Frequency
- *: Out of Restricted Band

EUT Test Condition		Measurement Detail	
Channel	Channel 159	Frequency Range	1 GHz ~ 40 GHz
Input Power	120 Vac, 60 Hz	Detector Function	Peak (PK) Average (AV)
Environmental Conditions	25 deg. C, 65 % RH	Tested By	Han Wu

**<Spurious Emission>
Horizontal**

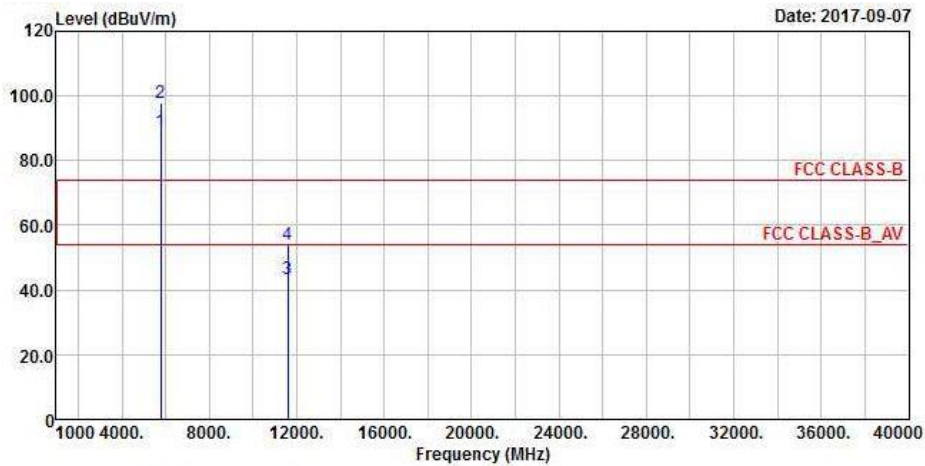

Vertical

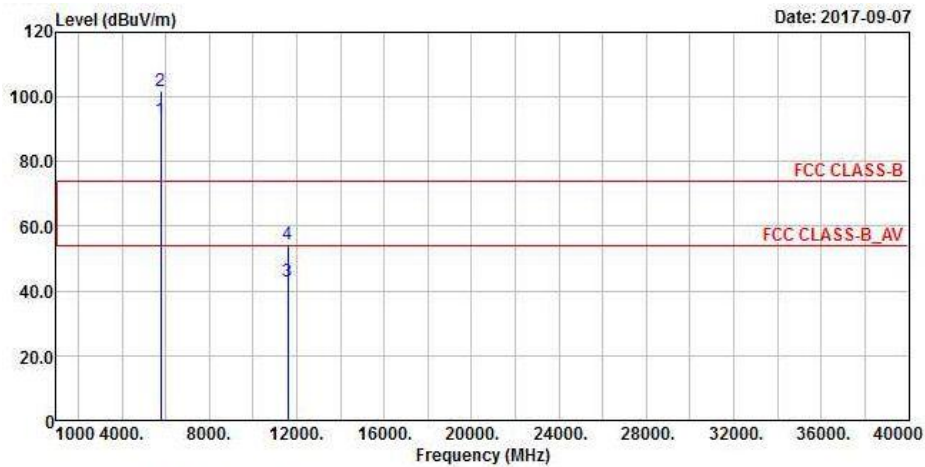

**<Out of Band Emission (OOBE)>
Horizontal**

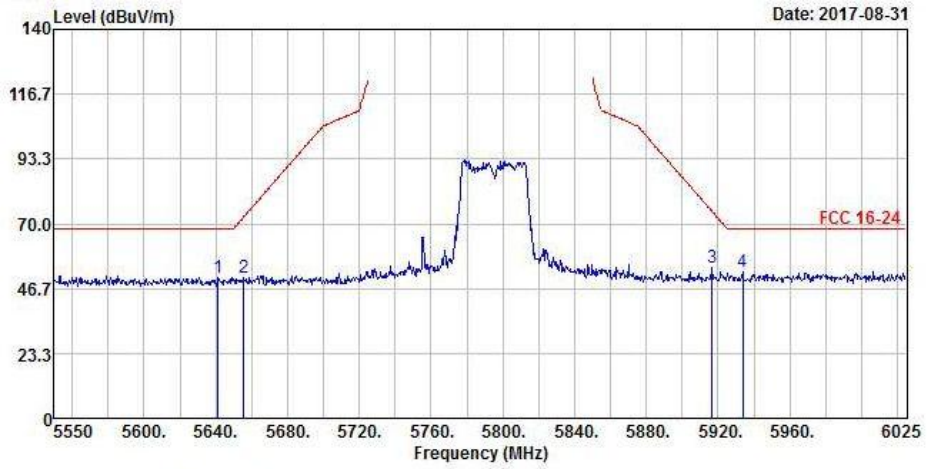

Vertical

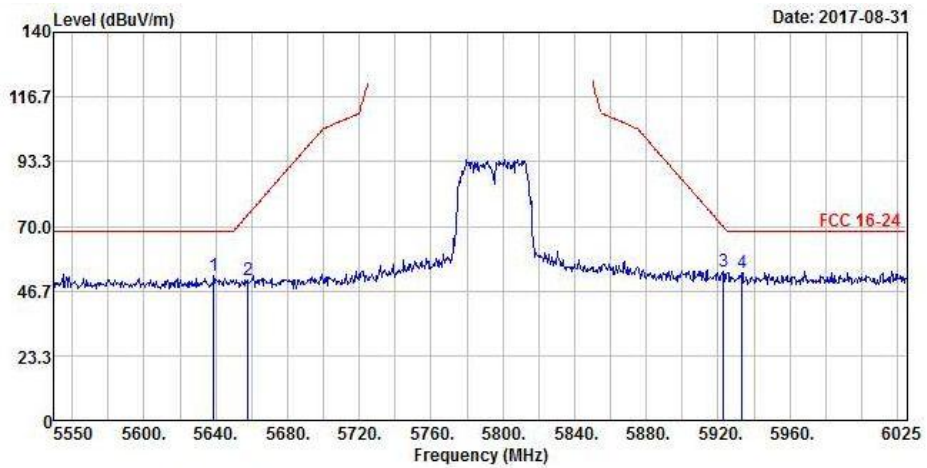

<Spurious Emission>

Antenna Polarity & Test Distance: Horizontal at 3 m										
Frequency (MHz)	Emission Level (dBuV/m)	Read Level (dBuV)	Limit (dBuV/m)	Margin (dB)	Antenna Factor (dB/m)	Cable Loss (dB)	Preamp Factor (dB)	Antenna Height (cm)	Table Angle (Degree)	Remark
5795	88.87	87.52			32.07	6.82	37.54	199	249	Average
5795	97.89	96.54			32.07	6.82	37.54	199	249	Peak
11590	43.25	45.74	54	-10.75	39.74	10.78	53.01	213	98	Average
11590	54.02	56.51	74	-19.98	39.74	10.78	53.01	213	98	Peak
Antenna Polarity & Test Distance: Vertical at 3 m										
Frequency (MHz)	Emission Level (dBuV/m)	Read Level (dBuV)	Limit (dBuV/m)	Margin (dB)	Antenna Factor (dB/m)	Cable Loss (dB)	Preamp Factor (dB)	Antenna Height (cm)	Table Angle (Degree)	Remark
5795	92.92	91.56			32.07	6.83	37.54	207	48	Average
5795	102	100.64			32.07	6.83	37.54	207	48	Peak
11590	42.83	45.64	54	-11.17	39.74	10.78	53.33	168	227	Average
11590	54.33	57.14	74	-19.67	39.74	10.78	53.33	168	227	Peak

<Out of Band Emission (OOBE)>

Antenna Polarity & Test Distance: Horizontal at 3 m										
Frequency (MHz)	Emission Level (dBuV/m)	Read Level (dBuV)	Limit (dBuV/m)	Margin (dB)	Antenna Factor (dB/m)	Cable Loss (dB)	Preamp Factor (dB)	Antenna Height (cm)	Table Angle (Degree)	Remark
5641.2	50.42	49.26	68.2	-17.78	31.82	6.62	37.28	199	249	Peak
5655.45	50.7	49.57	72.25	-21.55	31.85	6.62	37.34	199	249	Peak
5916.7	54.03	52.26	74.32	-20.29	32.26	7.01	37.5	199	249	Peak
5933.8	52.85	51.05	68.2	-15.35	32.29	7.01	37.5	199	249	Peak
Antenna Polarity & Test Distance: Vertical at 3 m										
Frequency (MHz)	Emission Level (dBuV/m)	Read Level (dBuV)	Limit (dBuV/m)	Margin (dB)	Antenna Factor (dB/m)	Cable Loss (dB)	Preamp Factor (dB)	Antenna Height (cm)	Table Angle (Degree)	Remark
5638.825	51.98	50.88	68.2	-16.22	31.82	6.56	37.28	207	48	Peak
5657.825	50.68	49.55	74.01	-23.33	31.85	6.62	37.34	207	48	Peak
5922.875	53.6	51.8	69.77	-16.17	32.29	7.01	37.5	207	48	Peak
5933.325	53.2	51.4	68.2	-15	32.29	7.01	37.5	207	48	Peak

Remarks:

- Emission Level = Read Level + Antenna Factor + Cable Loss - Preamp Factor
Margin value = Emission level – Limit value
- 5795 MHz: Fundamental Frequency
- *: Out of Restricted Band

9 kHz ~ 30 MHz DATA:

The amplitude of spurious emissions attenuated more than 20 dB below the permissible value is not required to be report.

30 MHz ~ 1 GHz WORST-CASE DATA:

802.11n (HT40)

EUT Test Condition		Measurement Detail	
Channel	Channel 38	Frequency Range	30 MHz ~ 1 GHz
Input Power	120 Vac, 60 Hz	Detector Function	Peak (PK) Quasi-peak (QP)
Environmental Conditions	25 deg. C, 65 % RH	Tested By	Han Wu

Horizontal

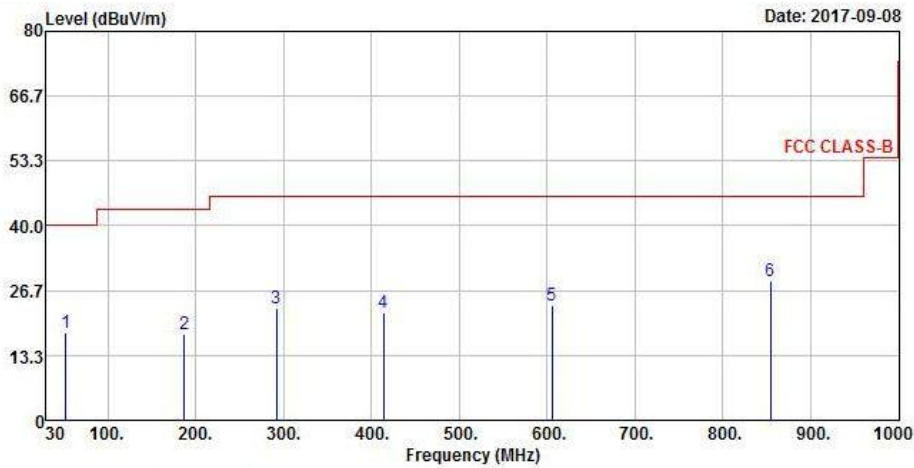

Vertical

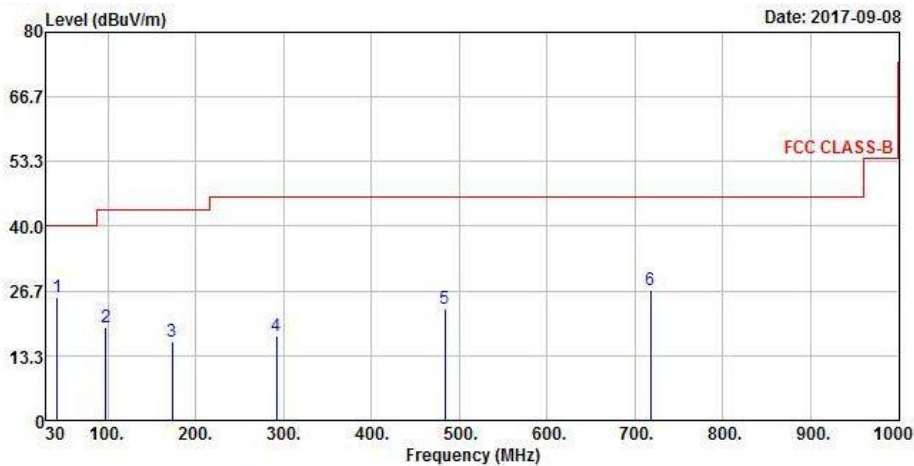

Antenna Polarity & Test Distance: Horizontal at 3 m

Frequency (MHz)	Emission Level (dBuV/m)	Read Level (dBuV)	Limit (dBuV/m)	Margin (dB)	Antenna Factor (dB/m)	Cable Loss (dB)	Preamp Factor (dB)	Antenna Height (cm)	Table Angle (Degree)	Remark
52.31	18.08	36.1	40	-21.92	12.76	0.54	31.32	109	227	Peak
187.14	17.78	38.08	43.5	-25.72	10.26	1.16	31.72	104	77	Peak
291.9	23.07	40.43	46	-22.93	12.71	1.63	31.7	127	141	Peak
414.12	22.21	36.47	46	-23.79	15.62	2.13	32.01	103	255	Peak
605.21	23.62	33.2	46	-22.38	19.67	2.92	32.17	119	89	Peak
854.5	28.75	33.84	46	-17.25	22.93	3.86	31.88	132	184	Peak

Antenna Polarity & Test Distance: Vertical at 3 m

Frequency (MHz)	Emission Level (dBuV/m)	Read Level (dBuV)	Limit (dBuV/m)	Margin (dB)	Antenna Factor (dB/m)	Cable Loss (dB)	Preamp Factor (dB)	Antenna Height (cm)	Table Angle (Degree)	Remark
42.61	25.31	42.31	40	-14.69	13.58	0.5	31.08	135	52	Peak
97.9	19.2	41.51	43.5	-24.3	8.91	0.74	31.96	129	229	Peak
173.56	16.29	35.59	43.5	-27.21	11.38	1.09	31.77	105	134	Peak
291.9	17.54	34.9	46	-28.46	12.71	1.63	31.7	112	276	Peak
483.96	23.05	35.45	46	-22.95	17	2.42	31.82	100	343	Peak
717.73	26.86	34.08	46	-19.14	21.07	3.39	31.68	116	54	Peak

Remarks:

- Emission Level = Read Level + Antenna Factor + Cable Loss - Preamp Factor
Margin value = Emission level – Limit value

802.11a

EUT Test Condition		Measurement Detail	
Channel	Channel 149	Frequency Range	30 MHz ~ 1 GHz
Input Power	120 Vac, 60 Hz	Detector Function	Peak (PK) Quasi-peak (QP)
Environmental Conditions	25 deg. C, 65 % RH	Tested By	Han Wu

Horizontal

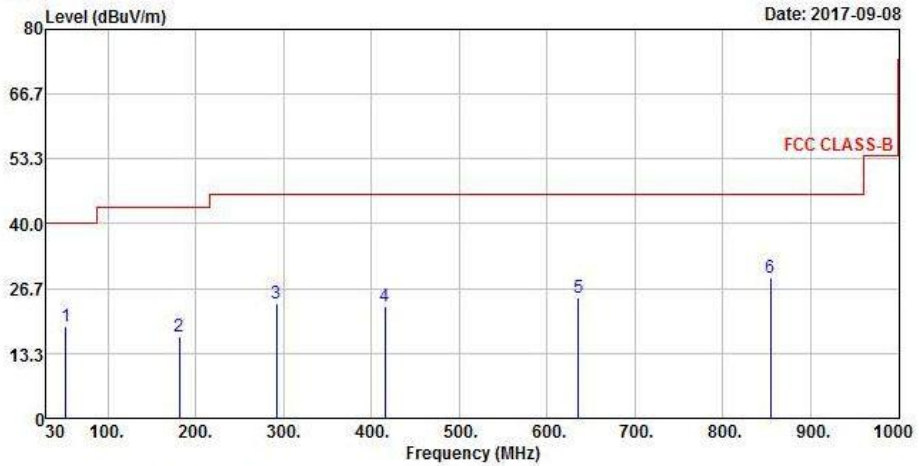

Vertical

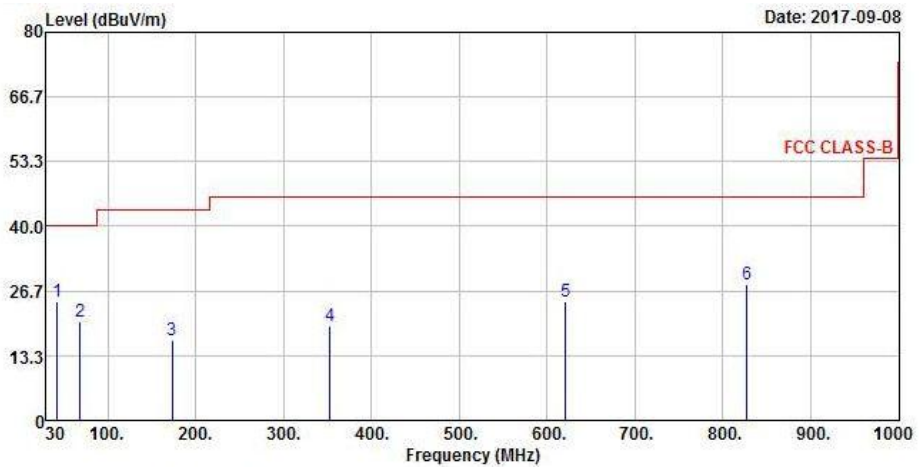

Antenna Polarity & Test Distance: Horizontal at 3 m										
Frequency (MHz)	Emission Level (dBuV/m)	Read Level (dBuV)	Limit (dBuV/m)	Margin (dB)	Antenna Factor (dB/m)	Cable Loss (dB)	Preamp Factor (dB)	Antenna Height (cm)	Table Angle (Degree)	Remark
52.31	18.78	36.8	40	-21.22	12.76	0.54	31.32	118	137	Peak
181.32	16.93	36.95	43.5	-26.57	10.67	1.13	31.82	108	191	Peak
291.9	23.64	41	46	-22.36	12.71	1.63	31.7	100	113	Peak
415.09	23.12	37.37	46	-22.88	15.64	2.13	32.02	130	84	Peak
635.28	24.65	33.68	46	-21.35	20.03	3.05	32.11	107	249	Peak
854.5	28.8	33.89	46	-17.2	22.93	3.86	31.88	105	123	Peak
Antenna Polarity & Test Distance: Vertical at 3 m										
Frequency (MHz)	Emission Level (dBuV/m)	Read Level (dBuV)	Limit (dBuV/m)	Margin (dB)	Antenna Factor (dB/m)	Cable Loss (dB)	Preamp Factor (dB)	Antenna Height (cm)	Table Angle (Degree)	Remark
42.61	24.38	41.38	40	-15.62	13.58	0.5	31.08	127	119	Peak
68.8	20.22	40.47	40	-19.78	10.89	0.63	31.77	123	183	Peak
173.56	16.54	35.84	43.5	-26.96	11.38	1.09	31.77	126	332	Peak
353.01	19.6	35.37	46	-26.4	14.22	1.89	31.88	109	305	Peak
620.73	24.43	33.75	46	-21.57	19.86	2.99	32.17	136	332	Peak
827.34	27.97	33.32	46	-18.03	22.58	3.76	31.69	116	131	Peak

Remarks:

- Emission Level = Read Level + Antenna Factor + Cable Loss - Preamp Factor
Margin value = Emission level – Limit value

4.2 Conducted Emission Measurement

4.2.1 Limits of Conducted Emission Measurement

Frequency (MHz)	Conducted Limit (dBuV)	
	Quasi-peak	Average
0.15 - 0.5	66 - 56	56 - 46
0.50 - 5.0	56	46
5.0 - 30.0	60	50

Note: 1. The lower limit shall apply at the transition frequencies.

2. The limit decreases in line with the logarithm of the frequency in the range of 0.15 to 0.50 MHz.

4.2.2 Test Instruments

Description & Manufacturer	Model No.	Serial No.	Date Of Calibration	Due Date Of Calibration
Test Receiver ROHDE & SCHWARZ	ESCI	100613	Nov. 21, 2016	Nov. 20, 2017
RF signal cable Woken	5D-FB	Cable-cond1-01	Sep. 05, 2017	Sep. 04, 2018
LISN ROHDE & SCHWARZ (EUT)	ESH3-Z5	835239/001	Mar. 10, 2017	Mar. 09, 2018
LISN ROHDE & SCHWARZ (Peripheral)	ESH3-Z5	100311	Aug. 15, 2017	Aug. 14, 2018
Software ADT	BV ADT_Cond_ V7.3.7.3	NA	NA	NA

- Note:**
1. The calibration interval of the above test instruments is 12 months and the calibrations are traceable to NML/ROC and NIST/USA.
 2. The test was performed in HwaYa Shielded Room 1.
 3. The VCCI Site Registration No. is C-2040.

4.2.3 Test Procedures

- a. The EUT was placed 0.4 meters from the conducting wall of the shielded room with EUT being connected to the power mains through a line impedance stabilization network (LISN). Other support units were connected to the power mains through another LISN. The two LISNs provide 50 ohm/ 50uH of coupling impedance for the measuring instrument.
- b. Both lines of the power mains connected to the EUT were checked for maximum conducted interference.
- c. The frequency range from 150 kHz to 30 MHz was searched. Emission levels under (Limit -20 dB) was not recorded.

Note: All modes of operation were investigated and the worst-case emissions are reported.

4.2.4 Deviation from Test Standard

No deviation.

4.2.5 Test Setup

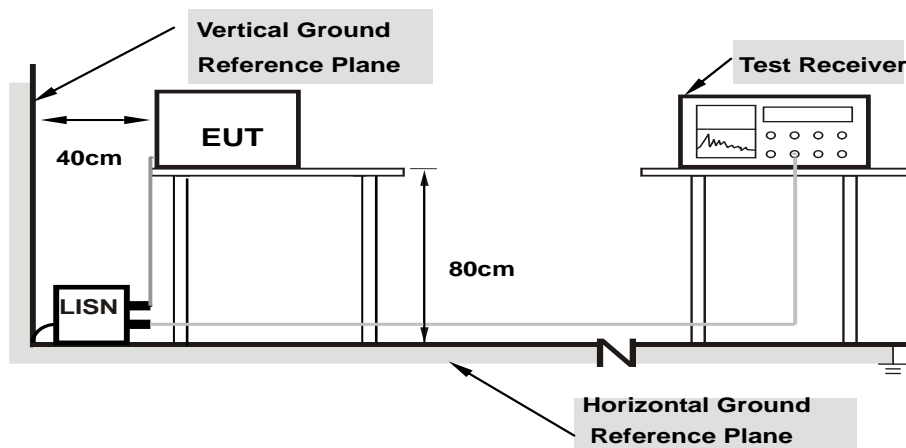

- Note:**
- 1.Support units were connected to second LISN.
 - 2.Both of LISNs (AMN) are 80 cm from EUT and at least 80 from other units and other metal planes

For the actual test configuration, please refer to the attached file (Test Setup Photo).

4.2.6 EUT Operating Conditions

- a. Placed the EUT on a testing table.
- b. Use the software to control the EUT under transmission condition continuously at specific channel frequency.

4.2.7 Test Results

Frequency Range	150kHz ~ 30MHz	Detector Function & Resolution Bandwidth	Quasi-Peak (QP) / Average (AV), 9kHz
Input Power	120Vac, 60Hz	Environmental Conditions	25°C, 75%RH
Tested by	Han Wu	Test Date	2017/9/5

Phase Of Power : Line (L)										
No	Frequency (MHz)	Correction Factor (dB)	Reading Value (dBuV)		Emission Level (dBuV)		Limit (dBuV)		Margin (dB)	
			Q.P.	AV.	Q.P.	AV.	Q.P.	AV.	Q.P.	AV.
1	0.15400	10.39	29.14	15.59	39.53	25.98	65.78	55.78	-26.25	-29.80
2	0.18133	10.39	24.97	12.06	35.36	22.45	64.42	54.42	-29.06	-31.97
3	0.25006	10.40	16.67	5.18	27.07	15.58	61.76	51.76	-34.69	-36.18
4	0.27800	10.40	21.21	9.08	31.61	19.48	60.88	50.88	-29.27	-31.40
5	0.36834	10.40	19.09	8.17	29.49	18.57	58.54	48.54	-29.05	-29.97
6	0.64220	10.41	18.72	15.18	29.13	25.59	56.00	46.00	-26.87	-20.41

Remarks:

1. Q.P. and AV. are abbreviations of quasi-peak and average individually.
2. The emission levels of other frequencies were very low against the limit.
3. Margin value = Emission level – Limit value
4. Correction factor = Insertion loss + Cable loss
5. Emission Level = Correction Factor + Reading Value

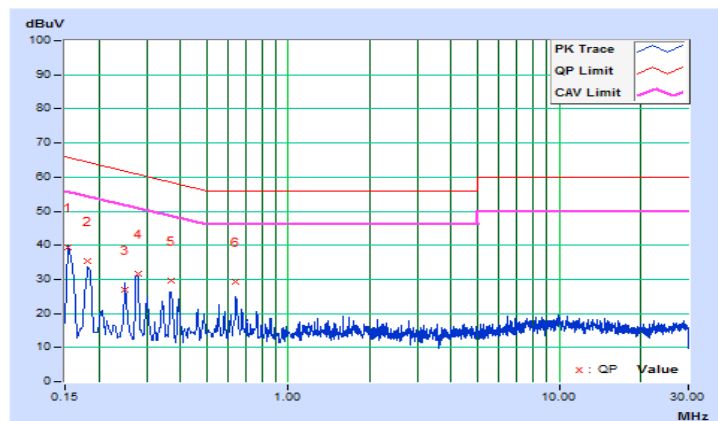

Frequency Range	150kHz ~ 30MHz	Detector Function & Resolution Bandwidth	Quasi-Peak (QP) / Average (AV), 9kHz
Input Power	120Vac, 60Hz	Environmental Conditions	25°C, 75%RH
Tested by	Han Wu	Test Date	2017/9/5

Phase Of Power : Neutral (N)										
No	Frequency (MHz)	Correction Factor (dB)	Reading Value (dBuV)		Emission Level (dBuV)		Limit (dBuV)		Margin (dB)	
			Q.P.	AV.	Q.P.	AV.	Q.P.	AV.	Q.P.	AV.
1	0.15400	10.15	28.80	15.12	38.95	25.27	65.78	55.78	-26.83	-30.51
2	0.18200	10.16	25.00	12.05	35.16	22.21	64.39	54.39	-29.23	-32.18
3	0.24600	10.16	22.07	10.04	32.23	20.20	61.89	51.89	-29.66	-31.69
4	0.27494	10.16	21.40	9.38	31.56	19.54	60.97	50.97	-29.41	-31.43
5	0.34200	10.17	13.92	3.04	24.09	13.21	59.15	49.15	-35.06	-35.94
6	2.16200	10.24	-0.31	-4.79	9.93	5.45	56.00	46.00	-46.07	-40.55

Remarks:

1. Q.P. and AV. are abbreviations of quasi-peak and average individually.
2. The emission levels of other frequencies were very low against the limit.
3. Margin value = Emission level – Limit value
4. Correction factor = Insertion loss + Cable loss
5. Emission Level = Correction Factor + Reading Value

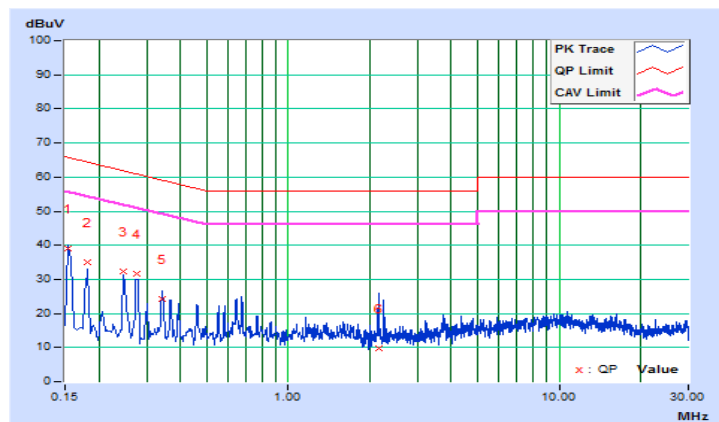

4.3 Transmit Power Measurement

4.3.1 Limits of Transmit Power Measurement

Operation Band	EUT Category		Limit
U-NII-1		Outdoor Access Point	1 Watt (30 dBm) (Max. e.i.r.p \leq 125 mW (21 dBm) at any elevation angle above 30 degrees as measured from the horizon)
		Fixed point-to-point Access Point	1 Watt (30 dBm)
		Indoor Access Point	1 Watt (30 dBm)
	√	Mobile and Portable client device	250 mW (24 dBm)
U-NII-2A	-		250 mW (24 dBm) or 11 dBm+10 log B*
U-NII-2C	-		250 mW (24 dBm) or 11 dBm+10 log B*
U-NII-3	√		1 Watt (30 dBm)

*B is the 26 dB emission bandwidth in megahertz

Per KDB 662911 Method of conducted output power measurement on IEEE 802.11 devices,

Array Gain = 0 dB (i.e., no array gain) for $N_{ANT} \leq 4$;

Array Gain = 0 dB (i.e., no array gain) for channel widths ≥ 40 MHz for any N_{ANT} ;

Array Gain = $5 \log(N_{ANT}/N_{SS})$ dB or 3 dB, whichever is less for 20 MHz channel widths with $N_{ANT} \geq 5$.

For power measurements on all other devices: Array Gain = $10 \log(N_{ANT}/N_{SS})$ dB.

4.3.2 Test Setup

<Power Output Measurement>

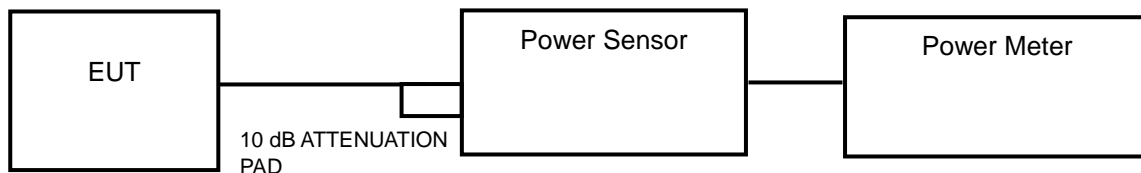

<26 dB Bandwidth>

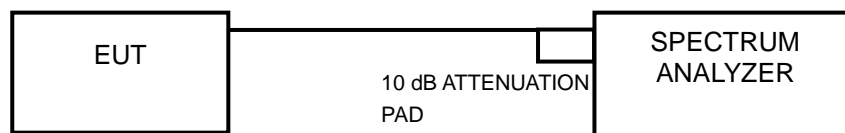

4.3.3 Test Instruments

Refer to section 4.1.2 to get information of above instrument.

4.3.4 Test Procedure

Average Power Measurement

Method PM is used to perform output power measurement, trigger and gating function of wide band power meter is enabled to measure max output power of TX on burst. Duty factor is not added to measured value.

26 dB Bandwidth

- 1) Set RBW = approximately 1 % of the emission bandwidth.
- 2) Set the VBW > RBW.
- 3) Detector = Peak.
- 4) Trace mode = max hold.
- 5) Measure the maximum width of the emission that is 26 dB down from the peak of the emission. Compare this with the RBW setting of the analyzer. Readjust RBW and repeat measurement as needed until the RBW/EBW ratio is approximately 1 %.

4.3.5 Deviation from Test Standard

No deviation.

4.3.6 EUT Operating Conditions

The software provided by client to enable the EUT under transmission condition continuously at lowest, middle and highest channel frequencies individually.

4.3.7 Test Result

Power Output:

802.11a

Channel	Frequency (MHz)	Maximum Conducted Power (mW)	Maximum Conducted Power (dBm)	Power Limit (dBm)	Pass / Fail
36	5180	26.607	14.25	24	Pass
44	5220	26.182	14.18	24	Pass
48	5240	26.363	14.21	24	Pass
149	5745	15.171	11.81	30	Pass
157	5785	16.634	12.21	30	Pass
165	5825	15.276	11.84	30	Pass

802.11n (HT20)

Channel	Frequency (MHz)	Maximum Conducted Power (mW)	Maximum Conducted Power (dBm)	Power Limit (dBm)	Pass / Fail
36	5180	26.424	14.22	24	Pass
44	5220	25.763	14.11	24	Pass
48	5240	26.303	14.20	24	Pass
149	5745	15.311	11.85	30	Pass
157	5785	16.52	12.18	30	Pass
165	5825	15.276	11.84	30	Pass

802.11n (HT40)

Channel	Frequency (MHz)	Maximum Conducted Power (mW)	Maximum Conducted Power (dBm)	Power Limit (dBm)	Pass / Fail
38	5190	26.792	14.28	24	Pass
46	5230	26.607	14.25	24	Pass
151	5755	15.996	12.04	30	Pass
159	5795	16.482	12.17	30	Pass

26 dB Bandwidth:

802.11a

Channel	Frequency (MHz)	26 dBc Bandwidth (MHz)
36	5180	20.11
44	5220	20.27
48	5240	20.25

802.11n (HT20)

Channel	Frequency (MHz)	26 dBc Bandwidth (MHz)
36	5180	20.68
44	5220	20.66
48	5240	20.57

802.11n (HT40)

Channel	Frequency (MHz)	26 dBc Bandwidth (MHz)
38	5190	42.78
46	5230	41.91

Spectrum Plot of Worst Value

802.11a

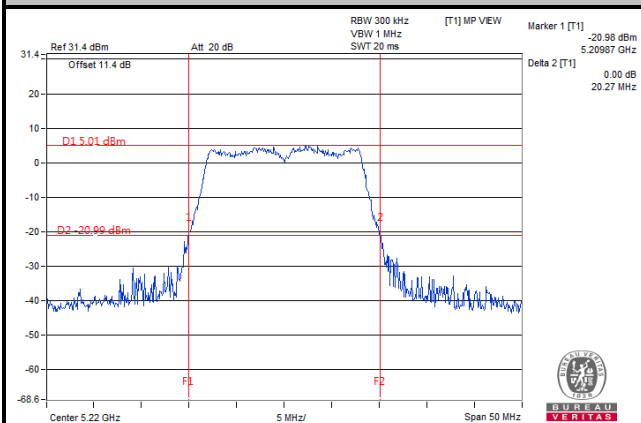

802.11n (HT20)

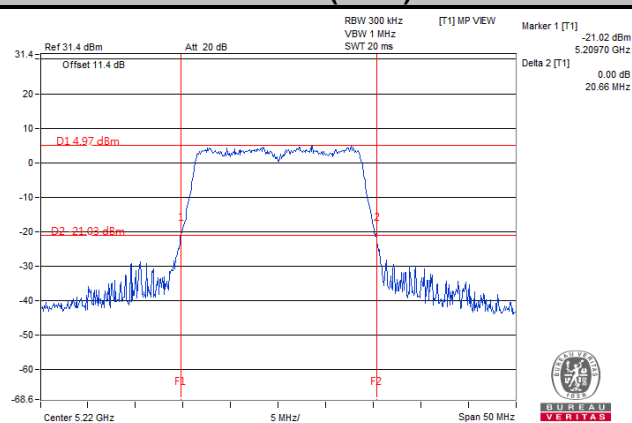

802.11n (HT40)

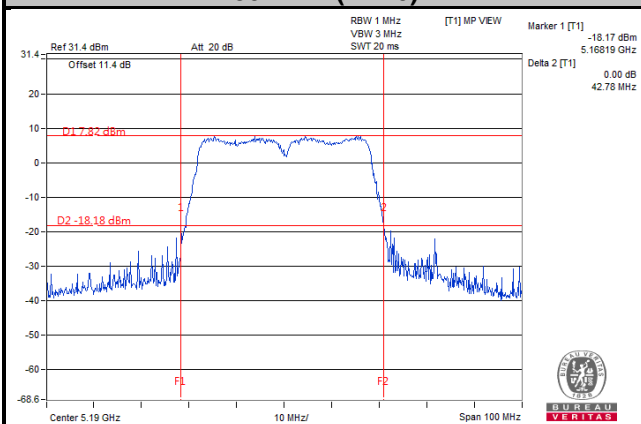

4.4 Occupied Bandwidth Measurement

4.4.1 Test Setup



4.4.2 Test Instruments

Refer to section 4.1.2 to get information of above instrument.

4.4.3 Test Procedure

The transmitter output was connected to the spectrum analyzer through an attenuator. The bandwidth of the fundamental frequency was measured by spectrum analyzer with resolution bandwidth in the range of 1 % to 5 % of the anticipated emission bandwidth, and a video bandwidth at least 3x the resolution bandwidth and set the detector to SAMPLE. The width of a frequency band such that, below the lower and above the upper frequency limits, the mean powers emitted are each equal to a specified percentage 0.5 % of the total mean power of a given emission.

4.4.4 Test Results

802.11a

Channel	Channel Frequency (MHz)	Occupied Bandwidth (MHz)
36	5180	16.92
44	5220	16.87
48	5240	16.87
149	5745	16.73
157	5785	16.65
165	5825	16.65

802.11n (HT20)

Channel	Channel Frequency (MHz)	Occupied Bandwidth (MHz)
36	5180	17.78
44	5220	17.78
48	5240	17.78
149	5745	17.78
157	5785	17.75
165	5825	17.75

802.11n (HT40)

Channel	Channel Frequency (MHz)	Occupied Bandwidth (MHz)
38	5190	36.66
46	5230	36.66
151	5755	36.53
159	5795	36.50

Spectrum Plot of Worst Value

802.11a

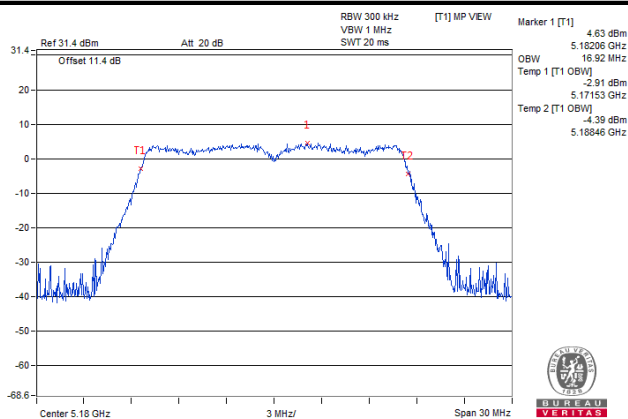

802.11n (HT20)

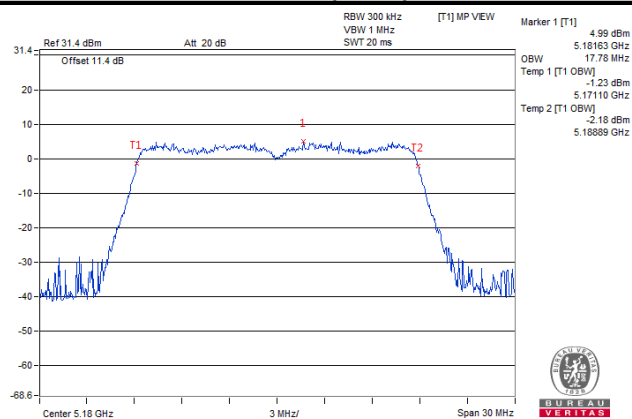

802.11n (HT40)

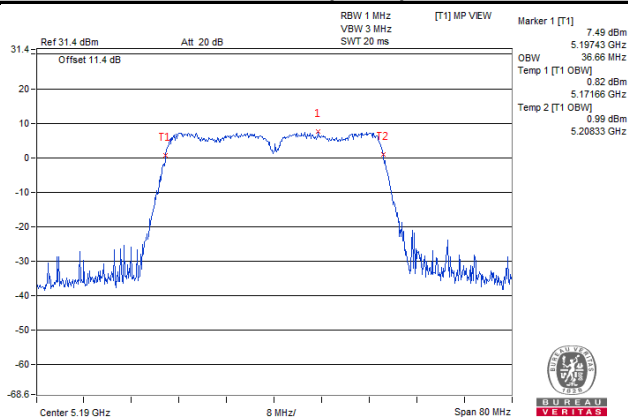

4.5 Peak Power Spectral Density Measurement

4.5.1 Limits of Peak Power Spectral Density Measurement

Operation Band	EUT Category		Limit
U-NII-1		Outdoor Access Point	17 dBm/MHz
		Fixed point-to-point Access Point	
		Indoor Access Point	
	√	Mobile and Portable client device	11 dBm/MHz
U-NII-2A	-		11 dBm/MHz
U-NII-2C	-		11 dBm/MHz
U-NII-3	√		30 dBm/500 kHz

4.5.2 Test Setup

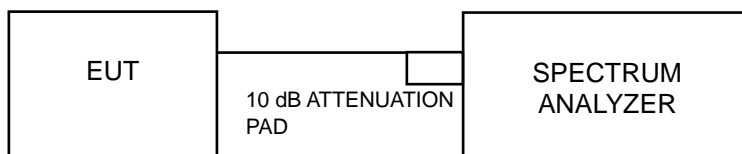

4.5.3 Test Instruments

Refer to section 4.1.3 to get information of above instrument.

4.5.4 Test Procedures

For U-NII-1 band:

Using method SA-2

1. Set span to encompass the entire emission bandwidth (EBW) of the signal.
2. Set RBW = 1 MHz, Set VBW \geq 3 RBW, Detector = RMS
3. Sweep time = auto, trigger set to "free run".
4. Trace average at least 100 traces in power averaging mode.
5. Record the max value and add 10 log (1/duty cycle)

※For U-NII-3:

1. Set span to encompass the entire emission bandwidth (EBW) of the signal.
2. Set RBW = 500 kHz, Set VBW \geq 3 RBW, Detector = RMS
3. Use the peak marker function to determine the maximum power level in any 500 kHz band segment within the fundamental EBW.
4. Sweep time = auto, trigger set to "free run".
5. Trace average at least 100 traces in power averaging mode.
6. Record the max value and add 10 log (1/duty cycle)

4.5.5 Deviation from Test Standard

No deviation.

4.5.6 EUT Operating Conditions

The software provided by client to enable the EUT under transmission condition continuously at lowest, middle and highest channel frequencies individually.

4.5.7 Test Results

For U-NII-1 Band

802.11a

Channel	Frequency (MHz)	PSD w/o Duty Factor (dBm/MHz)	Duty Factor (dB)	PSD with Duty Factor (dBm/MHz)	Maximum Limit (dBm/MHz)	Pass / Fail
36	5180	-1.35	3.61	2.26	11	Pass
44	5220	-0.70	3.61	2.92	11	Pass
48	5240	-1.24	3.61	2.37	11	Pass

Note: Refer to section 3.3 for duty cycle spectrum plot.

802.11n (HT20)

Channel	Frequency (MHz)	PSD w/o Duty Factor (dBm/MHz)	Duty Factor (dB)	PSD with Duty Factor (dBm/MHz)	Maximum Limit (dBm/MHz)	Pass / Fail
36	5180	0.34	3.78	4.12	11	Pass
44	5220	0.45	3.78	4.23	11	Pass
48	5240	0.52	3.78	4.30	11	Pass

Note: Refer to section 3.3 for duty cycle spectrum plot.

802.11n (HT40)

Channel	Frequency (MHz)	PSD w/o Duty Factor (dBm/MHz)	Duty Factor (dB)	PSD with Duty Factor (dBm/MHz)	Maximum Limit (dBm/MHz)	Pass / Fail
38	5190	-5.53	6.91	1.38	11	Pass
46	5230	-5.44	6.91	1.47	11	Pass

Note: Refer to section 3.3 for duty cycle spectrum plot.

Spectrum Plot of Worst Value

802.11a

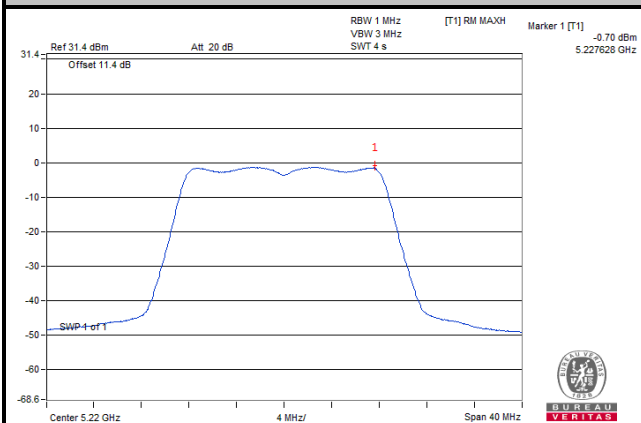

802.11n (HT20)

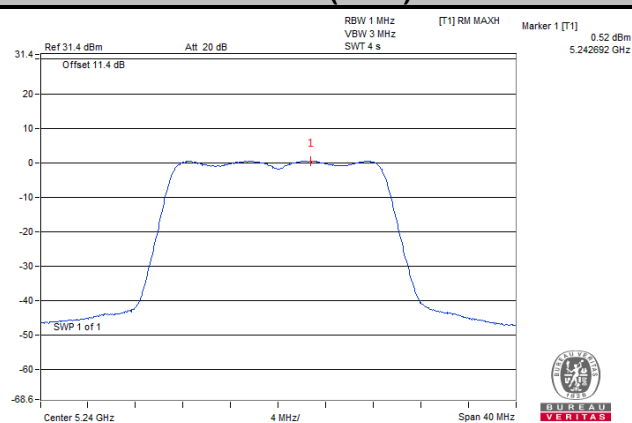

802.11n (HT40)

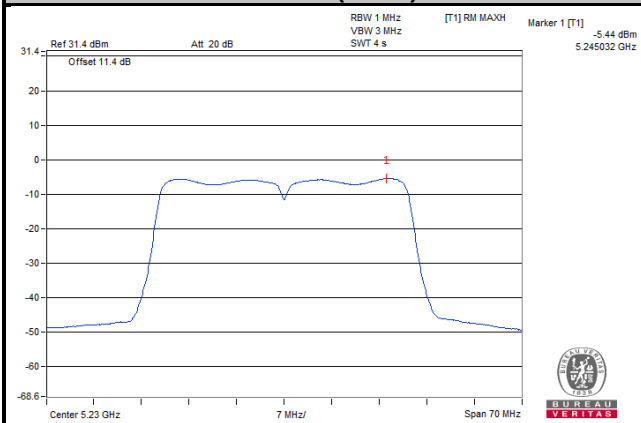

For U-NII-3 Band

802.11a

Channel	Frequency (MHz)	PSD w/o Duty Factor (dBm/500 kHz)	Duty Factor (dB)	PSD with Duty Factor (dBm/500 kHz)	Limit (dBm/500 kHz)	Pass / Fail
149	5745	-1.64	3.61	1.97	30	Pass
157	5785	-1.55	3.61	2.06	30	Pass
165	5825	-0.96	3.61	2.65	30	Pass

Note: Refer to section 3.3 for duty cycle spectrum plot.

802.11n (HT20)

Channel	Frequency (MHz)	PSD w/o Duty Factor (dBm/500 kHz)	Duty Factor (dB)	PSD with Duty Factor (dBm/500 kHz)	Limit (dBm/500 kHz)	Pass / Fail
149	5745	-1.70	3.78	2.08	30	Pass
157	5785	-1.52	3.78	2.26	30	Pass
165	5825	-0.99	3.78	2.79	30	Pass

Note: Refer to section 3.3 for duty cycle spectrum plot.

802.11n (HT40)

Channel	Frequency (MHz)	PSD w/o Duty Factor (dBm/500 kHz)	Duty Factor (dB)	PSD with Duty Factor (dBm/500 kHz)	Limit (dBm/500 kHz)	Pass / Fail
151	5755	-4.52	6.91	2.39	30	Pass
159	5795	-4.00	6.91	2.91	30	Pass

Note: Refer to section 3.3 for duty cycle spectrum plot.

Spectrum Plot of Worst Value

802.11a

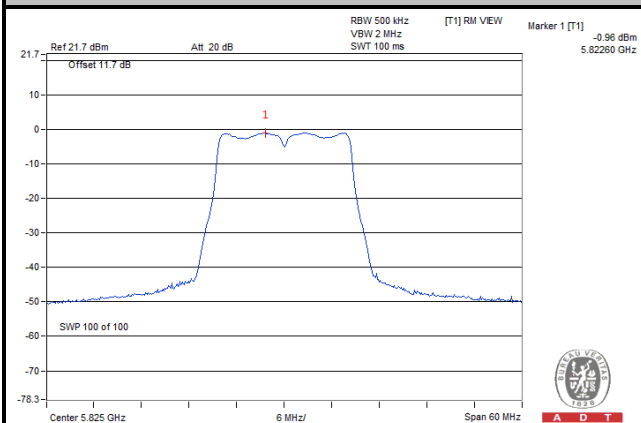

802.11n (HT20)

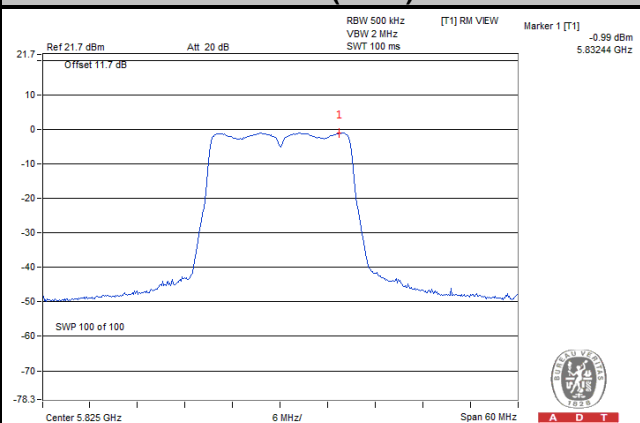

802.11n (HT40)

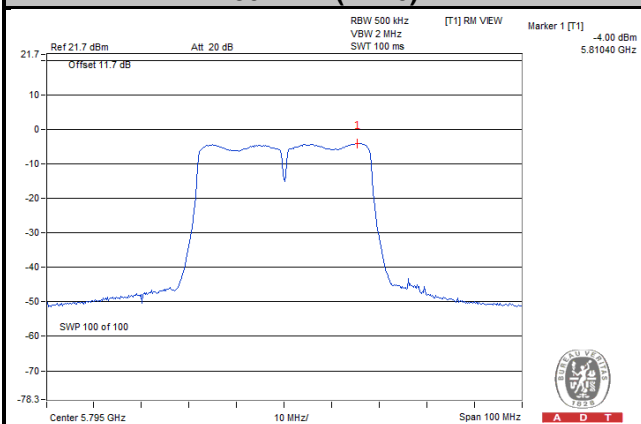

4.6 Frequency Stability

4.6.1 Limit of Frequency Stability Measurement

The frequency of the carrier signal shall be maintained within band of operation.

4.6.2 Test Setup

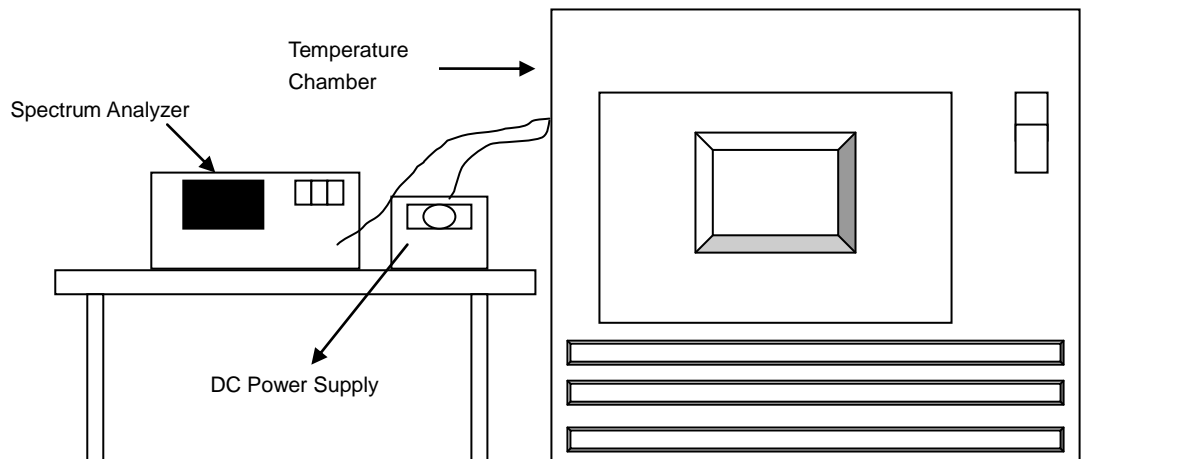

4.6.3 Test Instruments

Refer to section 4.1.3 to get information of above instrument.

4.6.4 Test Procedure

- To ensure emission at the band edge is maintained within the authorized band, those values shall be measured by radiation emissions at upper and lower frequency points, and finally compensated by frequency deviation as procedures below.
- The EUT was operated at the maximum output power, and connected to the spectrum analyzer, which is set to maximum hold function and peak detector. The peak value of the power envelope was measured and noted. The upper and lower frequency points were respectively measured relatively 10 dB lower than the measured peak value.
- The frequency deviation was calculated by adding the upper frequency point and the lower frequency point divided by two. Those detailed values of frequency deviation are provided in table below.

4.6.5 Deviation from Test Standard

No deviation.

4.6.6 EUT Operating Condition

Set the EUT transmit at un-modulation mode to test frequency stability.

4.6.7 Test Results

Frequency Stability Versus Temp.									
Operating Frequency: 5180 MHz									
Temp. (°C)	Power Supply (Vdc)	0 Minute		2 Minute		5 Minute		10 Minute	
		Measured Frequency (MHz)	Frequency Drift (ppm)	Measured Frequency (MHz)	Frequency Drift (ppm)	Measured Frequency (MHz)	Frequency Drift (ppm)	Measured Frequency (MHz)	Frequency Drift (ppm)
50	3.8	5180.0239	4.61000	5180.027	5.21000	5180.025	4.83000	5180.0231	4.46000
40	3.8	5180.0105	2.03000	5180.0126	2.43000	5180.0095	1.83000	5180.0141	2.72000
30	3.8	5179.9809	-3.69000	5179.9779	-4.27000	5179.9784	-4.17000	5179.978	-4.25000
20	3.8	5179.9835	-3.19000	5179.9839	-3.11000	5179.984	-3.09000	5179.9818	-3.51000
10	3.8	5179.9976	-0.46000	5180.0014	0.27000	5180.0001	0.02000	5179.9977	-0.44000
0	3.8	5179.9835	-3.19000	5179.9836	-3.17000	5179.9833	-3.22000	5179.9786	-4.13000
-10	3.8	5179.9862	-2.66000	5179.9858	-2.74000	5179.9858	-2.74000	5179.9853	-2.84000
-20	3.8	5180.0103	1.99000	5180.0117	2.26000	5180.0123	2.37000	5180.0088	1.70000
-30	3.8	5179.9737	-5.08000	5179.9745	-4.92000	5179.9769	-4.46000	5179.9743	-4.96000

Frequency Stability Versus Temp.									
Operating Frequency: 5180 MHz									
Temp. (°C)	Power Supply (Vdc)	0 Minute		2 Minute		5 Minute		10 Minute	
		Measured Frequency (MHz)	Frequency Drift (ppm)	Measured Frequency (MHz)	Frequency Drift (ppm)	Measured Frequency (MHz)	Frequency Drift (ppm)	Measured Frequency (MHz)	Frequency Drift (ppm)
20	4.37	5179.9829	-3.30000	5179.9833	-3.22000	5179.9848	-2.93000	5179.9821	-3.46000
	3.8	5179.9835	-3.19000	5179.9839	-3.11000	5179.984	-3.09000	5179.9818	-3.51000
	3.23	5179.9832	-3.24000	5179.984	-3.09000	5179.9833	-3.22000	5179.9822	-3.44000

4.7 6 dB Bandwidth Measurement

4.7.1 Limits of 6 dB Bandwidth Measurement

The minimum of 6 dB Bandwidth Measurement is 0.5 MHz.

4.7.2 Test Setup

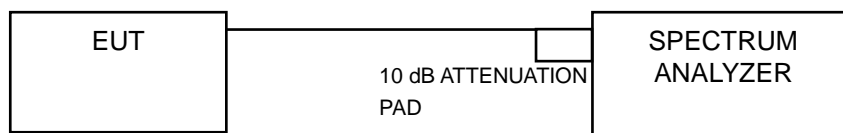

4.7.3 Test Instruments

Refer to section 4.1.3 to get information of above instrument.

4.7.4 Test Procedure

MEASUREMENT PROCEDURE REF

- Set resolution bandwidth (RBW) = 100 kHz
- Set the video bandwidth (VBW) $\geq 3 \times$ RBW, Detector = Peak.
- Trace mode = max hold.
- Sweep = auto couple.
- Measure the maximum width of the emission that is constrained by the frequencies associated with the two amplitude points (upper and lower) that are attenuated by 6 dB relative to the maximum level measured in the fundamental emission

4.7.5 Deviation from Test Standard

No deviation.

4.7.6 EUT Operating Condition

The software provided by client to enable the EUT under transmission condition continuously at lowest, middle and highest channel frequencies individually.

4.7.7 Test Results

802.11a

Channel	Frequency (MHz)	6 dB Bandwidth (MHz)	Minimum Limit (MHz)	Pass / Fail
149	5745	16.41	0.5	Pass
157	5785	16.39	0.5	Pass
165	5825	16.40	0.5	Pass

802.11n (HT20)

Channel	Frequency (MHz)	6 dB Bandwidth (MHz)	Minimum Limit (MHz)	Pass / Fail
149	5745	17.61	0.5	Pass
157	5785	17.60	0.5	Pass
165	5825	17.63	0.5	Pass

802.11n (HT40)

Channel	Frequency (MHz)	6 dB Bandwidth (MHz)	Minimum Limit (MHz)	Pass / Fail
151	5755	35.73	0.5	Pass
159	5795	35.75	0.5	Pass

Spectrum Plot of Worst Value

802.11a

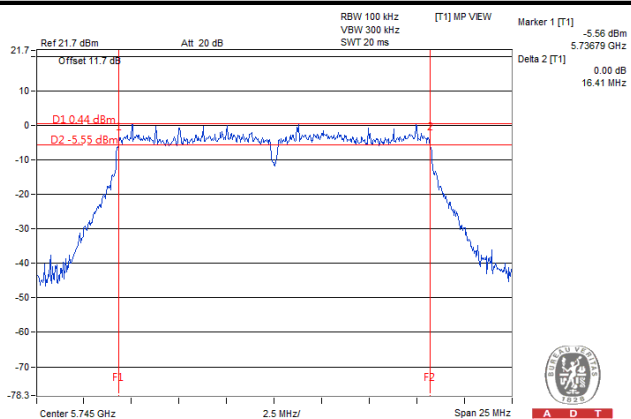

802.11n (HT20)

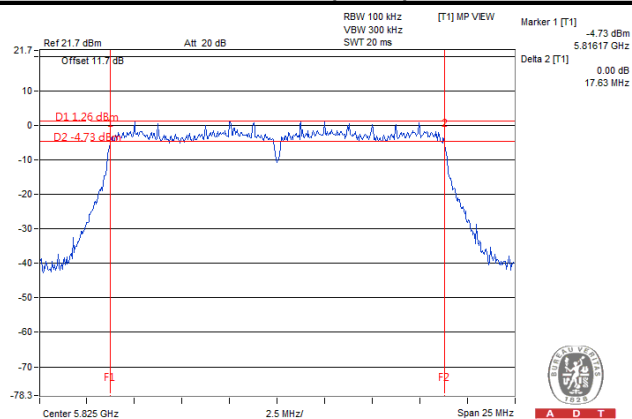

802.11n (HT40)

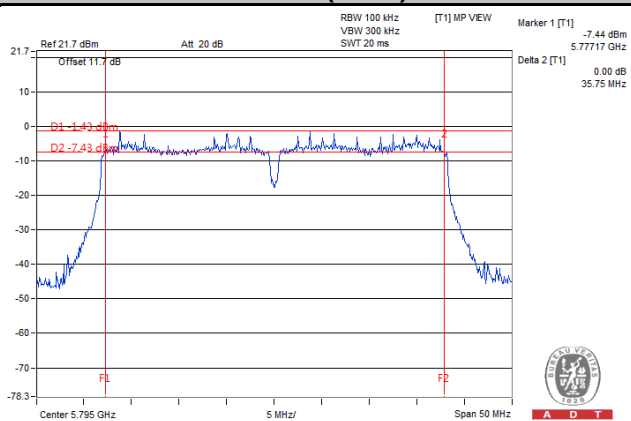

5 Pictures of Test Arrangements

Please refer to the attached file (Test Setup Photo).

Annex A- Radiated Bandedge Plots

802.11a

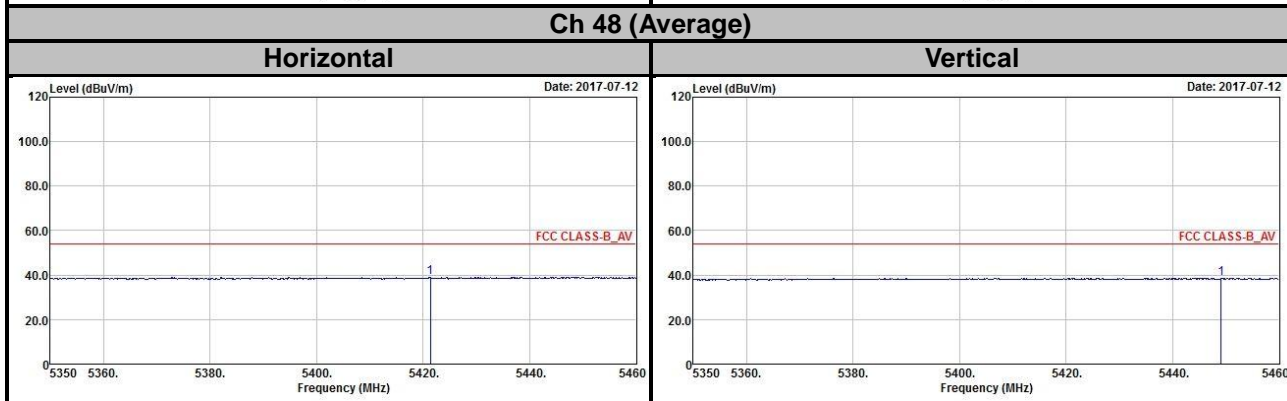
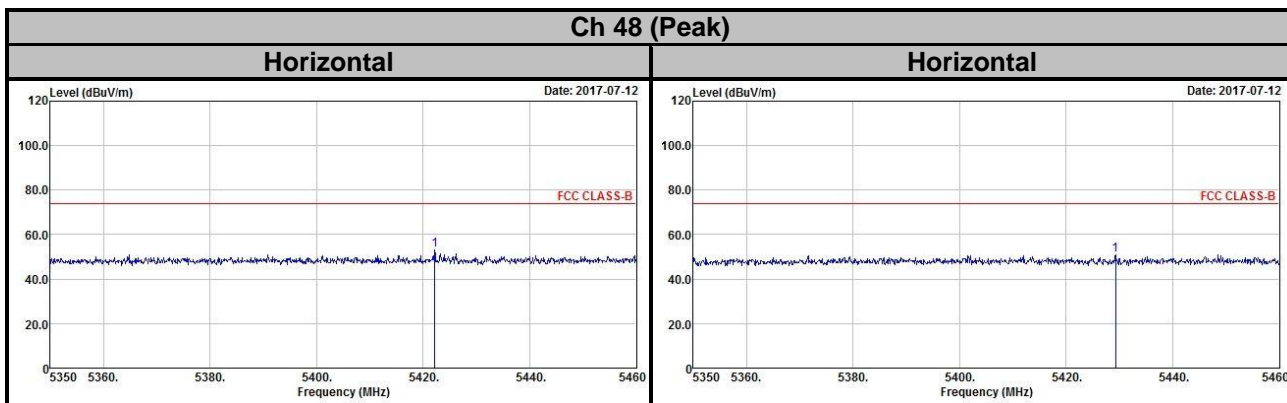
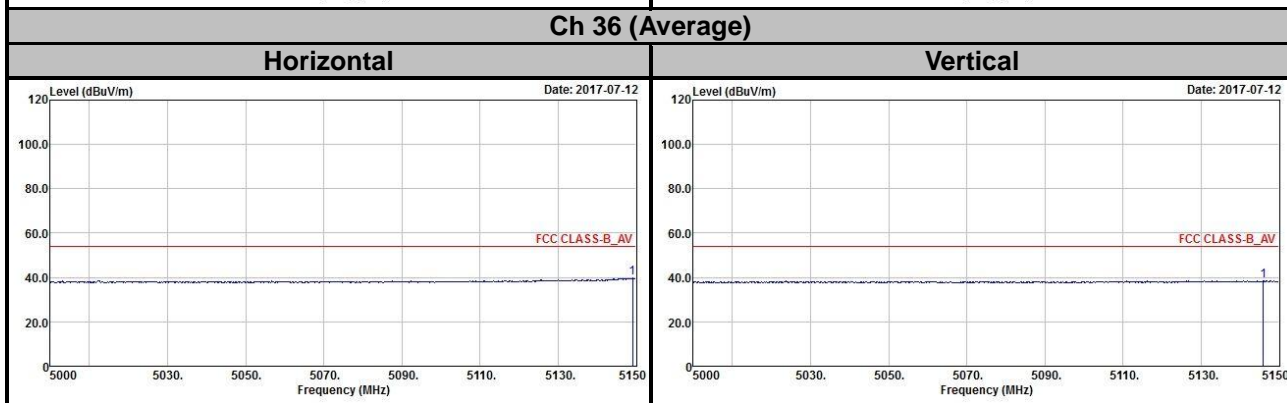
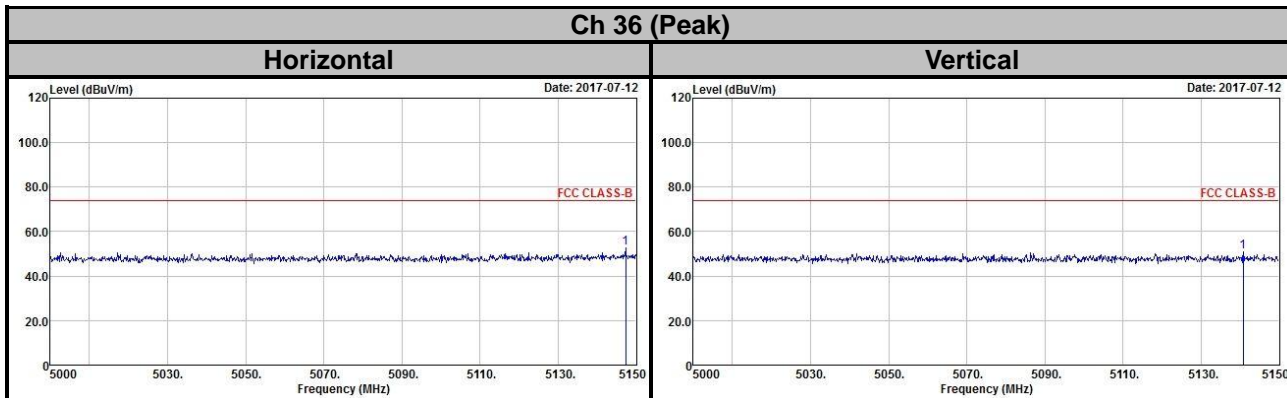

802.11n (HT20)

Ch 36 (Peak)

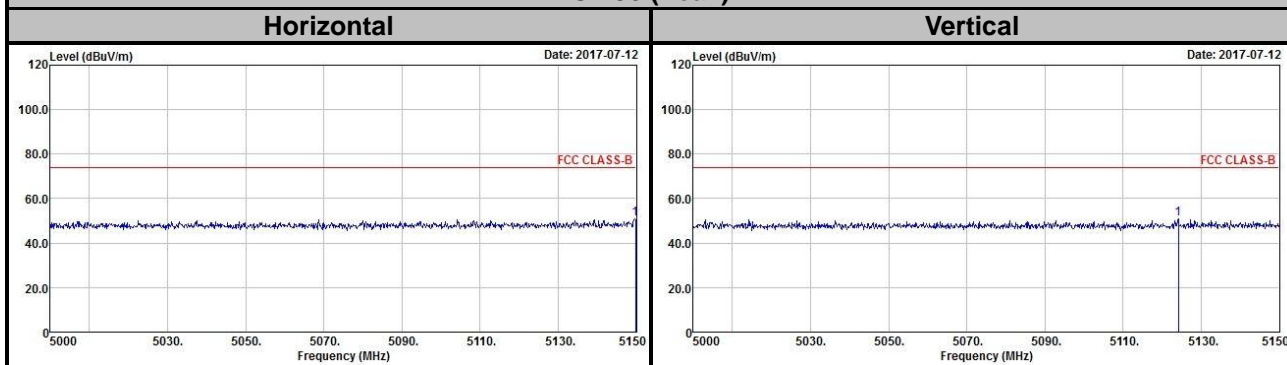

Ch 36 (Average)

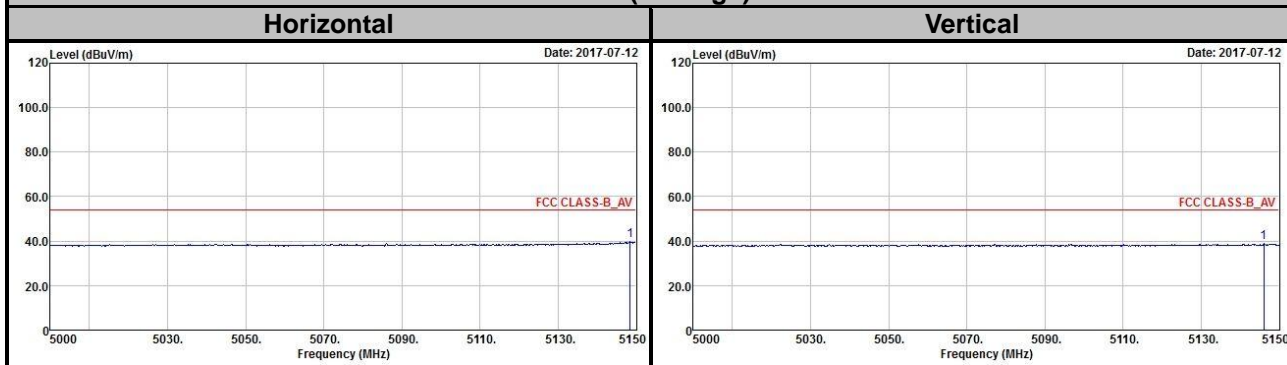

Ch 48 (Peak)

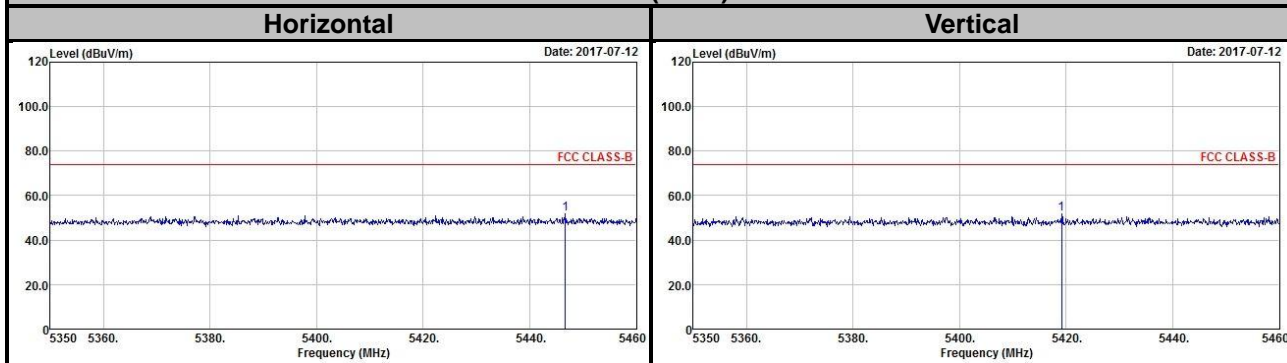

Ch 48 (Average)

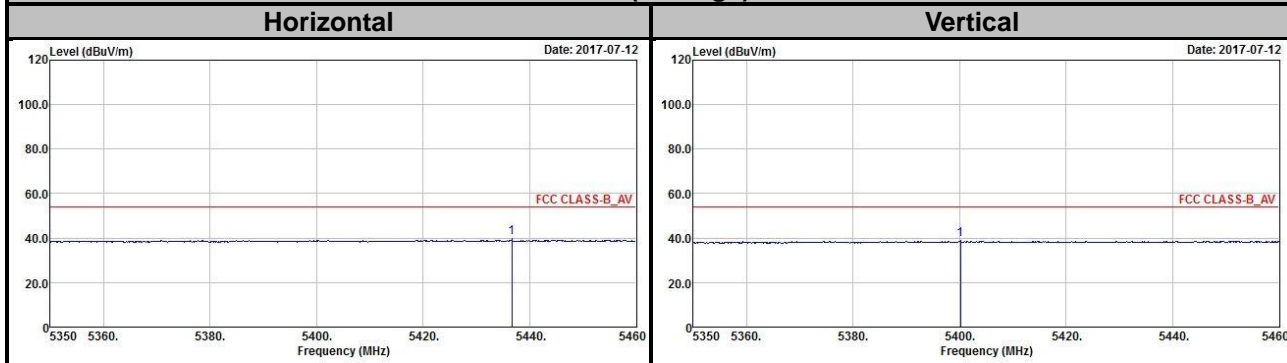

802.11n (HT40)

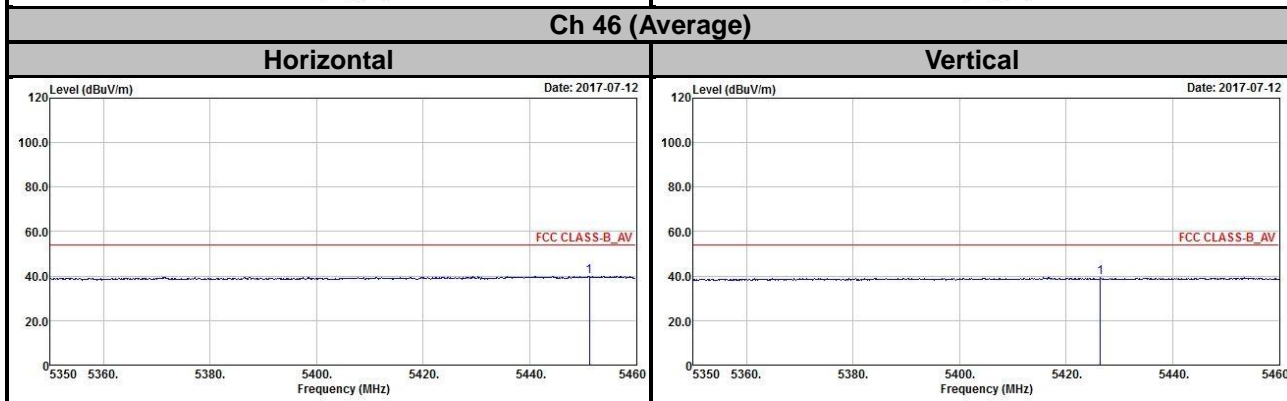
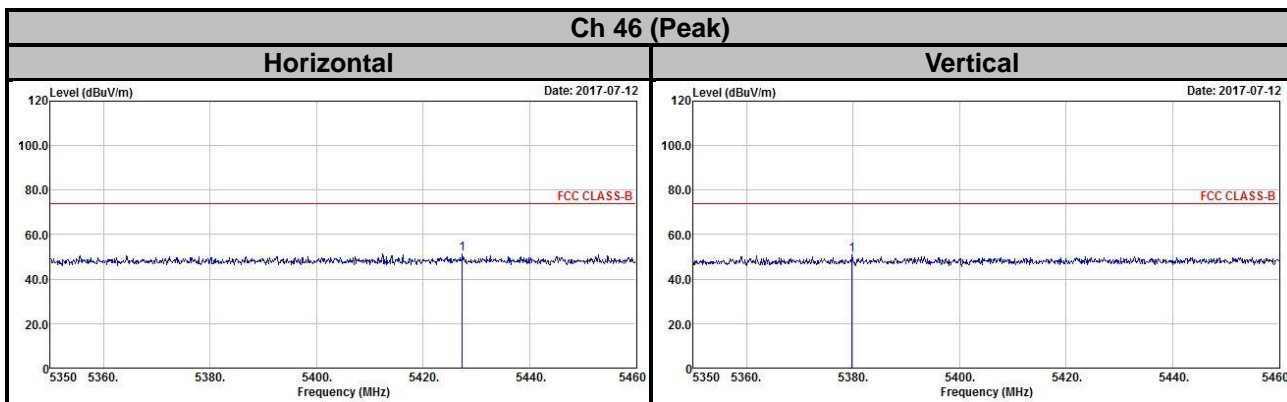
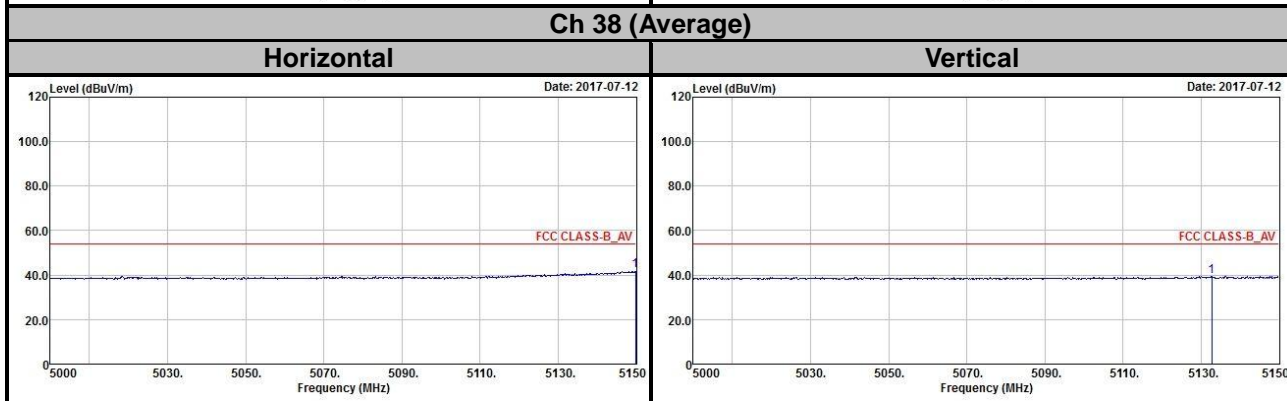
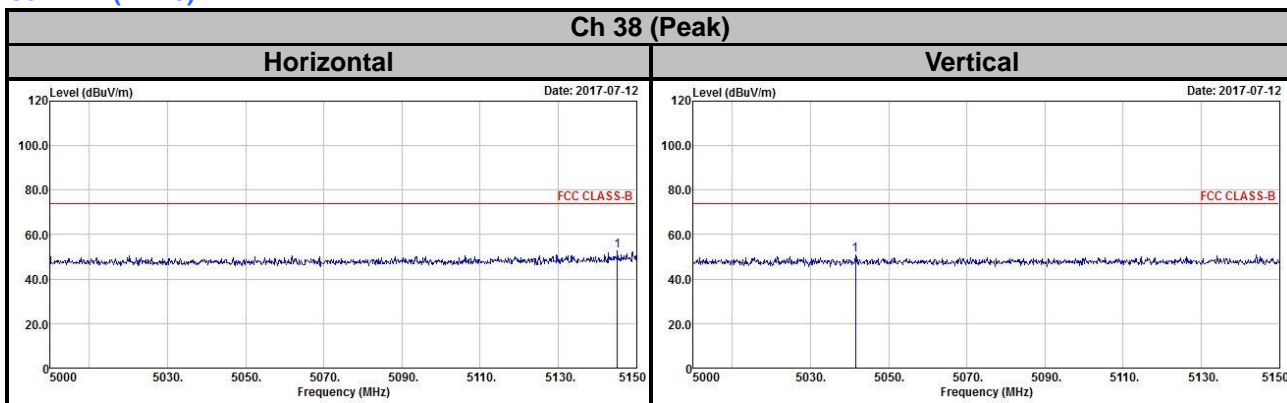

Appendix – Information on the Testing Laboratories

We, Bureau Veritas Consumer Products Services (H.K.) Ltd., Taoyuan Branch, were founded in 1988 to provide our best service in EMC, Radio, Telecom and Safety consultation. Our laboratories are FCC recognized accredited test firms and accredited according to ISO/IEC 17025.

If you have any comments, please feel free to contact us at the following:

Linko EMC/RF Lab

Tel: 886-2-26052180

Fax: 886-2-26051924

Hsin Chu EMC/RF/Telecom Lab

Tel: 886-3-6668565

Fax: 886-3-6668323

Hwa Ya EMC/RF/Safety

Tel: 886-3-3183232

Fax: 886-3-3270892

Email: service.adt@tw.bureauveritas.com

Web Site: www.bureauveritas-adt.com

The address and road map of all our labs can be found in our web site also.

--- END ---