

Block Diagram

FCC ID: A4P-200-0013-02

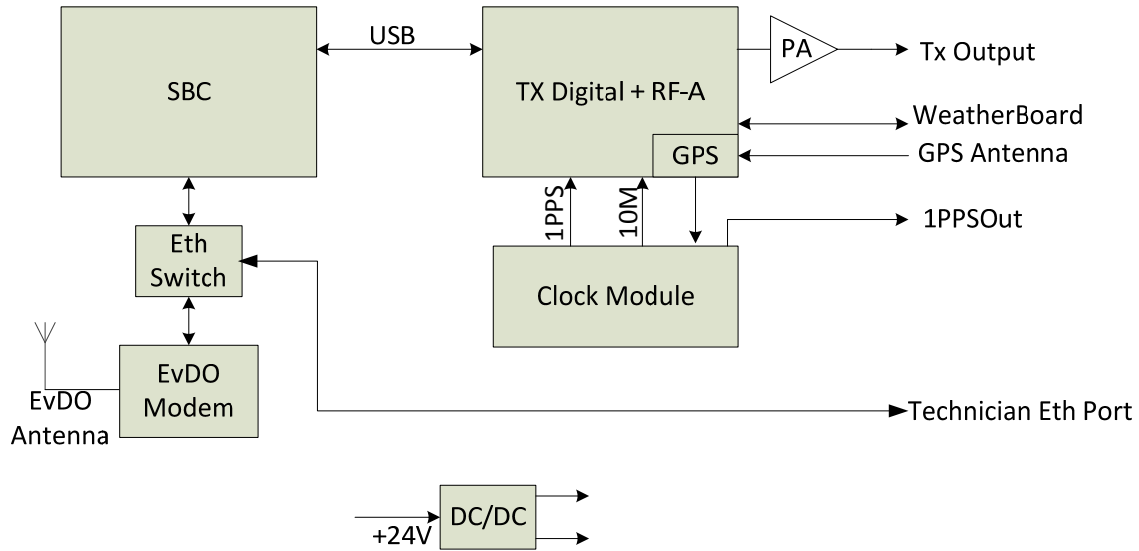

Figure 1 NextNav Local beacon block wiring diagram

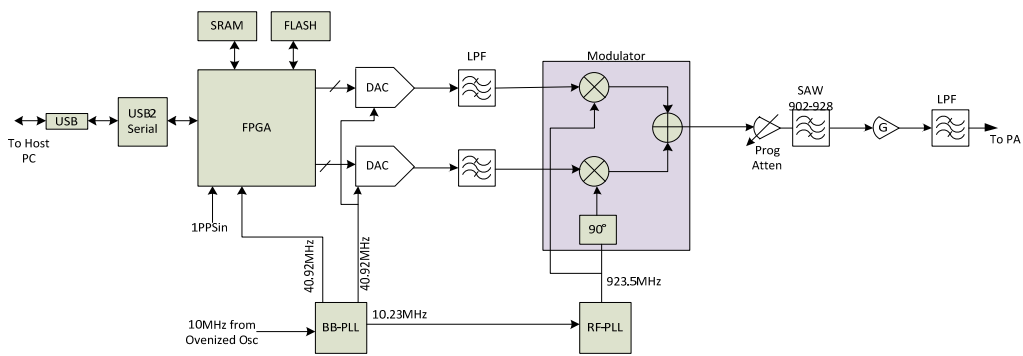

Figure 2: Maia Radio Modem Module Board Block Diagram