

FCC PART 15 SUBPART C TEST REPORT

FCC PART 15.247

Report Reference No..... : MTEB23060269-R1

FCC ID..... : A4C-10013B

Compiled by

(position+printed name+signature)..: File administrators Alisa Luo

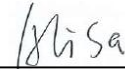

Supervised by

(position+printed name+signature)..: Test Engineer Sunny Deng



Approved by

(position+printed name+signature)..: Manager Yvette Zhou

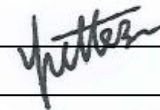

Date of issue..... : **June 27,2023**

Representative Laboratory Name. : Shenzhen Most Technology Service Co., Ltd.

Address..... : No.5, 2nd Langshan Road, North District, Hi-tech Industrial Park,
 Nanshan, Shenzhen, Guangdong, China.

Applicant's name..... : RM ACQUISITION LLC

Address..... : 8770 W. Bryn Mawr Avenue,Chicago,Illinois,United States,60631

Test specification..... :

Standard..... : **FCC Part 15.247**

TRF Originator..... : Shenzhen Most Technology Service Co., Ltd.

Shenzhen Most Technology Service Co., Ltd. All rights reserved.

This publication may be reproduced in whole or in part for non-commercial purposes as long as the Shenzhen Most Technology Service Co., Ltd. is acknowledged as copyright owner and source of the material. Shenzhen Most Technology Service Co., Ltd. takes no responsibility for and will not assume liability for damages resulting from the reader's interpretation of the reproduced material due to its placement and context.

Test item description..... : GPS Device

Trade Mark..... :

RAND M^cNALLY

Manufacturer..... : **SHEN ZHEN APICAL TECHNOLOGY CO., LTD**

Model/Type reference..... : RandTab5

Listed Models : N/A

Modulation Type..... : CCK/DSSS/ OFDM

Operation Frequency..... : From 2412 - 2462MHz

Hardware Version..... 19308-A64-01C-1

Software Version..... TND550-20210105-026

Rating..... : lithium battery:DC3.7V,
 Charge by car charger(DC5V)

Result..... : **PASS**

TEST REPORT

Equipment under Test : GPS Device

Model /Type : RandTab5

Listed Models : N/A

Remark : N/A.

Applicant : **RM ACQUISITION LLC**

Address : 8770 W. Bryn Mawr Avenue,Chicago,Illinois,United States,60631

Manufacturer : SHEN ZHEN APICAL TECHNOLOGY CO., LTD

Address : 9/F,B Building, Tinghua Unis Infoport, Langshan RD, North district, Hi-tech Industrial Park, Nanshan, Shenzhen

Test Result:	PASS
---------------------	-------------

The test report merely corresponds to the test sample.
It is not permitted to copy extracts of these test result without the written permission of the test laboratory.

Contents

1 REVISION HISTORY	4
2 TEST STANDARDS	5
3 SUMMARY	6
3.1 General Remarks	6
3.2 Product Description	6
3.3 Equipment Under Test	6
3.4 Short description of the Equipment under Test (EUT)	6
3.5 EUT operation mode	6
3.6 Block Diagram of Test Setup	7
3.7 Test Item (Equipment Under Test) Description*	7
3.8 Auxiliary Equipment (AE) Description	7
3.9 Antenna Information*	7
3.10 Related Submittal(s) / Grant (s)	7
3.11 Modifications	8
4 TEST ENVIRONMENT	9
4.1 Address of the test laboratory	9
4.2 Test Facility	9
4.3 Environmental conditions	9
4.4 Test Description	10
4.5 Statement of the measurement uncertainty	10
4.6 Equipments Used during the Test	11
5 TEST CONDITIONS AND RESULTS	12
5.1 AC Power Conducted Emission	12
5.2 Radiated Emission	13
5.3 Antenna Requirement	20
6 TEST SETUP PHOTOS OF THE EUT	21
7 PHOTOS OF THE EUT	22

1 Revision History

Revision	Issue Date	Revisions	Revised By
00	2023-06-27	Initial Issue	Alisa Luo

2 TEST STANDARDS

The tests were performed according to following standards:

[FCC Rules Part 15.247](#): Frequency Hopping, Direct Spread Spectrum and Hybrid Systems that are in operation within the bands of 902-928 MHz, 2400-2483.5 MHz, and 5725-5850 MHz.

[ANSI C63.10-2013](#): American National Standard for Testing Unlicensed Wireless Devices

[KDB558074 D01 v05r02](#): Guidance for Compliance Measurements on Digital Transmission Systems (DTS) ,Frequency Hopping Spread Spectrum System(HFSS), and Hybrid System Devices Operating Under §15.247 of The FCC rules.

3 SUMMARY

3.1 General Remarks

Date of receipt of test sample	:	2023.05.25
Testing commenced on	:	2023.05.26
Testing concluded on	:	2023.06.27

3.2 Product Description

Product Name:	GPS Device
Model/Type reference:	RandTab5
Power Supply:	DC3.7V by Battery DC 5V(by USB) DC 5V(by Car Charger)
Testing sample ID:	MTYP1601
WIFI :	
Supported type:	802.11b/802.11g/802.11n(H20)/802.11n(H40)
Modulation:	802.11b: DSSS 802.11g/802.11n(H20) /802.11n(H40): OFDM
Operation frequency:	802.11b/802.11g/802.11n(H20): 2412MHz~2462MHz 802.11n(H40): 2422MHz~2452MHz
Channel number:	802.11b/802.11g/802.11n(H20): 11 802.11b/802.11g/802.11n(H40): 7
Channel separation:	5MHz
Antenna type:	Integral Antenna with ipex connector
Antenna gain:	2.12 dBi

3.3 Equipment Under Test

Power supply system utilised

Power supply voltage	:	<input type="radio"/> 230V / 50 Hz	<input checked="" type="radio"/> 120V / 60Hz
		<input type="radio"/> 12 V DC	<input type="radio"/> 24 V DC
		<input type="radio"/> Other (specified in blank below)	

DC3.7V by Battery
DC 5V(by Car Charger)

3.4 Short description of the Equipment under Test (EUT)

This is a GPS Device.
For more details, refer to the user's manual of the EUT.

3.5 EUT operation mode

The application provider specific test software(AT command) to control sample in continuous TX and RX (Duty Cycle >98%) for testing meet KDB558074 test requirement.

IEEE 802.11b/g/n: Thirteen channels are provided to the EUT.

Channel	Frequency(MHz)	Channel	Frequency(MHz)
1	2412	8	2447
2	2417	9	2452
3	2422	10	2457
4	2427	11	2462
5	2432		
6	2437		
7	2442		

3.6 Block Diagram of Test Setup

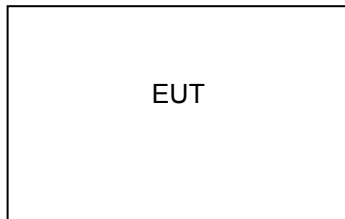

3.7 Test Item (Equipment Under Test) Description*

Short designation	EUT Name	EUT Description	Serial number	Hardware status	Software status
EUT A	/	/	/	/	/
EUT B	/	/	/	/	/

*: declared by the applicant. According to customers information EUTs A and B are the same devices.

3.8 Auxiliary Equipment (AE) Description

AE short designation	EUT Name (if available)	EUT Description	Serial number (if available)	Software (if used)
AE 1	-/	/	/	/
AE 2	-/	/	/	/

3.9 Antenna Information*

Short designation	Antenna Name	Antenna Type	Frequency Range	Serial number	Antenna Peak Gain
Antenna 1	---	Integral Antenna with ipex connector	2.4 – 2.5 GHz	---	2.12dBi
Antenna 2					

*: declared by the applicant.

3.10 Related Submittal(s) / Grant (s)

This submittal(s) (test report) is intended for **FCC ID: 2A33W-D22** filing to comply with Section 15.247 of the FCC Part 15, Subpart C Rules.

3.11 Modifications

No modifications were implemented to meet testing criteria.

4 TEST ENVIRONMENT

4.1 Address of the test laboratory

Shenzhen Most Technology Service Co., Ltd.

No.5, 2nd Langshan Road, North District, Hi-tech Industrial Park, Nanshan, Shenzhen, Guangdong, China.
The 3m-Semi anechoic test site fulfils CISPR 16-1-4 according to ANSI C63.4:2014 and CISPR 16-1-4:2010 SVSWR requirement for radiated emission above 1GHz.

4.2 Test Facility

The test facility is recognized, certified, or accredited by the following organizations:

FCC-Registration No.: 0031192610

Shenzhen Most Technology Service Co., Ltd. EMC Laboratory has been registered and fully described in a report filed with the (FCC) Federal Communications Commission. The acceptance letter from the FCC is maintained in our files.

A2LA-Lab Cert. No.: 6343.01

Shenzhen Most Technology Service Co., Ltd. EMC Laboratory has been accredited by A2LA for technical competence in the field of electrical testing, and proved to be in compliance with ISO/IEC 17025: 2005 General Requirements for the Competence of Testing and Calibration Laboratories and any additional program requirements in the identified field of testing.

4.3 Environmental conditions

Radiated Emission:

Temperature:	24 ° C
Humidity:	48 %
Atmospheric pressure:	950-1050mbar

AC Main Conducted testing:

Temperature:	24 ° C
Humidity:	45 %
Atmospheric pressure:	950-1050mbar

Conducted testing:

Temperature:	24 ° C
Humidity:	45 %
Atmospheric pressure:	950-1050mbar

4.4 Test Description

FCC PART 15.247		
FCC Part 15.207	AC Power Conducted Emission	N/A
FCC Part 15.109/ 15.205/ 15.209	Radiated Emissions	PASS

Data Rate Used:

Preliminary tests were performed in different data rate to find the worst radiated emission. The data rate shown in the table below is the worst-case rate with respect to the specific test item. Investigation has been done on all the possible configurations for searching the worst cases. The following table is a list of the test modes shown in this test report.

Test Items	Mode	Data Rate	Channel
Maximum Peak Conducted Output Power Power Spectral Density 6dB Bandwidth Spurious RF conducted emission Radiated Emission 9KHz~1GHz& Radiated Emission 1GHz~10 th Harmonic	11b/DSSS	1 Mbps	1/6/11
	11g/OFDM	6 Mbps	1/6/11
	11n(20MHz)/OFDM	6.5Mbps	1/6/11
	11n(40MHz)/OFDM	6.5Mbps	3/6/9
Band Edge	11b/DSSS	1 Mbps	1/11
	11g/OFDM	6 Mbps	1/11
	11n(20MHz)/OFDM	6.5Mbps	1/11
	11n(40MHz)/OFDM	6.5Mbps	3/9

4.5 Statement of the measurement uncertainty

The data and results referenced in this document are true and accurate. The reader is cautioned that there may be errors within the calibration limits of the equipment and facilities. The measurement uncertainty was calculated for all measurements listed in this test report acc. to CISPR 16 - 4 „Specification for radio disturbance and immunity measuring apparatus and methods – Part 4: Uncertainty in EMC Measurements“ and is documented in the Shenzhen Most Technology Service Co., Ltd. quality system acc. to DIN EN ISO/IEC 17025. Furthermore, component and process variability of devices similar to that tested may result in additional deviation. The manufacturer has the sole responsibility of continued compliance of the device.

Hereafter the best measurement capability for Shenzhen Most Technology Service Co., Ltd. is reported:

Test	Range	Measurement Uncertainty	Notes
Radiated Emission	30~1000MHz	4.10 dB	(1)
Radiated Emission	1~18GHz	4.32 dB	(1)
Radiated Emission	18-40GHz	5.54 dB	(1)
Conducted Disturbance	0.15~30MHz	3.12 dB	(1)

(1) This uncertainty represents an expanded uncertainty expressed at approximately the 95% confidence level using a coverage factor of k=2.

4.6 Equipments Used during the Test

Item	Equipment	Manufacturer	Model No.	Serial No.	Firmware versions	Last Cal.	Cal. Interval
1.	L.I.S.N.	R&S	ENV216	100093	/	2023/03/17	1 Year
2	Three-phase artificial power network	Schwarzback Mess	NNLK8129	8129178	/	2023/03/17	1 Year
3.	Receiver	R&S	ESCI	100492	V3.0-10-2	2023/03/17	1 Year
4	Receiver	R&S	ESPI	101202	V3.0-10-2	2023/03/17	1 Year
5	Spectrum analyzer	Agilent	9020A	MT-E306	A14.16	2023/03/17	1 Year
6	Bilong Antenna	Sunol Sciences	JB3	A121206	/	2023/03/17	1 Year
7	Horn antenna	HF Antenna	HF Antenna	MT-E158	/	2023/03/17	1 Year
8	Loop antenna	Beijing Daze	ZN30900B	/	/	2023/03/17	1 Year
9	Horn antenna	R&S	OBH100400	26999002	/	2023/03/17	1 Year
10	Wireless Communication Test Set	R&S	CMW500	/	CMW-BASE-3.7.21	2023/03/17	1 Year
11	Spectrum analyzer	R&S	FSP	100019	V4.40 SP2	2023/03/17	1 Year
12	High gain antenna	Schwarzbeck	LB-180400KF	MT-E389	/	2023/03/17	1 Year
13	Preamplifier	Schwarzbeck	BBV 9743	MT-E390	/	2023/03/17	1 Year
14	Pre-amplifier	EMCI	EMC051845S E	MT-E391	/	2023/03/17	1 Year
15	Pre-amplifier	Agilent	83051A	MT-E392	/	2023/03/17	1 Year
16	High pass filter unit	Tonscend	JS0806-F	MT-E393	/	2023/03/17	1 Year
17	RF Cable(below1GHz)	Times	9kHz-1GHz	MT-E394	/	2023/03/17	1 Year
18	RF Cable(above 1GHz)	Times	1-40G	MT-E395	/	2023/03/17	1 Year
19	RF Cable (9KHz-40GHz)	Tonscend	170660	N/A	/	2023/03/17	1 Year

Note: The Cal.Interval was one year.

5 TEST CONDITIONS AND RESULTS

5.1 AC Power Conducted Emission

TEST CONFIGURATION



TEST PROCEDURE

- 1 The equipment was set up as per the test configuration to simulate typical actual usage per the user's manual. The EUT is a tabletop system, a wooden table with a height of 0.8 meters is used and is placed on the ground plane as per ANSI C63.10-2013.
- 2 Support equipment, if needed, was placed as per ANSI C63.10-2013
- 3 All I/O cables were positioned to simulate typical actual usage as per ANSI C63.10-2013
- 4 The EUT received DC 12V power from adapter, the adapter received AC120V/60Hz and AC 240V/60Hz power through a Line Impedance Stabilization Network (LISN) which supplied power source and was grounded to the ground plane.
- 5 All support equipments received AC power from a second LISN, if any.
- 6 The EUT test program was started. Emissions were measured on each current carrying line of the EUT using a spectrum Analyzer / Receiver connected to the LISN powering the EUT. The LISN has two monitoring points: Line 1 (Hot Side) and Line 2 (Neutral Side). Two scans were taken: one with Line 1 connected to Analyzer / Receiver and Line 2 connected to a 50 ohm load; the second scan had Line 1 connected to a 50 ohm load and Line 2 connected to the Analyzer / Receiver.
- 7 Analyzer / Receiver scanned from 150 KHz to 30MHz for emissions in each of the test modes.
- 8 During the above scans, the emissions were maximized by cable manipulation.

AC Power Conducted Emission Limit

For intentional device, according to § 15.207(a) AC Power Conducted Emission Limits is as following :

Frequency range (MHz)	Limit (dBuV)	
	Quasi-peak	Average
0.15-0.5	66 to 56*	56 to 46*
0.5-5	56	46
5-30	60	50

* Decreases with the logarithm of the frequency.

TEST RESULTS

N/A

5.2 Radiated Emission

TEST CONFIGURATION

Frequency range 9 KHz – 30MHz

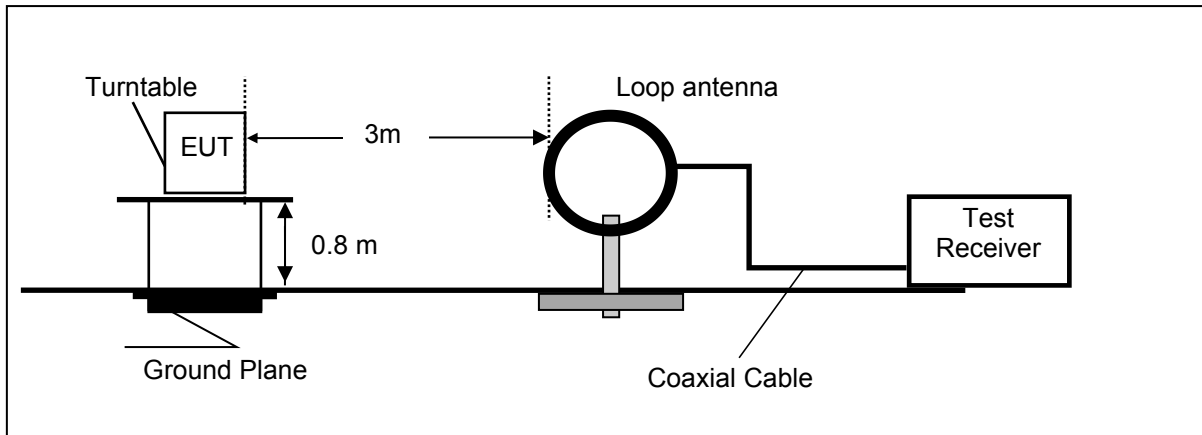

Frequency range 30MHz – 1000MHz

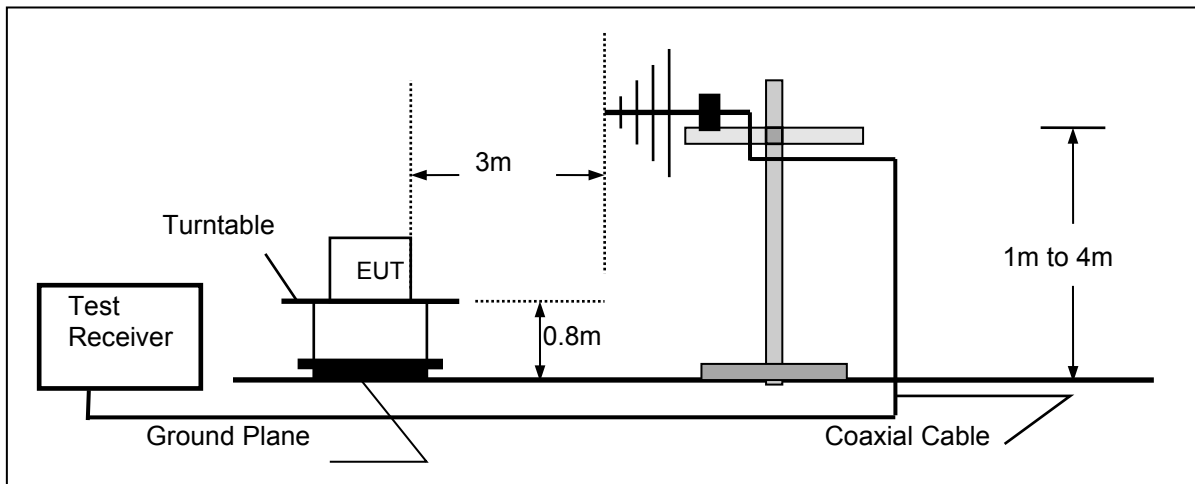

Frequency range above 1GHz-25GHz

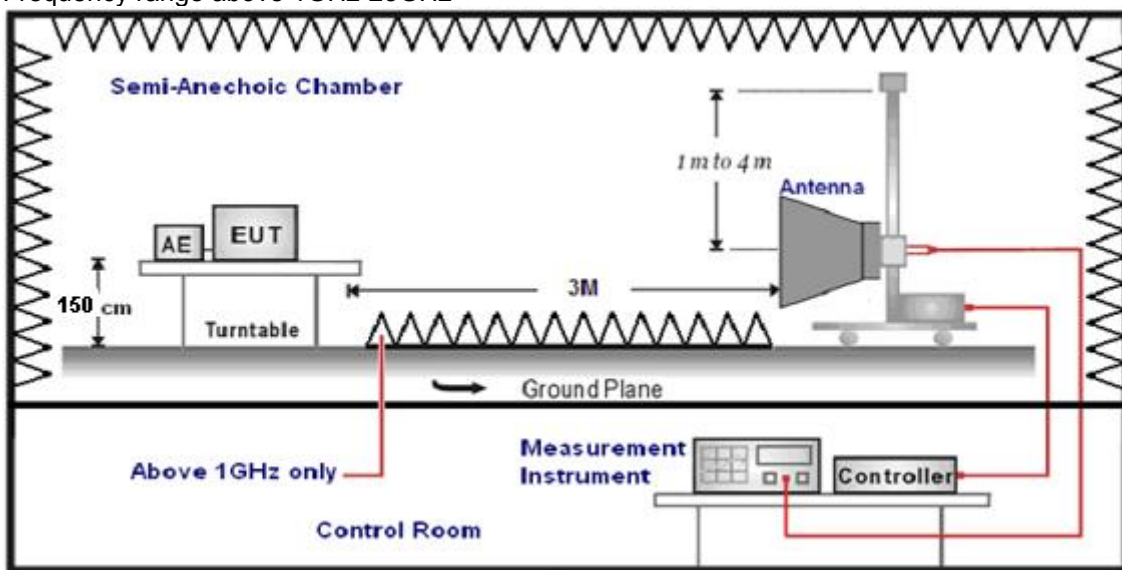

TEST PROCEDURE

- The EUT was placed on a turn table which is 0.8m above ground plane when testing frequency range 9 KHz –1GHz;the EUT was placed on a turn table which is 1.5m above ground plane when testing frequency range 1GHz – 25GHz.
- Maximum procedure was performed by raising the receiving antenna from 1m to 4m and rotating the turn table from 0° to 360° to acquire the highest emissions from EUT.
- And also, each emission was to be maximized by changing the polarization of receiving antenna both horizontal and vertical.
- Repeat above procedures until all frequency measurements have been completed.
- Radiated emission test frequency band from 9KHz to 25GHz.
- The distance between test antenna and EUT as following table states:

Test Frequency range	Test Antenna Type	Test Distance
9KHz-30MHz	Active Loop Antenna	3
30MHz-1GHz	Ultra-Broadband Antenna	3
1GHz-18GHz	Double Ridged Horn Antenna	3
18GHz-25GHz	Horn Antenna	1

- Setting test receiver/spectrum as following table states:

Test Frequency range	Test Receiver/Spectrum Setting	Detector
9KHz-150KHz	RBW=200Hz/VBW=3KHz,Sweep time=Auto	QP
150KHz-30MHz	RBW=9KHz/VBW=100KHz,Sweep time=Auto	QP
30MHz-1GHz	RBW=120KHz/VBW=1000KHz,Sweep time=Auto	QP
1GHz-40GHz	Peak Value: RBW=1MHz/VBW=3MHz, Sweep time=Auto Average Value: RBW=1MHz/VBW=10Hz, Sweep time=Auto	Peak

Field Strength Calculation

The field strength is calculated by adding the Antenna Factor and Cable Factor and subtracting the Amplifier Gain and Duty Cycle Correction Factor(if any) from the measured reading. The basic equation with a sample calculation is as follows:

$$FS = RA + AF + CL - AG$$

Where	FS = Field Strength	CL = Cable Attenuation Factor (Cable Loss)
	RA = Reading Amplitude	AG = Amplifier Gain
	AF = Antenna Factor	

$$Transd=AF +CL-AG$$

RADIATION LIMIT

For intentional device, according to § 15.209(a), the general requirement of field strength of radiated emission from intentional radiators at a distance of 3 meters shall not exceed the following table. According to § 15.247(d), in any 100kHz bandwidth outside the frequency band in which the EUT is operating, the radio frequency power that is produced by the intentional radiator shall be at least 20dB below that in the100kHz bandwidth within the band that contains the highest level of desired power.

The pre-test have done for the EUT in three axes and found the worst emission at position shown in test setup photos.

Frequency (MHz)	Distance (Meters)	Radiated (dBµV/m)	Radiated (µV/m)
0.009-0.49	3	20log(2400/F(KHz))+40log(300/3)	2400/F(KHz)
0.49-1.705	3	20log(24000/F(KHz))+ 40log(30/3)	24000/F(KHz)
1.705-30	3	20log(30)+ 40log(30/3)	30
30-88	3	40.0	100
88-216	3	43.5	150
216-960	3	46.0	200
Above 960	3	54.0	500

TEST RESULTS

Remark:

1. This test was performed with EUT in X, Y, Z position and the worse case was found when EUT in X position.
2. All three channels (lowest/middle/highest) of each mode were measured below 1GHz and recorded worst case at 802.11b low channel.
3. Radiated emission test from 9 KHz to 10th harmonic of fundamental was verified, and no emission found except system noise floor in 9 KHz to 30MHz and not recorded in this report.
4. Remark: Result=Reading value+Factor

For 30MHz-1GHz

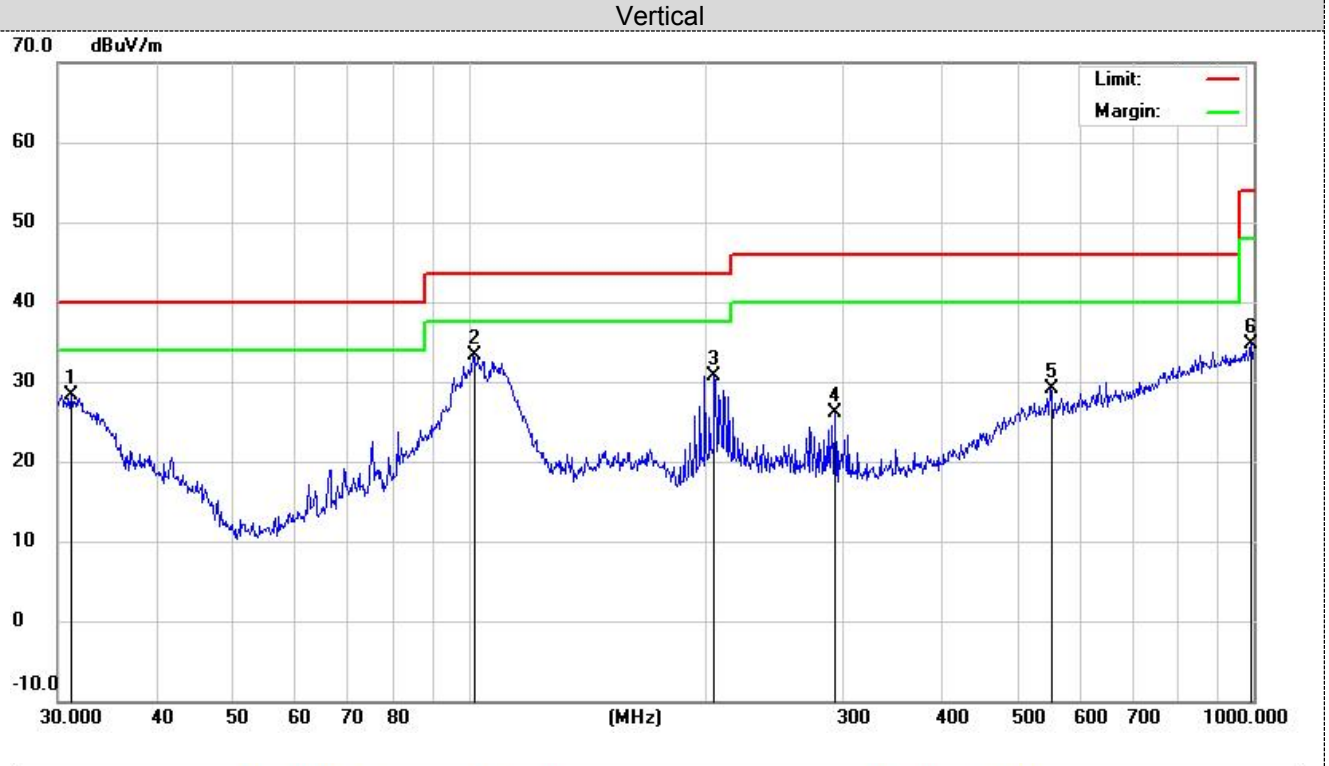

No.	Mk.	Freq.	Reading Level	Correct Factor	Measurement	Limit	Over	Antenna Height	Table Degree	
		MHz	dBuV	dB	dBuV/m	dBuV/m	dB	cm	degree	Comment
1		31.1797	8.30	20.10	28.40	40.00	-11.60	QP	100	50
2	*	101.2885	19.49	13.74	33.23	43.50	-10.27	QP	100	120
3		205.6750	15.66	15.04	30.70	43.50	-12.80	QP	100	145
4		293.0842	10.77	15.26	26.03	46.00	-19.97	QP	100	190
5		550.9480	5.88	23.26	29.14	46.00	-16.86	QP	100	230
6		993.0114	4.76	29.93	34.69	54.00	-19.31	QP	100	310

*:Maximum data x:Over limit !:over margin

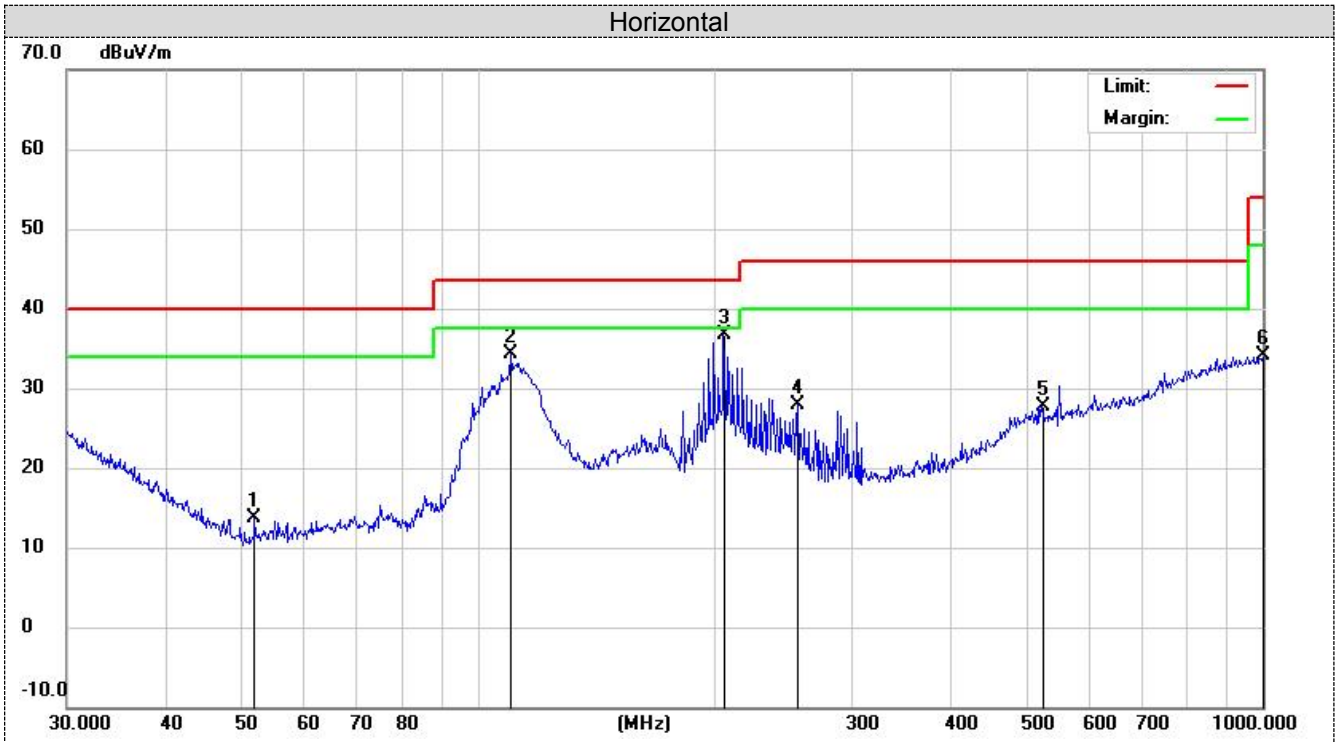

No.	Mk.	Freq. MHz	Reading Level dBuV	Correct Factor dB	Measure- ment dBuV/m	Limit dBuV/m	Over dB	Antenna Height cm	Table Degree	Comment
1		52.0251	5.41	8.20	13.61	40.00	-26.39	QP	200	310
2		110.1816	19.53	14.72	34.25	43.50	-9.25	QP	200	20
3	*	205.6751	21.65	15.04	36.69	43.50	-6.81	QP	200	90
4		255.6231	13.84	13.99	27.83	46.00	-18.17	QP	200	130
5		522.7180	4.69	22.95	27.64	46.00	-18.36	QP	200	180
6		1000.000	4.03	30.00	34.03	54.00	-19.97	QP	200	220

*:Maximum data x:Over limit !:over margin

For 1GHz to 25GHz

Note: 802.11b/802.11g/802.11n (H20)/ 802.11n (H40) all have been tested, only worse case 802.11b mode is reported

Polar (H/V)	Frequency	Meter Reading	Antenna Factor	Cable loss	Preamp factor	Emission Level	Limits	Margin	Detector Type
	(MHz)	(dBuV)	(dB)	(dB)	(dB)	(dBuV/m)	(dBuV/m)	(dB)	
802.11b-2412MHz									
V	4824	56.53	30.28	7.01	36.5	57.32	74	16.68	PK
V	4824	44.72	30.28	7.01	36.5	45.51	54	8.49	AV
H	4824	56.39	30.28	7.01	36.5	57.18	74	16.82	PK
H	4824	44.49	30.28	7.01	36.5	45.28	54	8.72	AV
V	7236	43.7	36.59	8.91	35.3	53.9	74	20.1	PK
V	7236	30.02	36.59	8.91	35.3	40.22	54	13.78	AV
H	7236	43.99	36.59	8.91	35.3	54.19	74	19.81	PK
H	7236	31.77	36.59	8.91	35.3	41.97	54	12.03	AV
802.11b -2437MHz									
V	4874	53.99	30.36	7.62	36.5	55.47	74	18.53	PK
V	4874	41.25	30.36	7.62	36.5	42.73	54	11.27	AV
H	4874	54.48	30.36	7.62	36.5	55.96	74	18.04	PK
H	4874	40.12	30.36	7.62	36.5	41.6	54	12.4	AV
V	7311	41.29	36.61	8.84	35.3	51.44	74	22.56	PK
V	7311	30.48	36.61	8.84	35.3	40.63	54	13.37	AV
H	7311	41.75	36.61	8.84	35.3	51.9	74	22.1	PK
H	7311	30.73	36.61	8.84	35.3	40.88	54	13.12	AV
802.11b -2462MHz									
V	4924	56.53	30.43	7.94	36.2	58.7	74	15.3	PK
V	4924	40.12	30.43	7.94	36.2	42.29	54	11.71	AV
H	4924	55.89	30.43	7.94	36.2	58.06	74	15.94	PK
H	4924	44	30.43	7.94	36.2	46.17	54	7.83	AV
V	7386	43.9	36.78	8.45	35.3	53.83	74	20.17	PK
V	7386	29.61	36.78	8.45	35.3	39.54	54	14.46	AV
H	7386	40	36.78	8.45	35.3	49.93	74	24.07	PK
H	7386	29.99	36.78	8.45	35.3	39.92	54	14.08	AV

Note:

- 1) Emission level (dBuV/m) = Meter Reading+ antenna Factor+ cable loss- preamp factor.
- 2) Margin value = Limits-Emission level.
- 3) -- Mean the PK detector measured value is below average limit.
- 4) The other emission levels were very low against the limit.
- 5) RBW1MHz VBW3MHz Peak detector is for PK value; RBW 1MHz VBW10Hz Peak detector is for AV value.

Results of Band Edges Test (Radiated)

Polar (H/V)	Frequency	Meter Reading	Antenna Factor	Cable loss	Preamp factor	Emission Level	Limits	Margin	Detector Type
	(MHz)	(dBuV)	(dB)	(dB)	(dB)	(dBuV/m)	(dBuV/m)	(dB)	
802.11b -2412MHz									
V	2390	56.65	27.49	3.32	36.22	51.24	74	22.76	PK
V	2390	45.79	27.49	3.32	36.22	40.38	54	13.62	AV
H	2390	57.22	27.49	3.32	36.22	51.81	74	22.19	PK
H	2390	43.77	27.49	3.32	36.22	38.36	54	15.64	AV
V	2400	55.27	27.55	3.41	36.22	50.01	74	23.99	PK
V	2400	44.95	27.55	3.41	36.22	39.69	54	14.31	AV
H	2400	56.14	27.55	3.41	36.22	50.88	74	23.12	PK
H	2400	47.45	27.55	3.41	36.22	42.19	54	11.81	AV
802.11b -2462MHz									
V	2483.5	59.55	27.45	3.38	36.34	54.04	74	19.96	PK
V	2483.5	43.59	27.45	3.38	36.34	38.08	54	15.92	AV
H	2483.5	55.83	27.45	3.38	36.34	50.32	74	23.68	PK
H	2483.5	45.39	27.45	3.38	36.34	39.88	54	14.12	AV
V	2500	58.39	27.41	3.47	36.35	52.92	74	21.08	PK
V	2500	46.38	27.41	3.47	36.35	40.91	54	13.09	AV
H	2500	56.55	27.41	3.47	36.35	51.08	74	22.92	PK
H	2500	44.37	27.41	3.47	36.35	38.9	54	15.1	AV

Polar (H/V)	Frequency	Meter Reading	Antenna Factor	Cable loss	Preamp factor	Emission Level	Limits	Margin	Detector Type
	(MHz)	(dBuV)	(dB)	(dB)	(dB)	(dBuV/m)	(dBuV/m)	(dB)	
802.11g -2412MHz									
V	2390	58.72	27.49	3.32	36.22	53.31	74	20.69	PK
V	2390	43.81	27.49	3.32	36.22	38.4	54	15.6	AV
H	2390	56.95	27.49	3.32	36.22	51.54	74	22.46	PK
H	2390	43.33	27.49	3.32	36.22	37.92	54	16.08	AV
V	2400	57.26	27.55	3.41	36.22	52	74	22	PK
V	2400	46.89	27.55	3.41	36.22	41.63	54	12.37	AV
H	2400	59.66	27.55	3.41	36.22	54.4	74	19.6	PK
H	2400	45.52	27.55	3.41	36.22	40.26	54	13.74	AV
802.11g -2462MHz									
V	2483.5	55.65	27.45	3.38	36.34	50.14	74	23.86	PK
V	2483.5	43.64	27.45	3.38	36.34	38.13	54	15.87	AV
H	2483.5	55.88	27.45	3.38	36.34	50.37	74	23.63	PK
H	2483.5	43.82	27.45	3.38	36.34	38.31	54	15.69	AV
V	2500	59.62	27.41	3.47	36.35	54.15	74	19.85	PK
V	2500	45.93	27.41	3.47	36.35	40.46	54	13.54	AV
H	2500	57.13	27.41	3.47	36.35	51.66	74	22.34	PK
H	2500	46.59	27.41	3.47	36.35	41.12	54	12.88	AV

Polar (H/V)	Frequency	Meter Reading	Antenna Factor	Cable loss	Preamp factor	Emission Level	Limits	Margin	Detector Type
	(MHz)	(dBuV)	(dB)	(dB)	(dB)	(dBuV/m)	(dBuV/m)	(dB)	
802.11n(HT20) -2412MHz									
V	2390	56.66	27.49	3.32	36.22	51.25	74	22.75	PK
V	2390	43.48	27.49	3.32	36.22	38.07	54	15.93	AV
H	2390	59.01	27.49	3.32	36.22	53.6	74	20.4	PK
H	2390	46.73	27.49	3.32	36.22	41.32	54	12.68	AV
V	2400	55.11	27.55	3.41	36.22	49.85	74	24.15	PK
V	2400	47.21	27.55	3.41	36.22	41.95	54	12.05	AV
H	2400	56.24	27.55	3.41	36.22	50.98	74	23.02	PK
H	2400	44.87	27.55	3.41	36.22	39.61	54	14.39	AV
802.11n(HT20) -2462MHz									
V	2483.5	57.5	27.45	3.38	36.34	51.99	74	22.01	PK
V	2483.5	43.22	27.45	3.38	36.34	37.71	54	16.29	AV
H	2483.5	59.79	27.45	3.38	36.34	54.28	74	19.72	PK
H	2483.5	43.62	27.45	3.38	36.34	38.11	54	15.89	AV
V	2500	57.46	27.41	3.47	36.35	51.99	74	22.01	PK
V	2500	45.64	27.41	3.47	36.35	40.17	54	13.83	AV
H	2500	58.68	27.41	3.47	36.35	53.21	74	20.79	PK
H	2500	47.02	27.41	3.47	36.35	41.55	54	12.45	AV

Polar (H/V)	Frequency	Meter Reading	Antenna Factor	Cable loss	Preamp factor	Emission Level	Limits	Margin	Detector Type
	(MHz)	(dBuV)	(dB)	(dB)	(dB)	(dBuV/m)	(dBuV/m)	(dB)	
802.11n(HT20) -2422MHz									
V	2390	58.46	27.49	3.32	36.22	53.05	74	20.95	PK
V	2390	45.58	27.49	3.32	36.22	40.17	54	13.83	AV
H	2390	58.06	27.49	3.32	36.22	52.65	74	21.35	PK
H	2390	47.88	27.49	3.32	36.22	42.47	54	11.53	AV
V	2400	58.62	27.55	3.41	36.22	53.36	74	20.64	PK
V	2400	44.14	27.55	3.41	36.22	38.88	54	15.12	AV
H	2400	55.99	27.55	3.41	36.22	50.73	74	23.27	PK
H	2400	46.33	27.55	3.41	36.22	41.07	54	12.93	AV
802.11n(HT20) -2452MHz									
V	2483.5	55.41	27.45	3.38	36.34	49.9	74	24.1	PK
V	2483.5	44.2	27.45	3.38	36.34	38.69	54	15.31	AV
H	2483.5	56.6	27.45	3.38	36.34	51.09	74	22.91	PK
H	2483.5	46.4	27.45	3.38	36.34	40.89	54	13.11	AV
V	2500	55.27	27.41	3.47	36.35	49.8	74	24.2	PK
V	2500	47.45	27.41	3.47	36.35	41.98	54	12.02	AV
H	2500	57.52	27.41	3.47	36.35	52.05	74	21.95	PK
H	2500	45.55	27.41	3.47	36.35	40.08	54	13.92	AV

Note:

- 1) Emission level (dBuV/m) = Meter Reading+ antenna Factor+ cable loss- preamp factor.
- 2) Margin value = Limits-Emission level.
- 3) -- Mean the PK detector measured value is below average limit.
- 4) The other emission levels were very low against the limit.
- 5) RBW1MHz VBW3MHz Peak detector is for PK value; RBW 1MHz VBW10Hz Peak detector is for AV value.

5.3 Antenna Requirement

Standard Applicable

For intentional device, according to FCC 47 CFR Section 15.203:

An intentional radiator shall be designed to ensure that no antenna other than that furnished by the responsible party shall be used with the device. The use of a permanently attached antenna or of an antenna that uses a unique coupling to the intentional radiator, the manufacturer may design the unit so that a broken antenna can be replaced by the user, but the use of a standard antenna jack or electrical connector is prohibited

FCC CFR Title 47 Part 15 Subpart C Section 15.247(c) (1) (I):

(i) Systems operating in the 2400-2483.5 MHz band that is used exclusively for fixed. Point-to-point operations may employ transmitting antennas with directional gain greater than 6dBi provided the maximum conducted output power of the intentional radiator is reduced by 1 dB for every 3 dB that the directional gain of the antenna exceeds 6dBi.

Test Result:

The directional gains of antenna used for transmitting is 2.12dBi, and the antenna is an Integral Antenna with ipex connector and no consideration of replacement. Please see EUT photo for details.

Results: Compliance.

6 Test Setup Photos of the EUT

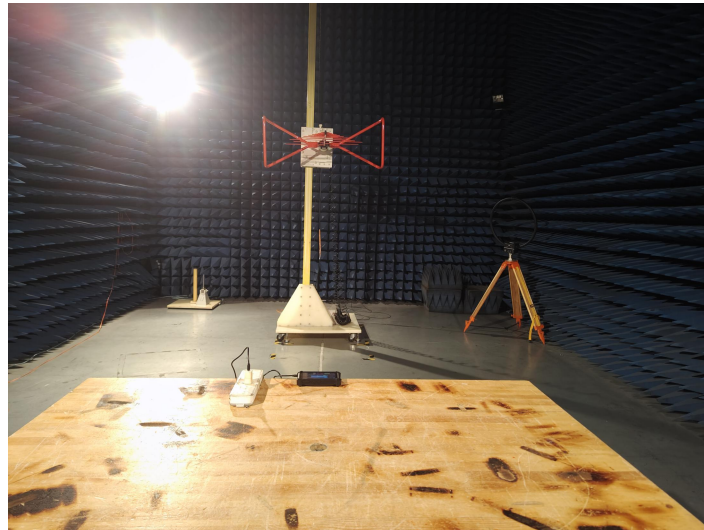
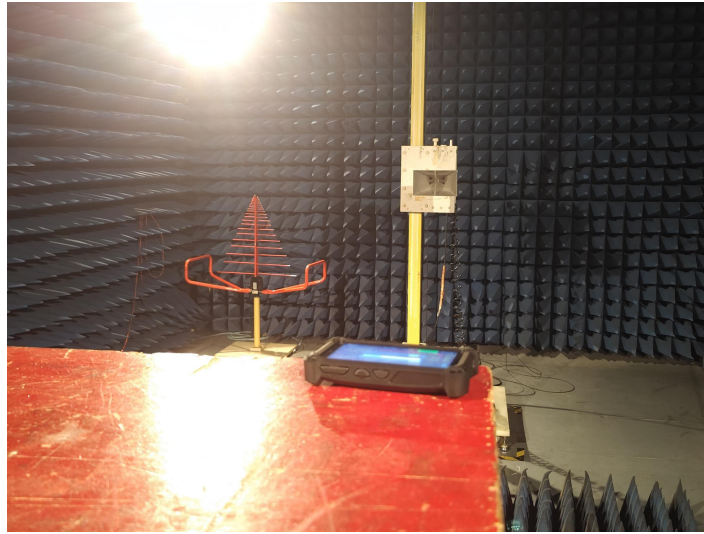

7 Photos of the EUT

See related photo report.

******* End of Report *******