



RF Test Report

For

Applicant Name: RM ACQUISITIONS LLC
Address: 8770 W. Bryn Mawr Avenue, Chicago, Illinois, United States, 60631
EUT Name: GPS Device
Brand Name: RANDOMNALLY
Model Number: Randtab7

Issued By

Company Name: BTF Testing Lab (Shenzhen) Co., Ltd.
Address: F101, 201 and 301, Building 1, Block 2, Tantou Industrial Park, Tantou Community, Songgang Street, Bao'an District, Shenzhen, China

Report Number: BTF230628R00401
Test Standards: 47 CFR Part 15 Subpart E Section 15.407
FCC ID: A4C-10012B
Test Conclusion: Pass
Test Date: 2023-06-28 to 2023-08-14
Date of Issue: 2023-08-31

Prepared By:

Chris Liu

Date:

Chris Liu / Project Engineer
2023-08-31

Approved By:

Ryan.CJ

Date:

Ryan.CJ / EMC Manager
2023-08-31

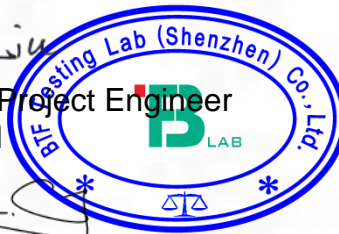

Note: All the test results in this report only related to the testing samples. Which can be duplicated completely for the legal use with approval of applicant; it shall not be reproduced except in full without the written approval of BTF Testing Lab (Shenzhen) Co., Ltd., All the objections should be raised within thirty days from the date of issue. To validate the report, you can contact us.

Revision History		
Version	Issue Date	Revisions Content
R_V0	2023-08-31	Original
<i>Note:</i>	<i>Once the revision has been made, then previous versions reports are invalid.</i>	

Table of Contents

1.	Introduction.....	4
1.1	Identification of Testing Laboratory	4
1.2	Identification of the Responsible Testing Location	4
1.3	Laboratory Condition.....	4
1.4	Announcement	4
2.	Product Information.....	5
2.1	Application Information	5
2.2	Manufacturer Information	5
2.3	Factory Information	5
2.4	General Description of Equipment under Test (EUT).....	5
2.5	Technical Information.....	6
3.	Summary of Test Results.....	7
3.1	Test Standards	7
3.2	Summary of Test Result	7
3.3	Uncertainty of Test.....	7
4.	Test Configuration.....	8
4.1	Environment Condition	8
4.2	Test Equipment List	8
4.3	Test Auxiliary Equipment	8
4.4	Test Setup.....	9
5.	DFS TEST INFORMATION	10
5.1	DFS test requirement.....	10
5.2	DFS Detection Thresholds	13
5.3	Radar Test Waveforms	14
6.	Test Item 17	17
6.1	Calibration of Radar Waveform.....	17
6.2	Channel Move Time, Channel Closing Transmission Time.....	18
	ANNEX A Test Results	20

1. Introduction

1.1 Identification of Testing Laboratory

Company Name:	BTF Testing Lab (Shenzhen) Co., Ltd.
Address:	F101, 201 and 301, Building 1, Block 2, Tantou Industrial Park, Tantou Community, Songgang Street, Bao'an District, Shenzhen, China
Phone Number:	+86-0755-23146130
Fax Number:	+86-0755-23146130

1.2 Identification of the Responsible Testing Location

Test Location:	BTF Testing Lab (Shenzhen) Co., Ltd.
Address:	F101, 201 and 301, Building 1, Block 2, Tantou Industrial Park, Tantou Community, Songgang Street, Bao'an District, Shenzhen, China
Description:	All measurement facilities used to collect the measurement data are located at F101,201 and 301, Building 1, Block 2, Tantou Industrial Park, Tantou Community, Songgang Street, Bao'an District, Shenzhen, China
FCC Registration Number:	518915
Designation Number:	CN1330

1.3 Laboratory Condition

Ambient Temperature:	20°C to 25°C
Ambient Relative Humidity:	45% to 55%
Ambient Pressure:	100 kPa to 102 kPa

1.4 Announcement

- (1) The test report reference to the report template version v0.
- (2) The test report is invalid if not marked with the signatures of the persons responsible for preparing, reviewing and approving the test report.
- (3) The test report is invalid if there is any evidence and/or falsification.
- (4) This document may not be altered or revised in any way unless done so by BTF and all revisions are duly noted in the revisions section.
- (5) Content of the test report, in part or in full, cannot be used for publicity and/or promotional purposes without prior written approval from the laboratory.
- (6) The laboratory is only responsible for the data released by the laboratory, except for the part provided by the applicant.

2. Product Information

2.1 Application Information

Company Name:	RM ACQUISITIONS LLC
Address:	8770 W. Bryn Mawr Avenue, Chicago, Illinois, United States, 60631

2.2 Manufacturer Information

Company Name:	SHEN ZHEN APICAL TECHNOLOGY CO., LTD
Address:	9/F, B Building, Tinghua Unis Infoport, Langshan RD, North district, Hi-tech Industrial Park, Nanshan, Shenzhen

2.3 Factory Information

Company Name:	SHEN ZHEN APICAL TECHNOLOGY CO., LTD
Address:	9/F, B Building, Tinghua Unis Infoport, Langshan RD, North district, Hi-tech Industrial Park, Nanshan, Shenzhen

2.4 General Description of Equipment under Test (EUT)

EUT Name	GPS Device
Under Test Model Name	Randtab7
Series Model Name	N/A
Description of Model name differentiation	N/A
Test Sample Number	BTFSN230627E005-1/1
Hardware Version	T1050-MT8176-MAIN-01B
Software and Firmware Version	RandTab7_mp

2.5 Technical Information

Modulation technology	OFDM
Modulation Type	BPSK, QPSK, 16QAM, 64QAM, 256QAM
Function	<input type="checkbox"/> Outdoor AP <input type="checkbox"/> Indoor AP <input type="checkbox"/> Fixed P2P <input checked="" type="checkbox"/> Client
DFS type	<input type="checkbox"/> Master <input type="checkbox"/> Slave with radar detection <input checked="" type="checkbox"/> Slave without radar detection
Operation Frequency Range	U-NII Band 2A: 5.26~5.32 GHz U-NII Band 2C: 5.50~5.70 GHz
Frequency Block	U-NII Band 2A: 5.25~5.35 GHz U-NII Band 2C: 5.47~5.725 GHz
Channel Bandwidth	802.11a: 20 MHz 802.11n: 20 MHz, 40 MHz 802.11ac: 20 MHz, 40 MHz, 80 MHz
Antenna Impedance	50Ω
Antenna System (MIMO Smart Antenna)	N/A

Note:

#: The antenna gain provided by the applicant, and the laboratory will not be responsible for the accumulated calculation results which covers the information provided by the applicant.

According to section 15.31(m), regards to the operating frequency range over 10 MHz, must select three channels which were tested. The Lowest frequency, the middle frequency, and the highest frequency of channel were selected to perform the test, please see the below .

Band	Test Channel	20MHz		40MHz		80MHz	
		Channel	Frequency (MHz)	Channel	Frequency (MHz)	Channel	Frequency (MHz)
U-NII-2A	CH _L	52	5260	54	5270	-	-
	CH _M	56	5280	-	-	58	5290
	CH _H	64	5320	62	5310	-	-
U-NII-2C	CH _L	100	5500	102	5510	106	5530
	CH _M	116	5580	110	5550	122	5610
	CH _H	140	5700	134	5670	138	5690
	CH _{H1}	144	5720	142	5710		

3. Summary of Test Results

3.1 Test Standards

No.	Identity	Document Title
1	47 CFR Part 15 Subpart E Section 15.407	Unlicensed National Information Infrastructure Devices
2	ANSI C63.10-2013	American National Standard for Testing Unlicensed Wireless Devices
3	KDB905462 D02 v02	COMPLIANCE MEASUREMENT PROCEDURES FOR UNLICENSED-NATIONAL INFORMATION INFRASTRUCTURE DEVICES OPERATING IN THE 5250-5350 MHz AND 5470-5725 MHz BANDS INCORPORATING DYNAMIC FREQUENCY SELECTION
4	KDB905462 D03 v01r02	U-NII CLIENT DEVICES WITHOUT RADAR DETECTION CAPABILITY
5	KDB905462 D04 v01	OPERATIONAL MODES SUGGESTED FOR DFS TESTING

3.2 Summary of Test Result

No.	Description	FCC Part No.	Test Result	Test By	Verdict	Remark
1	Calibration of Radar Waveform	15.407(i)	ANNEX A.1		Pass	--
2	Channel Move Time, Channel Closing Transmission Time	15.407(i)	ANNEX A.2		Pass	--

3.3 Uncertainty of Test

The following measurement uncertainty levels have been estimated for tests performed on the EUT as specified in CISPR 16-4-2 and TR100 028-1/-2. This uncertainty represents an expanded uncertainty expressed at approximately the 95% confidence level using a coverage factor of k=2.

Measurement	Value
Occupied Channel Bandwidth	69 KHz
RF output power, conducted	0.87 dB
Power Spectral Density, conducted	0.69 dB
Unwanted Emissions, conducted	0.94 dB
All emissions, radiated(<1GHz)	4.12 dB
All emissions, radiated(>1GHz)	4.16 dB
Temperature	0.82 °C
Humidity	4.1 %

4. Test Configuration

4.1 Environment Condition

Environment Parameter	Selected Values During Tests			
	Temperature	Voltage	Relative Humidity	Ambient Pressure
Normal Temperature, Normal Voltage (NTNV)	20°C to 25°C	DC 5V	30% to 60%	100 kPa to 102 kPa

4.2 Test Equipment List

Conducted Method Test						
Description	Manufacturer	Model	Serial No.	Cal. Date	Cal. Due	Use
MXA Signal Analyzer	KEYSIGHT	N9020A	MY50410020	2022.11.24	2023.11.23	<input checked="" type="checkbox"/>
WIDEBAND RADIO COMMUNICATION TESTER	Rohde & Schwarz	CMW500	161997	2022.11.24	2023.11.23	<input checked="" type="checkbox"/>
ESG VECTOR SIGNAL GENERATOR	Agilent	E4438C	MY45094854	2022.11.24	2023.11.23	<input checked="" type="checkbox"/>
MXG Vector Signal Generator	Agilent	N5182A	MY46240163	2022.11.24	2023.11.23	<input checked="" type="checkbox"/>
Adjustable Direct Current Regulated Power Supply	Dongguan Tongmen Electronic Technology Co., LTD	etm-6050c	20211026123	2022.11.25	2023.11.24	<input checked="" type="checkbox"/>
RF Control Unit	TST	TST-Full	S01	/	/	<input checked="" type="checkbox"/>
RF Test software	TST	V2.0	/	/	/	<input checked="" type="checkbox"/>

4.3 Test Auxiliary Equipment

Description	Manufacturer	Model	Serial No.	FCC ID	Description	Use
Router	ASUS	RT-AC88U	/	MSQ-RTGW00	/	<input checked="" type="checkbox"/>

4.4 Test Setup

Test Setup 1

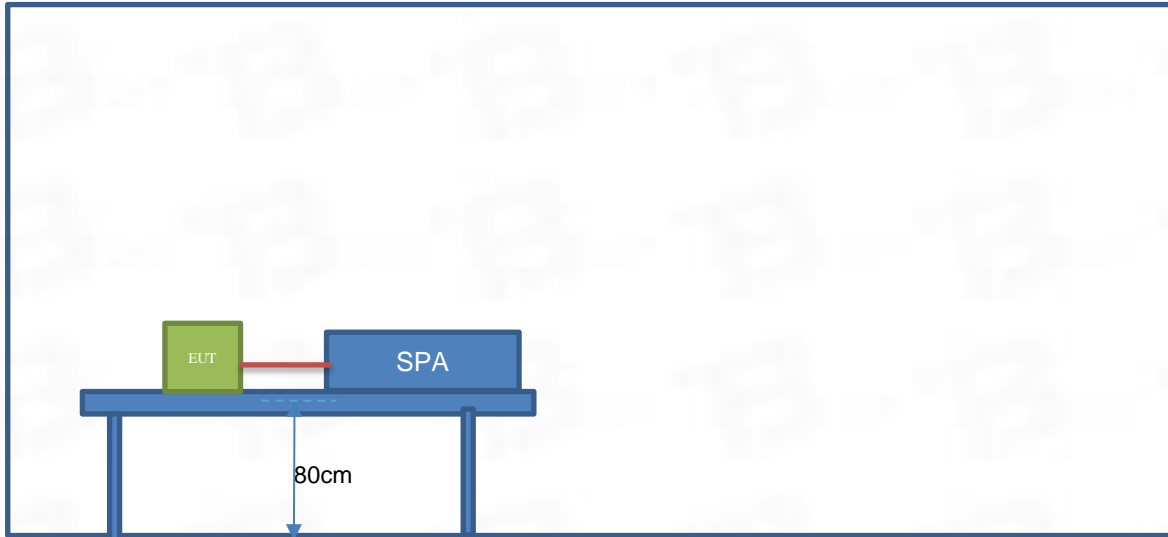

5. DFS TEST INFORMATION

5.1 DFS test requirement

The following table from FCC KDB905462 D02 UNII DFS Compliance procedures new rules list the applicable requirements for the DFS testing.

Table 1: Applicability of DFS Requirements Prior to Use of a Channel

Requirement	Operational Mode		
	Master	Client Without Radar Detection	Client With Radar Detection
Non-Occupancy Period	Yes	Not required	Yes
DFS Detection Threshold	Yes	Not required	Yes
Channel Availability Check Time	Yes	Not required	Not required
U-NII Detection Bandwidth	Yes	Not required	Yes

Table 2: Applicability of DFS requirements during normal operation

Requirement	Operational Mode	
	Master Device or Client with Radar Detection	Client Without Radar Detection
DFS Detection Threshold	Yes	Not required
Channel Closing Transmission Time	Yes	Yes
Channel Move Time	Yes	Yes
U-NII Detection Bandwidth	Yes	Not required

Additional requirements for devices with multiple bandwidth modes	Master Device or Client with Radar Detection	Client Without Radar Detection
U-NII Detection Bandwidth and Statistical Performance Check	All BW modes must be tested	Not required
Channel Move Time and Channel Closing Transmission Time	Test using widest BW mode available	Test using the widest BW mode available for the link
All other tests	Any single BW mode	Not required

Note: Frequencies selected for statistical performance check (Section 7.8.4) should include several frequencies within the radar detection bandwidth and frequencies near the edge of the radar detection bandwidth. For 802.11 devices it is suggested to select frequencies in each of the bonded 20 MHz channels and the channel center frequency.

Master Devices

- a) The Master Device will use DFS in order to detect Radar Waveforms with received signal strength above the DFS Detection Threshold in the 5250~5350 MHz and 5470~5725 MHz bands. DFS is not required in the 5150~5250 MHz or 5725~5825 MHz bands.
- b) Before initiating a network on a Channel, the Master Device will perform a Channel Availability Check for a specified time duration (Channel Availability Check Time) to ensure that there is no radar system operating on the Channel, using DFS described under subsection a) above.
- c) The Master Device initiates a U-NII network by transmitting control signals that will enable other U-NII devices to Associate with the Master Device.
- d) During normal operation, the Master Device will monitor the Channel (In-Service Monitoring) to ensure that there is no radar system operating on the Channel, using DFS described under a).
- e) If the Master Device has detected a Radar Waveform during In-Service Monitoring as described under d), the Operating Channel of the U-NII network is no longer an Available Channel. The Master Device will instruct all associated Client Device(s) to stop transmitting on this Channel within the Channel Move Time. The transmissions during the Channel Move Time will be limited to the Channel Closing Transmission Time.
- f) Once the Master Device has detected a Radar Waveform it will not utilize the Channel for the duration of the Non-Occupancy Period.
- g) If the Master Device delegates the In-Service Monitoring to a Client Device, then the combination will be tested to the requirements described under d) through f) above.
- h)

Client Devices

- a) A Client Device will not transmit before having received appropriate control signals from a Master Device.
- b) A Client Device will stop all its transmissions whenever instructed by a Master Device to which it is associated and will meet the Channel Move Time and Channel Closing Transmission Time requirements. The Client Device will not resume any transmissions until it has again received control signals from a Master Device.
- c) If a Client Device is performing In-Service Monitoring and detects a Radar Waveform above the DFS Detection Threshold, it will inform the Master Device. This is equivalent to the Master Device detecting the Radar Waveform and d) through f) of section 5.1.1 apply.
- d) Irrespective of Client Device or Master Device detection the Channel Move Time and Channel Closing Transmission Time requirements remain the same.
- e) The client test frequency must be monitored to ensure no transmission of any type has occurred for 30 minutes. Note: If the client moves with the master, the device is considered compliant if nothing appears in the client non-occupancy period test. For devices that shut down (rather than moving channels), no beacons should appear.

Table 4: DFS Response Requirement Values

Parameter	Value
Non-occupancy period	Minimum 30 minutes
Channel Availability Check Time	60 seconds
Channel Move Time	10 seconds See Note 1.
Channel Closing Transmission Time	200 milliseconds + an aggregate of 60 milliseconds over remaining 10 second period. See Notes 1 and 2.
U-NII Detection Bandwidth	Minimum 100% of the U-NII 99% transmission power bandwidth. See Note 3.
<p>Note 1: Channel Move Time and the Channel Closing Transmission Time should be performed with Radar Type 0. The measurement timing begins at the end of the Radar Type 0 burst.</p> <p>Note 2: The Channel Closing Transmission Time is comprised of 200 milliseconds starting at the beginning of the Channel Move Time plus any additional intermittent control signals required facilitating a Channel move (an aggregate of 60 milliseconds) during the remainder of the 10 second period. The aggregate duration of control signals will not count quiet periods in between transmissions.</p> <p>Note 3: During the U-NII Detection Bandwidth detection test, radar type 0 should be used. For each frequency step the minimum percentage of detection is 90 percent. Measurements are performed with no data traffic.</p>	

5.2 DFS Detection Thresholds

Table 3: DFS Detection Thresholds for Master Devices and Client Devices With Radar Detection

Maximum Transmit Power	Value (See Notes 1, 2, and 3)
EIRP \geq 200 milliwatt	-64 dBm
EIRP < 200 milliwatt and power spectral density < 10 dBm/MHz	-62 dBm
EIRP < 200 milliwatt that do not meet the power spectral density requirement	-64 dBm

Note 1: This is the level at the input of the receiver assuming a 0 dBi receive antenna.

Note 2: Throughout these test procedures an additional 1 dB has been added to the amplitude of the test transmission waveforms to account for variations in measurement equipment. This will ensure that the test signal is at or above the detection threshold level to trigger a DFS response.

Note3: EIRP is based on the highest antenna gain. For MIMO devices refer to KDB Publication 662911 D01.

5.3 Radar Test Waveforms

This section provides the parameters for required test waveforms, minimum percentage of successful detections, and the minimum number of trials that must be used for determining DFS conformance. Step intervals of 0.1 microsecond for Pulse Width, 1 microsecond for PRI, 1 MHz for chirp width and 1 for the number of pulses will be utilized for the random determination of specific test waveforms.

Table 5 Short Pulse Radar Test Waveforms

Radar Type	Pulse Width (μsec)	PRI (μsec)	Number of Pulses	Minimum Percentage of Successful Detection	Minimum Number of Trials
0	1	1428	18	See Note 1	See Note 1
1	1	Test A: 15 unique PRI values randomly selected from the list of 23 PRI values in Table 5a	Roundup $\left\{ \left(\frac{1}{360} \right) \cdot \left(\frac{19 \cdot 10^6}{\text{PRI}_{\mu\text{sec}}} \right) \right\}$	60%	30
		Test B: 15 unique PRI values randomly selected within the range of 518-3066 μsec, with a minimum increment of 1 μsec, excluding PRI values selected in Test A			
2	1-5	150-230	23-29	60%	30
3	6-10	200-500	16-18	60%	30
4	11-20	200-500	12-16	60%	30
Aggregate (Radar Types 1-4)				80%	120
Note 1: Short Pulse Radar Type 0 should be used for the detection bandwidth test, channel move time, and channel closing time tests.					

A minimum of 30 unique waveforms are required for each of the Short Pulse Radar Types 2 through 4. If more than 30 waveforms are used for Short Pulse Radar Types 2 through 4, then each additional waveform must also be unique and not repeated from the previous waveforms. If more than 30 waveforms are used for Short Pulse Radar Type 1, then each additional waveform is generated with Test B and must also be unique and not repeated from the previous waveforms in Tests A or B.

For example if in Short Pulse Radar Type 1 Test B a PRI of 3066 μsec is selected, the number of pulses would be Round up

$$\left\{ \left(\frac{1}{360} \right) \cdot \left(\frac{19 \cdot 10^6}{3066} \right) \right\} = \text{Round up } \{17.2\} = 18.$$

Table 5a - Pulse Repetition Intervals Values for Test A

Pulse Repetition Frequency Number	Pulse Repetition Frequency (Pulses Per Second)	Pulse Repetition Interval (Microseconds)
1	1930.5	518
2	1858.7	538
3	1792.1	558
4	1730.1	578
5	1672.2	598
6	1618.1	618
7	1567.4	638
8	1519.8	658
9	1474.9	678
10	1432.7	698
11	1392.8	718
12	1355	738
13	1319.3	758
14	1285.3	778
15	1253.1	798
16	1222.5	818
17	1193.3	838
18	1165.6	858
19	1139	878
20	1113.6	898
21	1089.3	918
22	1066.1	938
23	326.2	3066

Table 6 – Long Pulse Radar Test Waveform

Radar Type	Pulse Width (µsec)	Chirp Width (MHz)	PRI (µsec)	Number of Pulses per Burst	Number of Bursts	Minimum Percentage of Successful Detection	Minimum Number of Trials
5	50-100	5-20	1000-2000	1-3	8-20	80%	30

The parameters for this waveforms are randomly chosen. Thirty unique waveforms are required for the Long Pulse Radar Type waveforms. If more than 30 waveforms are used for the Long Pulse Radar Type wave forms, then each additional waveform must also be unique and not repeated from the previous waveforms.

Table 7 – Frequency Hopping Radar Test Waveform

Radar Type	Pulse Width (μsec)	PRI (μsec)	Pulses per Hop	Hopping Rate (kHz)	Hopping Sequence Length (msec)	Minimum Percentage of Successful Detection	Minimum Number of Trials
6	1	333	9	0.333	300	70%	30

For the Frequency Hopping Radar Type, the same Burst parameters are used for each wave form. The hopping sequence is different for each wave form and a 100-length segment is selected from the hopping sequence defined by the following algorithm:

The first frequency in a hopping sequence is selected randomly from the group of 475 integer frequencies from 5250–5724MHz. Next, the frequency that was just chosen is removed from the group and a frequency is randomly selected from the remaining 474 frequencies in the group. This process continues until all 475 frequencies are chosen for the set. For selection of a random frequency, the frequencies remaining within the group are always treated as equally likely.

6. Test Item

6.1 Calibration of Radar Waveform

6.1.1 TEST CONFIGURATION

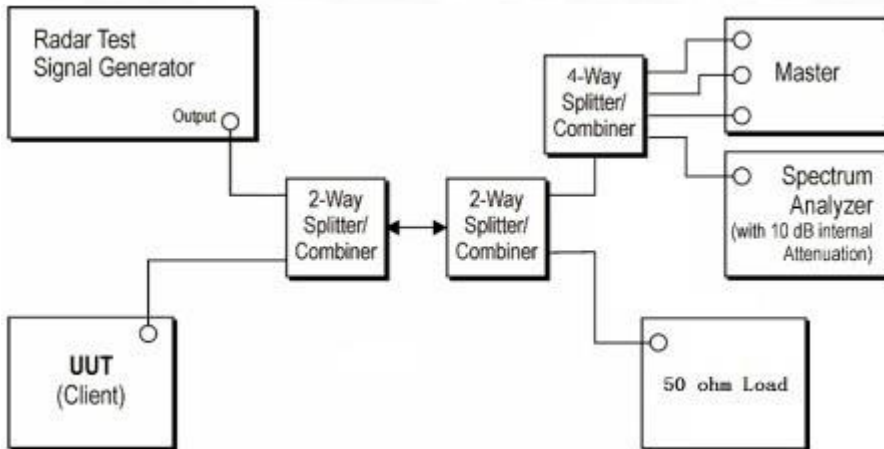

6.1.2 Test Procedure

- A 50 ohm load is connected in place of the spectrum analyzer, and the spectrum analyzer is connected to place of the master
- The interference Radar Detection Threshold Level is $-62\text{dBm} + 0\text{dBi} + 1\text{dB} = -61\text{dBm}$ that had been taken into account the output power range and antenna gain.
- The following equipment setup was used to calibrate the conducted radar waveform. A vector signal generator was utilized to establish the test signal level for radar type 0. During this process there were no transmissions by either the master or client device. The spectrum analyzer was switched to the zero spans (time domain) at the frequency of the radar waveform generator. Peak detection was used. The spectrum analyzer resolution bandwidth (RBW) and video bandwidth (VBW) were set to 3MHz. The spectrum analyzer had offset -1.0dB to compensate RF cable loss 1.0dB .
- The vector signal generator amplitude was set so that the power level measured at the spectrum analyzer was $-62\text{dBm} + 0\text{dBi} + 1\text{dB} = -61\text{dBm}$. Capture the spectrum analyzer plots on short pulse radar waveform.

6.1.3 Test Result

Please refer to ANNEX A.1

6.2 Channel Move Time, Channel Closing Transmission Time

6.2.1 TEST CONFIGURATION

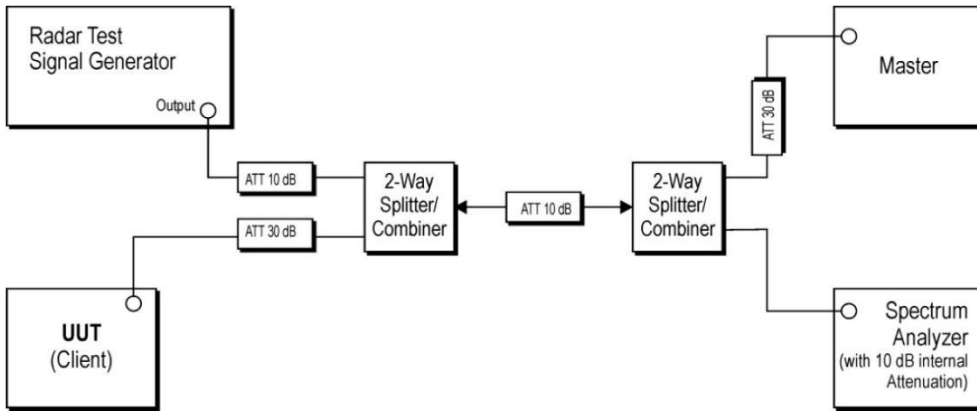

6.2.2 Test Procedure

- a) The radar pulse generator is setup to provide a pulse at frequency that the master and client are operating. A type 0 radar pulse with a 1us pulse width and a 1428us PRI is used for the testing.
- b) The vector signal generator is adjusted to provide the radar burst (18 pulses) at the level of approximately -61dBm at the antenna port of the master device.
- c) A trigger is provided from the pulse generator to the DFS monitoring system in order to capture the traffic and the occurrence of the radar pulse.
- d) EUT will associate with the master at channel. The file "iperf.exe" specified by the FCC is streamed from the PC 2 through the master and the client device to the PC 1 and played in full motion video using Media Player Classic Ver. 6.4.8.6 in order to properly load the network for the entire period of the test.
- e) When radar burst with a level equal to the DFS Detection Threshold +1dB is generated on the operating channel of the U-NII device. At time T0 the radar waveform generator sends a burst of pulse of the radar waveform at Detection Threshold +1dB.
- f) Observe the transmissions of the EUT at the end of the radar Burst on the Operating Channel Measure and record the transmissions from the UUT during the observation time (Channel Move Time). One 15 seconds plot is reported for the Short Pulse Radar Type 0. The plot for the Short Pulse Radar Types start at the end of the radar burst. The Channel Move Time will be calculated based on the zoom in 600ms plot of the Short Pulse Radar Type
- g) Measurement of the aggregate duration of the Channel Closed Transmission Time method. With the spectrum analyzer set to zero span tuned to the center frequency of the EUT operating channel at the radar simulated

frequency, peak detection, and max hold, the dwell time per bin is given by: $Dwell (0.3ms) = S (12000ms) / B (4000)$; where Dwell is the dwell time per spectrum analyzer sampling bin, S is sweep time and B is the number of spectrum analyzer sampling bins. An upper bound of the aggregate duration of the intermittent control signals of Channel Closing Transmission Time is calculated by: $C (ms) = N \times Dwell (0.3ms)$; where C is the Closing Time, N is the number of spectrum analyzer sampling bins (intermittent control signals) showing a U-NII transmission and Dwell is the dwell time per bin.

- h) Measurement the EUT for more than 30 minutes following the channel move time to verify that no transmission or beacons occur on this channel.

6.2.3 Test Result

Please refer to ANNEX A.2

ANNEX A Test Results

1. Signal Calibration

1.1 SC

1.1.1 Test Result

Band: 2A							
Mode	Bandwidth (MHz)	Frequency (MHz)	Radar Signal		Signal Calibration		Verdict
			Type	Trial Id	Result	Limit	
802.11ac	80	5290	0	0	Refer To Test Graph		Pass
			1	0	Refer To Test Graph		Pass
			2	0	Refer To Test Graph		Pass
			3	0	Refer To Test Graph		Pass
			4	0	Refer To Test Graph		Pass
			5	0	Refer To Test Graph		Pass
			6	0	Refer To Test Graph		Pass

1.1.2 Test Graph

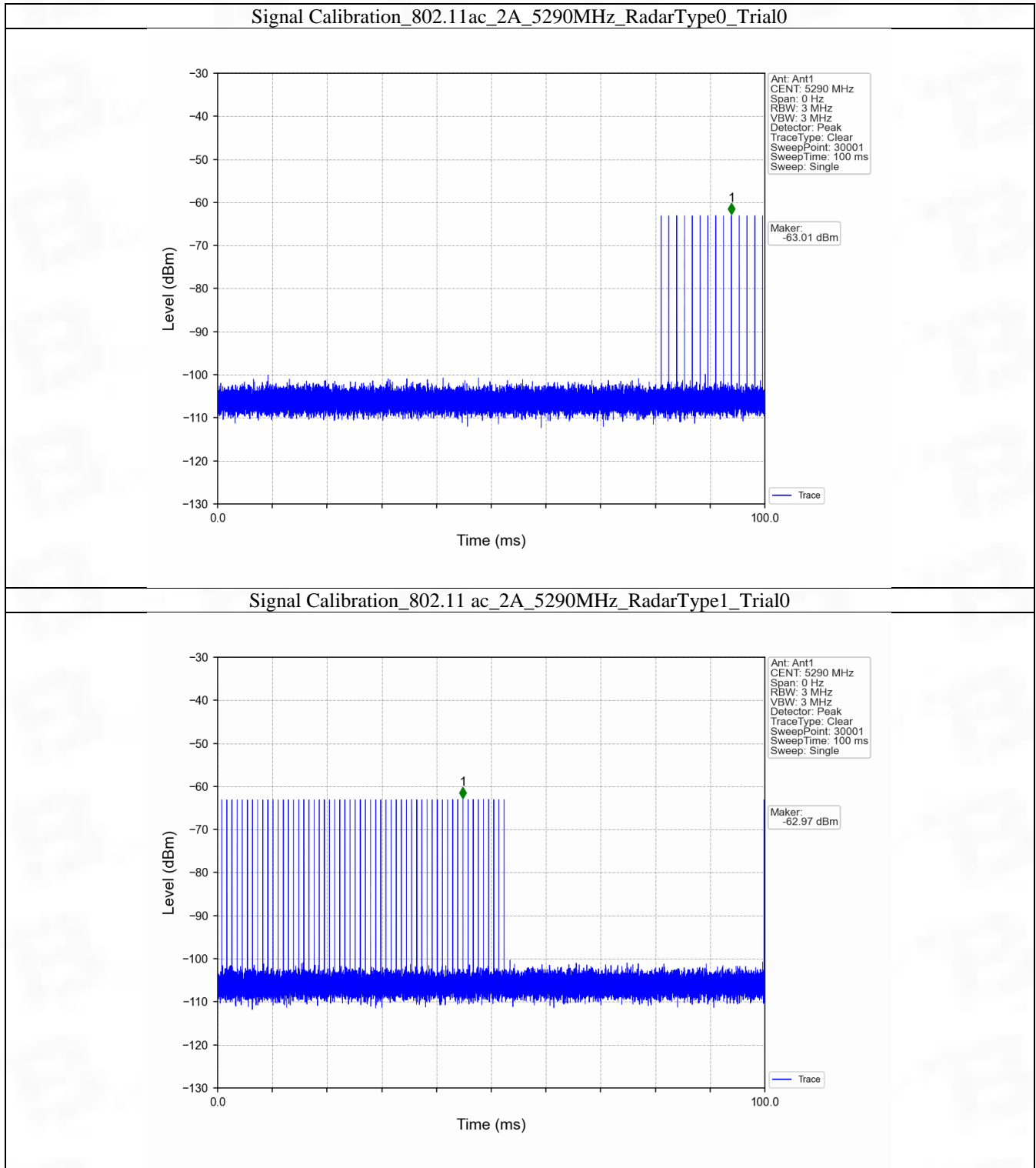

Signal Calibration_802.11 ac_2A_5290MHz_RadarType2_Trial0

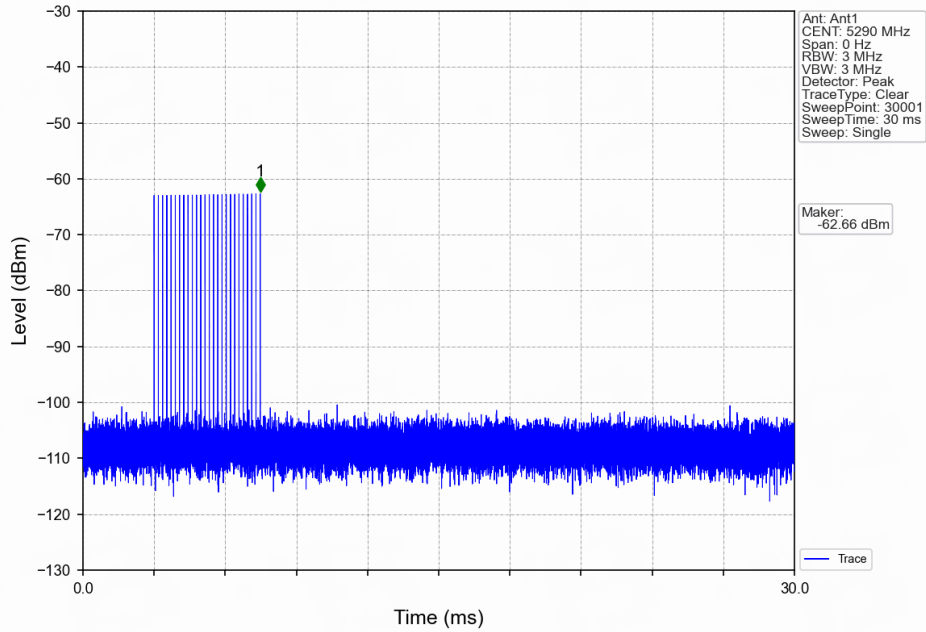

Signal Calibration_802.11 ac_2A_5290MHz_RadarType3_Trial0

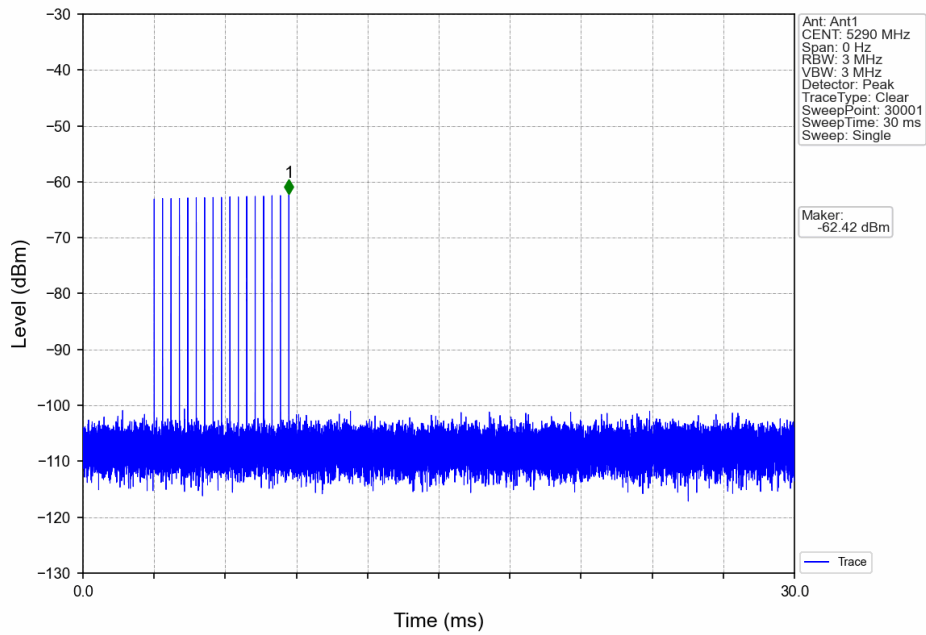

Signal Calibration_802.11 ac_2A_5290MHz_RadarType4_Trial0

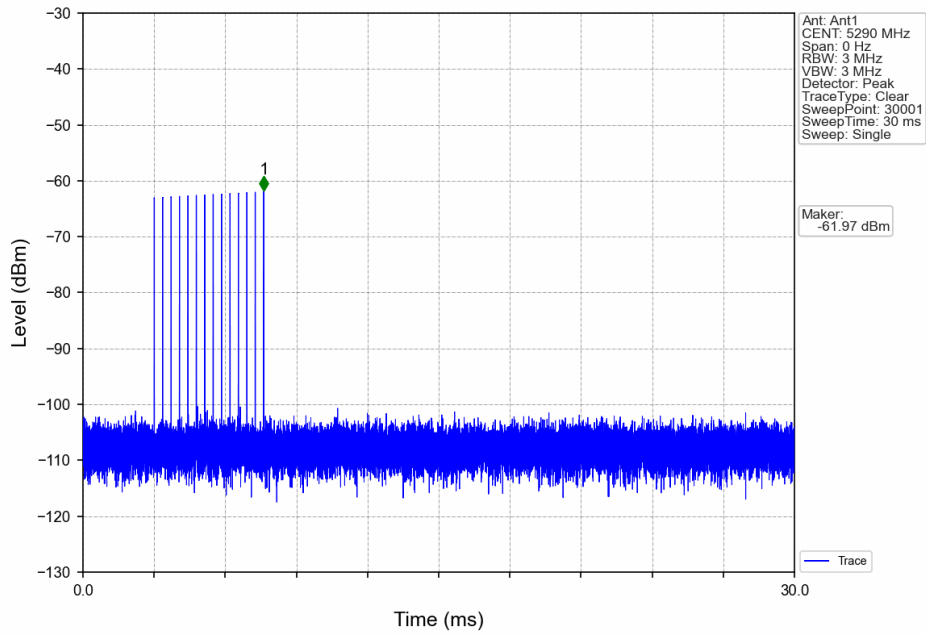

Signal Calibration_802.11 ac_2A_5290MHz_RadarType5_Trial0

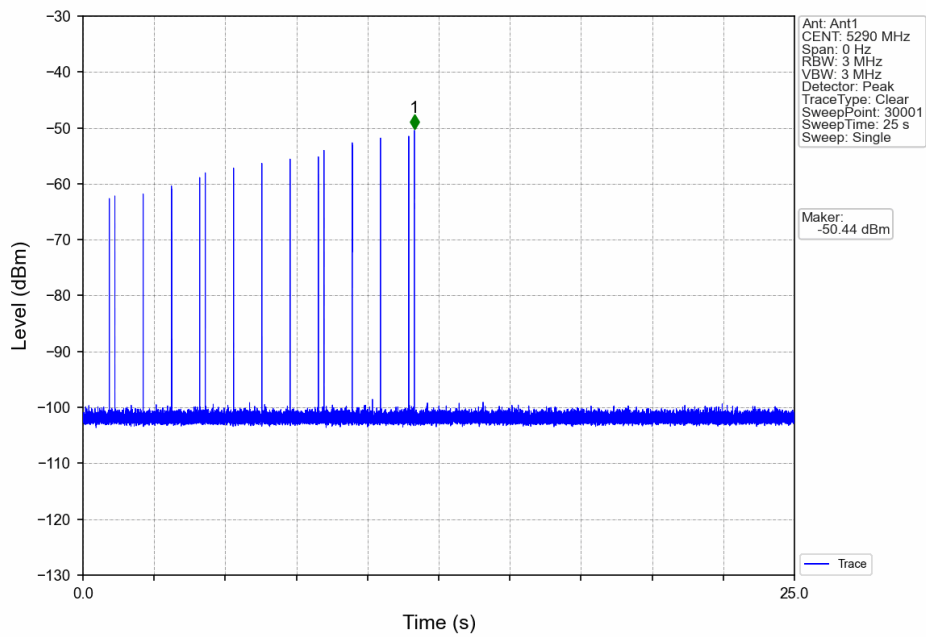

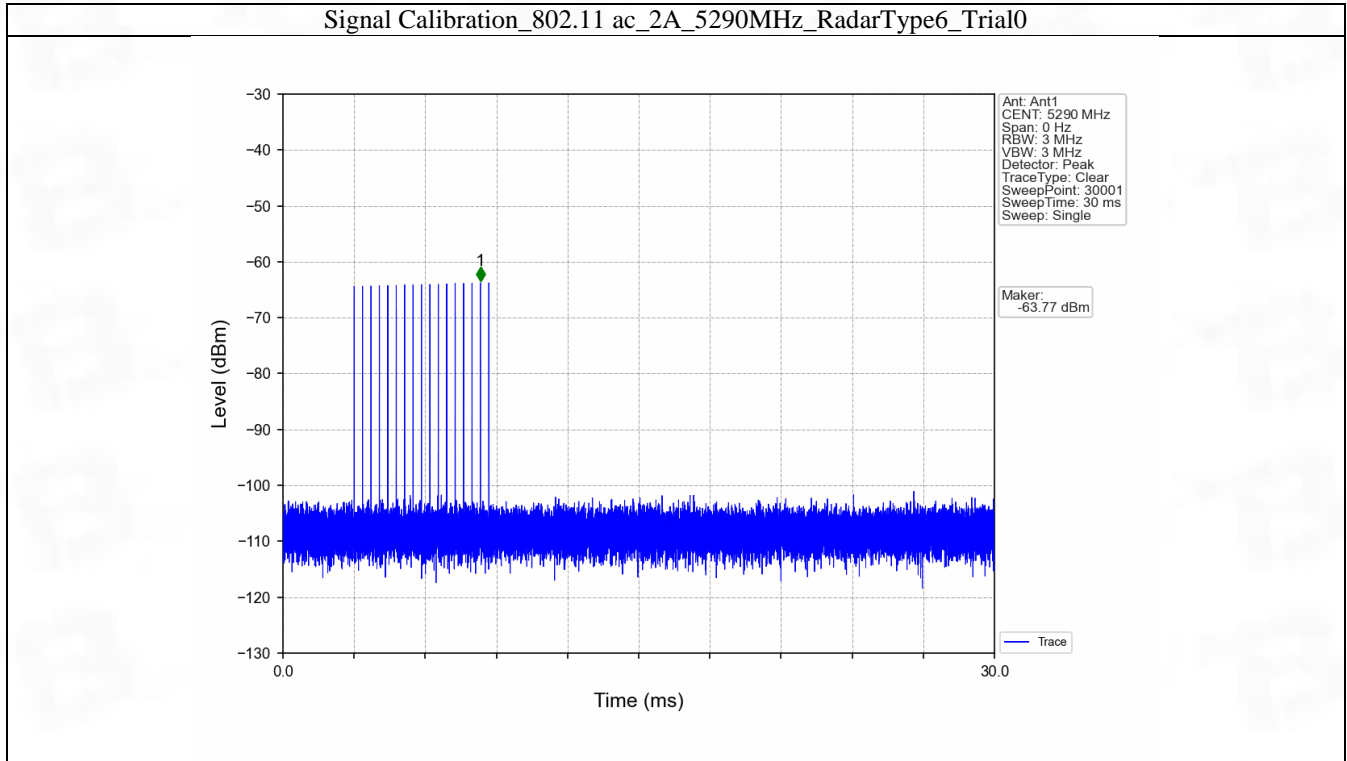

1.2 SC

1.2.1 Test Result

Band: 2C							
Mode	Bandwidth (MHz)	Frequency (MHz)	Radar Signal		Signal Calibration		Verdict
			Type	Trial Id	Result	Limit	
802.11ac	80	5530	0	0	Refer To Test Graph		Pass
			1	0	Refer To Test Graph		Pass
			2	0	Refer To Test Graph		Pass
			3	0	Refer To Test Graph		Pass
			4	0	Refer To Test Graph		Pass
			5	0	Refer To Test Graph		Pass
			6	0	Refer To Test Graph		Pass

1.2.2 Test Graph

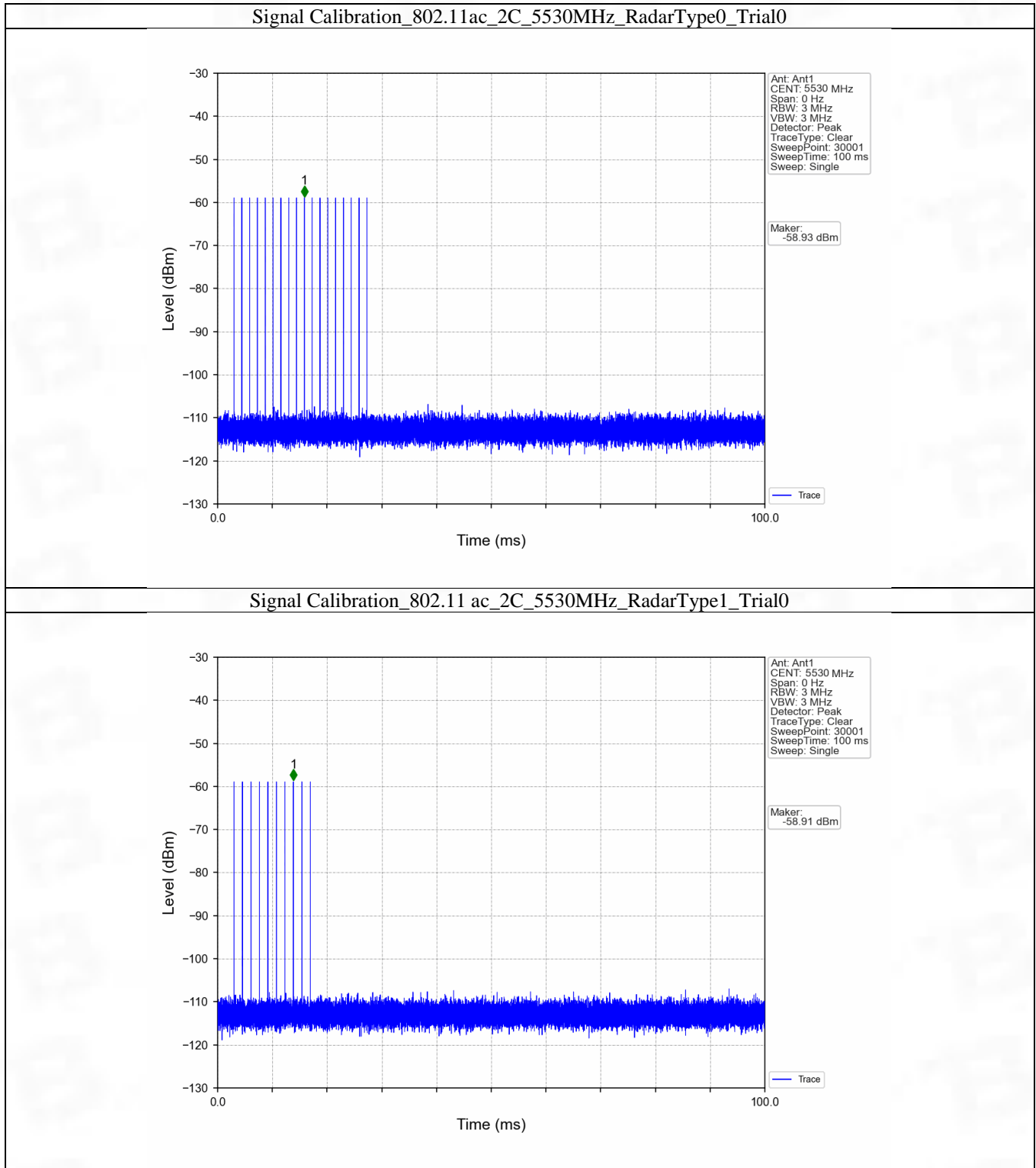

Signal Calibration_802.11 ac_2C_5530MHz_RadarType2_Trial0

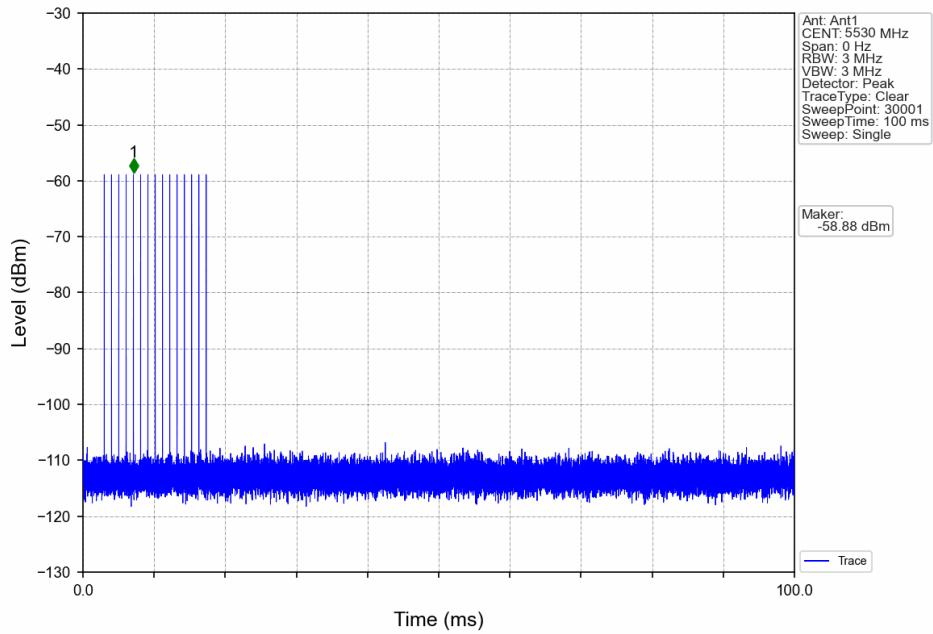

Signal Calibration_802.11 ac_2C_5530MHz_RadarType3_Trial0

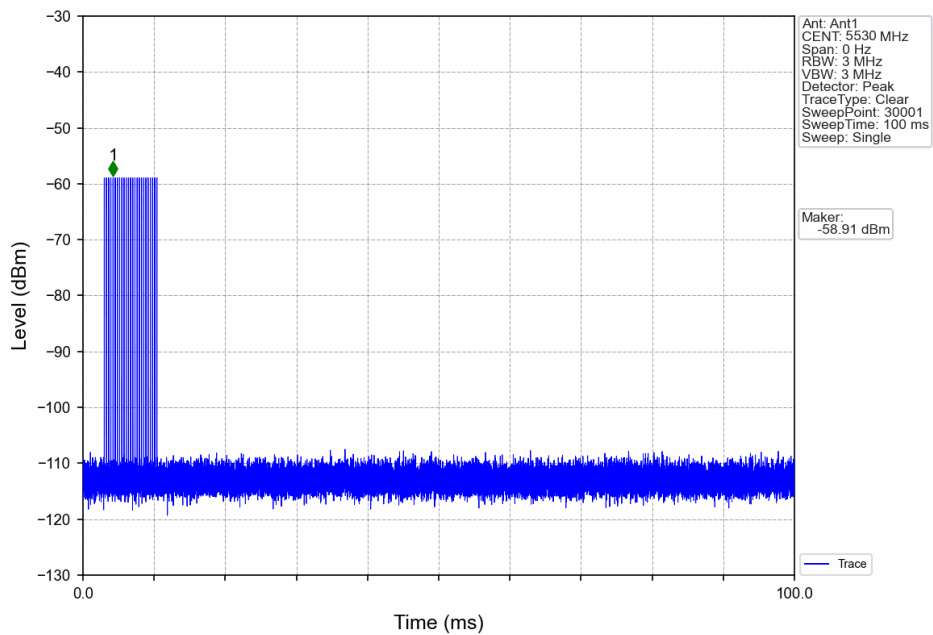

Signal Calibration_802.11 ac_2C_5530MHz_RadarType4_Trial0

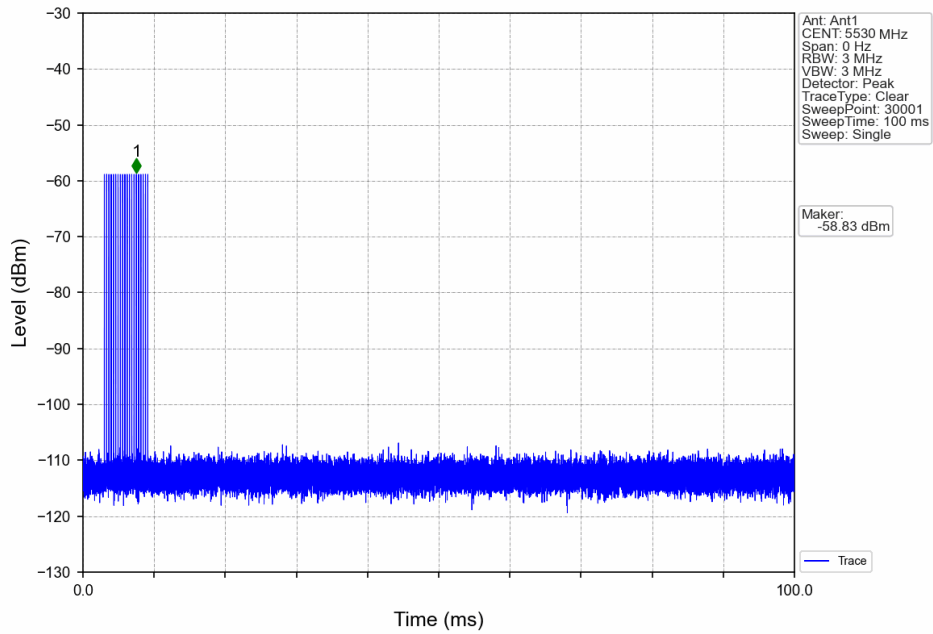

Signal Calibration_802.11 ac_2C_5530MHz_RadarType5_Trial0

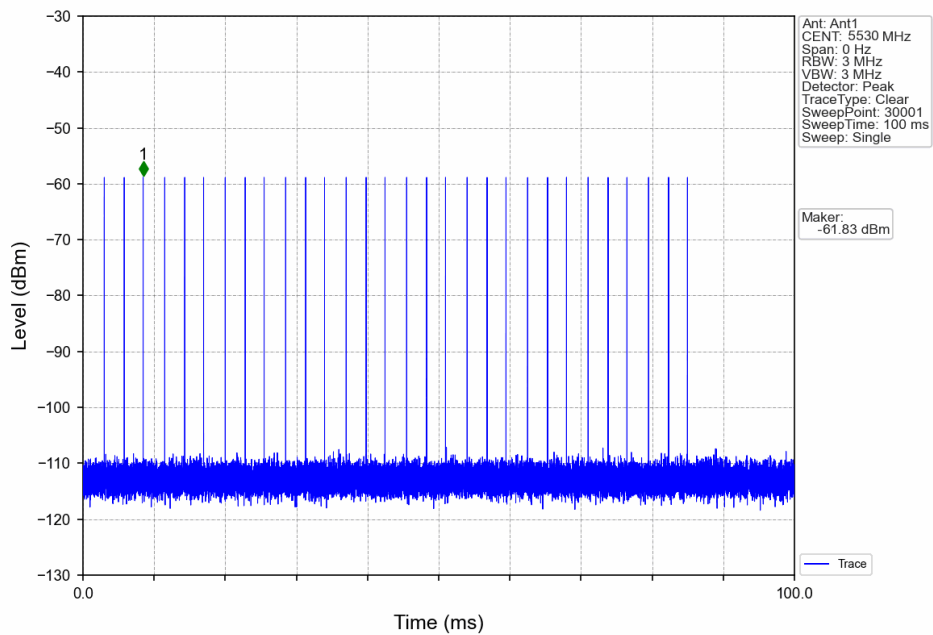

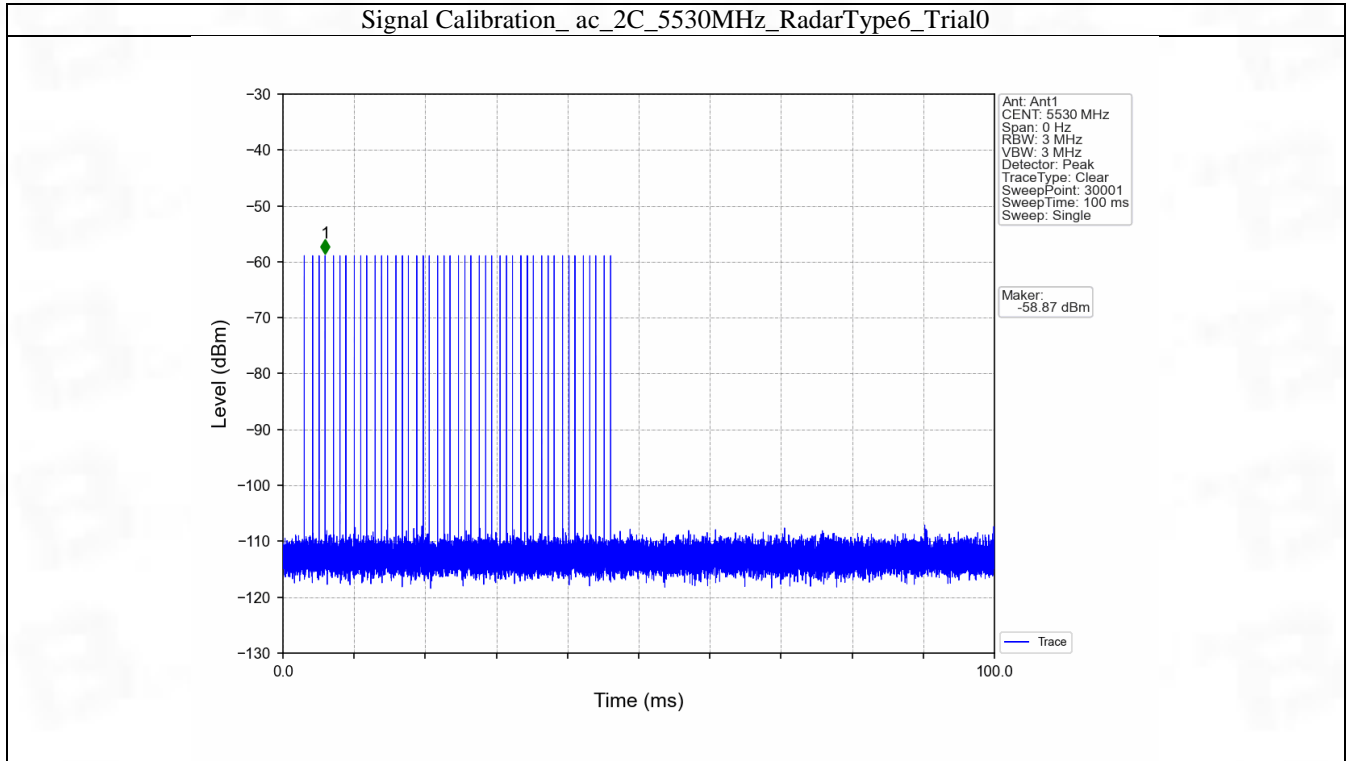

2. Channel Loading (Payload)

2.1 Payload

2.1.1 Test Result

Band: 2C					
Mode	Bandwidth (MHz)	Frequency (MHz)	Channel Loading (Payload) (%)		Verdict
			Result	Limit	
802.11ac	80	5290	95.90	≥ 17	Pass
802.11ac	80	5530	95.90	≥ 17	Pass

2.1.2 Test Graph

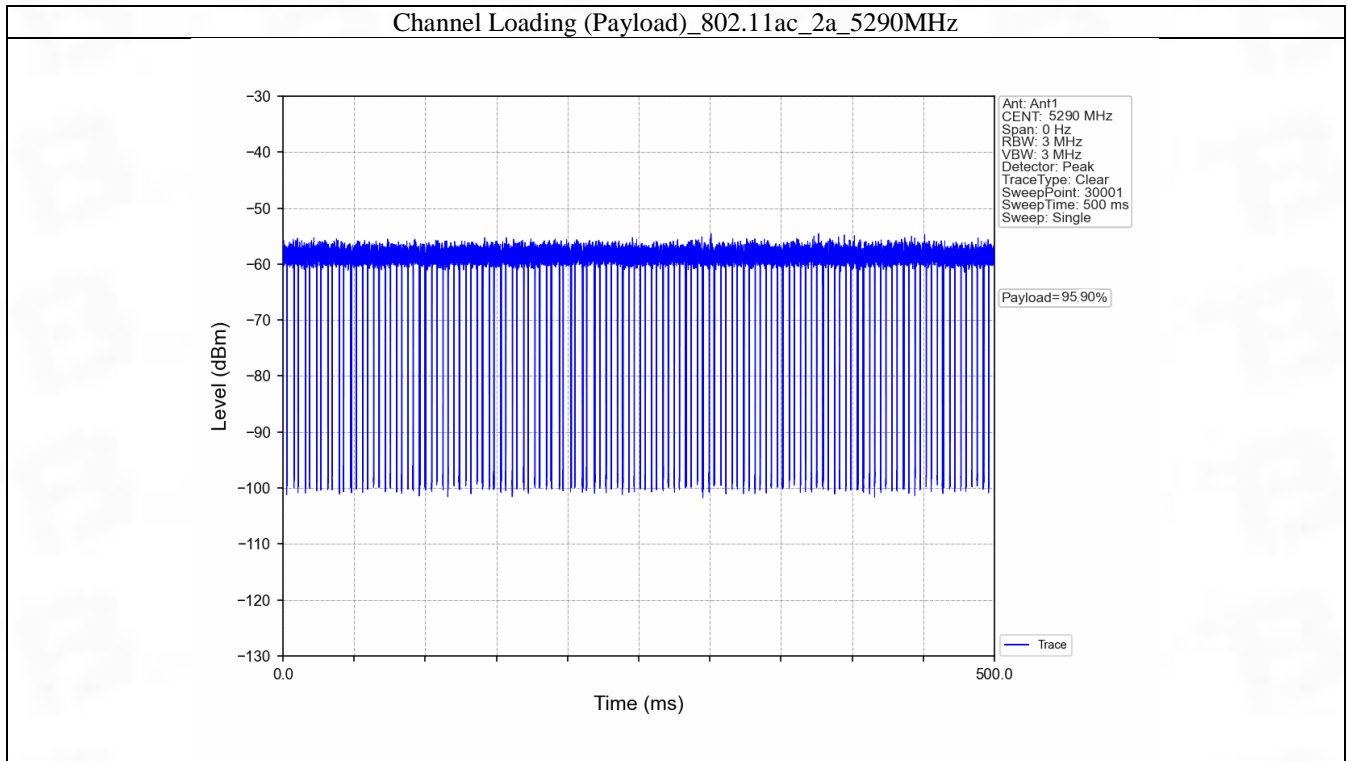

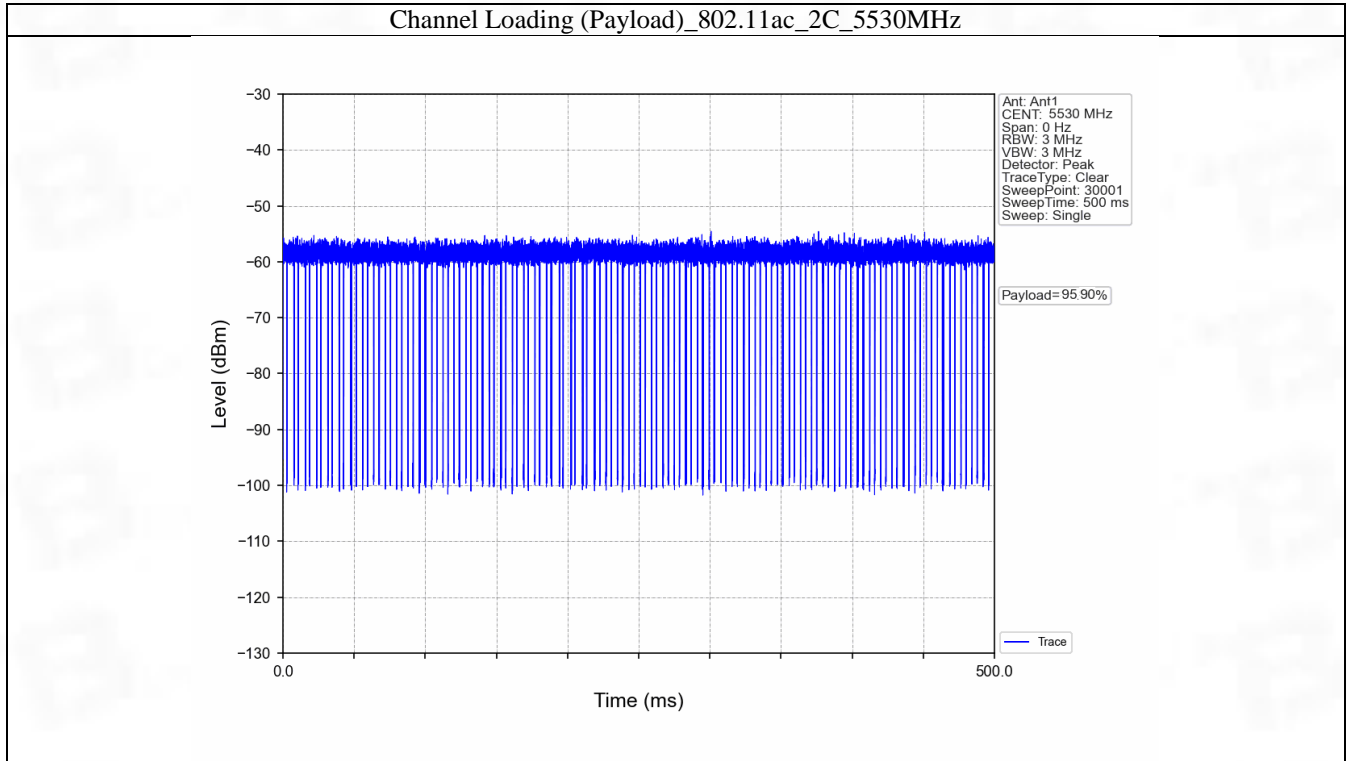

3. Channel Move Time and Closing Transmission Time

3.1 CMT_CTT

3.1.1 Test Result

Mode	Bandwidth (MHz)	Frequency (MHz)	Channel Move Time(s)		Closing Transmission Time(ms)		Verdict
			Result	Limit	Result	Limit	
802.11ac	80	5290	0.745	10	0.00	60	Pass
802.11ac	80	5530	0.661	10	0.00	60	Pass

3.1.2 Test Graph

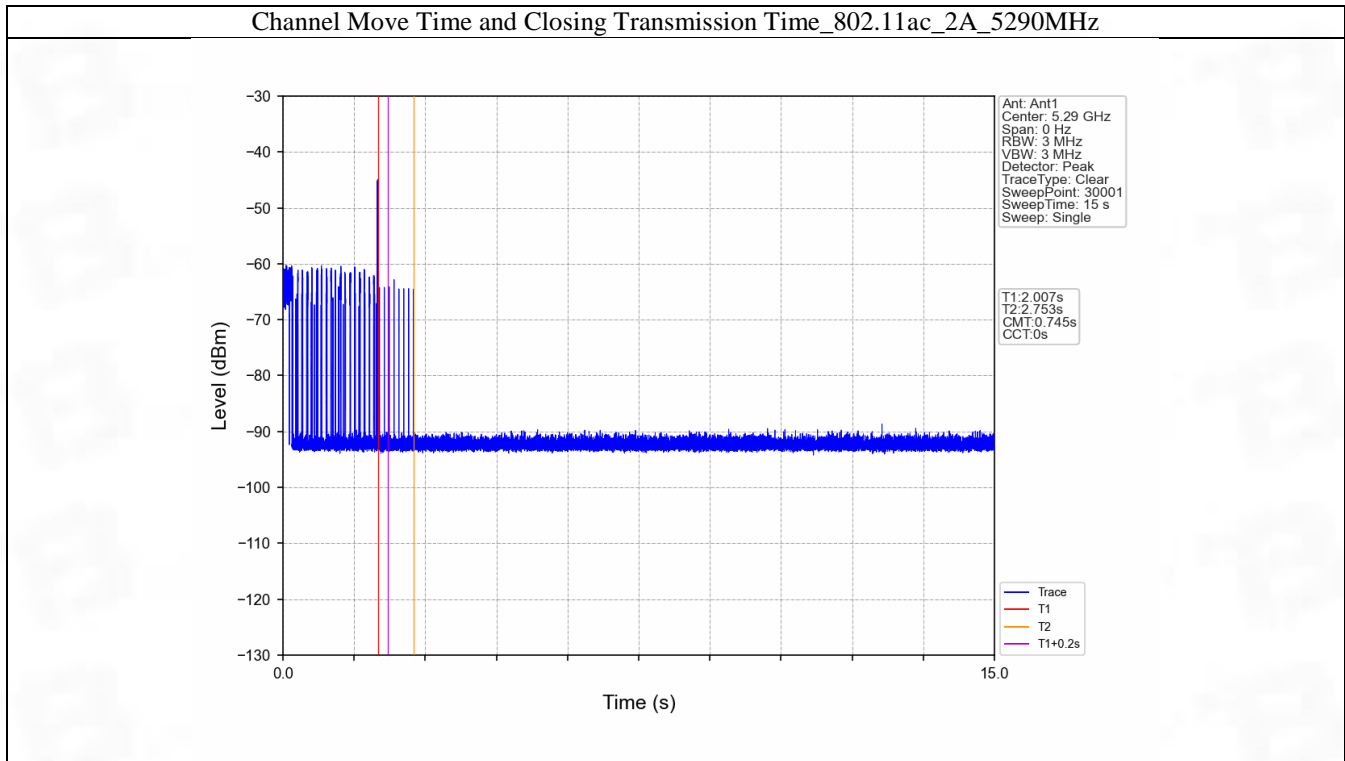

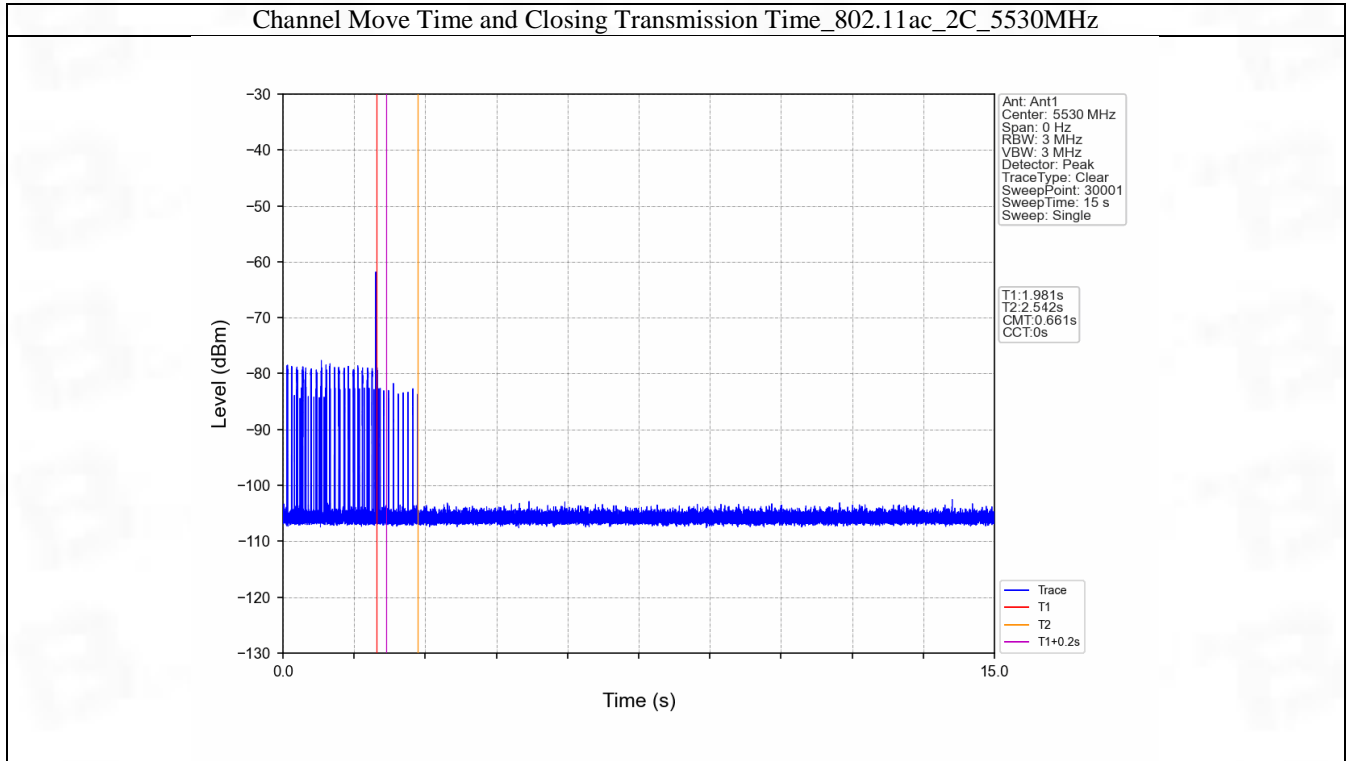

4. Non-Occupancy Period

4.1 Period

4.1.1 Test Result

Band: 2					
Mode	Bandwidth (MHz)	Frequency (MHz)	Non-Occupancy Period		Verdict
			Result	Limit	
802.11ac	80	5290	1800	1800	Pass
802.11ac	80	5530	1800	1800	Pass

8.1.2 Test Graph

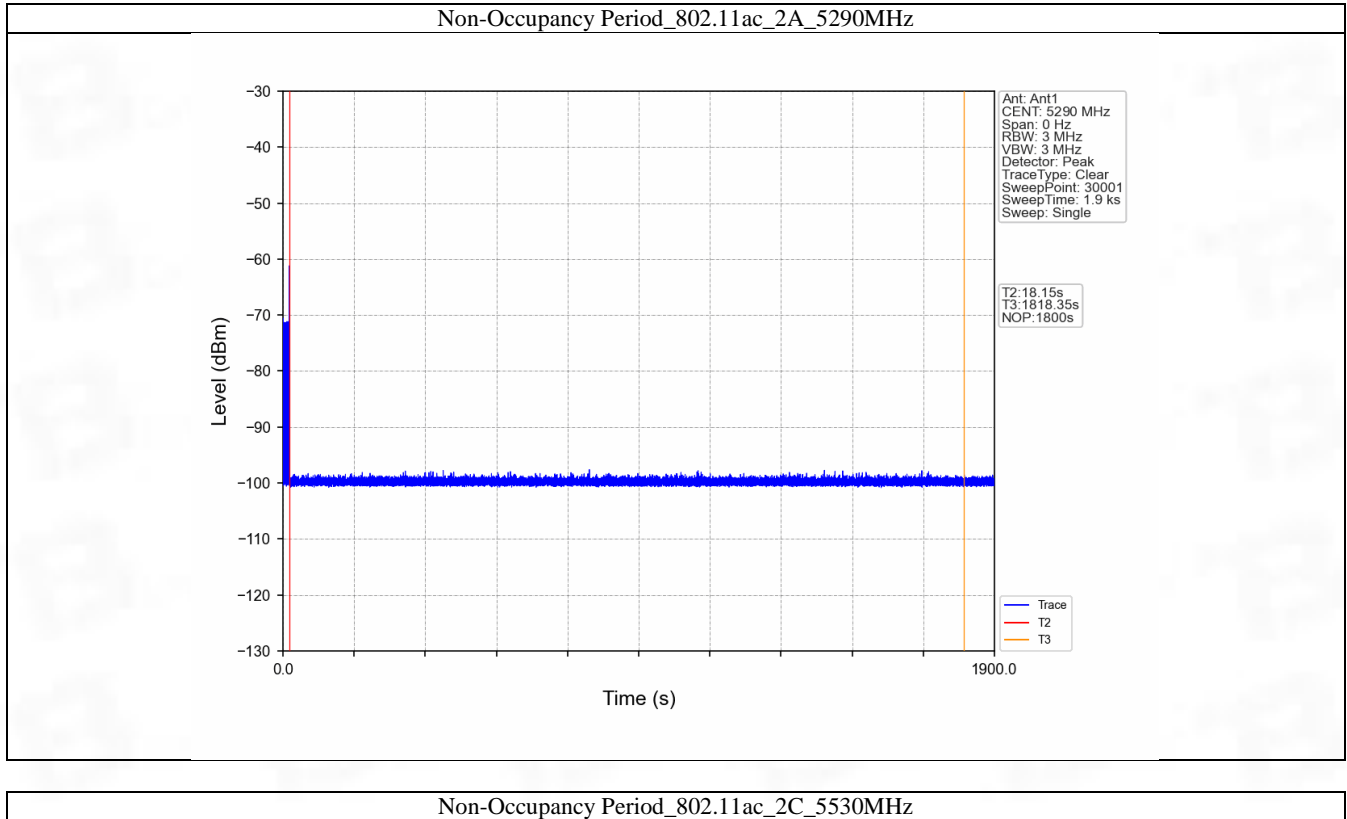

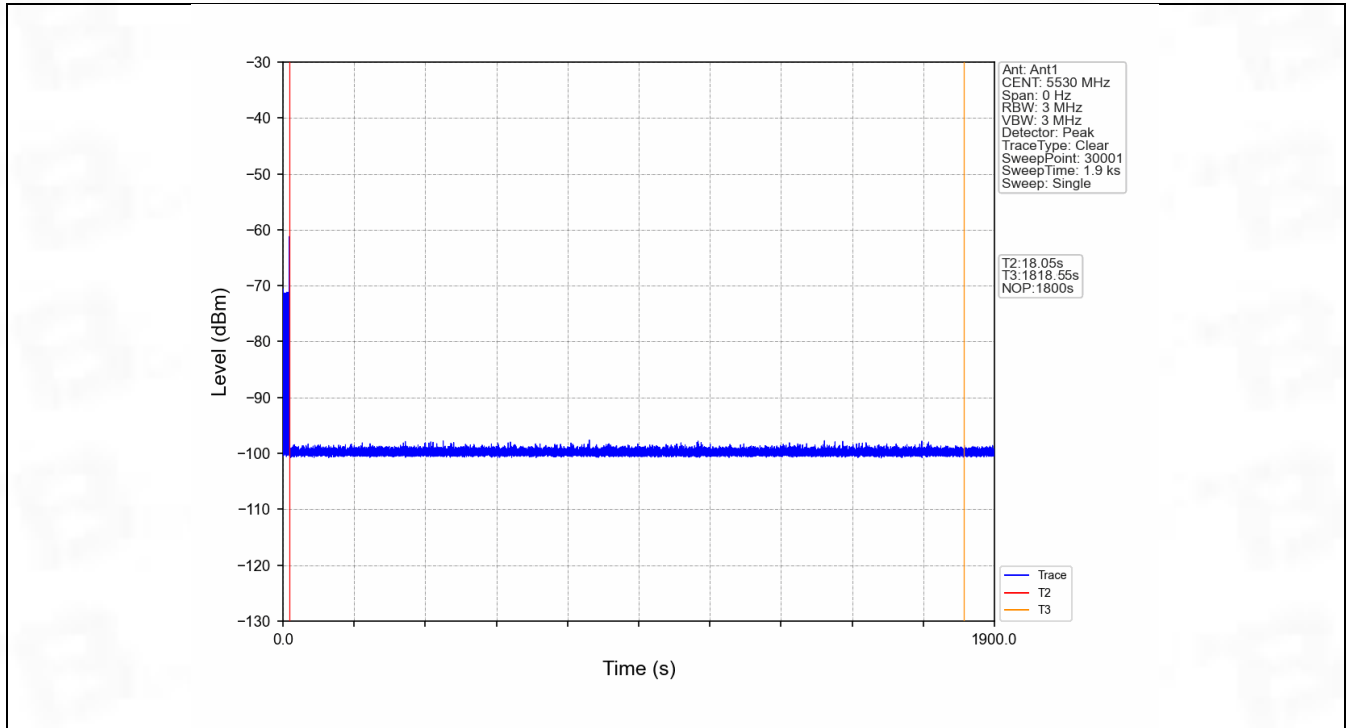

ANNEX BTEST SETUP PHOTOS

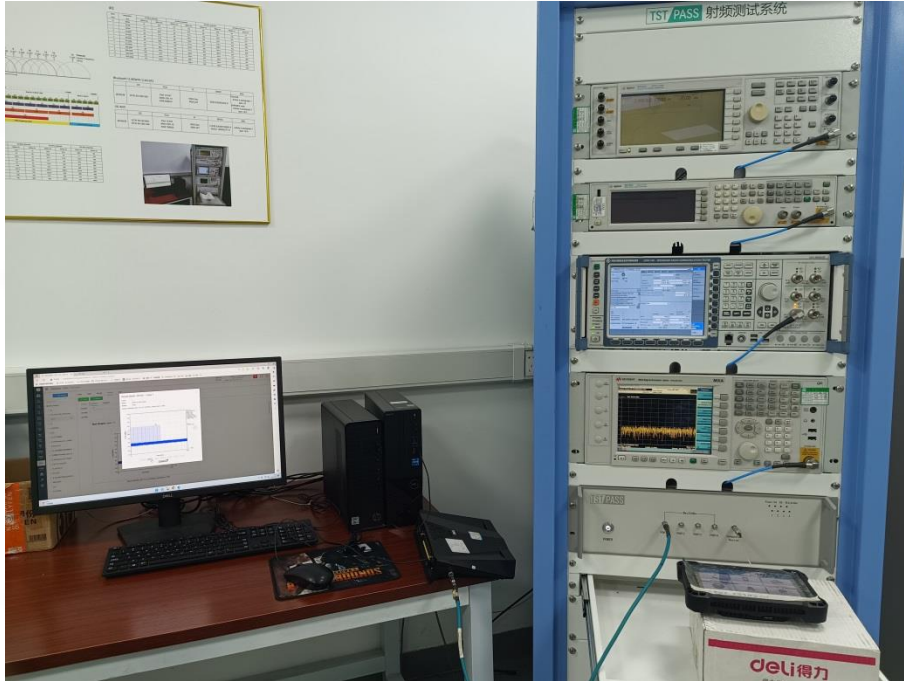



Test Report Number: BTF230628R00401



BTF Testing Lab (Shenzhen) Co., Ltd.

F101, 201 and 301, Building 1, Block 2, Tantou Industrial Park, Tantou Community, Songgang Street,
Bao'an District, Shenzhen, China

www.btf-lab.com

--END OF REPORT--