

FCC PART 15 SUBPART C TEST REPORT

FCC PART 15 SUBPART E 15.407

Report Reference No......: **MTEB23070004-R1**

FCC ID..... : **A4C-10012B**

Compiled by
(position+printed name+signature)..: File administrators Alisa Luo



Supervised by
(position+printed name+signature)..: Test Engineer Sunny Deng



Approved by
(position+printed name+signature)..: Manager Yvette Zhou

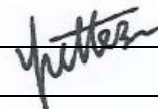

Date of issue.....: **Jul.03,2023**

Representative Laboratory Name ..: **Shenzhen Most Technology Service Co., Ltd.**

Address: No.5, 2nd Langshan Road, North District, Hi-tech Industrial Park,
Nanshan, Shenzhen, Guangdong, China.

Applicant's name.....: **RM ACQUISITIONS LLC**

Address: 8770 W. Bryn Mawr Avenue, Chicago, Illinois, United States, 60631

Test specification

Standard: **FCC Part 15 Subpart E 15.407**

Shenzhen Most Technology Service Co., Ltd. All rights reserved.

This publication may be reproduced in whole or in part for non-commercial purposes as long as the Shenzhen Most Technology Service Co., Ltd. is acknowledged as copyright owner and source of the material. Shenzhen Most Technology Service Co., Ltd. takes no responsibility for and will not assume liability for damages resulting from the reader's interpretation of the reproduced material due to its placement and context.

Test item description

Trade Mark: **RAND M[®]NALLY**

Manufacturer.....: **SHEN ZHEN APICAL TECHNOLOGY CO., LTD**

Model/Type reference.....: RandTab7

Listed Models: N/A

Ratings: DC 3.7V (by Battery)
DC 5V (by USB Port)
DC 5V (by Car Charger)

Modulation: OFDM

Frequency.....: From 5180MHz-5240MHz; 5260MHz-5320MHz;
5500MHz-5700MHz; 5745MHz-5825MHz

Hardware version: T1050-MT8176-MAIN-01B

Software version: RandTab7_mp

Result.....: **PASS**

TEST REPORT

Equipment under Test : GPS Device

Model /Type : RandTab7

Listed Models : N/A

Remark : N/A.

Applicant : RM ACQUISITIONS LLC

Address : 8770 W. Bryn Mawr Avenue,Chicago,Illinois,United States,60631

Manufacturer : SHEN ZHEN APICAL TECHNOLOGY CO., LTD

Address : 9/F,B Building, Tinghua Unis Infoport, Langshan RD, North district, Hi-tech Industrial Park, Nanshan, Shenzhen

Test Result:	PASS
---------------------	-------------

The test report merely corresponds to the test sample.
It is not permitted to copy extracts of these test result without the written permission of the test laboratory.

Contents

<u>1</u>	<u>REVISION HISTORY</u>	<u>4</u>
<u>2</u>	<u>TEST STANDARDS</u>	<u>5</u>
<u>3</u>	<u>SUMMARY</u>	<u>6</u>
3.1	General Remarks	6
3.2	Product Description	6
3.3	Equipment Under Test	6
3.4	Short description of the Equipment under Test (EUT)	6
3.5	EUT operation mode	7
3.6	Block Diagram of Test Setup	7
3.1	Test Item (Equipment Under Test) Description*	7
3.2	Auxiliary Equipment (AE) Description	8
3.3	Antenna Information*	8
3.4	Related Submittal(s) / Grant (s)	8
3.5	Modifications	8
3.6	EUT configuration	8
<u>4</u>	<u>TEST ENVIRONMENT</u>	<u>9</u>
4.1	Address of the test laboratory	9
4.2	Test Facility	9
4.3	Environmental conditions	9
4.4	Test Description	10
4.5	Statement of the measurement uncertainty	10
4.6	Equipments Used during the Test	11
<u>5</u>	<u>TEST CONDITIONS AND RESULTS</u>	<u>12</u>
5.1	AC Power Conducted Emission	12
5.2	Radiated Emissions	15
5.3	Conduction spurious emission	26
5.4	Maximum Conducted Average Output Power	27
5.5	Power Spectral Density	28
5.6	Emission Bandwidth (26dBm Bandwidth)	29
5.7	Minimum Emission Bandwidth (6dBm Bandwidth)	30
5.8	Frequency Stability	31
5.9	Duty Cycle Information	32
<u>6</u>	<u>TEST SETUP PHOTOS OF THE EUT</u>	<u>33</u>
<u>7</u>	<u>PHOTOS OF THE EUT</u>	<u>34</u>
	APPENDIX I.Frequency Stability	35
	APPENDIX II.Conducted Peak Output Power	36
	APPENDIX III.99% Bandwidth	38
	APPENDIX IV.6dB Bandwidth	50
	APPENDIX V.26dB Bandwidth	62
	APPENDIX VI.Conducted Out Of Band Emission	74
	APPENDIX VII.Duty Cycle	103

APPENDIX VIII. Peak Power Spectral Density

134

1 Revision History

Revision	Issue Date	Revisions	Revised By
00	2023-07-03	Initial Issue	Alisa Luo

2 TEST STANDARDS

The tests were performed according to following standards:

[FCC Rules Part 15 Subpart E](#)—Unlicensed National Information Infrastructure Devices

[ANSI C63.10-2013](#): American National Standard for Testing Unlicensed Wireless Devices

[KDB789033 D02](#): General UNII Test Procedures New Rules v01r02

3 SUMMARY

3.1 General Remarks

Date of receipt of test sample	:	2023.06.19
Testing commenced on	:	2023.06.20
Testing concluded on	:	2023.07.03

3.2 Product Description

Product Description:	GPS Device			
Model:	RandTab7			
Power supply:	DC 3.7V (by Battery) DC 5V (by USB Port) DC 5V (by Car Charger)			
Testing sample ID:	MTYP01540			
WIFI				
Supported type:	20MHz system	40MHz system	80MHz system	160MHz system
	802.11a 802.11n 802.11ac	802.11n 802.11ac	802.11ac	N/A
Operation frequency:	5180MHz-5240MHz 5260MHz-5320MHz 5500MHz-5700MHz 5745MHz-5825MHz	5190MHz-5230MHz 5270-5310 5510-5670 5755MHz-5795MHz	5210MHz 5290MHz 5530MHz-5610MHz 5775MHz	N/A
Modulation:	OFDM	OFDM	OFDM	N/A
Antenna type:	FPC Antenna			
Antenna gain:	5180MHz-5240MHz:2.9dBi, 5260MHz-5320MHz:2.9dBi, 5500MHz-5700MHz:2.9dBi, 5745MHz-5825MHz:2.9dBi,			

3.3 Equipment Under Test

Power supply system utilised

Power supply voltage	:	<input type="radio"/> 230V / 50 Hz	<input type="radio"/> 120V / 60Hz
		<input type="radio"/> 12 V DC	<input type="radio"/> 24 V DC
		<input checked="" type="radio"/> Other (specified in blank below)	

DC 3.7V (by Battery)
DC 5V (by USB Port)
DC 5V (by Car Charger)

3.4 Short description of the Equipment under Test (EUT)

This is a GPS Device

For more details, refer to the user's manual of the EUT.

3.5 EUT operation mode

The Applicant provides communication tools software (AT command) to control the EUT for staying in continuous transmitting (Duty Cycle more than 98%) and receiving mode for testing. All test performed at the low, middle and high of operational frequency range of each mode.

Operation Frequency List WIFI on 5G Band:

Operating band	20MHz		40MHz		80MHz	
	Channel	Frequency (MHz)	Channel	Frequency (MHz)	Channel	Frequency (MHz)
U-NII 1 (5150MHz-5250MHz)	36	5180	38	5190	42	5210
	40	5200				
	44	5220				
	48	5240				
U-NII 2A	52	5260	54	5270	58	5290
	56	5280				
	60	5300				
	64	5320				
U-NII 2C	100	5500	102	5510	106	5530
	104	5520				
	108	5540				
	112	5560				
	116	5580	118	5590		
	120	5600				
	124	5620				
	128	5640				
	132	5660	134	5670	--	--
	140	5700			--	--
U-NII 3 (5725MHz-5850MHz)	149	5745	151	5755	155	5775
	153	5765				
	157	5785				
	161	5805				
	165	5825	--	--		

Note: The line display in grey is those Channels/Frequencies select to test in this report for each operation mode.

3.6 Block Diagram of Test Setup

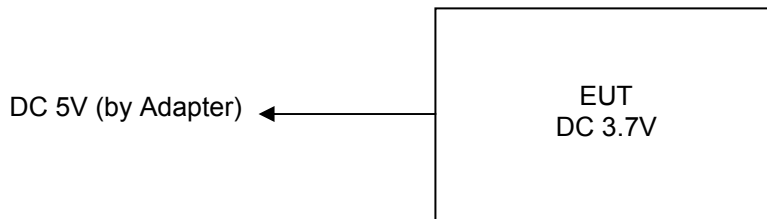

3.1 Test Item (Equipment Under Test) Description*

Short designation	EUT Name	EUT Description	Serial number	Hardware status	Software status
EUT A					
EUT B					

*: declared by the applicant. According to customers information EUTs A and B are the same devices.

3.2 Auxiliary Equipment (AE) Description

AE short designation	EUT Name (if available)	EUT Description	Serial number (if available)	Software (if used)
AE 1	Adapter	/	MDY-08-EH	
AE 2	-			

3.3 Antenna Information*

Short designation	Antenna Name	Antenna Type	Frequency Range	Serial number	Antenna Peak Gain
Antenna 1	---	FPC Antenna	5180MHz-5240MHz 5260MHz-5320MHz 5500MHz-5700MHz 5745MHz-5825MHz	---	2.9dBi
Antenna 2					

*: declared by the applicant.

3.4 Related Submittal(s) / Grant (s)

This submittal(s) (test report) is intended to comply with Section 15.407 of the FCC Part 15, Subpart E Rules.

3.5 Modifications

No modifications were implemented to meet testing criteria.

3.6 EUT configuration

The following peripheral devices and interface cables were connected during the measurement:

- supplied by the manufacturer

- Supplied by the lab

<input checked="" type="radio"/>	ADAPTER	M/N:	MDY-08-EH
		Manufacturer:	Xiaomi Communications Co.,Ltd

4 TEST ENVIRONMENT

4.1 Address of the test laboratory

Shenzhen Most Technology Service Co., Ltd.

No.5, 2nd Langshan Road, North District, Hi-tech Industrial Park, Nanshan, Shenzhen, Guangdong, China.

The 3m-Semi anechoic test site fulfils CISPR 16-1-4 according to ANSI C63.4:2014 and CISPR 16-1-4:2010 SVSWR requirement for radiated emission above 1GHz.

4.2 Test Facility

The test facility is recognized, certified, or accredited by the following organizations:

The test facility is recognized, certified, or accredited by the following organizations:

FCC-Registration No.: 0031192610

Shenzhen Most Technology Service Co., Ltd. EMC Laboratory has been registered and fully described in a report filed with the (FCC) Federal Communications Commission. The acceptance letter from the FCC is maintained in our files.

A2LA-Lab Cert. No.: 6343.01

Shenzhen Most Technology Service Co., Ltd. EMC Laboratory has been accredited by A2LA for technical competence in the field of electrical testing, and proved to be in compliance with ISO/IEC 17025: 2005 General Requirements for the Competence of Testing and Calibration Laboratories and any additional program requirements in the identified field of testing.

4.3 Environmental conditions

Radiated Emission:

Temperature:	23 ° C
Humidity:	48 %
Atmospheric pressure:	950-1050mbar

AC Main Conducted testing:

Temperature:	24 ° C
Humidity:	45 %
Atmospheric pressure:	950-1050mbar

Conducted testing:

Temperature:	24 ° C
Humidity:	45 %
Atmospheric pressure:	950-1050mbar

4.4 Test Description

FCC Requirement		
FCC Part 15.207	AC Power Conducted Emission	N/A
FCC Part 15.407(a)	Emission Bandwidth(26dBm Bandwidth)	PASS _{Note1}
FCC Part 15.407(e)	Minimum Emission Bandwidth(6dBm Bandwidth)	PASS _{Note2}
FCC Part 15.407(a)	Maximum Conducted Output Power	PASS
FCC Part 15.407(a)	Peak Power Spectral Density	PASS
FCC Part 15.407(g)	Frequency Stability	PASS
FCC Part 15.407(b)	Undesirable emission	PASS
FCC Part 15.407(b)/15.205/15.209	Radiated Emissions	PASS
FCC Part 15.407(h)	Dynamic Frequency Selection	N/A _{Note 3}
FCC Part 15.203/15.247(b)	Antenna Requirement	PASS

Note 1: Apply to U-NII 1, U-NII 2A, and U-NII 2C band.

Note 2: Apply to U-NII 3 band only.

Note 3: This device not work in DFS band.

Data Rate Used:

Preliminary tests were performed in different data rate to find the worst radiated emission. The data rate shown in the table below is the worst-case rate with respect to the specific test item. Investigation has been done on all the possible configurations for searching the worst cases. The following table is a list of the test modes shown in this test report.

Test Items	Mode	Data Rate
Maximum Conducted Output Power Power Spectral Density Emission Bandwidth(26dBm Bandwidth) Minimum Emission Bandwidth(6dBm Bandwidth) Undesirable emission Frequency Stability	11a/OFDM	54 Mbps
	11n(20MHz),11ac(20MHz)/OFDM	MCS0
	11n(40MHz),11ac(40MHz)/OFDM	MCS0
	11ac(80MHz)/OFDM	MCS0

4.5 Statement of the measurement uncertainty

The data and results referenced in this document are true and accurate. The reader is cautioned that there may be errors within the calibration limits of the equipment and facilities. The measurement uncertainty was calculated for all measurements listed in this test report acc. to CISPR 16 - 4 „Specification for radio disturbance and immunity measuring apparatus and methods – Part 4: Uncertainty in EMC Measurements“ and is documented in the Shenzhen Most Technology Service Co., Ltd. quality system acc. to DIN EN ISO/IEC 17025. Furthermore, component and process variability of devices similar to that tested may result in additional deviation. The manufacturer has the sole responsibility of continued compliance of the device.

Hereafter the best measurement capability for Shenzhen Most Technology Service Co., Ltd. is reported:

Test Items	Mode	Data Rate
Maximum Conducted Output Power Power Spectral Density Emission Bandwidth(26dBm Bandwidth) Minimum Emission Bandwidth(6dBm Bandwidth)	11a/OFDM	54 Mbps
	11n(20MHz),11ac(20MHz)/OFDM	MCS0

Undesirable emission Frequency Stability	11n(40MHz),11ac(40MHz)/OFDM	MCS0
	11ac(80MHz)/OFDM	MCS0

(1) This uncertainty represents an expanded uncertainty expressed at approximately the 95% confidence level using a coverage factor of k=2.

4.6 Equipments Used during the Test

Item	Equipment	Manufacturer	Model No.	Serial No.	Firmware versions	Last Cal.	Cal. Interval
1.	L.I.S.N.	R&S	ENV216	100093	/	2023/03/17	1 Year
2	Three-phase artificial power network	Schwarzback Mess	NNLK8129	8129178	/	2023/03/17	1 Year
3.	Receiver	R&S	ESCI	100492	V3.0-10-2	2023/03/17	1 Year
4	Receiver	R&S	ESPI	101202	V3.0-10-2	2023/03/17	1 Year
5	Spectrum analyzer	Agilent	9020A	MT-E306	A14.16	2023/03/17	1 Year
6	Bilog Antenna	Sunol Sciences	JB3	A121206	/	2023/03/17	1 Year
7	Horn antenna	HF Antenna	HF Antenna	MT-E158	/	2023/03/17	1 Year
8	Loop antenna	Beijing Daze	ZN30900B	/	/	2023/03/17	1 Year
9	Horn antenna	R&S	OBH100400	26999002	/	2023/03/17	1 Year
10	Wireless Communication Test Set	R&S	CMW500	/	CMW-BASE-3.7.21	2023/03/17	1 Year
11	Spectrum analyzer	R&S	FSP	100019	V4.40 SP2	2023/03/17	1 Year
12	High gain antenna	Schwarzbeck	LB-180400KF	MT-E389	/	2023/03/17	1 Year
13	Preamplifier	Schwarzbeck	BBV 9743	MT-E390	/	2023/03/17	1 Year
14	Pre-amplifier	EMCI	EMC051845S E	MT-E391	/	2023/03/17	1 Year
15	Pre-amplifier	Agilent	83051A	MT-E392	/	2023/03/17	1 Year
16	High pass filter unit	Tonscend	JS0806-F	MT-E393	/	2023/03/17	1 Year
17	RF Cable(below1GHz)	Times	9kHz-1GHz	MT-E394	/	2023/03/17	1 Year
18	RF Cable(above 1GHz)	Times	1-40G	MT-E395	/	2023/03/17	1 Year
19	RF Cable (9KHz-40GHz)	Tonscend	170660	N/A	/	2023/03/17	1 Year

Note: The Cal.Interval was one year.

5 TEST CONDITIONS AND RESULTS

5.1 AC Power Conducted Emission

TEST CONFIGURATION

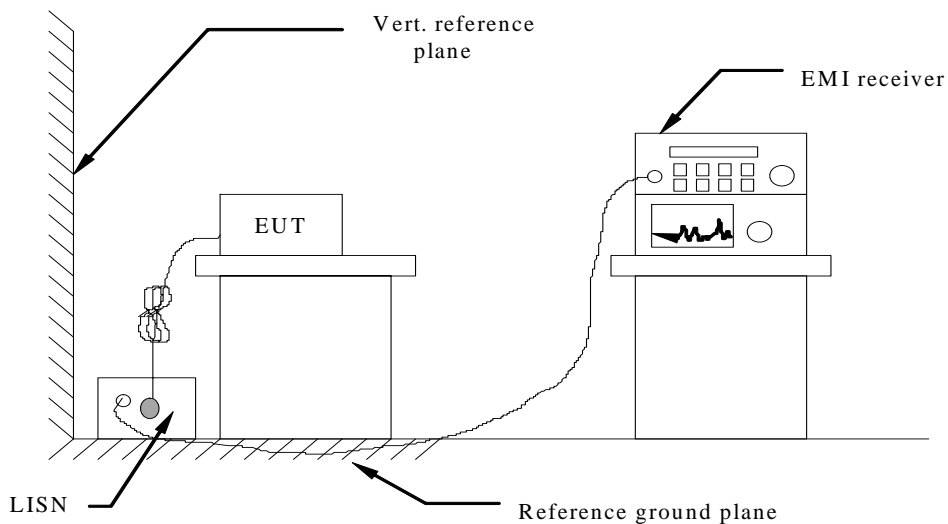

TEST PROCEDURE

- 1 The equipment was set up as per the test configuration to simulate typical actual usage per the user's manual. The EUT is a tabletop system, a wooden table with a height of 0.8 meters is used and is placed on the ground plane as per ANSI C63.10-2013.
- 2 Support equipment, if needed, was placed as per ANSI C63.10-2013
- 3 All I/O cables were positioned to simulate typical actual usage as per ANSI C63.10-2013
- 4 The EUT received DC 12V power from adapter, the adapter received AC120V/60Hz and AC 240V/60Hz power through a Line Impedance Stabilization Network (LISN) which supplied power source and was grounded to the ground plane.
- 5 All support equipments received AC power from a second LISN, if any.
- 6 The EUT test program was started. Emissions were measured on each current carrying line of the EUT using a spectrum Analyzer / Receiver connected to the LISN powering the EUT. The LISN has two monitoring points: Line 1 (Hot Side) and Line 2 (Neutral Side). Two scans were taken: one with Line 1 connected to Analyzer / Receiver and Line 2 connected to a 50 ohm load; the second scan had Line 1 connected to a 50 ohm load and Line 2 connected to the Analyzer / Receiver.
- 7 Analyzer / Receiver scanned from 150 KHz to 30MHz for emissions in each of the test modes.
- 8 During the above scans, the emissions were maximized by cable manipulation.

AC Power Conducted Emission Limit

For intentional device, according to § 15.207(a) AC Power Conducted Emission Limits is as following :

Frequency range (MHz)	Limit (dBuV)	
	Quasi-peak	Average
0.15-0.5	66 to 56*	56 to 46*
0.5-5	56	46
5-30	60	50

* Decreases with the logarithm of the frequency.

TEST RESULTS

Remark:

1. WIFI 5G modes were test at 802.11a, 802.11n(20), 802.11n(40)(Low, Middle, and High channel); only the worst result of 802.11a Middle Channel was reported as below:

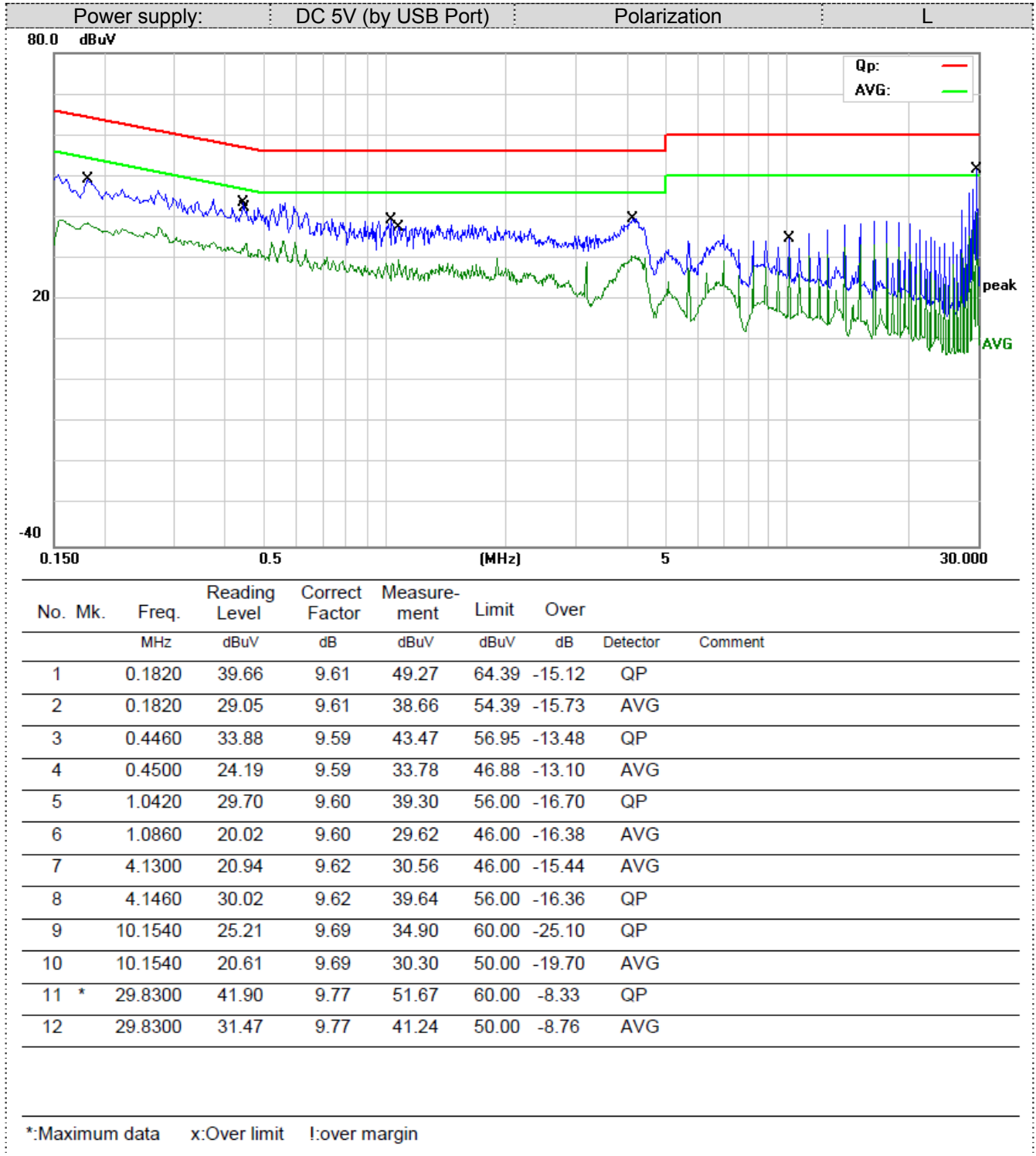

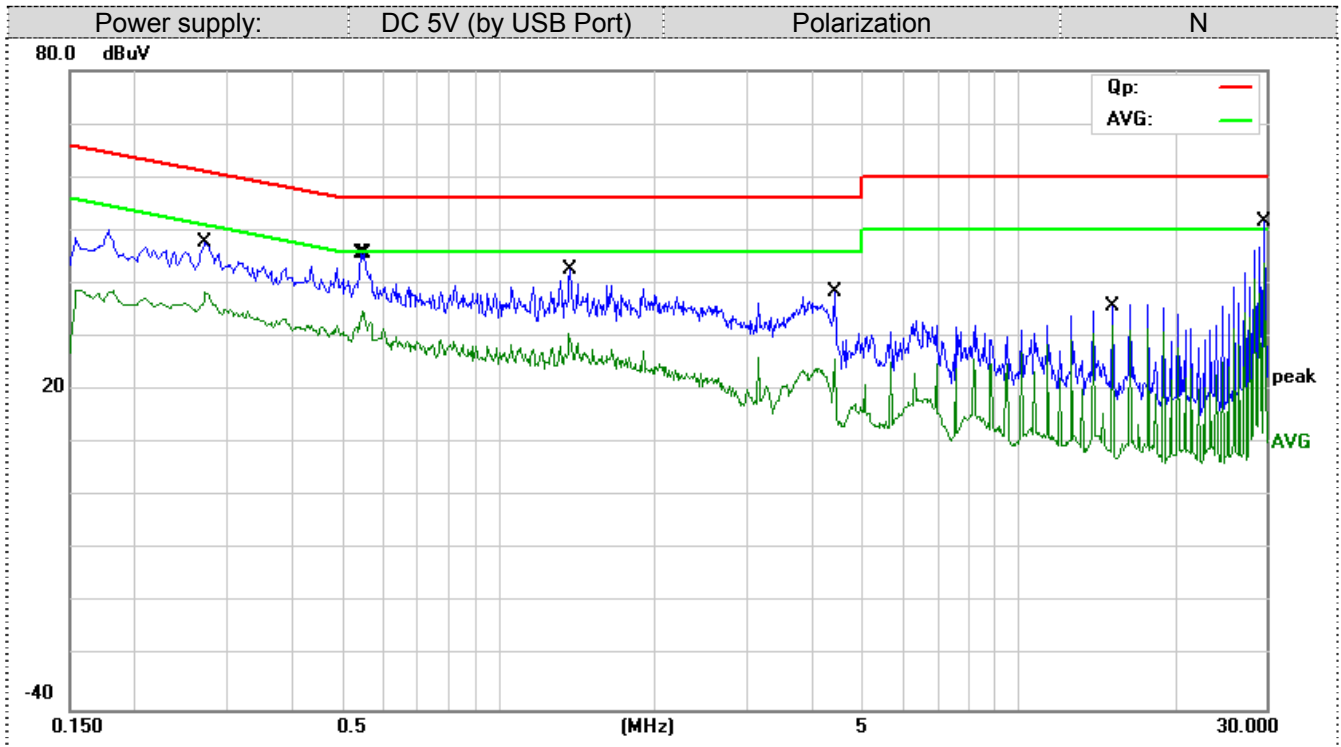

No.	Mk.	Freq. MHz	Reading Level dBuV	Correct Factor dB	Measure- ment dBuV	Limit dBuV	Over dB	Detector	Comment
1		0.2740	38.14	9.60	47.74	61.00	-13.26	QP	
2		0.2740	28.73	9.60	38.33	51.00	-12.67	AVG	
3		0.5460	35.98	9.59	45.57	56.00	-10.43	QP	
4		0.5500	25.27	9.59	34.86	46.00	-11.14	AVG	
5		1.3700	20.92	9.60	30.52	46.00	-15.48	AVG	
6		1.3780	33.01	9.60	42.61	56.00	-13.39	QP	
7		4.4340	28.81	9.62	38.43	56.00	-17.57	QP	
8		4.4340	16.15	9.62	25.77	46.00	-20.23	AVG	
9		15.2020	26.02	9.70	35.72	60.00	-24.28	QP	
10		15.2020	22.48	9.70	32.18	50.00	-17.82	AVG	
11		29.8260	41.74	9.77	51.51	60.00	-8.49	QP	
12	*	29.8260	33.98	9.77	43.75	50.00	-6.25	AVG	

*:Maximum data x:Over limit !:over margin

5.2 Radiated Emissions

Limit

The maximum emissions outside of the frequency bands of operation shall be attenuated in accordance with the following limits:

- (1) For transmitters operating in the 5.15-5.25 GHz band: All emissions outside of the 5.15-5.35 GHz band shall not exceed an e.i.r.p. of -27 dBm/MHz.
- (2) For transmitters operating in the 5.25-5.35 GHz band: All emissions outside of the 5.15-5.35 GHz band shall not exceed an e.i.r.p. of -27 dBm/MHz.
- (3) For transmitters operating in the 5.47-5.725 GHz band: All emissions outside of the 5.47-5.725 GHz band shall not exceed an e.i.r.p. of -27 dBm/MHz.
- (4) For transmitters operating in the 5.725-5.85 GHz band: All emissions shall be limited to a level of -27 dBm/MHz at 75 MHz or more above or below the band edge increasing linearly to 10 dBm/MHz at 25 MHz above or below the band edge, and from 25 MHz above or below the band edge increasing linearly to a level of 15.6 dBm/MHz at 5 MHz above or below the band edge, and from 5 MHz above or below the band edge increasing linearly to a level of 27 dBm/MHz at the band edge.

Undesirable emission limits

Requirement	Limit(EIRP)	Limit (Field strength at 3m) ^{Note1}
15.407(b)(1)	PK:-27(dBm/MHz)	PK:68.2(dBμV/m)
15.407(b)(2)		
15.407(b)(3)		
15.407(b)(4)		

Note1: The following formula is used to convert the equipment isotropic radiated power (eirp) to field strength:

$$E = \frac{1000000\sqrt{30P}}{3} \mu\text{V/m, where P is the eirp (Watts)}$$

- (5) Unwanted emissions below 1 GHz must comply with the general field strength limits set forth in §15.209
- (6) In addition, radiated emissions which fall in the restricted bands, as defined in §15.205(a), must also comply with the radiated emission limits specified in §15.209(a)

Radiated emission limits

Frequency (MHz)	Distance (Meters)	Radiated (dBμV/m)	Radiated (μV/m)
0.009-0.49	3	20log(2400/F(KHz))+40log(300/3)	2400/F(KHz)
0.49-1.705	3	20log(24000/F(KHz))+ 40log(30/3)	24000/F(KHz)
1.705-30	3	20log(30)+ 40log(30/3)	30
30-88	3	40.0	100
88-216	3	43.5	150
216-960	3	46.0	200
Above 960	3	54.0	500

TEST CONFIGURATION

(A) Radiated Emission Test Set-Up, Frequency Below 30MHz

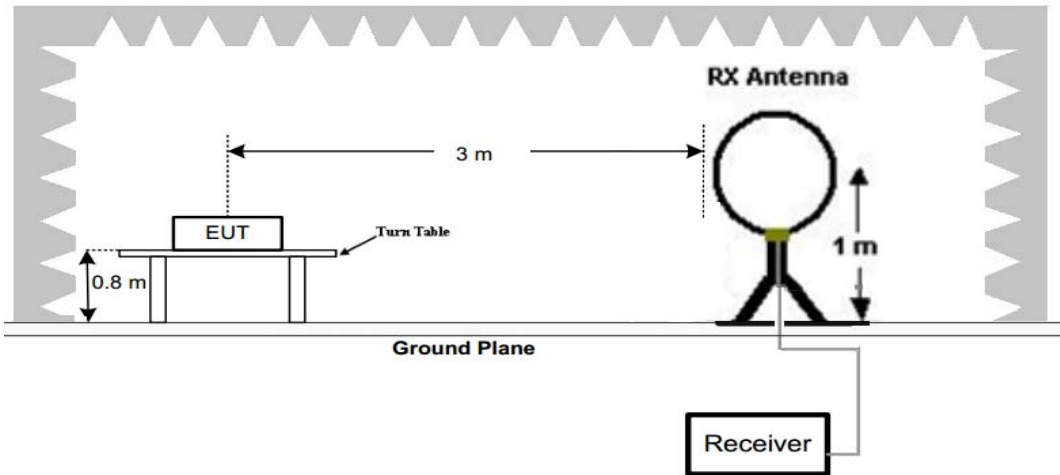

(B) Radiated Emission Test Set-Up, Frequency below 1000MHz

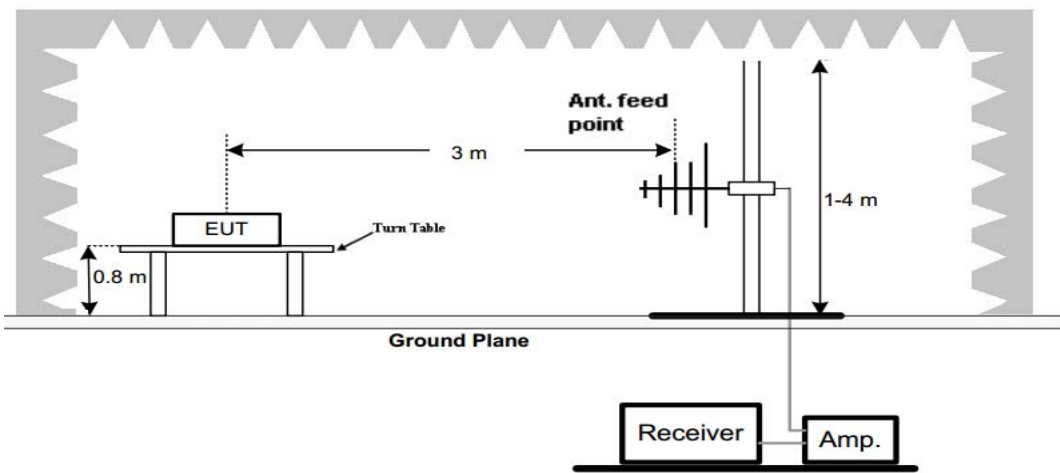

(C) Radiated Emission Test Set-Up, Frequency above 1000MHz

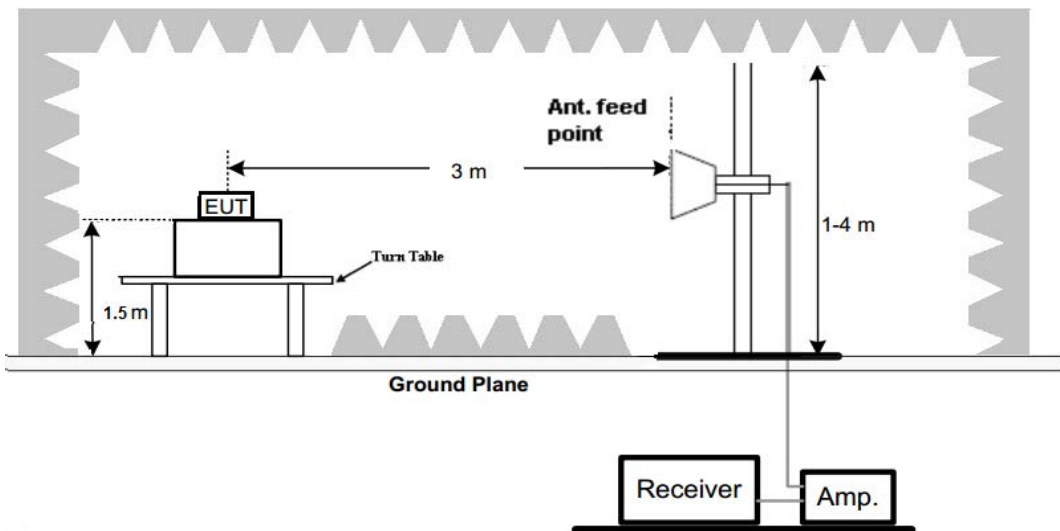

Test Procedure

1. Below 1GHz measurement the EUT is placed on a turntable which is 0.8m above ground plane, and above 1GHz measurement EUT was placed on a low permittivity and low loss tangent turn table which is 1.5m above ground plane.
2. Maximum procedure was performed by raising the receiving antenna from 1m to 4m and rotating the turn table from 0°C to 360°C to acquire the highest emissions from EUT
3. And also, each emission was to be maximized by changing the polarization of receiving antenna both horizontal and vertical.
4. Repeat above procedures until all frequency measurements have been completed.
5. Radiated emission test frequency band from 9KHz to 40GHz.
6. The distance between test antenna and EUT as following table states:

Test Frequency range	Test Antenna Type	Test Distance
9KHz-30MHz	Active Loop Antenna	3
30MHz-1GHz	Bilog Antenna	3
1GHz-18GHz	Horn Antenna	3
18GHz-25GHz	Horn Antenna	1

7. Setting test receiver/spectrum as following table states:

Test Frequency range	Test Receiver/Spectrum Setting	Detector
9KHz-150KHz	RBW=200Hz/VBW=3KHz,Sweep time=Auto	QP
150KHz-30MHz	RBW=9KHz/VBW=100KHz,Sweep time=Auto	QP
30MHz-1GHz	RBW=120KHz/VBW=1000KHz,Sweep time=Auto	QP
1GHz-40GHz	Peak Value: RBW=1MHz/VBW=3MHz, Sweep time=Auto Average Value: RBW=1MHz/VBW=10Hz, Sweep time=Auto	Peak

TEST RESULTS

Remark:

1. This test was performed with EUT in X, Y, Z position and the worse case was found when EUT in X position.
2. All 802.11a / 802.11n (HT20) / 802.11n (HT40)/802.11ac(HT20)/802.11ac(HT40)/802.11ac(HT80) modes have been tested for below 1GHz test, only the worst case 802.11a low channel of U-NII 1 band was recorded.
3. All 802.11a / 802.11n (HT20) / 802.11n (HT40)/802.11ac(HT20)/802.11ac(HT40)/802.11ac(HT80) modes have been tested for above 1GHz test, only the worst case 802.11a was recorded.
4. Radiated emission test from 9 KHz to 10th harmonic of fundamental was verified, and no emission found except system noise floor in 9 KHz to 30MHz and not recorded in this report.
5. Remark: Result=Reading value+Factor

For 30MHz-1GHz

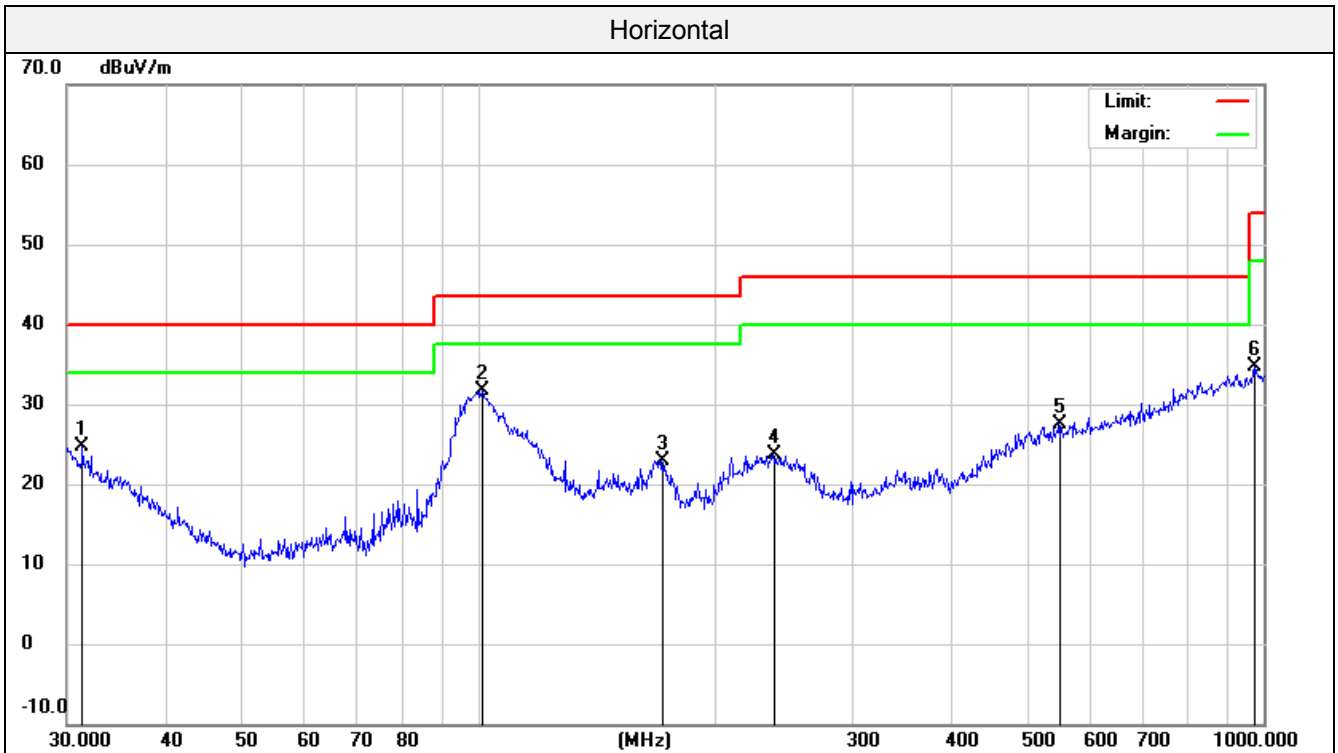

No.	Mk.	Freq. MHz	Reading Level dBuV	Correct Factor dB	Measure- ment dBuV/m	Limit dBuV/m	Over dB	Detector	Antenna Height cm	Table Degree	Comment
1		31.3992	4.66	19.95	24.61	40.00	-15.39	QP	200	251	
2	*	101.2885	17.96	13.74	31.70	43.50	-11.80	QP	200	119	
3		171.3926	6.08	16.92	23.00	43.50	-20.50	QP	200	158	
4		237.4760	9.64	14.15	23.79	46.00	-22.21	QP	200	265	
5		549.0195	4.23	23.24	27.47	46.00	-18.53	QP	200	187	
6		972.3374	4.91	29.72	34.63	54.00	-19.37	QP	200	87	

*:Maximum data x:Over limit !:over margin

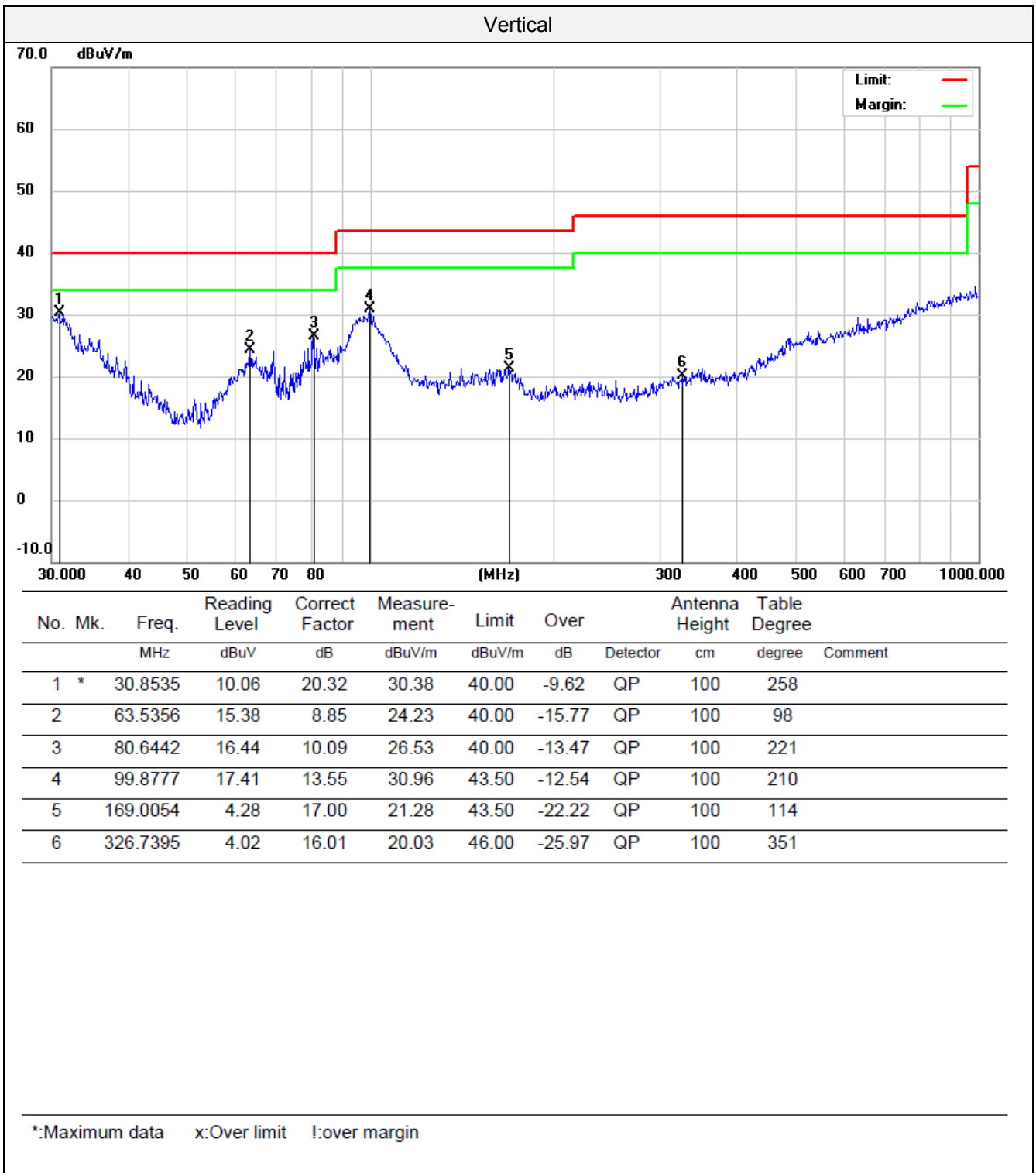

For 1GHz to 40GHz

Note: All 802.11a / 802.11n (HT20) / 802.11n (HT40)/802.11ac(HT20)/802.11ac(HT40)/802.11ac(HT80) modes have been tested for above 1GHz test, only the worst case 802.11a was recorded.

U-NII 1

Polar (H/V)	Frequency (MHz)	Meter Reading (dBuV)	Antenna Factor (dB)	Cable loss (dB)	Preamp factor (dB)	Emission Level (dBuV/m)	Limits (dBuV/m)	Margin (dB)	Detector Type
802.11a Mode -5180MHz									
V	3586	56.21	29.03	5.24	36.4	54.08	68.2	14.12	PK
V	3586	43.8	29.03	5.24	36.4	41.67	54	12.33	AV
H	3586	52.35	29.03	5.24	36.4	50.22	68.2	17.98	PK
H	3586	47.9	29.03	5.24	36.4	45.77	54	8.23	AV
V	10360	33.76	39.41	11.45	34.28	50.34	68.2	17.86	PK
V	10360	25.27	39.41	11.45	34.28	41.85	54	12.15	AV
H	10360	33.99	39.41	11.45	34.28	50.57	68.2	17.63	PK
H	10360	27.12	39.41	11.45	34.28	43.7	54	10.3	AV
802.11a Mode -5200MHz									
V	3586	53.46	29.03	5.24	36.4	51.33	68.2	16.87	PK
V	3586	43.16	29.03	5.24	36.4	41.03	54	12.97	AV
H	3586	53.53	29.03	5.24	36.4	51.4	68.2	16.8	PK
H	3586	48.01	29.03	5.24	36.4	45.88	54	8.12	AV
V	10400	35.68	39.42	11.47	34.28	52.29	68.2	15.91	PK
V	10400	25.7	39.42	11.47	34.28	42.31	54	11.69	AV
H	10400	35.03	39.42	11.47	34.28	51.64	68.2	16.56	PK
H	10400	28.83	39.42	11.47	34.28	45.44	54	8.56	AV
802.11b Mode -5240MHz									
V	3586	54.32	29.03	5.24	36.4	52.19	68.2	16.01	PK
V	3586	43.32	29.03	5.24	36.4	41.19	54	12.81	AV
H	3586	53.69	29.03	5.24	36.4	51.56	68.2	16.64	PK
H	3586	47.59	29.03	5.24	36.4	45.46	54	8.54	AV
V	10480	36.55	39.43	11.47	34.28	53.17	68.2	15.03	PK
V	10480	26.79	39.43	11.47	34.28	43.41	54	10.59	AV
H	10480	36.05	39.43	11.47	34.28	52.67	68.2	15.53	PK
H	10480	26.95	39.43	11.47	34.28	43.57	54	10.43	AV

U-NII 2A

Polar (H/V)	Frequency	Meter Reading	Antenna Factor	Cable loss	Preamp factor	Emission Level	Limits	Margin	Detector Type
	(MHz)	(dBuV)	(dB)	(dB)	(dB)	(dBuV/m)	(dBuV/m)	(dB)	
802.11a Mode -5260MHz									
V	3603	54.98	29.03	5.24	36.4	52.85	68.2	15.35	PK
V	3603	42.22	29.03	5.24	36.4	40.09	54	13.91	AV
H	3603	52.79	29.03	5.24	36.4	50.66	68.2	17.54	PK
H	3603	49.03	29.03	5.24	36.4	46.9	54	7.1	AV
V	10520	34.32	39.43	11.47	34.28	50.94	68.2	17.26	PK
V	10520	23.99	39.43	11.47	34.28	40.61	54	13.39	AV
H	10520	33.97	39.43	11.47	34.28	50.59	68.2	17.61	PK
H	10520	28.53	39.43	11.47	34.28	45.15	54	8.85	AV
802.11a Mode -5280MHz									
V	3603	53.84	29.03	5.24	36.4	51.71	68.2	16.49	PK
V	3603	42.58	29.03	5.24	36.4	40.45	54	13.55	AV
H	3603	52.49	29.03	5.24	36.4	50.36	68.2	17.84	PK
H	3603	47.97	29.03	5.24	36.4	45.84	54	8.16	AV
V	10560	37.16	39.43	11.47	34.28	53.78	68.2	14.42	PK
V	10560	27.21	39.43	11.47	34.28	43.83	54	10.17	AV
H	10560	34.67	39.43	11.47	34.28	51.29	68.2	16.91	PK
H	10560	27.1	39.43	11.47	34.28	43.72	54	10.28	AV
802.11b Mode -5320MHz									
V	3603	53.49	29.03	5.24	36.4	51.36	68.2	16.84	PK
V	3603	43.16	29.03	5.24	36.4	41.03	54	12.97	AV
H	3603	55.22	29.03	5.24	36.4	53.09	68.2	15.11	PK
H	3603	48.82	29.03	5.24	36.4	46.69	54	7.31	AV
V	10640	36.16	39.44	11.47	34.28	52.79	68.2	15.41	PK
V	10640	26.96	39.44	11.47	34.28	43.59	54	10.41	AV
H	10640	34.62	39.44	11.47	34.28	51.25	68.2	16.95	PK
H	10640	26.47	39.44	11.47	34.28	43.1	54	10.9	AV

U-NII 2C

Polar (H/V)	Frequency	Meter Reading	Antenna Factor	Cable loss	Preamp factor	Emission Level	Limits	Margin	Detector Type
	(MHz)	(dBuV)	(dB)	(dB)	(dB)	(dBuV/m)	(dBuV/m)	(dB)	
802.11a Mode -5500MHz									
V	4982	51.73	32.52	5.24	36.4	53.09	68.2	15.11	PK
V	4982	40.38	32.52	5.24	36.4	41.74	54	12.26	AV
H	4982	50.5	32.52	5.24	36.4	51.86	68.2	16.34	PK
H	4982	45.54	32.52	5.24	36.4	46.9	54	7.1	AV
V	11000	36.23	39.46	11.47	34.28	52.88	68.2	15.32	PK
V	11000	24.92	39.46	11.47	34.28	41.57	54	12.43	AV
H	11000	34.54	39.46	11.47	34.28	51.19	68.2	17.01	PK
H	11000	26.64	39.46	11.47	34.28	43.29	54	10.71	AV
802.11a Mode -5600MHz									
V	4982	49.2	32.52	5.24	36.4	50.56	68.2	17.64	PK
V	4982	40.31	32.52	5.24	36.4	41.67	54	12.33	AV
H	4982	49.4	32.52	5.24	36.4	50.76	68.2	17.44	PK
H	4982	43.85	32.52	5.24	36.4	45.21	54	8.79	AV
V	11200	35.79	39.46	11.47	34.28	52.44	68.2	15.76	PK
V	11200	26.91	39.46	11.47	34.28	43.56	54	10.44	AV
H	11200	36.04	39.46	11.47	34.28	52.69	68.2	15.51	PK
H	11200	26.49	39.46	11.47	34.28	43.14	54	10.86	AV
802.11b Mode -5700MHz									
V	4982	49.65	32.52	5.24	36.4	51.01	68.2	17.19	PK
V	4982	39.01	32.52	5.24	36.4	40.37	54	13.63	AV
H	4982	49.67	32.52	5.24	36.4	51.03	68.2	17.17	PK
H	4982	42.85	32.52	5.24	36.4	44.21	54	9.79	AV
V	11400	34.87	39.46	11.47	34.28	51.52	68.2	16.68	PK
V	11400	26.41	39.46	11.47	34.28	43.06	54	10.94	AV
H	11400	37.01	39.46	11.47	34.28	53.66	68.2	14.54	PK
H	11400	28.71	39.46	11.47	34.28	45.36	54	8.64	AV

U-NII 3

Polar (H/V)	Frequency	Meter Reading	Antenna Factor	Cable loss	Preamp factor	Emission Level	Limits	Margin	Detector Type
	(MHz)	(dBuV)	(dB)	(dB)	(dB)	(dBuV/m)	(dBuV/m)	(dB)	
802.11a Mode -5500MHz									
V	5112	51.16	32.84	5.24	36.4	52.84	68.2	15.36	PK
V	5112	39.37	32.84	5.24	36.4	41.05	54	12.95	AV
H	5112	48.76	32.84	5.24	36.4	50.44	68.2	17.76	PK
H	5112	42.47	32.84	5.24	36.4	44.15	54	9.85	AV
V	11490	35.35	39.52	11.47	34.28	52.06	68.2	16.14	PK
V	11490	23.7	39.52	11.47	34.28	40.41	54	13.59	AV
H	11490	36.1	39.52	11.47	34.28	52.81	68.2	15.39	PK
H	11490	29.1	39.52	11.47	34.28	45.81	54	8.19	AV
802.11a Mode -5600MHz									
V	5112	49.74	32.84	5.24	36.4	51.42	68.2	16.78	PK
V	5112	40.21	32.84	5.24	36.4	41.89	54	12.11	AV
H	5112	50.52	32.84	5.24	36.4	52.2	68.2	16	PK
H	5112	44.96	32.84	5.24	36.4	46.64	54	7.36	AV
V	11570	34.64	39.52	11.47	34.28	51.35	68.2	16.85	PK
V	11570	26.93	39.52	11.47	34.28	43.64	54	10.36	AV
H	11570	34.75	39.52	11.47	34.28	51.46	68.2	16.74	PK
H	11570	28.29	39.52	11.47	34.28	45	54	9	AV
802.11b Mode -5700MHz									
V	5112	50.33	32.84	5.24	36.4	52.01	68.2	16.19	PK
V	5112	38.74	32.84	5.24	36.4	40.42	54	13.58	AV
H	5112	50.53	32.84	5.24	36.4	52.21	68.2	15.99	PK
H	5112	43.3	32.84	5.24	36.4	44.98	54	9.02	AV
V	11650	36.51	39.52	11.47	34.28	53.22	68.2	14.98	PK
V	11650	26.95	39.52	11.47	34.28	43.66	54	10.34	AV
H	11650	36.48	39.52	11.47	34.28	53.19	68.2	15.01	PK
H	11650	27.92	39.52	11.47	34.28	44.63	54	9.37	AV

REMARKS:

1. Emission level (dBuV/m) =Raw Value (dBuV)+Correction Factor (dB/m)
2. Correction Factor (dB/m) = Antenna Factor (dB/m)+Cable Factor (dB)-Pre-amplifier Factor
3. Margin value = Limit value- Emission level.
4. -- Mean the other emission levels were very low against the limit.
5. RBW1MHz VBW3MHz Peak detector is for PK value; RBW 1MHz VBW10Hz Peak detector is for AV value.

Radiated Band Edge Test:

All 802.11a / 802.11n (HT20) / 802.11n (HT40)/802.11ac(HT20)/802.11ac(HT40)/802.11ac(HT80) modes have been tested for above 1GHz test, only the worst case 802.11a was recorded.

U-NII 1

Polar (H/V)	Frequency	Meter Reading	Antenna Factor	Cable loss	Preamp factor	Emission Level	Limits	Margin	Detector Type
	(MHz)	(dBuV)	(dB)	(dB)	(dB)	(dBuV/m)	(dBuV/m)	(dB)	
802.11a									
V	5150	54.53	31.22	7.62	36.5	56.87	74	17.13	PK
V	5150	37.89	31.22	7.62	36.5	40.23	54	13.77	AV
H	5150	56.11	31.22	7.62	36.5	58.45	74	15.55	PK
H	5150	44.43	31.22	7.62	36.5	46.77	54	7.23	AV
V	5350	53.49	31.56	7.83	35.82	57.06	74	16.94	PK
V	5350	39.45	31.56	7.83	35.82	43.02	54	10.98	AV
H	5350	53.46	31.56	7.83	35.82	57.03	74	16.97	PK
H	5350	40.56	31.56	7.83	35.82	44.13	54	9.87	AV

U-NII 2A

Polar (H/V)	Frequency	Meter Reading	Antenna Factor	Cable loss	Preamp factor	Emission Level	Limits	Margin	Detector Type
	(MHz)	(dBuV)	(dB)	(dB)	(dB)	(dBuV/m)	(dBuV/m)	(dB)	
802.11a									
V	5150	56.13	31.22	7.62	36.5	58.47	74	15.53	PK
V	5150	39.51	31.22	7.62	36.5	41.85	54	12.15	AV
H	5150	54.88	31.22	7.62	36.5	57.22	74	16.78	PK
H	5150	41.86	31.22	7.62	36.5	44.2	54	9.8	AV
V	5350	55.55	31.56	7.83	35.82	59.12	74	14.88	PK
V	5350	39.21	31.56	7.83	35.82	42.78	54	11.22	AV
H	5350	55.5	31.56	7.83	35.82	59.07	74	14.93	PK
H	5350	39.58	31.56	7.83	35.82	43.15	54	10.85	AV

U-NII 2C

Polar (H/V)	Frequency	Meter Reading	Antenna Factor	Cable loss	Preamp factor	Emission Level	Limits	Margin	Detector Type
	(MHz)	(dBuV)	(dB)	(dB)	(dB)	(dBuV/m)	(dBuV/m)	(dB)	
802.11a									
V	5460	53.12	31.62	7.89	35.76	56.87	74	17.13	PK
V	5460	36.59	31.62	7.89	35.76	40.34	54	13.66	AV
H	5460	52.41	31.62	7.89	35.76	56.16	74	17.84	PK
H	5460	42.52	31.62	7.89	35.76	46.27	54	7.73	AV
V	5850	55.52	31.71	7.92	35.55	59.6	74	14.4	PK
V	5850	39.04	31.71	7.92	35.55	43.12	54	10.88	AV
H	5850	54.13	31.71	7.92	35.55	58.21	74	15.79	PK
H	5850	41.67	31.71	7.92	35.55	45.75	54	8.25	AV

U-NII 3

Polar (H/V)	Frequency	Meter Reading	Antenna Factor	Cable loss	Preamp factor	Emission Level	Limits	Margin	Detector Type
	(MHz)	(dBuV)	(dB)	(dB)	(dB)	(dBuV/m)	(dBuV/m)	(dB)	
802.11a									
V	5460	53.37	31.62	7.89	35.76	57.12	74	16.88	PK
V	5460	37.81	31.62	7.89	35.76	41.56	54	12.44	AV
H	5460	53.28	31.62	7.89	35.76	57.03	74	16.97	PK
H	5460	41.6	31.62	7.89	35.76	45.35	54	8.65	AV
V	5850	52.92	31.71	7.92	35.55	57	74	17	PK
V	5850	38.68	31.71	7.92	35.55	42.76	54	11.24	AV
H	5850	53.33	31.71	7.92	35.55	57.41	74	16.59	PK
H	5850	40.17	31.71	7.92	35.55	44.25	54	9.75	AV

5.3 Conduction spurious emission

Limit

The maximum emissions outside of the frequency bands of operation shall be attenuated in accordance with the following limits:

- (1) For transmitters operating in the 5.15-5.25 GHz band: All emissions outside of the 5.15-5.35 GHz band shall not exceed an e.i.r.p. of -27 dBm/MHz.
- (2) For transmitters operating in the 5.25-5.35 GHz band: All emissions outside of the 5.15-5.35 GHz band shall not exceed an e.i.r.p. of -27 dBm/MHz.
- (3) For transmitters operating in the 5.47-5.725 GHz band: All emissions outside of the 5.47-5.725 GHz band shall not exceed an e.i.r.p. of -27 dBm/MHz.
- (4) For transmitters operating in the 5.725-5.85 GHz band: All emissions shall be limited to a level of -27 dBm/MHz at 75 MHz or more above or below the band edge increasing linearly to 10 dBm/MHz at 25 MHz above or below the band edge, and from 25 MHz above or below the band edge increasing linearly to a level of 15.6 dBm/MHz at 5 MHz above or below the band edge, and from 5 MHz above or below the band edge increasing linearly to a level of 27 dBm/MHz at the band edge.

Test Procedure

Use the following spectrum analyzer settings:

Span = wide enough to capture the peak level of the in-band emission and all spurious emissions (e.g., harmonics) from the lowest frequency generated in the EUT up through the 10th harmonic. Typically, several plots are required to cover this entire span.

RBW = 1 MHz for $f \geq 1$ GHz, 100 kHz for $f < 1$ GHz

VBW \geq RBW

Sweep = auto

Detector function = peak

Trace = max hold

Allow the trace to stabilize

Test Configuration

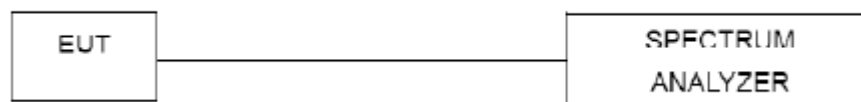

TEST RESULTS

See Appendix VI

5.4 Maximum Conducted Average Output Power

Limit

For the band 5.15-5.25 GHz.

(i) For an outdoor access point operating in the band 5.15-5.25 GHz, the maximum conducted output power over the frequency band of operation shall not exceed 1 W provided the maximum antenna gain does not exceed 6 dBi.

(ii) For an indoor access point operating in the band 5.15-5.25 GHz, the maximum conducted output power over the frequency band of operation shall not exceed 1 W provided the maximum antenna gain does not exceed 6 dBi.

(iii) For fixed point-to-point access points operating in the band 5.15-5.25 GHz, the maximum conducted output power over the frequency band of operation shall not exceed 1 W.

(iv) For client devices in the 5.15-5.25 GHz band, the maximum conducted output power over the frequency band of operation shall not exceed 250 mW provided the maximum antenna gain does not exceed 6 dBi.

For the 5.25-5.35 GHz and 5.47-5.725 GHz bands, the maximum conducted output power over the frequency bands of operation shall not exceed the lesser of 250 mW or $11 \text{ dBm} + 10 \log B$, where B is the 26 dB emission bandwidth in megahertz.

For the band 5.725-5.85 GHz, the maximum conducted output power over the frequency band of operation shall not exceed 1 W

Test Procedure

Remove the antenna from the EUT and then connect a low loss RF cable from the antenna port to the power sensor.

Test Configuration

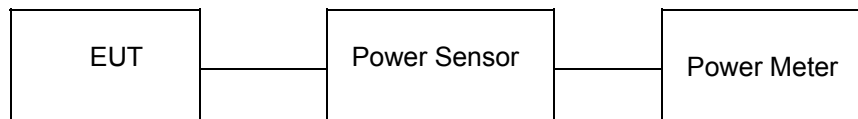

Test Results

See Appendix II

5.5 Power Spectral Density

Limit

(1) For the band 5.15 - 5.25 GHz.

(i) For an outdoor access point operating in the band 5.15 - 5.25 GHz, the maximum power spectral density shall not exceed 17 dBm in any 1 MHz band.^{note1}

(ii) For an indoor access point operating in the band 5.15 - 5.25 GHz, the maximum power spectral density shall not exceed 17 dBm in any 1 MHz band.^{note1}

(iii) For fixed point-to-point access points operating in the band 5.15 - 5.25 GHz, transmitters that employ a directional antenna gain greater than 23 dBi, a 1 dB reduction in maximum power spectral density is required for each 1 dB of antenna gain in excess of 23 dBi.

(iv) For mobile and portable client devices in the 5.15 - 5.25 GHz band, the maximum power spectral density shall not exceed 11 dBm in any 1 MHz band.^{note1}

(2) For the 5.25 - 5.35 GHz and 5.47 - 5.725 GHz bands, the peak power spectral density shall not exceed 11 dBm in any 1 MHz band.^{note1}

(3) For the band 5.725 - 5.85 GHz, the maximum power spectral density shall not exceed 30 dBm in any 500 kHz band.^{note1, note2}

Note1: If transmitting antennas of directional gain greater than 6 dBi are used, the peak power spectral density shall be reduced by the amount in dB that the directional gain of the antenna exceeds 6 dBi.

Note2: Fixed point - to-point U-NII devices operating in this band may employ transmitting antennas with directional gain greater than 6 dBi without any corresponding reduction in transmitter conducted power. Fixed, point-to-point operations exclude the use of point-to-multipoint systems, omnidirectional applications, and multiple collocated transmitters transmitting the same information.

Test Procedure

1. Use this procedure when the maximum peak conducted output power in the fundamental emission is used to demonstrate compliance.
2. Set the RBW = 1MHz for U-NII 1, U-NII 2A, U-NII C band and 510KHz for U-NII 3 band.
3. Set the VBW $\geq 3 \times$ RBW.
4. Set the span to encompass the entire EBW.
5. Detector = peak.
6. Sweep time = auto couple.
7. Trace mode = max hold.
8. Allow trace to fully stabilize.
9. Use the peak marker function to determine the maximum power level.

Test Configuration

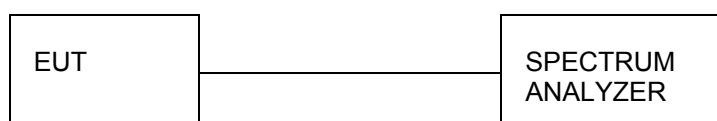

Test Results

See Appendix VIII

5.6 Emission Bandwidth (26dBm Bandwidth)

Limit

N/A

Test Procedure

1. Set resolution bandwidth (RBW) = approximately 1 % of the EBW.
2. Set the video bandwidth (VBW) > RBW.
3. Detector = Peak.
4. Trace mode = Max hold.
5. Measure the maximum width of the emission that is 26 dB down from the peak of the emission. Compare this with the RBW setting of the analyzer. Readjust RBW and repeat measurement as needed until the RBW / EBW ratio is approximately 1 %.

Test Configuration

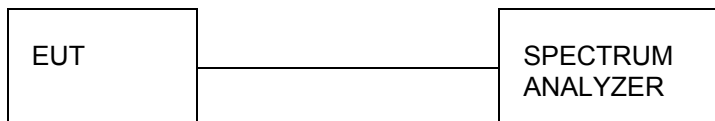

Test Results

See Appendix V

5.7 Minimum Emission Bandwidth (6dBm Bandwidth)

Limit

Within the 5.725-5.85 GHz band, the minimum 6 dB bandwidth of U-NII devices shall be at least 500 kHz.

Test Procedure

1. Set resolution bandwidth (RBW) = 100 kHz
2. Set the video bandwidth 3 x RBW.
3. Detector = Peak.
4. Trace mode = Max hold.
5. Measure the maximum width of the emission that is constrained by the frequencies associated with the two outermost amplitude points (upper and lower frequencies) that are attenuated by 6 dB relative to the maximum level measured in the fundamental emission.

Test Configuration

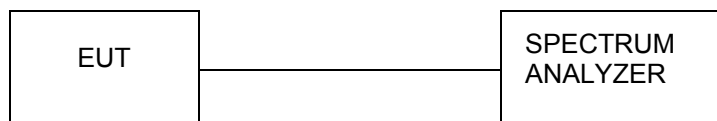

Test Results

See Appendix IV

5.8 Frequency Stability

LIMIT

Manufacturers of U-NII devices are responsible for ensuring frequency stability such that an emission is maintained within the band of operation under all conditions of normal operation as specified in the users manual.

TEST CONFIGURATION

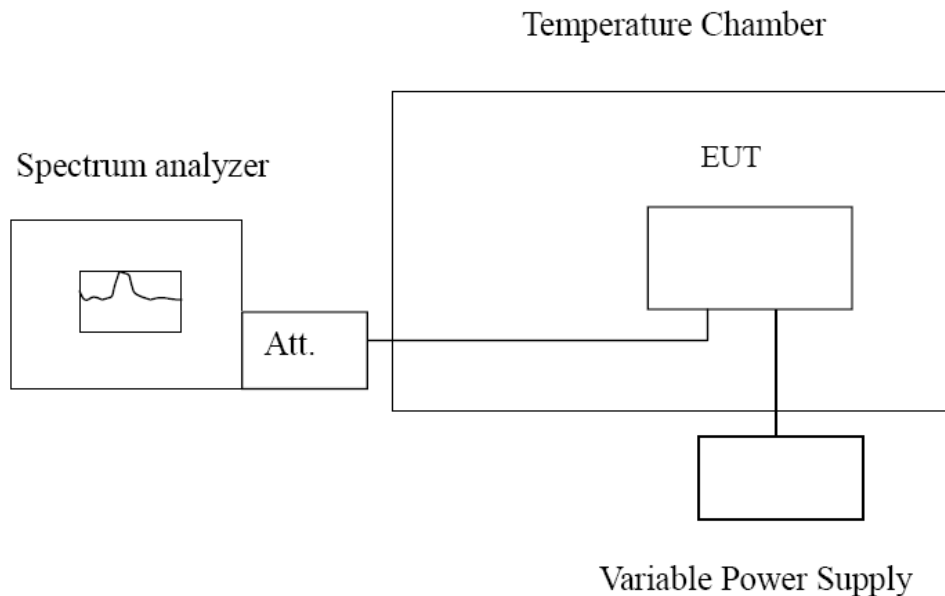

TEST PROCEDURE

Frequency Stability under Temperature Variations:

The equipment under test was connected to an external AC or DC power supply and input rated voltage. RF output was connected to a frequency counter or spectrum analyzer via feed through attenuators. The EUT was placed inside the temperature chamber. Set the spectrum analyzer RBW low enough to obtain the desired frequency resolution and measure EUT 20°C operating frequency as reference frequency. Turn EUT off and set the chamber temperature to -30°C. After the temperature stabilized for approximately 30 minutes recorded the frequency. Repeat step measure with 10°C increased per stage until the highest temperature of +50°C reached.

Frequency Stability under Voltage Variations:

Set chamber temperature to 20°C. Use a variable AC power supply / DC power source to power the EUT and set the voltage to rated voltage. Set the spectrum analyzer RBW low enough to obtain the desired frequency resolution and recorded the frequency.

Reduce the input voltage to specify extreme voltage variation ($\pm 15\%$) and endpoint, record the maximum frequency change.

TEST RESULTS

See Appendix I

5.9 Duty Cycle Information

See Appendix VII

6 Test Setup Photos of the EUT

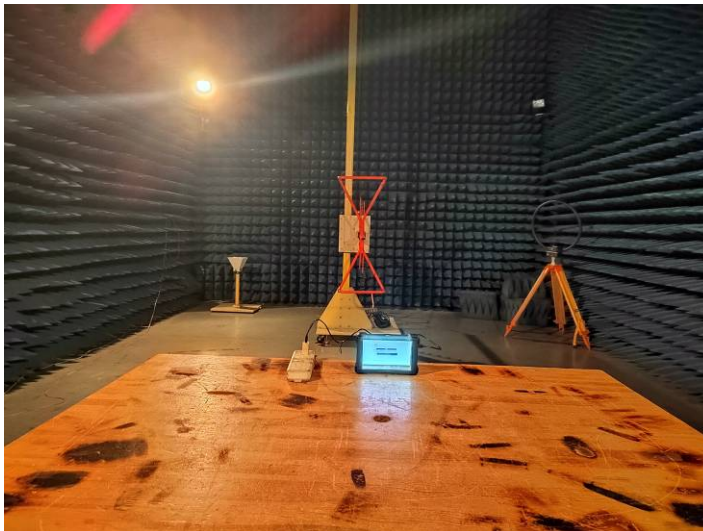

7 Photos of the EUT

see photo report.

APPENDIX I.Frequency Stability

Test Result

Reference Frequency: 802.11a channel=36 frequency=5180MHz					
Voltage (V)	Temperature (°C)	Frequency error		Limit (ppm)	Result
		MHz	ppm		
5.00	-30	0.00137	0.264	Within the band of operation	Pass
	-20	0.00139	0.268		
	-10	0.00145	0.280		
	0	-0.00139	-0.268		
	10	-0.00156	-0.301		
	20	0.00129	0.250		
	30	0.00201	0.388		
	40	-0.00187	-0.361		
50	0.00120	0.231			
5.75	20	0.00149	0.287		
4.25	20	0.00135	0.260		

APPENDIX II. Conducted Peak Output Power

Mode	Channel	Ant. 0 (dBm)	Limit (dBm)	Result
IEEE 802.11a	36	13.286	24	PASS
	40	14.254	24	PASS
	48	14.551	24	PASS
	52	14.621	24	PASS
	56	15.241	24	PASS
	64	15.150	24	PASS
	100	14.54	24	PASS
	120	15.021	24	PASS
IEEE 802.11n_20	140	14.114	24	PASS
	36	14.054	24	PASS
	40	14.251	24	PASS
	48	14.552	24	PASS
	52	14.622	24	PASS
	56	15.207	24	PASS
	64	15.252	24	PASS
	100	14.442	24	PASS
IEEE 802.11n_40	120	14.912	24	PASS
	140	14.595	24	PASS
	38	10.056	24	PASS
	46	14.658	24	PASS
	54	15.190	24	PASS
	62	11.216	24	PASS
	102	10.212	24	PASS
IEEE 802.11ac_20	118	14.479	24	PASS
	134	14.525	24	PASS
	36	14.244	24	PASS
	40	18.355	24	PASS
	48	18.751	24	PASS
	52	18.708	24	PASS
	56	19.210	24	PASS
	64	16.045	24	PASS
IEEE 802.11ac_40	100	15.154	24	PASS
	120	13.681	24	PASS
	140	13.352	24	PASS
	38	10.025	24	PASS
	46	18.701	24	PASS
	54	18.921	24	PASS
	62	10.762	24	PASS
IEEE 802.11ac_80	102	9.964	24	PASS
	118	13.454	24	PASS
	134	10.254	24	PASS
IEEE 802.11ac_80	42	7.915	24	PASS
	58	8.727	24	PASS
	122	10.654	24	PASS

Mode	Channel	Ant. 0 (dBm)	Limit (dBm)	Result
IEEE 802.11a	149	15.54	30	PASS
	157	15.20	30	PASS
	165	15.14	30	PASS
IEEE 802.11n_20	149	15.35	30	PASS
	157	15.52	30	PASS
	165	14.45	30	PASS
IEEE 802.11n_40	151	15.24	30	PASS
	159	10.42	30	PASS
IEEE 802.11ac_20	149	13.20	30	PASS
	157	11.42	30	PASS
	165	10.35	30	PASS
IEEE 802.11ac_40	151	11.12	30	PASS
	159	10.42	30	PASS
IEEE 802.11ac_80	155	8.75	30	PASS

APPENDIX III.99% Bandwidth

Test Result

Mode	Channel	Ant.	99% BW (MHz)
IEEE 802.11a	36	0	16.474
	40		16.441
	48		16.481
	52		16.432
	56		16.395
	64		16.459
	100		16.433
	120		16.467
	140		16.437
IEEE 802.11n_20	36	0	17.574
	40		17.575
	48		17.570
	52		17.589
	56		17.536
	64		17.588
	100		17.549
	120		17.556
	140		17.531
IEEE 802.11n_40	38	0	35.962
	46		35.969
	54		35.826
	62		35.925
	102		35.908
	118		35.872
	134		36.001
IEEE 802.11ac_20	36	0	17.679
	40		17.718
	48		17.716
	52		17.775
	56		17.722
	64		17.718
	100		17.718
	120		17.737
	140		17.711
IEEE 802.11ac_40	38	0	36.313
	46		36.238
	54		36.243
	62		36.305
	102		36.260
	118		36.244
	134		36.303

IEEE 802.11ac_80	42	75.934
	58	75.806
	122	75.710

Test Graphs

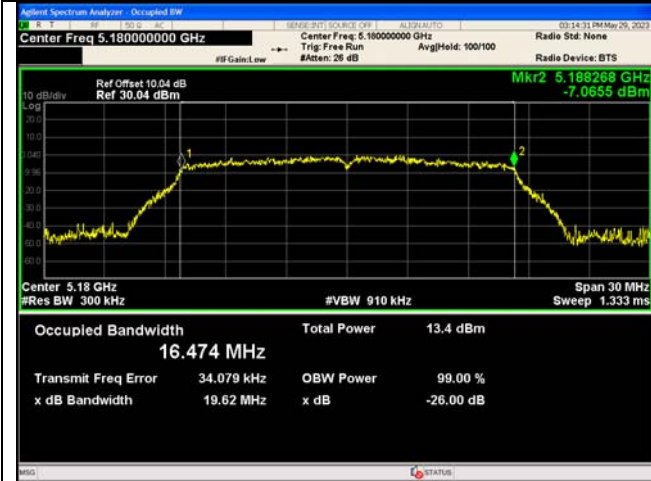

IEEE 802.11a_Channel 36_20MHz_Antenna 0

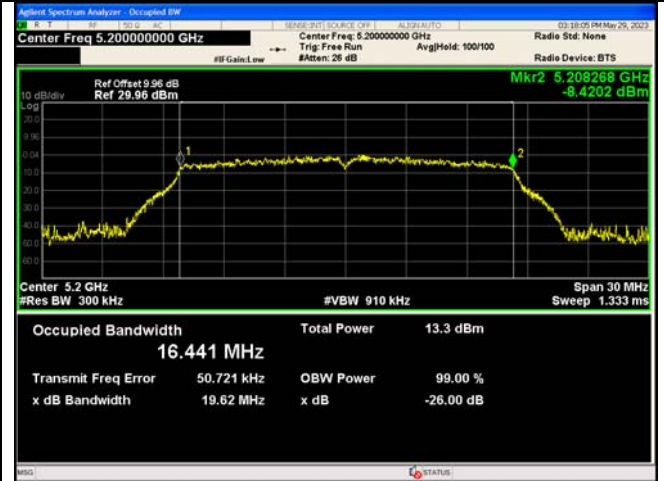

IEEE 802.11a_Channel 40_20MHz_Antenna 0

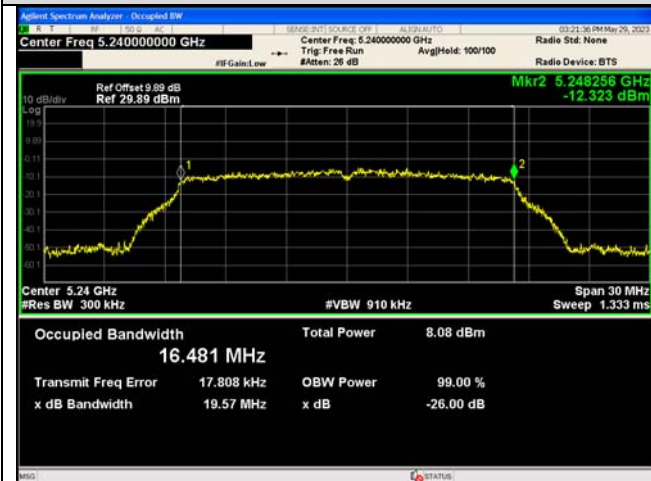

IEEE 802.11a_Channel 48_20MHz_Antenna 0



IEEE 802.11a_Channel 52_20MHz_Antenna 0

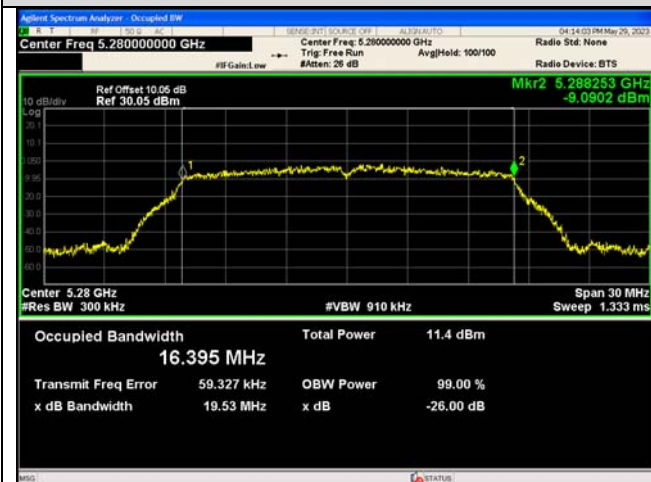

IEEE 802.11a_Channel 56_20MHz_Antenna 0

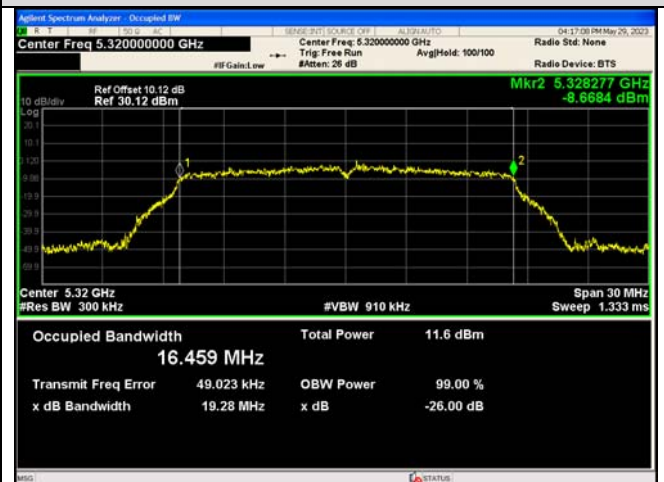

IEEE 802.11a_Channel 64_20MHz_Antenna 0

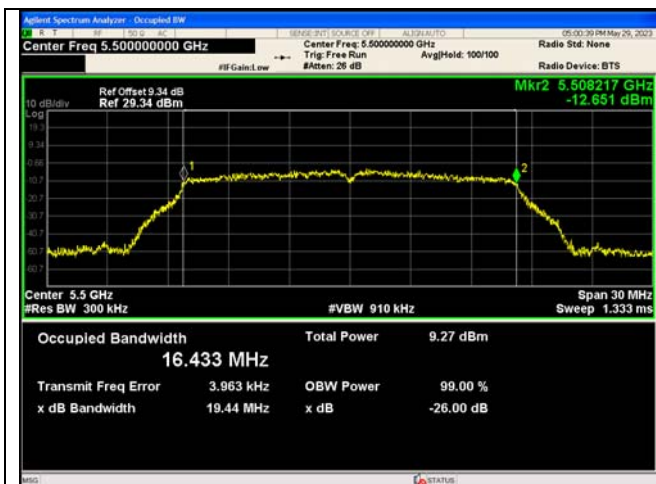

IEEE 802.11a_Channel 100_20MHz_Antenna 0

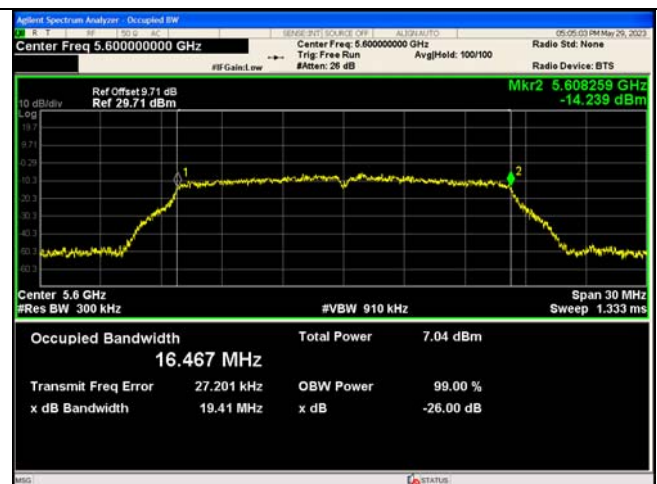

IEEE 802.11a_Channel 120_20MHz_Antenna 0

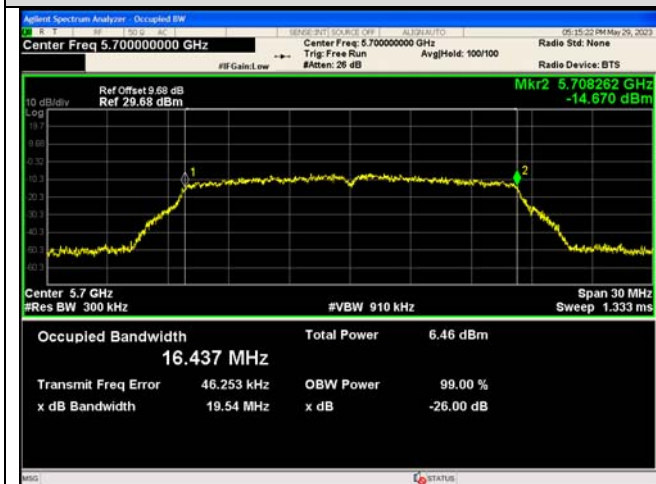

IEEE 802.11a_Channel 140_20MHz_Antenna 0

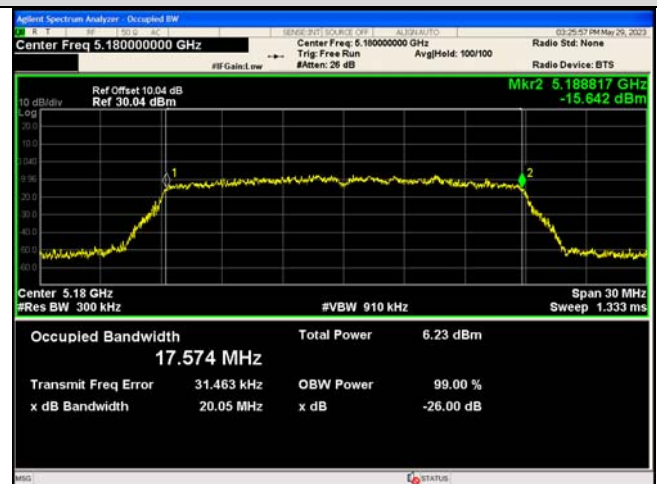

IEEE 802.11n_Channel 36_20MHz_Antenna 0

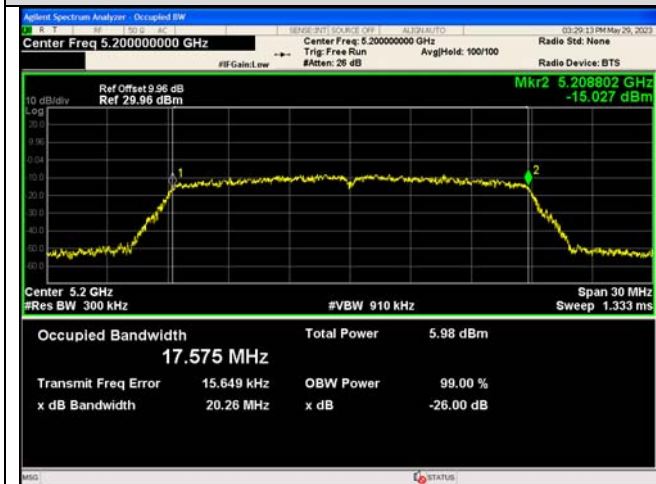

IEEE 802.11n_Channel 40_20MHz_Antenna 0

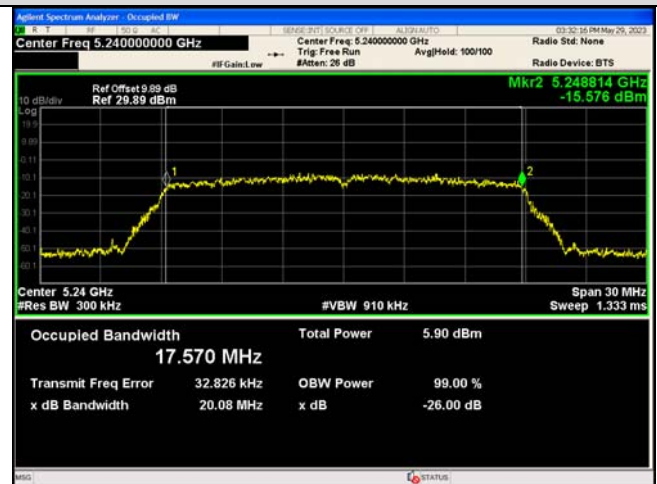

IEEE 802.11n_Channel 48_20MHz_Antenna 0

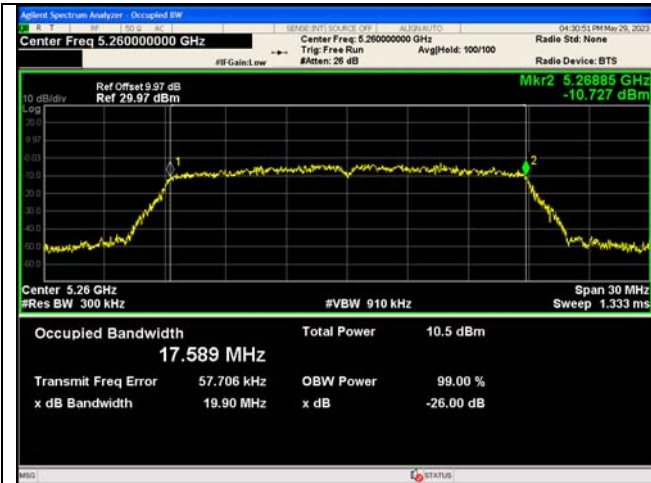

IEEE 802.11n_Channel 52_20MHz_Antenna 0

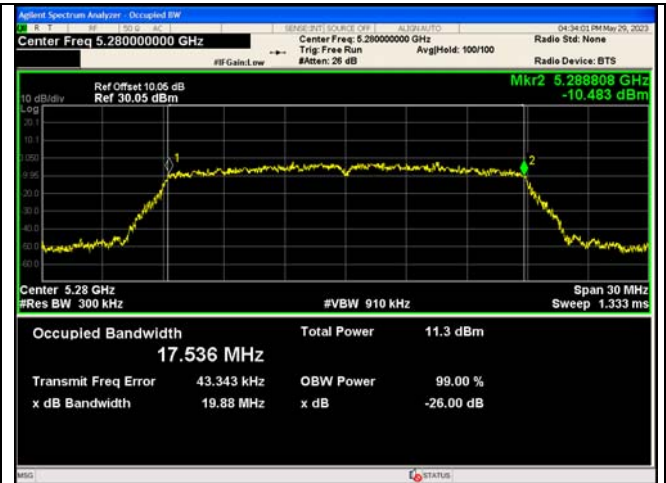

IEEE 802.11n_Channel 56_20MHz_Antenna 0

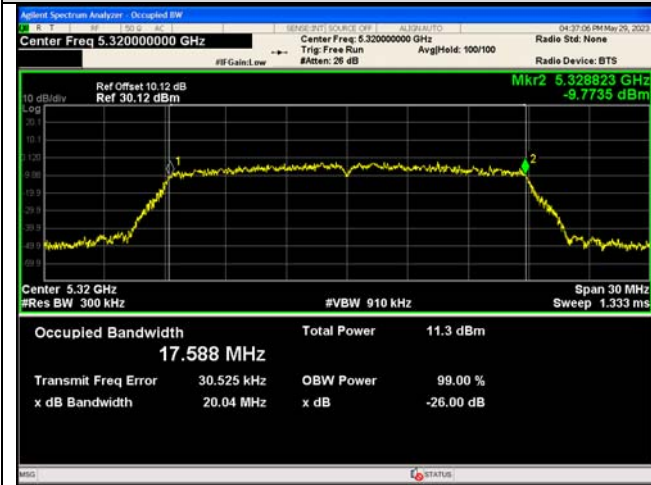

IEEE 802.11n_Channel 64_20MHz_Antenna 0

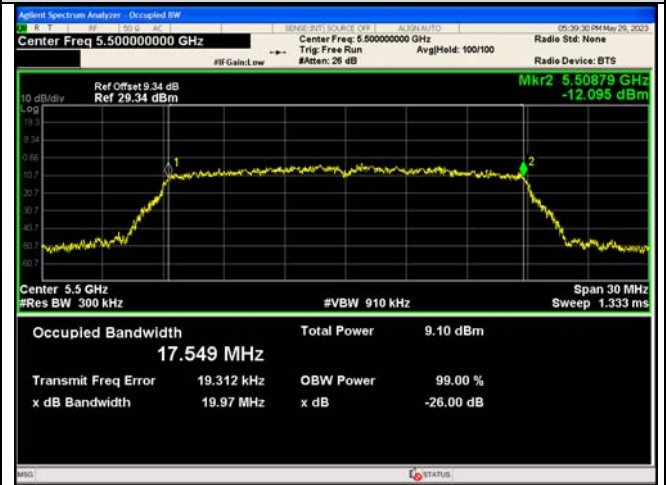

IEEE 802.11n_Channel 100_20MHz_Antenna 0



IEEE 802.11n_Channel 120_20MHz_Antenna 0

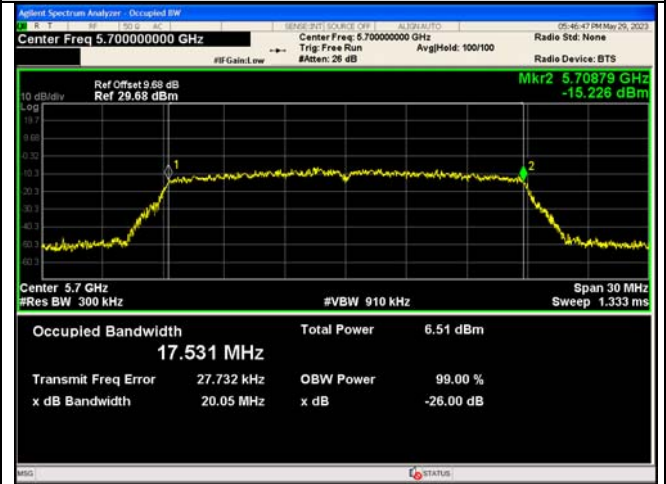

IEEE 802.11n_Channel 140_20MHz_Antenna 0

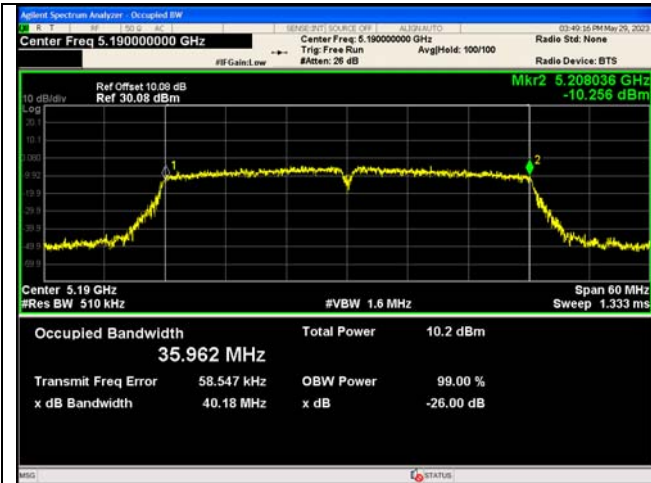

IEEE 802.11n_Channel 38_40MHz_Antenna 0



IEEE 802.11n_Channel 46_40MHz_Antenna 0

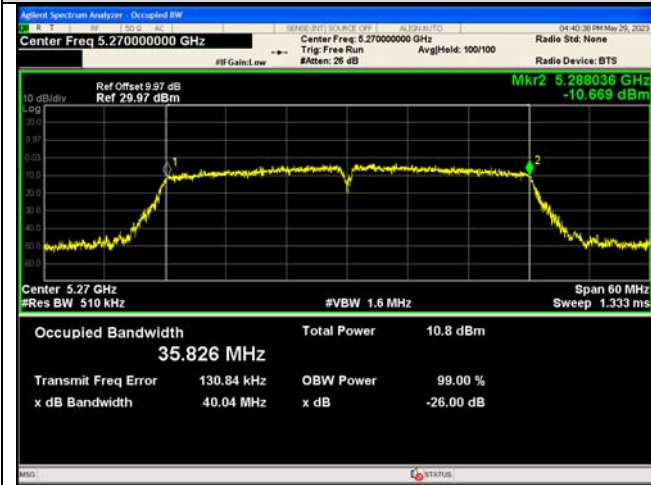

IEEE 802.11n_Channel 54_40MHz_Antenna 0

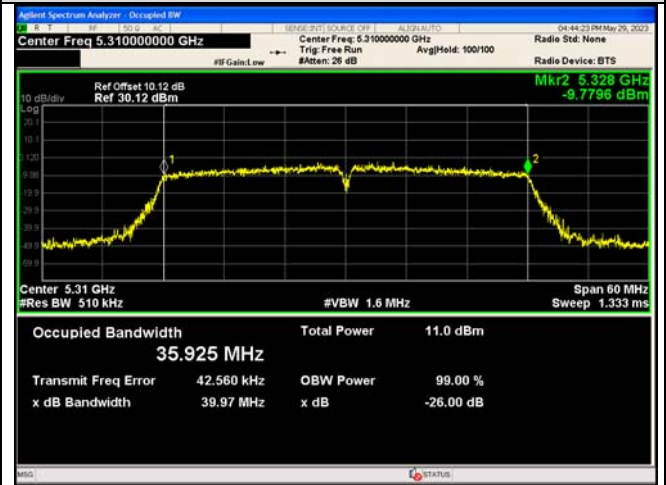

IEEE 802.11n_Channel 62_40MHz_Antenna 0



IEEE 802.11n_Channel 102_40MHz_Antenna 0

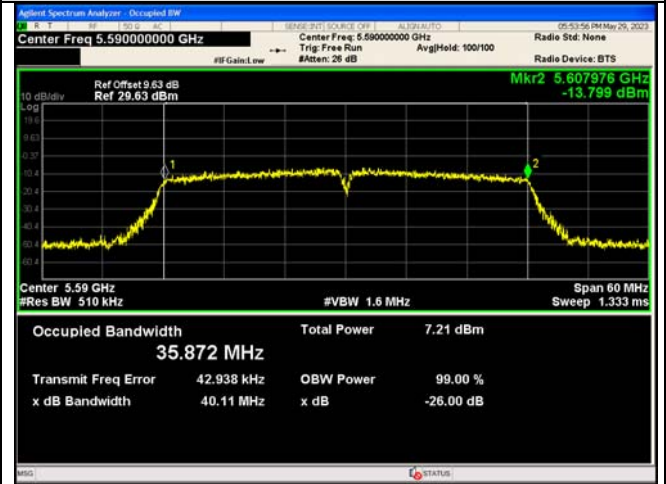

IEEE 802.11n_Channel 118_40MHz_Antenna 0

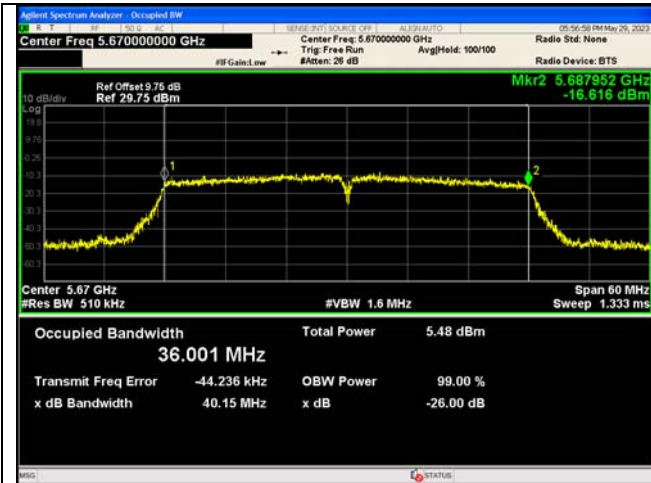

IEEE 802.11n_Channel 134_40MHz_Antenna 0

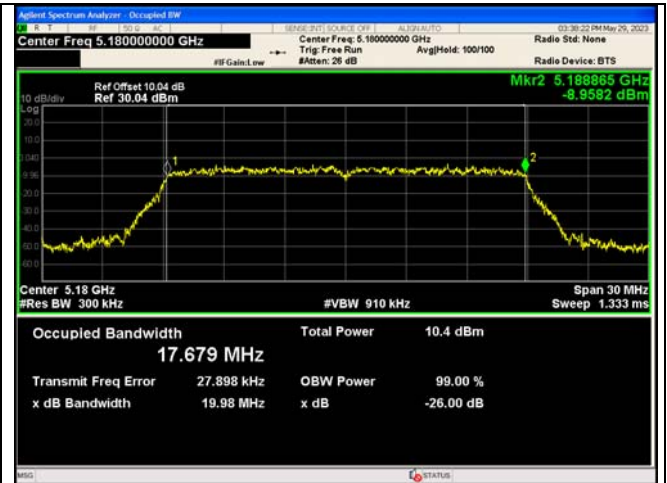

IEEE 802.11ac_Channel 36_20MHz_Antenna 0

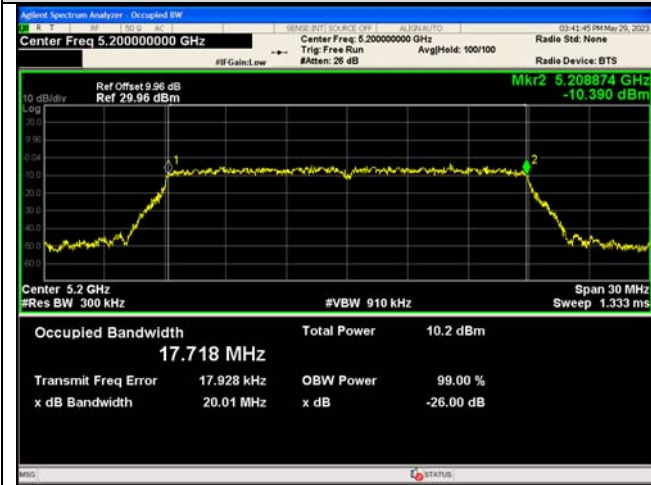

IEEE 802.11ac_Channel 40_20MHz_Antenna 0

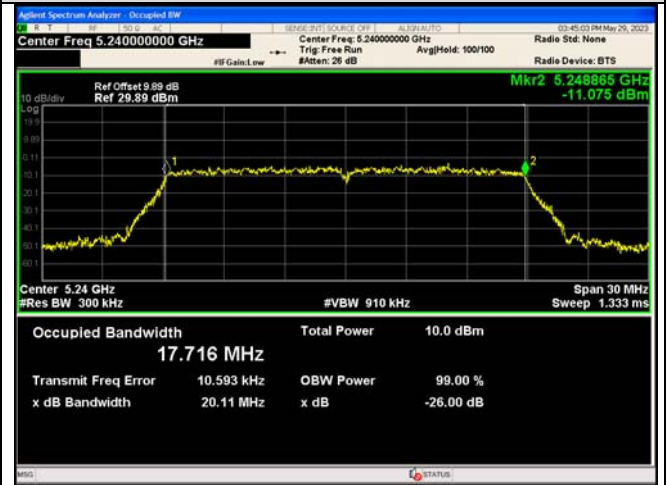

IEEE 802.11ac_Channel 48_20MHz_Antenna 0

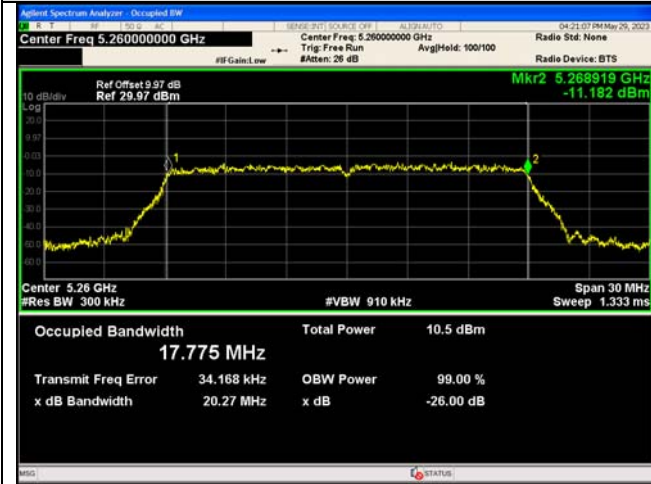

IEEE 802.11ac_Channel 52_20MHz_Antenna 0

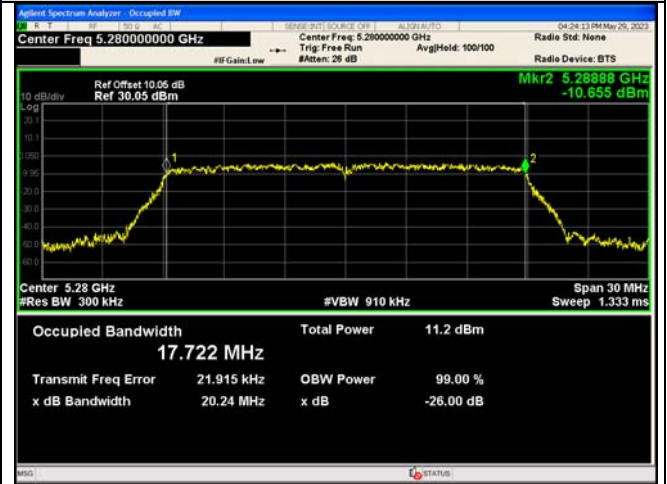

IEEE 802.11ac_Channel 56_20MHz_Antenna 0

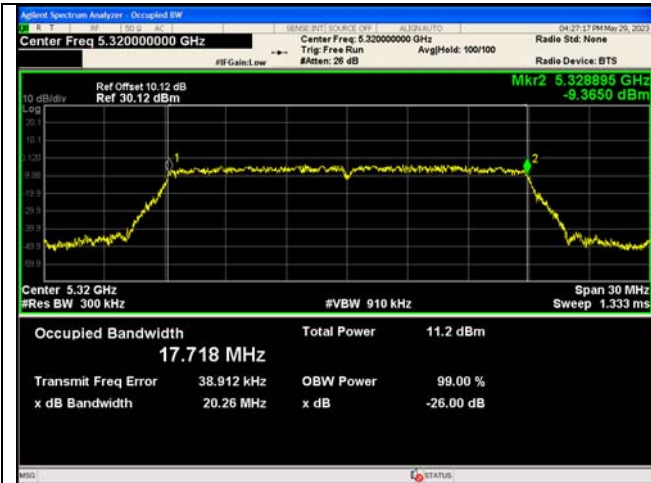

IEEE 802.11ac_Channel 64_20MHz_Antenna 0

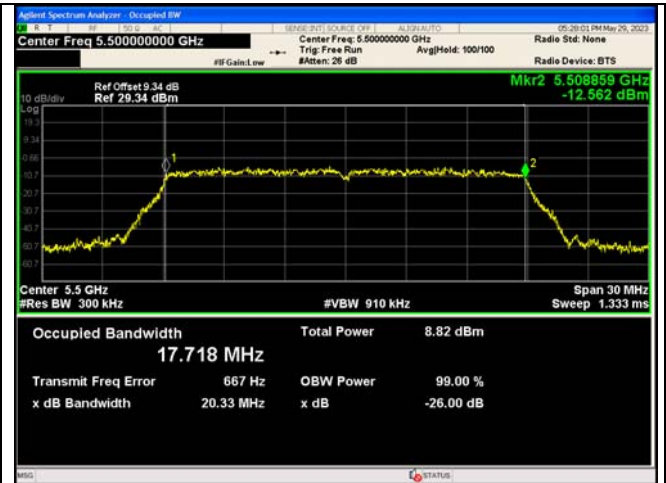

IEEE 802.11ac_Channel 100_20MHz_Antenna 0

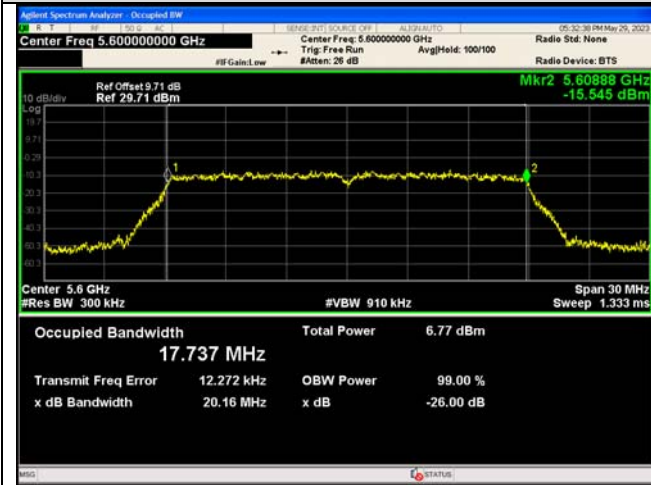

IEEE 802.11ac_Channel 120_20MHz_Antenna 0

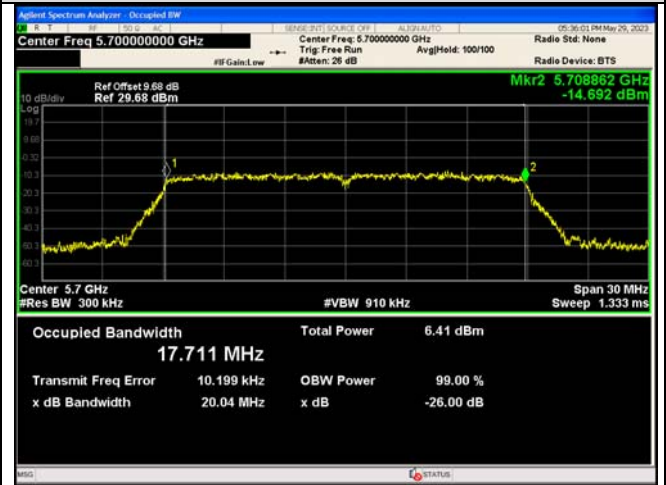

IEEE 802.11ac_Channel 140_20MHz_Antenna 0

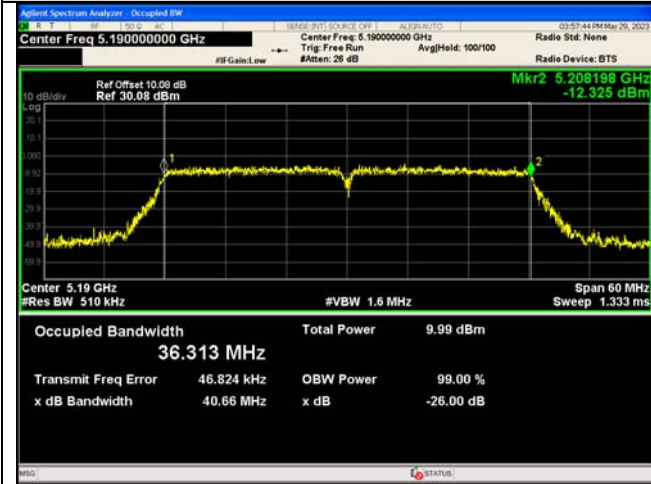

IEEE 802.11ac_Channel 38_40MHz_Antenna 0

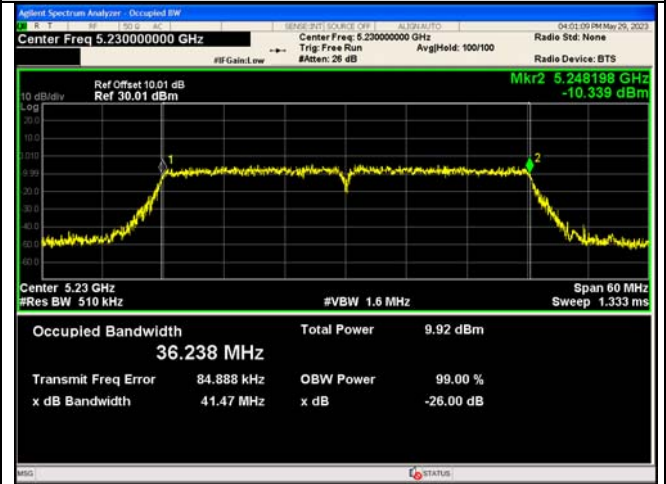

IEEE 802.11ac_Channel 46_40MHz_Antenna 0

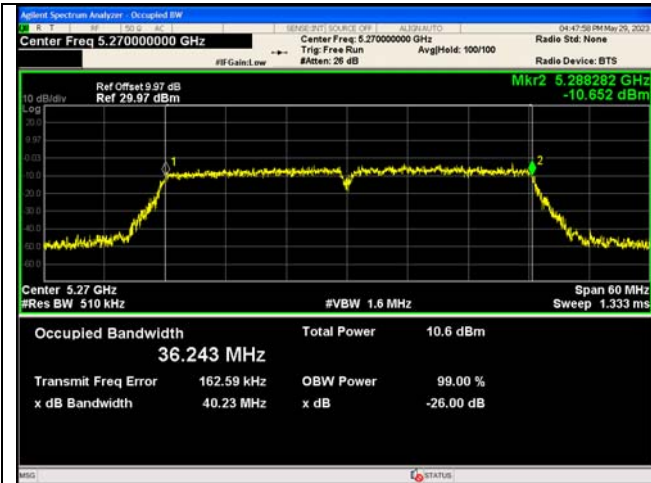

IEEE 802.11ac_Channel 54_40MHz_Antenna 0

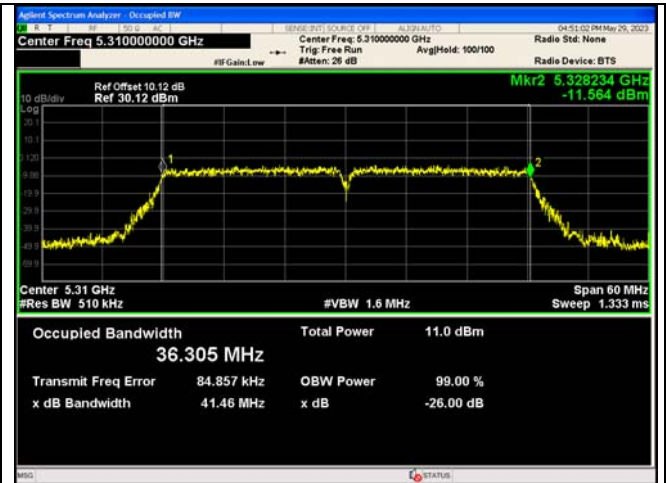

IEEE 802.11ac_Channel 62_40MHz_Antenna 0

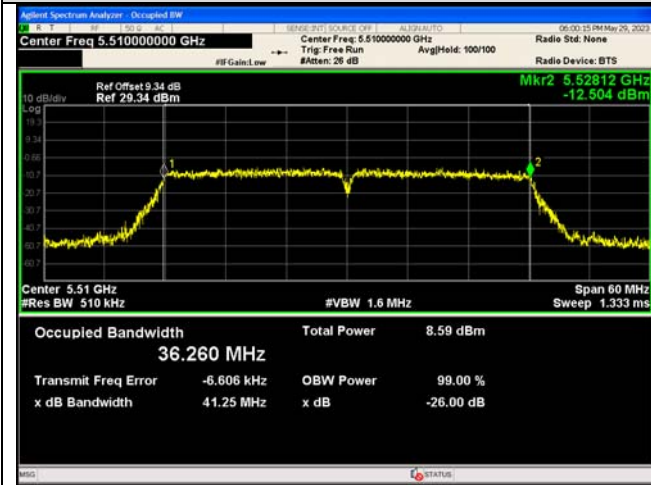

IEEE 802.11ac_Channel 102_40MHz_Antenna 0

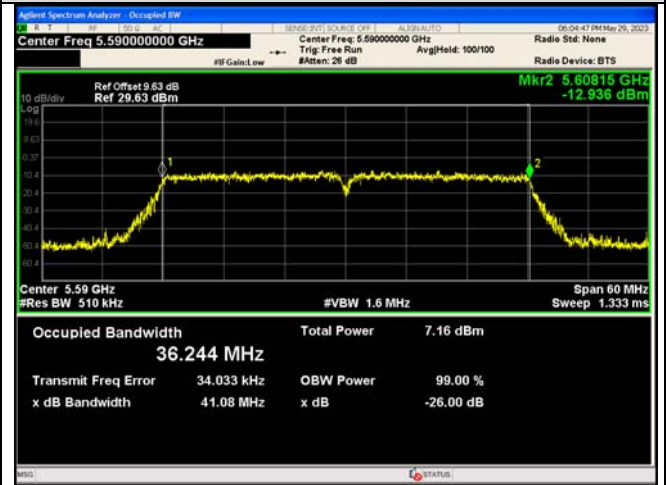

IEEE 802.11ac_Channel 118_40MHz_Antenna 0

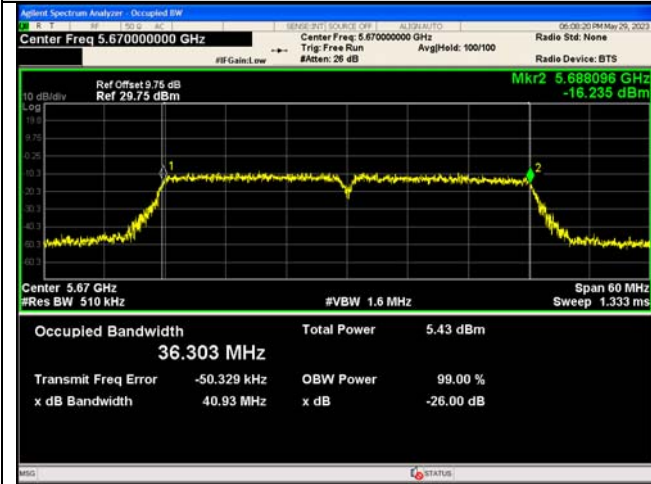

IEEE 802.11ac_Channel 134_40MHz_Antenna 0

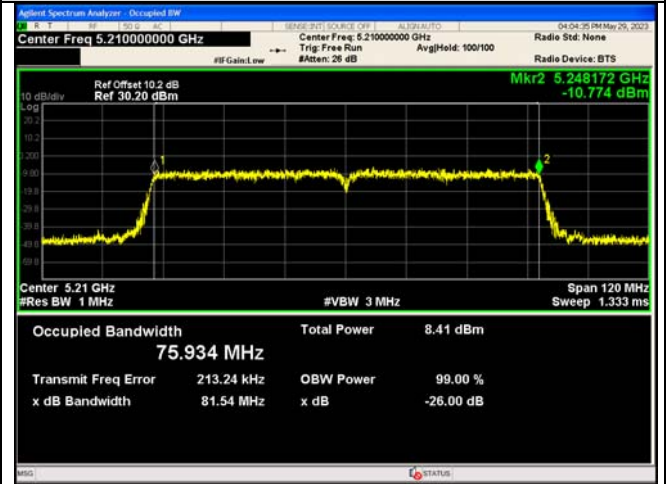

IEEE 802.11ac_Channel 42_80MHz_Antenna 0

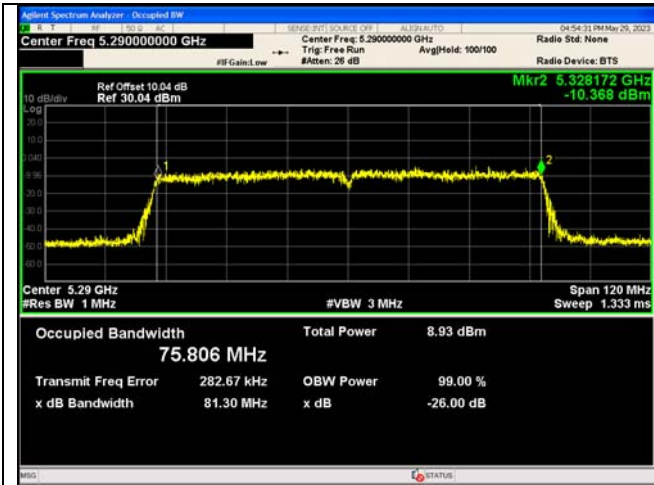

IEEE 802.11ac_Channel 58_80MHz_Antenna 0

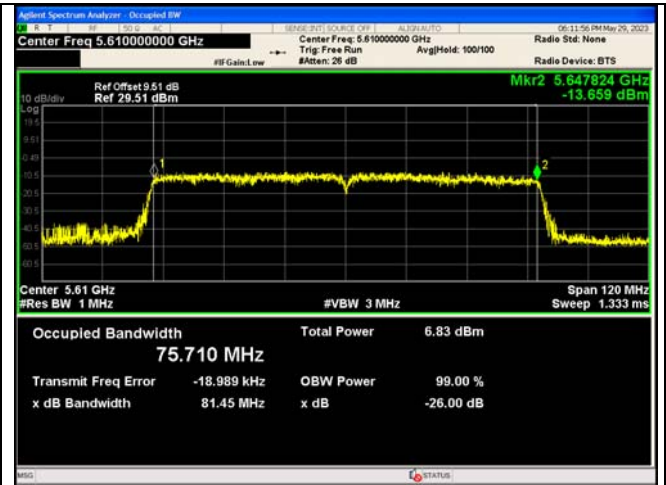

IEEE 802.11ac_Channel 122_80MHz_Antenna 0

Test Result

Mode	Channel	Ant.	99% BW (MHz)
IEEE 802.11a	149	0	16.445
	157		16.372
	165		16.501
IEEE 802.11n_20	149		17.568
	157		17.539
	165		17.569
IEEE 802.11n_40	151		35.916
	159		35.838
IEEE 802.11ac_20	149		17.696
	157		17.715
	165		17.715
IEEE 802.11ac_40	151		36.226
	159	36.145	
IEEE 802.11ac_80	155	75.774	

Test Graphs

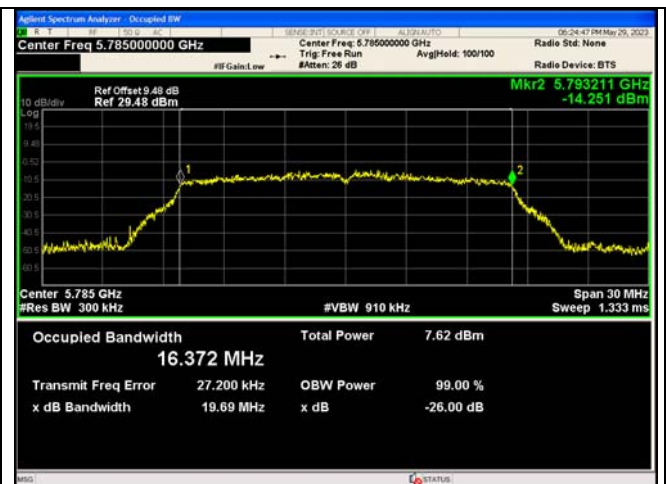
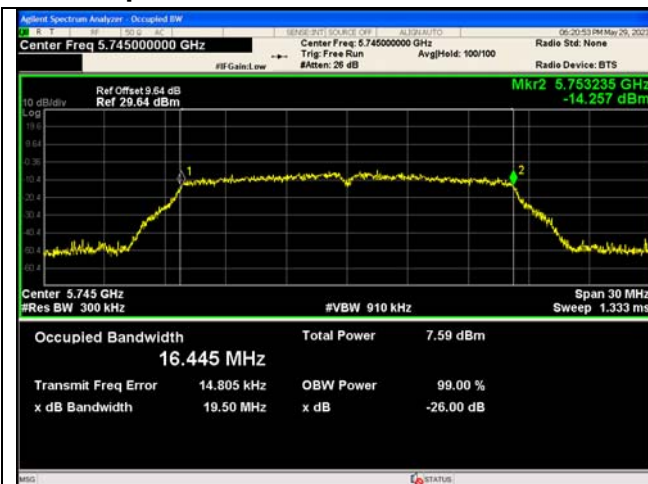

IEEE 802.11a_Channel 149_20MHz_Antenna 0

IEEE 802.11a_Channel 157_20MHz_Antenna 0

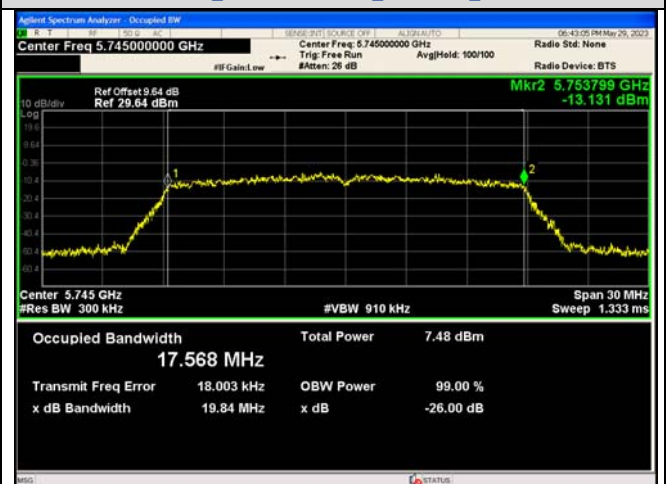
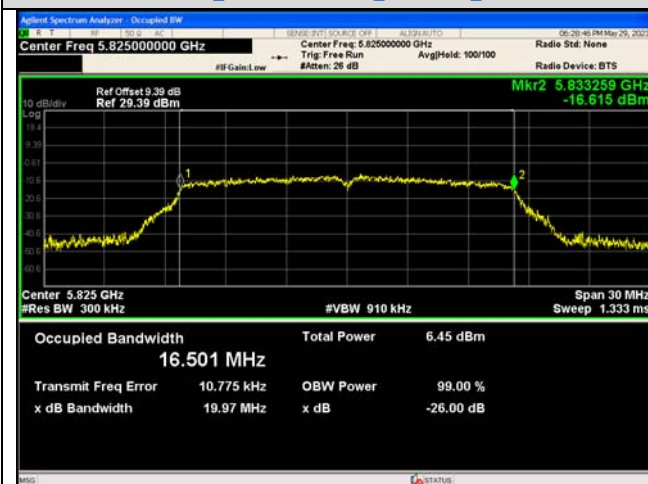

IEEE 802.11a_Channel 165_20MHz_Antenna 0

IEEE 802.11n_Channel 149_20MHz_Antenna 0

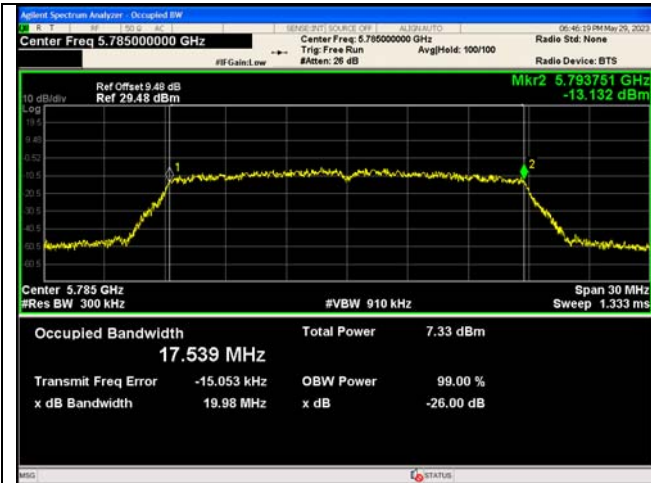

IEEE 802.11n_Channel 157_20MHz_Antenna 0



IEEE 802.11n_Channel 165_20MHz_Antenna 0

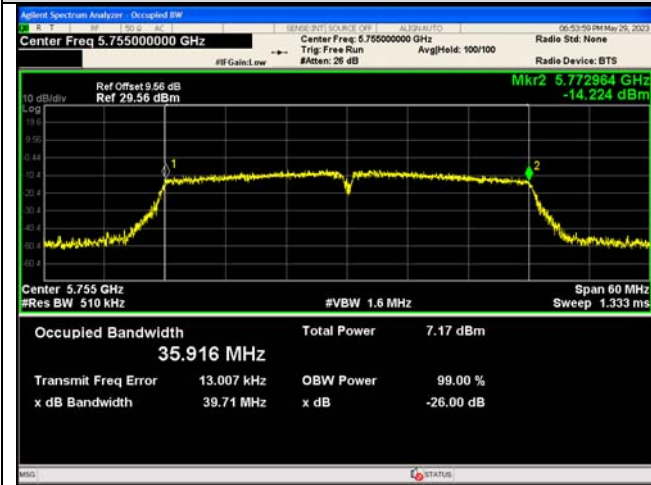

IEEE 802.11n_Channel 151_40MHz_Antenna 0

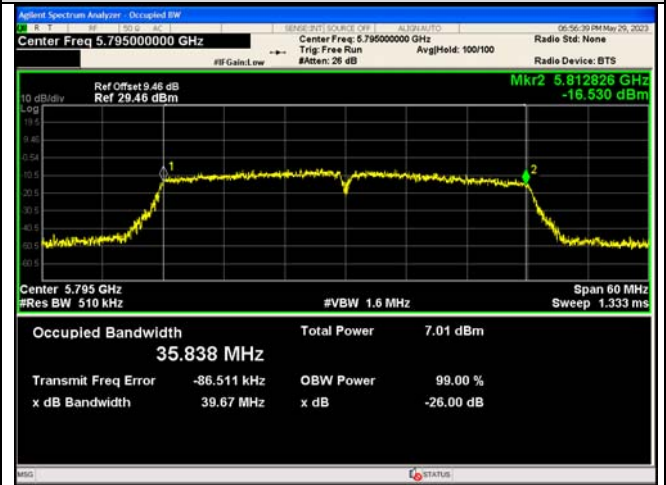

IEEE 802.11n_Channel 159_40MHz_Antenna 0



IEEE 802.11ac_Channel 149_20MHz_Antenna 0

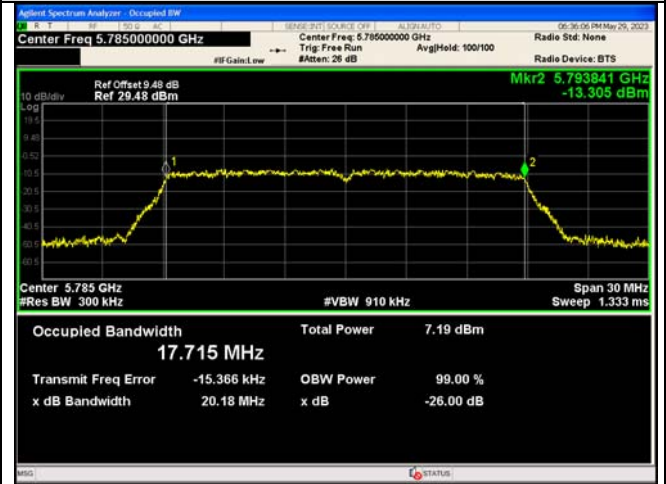

IEEE 802.11ac_Channel 157_20MHz_Antenna 0

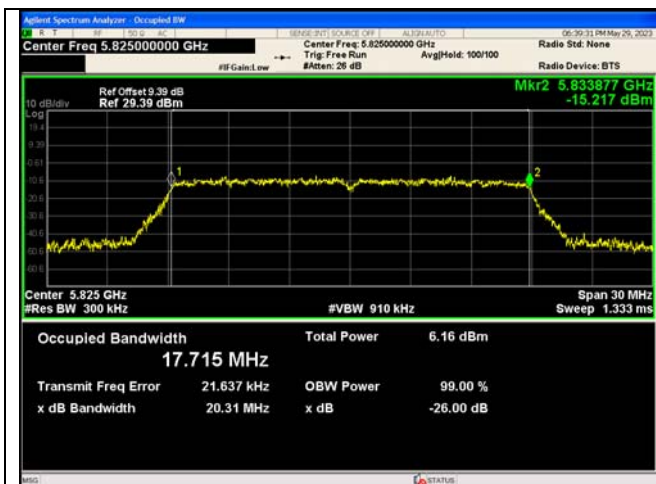

IEEE 802.11ac_Channel 165_20MHz_Antenna 0

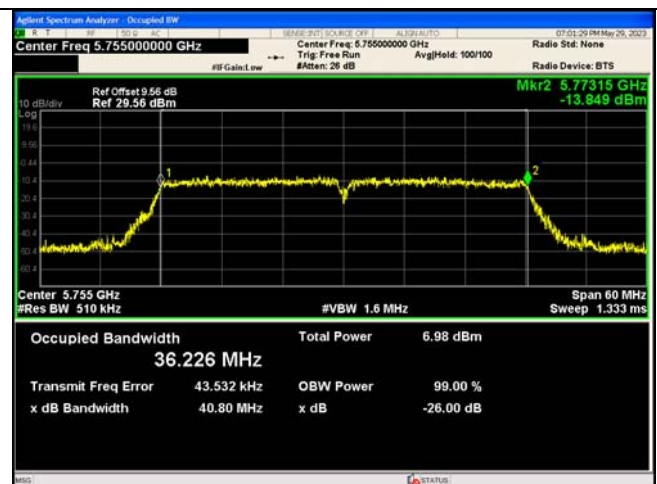

IEEE 802.11ac_Channel 151_40MHz_Antenna 0

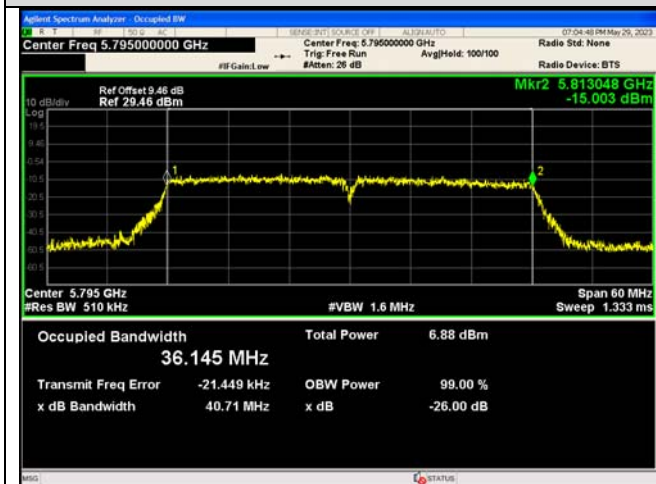

IEEE 802.11ac_Channel 159_40MHz_Antenna 0

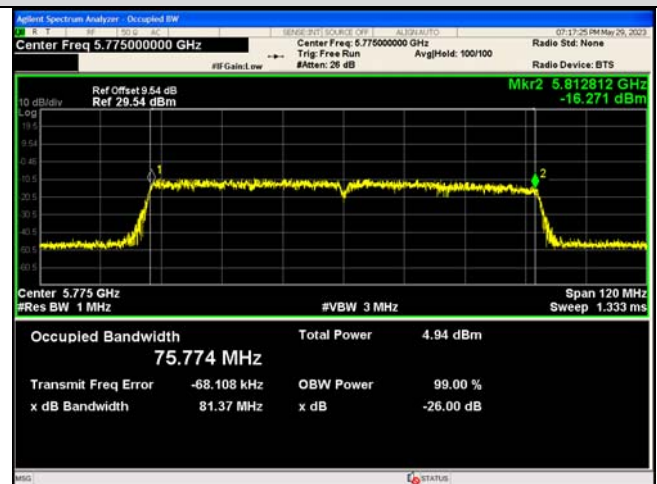

IEEE 802.11ac_Channel 155_80MHz_Antenna 0

APPENDIX IV.6dB Bandwidth

Test Result

Mode	Channel	Ant.	Center Frequency (MHz)	6 dB Bandwidth (MHz)	Limit (MHz)	Result
IEEE 802.11a	36	0	5180	15.43	0.5	PASS
	40		5200	15.09		PASS
	48		5240	15.10		PASS
	52		5260	15.10		PASS
	56		5280	15.11		PASS
	64		5320	15.06		PASS
	100		5500	15.13		PASS
	120		5600	15.09		PASS
140	5700		15.67	PASS		
IEEE 802.11n_20	36		5180	15.11		PASS
	40		5200	15.10		PASS
	48		5240	15.10		PASS
	52		5260	15.11		PASS
	56		5280	15.11		PASS
	64		5320	15.11		PASS
	100		5500	15.09		PASS
	120		5600	15.10		PASS
140	5700		15.08	PASS		
IEEE 802.11n_40	38		5190	35.03		PASS
	46		5230	35.09		PASS
	54		5270	35.07		PASS
	62		5310	35.10		PASS
	102		5510	35.08		PASS
	118		5590	35.06		PASS
	134	5670	35.10	PASS		
IEEE 802.11ac_20	36	5180	17.58	PASS		
	40	5200	17.62	PASS		
	48	5240	17.66	PASS		
	52	5260	17.64	PASS		
	56	5280	17.64	PASS		
	64	5320	17.57	PASS		
	100	5500	17.61	PASS		
	120	5600	17.56	PASS		
	140	5700	17.44	PASS		
IEEE 802.11ac_40	38	5190	35.99	PASS		
	46	5230	36.24	PASS		
	54	5270	35.60	PASS		

	62		5310	36.28		PASS
	102		5510	35.99		PASS
	118		5590	35.61		PASS
	134		5670	35.98		PASS
IEEE 802.11ac_80	42		5210	76.37		PASS
	58		5290	75.75		PASS
	122		5610	75.36		PASS

Test Graphs

IEEE 802.11a_Channel 36_20MHz_Antenna 0

IEEE 802.11a_Channel 40_20MHz_Antenna 0

IEEE 802.11a_Channel 48_20MHz_Antenna 0

IEEE 802.11a_Channel 52_20MHz_Antenna 0

IEEE 802.11a_Channel 48_20MHz_Antenna 0

IEEE 802.11a_Channel 56_20MHz_Antenna 0

IEEE 802.11a_Channel 64_20MHz_Antenna 0

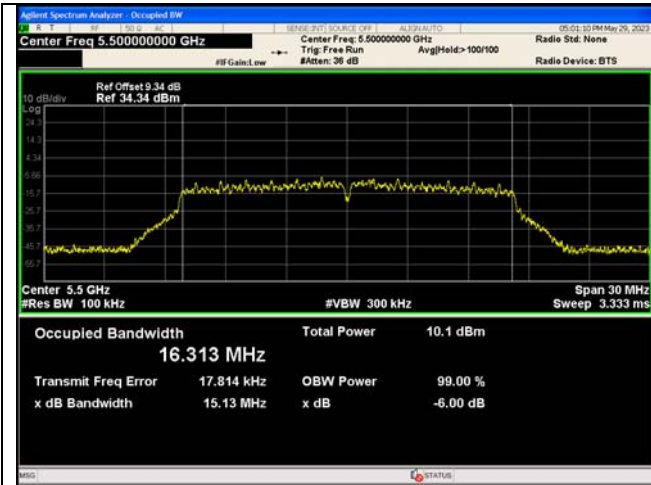

IEEE 802.11a_Channel 100_20MHz_Antenna 0

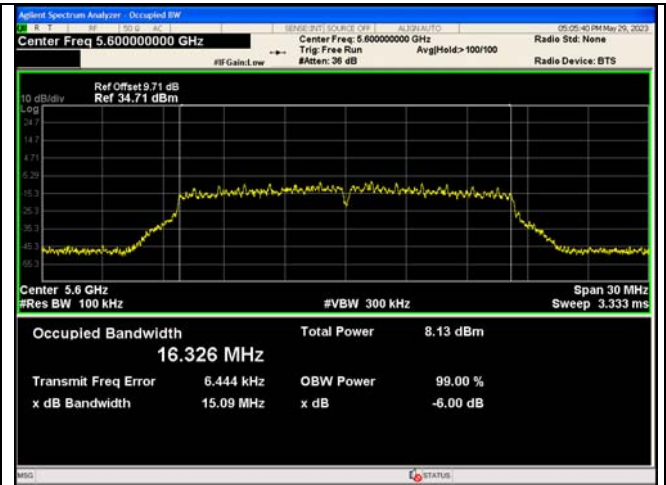

IEEE 802.11a_Channel 120_20MHz_Antenna 0

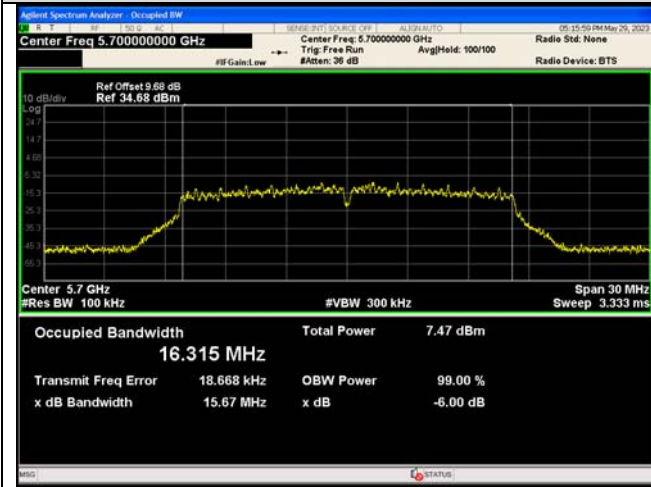

IEEE 802.11a_Channel 140_20MHz_Antenna 0

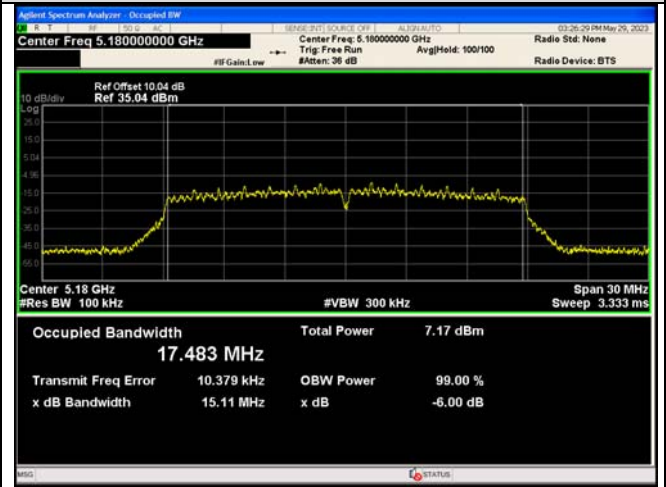

IEEE 802.11n_Channel 36_20MHz_Antenna 0

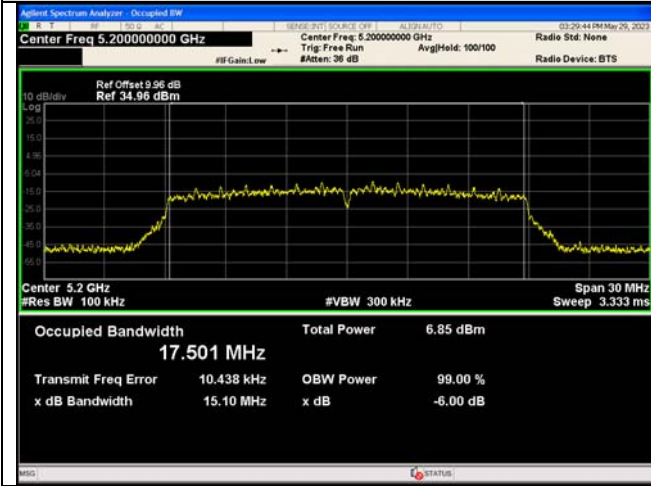

IEEE 802.11n_Channel 40_20MHz_Antenna 0

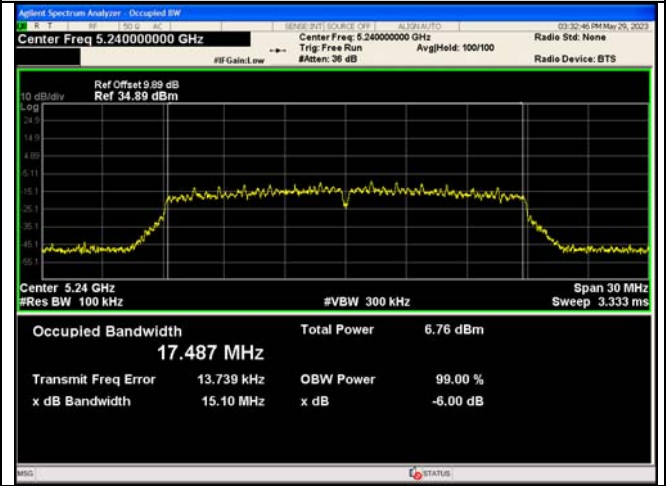

IEEE 802.11n_Channel 48_20MHz_Antenna 0