

# RADIO TEST REPORT

## FCC 47 CFR PART 15 SUBPART C

### INDUSTRY CANADA RSS-247

<b>Test Standard</b>	FCC Part 15.247 and IC RSS-247 issue 2
<b>FCC ID</b>	A4C-1000CA
<b>ISED ID</b>	10199A-1000CA
<b>Product name</b>	TND™ 740
<b>Brand Name</b>	Rand McNally
<b>Test Result</b>	Pass

The test Result was tested by Compliance Certification Services Inc. The test data, data evaluation, test procedures, and equipment configurations shown in this report were given in ANSI C63.10: 2013 and compliance standards.

The test results of this report relate only to the tested sample (EUT) identified in this report.

The test Report of full or partial shall not copy. Without written approval of CCS. Inc.

The sample selected for test was production product and was provided by manufacturer.



Approved by:

Reviewed by:

*Davis Tseng*

*Zeus Chen*

---

Davis Tseng  
Sr. Engineer

---

Zeus Chen  
Supervisor

## Revision History

Rev.	Issue Date	Revisions	Revised By
00	January 20, 2017	Initial Issue	Angel Cheng
01	March 17, 2017	1. Revise section 4.6.2 Duty Cycle in page 27. 2. Add Remark in page 26.	Doris Chu
02	April 11, 2017	1. Update to RSS-247 issue 2 in page 1.	Angel Cheng
03	April 12, 2017	1. Update the test result sections in page 16, 18, 20	Angel Cheng

---

## Table of contents

<b>1. GENERAL INFORMATION .....</b>	<b>4</b>
<b>1.1 EUT INFORMATION .....</b>	<b>4</b>
<b>1.2 EUT CHANNEL INFORMATION .....</b>	<b>5</b>
<b>1.3 ANTENNA INFORMATION .....</b>	<b>5</b>
<b>1.4 MEASUREMENT UNCERTAINTY.....</b>	<b>6</b>
<b>1.5 FACILITIES AND TEST LOCATION .....</b>	<b>7</b>
<b>1.6 INSTRUMENT CALIBRATION .....</b>	<b>7</b>
<b>1.7 SUPPORT AND EUT ACCESSORIES EQUIPMENT .....</b>	<b>8</b>
<b>2. TEST SUMMERY .....</b>	<b>9</b>
<b>3. DESCRIPTION OF TEST MODES .....</b>	<b>10</b>
<b>3.1 THE WORST MODE OF OPERATING CONDITION .....</b>	<b>10</b>
<b>3.2 THE WORST MODE OF MEASUREMENT .....</b>	<b>11</b>
<b>3.3 EUT DUTY CYCLE.....</b>	<b>12</b>
<b>4. TEST RESULT .....</b>	<b>13</b>
<b>4.1 AC POWER LINE CONDUCTED EMISSION .....</b>	<b>13</b>
<b>4.2 6DB BANDWIDTH AND OCCUPIED BANDWIDTH(99%) .....</b>	<b>16</b>
<b>4.3 OUTPUT POWER MEASUREMENT .....</b>	<b>18</b>
<b>4.4 POWER SPECTRAL DENSITY.....</b>	<b>20</b>
<b>4.5 CONDUCTED BAND EDGE AND SPURIOUS EMISSION .....</b>	<b>22</b>
<b>4.6 RADIATION BANDEDGE AND SPURIOUS EMISSION .....</b>	<b>26</b>
<b>APPENDIX 1 - PHOTOGRAPHS OF EUT</b>	

# 1. GENERAL INFORMATION

## 1.1 EUT INFORMATION

Applicant	RM Acquisition, LLC 9855 Woods Drive Skokie, IL 60077 USA
Equipment	TND™ 740
Model No.	TND 740
Model Discrepancy	N/A
EUT Functions	IEEE 802.11bgn+BT+GPS
Received Date	Jan, 03, 2017
Date of Test	Jan 06 ~ Jan 19, 2017
Output Power (W)	BLE : 0.0009 (EIRP : 0.0018)
Power Operation	<input type="checkbox"/> AC 120V/60Hz <input type="checkbox"/> Adapter(Not for sale) <input type="checkbox"/> PoE(Not for sale) <input checked="" type="checkbox"/> Host system <input checked="" type="checkbox"/> DC Type : <input checked="" type="checkbox"/> Battery <input checked="" type="checkbox"/> Car Charger <input type="checkbox"/> DC Power Supply <input type="checkbox"/> External DC adapter

## 1.2 EUT CHANNEL INFORMATION

Frequency Range	2402MHz-2480MHz
Modulation Type	GFSK for BLE-1Mbps
Number of channel	40 Channels

**Remark:**

Refer as ANSI 63.10:2013 clause 5.6.1 Table 4 and RSS-GEN Table A1 for test channels

Number of frequencies to be tested		
Frequency range in which device operates	Number of frequencies	Location in frequency range of operation
<input type="checkbox"/> 1 MHz or less	1	Middle
<input type="checkbox"/> 1 MHz to 10 MHz	2	1 near top and 1 near bottom
<input checked="" type="checkbox"/> More than 10 MHz	3	1 near top, 1 near middle, and 1 near bottom

## 1.3 ANTENNA INFORMATION

<b>Antenna Category</b>	<input checked="" type="checkbox"/> Integral: antenna permanently attached <input type="checkbox"/> External dedicated antennas <input type="checkbox"/> External Unique antenna connector
<b>Antenna Type</b>	<input checked="" type="checkbox"/> PIFA <input type="checkbox"/> PCB <input type="checkbox"/> Dipole <input type="checkbox"/> Coils
<b>Antenna Gain</b>	2.75 dBi

## 1.4 MEASUREMENT UNCERTAINTY

PARAMETER	UNCERTAINTY
AC Powerline Conducted Emission	+/- 1.2575
Emission bandwidth, 20dB bandwidth	+/- 1.4003
RF output power, conducted	+/- 1.1372
Power density, conducted	+/- 1.4003
3M Semi Anechoic Chamber / 30M~200M	+/- 4.0138
3M Semi Anechoic Chamber / 200M~1000M	+/- 3.9483
3M Semi Anechoic Chamber / 1G~8G	+/- 2.5975
3M Semi Anechoic Chamber / 8G~18G	+/- 2.6112
3M Semi Anechoic Chamber / 18G~26G	+/- 2.7389
3M Semi Anechoic Chamber / 26G~40G	+/- 2.9683
3M Semi Anechoic Chamber / 40G~60G	+/- 1.8509
3M Semi Anechoic Chamber / 60G~75G	+/- 1.9869
3M Semi Anechoic Chamber / 75G~110G	+/- 2.9651
3M Semi Anechoic Chamber / 110G~170G	+/- 2.7807
3M Semi Anechoic Chamber / 170G~220G	+/- 3.6437
3M Semi Anechoic Chamber / 220G~325G	+/- 4.2982

**Remark:**

1. This uncertainty represents an expanded uncertainty expressed at approximately the 95% confidence level using a coverage factor of  $k=2$
2. ISO/IEC 17025 requires that an estimate of the measurement uncertainties associated with the emissions test results be included in the report.

## 1.5 FACILITIES AND TEST LOCATION

All measurement facilities used to collect the measurement data are located at No.11, Wugong 6th Rd., Wugu Dist., New Taipei City 24891, Taiwan. (R.O.C.)

Test site	Test Engineer	Remark
AC Conduction Room	David Cheng	
Radiation	Kevin Kuo	
RF Conducted	Eric Lee	

**Remark:** The sites are constructed in conformance with the requirements of ANSI C63.7, ANSI C63.4 and CISPR Publication 22.

## 1.6 INSTRUMENT CALIBRATION

RF Conducted Test Site					
Equipment	Manufacturer	Model	S/N	Cal Date	Cal Due
Spectrum Analyzer	R&S	FSV 40	101073	08/01/2016	07/31/2017

3M 966 Chamber Test Site					
Equipment	Manufacturer	Model	S/N	Cal Date	Cal Due
Bi-log Antenna	TESEQ	CBL 6112D	35403	07/03/2016	07/02/2017
Double Ridged BroadBand Horn Antenna	SCHWARZBECK	BBHA 9120 D	9120D-778	07/15/2016	07/14/2017
Double Ridged Guide Horn Antenna	ETS · LINDGREN	3117	00078733	11/17/2016	11/16/2017
EMI Test Receiver	ROHDE & SCHWARZ	ESCI	100221	04/27/2016	04/26/2017
Horn Antenna	COM-POWER	AH-840	03077	12/02/2016	12/01/2017
Loop Antenna	COM-POWER	AL-130	121060	05/24/2016	05/23/2017
Preamplifier	Agilent	8447D	2944A10052	07/13/2016	07/12/2017
Preamplifier	Agilent	8449B	3008A01916	07/13/2016	07/12/2017
PSA Series Spectrum Analyzer	Agilent	E4446A	MY46180323	04/13/2016	04/12/2017
Software	E3.815206a				

AC Conducted Emissions Test Site					
Equipment	Manufacturer	Model	S/N	Cal Date	Cal Due
EMI Test Receiver	R&S	ESCI	101201	08/20/2016	08/19/2017
LISN	Schwarzbeck	NNLK 8129	8129-286	08/19/2016	08/18/2017
LISN(EUT)	Schwarzbeck	NSLK 8127	8127-527	08/19/2016	08/18/2017
Pulse Limiter	R&S	ESH3Z2	C3010026-2	08/21/2016	08/22/2017
Software	EZ-EMC				

**Remark:** Each piece of equipment is scheduled for calibration once a year.

## 1.7 SUPPORT AND EUT ACCESSORIES EQUIPMENT



EUT Accessories Equipment					
No.	Equipment	Brand	Model	Series No.	FCC ID
1	Car Charger	N/A	N/A	N/A	N/A
2	Docking	N/A	N/A	N/A	N/A

Support Equipment					
No.	Equipment	Brand	Model	Series No.	FCC ID
1	Notebook	Acer	Z01	N/A	QDS-BRCM1018
2	Battery	YUASA	CMF75D23L	N/A	N/A
3	PS/2 Mouse	hp	M-SBF96	FATSQDC5BYJQKZ	FCC DoC
4	PS/2 Keyboard	Genius	K939	N/A	FCC DoC
5	Microphone & Earphone	INTOPIC	JASS-288	N/A	N/A
6	Monitor	DELL	P2314Ht	CN-0HMJ1V-74445-46S-156S	FCC DoC
7	Host PC	DELL	T5810	8G5NKG2	N/A
8	Modem	GALILEO	AL-56ERM	0MERM04A0212	FCC DoC
9	Printer	HP	SNPRB-1202-01	CN54K182G9	N/A

## 1.8 Test methodology and applied standards

The test methodology, setups and results comply with all requirements in accordance with ANSI C63.10:2013, FCC Part 2, FCC Part 15.247, KDB 558074 D01 v03r05, RSS-247 Issue 2 and RSS-GEN Issue 4

## 1.9 Table of accreditations and listings

Country	Agency	Scope of Accreditation	Logo
USA	FCC	3M Semi Anechoic Chamber (FCC MRA: TW1039) to perform FCC Part 15 measurements	
Canada	Industry Canada	3M Semi Anechoic Chamber (IC 2324G-1 / IC 2324G-2) to perform	



## 2. TEST SUMMERY

FCC Standard Section	IC Standard Section	Report Section	Test Item	Result
15.203	-	1.2	Antenna Requirement	Pass
15.207(a)	RSS-GEN 8.8	4.1	AC Conducted Emission	Pass
15.247(a)(2)	RSS-247(5.2)(a)	4.2	6 dB Bandwidth	Pass
-	RSS-GEN 6.6	4.2	Occupied Bandwidth (99%)	Pass
15.247(b)	RSS-247(5.4)(d)	4.3	Output Power Measurement	Pass
15.247(e)	RSS-247(5.2)(b)	4.4	Power Spectral Density	Pass
15.247(d)	RSS-247(5.5)	4.5	Conducted Band Edge	Pass
15.247(d)	RSS-247(5.5)	4.5	Conducted Emission	Pass
15.247(d)	RSS-GEN 8.9, 8.10	4.6	Radiation Band Edge	Pass
15.247(d)	RSS-GEN 8.9, 8.10	4.6	Radiation Spurious Emission	Pass

### 3. DESCRIPTION OF TEST MODES

#### 3.1 THE WORST MODE OF OPERATING CONDITION

Operation mode	BT4.0 Mode (1Mbps)
Test Channel Frequencies	1.Lowest Channel : 2402MHz 2.Middle Channel : 2440MHz 3.Highest Channel : 2480MHz

*Remark:*

1. EUT pre-scanned data rate of output power for each mode, the worst data rate were recorded in this report.

.

### 3.2 THE WORST MODE OF MEASUREMENT

AC Power Line Conducted Emission	
Test Condition	AC Power line conducted emission for line and neutral
Voltage/Hz	120V/60Hz
Test Mode	Mode 1:EUT power by host system via USB Cable
Worst Mode	<input checked="" type="checkbox"/> Mode 1 <input type="checkbox"/> Mode 2 <input type="checkbox"/> Mode 3 <input type="checkbox"/> Mode 4

Radiated Emission Measurement Above 1G	
Test Condition	Band edge, Emission for Unwanted and Fundamental
Voltage/Hz	120V/60Hz
Test Mode	Mode 1:EUT power by host system via USB Cable
Worst Mode	<input checked="" type="checkbox"/> Mode 1 <input type="checkbox"/> Mode 2 <input type="checkbox"/> Mode 3 <input type="checkbox"/> Mode 4
Worst Position	<input type="checkbox"/> Placed in fixed position. <input checked="" type="checkbox"/> Placed in fixed position at X-Plane (E2-Plane) <input type="checkbox"/> Placed in fixed position at Y-Plane (E1-Plane) <input type="checkbox"/> Placed in fixed position at Z-Plane (H-Plane)
Worst Polarity	<input checked="" type="checkbox"/> Horizontal <input type="checkbox"/> Vertical

Radiated Emission Measurement Below 1G	
Test Condition	Radiated Emission Below 1G
Voltage/Hz	120V/60Hz
Test Mode	Mode 1:EUT power by host system via USB Cable Mode 2:EUT power by Car charger via Power Board(Charger mode)
Worst Mode	<input checked="" type="checkbox"/> Mode 1 <input type="checkbox"/> Mode 2 <input type="checkbox"/> Mode 3 <input type="checkbox"/> Mode 4

**Remark:**

1. The worst mode was record in this test report.
2. EUT pre-scanned in three axis ,X ,Y, Z and two polarity, Horizontal and Vertical for radiated measurement. The worst case(Y-Plane and Vertical) were recorded in this report.
3. For below 1G AC power line conducted emission and radiation emission were performed the EUT transmit at the Maximum bandwidth and Middle channel as worse case.
4. EUT power supply had two ways (Car charger, by host system),that EUT pre-scanned two power supply(Car charger and host system) at Radiated below 1G, and the worst case was host system mode.
5. EUT Transmit only can by host system to set, and we tested car Car charger in Charger mode. Therefore EUT used host system mode for Radiated measurement above 1G and Conduction below 1G in test report.

### 3.3 EUT DUTY CYCLE

Duty Cycle				
Configuration	TX ON (ms)	TX ALL (ms)	Duty Cycle (%)	Duty Factor(dB)
BLE	0.42	0.64	65.63	1.83

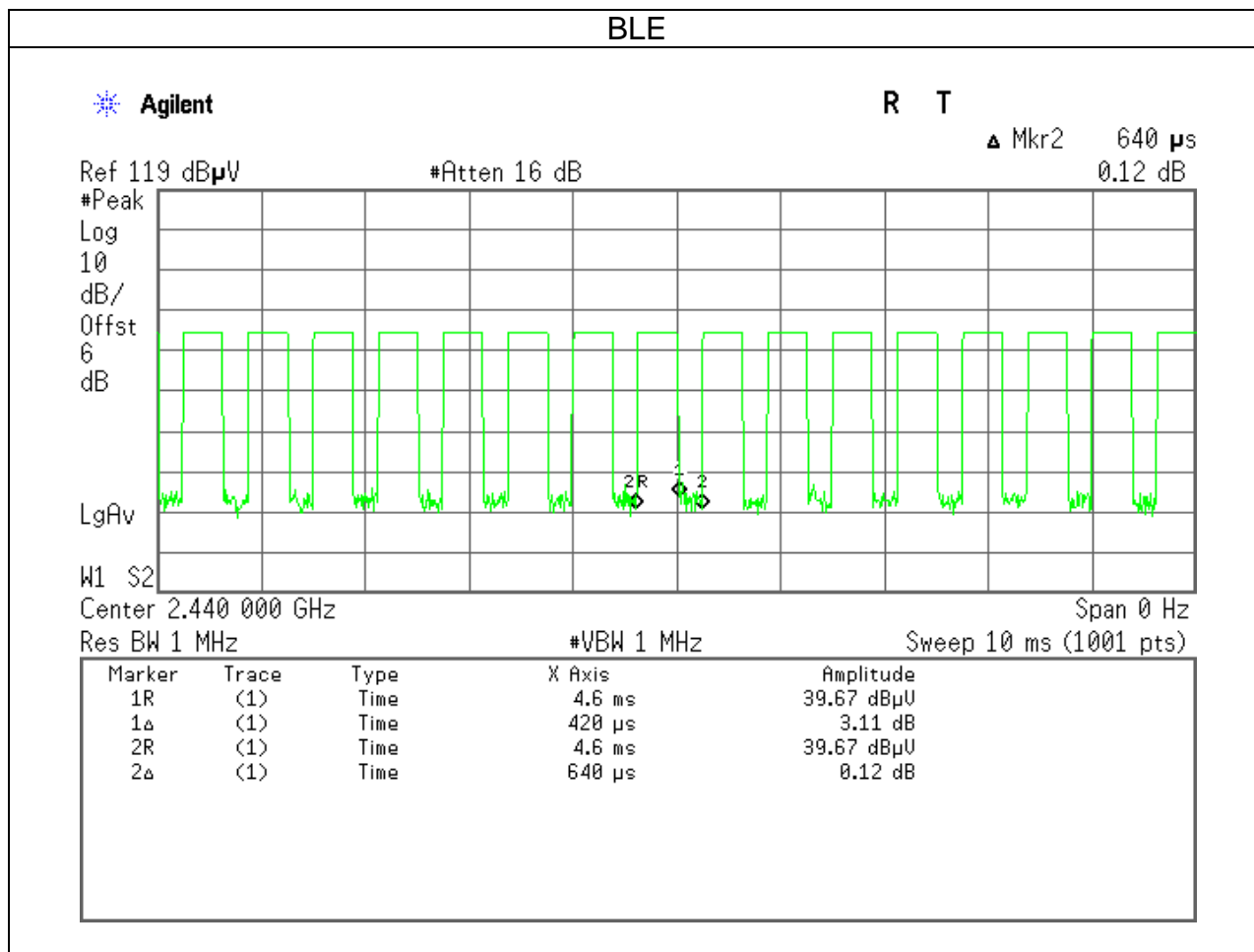

## 4. TEST RESULT

### 4.1 AC POWER LINE CONDUCTED EMISSION

#### 4.1.1 Test Limit

According to §15.207(a) and RSS-GEN section 8.8,

Frequency Range (MHz)	Limits(dBμV)	
	Quasi-peak	Average
0.15 to 0.50	66 to 56*	56 to 46*
0.50 to 5	56	46
5 to 30	60	50

\* Decreases with the logarithm of the frequency.

#### 4.1.2 Test Procedure

Test method Refer as ANSI 63.10:2013 clause 6.2,

1. The EUT was placed on a non-conducted table, which is 0.8m above horizontal ground plane and 0.4m above vertical ground plane.
2. EUT connected to the line impedance stabilization network (LISN)
3. Receiver set RBW of 9kHz and Detector Peak, and note as quasi-peak and average.
4. Maximum procedure was performed on the six highest emissions to ensure EUT compliance.
5. Recorded Line for Neutral and Line.

#### 4.1.3 Test Setup

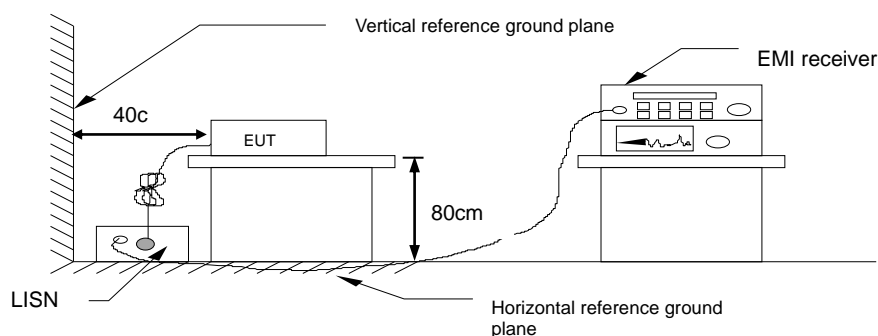

#### 4.1.4 Test Result

**Pass**

**Test Data**

Test Mode:	Mode 1	Temp/Hum	24(°C)/ 50%RH
Test Voltage:	120Vac / 60Hz	Test Date	Jan 06, 2017
Phase:	Line	Test Engineer	David Cheng

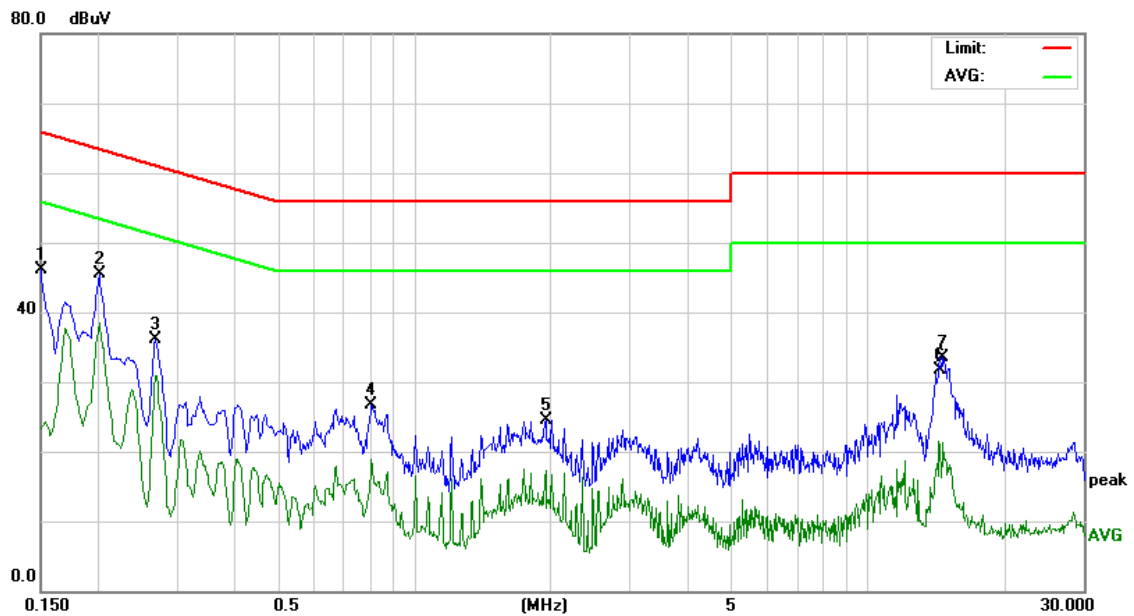

Frequency (MHz)	Reading (dBuV)	Factor (dB)	Result (dB)	Limit (dBuV)	Margin (dBuV)	Detector (dBuV)
0.1500	36.03	10.09	46.12	65.99	-19.87	Peak
0.2020	35.36	10.10	45.46	63.52	-18.06	Peak
0.2700	25.98	10.11	36.09	61.12	-25.03	Peak
0.8059	16.62	10.12	26.74	56.00	-29.26	Peak
1.9500	14.20	10.29	24.49	56.00	-31.51	Peak
14.3740	20.83	10.80	31.63	60.00	-28.37	Peak

Test Mode:	Mode 1	Temp/Hum	27(°C)/ 53%RH
Test Voltage:	120Vac / 60Hz	Test Date	Jan 06, 2017
Phase:	Neutral	Test Engineer	David Cheng

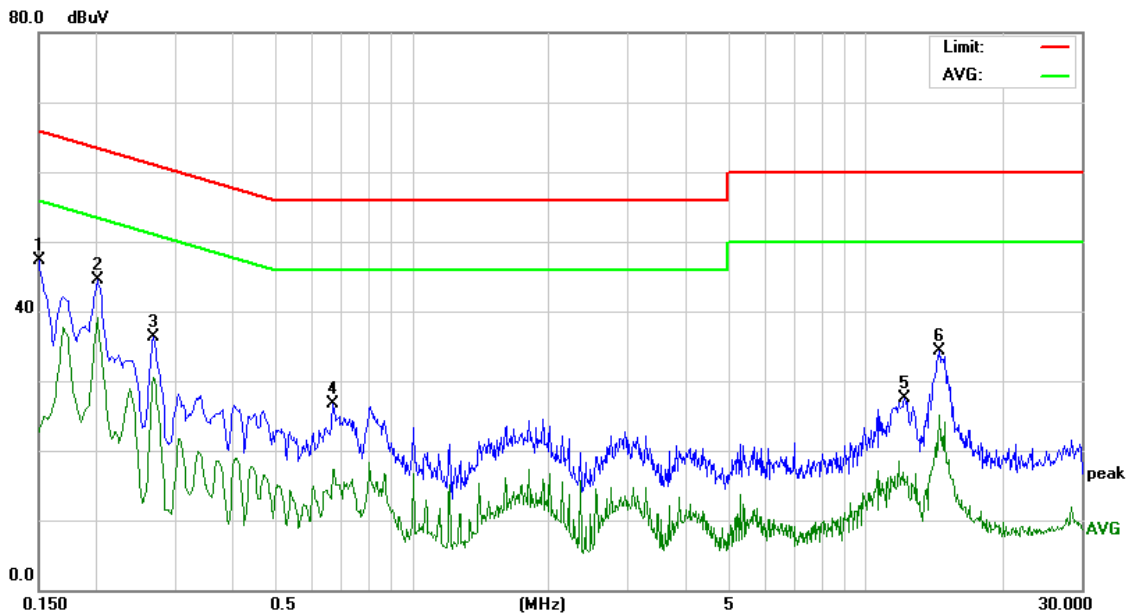

Frequency (MHz)	Reading (dBuV)	Factor (dB)	Result (dB)	Limit (dBuV)	Margin (dBuV)	Detector (dBuV)
0.1500	37.18	10.05	47.23	65.99	-18.76	Peak
0.2020	34.40	10.01	44.41	63.52	-19.11	Peak
0.2700	26.29	10.04	36.33	61.12	-24.79	Peak
0.6700	16.56	10.13	26.69	56.00	-29.31	Peak
12.2140	16.83	10.74	27.57	60.00	-32.43	Peak
14.5620	23.51	10.85	34.36	60.00	-25.64	Peak

## 4.2 6DB BANDWIDTH AND OCCUPIED BANDWIDTH(99%)

### 4.2.1 Test Limit

According to §15.247(a)(2) and RSS-247 section 5.2(a)

#### 6 dB Bandwidth :

Limit	Shall be at least 500kHz
-------	--------------------------

Occupied Bandwidth(99%) : For reporting purposes only.

### 4.2.2 Test Procedure

Test method Refer as KDB 558074 D01 v03r05, section 8.1 and ANSI 63.10:2013 clause 6.9.2 & 6.9.3.

1. The EUT RF output connected to the spectrum analyzer by RF cable.
2. Setting maximum power transmit of EUT
3. SA set RBW = 100kHz, VBW = 300kHz and Detector = Peak, to measurement 6 dB Bandwidth and 99% Bandwidth.
4. Measure and record the result of 6 dB Bandwidth and 99% Bandwidth. in the test report.

### 4.2.3 Test Setup

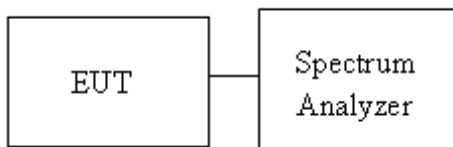

### 4.2.4 Test Result

Test mode: BLE mode / 2402-2480 MHz				
Channel	Frequency (MHz)	OBW(99%) (MHz)	6dB BW (MHz)	6dB limit (kHz)
Low	2402	1.0246	0.6956	>500
Mid	2440	1.0289	0.7043	
High	2480	1.0246	0.7000	



Test Data

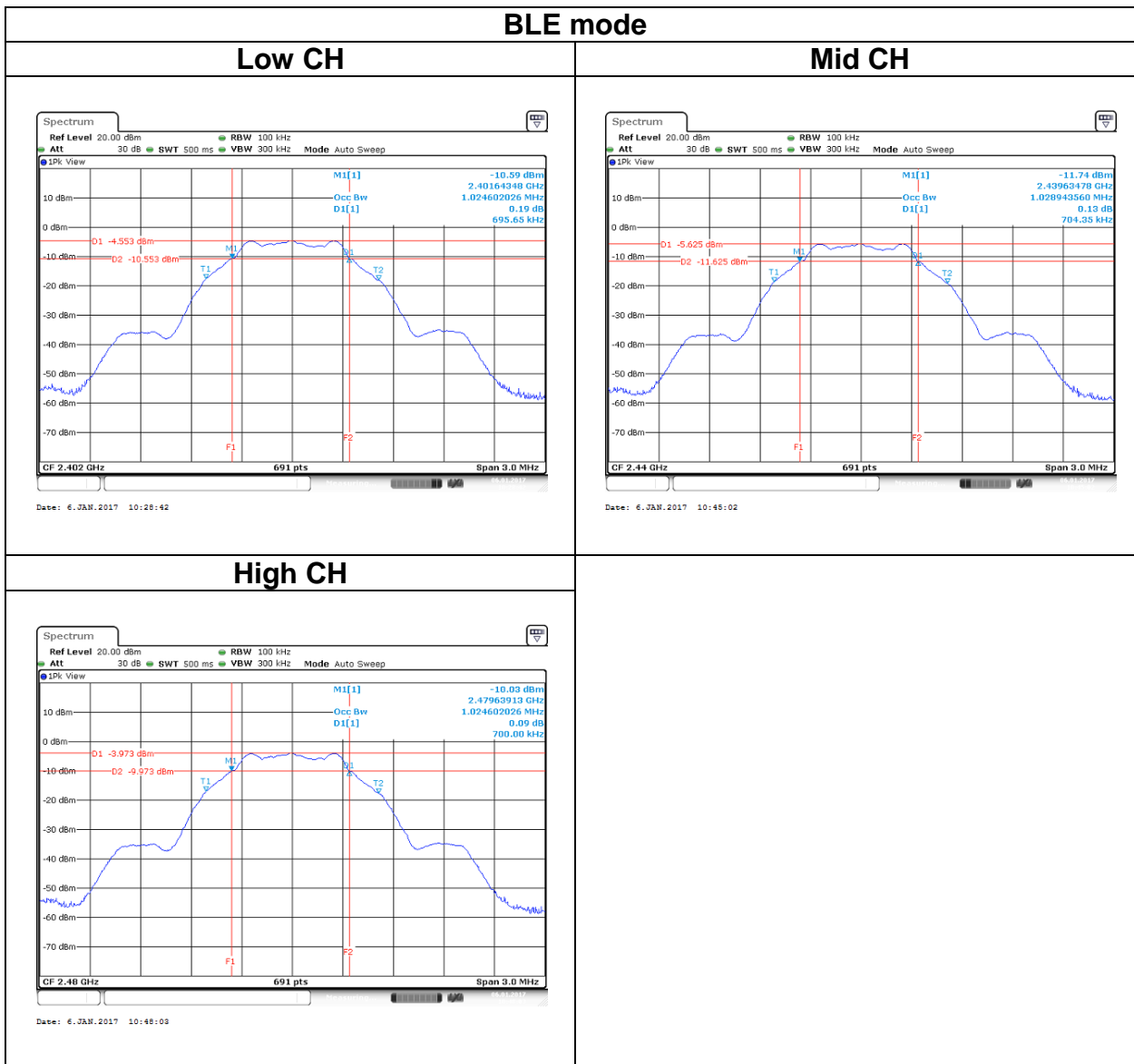

### 4.3 OUTPUT POWER MEASUREMENT

#### 4.3.1 Test Limit

According to §15.247(b) and RSS-247 section 5.4(d)

**Peak output power :**

For systems using digital modulation in the 2400-2483.5 MHz, and 5725-5850 MHz bands: 1 Watt(30 dBm), base on the use of antennas with directional gain not exceed 6 dBi If transmitting antennas of directional gain greater than 6dBi are used the peak output power the conducted output power from the intentional radiator shall be reduced by the amount in dB that the directional gain of the antenna exceeds 6 dBi. In case of point-to-point operation, the limit has to be reduced by 1dB for every 3 dB that the directional gain of the antenna exceeds 6 dBi.

Limit	<input checked="" type="checkbox"/> Antenna not exceed 6 dBi : 30dBm <input type="checkbox"/> Antenna with DG greater than 6 dBi [ Limit = 30 – (DG – 6) ] <input type="checkbox"/> Point-to-point operation
-------	---

**Average output power** : For reporting purposes only.

#### 4.3.2 Test Procedure

Test method Refer as KDB 558074 D01 v03r05, section 9.1.2.

1. The EUT RF output connected to the power meter by RF cable.
2. Setting maximum power transmit of EUT.
3. The path loss was compensated to the results for each measurement.
4. Measure and record the result of Peak output power and Average output power. in the test report.

#### 4.3.3 Test Setup

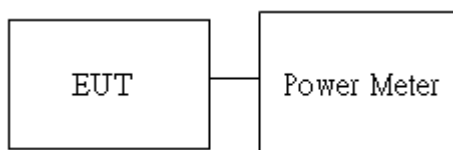

### 4.3.4 Test Result

**Peak output power :**

BLE Mode							
Config.	CH	Freq. (MHz)	PK Power (dBm)	EIRP PK Power (dBm)	PK Power (W)	EIRP PK Power (W)	FCC/IC Limit (dBm)
BLE Data rate: 1Mbps	0	2402	-0.45	2.30	0.0009	0.0017	30
	19	2440	-1.42	1.33	0.0007	0.0014	
	39	2480	-0.23	2.52	0.0009	0.0018	

**Average output power :**

BLE Mode			
Config.	CH	Freq. (MHz)	AV Power (dBm)
BLE Data rate: 1Mbps	0	2402	-1.53
	19	2440	-3.13
	39	2480	-0.74

## 4.4 POWER SPECTRAL DENSITY

### 4.4.1 Test Limit

According to §15.247(e) and RSS-247 section 5.2(b)

For digitally modulated systems, the power spectral density conducted from the intentional radiator to the antenna shall not be greater than 8 dBm in any 3 kHz band during any time interval of continuous transmission.

Limit	<input checked="" type="checkbox"/> Antenna not exceed 6 dBi : 8dBm <input type="checkbox"/> Antenna with DG greater than 6 dBi [ Limit = 8 – (DG – 6) ] <input type="checkbox"/> Point-to-point operation :
-------	---

### 4.4.2 Test Procedure

Test method Refer as KDB 558074 D01 v03r05, Section 10.2

1. The EUT RF output connected to the spectrum analyzer by RF cable.
2. Setting maximum power transmit of EUT
3. SA set RBW = 3kHz, VBW = 30kHz, Span = 1.5 times DTS Bandwidth (6 dB BW), Detector = Peak, Sweep Time = Auto and Trace = Max hold.
4. The path loss and Duty Factor were compensated to the results for each measurement by SA.
5. Mark the maximum level.
6. Measure and record the result of power spectral density. in the test report.

### 4.4.3 Test Setup

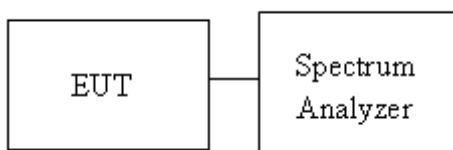

### 4.4.4 Test Result

Test mode: BLE mode / 2402-2480 MHz			
Channel	Frequency (MHz)	PSD (dBm)	IC/FCC limit (dBm)
Low	2402	-15.56	8
Mid	2440	-16.64	
High	2480	-15.01	

## Test Data

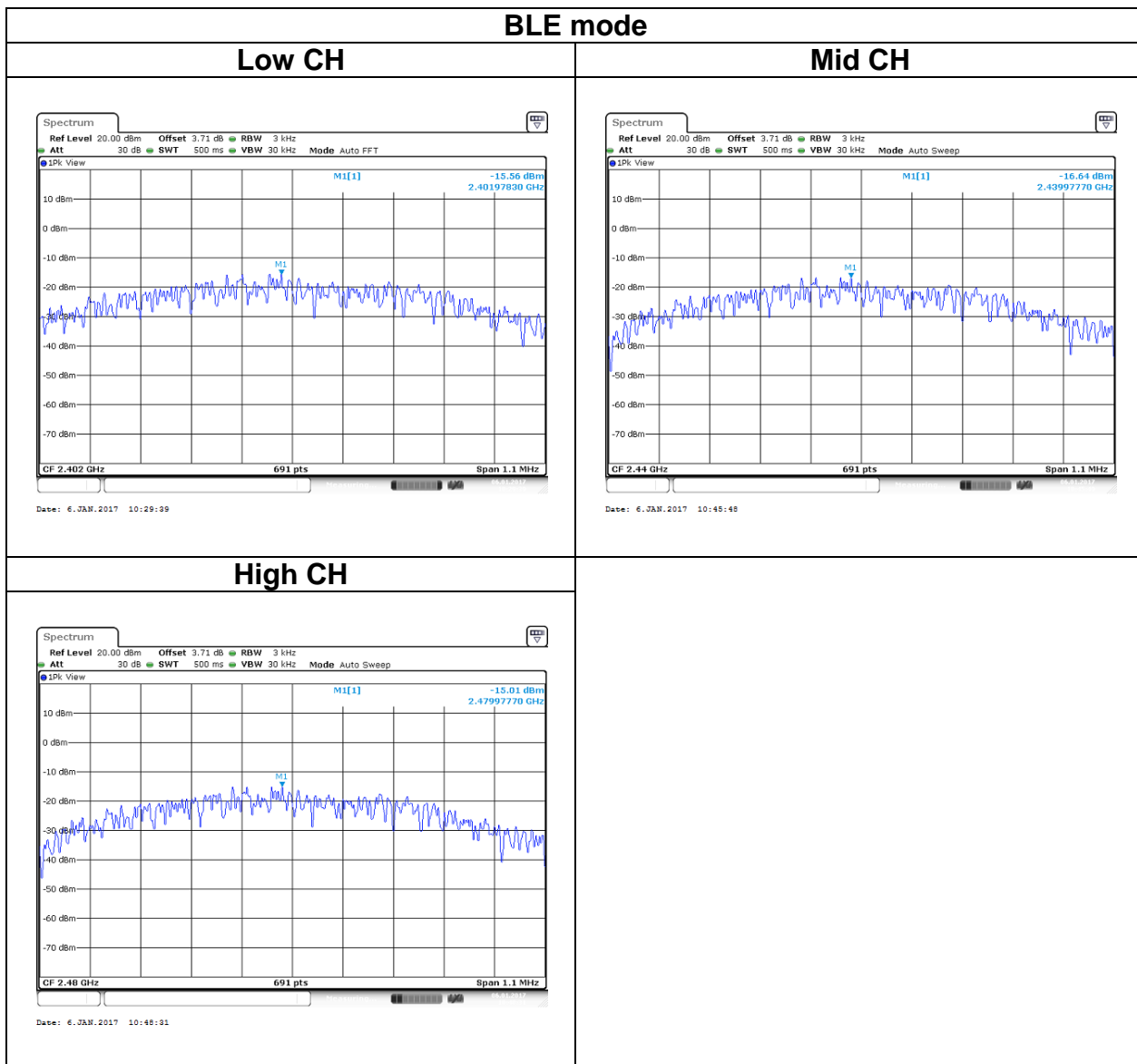

## 4.5 CONDUCTED BAND EDGE AND SPURIOUS EMISSION

### 4.5.1 Test Limit

According to §15.247(d) and RSS-247 section 5.5

In any 100 kHz bandwidth outside the authorized frequency band,

Non-restricted bands shall be attenuated at least 20 dB/30 dB relative to the maximum PSD level in 100 kHz by RF conducted or a radiated measurement which fall in the restricted bands, as defined in §15.205(a), must also comply with the radiated emission limits specified in §15.209(a).

### 4.5.2 Test Procedure

Test method Refer as KDB 558074 D01 v03r05, Section 11.

1. EUT RF output port connected to the SA by RF cable, and the path loss was compensated to result.
2. SA setting, RBW=100kHz, VBW=300kHz, Detector=Peak, Trace mode = max hold, SWT = Auto.
3. In any 100 kHz bandwidth outside the authorized frequency band, shall be attenuated at least 20 dB relative to the maximum in-band peak PSD level in 100 kHz when conducted power procedure is used. If the transmitter complies with the conducted power limits based on the use of RMS averaging over a time interval, the attenuation required under this paragraph shall be 30 dB instead of 20 dB.

### 4.5.3 Test Setup

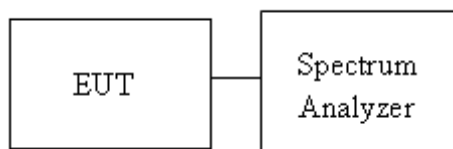

### 4.5.4 Test Result

#### Test Data

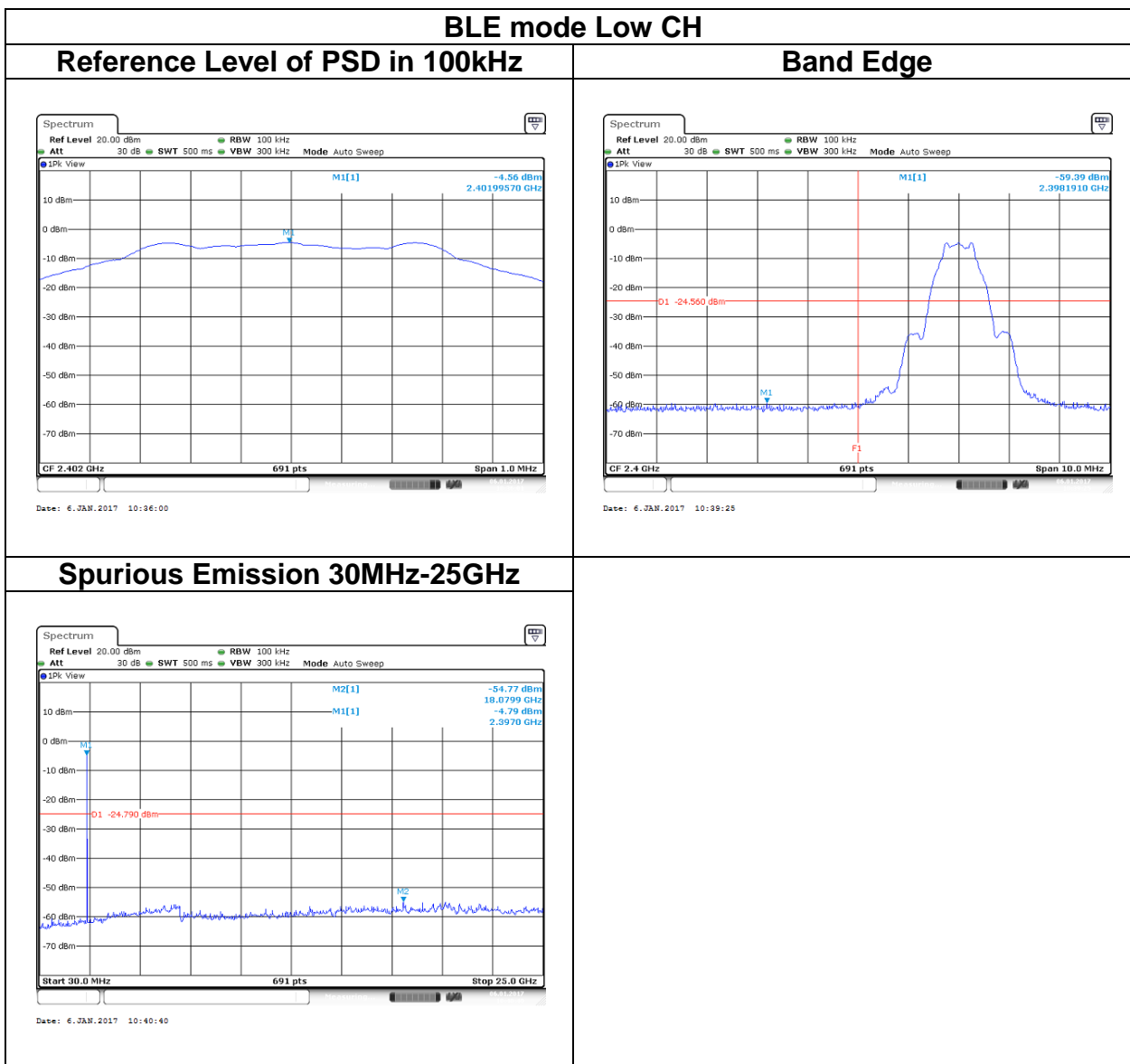

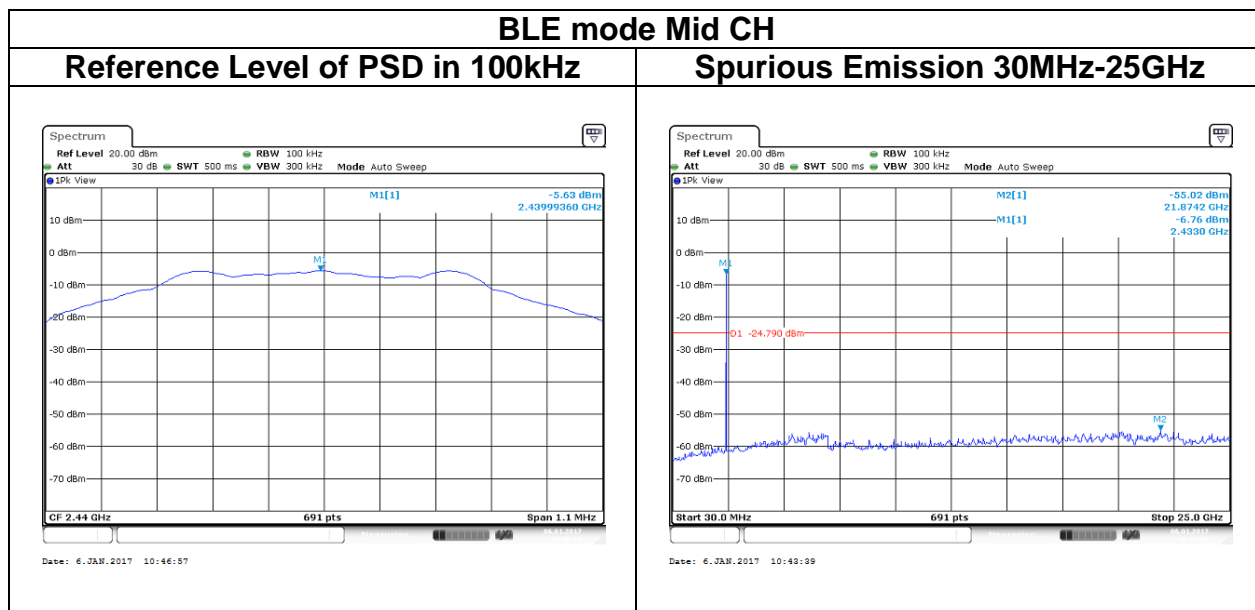



**BLE mode High CH**

**Reference Level of PSD in 100kHz**

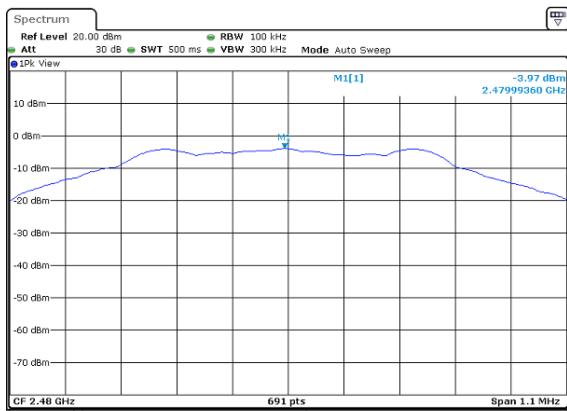

Date: 6.JAN.2017 10:49:33

**Band Edge**

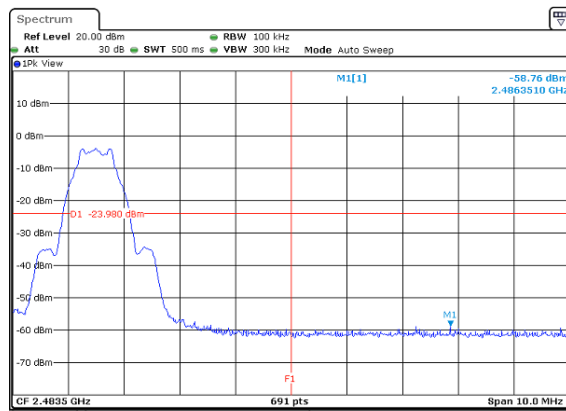

Date: 6.JAN.2017 10:51:15

**Spurious Emission 30MHz-25GHz**

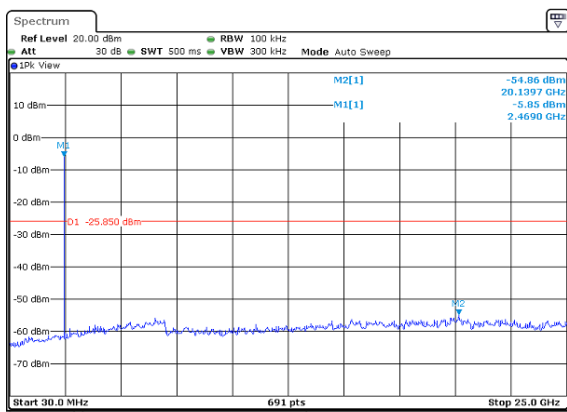

Date: 6.JAN.2017 10:52:17

## 4.6 RADIATION BANDEGE AND SPURIOUS EMISSION

### 4.6.1 Test Limit

FCC according to §15.247(d), §15.209 and §15.205,

IC according to RSS-247 section 5.5, RSS-Gen, Section 8.9 and 8.10

In any 100 kHz bandwidth outside the authorized frequency band, all harmonic and spurious must be least 20 dB below the highest emission level with the authorized frequency band. Radiation emission which fall in the restricted bands must also follow the FCC section 15.209 as below limit in table.

#### Below 30 MHz

Frequency	Field Strength (microvolts/m)	Magnetic H-Field (microamperes/m)	Measurement Distance (metres)
9-490 kHz	2,400/F (F in kHz)	2,400/F (F in kHz)	300
490-1,705 kHz	24,000/F (F in kHz)	24,000/F (F in kHz)	30
1.705-30 MHz	30	N/A	30

#### Above 30 MHz

Frequency (MHz)	Field Strength microvolts/m at 3 metres (watts, e.i.r.p.)	
	Transmitters	Receivers
30-88	100 (3 nW)	100 (3 nW)
88-216	150 (6.8 nW)	150 (6.8 nW)
216-960	200 (12 nW)	200 (12 nW)
Above 960	500 (75 nW)	500 (75 nW)

Remark:

Although these tests were performed other than open area test site, adequate comparison measurements were confirmed against 30 m open are test site. Therefore sufficient tests were made to demonstrate that the alternative site produces results that correlate with the ones of tests made in an open field based on KDB 937606.

### 4.6.2 Test Procedure

Test method Refer as KDB 558074 D01 v03r05, Section 12.1.

1. The EUT is placed on a turntable, Above 1 GHz is 1.5m and below 1 GHz is 0.8m above ground plane. The EUT Configured un accordance with ANSI C63.10, and the EUT set in a continuous mode.
2. The turntable shall be rotated for 360 degrees to determine the position of maximum emission level. And EUT is set 3m away from the receiving antenna, which is scanned from 1m to 4m above the ground plane to find out the highest emissions. Measurement are made polarized in both the vertical and the horizontal positions with antenna.
3. Span shall wide enough to full capture the emission measured. The SA from 30MHz to 26.5GHz set to the low, Mid and High channels with the EUT transmit.
4. The SA setting following :
  - (1) Below 1G : RBW = 100kHz, VBW  $\geq$  3 RBW, Sweep = Auto, Detector = Peak, Trace = Max hold.
  - (2) Above 1G :
    - (2.1) For Peak measurement : RBW = 1MHz, VBW  $\geq$  3 RBW, Sweep = Auto, Detector = Peak, Trace = Max hold.
    - (2.2) For Average measurement : RBW = 1MHz, VBW
      - If Duty Cycle  $\geq$  98%, VBW=10Hz.
      - If Duty Cycle < 98%, VBW=1/T.

Configuration	Duty Cycle (%)	VBW
BLE	65.63 %	2.4kHz

### 4.6.3 Test Setup

#### 9kHz ~ 30MHz

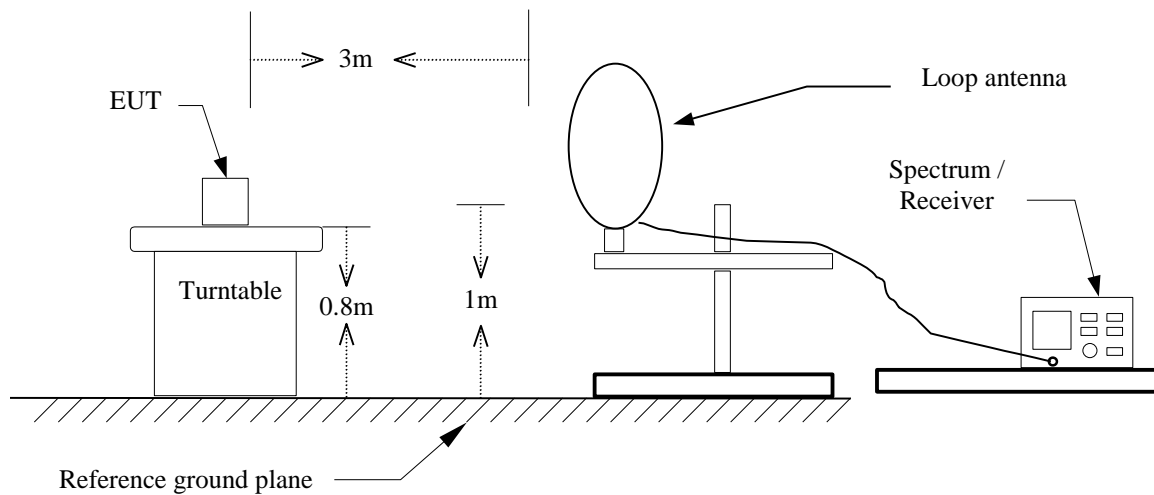

#### 30MHz ~ 1GHz

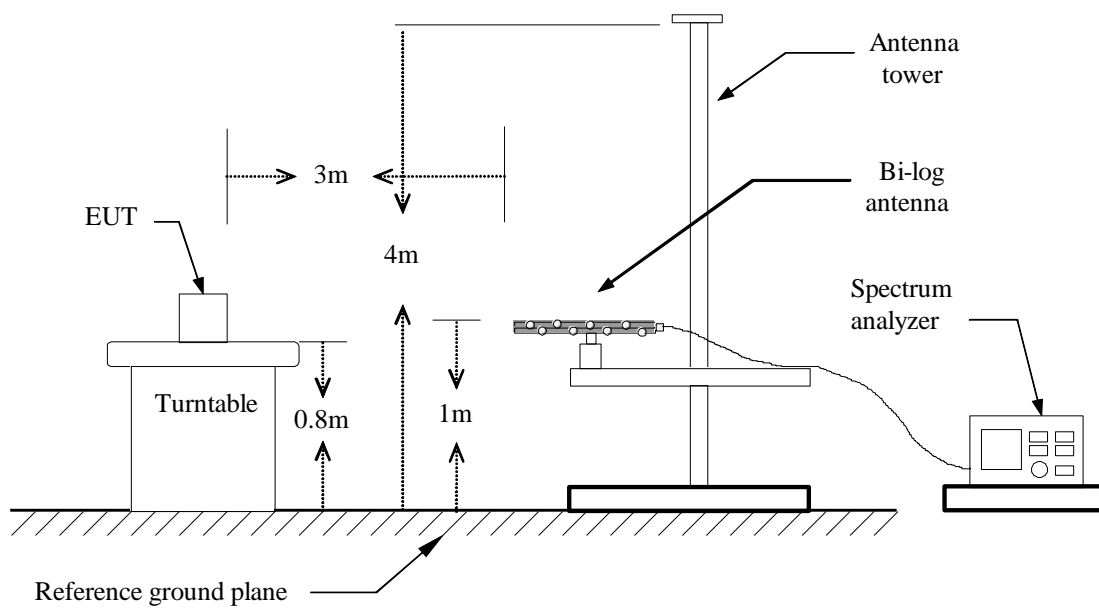

**Above 1 GHz**

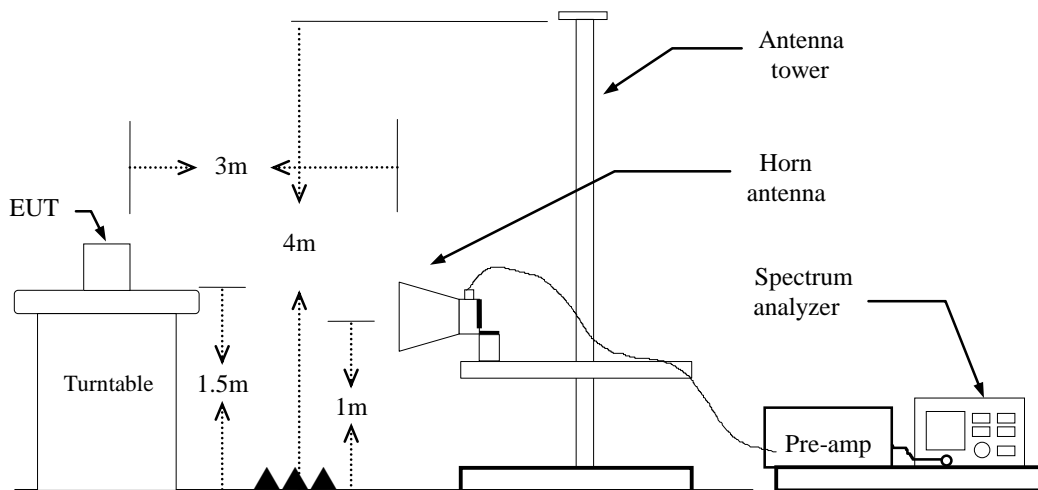

### 4.6.4 Test Result

#### Band Edge Test Data

Test Mode:	BLE Low CH	Temp/Hum	27(°C)/ 53%RH
Test Item	Band Edge	Test Date	Jan 11, 2017
Polarize	Horizontal	Test Engineer	Ed Chiang
Detector	Peak	Test Voltage:	120Vac / 60Hz

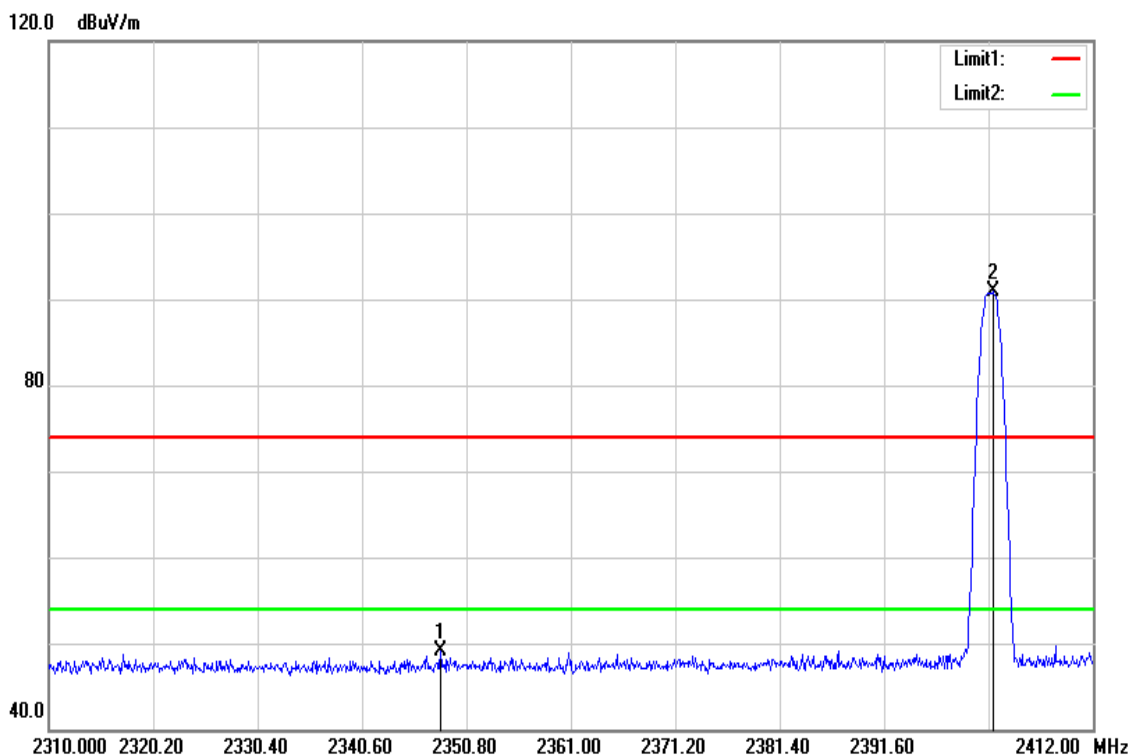

Frequency (MHz)	Reading (dBuV)	Correct Factor (dB/m)	Result (dBuV/m)	Limit (dBuV/m)	Margin (dB)	Remark
2348.250	51.95	-2.83	49.12	74.00	-24.88	Peak
2402.208	93.23	-2.41	90.82	-	-	Peak

Test Mode:	BLE Low CH	Temp/Hum	27(°C)/ 53%RH
Test Item	Band Edge	Test Date	Jan 11, 2017
Polarize	Horizontal	Test Engineer	Ed Chiang
Detector	Average	Test Voltage:	120Vac / 60Hz

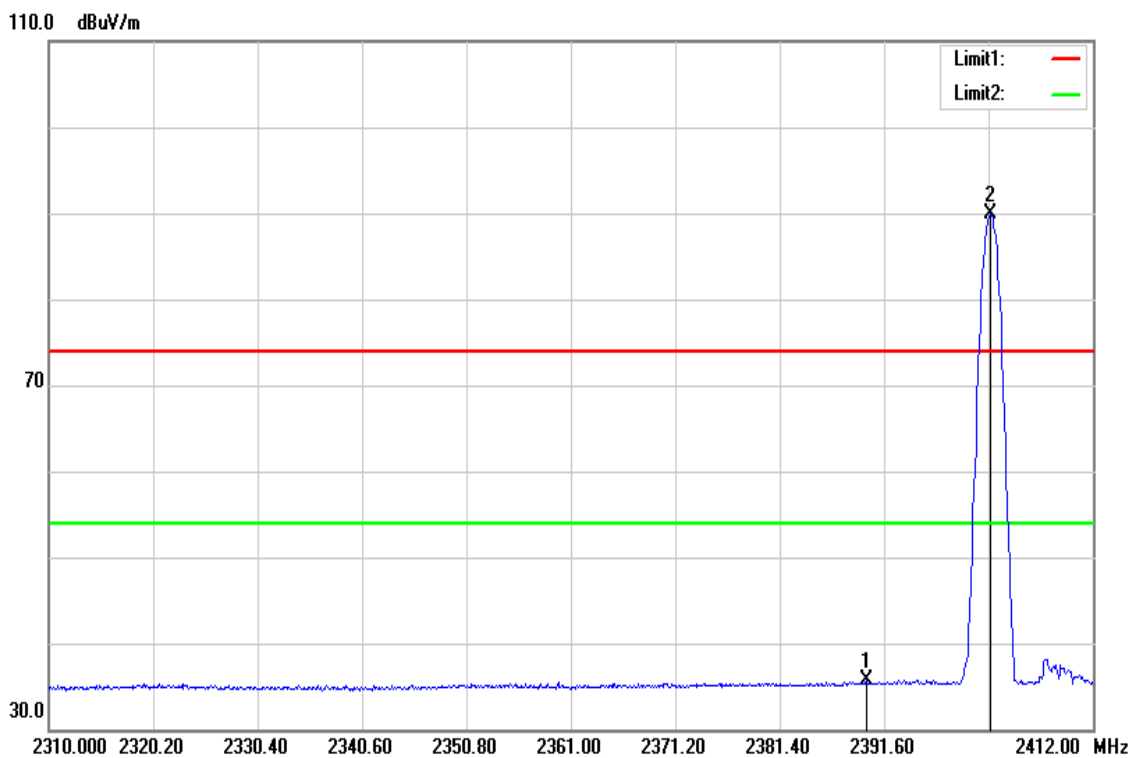

Frequency (MHz)	Reading (dBuV)	Correct Factor (dB/m)	Result (dBuV/m)	Limit (dBuV/m)	Margin (dB)	Remark
2389.866	38.16	-2.49	35.67	54.00	-18.33	AVG
2402.004	92.40	-2.41	89.99	-	-	AVG

Test Mode:	BLE High CH	Temp/Hum	27(°C)/ 53%RH
Test Item	Band Edge	Test Date	Jan 11, 2017
Polarize	Horizontal	Test Engineer	Ed Chiang
Detector	Peak	Test Voltage:	120Vac / 60Hz

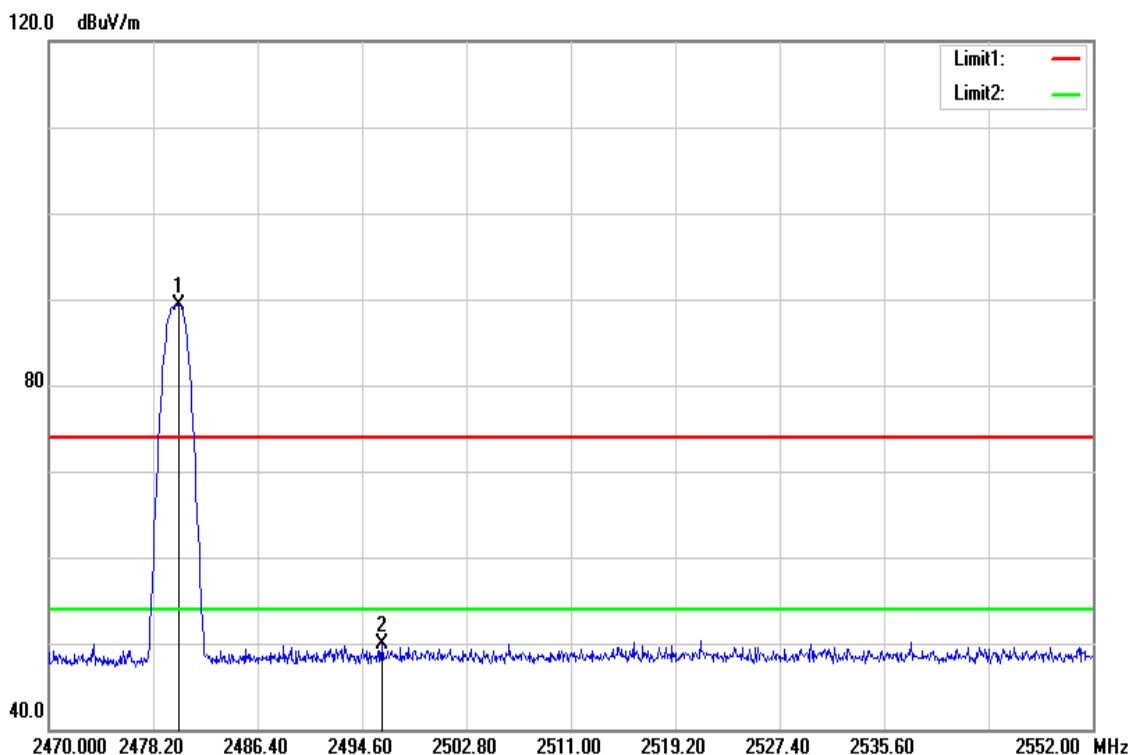

Frequency (MHz)	Reading (dBuV)	Correct Factor (dB/m)	Result (dBuV/m)	Limit (dBuV/m)	Margin (dB)	Remark
2480.168	91.36	-2.03	89.33	-	-	peak
2496.158	51.75	-1.89	49.86	74.00	-24.14	peak



Test Mode:	BLE High CH	Temp/Hum	27(°C)/ 53%RH
Test Item	Band Edge	Test Date	Jan 11, 2017
Polarize	Horizontal	Test Engineer	Ed Chiang
Detector	Average	Test Voltage:	120Vac / 60Hz

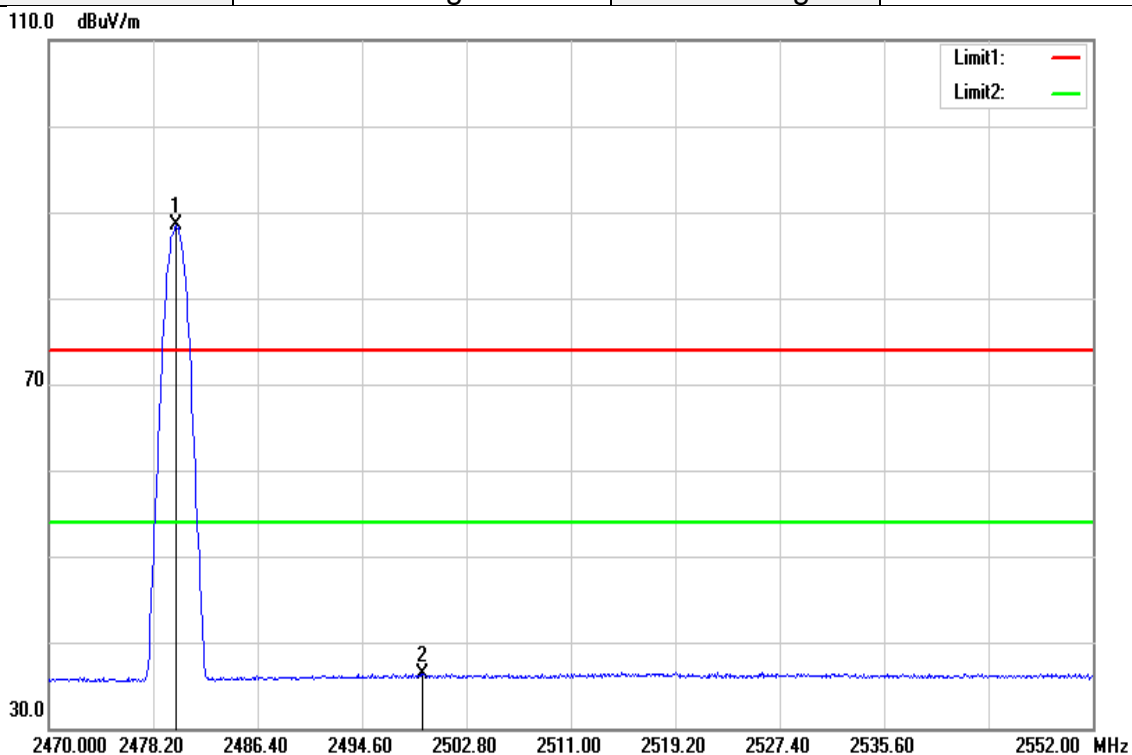

Frequency (MHz)	Reading (dBuV)	Correct Factor (dB/m)	Result (dBuV/m)	Limit (dBuV/m)	Margin (dB)	Remark
2480.004	90.46	-2.03	88.43	-	-	AVG
2499.356	38.18	-1.86	36.32	54.00	-17.68	AVG

**Above 1G Test Data**

Test Mode:	BLE Low CH	Temp/Hum	27(°C)/ 53%RH
Test Item	Harmonic	Test Date	Jan 12, 2017
Polarize	Vertical	Test Engineer	Ed Chiang
Detector	Peak and Average	Test Voltage:	120Vac / 60Hz

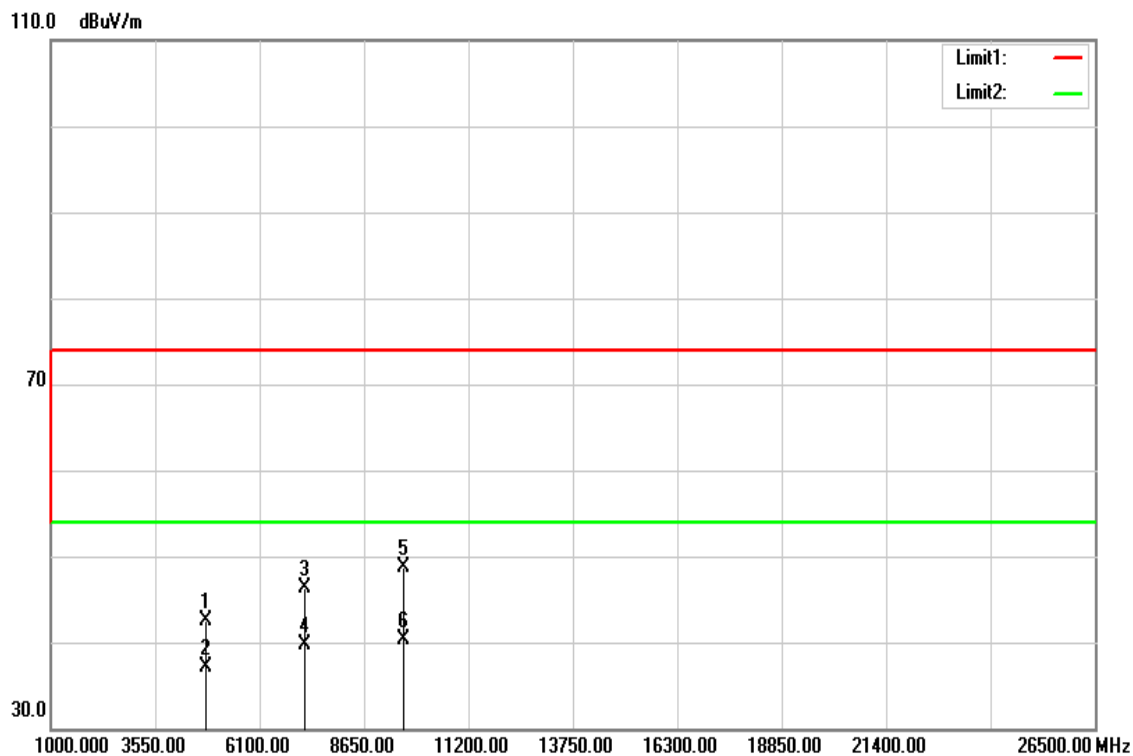

Frequency (MHz)	Reading (dBuV)	Correct Factor (dB/m)	Result (dBuV/m)	Limit (dBuV/m)	Margin (dB)	Remark
4804.000	37.41	5.04	42.45	74.00	-31.55	Peak
4804.000	32.03	5.04	37.07	54.00	-16.93	AVG
7206.000	33.73	12.62	46.35	74.00	-27.65	Peak
7206.000	27.17	12.62	39.79	54.00	-14.21	AVG
9608.000	31.10	17.60	48.70	74.00	-25.30	Peak
9608.000	22.80	17.60	40.40	54.00	-13.60	AVG

**Remark:**

1. Measuring frequencies from 1 GHz to the 10th harmonic of highest fundamental frequency.
2. For above 1GHz, the EUT peak value was under average limit, therefore the Average value compliance with the average limit

Test Mode:	BLE Low CH	Temp/Hum	27(°C)/ 53%RH
Test Item	Harmonic	Test Date	Jan 12, 2017
Polarize	Horizontal	Test Engineer	Ed Chiang
Detector	Peak and Average	Test Voltage:	120Vac / 60Hz

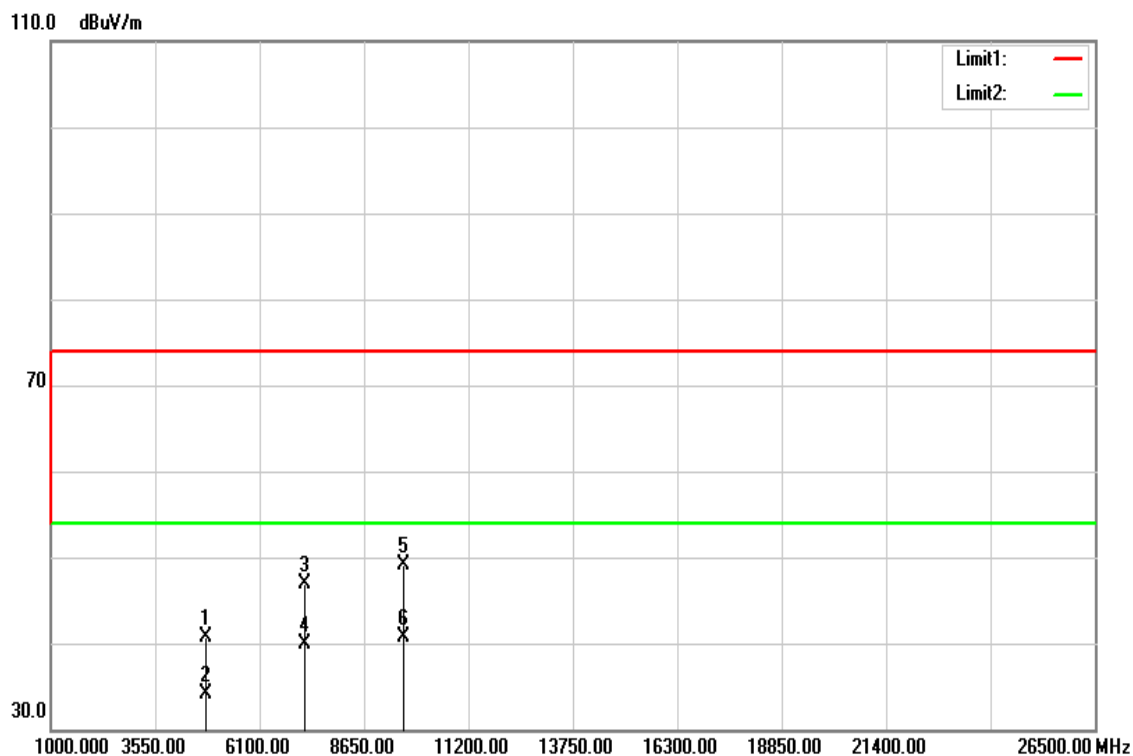

Frequency (MHz)	Reading (dBuV)	Correct Factor (dB/m)	Result (dBuV/m)	Limit (dBuV/m)	Margin (dB)	Remark
4804.000	35.76	5.04	40.80	74.00	-33.20	Peak
4804.000	29.13	5.04	34.17	54.00	-19.83	AVG
7206.000	34.26	12.62	46.88	74.00	-27.12	Peak
7206.000	27.19	12.62	39.81	54.00	-14.19	AVG
9608.000	31.43	17.60	49.03	74.00	-24.97	Peak
9608.000	23.01	17.60	40.61	54.00	-13.39	AVG

**Remark:**

1. Measuring frequencies from 1 GHz to the 10th harmonic of highest fundamental frequency.
2. For above 1GHz, the EUT peak value was under average limit, therefore the Average value compliance with the average limit

Test Mode:	BLE Mid CH	Temp/Hum	27(°C)/ 53%RH
Test Item	Harmonic	Test Date	Jan 12, 2017
Polarize	Vertical	Test Engineer	Ed Chiang
Detector	Peak and Average	Test Voltage:	120Vac / 60Hz

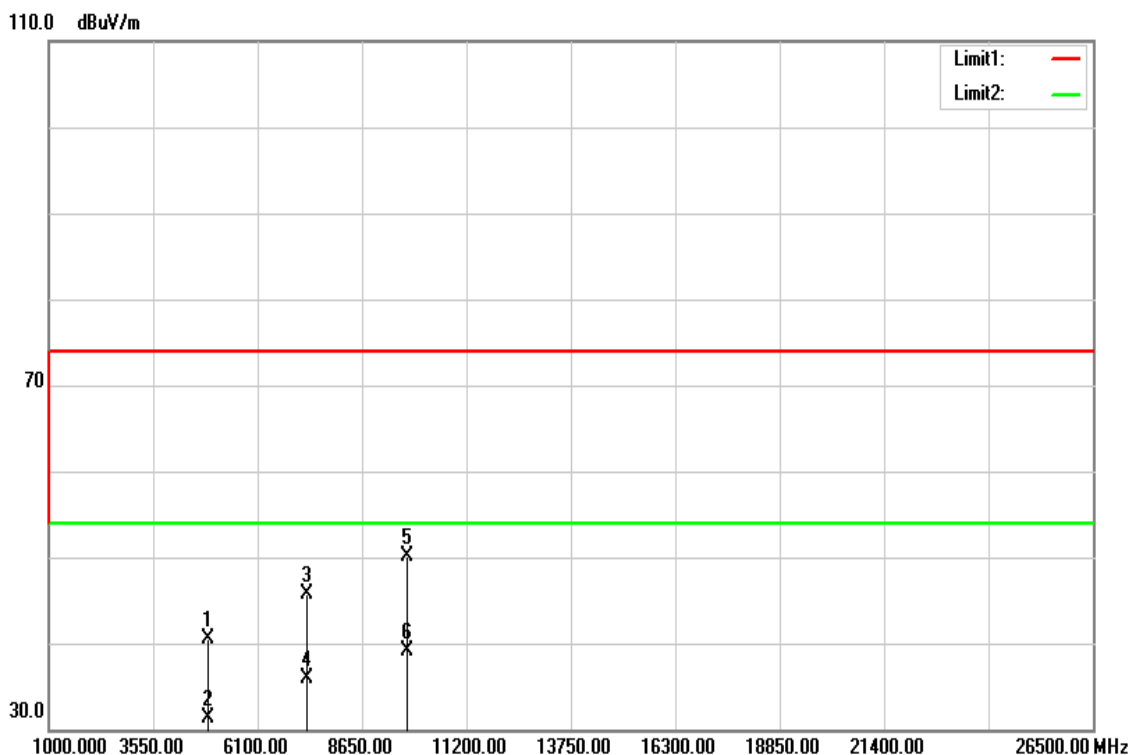

Frequency (MHz)	Reading (dBuV)	Correct Factor (dB/m)	Result (dBuV/m)	Limit (dBuV/m)	Margin (dB)	Remark
4880.000	35.29	5.25	40.54	74.00	-33.46	Peak
4880.000	26.09	5.25	31.34	54.00	-22.66	AVG
7320.000	32.69	12.97	45.66	74.00	-28.34	Peak
7320.000	22.95	12.97	35.92	54.00	-18.08	AVG
9760.000	32.59	17.60	50.19	74.00	-23.81	Peak
9760.000	21.51	17.60	39.11	54.00	-14.89	AVG

**Remark:**

1. Measuring frequencies from 1 GHz to the 10th harmonic of highest fundamental frequency.
2. For above 1GHz, the EUT peak value was under average limit, therefore the Average value compliance with the average limit

Test Mode:	BLE Mid CH	Temp/Hum	27(°C)/ 53%RH
Test Item	Harmonic	Test Date	Jan 12, 2017
Polarize	Horizontal	Test Engineer	Ed Chiang
Detector	Peak and Average	Test Voltage:	120Vac / 60Hz

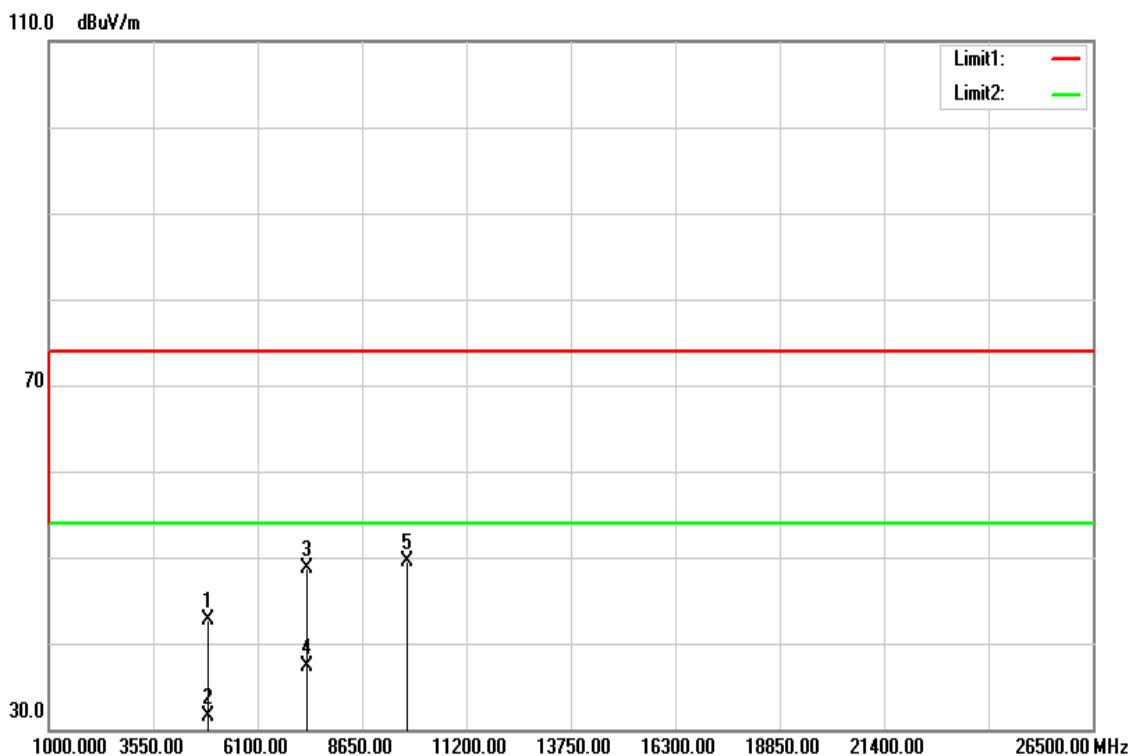

Frequency (MHz)	Reading (dBuV)	Correct Factor (dB/m)	Result (dBuV/m)	Limit (dBuV/m)	Margin (dB)	Remark
4880.000	35.82	5.25	41.07	74.00	-32.93	Peak
4880.000	26.03	5.25	31.28	54.00	-22.72	AVG
7302.000	34.09	12.91	47.00	74.00	-27.00	Peak
7302.000	23.10	12.91	36.01	54.00	-17.99	AVG
9760.000	32.07	17.60	49.67	74.00	-24.33	Peak
9760.000	23.28	17.60	40.88	54.00	-13.12	AVG

**Remark:**

1. Measuring frequencies from 1 GHz to the 10th harmonic of highest fundamental frequency.
2. For above 1GHz, the EUT peak value was under average limit, therefore the Average value compliance with the average limit

Test Mode:	BLE High CH	Temp/Hum	27(°C)/ 53%RH
Test Item	Harmonic	Test Date	Jan 12, 2017
Polarize	Vertical	Test Engineer	Ed Chiang
Detector	Peak and Average	Test Voltage:	120Vac / 60Hz

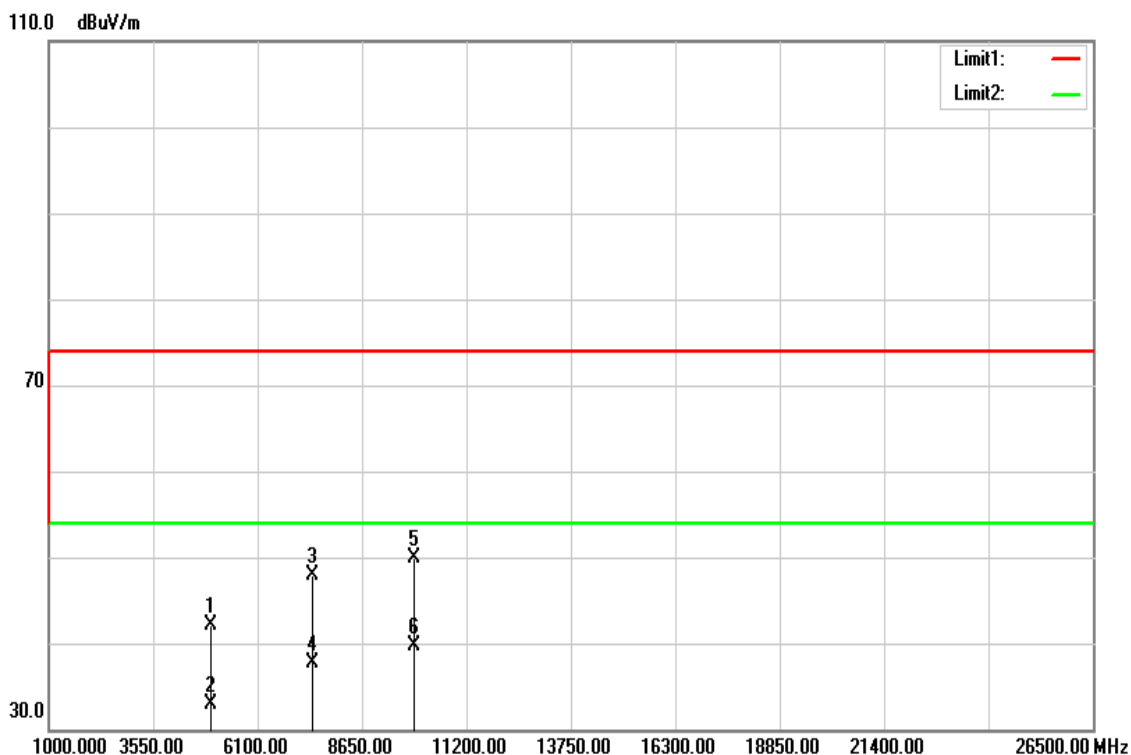

Frequency (MHz)	Reading (dBuV)	Correct Factor (dB/m)	Result (dBuV/m)	Limit (dBuV/m)	Margin (dB)	Remark
4960.000	36.59	5.46	42.05	74.00	-31.95	Peak
4960.000	27.36	5.46	32.82	54.00	-21.18	AVG
7440.000	34.67	13.33	48.00	74.00	-26.00	Peak
7440.000	24.28	13.33	37.61	54.00	-16.39	AVG
9920.000	32.40	17.60	50.00	74.00	-24.00	Peak
9920.000	22.08	17.60	39.68	54.00	-14.32	AVG

**Remark:**

1. Measuring frequencies from 1 GHz to the 10th harmonic of highest fundamental frequency.
2. For above 1GHz, the EUT peak value was under average limit, therefore the Average value compliance with the average limit

Test Mode:	BLE High CH	Temp/Hum	27(°C)/ 53%RH
Test Item	Harmonic	Test Date	Jan 12, 2017
Polarize	Horizontal	Test Engineer	Ed Chiang
Detector	Peak and Average	Test Voltage:	120Vac / 60Hz

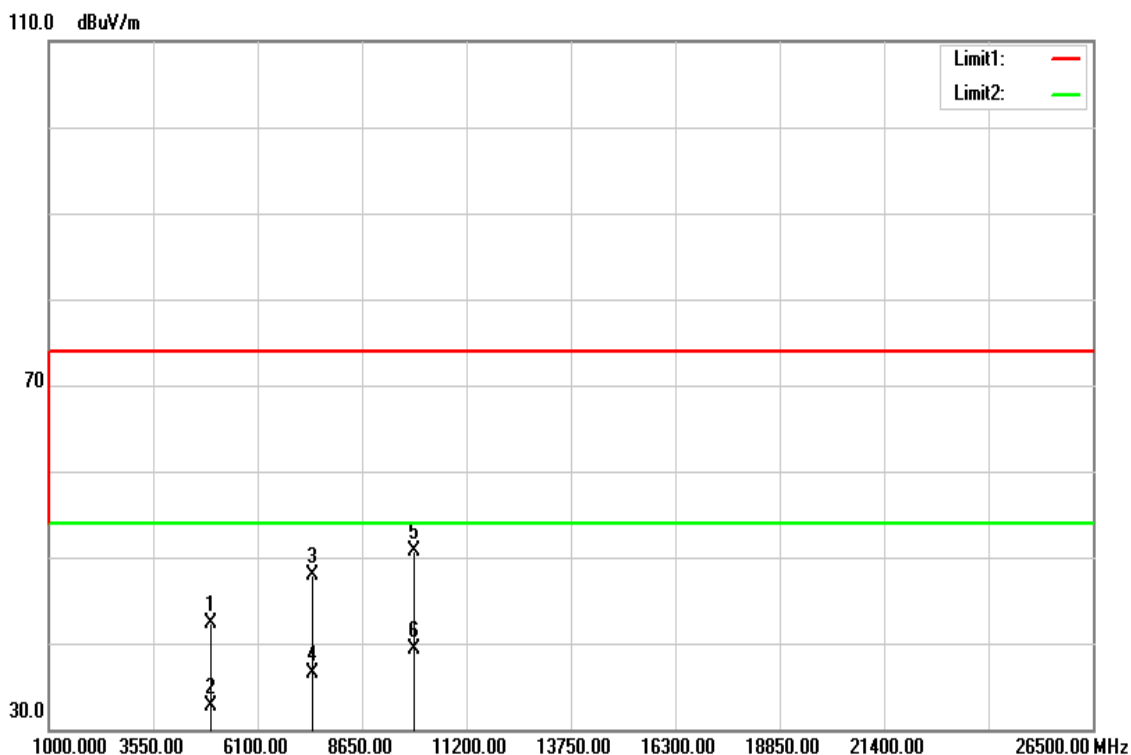

Frequency (MHz)	Reading (dBuV)	Correct Factor (dB/m)	Result (dBuV/m)	Limit (dBuV/m)	Margin (dB)	Remark
4960.000	36.81	5.46	42.27	74.00	-31.73	Peak
4960.000	27.28	5.46	32.74	54.00	-21.26	AVG
7440.000	34.66	13.33	47.99	74.00	-26.01	Peak
7440.000	23.20	13.33	36.53	54.00	-17.47	AVG
9920.000	33.13	17.60	50.73	74.00	-23.27	Peak
9920.000	21.68	17.60	39.28	54.00	-14.72	AVG

**Remark:**

1. Measuring frequencies from 1 GHz to the 10th harmonic of highest fundamental frequency.
2. For above 1GHz, the EUT peak value was under average limit, therefore the Average value compliance with the average limit

**Below 1G Test Data**

Test Mode:	BT Mode	Temp/Hum	27(°C)/ 53%RH
Test Item	30MHz-1GHz	Test Date	Jan 10, 2017
Polarize	Vertical	Test Engineer	Ed Chiang
Detector	Peak and Qusi-peak	Test Voltage:	120Vac / 60Hz

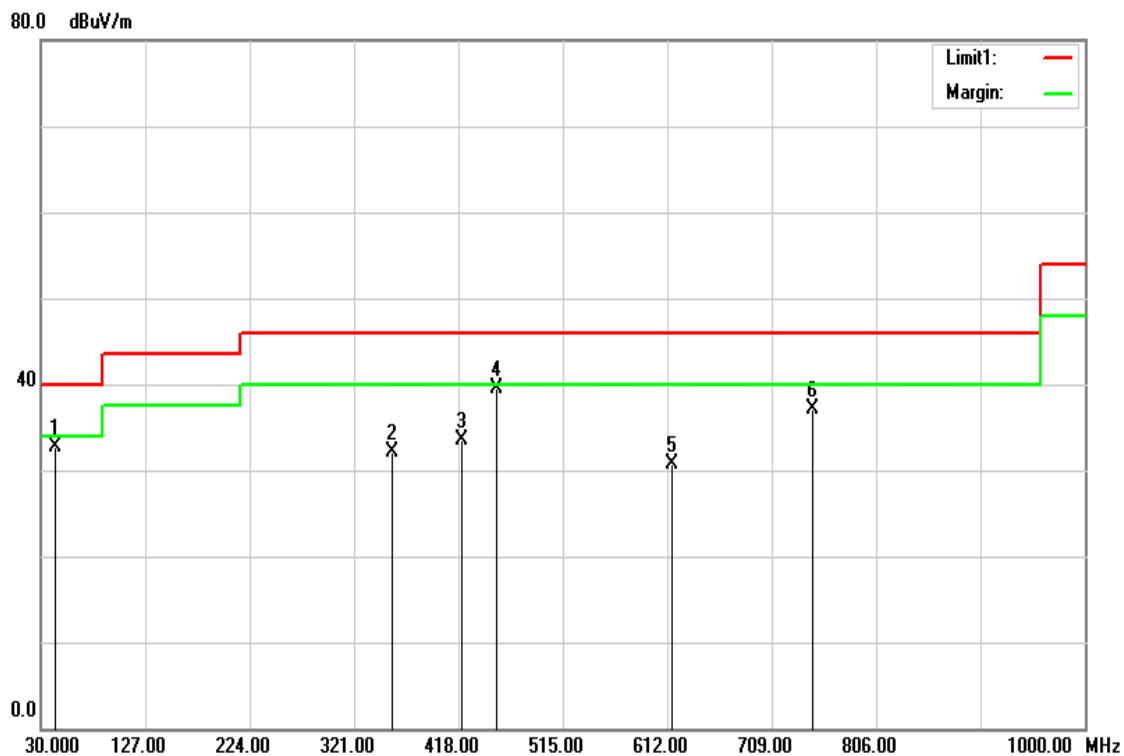

Frequency (MHz)	Reading (dBuV)	Correct Factor (dB/m)	Result (dBuV/m)	Limit (dBuV/m)	Margin (dB)	Remark
43.5800	50.05	-17.39	32.66	40.00	-7.34	QP
356.8900	44.74	-12.73	32.01	46.00	-13.99	Peak
420.9100	44.55	-11.07	33.48	46.00	-12.52	Peak
452.9200	49.70	-10.13	39.57	46.00	-6.43	Peak
615.8800	38.03	-7.38	30.65	46.00	-15.35	Peak
746.8300	42.09	-4.99	37.10	46.00	-8.90	Peak



Test Mode:	BT Mode	Temp/Hum	27(°C)/ 53%RH
Test Item	30MHz-1GHz	Test Date	Jan 10, 2017
Polarize	Horizontal	Test Engineer	Ed Chiang
Detector	Peak and Qusi-peak	Test Voltage:	120Vac / 60Hz

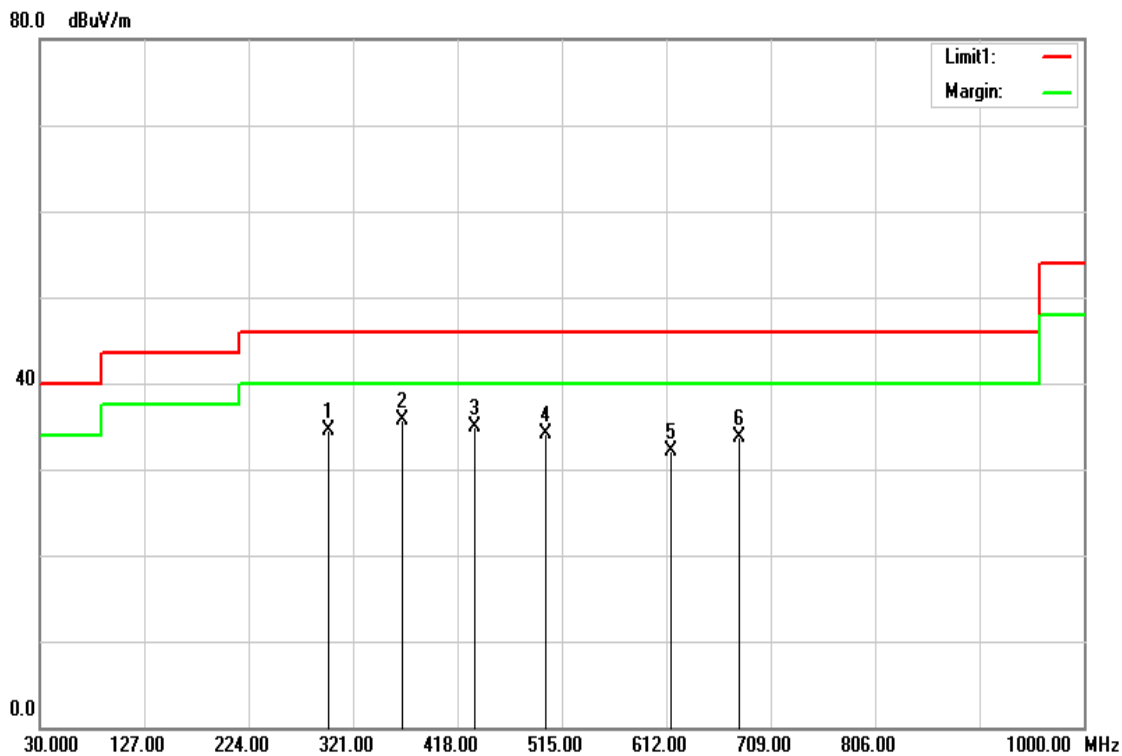

Frequency (MHz)	Reading (dBuV)	Correct Factor (dB/m)	Result (dBuV/m)	Limit (dBuV/m)	Margin (dB)	Remark
298.6900	48.70	-14.26	34.44	46.00	-11.56	Peak
366.5900	48.14	-12.50	35.64	46.00	-10.36	Peak
433.5200	45.66	-10.69	34.97	46.00	-11.03	Peak
499.4800	43.39	-9.25	34.14	46.00	-11.86	Peak
616.8500	39.54	-7.36	32.18	46.00	-13.82	Peak
679.9000	39.88	-6.27	33.61	46.00	-12.39	Peak

Test Mode:	Charger Mode	Temp/Hum	27(°C)/ 53%RH
Test Item	30MHz-1GHz	Test Date	Jan 19, 2017
Polarize	Vertical	Test Engineer	Ed Chiang
Detector	Peak and Qusi-peak	Test Voltage:	120Vac / 60Hz

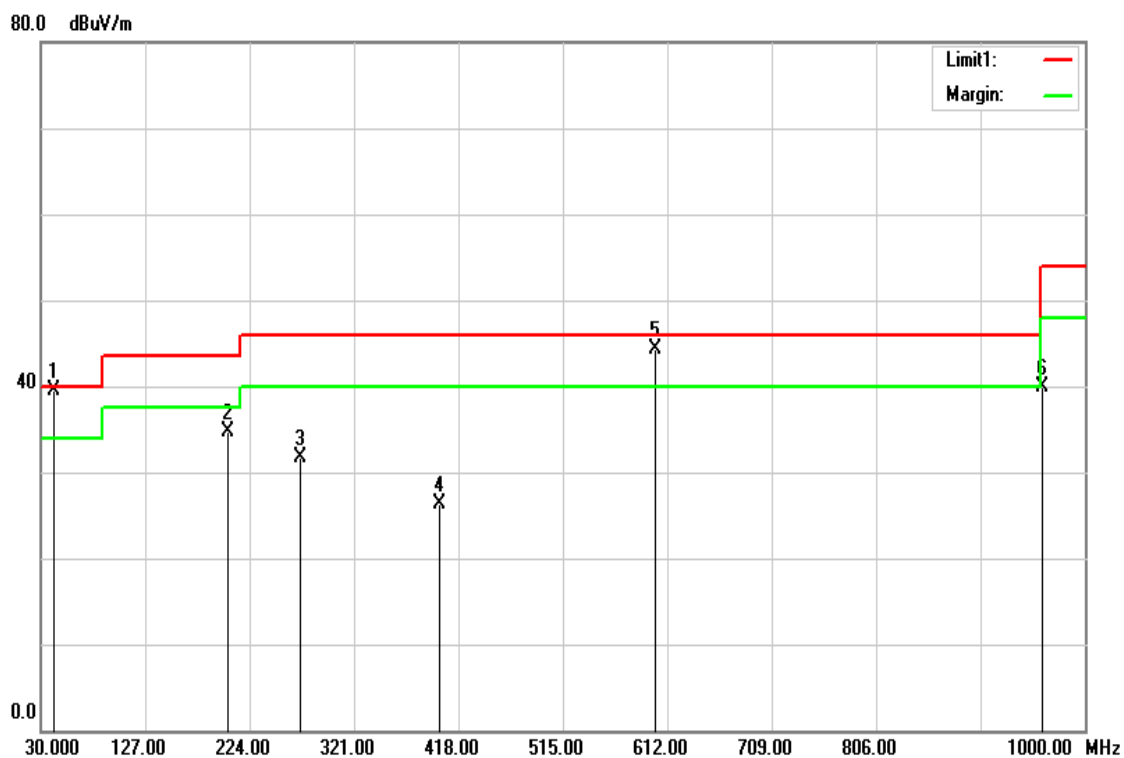

Frequency (MHz)	Reading (dBuV)	Correct Factor (dB/m)	Result (dBuV/m)	Limit (dBuV/m)	Margin (dB)	Remark
41.6400	55.76	-16.28	39.48	40.00	-0.52	QP
203.6300	50.50	-15.81	34.69	43.50	-8.81	Peak
270.5600	46.49	-14.79	31.70	46.00	-14.30	Peak
400.5400	38.03	-11.68	26.35	46.00	-19.65	Peak
600.3600	52.11	-7.75	44.36	46.00	-1.64	QP
960.2300	42.07	-2.23	39.84	54.00	-14.16	Peak

Test Mode:	Charger Mode	Temp/Hum	27(°C)/ 53%RH
Test Item	30MHz-1GHz	Test Date	Jan 19, 2017
Polarize	Horizontal	Test Engineer	Ed Chiang
Detector	Peak and Qusi-peak	Test Voltage:	120Vac / 60Hz

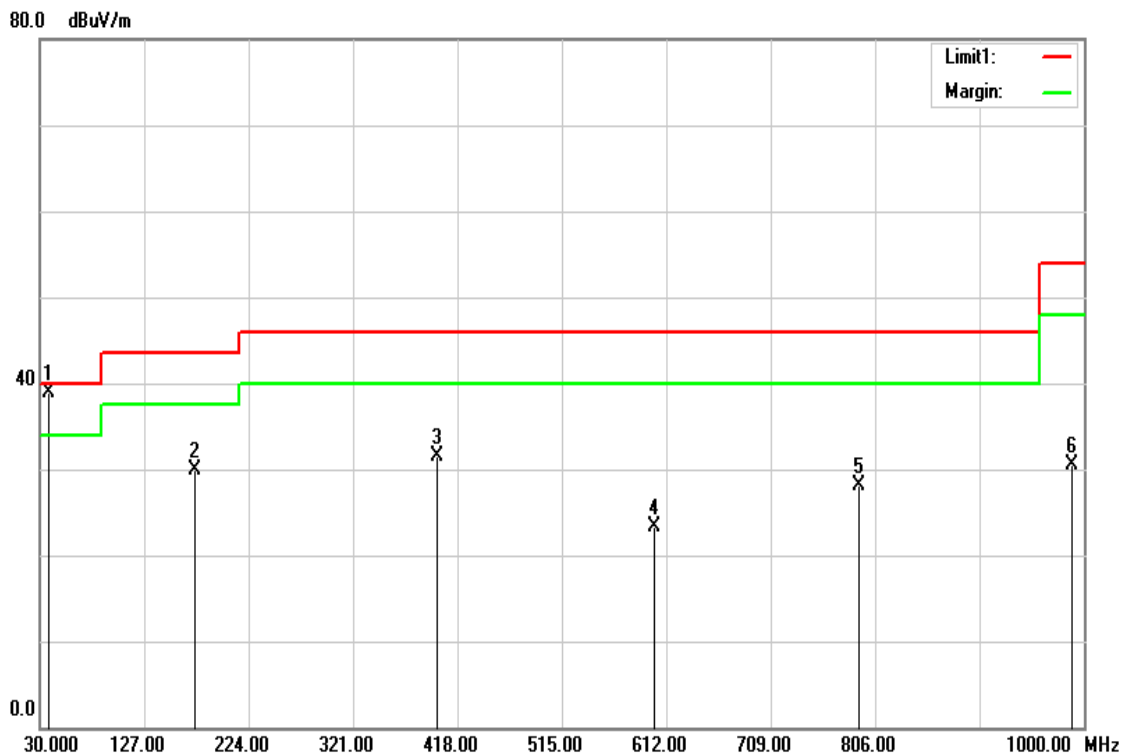

Frequency (MHz)	Reading (dBuV)	Correct Factor (dB/m)	Result (dBuV/m)	Limit (dBuV/m)	Margin (dB)	Remark
37.7600	52.53	-13.68	38.85	40.00	-1.15	QP
173.5600	46.96	-17.02	29.94	43.50	-13.56	Peak
399.5700	43.13	-11.71	31.42	46.00	-14.58	Peak
600.3600	30.97	-7.75	23.22	46.00	-22.78	Peak
791.4500	32.62	-4.57	28.05	46.00	-17.95	Peak
989.3300	32.28	-1.75	30.53	54.00	-23.47	Peak