

FCC Radio Test Report

FCC ID: A4C-10009A

This report concerns (check one): Original Grant Class II Change

Project No. : 1605099
Equipment : OverDryve 7
Test Model : OD7
Applicant : RM Acquisition, LLC
Address : 9855 Woods Drive Skokie, IL 60077 USA

Date of Receipt : May 20, 2016
Date of Test : May 20, 2016 ~ Jun. 01, 2016
Issued Date : Jun. 03, 2016
Tested by : BTL Inc.

Testing Engineer : Rush Kao
(Rush Kao)

Technical Manager : Jeff Yang
(Jeff Yang)

Authorized Signatory : Andy Chiu
(Andy Chiu)

B T L I N C .

B1, No.37, Lane 365, Yang Guang St.,
Nei-Hu District, Taipei City 114, Taiwan.
TEL:+886-2-2657-3299 FAX: +886-2- 2657-3331

Declaration

BTL represents to the client that testing is done in accordance with standard procedures as applicable and that test instruments used has been calibrated with standards traceable to international standard(s) and/or national standard(s).

BTL's reports apply only to the specific samples tested under conditions. It is manufacture's responsibility to ensure that additional production units of this model are manufactured with the identical electrical and mechanical components. **BTL** shall have no liability for any declarations, inferences or generalizations drawn by the client or others from **BTL** issued reports.

BTL's report must not be used by the client to claim product certification, approval, or endorsement by NVLAP, NIST, or any agency of the Federal Government.

This report is the confidential property of the client. As a mutual protection to the clients, the public and **BTL-self**, extracts from the test report shall not be reproduced except in full with **BTL's** authorized written approval.

BTL's laboratory quality assurance procedures are in compliance with the **ISO Guide 17025** requirements, and accredited by the conformity assessment authorities listed in this test report.

Limitation

For the use of the authority's logo is limited unless the Test Standard(s)/Scope(s)/Item(s) mentioned in this test report is (are) included in the conformity assessment authorities acceptance respective.

Table of Contents	Page
1 . CERTIFICATION	7
2 . SUMMARY OF TEST RESULTS	8
2.1 TEST FACILITY	8
2.2 MEASUREMENT UNCERTAINTY	9
3 . GENERAL INFORMATION	10
3.1 GENERAL DESCRIPTION OF EUT	10
3.2 DESCRIPTION OF TEST MODES	11
3.3 TABLE OF PARAMETERS OF TEXT SOFTWARE SETTING	12
3.4 BLOCK DIAGRAM SHOWING THE CONFIGURATION OF SYSTEM TESTED	13
3.5 DESCRIPTION OF SUPPORT UNITS	14
4 . EMC EMISSION TEST	15
4.1 CONDUCTED EMISSION MEASUREMENT	15
4.1.1 POWER LINE CONDUCTED EMISSION LIMITS	15
4.1.2 TEST PROCEDURE	15
4.1.3 DEVIATION FROM TEST STANDARD	15
4.1.4 TEST SETUP	16
4.1.5 EUT OPERATING CONDITIONS	16
4.1.6 EUT TEST CONDITIONS	16
4.1.7 TEST RESULTS	16
4.2 RADIATED EMISSION MEASUREMENT	17
4.2.1 RADIATED EMISSION LIMITS	17
4.2.2 TEST PROCEDURE	18
4.2.3 DEVIATION FROM TEST STANDARD	18
4.2.4 TEST SETUP	19
4.2.5 EUT OPERATING CONDITIONS	20
4.2.6 EUT TEST CONDITIONS	20
4.2.7 TEST RESULTS (9KHZ TO 30MHZ)	21
4.2.8 TEST RESULTS (30MHZ TO 1000 MHZ)	21
4.2.9 TEST RESULTS (1GHZ~10 TH HARMONIC)	21
4.3 BAND EDGE MEASUREMENT	22
4.3.1 RADIATED EMISSION LIMITS	22
4.3.2 TEST PROCEDURE	23
4.3.3 TEST SETUP LAYOUT	23
4.3.4 DEVIATION FROM TEST STANDARD	23
4.3.5 EUT OPERATING CONDITIONS	23
4.3.6 TEST RESULTS (BAND EDGE AND FUNDAMENTAL EMISSIONS)	23
5 . BANDWIDTH TEST	24
5.1 APPLIED PROCEDURES	24

Table of Contents	Page
5.1.1 TEST PROCEDURE	24
5.1.2 DEVIATION FROM STANDARD	24
5.1.3 TEST SETUP	24
5.1.4 EUT OPERATION CONDITIONS	24
5.1.5 EUT TEST CONDITIONS	24
5.1.6 TEST RESULTS	24
6 . MAXIMUM PEAK CONDUCTED OUTPUT POWER TEST	25
6.1 APPLIED PROCEDURES / LIMIT	25
6.1.1 TEST PROCEDURE	25
6.1.2 DEVIATION FROM STANDARD	25
6.1.3 TEST SETUP	25
6.1.4 EUT OPERATION CONDITIONS	25
6.1.5 EUT TEST CONDITIONS	25
6.1.6 TEST RESULTS	25
7 . ANTENNA CONDUCTED SPURIOUS EMISSION	26
7.1 APPLIED PROCEDURES / LIMIT	26
7.1.1 TEST PROCEDURE	26
7.1.2 DEVIATION FROM STANDARD	26
7.1.3 TEST SETUP	26
7.1.4 EUT OPERATION CONDITIONS	26
7.1.5 EUT TEST CONDITIONS	26
7.1.6 TEST RESULTS	26
8 . POWER SPECTRAL DENSITY TEST	27
8.1 APPLIED PROCEDURES / LIMIT	27
8.1.1 TEST PROCEDURE	27
8.1.2 DEVIATION FROM STANDARD	27
8.1.3 TEST SETUP	27
8.1.4 EUT OPERATION CONDITIONS	27
8.1.5 EUT TEST CONDITIONS	27
8.1.6 TEST RESULTS	27
9 . MEASUREMENT INSTRUMENTS LIST	28
10 . EUT TEST PHOTO	30
ATTACHMENT A - CONDUCTED EMISSION	35
ATTACHMENT B - RADIATED EMISSION (9KHZ TO 30MHZ)	38
ATTACHMENT C - RADIATED EMISSION (30MHZ TO 1000MHZ)	43
ATTACHMENT D - RADIATED EMISSION (1GHZ~10TH HARMONIC)	48
ATTACHMENT E - BAND EDGE AND FUNDAMENTAL EMISSIONS	67
ATTACHMENT F - BANDWIDTH	86

Table of Contents

Page

ATTACHMENT G – MAXIMUM PEAK CONDUCTED OUTPUT POWER	93
ATTACHMENT H - ANTENNA CONDUCTED SPURIOUS EMISSION	95
ATTACHMENT I - POWER SPECTRAL DENSITY	105

REPORT ISSUED HISTORY

Issued No.	Description	Issued Date
BTL-FCCP-1-1605099	Original Issue.	Jun. 03, 2016

1. CERTIFICATION

Equipment : OverDryve 7
Brand Name : RAND McNALLY
Test Model : OD7
Applicant : RM Acquisition, LLC
Date of Test : May 20, 2016 ~ Jun. 01, 2016
Test Sample : Engineering Sample
Standard(s) : FCC Part15, Subpart C (15.247) / ANSI C63.10-2013

The above equipment has been tested and found compliance with the requirement of the relative standards by BTL Inc.

The test data, data evaluation, and equipment configuration contained in our test report (Ref No. BTL-FCCP-1-1605099) were obtained utilizing the test procedures, test instruments, test sites that has been accredited by the Authority of TAF according to the ISO-17025 quality assessment standard and technical standard(s).

Test results included in this report is only for the 2.4G WIFI part.

2. SUMMARY OF TEST RESULTS

Test procedures according to the technical standard(s):

FCC Part15 (15.247), Subpart C			
Standard(s) Section	Test Item	Judgment	Remark
15.207	Conducted Emission	PASS	
15.247(d)	Antenna conducted Spurious Emission	PASS	
15.247(a)(2)	6dB Bandwidth	PASS	
15.247(b)(3)	Peak Output Power	PASS	
15.247(e)	Power Spectral Density	PASS	
15.203	Antenna Requirement	PASS	
15.209/15.205	Transmitter Radiated Emissions	PASS	
15.247(d)	Band Edge Emissions	PASS	

NOTE:

(1) "N/A" denotes test is not applicable in this test report.

2.1 TEST FACILITY

The test facilities used to collect the test data in this report:

Conducted emission Test:

C05: (VCCI RN: C-4742; FCC RN:965108; FCC DN:TW1082)

No. 68-1, Ln. 169, Sec.2, Datong Rd., Xizhi Dist., New Taipei City 221, Taiwan

Radiated emission Test (Below 1 GHz):

CB11: (VCCI RN: R-4260; FCC RN:949005; FCC DN:TW1082; IC Assigned Code:20088)

No. 68-1, Ln. 169, Sec.2, Datong Rd., Xizhi Dist., New Taipei City 221, Taiwan

Radiated emission Test (Above 1 GHz):

CB11: (VCCI RN: G-868; FCC RN:949005; FCC DN:TW1082; IC Assigned Code:20088)

No. 68-1, Ln. 169, Sec.2, Datong Rd., Xizhi Dist., New Taipei City 221, Taiwan

2.2 MEASUREMENT UNCERTAINTY

Where relevant, the following measurement uncertainty levels have been estimated for tests performed on the EUT as specified in CISPR 16-4-2. The BTL measurement uncertainty is less than the CISPR 16-4-2 U_{CISPR} requirement.

The reported uncertainty of measurement $y \pm U$, where expanded uncertainty U is based on a standard uncertainty multiplied by a coverage factor of $k=2$, providing a level of confidence of approximately 95 %.

A. Conducted emission test:

Test Site	Method	Measurement Frequency Range	U, (dB)
C05	CISPR	150 kHz~30MHz	2.04

B. Radiated emission test:

Test Site	Method	Measurement Frequency Range	U,(dB)
CB11 (3m)	CISPR	9kHz ~ 150kHz	4.00
		150kHz ~ 30MHz	4.00

Test Site	Method	Measurement Frequency Range	Ant. H / V	U,(dB)
CB11 (3m)	CISPR	30MHz ~ 200MHz	V	3.06
		30MHz ~ 200MHz	H	2.58
		200MHz ~ 1,000MHz	V	3.50
		200MHz ~ 1,000MHz	H	3.10

Test Site	Method	Measurement Frequency Range	Ant. H / V	U,(dB)
CB11 (3m)	CISPR	1GHz ~ 6GHz	V	4.14
		1GHz ~ 6GHz	H	4.14
		6GHz ~ 18GHz	V	5.34
		6GHz ~ 18GHz	H	5.34

Our calculated Measurement Instrumentation Uncertainty is shown in the tables above. These are our U_{lab} values in CISPR 16-4-2 terminology.

Since Table 1 of CISPR 16-4-2 has values of measurement instrumentation uncertainty, called U_{CISPR} , as follows:

Conducted Disturbance (mains port) – 150 kHz – 30 MHz: 3.6 dB

Radiated Disturbance (electric field strength on an open area test site or alternative test site) – 30 MHz – 1000 MHz: 5.2 dB

It can be seen that our U_{lab} values are smaller than U_{CISPR} .

Note: unless specifically mentioned, the uncertainty of measurement has not been taken into account to declare the compliance or non-compliance to the specification.

3. GENERAL INFORMATION

3.1 GENERAL DESCRIPTION OF EUT

Equipment	OverDryve 7		
Brand Name	RAND McNALLY		
Test Model	OD7		
Model Difference	N/A		
EUT Power Rating	I/P: DC 5V		
Power Adapter Manufacturer	Chicony	Model	W12-010N3A
	DVE	Model	DDA-18A-05 053350
Power Adapter Power Rating	For W12-010N3A I/P: AC 100-240V 50/60Hz 0.3A O/P: DC 5V 2A		
	For DDA-18A-05 053350 I/P: DC 12/24V 2A O/P: DC 5.3V 3.5A		
Battery Pack Manufacturer	McNair New Power	Model	MLP4110172
Product Description	Operation Frequency		2412~2462 MHz
	Modulation Technology		802.11b:DSSS 802.11g:OFDM 802.11n:OFDM
	Bit Rate of Transmitter		802.11b: 11/5.5/2/1 Mbps 802.11g: 54/48/36/24/18/12/9/6 Mbps 802.11n: MSC7
	Output Power (Max.)		802.11b: 17.75 dBm 802.11g: 21.96 dBm 802.11n(20MHz): 21.82 dBm

Note:

- For a more detailed features description, please refer to the manufacturer's specifications or the user's manual.
- Channel List:

802.11b, 802.11g, 802.11n(20MHz)							
Channel	Frequency (MHz)	Channel	Frequency (MHz)	Channel	Frequency (MHz)	Channel	Frequency (MHz)
01	2412	04	2427	07	2442	10	2457
02	2417	05	2432	08	2447	11	2462
03	2422	06	2437	09	2452		

3. Table for Filed Antenna

Ant.	Manufacturer	Model Name	Antenna Type	Connector	Gain (dBi)	Note
1	JIENG TAI	AH-JT-1575Y2211	PIFA	iPEX	1.67	TX/RX

3.2 DESCRIPTION OF TEST MODES

To investigate the maximum EMI emission characteristics generates from EUT, the test system was pre-scanning tested base on the consideration of following EUT operation mode or test configuration mode which possible have effect on EMI emission level. Each of these EUT operation mode(s) or test configuration mode(s) mentioned above was evaluated respectively.

Pretest Mode	Description
Mode 1	TX B MODE CHANNEL 01/06/11
Mode 2	TX G MODE CHANNEL 01/06/11
Mode 3	TX N-20MHZ MODE CHANNEL 01/06/11
Mode 4	TX Mode Note (6)

The EUT system operated these modes were found to be the worst case during the pre-scanning test as following:

For Conducted Test	
Final Test Mode	Description
Mode 4	TX Mode Note (6)

For Radiated Test	
Final Test Mode	Description
Mode 1	TX B MODE CHANNEL 01/06/11
Mode 2	TX G MODE CHANNEL 01/06/11
Mode 3	TX N-20MHZ MODE CHANNEL 01/06/11

Note:

- (1) The measurements are performed at the high, middle, low available channels.
- (2) 802.11b mode: DBPSK (1Mbps)
802.11g mode: OFDM (6Mbps)
802.11n HT20 mode : BPSK (13Mbps)
For radiated emission tests, the highest output powers were set for final test.
- (3) For radiated below 1G test, the 802.11b is found to be the worst case and recorded.
- (4) The EUT was programmed to be in continuously transmitting mode and the transmit duty cycle is not less than 98%.
- (5) The EUT was pre-tested on the positioned of each 3 axis. The worst case was found positioned on X-plane. Therefore only the test data of this X-plane was used for radiated emission measurement test.
- (6) The EUT includes two power sources: Adapter and Smart Mount + Adapter.
Power source Adapter is the worst mode for all test items.

3.3 TABLE OF PARAMETERS OF TEXT SOFTWARE SETTING

During testing, channel & power controlling software provided by the customer was used to control the operating channel as well as the output power level. The RF output power selection is for the setting of RF output power expected by the customer and is going to be fixed on the firmware of the final end product power parameters of WLAN

Test software version	Ampak RF Test Tool.VER:5.4		
Frequency (MHz)	2412	2437	2462
802.11b	DEF	DEF	DEF
802.11g	DEF	DEF	DEF
802.11n (20MHz)	DEF	DEF	DEF

3.4 BLOCK DIAGRAM SHOWING THE CONFIGURATION OF SYSTEM TESTED

Power source: Adapter

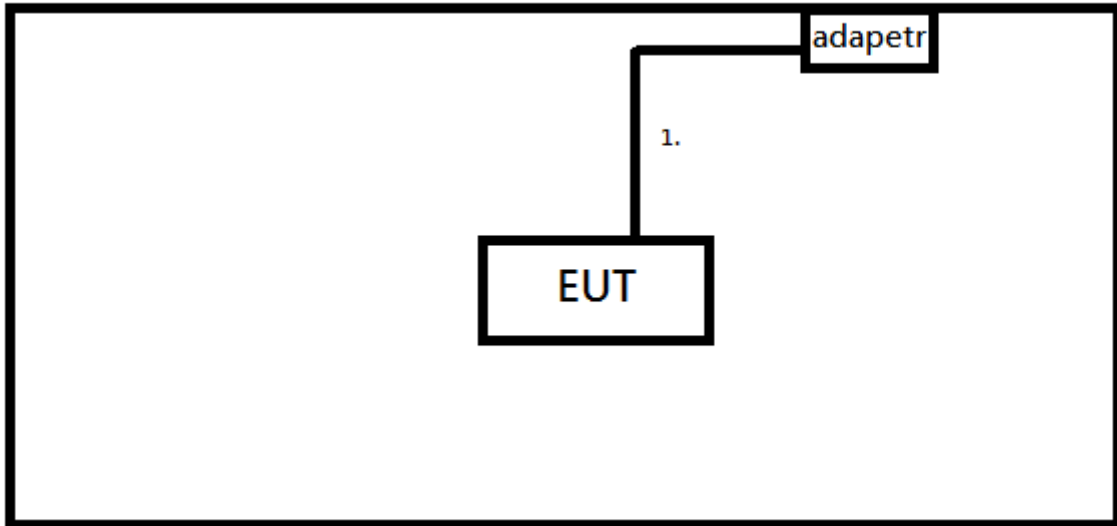

Power source: Smart Mount + Adapter

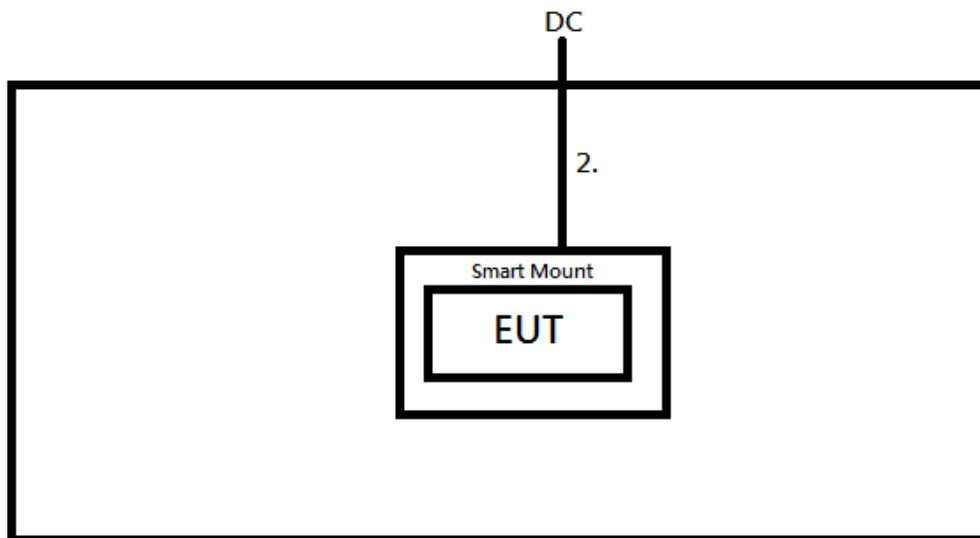

3.5 DESCRIPTION OF SUPPORT UNITS

The EUT has been tested as an independent unit together with other necessary accessories or support units. The following support units or accessories were used to form a representative test configuration during the tests.

Item	Equipment	Mfr/Brand	Model/Type No.	FCC ID	Series No.
-	-	-	-	-	-

Item	Shielded Type	Ferrite Core	Length	Note
1	YES	NO	0.8m	USB Cable
2	NO	NO	2m	DC Adapter

Note:

(1) The support equipment was authorized by Declaration of Conformity (DOC).

4. EMC EMISSION TEST

4.1 CONDUCTED EMISSION MEASUREMENT

4.1.1 POWER LINE CONDUCTED EMISSION LIMITS (Frequency Range 150KHz-30MHz)

Frequency of Emission (MHz)	Conducted Limit (dB μ V)	
	Quasi-peak	Average
0.15 -0.5	66 to 56*	56 to 46*
0.50 -5.0	56	46
5.0 -30.0	60	50

Note:

- (1) The limit of " * " decreases with the logarithm of the frequency
- (2) The test result calculated as following:
 Measurement Value = Reading Level + Correct Factor
 Correct Factor = Insertion Loss + Cable Loss + Attenuator Factor(if use)
 Margin Level = Measurement Value - Limit Value

The following table is the setting of the receiver

Receiver Parameters	Setting
Attenuation	10 dB
Start Frequency	0.15 MHz
Stop Frequency	30 MHz
IF Bandwidth	9 KHz

4.1.2 TEST PROCEDURE

- a. The EUT was placed 0.8 meters from the horizontal ground plane with EUT being connected to the power mains through a line impedance stabilization network (LISN). All other support equipments powered from additional LISN(s). The LISN provide 50 Ohm/ 50uH of coupling impedance for the measuring instrument.
- b. Interconnecting cables that hang closer than 40 cm to the ground plane shall be folded back and forth in the center forming a bundle 30 to 40 cm long.
- c. I/O cables that are not connected to a peripheral shall be bundled in the center. The end of the cable may be terminated, if required, using the correct terminating impedance. The overall length shall not exceed 1 m.
- d. LISN at least 80 cm from nearest part of EUT chassis.
- e. For the actual test configuration, please refer to the related Item –EUT Test Photos.

4.1.3 DEVIATION FROM TEST STANDARD

No deviation

4.1.4 TEST SETUP

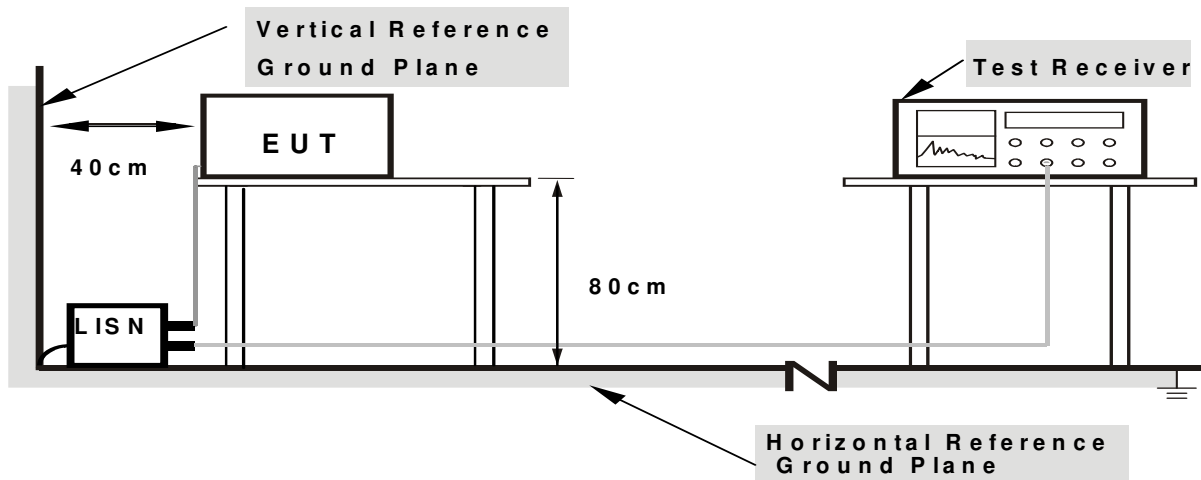

- Note: 1. Support units were connected to second LISN.
 2. Both of LISNs (AMN) are 80 cm from EUT and at least 80 cm from other units and other metal planes

4.1.5 EUT OPERATING CONDITIONS

The EUT was placed on the test table and programmed in normal function.

4.1.6 EUT TEST CONDITIONS

Temperature: 25°C Relative Humidity: 55% Test Voltage: AC 120V/60Hz

4.1.7 TEST RESULTS

Please refer to the Attachment A.

4.2 RADIATED EMISSION MEASUREMENT

4.2.1 RADIATED EMISSION LIMITS

In case the emission fall within the restricted band specified on 15.205(a), then the 15.209(a) limit in the table below has to be followed.

LIMITS OF RADIATED EMISSION MEASUREMENT (9KHz-1000MHz)

Frequency (MHz)	Field Strength (microvolts/meter)	Measurement Distance (meters)
0.009~0.490	2400/F(KHz)	300
0.490~1.705	24000/F(KHz)	30
1.705~30.0	30	30
30~88	100	3
88~216	150	3
216~960	200	3
960~1000	500	3

LIMITS OF RADIATED EMISSION MEASUREMENT (Above 1000MHz)

Frequency (MHz)	(dBuV/m) (at 3 meters)	
	PEAK	AVERAGE
Above 1000	74	54

Notes:

- (1) The limit for radiated test was performed according to FCC PART 15C.
- (2) The tighter limit applies at the band edges.
- (3) Emission level (dBuV/m)=20log Emission level (uV/m).
- (4) The test result calculated as following:
 Measurement Value = Reading Level + Correct Factor
 Correct Factor = Antenna Factor + Cable Loss - Amplifier Gain(if use)
 Margin Level = Measurement Value - Limit Value

Spectrum Parameter	Setting
Attenuation	Auto
Start Frequency	1000 MHz
Stop Frequency	10th carrier harmonic
RBW / VBW (Emission in restricted band)	1MHz / 3MHz for Peak, 1MHz / 1/T for Average

Receiver Parameter	Setting
Attenuation	Auto
Start ~ Stop Frequency	9KHz~90KHz for PK/AVG detector
Start ~ Stop Frequency	90KHz~110KHz for QP detector
Start ~ Stop Frequency	110KHz~490KHz for PK/AVG detector
Start ~ Stop Frequency	490KHz~30MHz for QP detector
Start ~ Stop Frequency	30MHz~1000MHz for QP detector

4.2.2 TEST PROCEDURE

- a. The measuring distance of 3 m shall be used for measurements. The EUT was placed on the top of a rotating table 0.8 meter above the ground at a 3 meter semi-anechoic chamber. The table was rotated 360 degrees to determine the position of the highest radiation.(below 1GHz)
- b. The measuring distance of 3 m shall be used for measurements. The EUT was placed on the top of a rotating table 1.5 meter above the ground at a 3 meter semi-anechoic chamber. The table was rotated 360 degrees to determine the position of the highest radiation.(above 1GHz)
- c. The height of the equipment or of the substitution antenna shall be 0.8 m or 1.5 m, the height of the test antenna shall vary between 1 m to 4 m. Both horizontal and vertical polarizations of the antenna are set to make the measurement.
- d. For each suspected emission, the EUT was arranged to its worst case and then the antenna was tuned to heights find the maximum reading (used Bore sight function).
- e. The receiver system was set to peak and average detect function and specified bandwidth with maximum hold mode when the test frequency is above 1GHz.
- f. The initial step in collecting radiated emission data is a receiver peak detector mode pre-scanning the measurement frequency range. Significant peaks are then marked and then Quasi Peak detector mode re-measured.
- g. All readings are Peak unless otherwise stated QP in column of Note. Peak denotes that the Peak reading compliance with the QP Limits and then QP Mode measurement didn't perform. (below 1GHz)
- h. All readings are Peak Mode value unless otherwise stated AVG in column of Note. If the Peak Mode Measured value compliance with the Peak Limits and lower than AVG Limits, the EUT shall be deemed to meet both Peak & AVG Limits and then only Peak Mode was measured, but AVG Mode didn't perform. (above 1GHz)
- i. For the actual test configuration, please refer to the related Item –EUT Test Photos.

4.2.3 DEVIATION FROM TEST STANDARD

No deviation

4.2.4 TEST SETUP

(A) Radiated Emission Test Set-Up Frequency Below 1 GHz

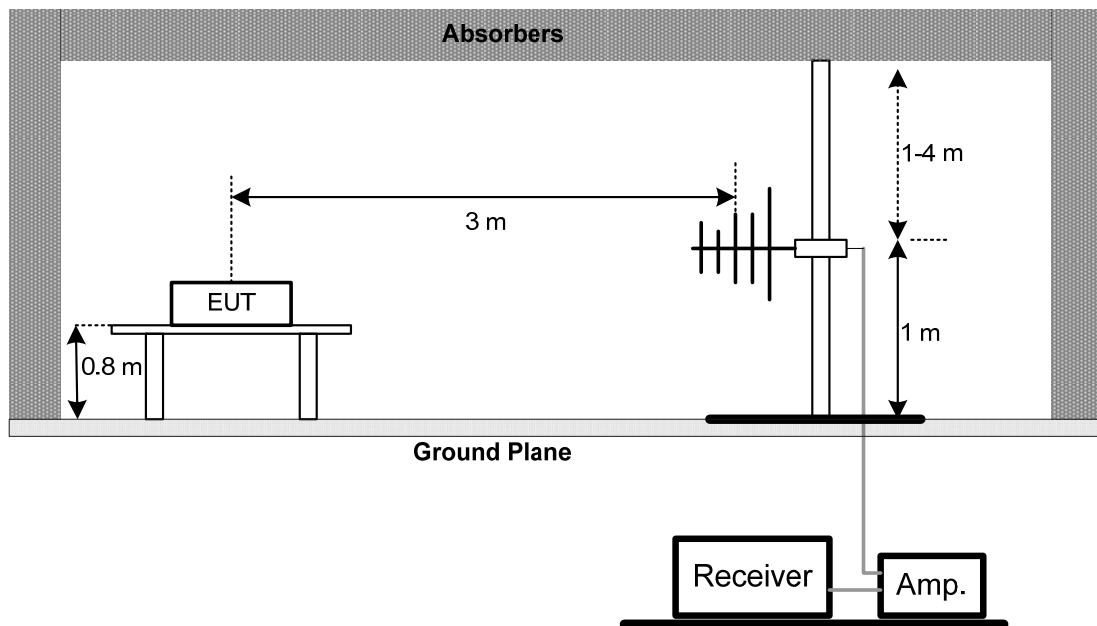

(B) Radiated Emission Test Set-Up Frequency Above 1 GHz

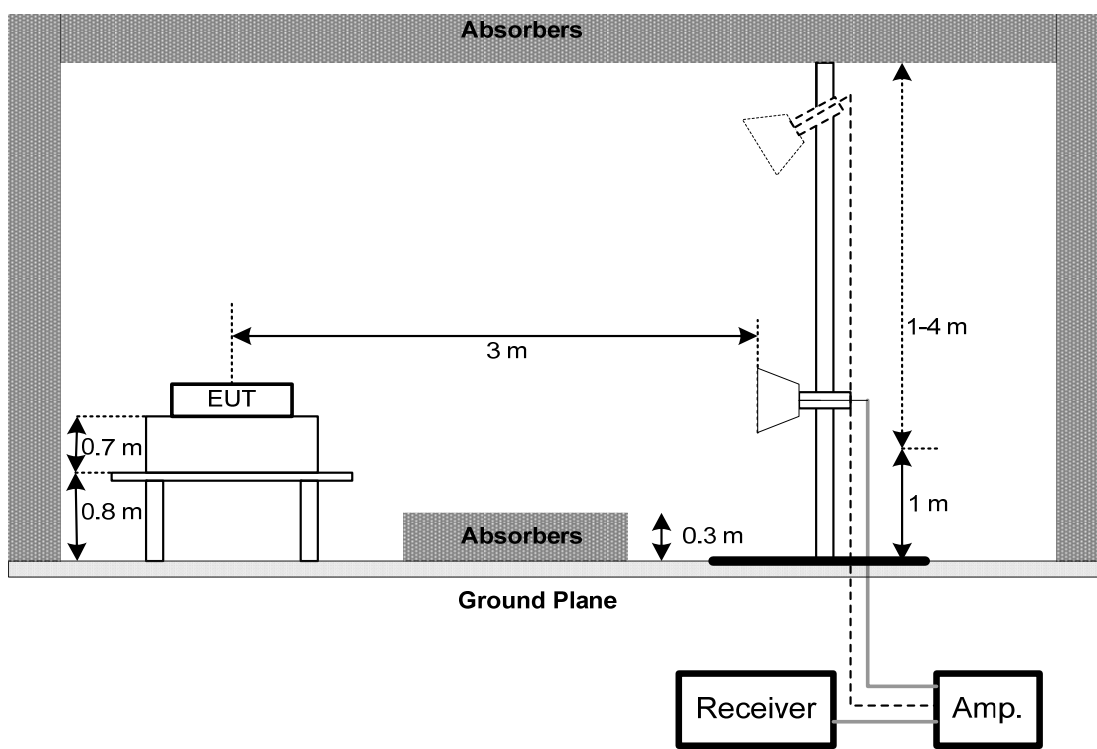

(C) For Radiated Emissions Below 30MHz

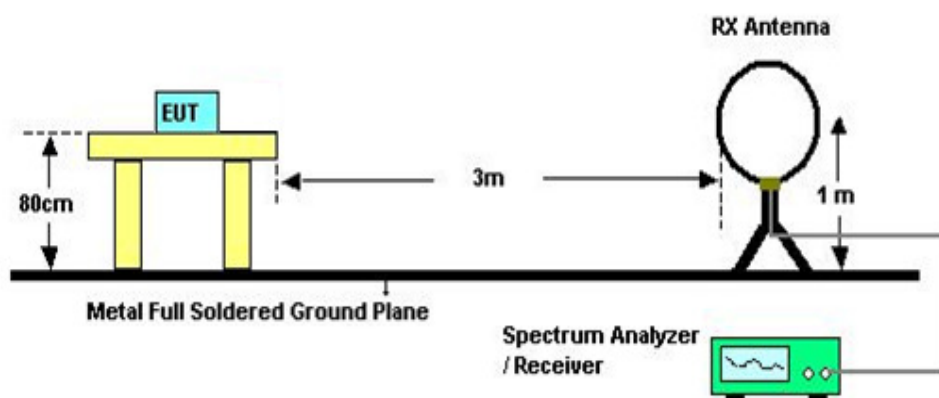

4.2.5 EUT OPERATING CONDITIONS

The EUT was programmed to be in continuously transmitting mode.

4.2.6 EUT TEST CONDITIONS

Temperature: 25°C Relative Humidity: 45% Test Voltage: AC 120V/60Hz

4.2.7 TEST RESULTS (9KHZ TO 30MHZ)

Please refer to the Attachment B

Remark:

- (1) The amplitude of spurious emissions which are attenuated by more than 20 dB below the permissible value has no need to be reported.
- (2) Distance extrapolation factor = $40 \log(\text{specific distance} / \text{test distance})$ (dB).
- (3) Limit line = specific limits (dBuV) + distance extrapolation factor.

4.2.8 TEST RESULTS (30MHZ TO 1000 MHZ)

Please refer to the Attachment C.

4.2.9 TEST RESULTS (1GHZ~10TH HARMONIC)

Please refer to the Attachment D.

Remark:

- (1) No limit: This is fundamental signal, the judgment is not applicable.
For fundamental signal judgment was referred to Peak output test.

4.3 BAND EDGE MEASUREMENT

4.3.1 RADIATED EMISSION LIMITS

In case the emission fall within the restricted band specified on 15.205(a), then the 15.209(a) limit in the table below has to be followed.

LIMITS OF RADIATED EMISSION MEASUREMENT (9KHz-1000MHz)

Frequency (MHz)	Field Strength (microvolts/meter)	Measurement Distance (meters)
0.009~0.490	2400/F(KHz)	300
0.490~1.705	24000/F(KHz)	30
1.705~30.0	30	30
30~88	100	3
88~216	150	3
216~960	200	3
960~1000	500	3

LIMITS OF RADIATED EMISSION MEASUREMENT (Above 1000MHz)

Frequency (MHz)	(dBuV/m) (at 3 meters)	
	PEAK	AVERAGE
Above 1000	74	54

Notes:

- (1) The limit for radiated test was performed according to FCC PART 15C.
- (2) The tighter limit applies at the band edges.
- (3) Emission level (dBuV/m)=20log Emission level (uV/m).
- (4) The test result calculated as following:
 Measurement Value = Reading Level + Correct Factor
 Correct Factor = Antenna Factor + Cable Loss - Amplifier Gain(if use)
 Margin Level = Measurement Value - Limit Value

Spectrum Parameter	Setting
Attenuation	Auto
Start Frequency	1000 MHz
Stop Frequency	10th carrier harmonic
RBW / VBW (Emission in restricted band)	1MHz / 3MHz for Peak, 1MHz / 1/T for Average

4.3.2 TEST PROCEDURE

For Radiated band edges Measurement:

- a. The test procedure is the same as section 4.2.2, only the frequency range investigated is limited to 100MHz around band edges.

For Radiated Out of Band Emission Measurement:

- a. Test was performed in accordance with KDB 558074 D01 v03r02 for Performing Compliance Measurements on Digital Transmission Systems (DTS) Operating Under §15.247 section 10.1 Unwanted Emissions into Non-Restricted Frequency Bands Measurement Procedure.

4.3.3 TEST SETUP LAYOUT

For Radiated band edges Measurement:

This test setup layout is the same as that shown in section 4.2.4.

For Radiated Out of Band Emission Measurement:

This test setup layout is the same as that shown in section 4.2.4.

4.3.4 DEVIATION FROM TEST STANDARD

No deviation

4.3.5 EUT OPERATING CONDITIONS

The EUT was programmed to be in continuously transmitting mode.

4.3.6 TEST RESULTS (BAND EDGE AND FUNDAMENTAL EMISSIONS)

Please refer to the Attachment E.

Remark:

- (1) No limit: This is fundamental signal, the judgment is not applicable.
For fundamental signal judgment was referred to Peak output test.

5. BANDWIDTH TEST

5.1 APPLIED PROCEDURES

FCC Part15 (15.247) , Subpart C			
Section	Test Item	Frequency Range (MHz)	Result
15.247(a)(2)	Bandwidth	2400-2483.5	PASS

5.1.1 TEST PROCEDURE

- a. The EUT was directly connected to the spectrum analyzer and antenna output port as show in the block diagram below,
- b. Spectrum Setting: RBW= 100KHz, VBW=300KHz, Sweep time = Auto.

5.1.2 DEVIATION FROM STANDARD

No deviation.

5.1.3 TEST SETUP



5.1.4 EUT OPERATION CONDITIONS

The EUT was programmed to be in continuously transmitting mode.

5.1.5 EUT TEST CONDITIONS

Temperature: 25°C Relative Humidity: 55% Test Voltage: AC 120V/60Hz

5.1.6 TEST RESULTS

Please refer to the Attachment F.

6. MAXIMUM PEAK CONDUCTED OUTPUT POWER TEST

6.1 APPLIED PROCEDURES / LIMIT

FCC Part15 (15.247) , Subpart C				
Section	Test Item	Limit	Frequency Range (MHz)	Result
15.247(b)(3)	Maximum Output Power	1 Watt or 30dBm	2400-2483.5	PASS

6.1.1 TEST PROCEDURE

- a. The EUT was directly connected to the power meter and antenna output port as show in the block diagram below,
- b. The maximum peak conducted output power was performed in accordance with method 9.1.2 of FCC KDB 558074 D01 DTS Meas Guidance v03r03.

6.1.2 DEVIATION FROM STANDARD

No deviation.

6.1.3 TEST SETUP



6.1.4 EUT OPERATION CONDITIONS

The EUT was programmed to be in continuously transmitting mode.

6.1.5 EUT TEST CONDITIONS

Temperature: 25°C Relative Humidity: 55% Test Voltage: AC 120V/60Hz

6.1.6 TEST RESULTS

Please refer to the Attachment G.

7. ANTENNA CONDUCTED SPURIOUS EMISSION

7.1 APPLIED PROCEDURES / LIMIT

In any 100 kHz bandwidth outside the frequency band in which the spread spectrum or digitally modulated device is operating, the RF power that is produced shall be at least 20 dB below that in the 100 kHz bandwidth within the band that contains the highest level of the desired power, based on either an RF conducted or a radiated measurement, provided that the transmitter demonstrates compliance with the peak conducted power limits.

7.1.1 TEST PROCEDURE

- a. The EUT was directly connected to the spectrum analyzer and antenna output port as show in the block diagram below,
- b. Spectrum Setting: RBW= 100KHz, VBW=300KHz, Sweep time = Auto.
- c. Offset=antenna gain+cable loss

7.1.2 DEVIATION FROM STANDARD

No deviation.

7.1.3 TEST SETUP



7.1.4 EUT OPERATION CONDITIONS

The EUT was programmed to be in continuously transmitting mode.

7.1.5 EUT TEST CONDITIONS

Temperature: 25°C Relative Humidity: 55% Test Voltage: AC 120V/60Hz

7.1.6 TEST RESULTS

Please refer to the Attachment H.

8. POWER SPECTRAL DENSITY TEST

8.1 APPLIED PROCEDURES / LIMIT

FCC Part15 (15.247) , Subpart C				
Section	Test Item	Limit	Frequency Range (MHz)	Result
15.247(e)	Power Spectral Density	8 dBm (in any 3KHz)	2400-2483.5	PASS

8.1.1 TEST PROCEDURE

- a. The EUT was directly connected to the spectrum analyzer and antenna output port as show in the block diagram below,
- b. Spectrum Setting: RBW=3KHz, VBW=10KHz, Sweep time = Auto.

8.1.2 DEVIATION FROM STANDARD

No deviation.

8.1.3 TEST SETUP

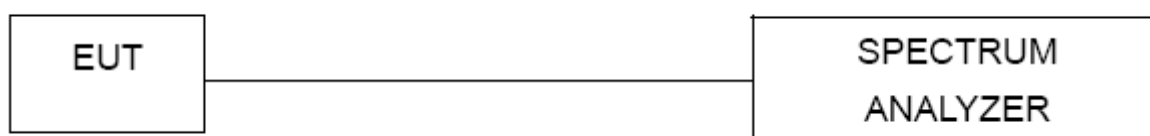

8.1.4 EUT OPERATION CONDITIONS

The EUT was programmed to be in continuously transmitting mode.

8.1.5 EUT TEST CONDITIONS

Temperature: 25°C Relative Humidity: 55% Test Voltage: AC 120V/60Hz

8.1.6 TEST RESULTS

Please refer to the Attachment I.

9. MEASUREMENT INSTRUMENTS LIST

Conducted Emission Measurement					
Item	Kind of Equipment	Manufacturer	Type No.	Serial No.	Calibrated until
1	TWO-LINE V-NETWORK	R&S	ENV216	101050	Jan. 26, 2017
2	Test Cable	TIMES	CFD300-NL	C02	Jun. 14, 2016
3	EMI Test Receiver	R&S	ESR7	101433	Dec. 09, 2016
4	Power Dividers	HP	11636A	8103	May 03, 2017
5	Measurement Software	EZ	EZ EMC (Version NB-03A)	N/A	N/A

Radiated Emission & Band edge Measurement					
Item	Kind of Equipment	Manufacturer	Type No.	Serial No.	Calibrated until
1	Log-Bicon Antenna	Schwarzbeck	VULB9168-352	9168-352	Jul. 30, 2016
2	Horn Antenna	Schwarzbeck	BBHA 9120	D-325	Apr. 19, 2017
3	Horn Antenna	Schwarzbeck	BBHA 9120	9120D-1333	May 19, 2017
4	Pre-Amplifier	Anritsu	MH648A	M92649	Jun. 16, 2016
5	Pre-Amplifier	Agilent	8449B	3008A01714	Apr. 13, 2017
6	Test Cable	LMR	LMR-400	01(10M)	May 11, 2017
7	Test Cable	LMR	LMR-400	01(3M)	May 11, 2017
8	Test Cable	Harbour industries	27478LL142	1M	May 12, 2017
9	Test Cable	Harbour industries	27478LL142	3M	May 12, 2017
10	Test Cable	AISI	S104-SMAP-1	8M	May 12, 2017
11	Spectrum Analyzer	Agilent	N9020A	MY51160196	Aug. 02, 2016
12	EMI Test Receiver	R&S	ESCI	100080	May 12, 2017
13	Measurement Software	Farad	EZ EMC (Version NB-03A)	N/A	N/A
14	Loop Ant	EMCO	6502	42960	Nov. 15, 2016

6dB Bandwidth Measurement					
Item	Kind of Equipment	Manufacturer	Type No.	Serial No.	Calibrated until
1	Spectrum Analyzer	R&S	FSP-40	100129	Jan. 17, 2017

Peak Output Power Measurement					
Item	Kind of Equipment	Manufacturer	Type No.	Serial No.	Calibrated until
1	Power Meter	Anritsu	ML2487A	6K00004714	May 18, 2017
2	Power Meter Sensor	Anritsu	MA2491A	034138	May 17, 2017

Antenna Conducted Spurious Emission Measurement					
Item	Kind of Equipment	Manufacturer	Type No.	Serial No.	Calibrated until
1	Spectrum Analyzer	R&S	FSP-40	100129	Jan. 17, 2017

Power Spectral Density Measurement					
Item	Kind of Equipment	Manufacturer	Type No.	Serial No.	Calibrated until
1	Spectrum Analyzer	R&S	FSP-40	100129	Jan. 17, 2017

Remark: "N/A" denotes no model name, serial no. or calibration specified.
 All calibration period of equipment list is one year.

10. EUT TEST PHOTO

Conducted Measurement Photos With Adapter_W12-010N3A

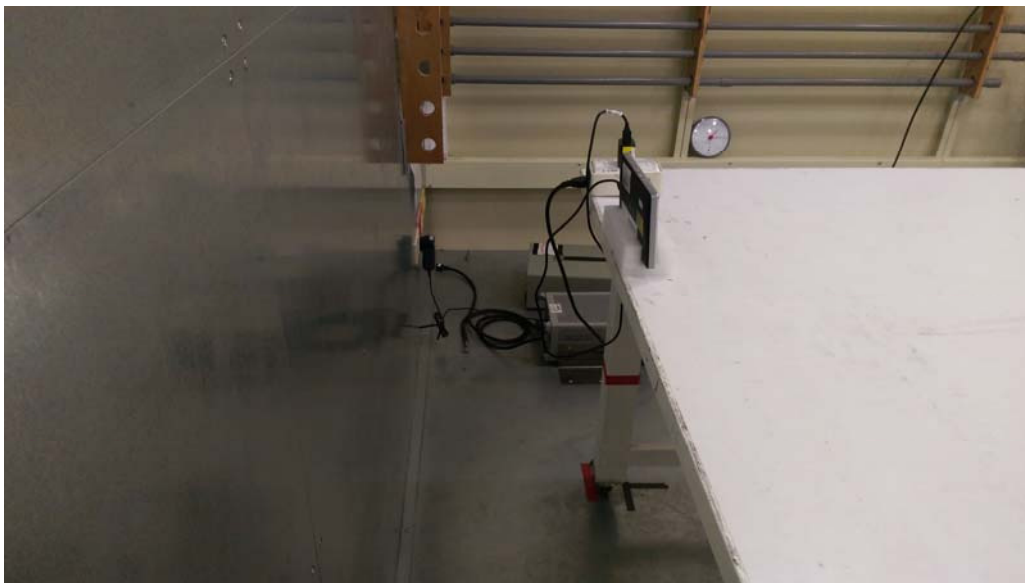
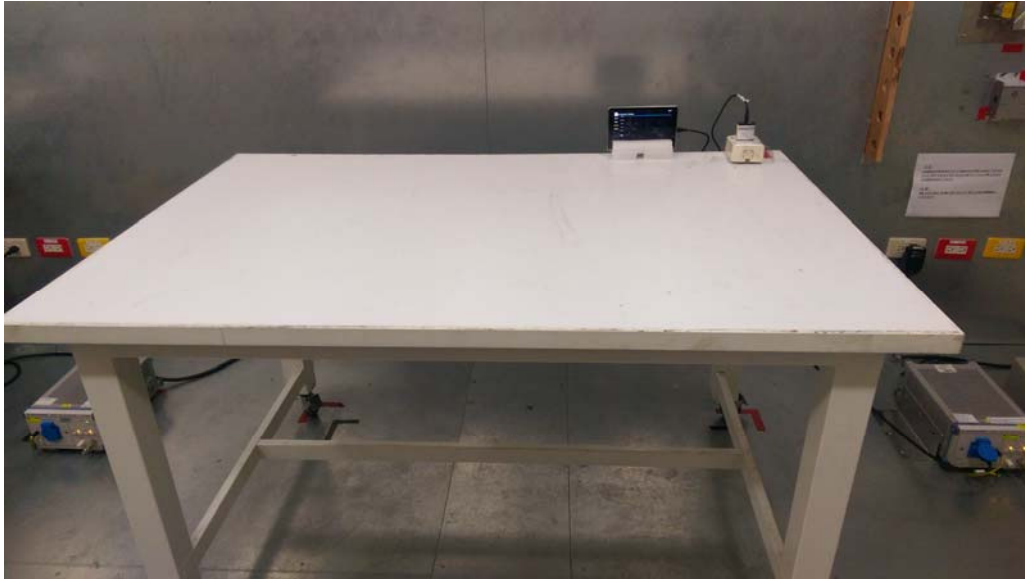

**Radiated Measurement Photos
9KHz to 30MHz
With Adapter_W12-010N3A**

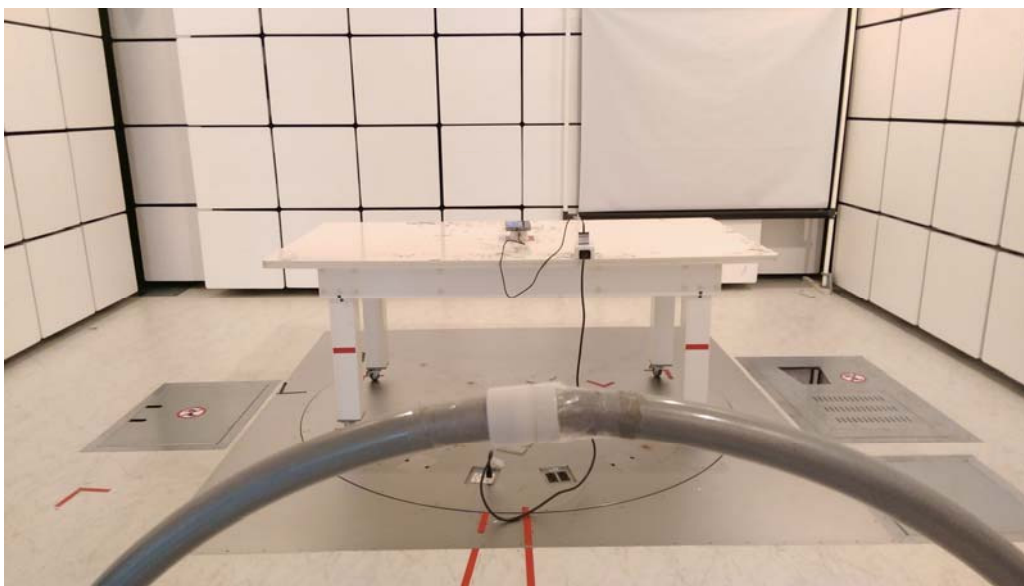
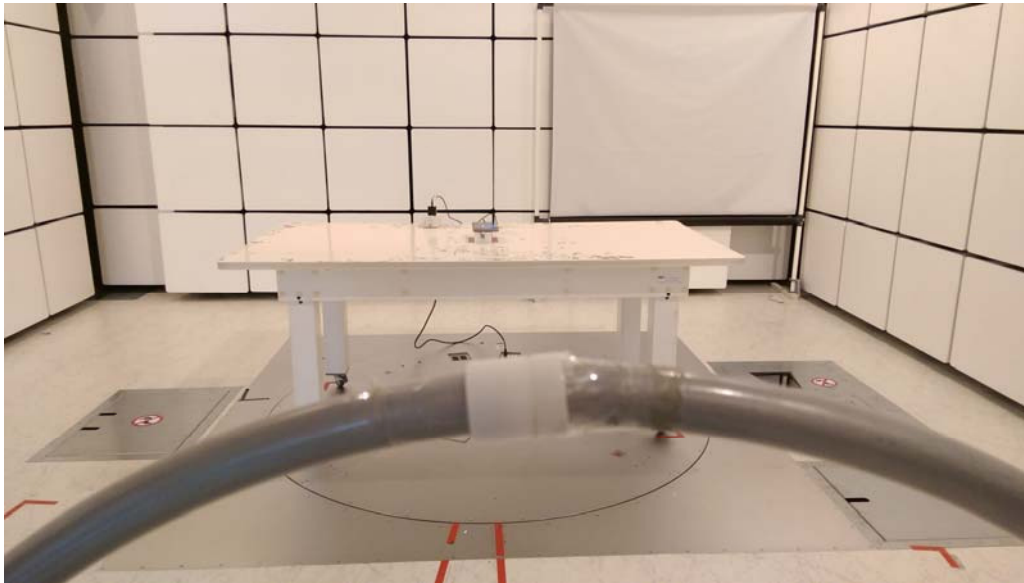

**Radiated Measurement Photos
30MHz to 1000MHz
With Adapter_W12-010N3A**

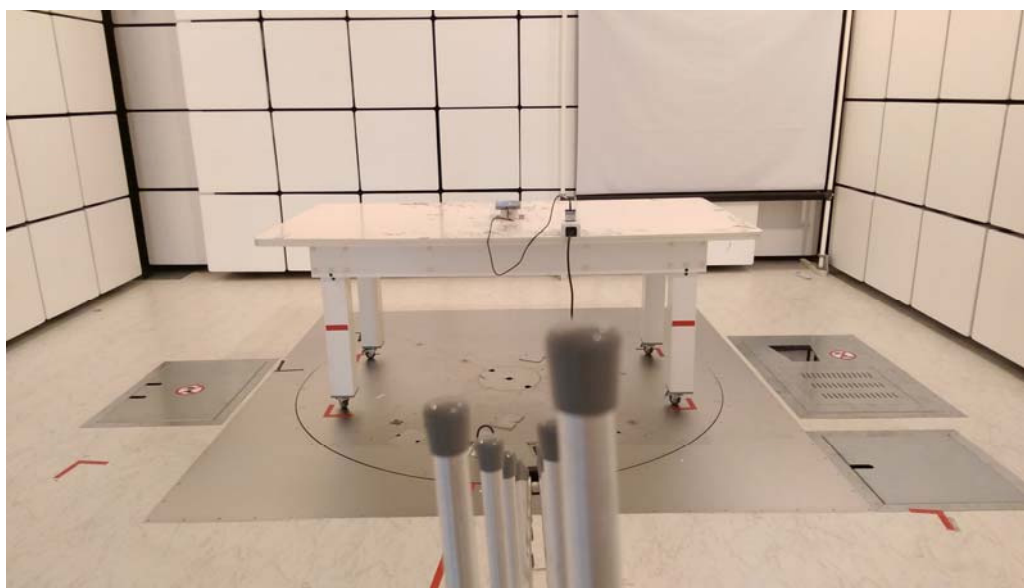
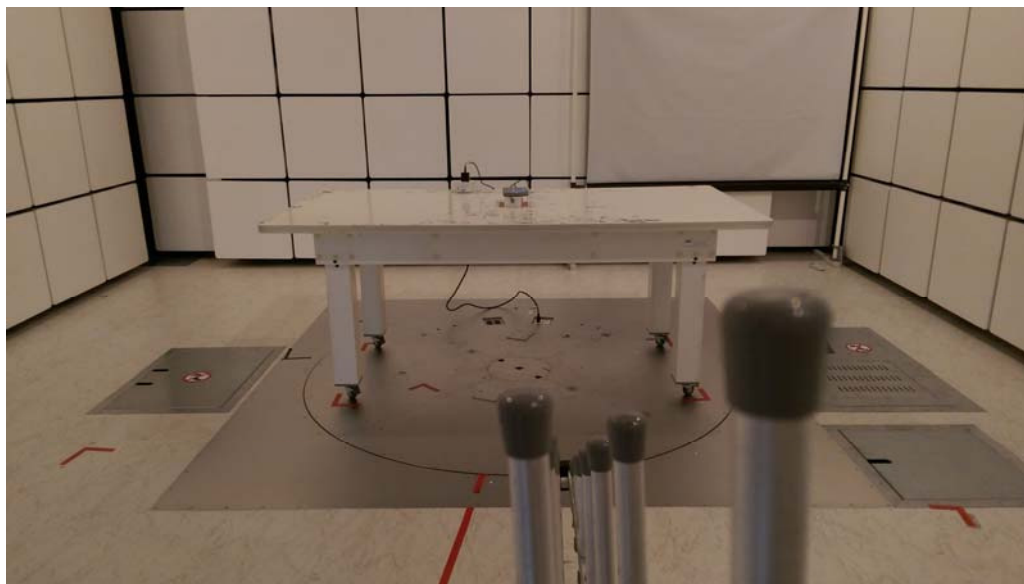

**Radiated Measurement Photos
30MHz to 1000MHz
With Smart Mount + Adapter_DDA-18A-05 053350**

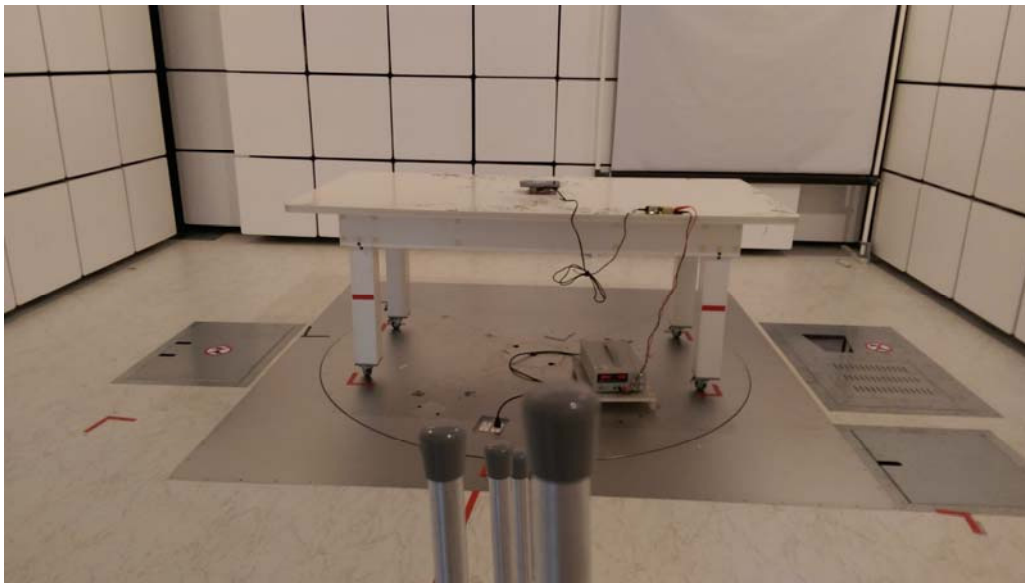
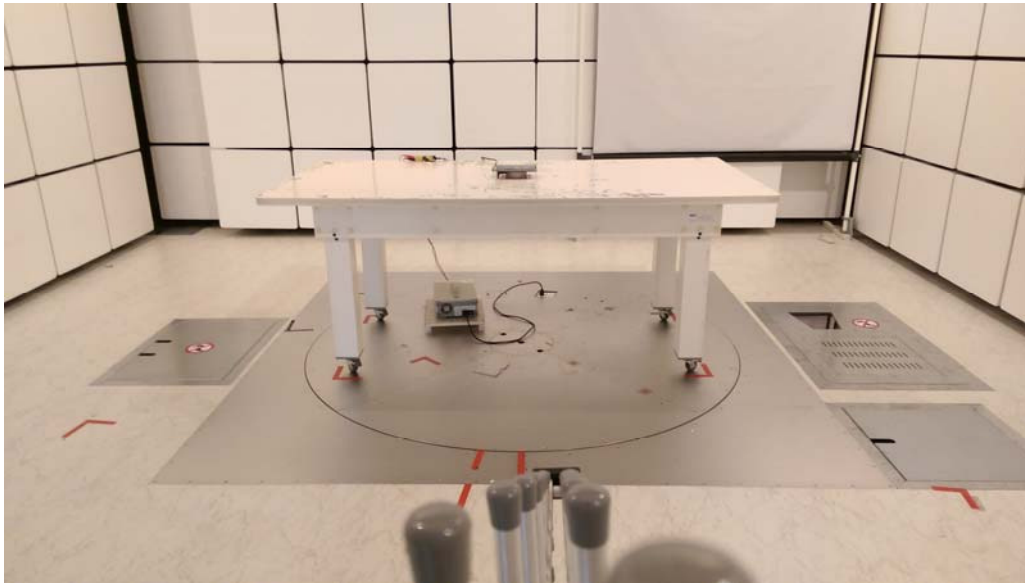

**Radiated Measurement Photos
Above 1000MHz
With Adapter_W12-010N3A**



ATTACHMENT A - CONDUCTED EMISSION

Test Mode: TX Mode_Adapter_W12-010N3A

Line

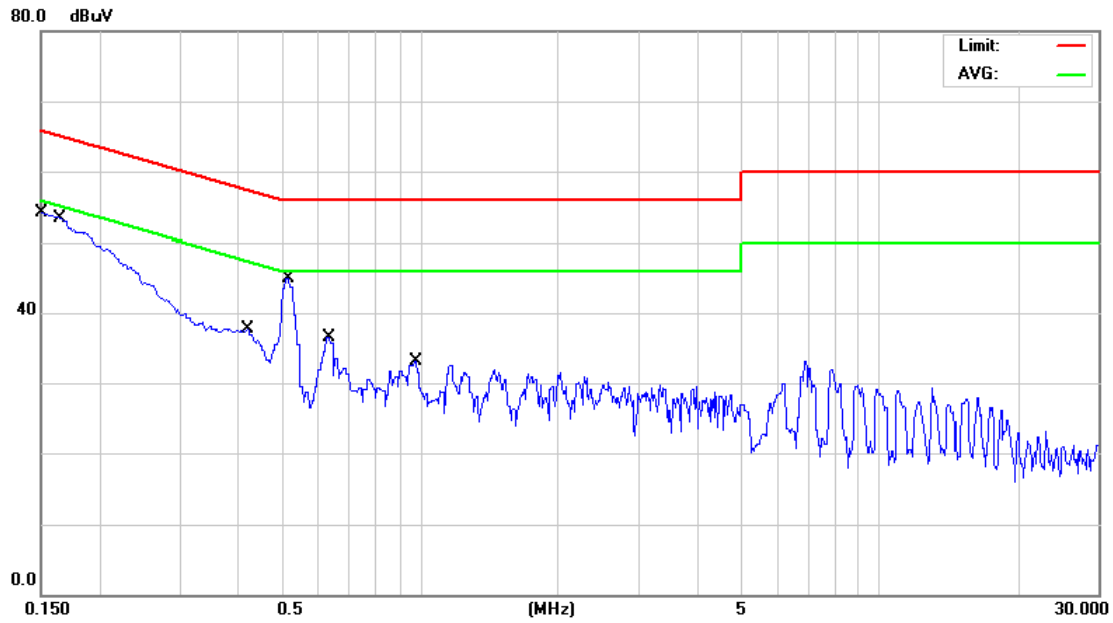

No.	Mk.	Freq. MHz	Reading Level dBuV	Correct Factor dB	Measure- ment dBuV	Limit dBuV	Margin dB	Detector	Comment
1		0.1507	37.10	9.68	46.78	65.96	-19.18	QP	
2		0.1507	18.80	9.68	28.48	55.96	-27.48	AVG	
3		0.1668	34.50	9.68	44.18	65.11	-20.93	QP	
4		0.1668	16.20	9.68	25.88	55.11	-29.23	AVG	
5		0.4202	20.70	9.68	30.38	57.44	-27.06	QP	
6		0.4202	10.40	9.68	20.08	47.44	-27.36	AVG	
7		0.5180	32.30	9.69	41.99	56.00	-14.01	QP	
8	*	0.5180	22.50	9.69	32.19	46.00	-13.81	AVG	
9		0.6350	20.80	9.70	30.50	56.00	-25.50	QP	
10		0.6350	8.10	9.70	17.80	46.00	-28.20	AVG	
11		0.9770	15.40	9.71	25.11	56.00	-30.89	QP	
12		0.9770	5.00	9.71	14.71	46.00	-31.29	AVG	

Test Mode: TX Mode_Adapter_W12-010N3A

Neutral

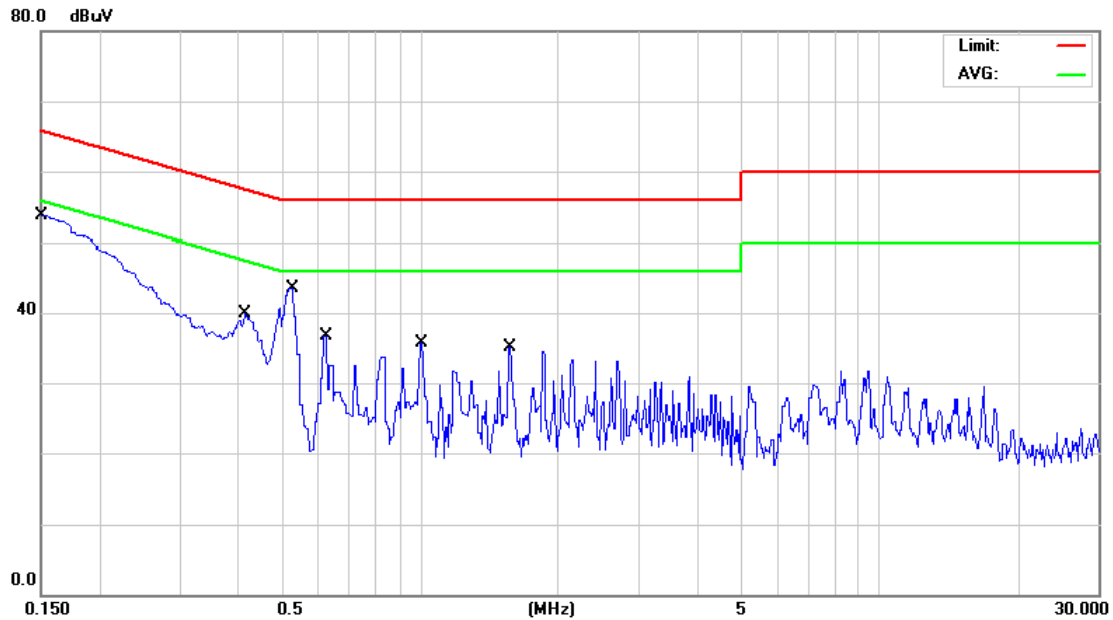

No.	Mk.	Freq. MHz	Reading Level dBuV	Correct Factor dB	Measure- ment dBuV	Limit dBuV	Margin dB	Detector	Comment
1		0.1500	37.00	9.69	46.69	65.99	-19.30	QP	
2		0.1500	18.70	9.69	28.39	55.99	-27.60	AVG	
3		0.4167	21.30	9.68	30.98	57.51	-26.53	QP	
4		0.4167	11.90	9.68	21.58	47.51	-25.93	AVG	
5		0.5270	31.10	9.69	40.79	56.00	-15.21	QP	
6	*	0.5270	21.60	9.69	31.29	46.00	-14.71	AVG	
7		0.6260	15.41	9.69	25.10	56.00	-30.90	QP	
8		0.6260	6.91	9.69	16.60	46.00	-29.40	AVG	
9		1.0040	13.00	9.72	22.72	56.00	-33.28	QP	
10		1.0040	3.00	9.72	12.72	46.00	-33.28	AVG	
11		1.5620	15.50	9.76	25.26	56.00	-30.74	QP	
12		1.5620	5.50	9.76	15.26	46.00	-30.74	AVG	

ATTACHMENT B - RADIATED EMISSION (9KHZ TO 30MHZ)

Test Mode: TX_Adapter_W12-010N3A

OPEN

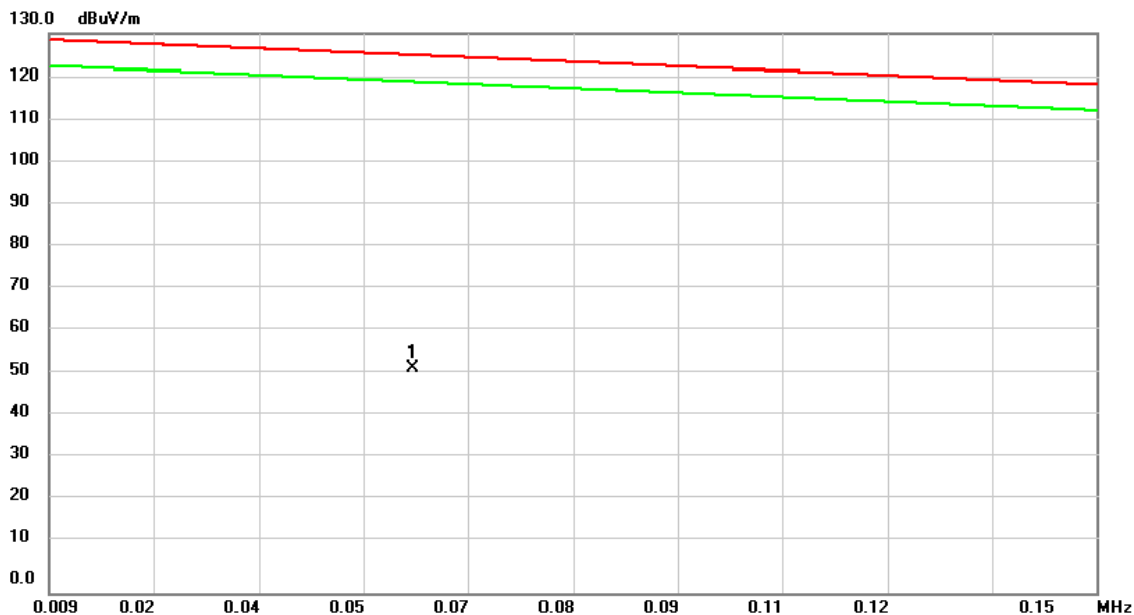

No.	Mk.	Freq. MHz	Reading Level dBuV	Correct Factor dB	Measure- ment dBuV/m	Limit dBuV/m	Over dB	Detector	Comment
1	*	0.0580	39.60	12.86	52.46	124.98	-72.52	peak	

Test Mode: TX_Adapter_W12-010N3A

OPEN

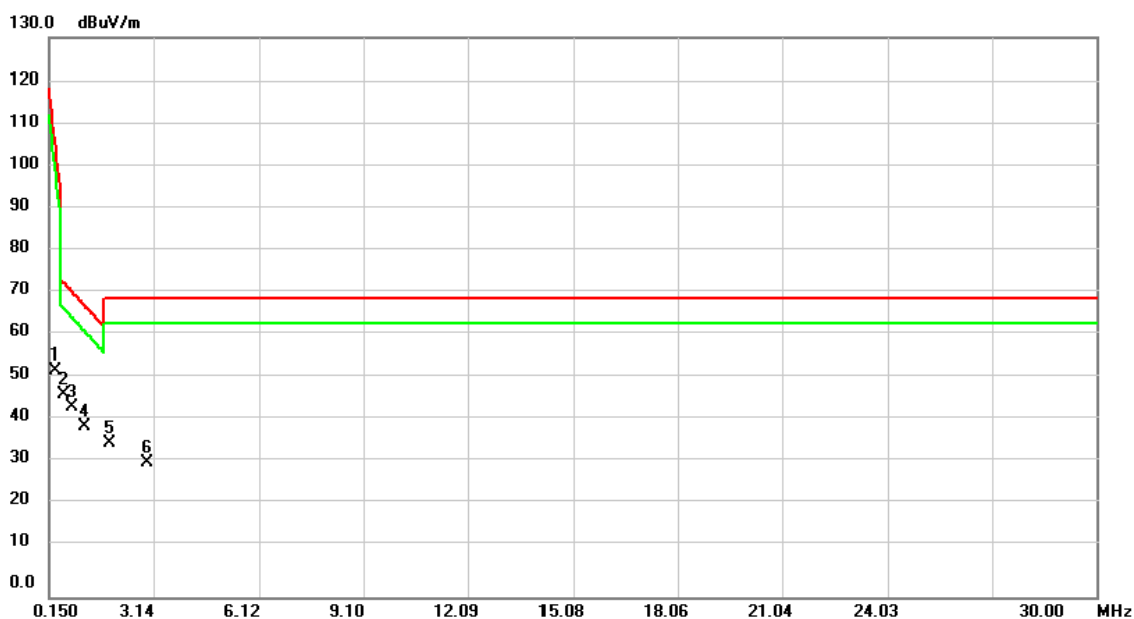

No.	Mk.	Freq. MHz	Reading Level dBuV	Correct Factor dB	Measure- ment dBuV/m	Limit dBuV/m	Over dB	Detector	Comment
1		0.3291	40.93	11.80	52.73	105.41	-52.68	peak	
2	*	0.5675	35.40	11.83	47.23	73.11	-25.88	peak	
3		0.8064	32.31	11.92	44.23	70.98	-26.75	peak	
4		1.1650	28.03	11.93	39.96	67.78	-27.82	peak	
5		1.8810	24.44	11.60	36.04	69.54	-33.50	peak	
6		2.9560	20.15	11.12	31.27	69.54	-38.27	peak	

Test Mode: TX_Adapter_W12-010N3A

CLOSE

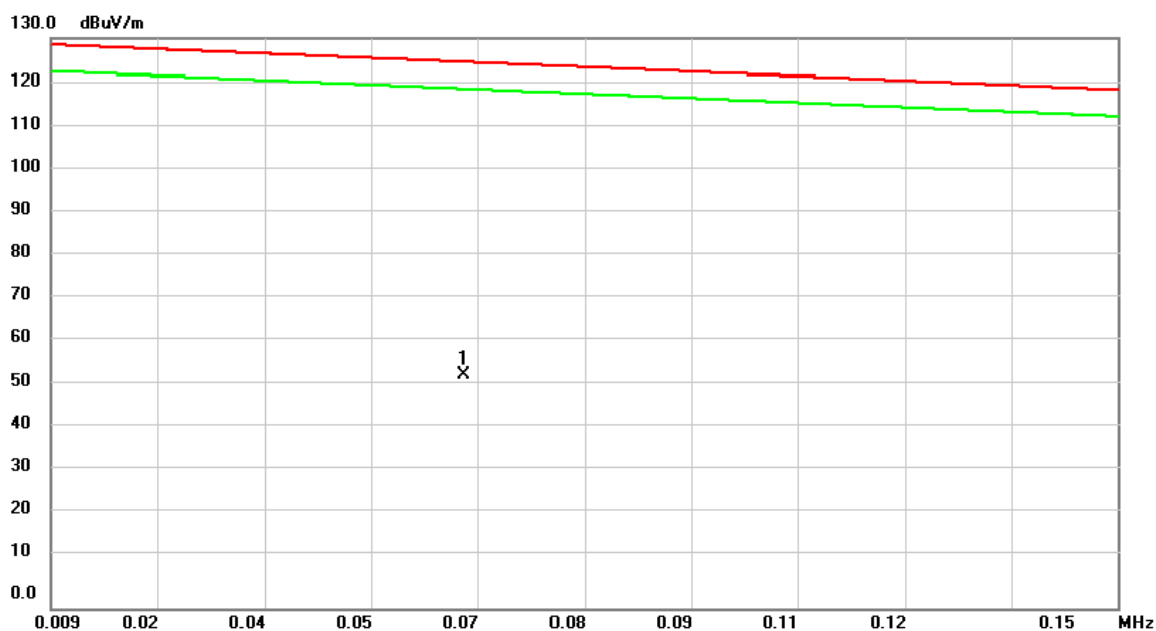

No.	Mk.	Freq. MHz	Reading Level dBuV	Correct Factor dB	Measure- ment dBuV/m	Limit dBuV/m	Over dB	Detector	Comment
1	*	0.0637	40.61	12.75	53.36	124.57	-71.21	peak	

Test Mode: TX_Adapter_W12-010N3A

CLOSE



No.	Mk.	Freq. MHz	Reading Level dBuV	Correct Factor dB	Measure- ment dBuV/m	Limit dBuV/m	Over dB	Detector	Comment
1		0.1800	46.94	11.98	58.92	116.18	-57.26	peak	
2	*	0.5675	35.78	11.83	47.61	73.11	-25.50	peak	
3		1.5230	26.24	11.76	38.00	64.59	-26.59	peak	
4		2.8664	21.25	11.16	32.41	69.54	-37.13	peak	
5		3.9410	18.34	11.24	29.58	69.54	-39.96	peak	
6		5.2842	16.97	11.39	28.36	69.54	-41.18	peak	

ATTACHMENT C - RADIATED EMISSION (30MHZ TO 1000MHZ)

Test Mode: TX_Adapter_W12-010N3A

Vertical

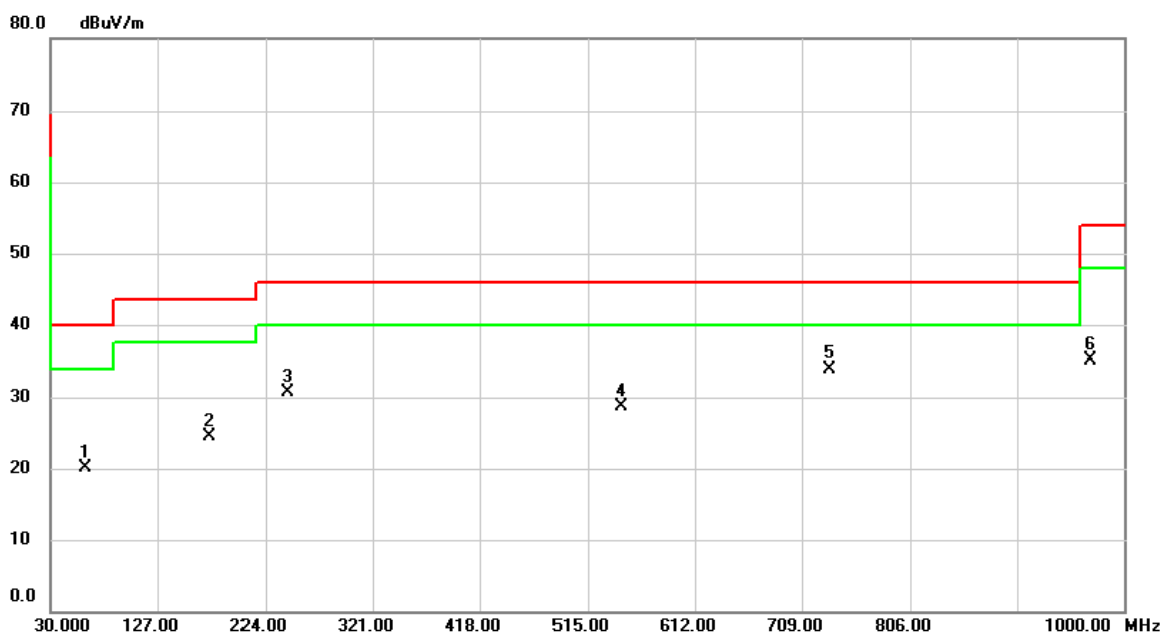

No.	Mk.	Freq. MHz	Reading Level dBuV	Correct Factor dB	Measure- ment dBuV/m	Limit dBuV/m	Over dB	Detector	Comment
1		61.0400	29.09	-9.00	20.09	40.00	-19.91	peak	
2		174.5300	33.80	-9.33	24.47	43.50	-19.03	peak	
3		244.3700	40.05	-9.33	30.72	46.00	-15.28	peak	
4		545.0700	30.26	-1.65	28.61	46.00	-17.39	peak	
5	*	734.2200	31.89	2.01	33.90	46.00	-12.10	peak	
6		969.9300	29.35	5.75	35.10	54.00	-18.90	peak	

Test Mode: TX_Adapter_W12-010N3A

Horizontal

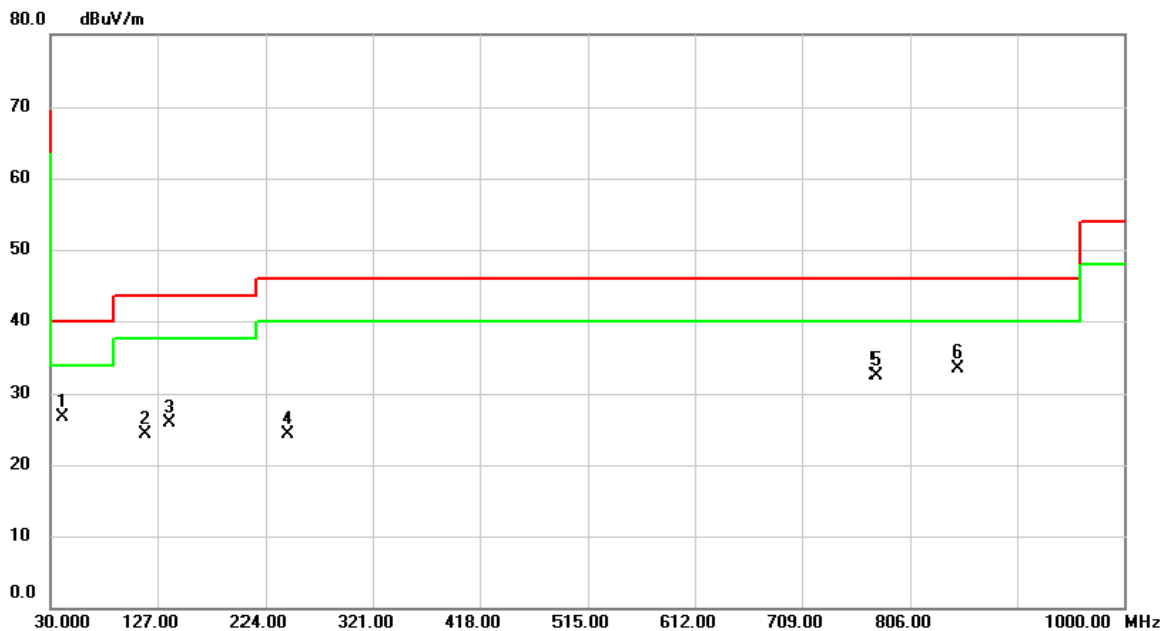

No.	Mk.	Freq. MHz	Reading Level dBuV	Correct Factor dB	Measure- ment dBuV/m	Limit dBuV/m	Over dB	Detector	Comment
1		40.6700	35.25	-8.61	26.64	40.00	-13.36	peak	
2		116.3300	35.07	-10.70	24.37	43.50	-19.13	peak	
3		137.6700	34.69	-8.86	25.83	43.50	-17.67	peak	
4		244.3700	33.60	-9.33	24.27	46.00	-21.73	peak	
5		775.9300	29.94	2.62	32.56	46.00	-13.44	peak	
6	*	848.6800	29.84	3.58	33.42	46.00	-12.58	peak	

Test Mode: TX_Smart Mount + Adapter_ DDA-18A-05 053350

Vertical

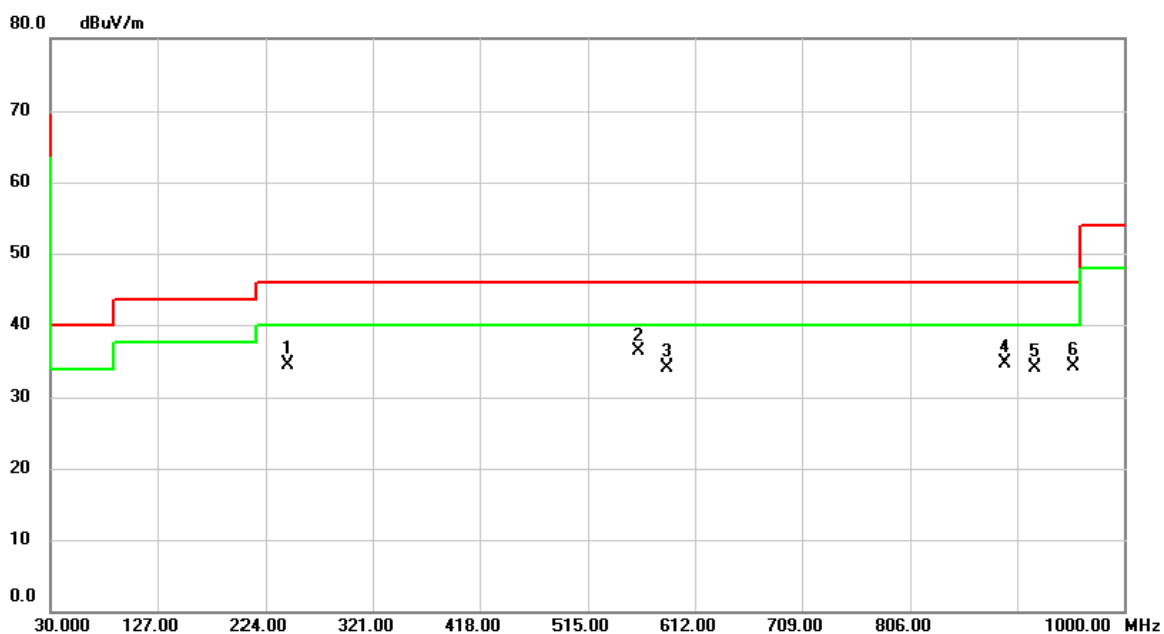

No.	Mk.	Freq. MHz	Reading Level dBuV	Correct Factor dB	Measure- ment dBuV/m	Limit dBuV/m	Over dB	Detector	Comment
1		244.3700	43.93	-9.33	34.60	46.00	-11.40	peak	
2	*	560.5900	37.66	-1.26	36.40	46.00	-9.60	peak	
3		586.7800	34.66	-0.57	34.09	46.00	-11.91	peak	
4		892.3300	30.22	4.46	34.68	46.00	-11.32	peak	
5		919.4900	29.06	4.95	34.01	46.00	-11.99	peak	
6		954.4100	28.78	5.55	34.33	46.00	-11.67	peak	

Test Mode: TX_Smart Mount + Adapter_ DDA-18A-05 053350

Horizontal

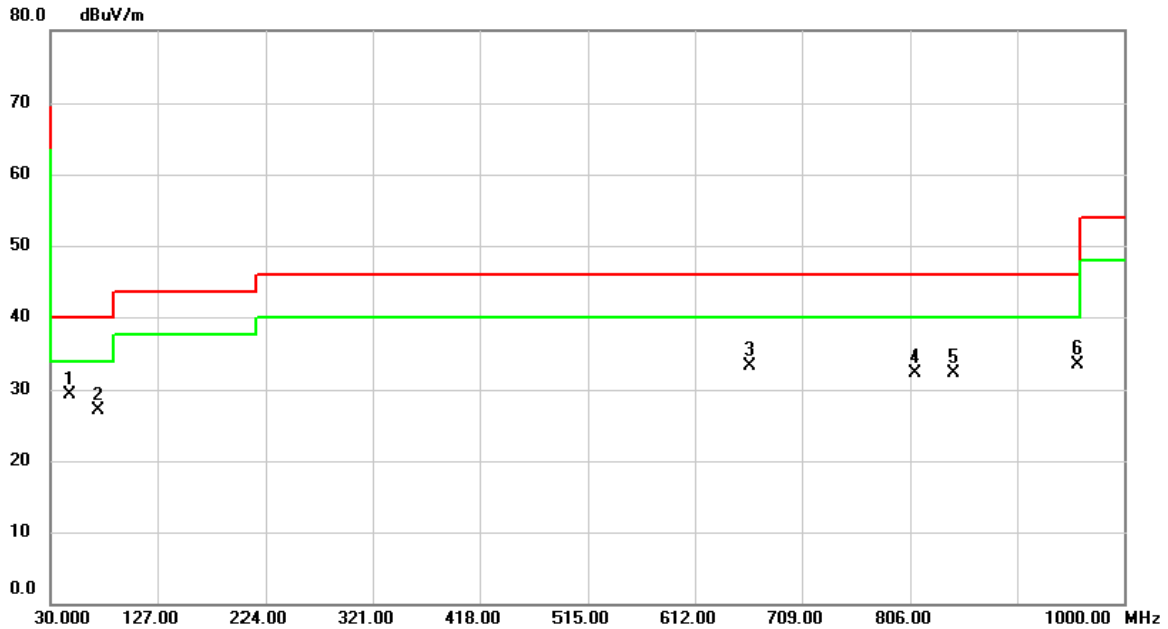

No.	Mk.	Freq. MHz	Reading Level dBuV	Correct Factor dB	Measure- ment dBuV/m	Limit dBuV/m	Over dB	Detector	Comment
1	*	47.4600	37.63	-8.25	29.38	40.00	-10.62	peak	
2		73.6500	38.15	-11.13	27.02	40.00	-12.98	peak	
3		661.4700	32.91	0.44	33.35	46.00	-12.65	peak	
4		809.8800	29.36	3.03	32.39	46.00	-13.61	peak	
5		845.7700	28.78	3.54	32.32	46.00	-13.68	peak	
6		957.3200	27.86	5.59	33.45	46.00	-12.55	peak	

ATTACHMENT D - RADIATED EMISSION (1GHZ~10TH HARMONIC)

Test Mode: TX B MODE 2412MHz

Vertical

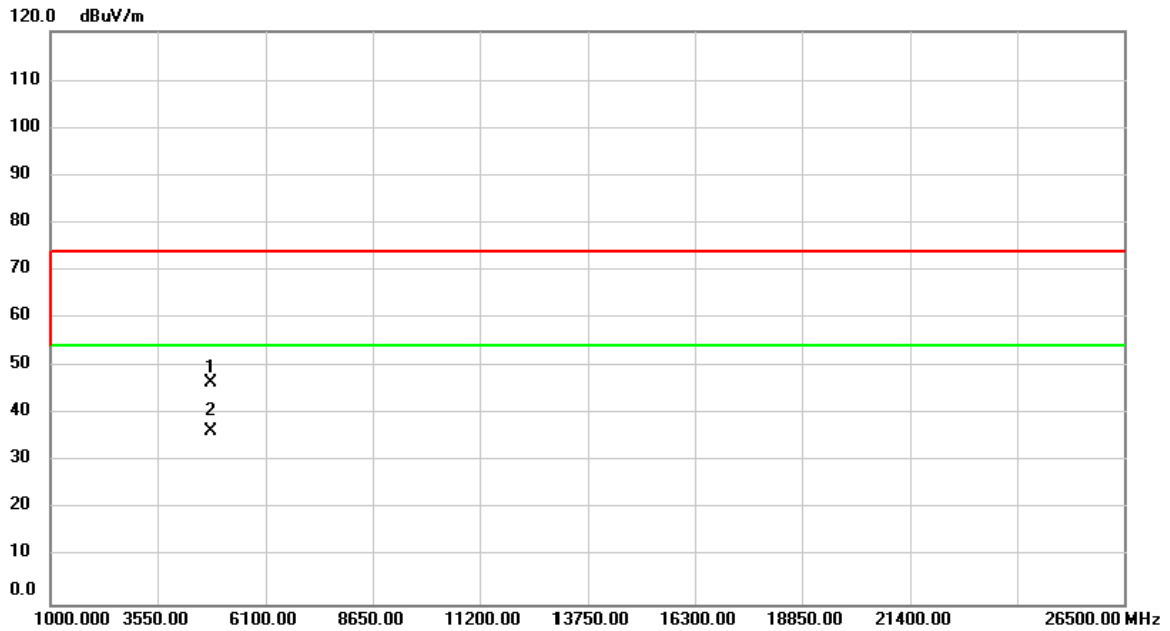

No.	Mk.	Freq. MHz	Reading Level dBuV	Correct Factor dB	Measure- ment dBuV/m	Limit dBuV/m	Over dB	Detector	Comment
1		4824.000	57.07	-10.48	46.59	74.00	-27.41	peak	
2	*	4824.000	47.06	-10.48	36.58	54.00	-17.42	AVG	

Test Mode: TX B MODE 2412MHz

Horizontal

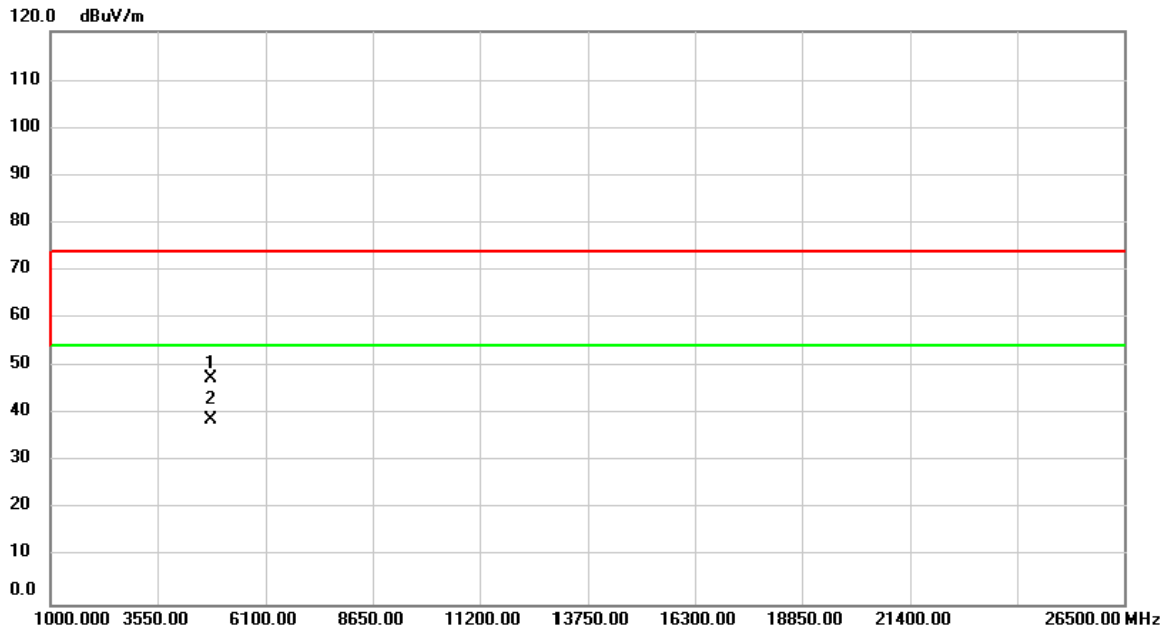

No.	Mk.	Freq. MHz	Reading Level dBuV	Correct Factor dB	Measure- ment dBuV/m	Limit dBuV/m	Over dB	Detector	Comment
1		4824.000	58.01	-10.48	47.53	74.00	-26.47	peak	
2	*	4824.000	49.34	-10.48	38.86	54.00	-15.14	AVG	

Test Mode:	TX B MODE 2437MHz
------------	-------------------

Vertical

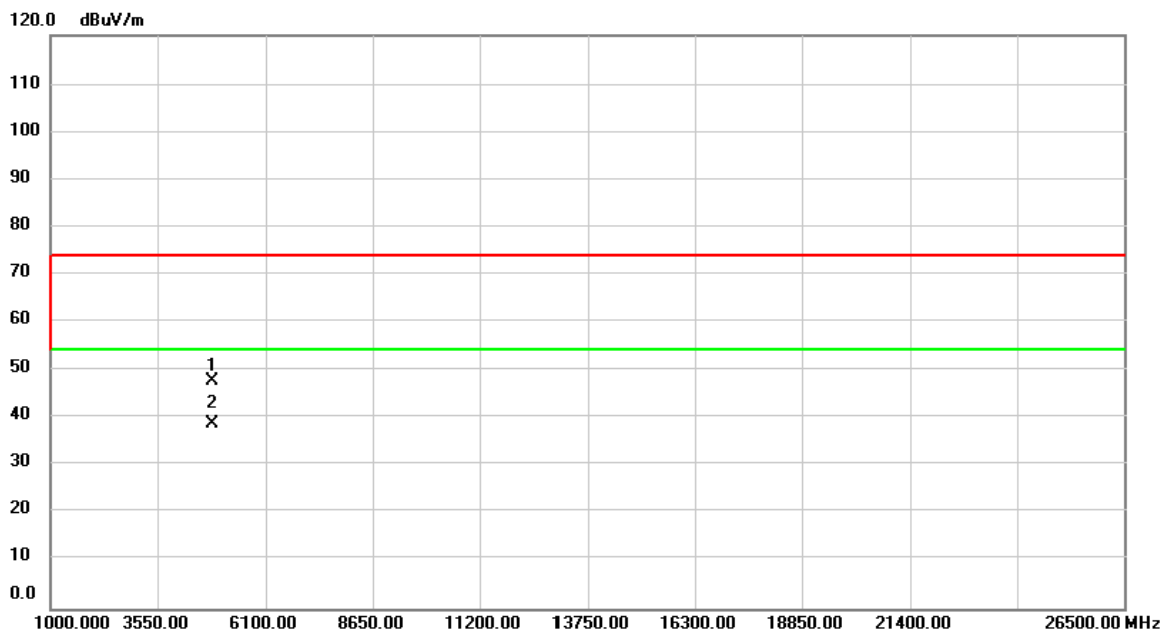

No.	Mk.	Freq.	Reading Level	Correct Factor	Measurement	Limit	Over	Detector	Comment
		MHz	dBuV	dB	dBuV/m	dBuV/m	dB		
1		4874.000	58.16	-10.40	47.76	74.00	-26.24	peak	
2	*	4874.000	49.19	-10.40	38.79	54.00	-15.21	AVG	

Test Mode: TX B MODE 2437MHz

Horizontal

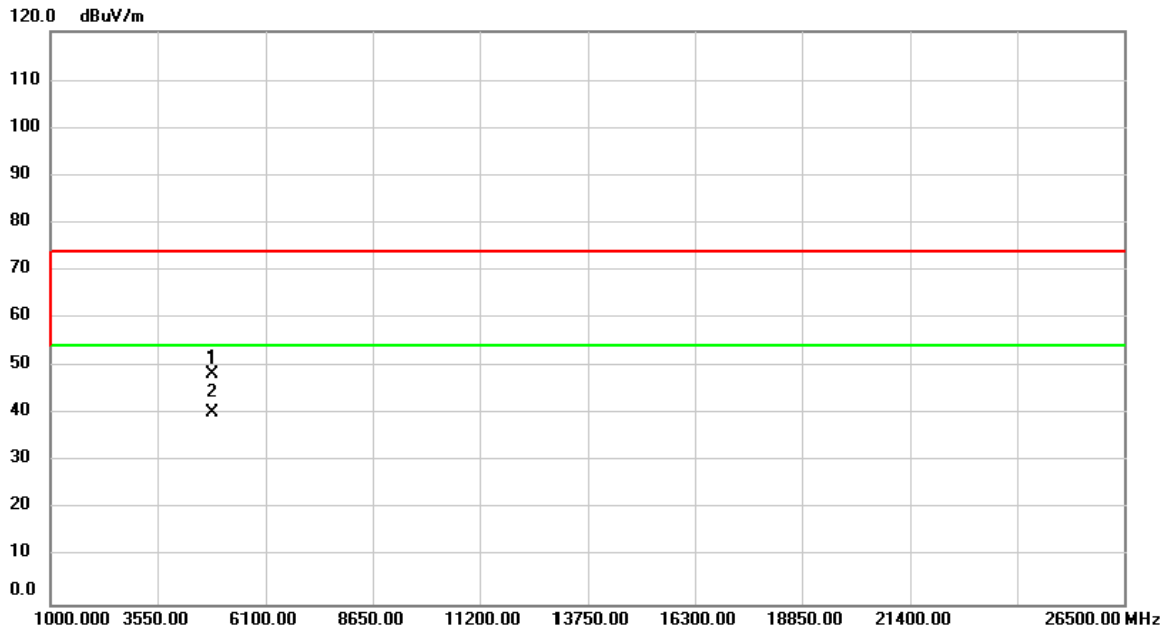

No.	Mk.	Freq. MHz	Reading Level dBuV	Correct Factor dB	Measure- ment dBuV/m	Limit dBuV/m	Over dB	Detector	Comment
1		4874.000	58.88	-10.40	48.48	74.00	-25.52	peak	
2	*	4874.000	50.85	-10.40	40.45	54.00	-13.55	AVG	

Test Mode: TX B MODE 2462MHz

Vertical

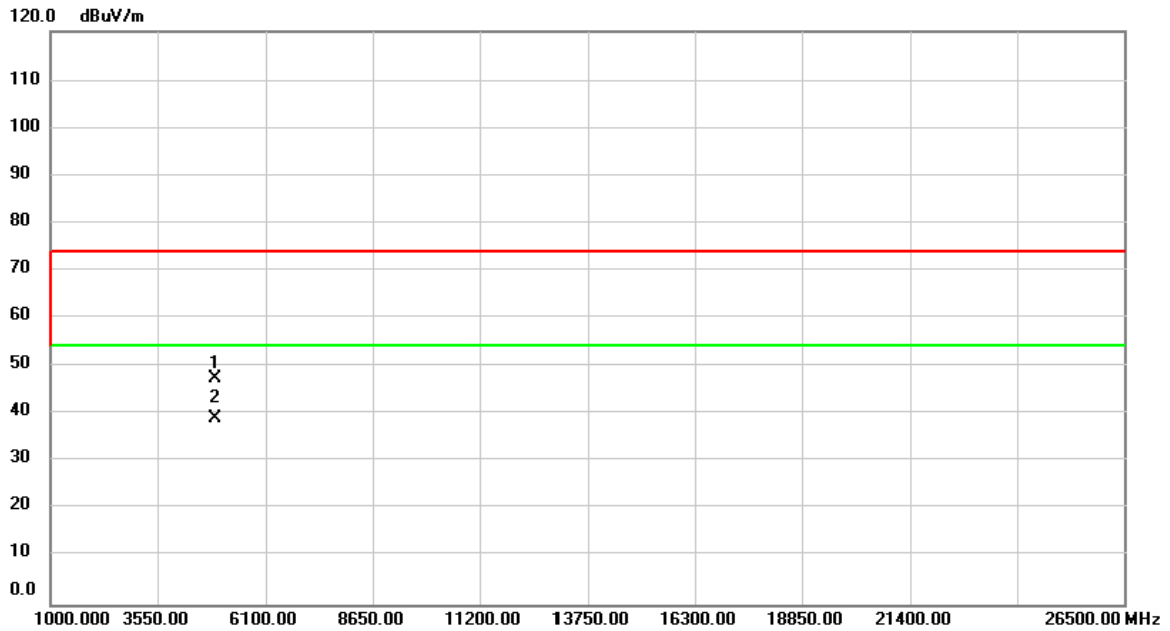

No.	Mk.	Freq. MHz	Reading Level dBuV	Correct Factor dB	Measure- ment dBuV/m	Limit dBuV/m	Over dB	Detector	Comment
1		4924.000	57.98	-10.32	47.66	74.00	-26.34	peak	
2	*	4924.000	49.62	-10.32	39.30	54.00	-14.70	AVG	

Test Mode: TX B MODE 2462MHz

Horizontal

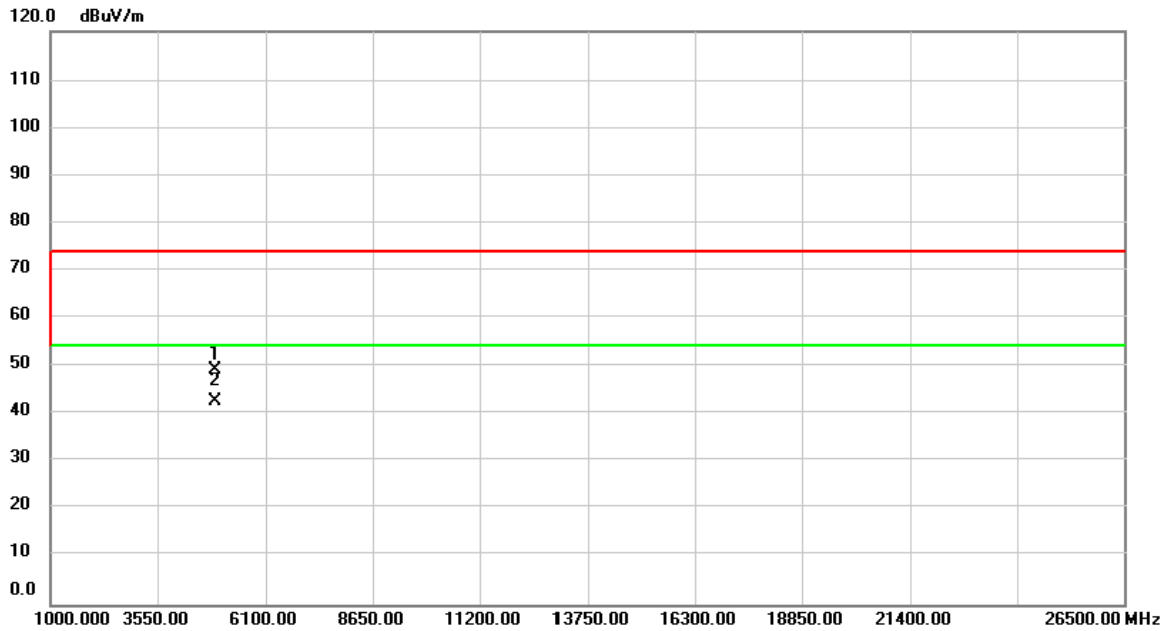

No.	Mk.	Freq. MHz	Reading Level dBuV	Correct Factor dB	Measure- ment dBuV/m	Limit dBuV/m	Over dB	Detector	Comment
1		4924.000	59.76	-10.32	49.44	74.00	-24.56	peak	
2	*	4924.000	53.08	-10.32	42.76	54.00	-11.24	AVG	

Test Mode:	TX G MODE 2412MHz
------------	-------------------

Vertical

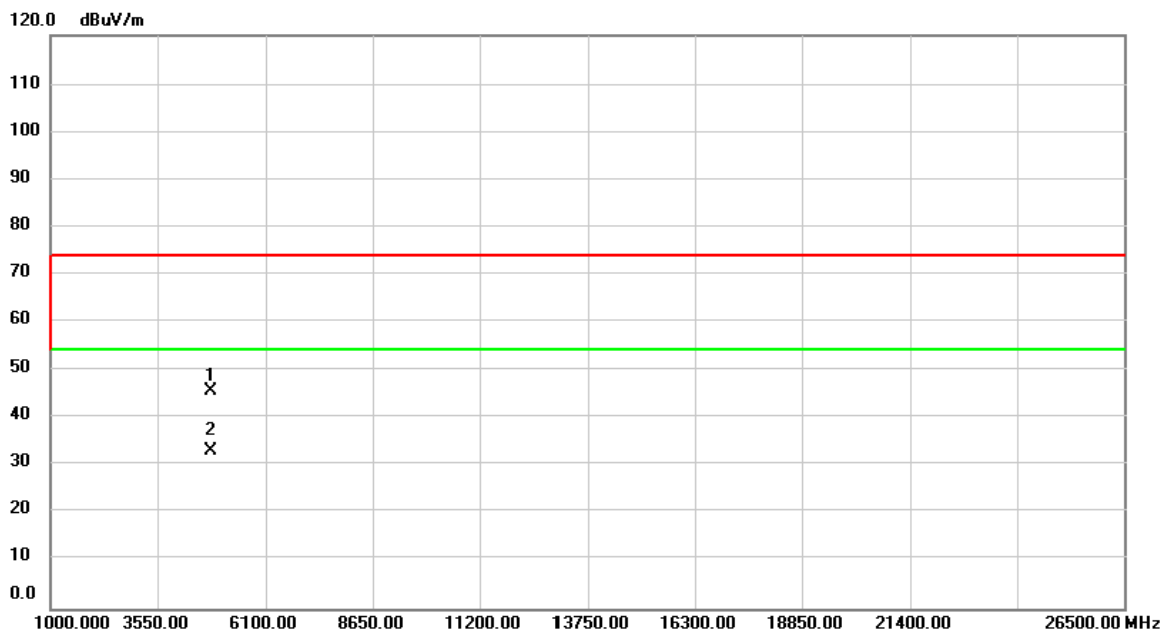

No.	Mk.	Freq.	Reading Level	Correct Factor	Measurement	Limit	Over	Detector	Comment
		MHz	dBuV	dB	dBuV/m	dBuV/m	dB		
1		4824.000	56.36	-10.48	45.88	74.00	-28.12	peak	
2	*	4824.000	43.55	-10.48	33.07	54.00	-20.93	AVG	

Test Mode: TX G MODE 2412MHz

Horizontal

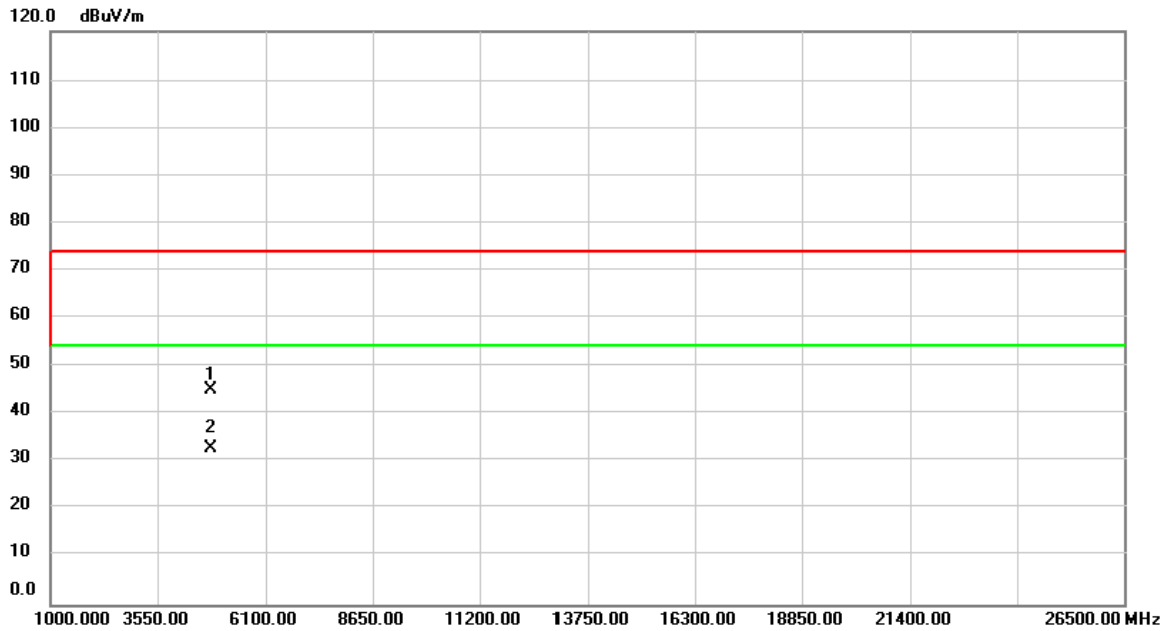

No.	Mk.	Freq. MHz	Reading Level dBuV	Correct Factor dB	Measure- ment dBuV/m	Limit dBuV/m	Over dB	Detector	Comment
1		4824.000	55.70	-10.48	45.22	74.00	-28.78	peak	
2	*	4824.000	43.23	-10.48	32.75	54.00	-21.25	AVG	

Test Mode: TX G MODE 2437MHz

Vertical

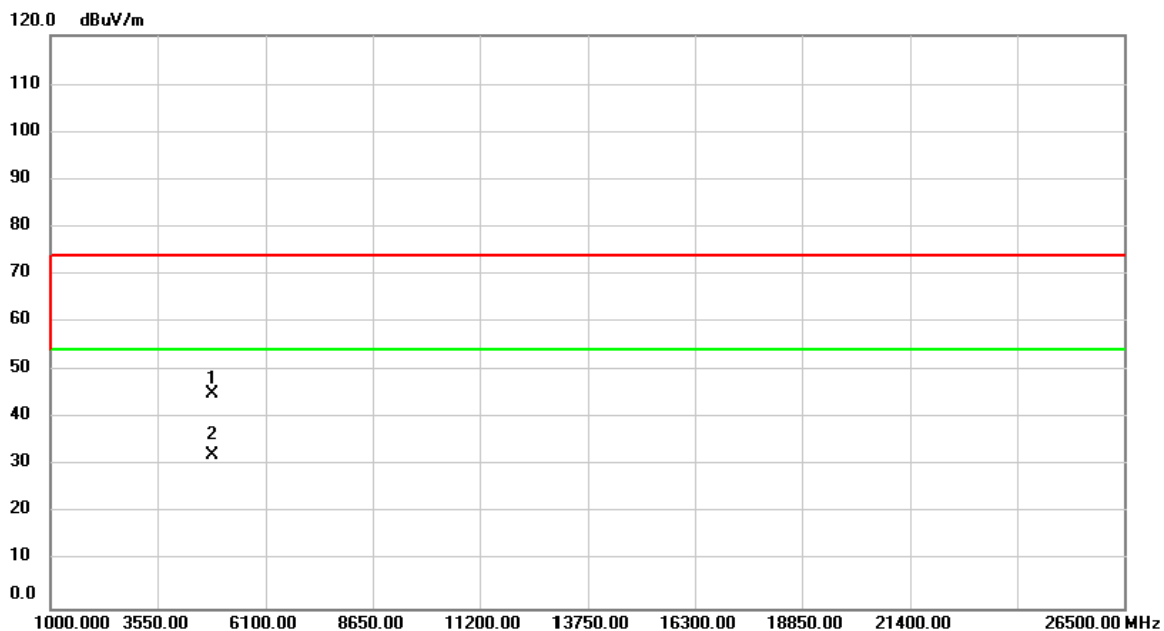

No.	Mk.	Freq. MHz	Reading Level dBuV	Correct Factor dB	Measure- ment dBuV/m	Limit dBuV/m	Over dB	Detector	Comment
1		4874.000	55.55	-10.40	45.15	74.00	-28.85	peak	
2	*	4874.000	42.79	-10.40	32.39	54.00	-21.61	AVG	

Test Mode: TX G MODE 2437MHz

Horizontal

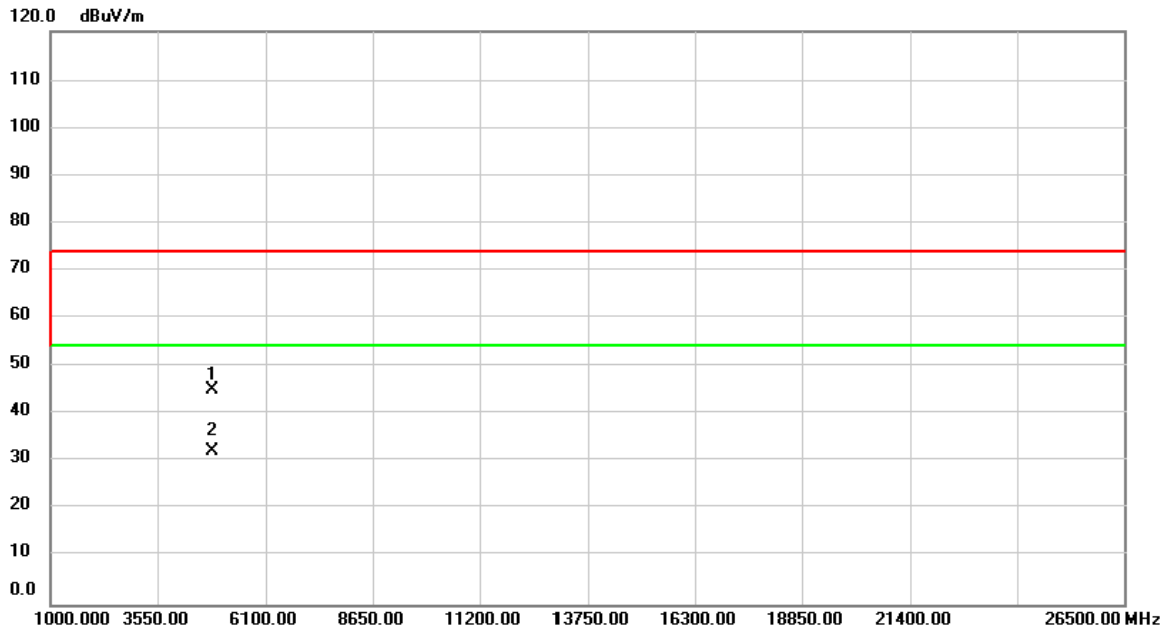

No.	Mk.	Freq. MHz	Reading Level dBuV	Correct Factor dB	Measure- ment dBuV/m	Limit dBuV/m	Over dB	Detector	Comment
1		4874.000	55.54	-10.40	45.14	74.00	-28.86	peak	
2	*	4874.000	42.77	-10.40	32.37	54.00	-21.63	AVG	

Test Mode:	TX G MODE 2462MHz
------------	-------------------

Vertical

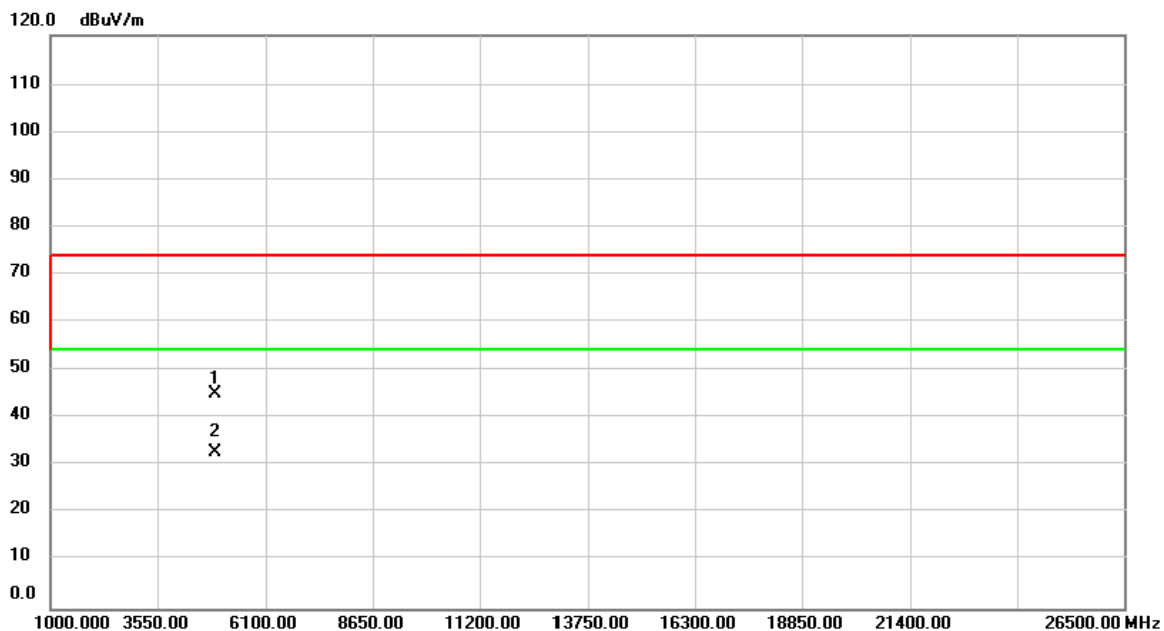

No.	Mk.	Freq. MHz	Reading Level dBuV	Correct Factor dB	Measure- ment dBuV/m	Limit dBuV/m	Over dB	Detector	Comment
1		4924.000	55.35	-10.32	45.03	74.00	-28.97	peak	
2	*	4924.000	43.10	-10.32	32.78	54.00	-21.22	AVG	

Test Mode:	TX G MODE 2462MHz
------------	-------------------

Horizontal

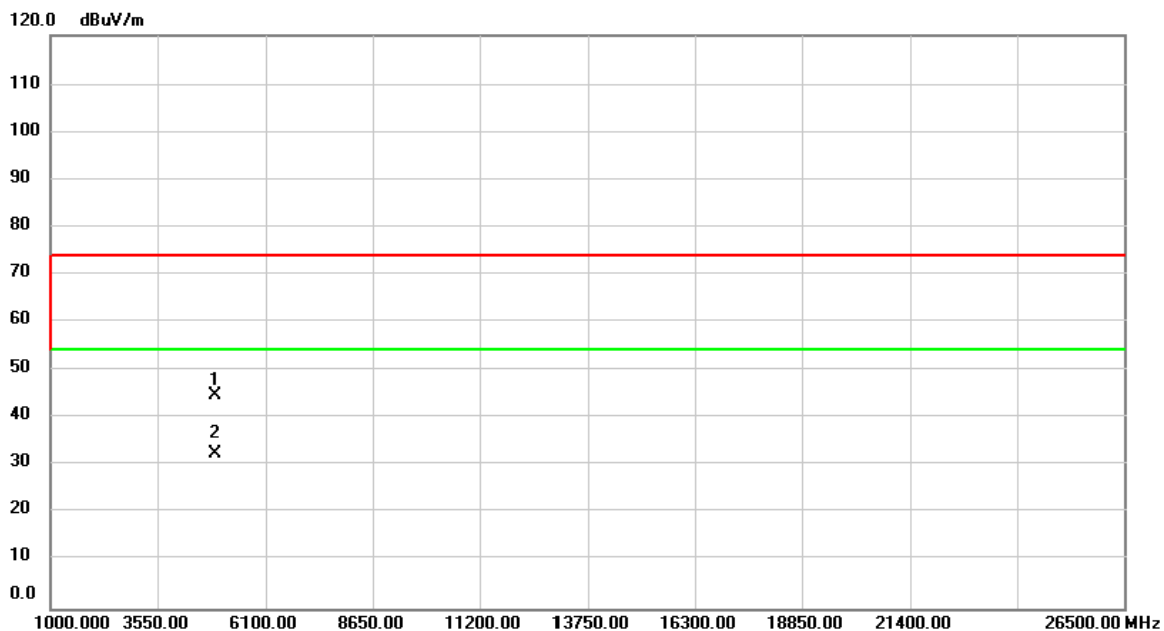

No.	Mk.	Freq. MHz	Reading Level dBuV	Correct Factor dB	Measure- ment dBuV/m	Limit dBuV/m	Over dB	Detector	Comment
1		4924.000	55.14	-10.32	44.82	74.00	-29.18	peak	
2	*	4924.000	42.86	-10.32	32.54	54.00	-21.46	AVG	

Test Mode: TX N-20M MODE 2412MHz

Vertical

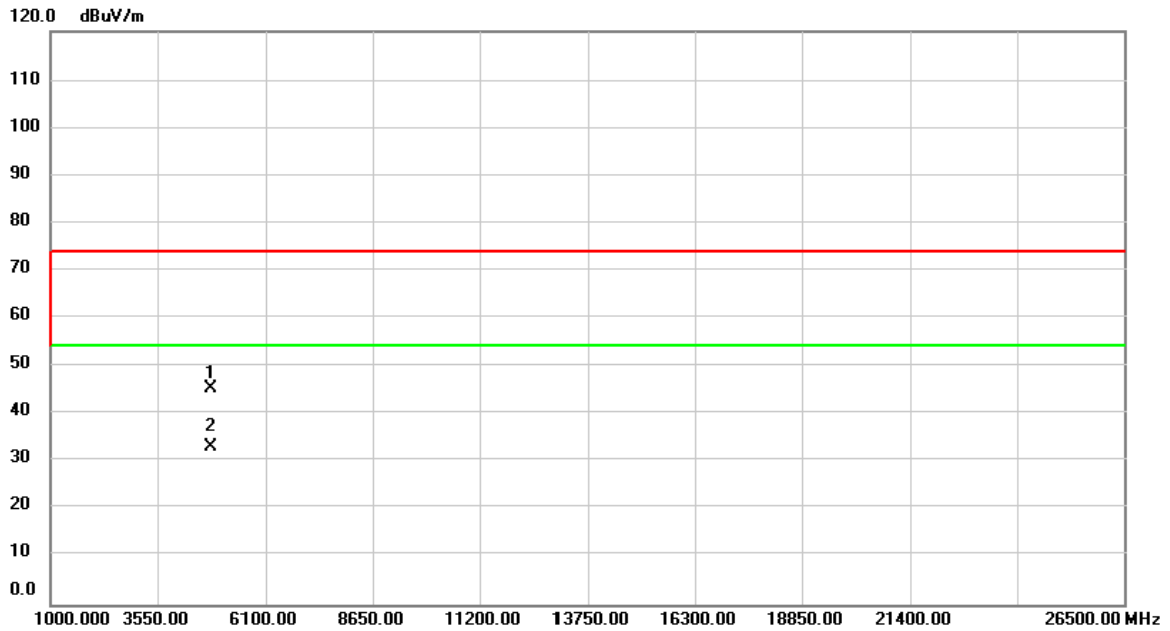

No.	Mk.	Freq. MHz	Reading Level dBuV	Correct Factor dB	Measure- ment dBuV/m	Limit dBuV/m	Over dB	Detector	Comment
1		4824.000	55.86	-10.48	45.38	74.00	-28.62	peak	
2	*	4824.000	43.54	-10.48	33.06	54.00	-20.94	AVG	

Test Mode: TX N-20M MODE 2412MHz

Horizontal

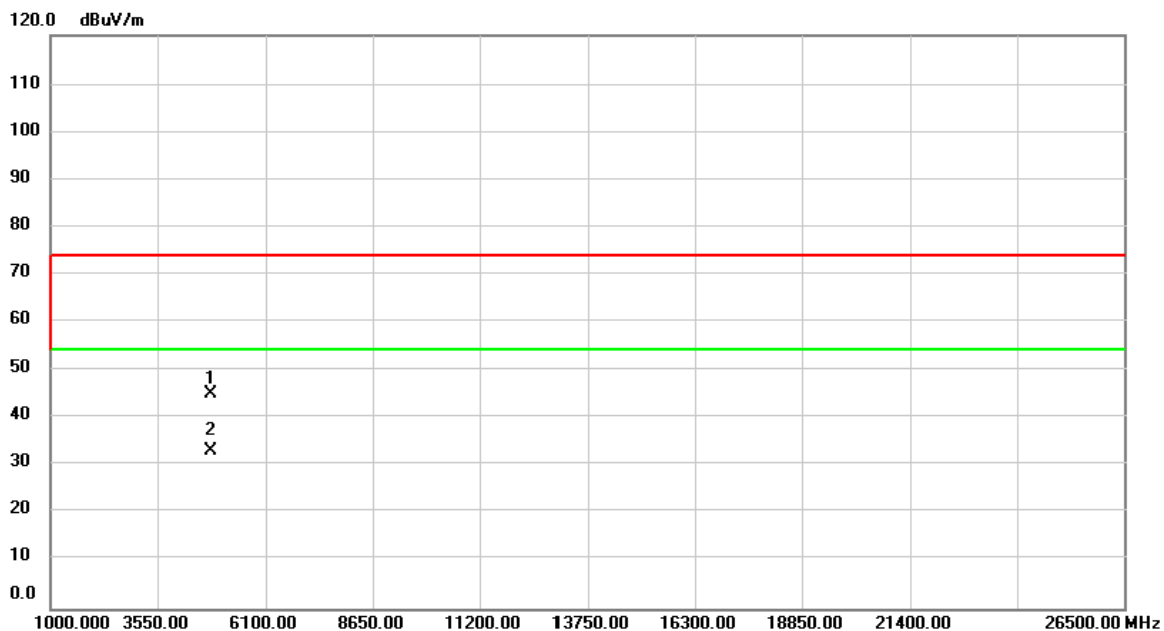

No.	Mk.	Freq. MHz	Reading Level dBuV	Correct Factor dB	Measure- ment dBuV/m	Limit dBuV/m	Over dB	Detector	Comment
1		4824.000	55.56	-10.48	45.08	74.00	-28.92	peak	
2	*	4824.000	43.60	-10.48	33.12	54.00	-20.88	AVG	

Test Mode: TX N-20M MODE 2437MHz

Vertical

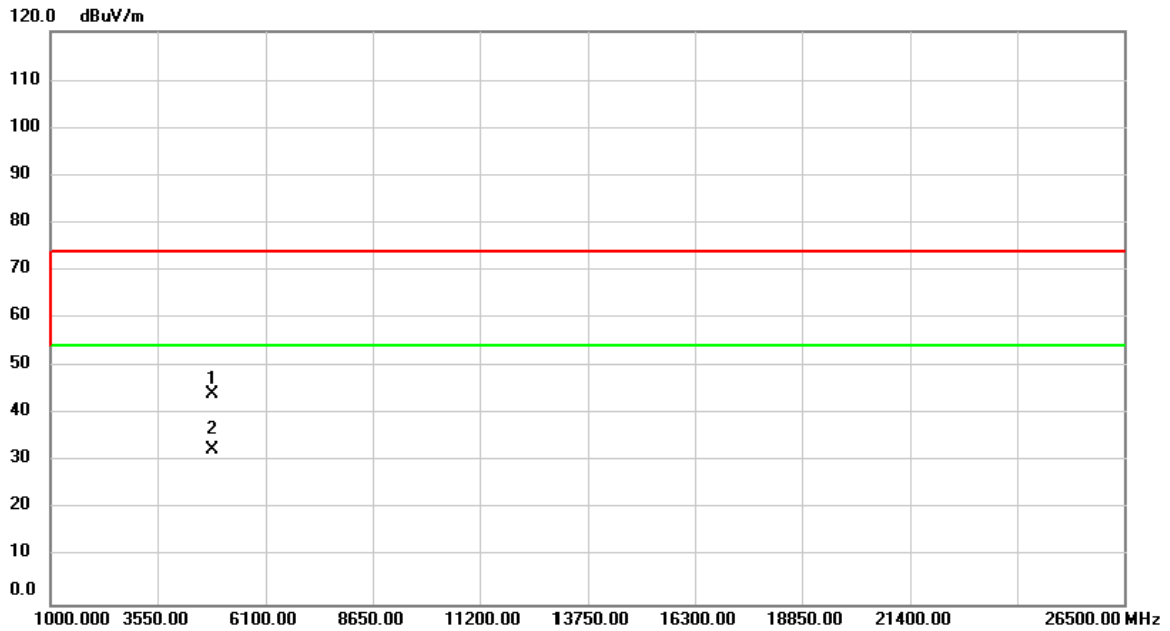

No.	Mk.	Freq. MHz	Reading Level dBuV	Correct Factor dB	Measure- ment dBuV/m	Limit dBuV/m	Over dB	Detector	Comment
1		4874.000	54.71	-10.40	44.31	74.00	-29.69	peak	
2	*	4874.000	42.81	-10.40	32.41	54.00	-21.59	AVG	

Test Mode: TX N-20M MODE 2437MHz

Horizontal

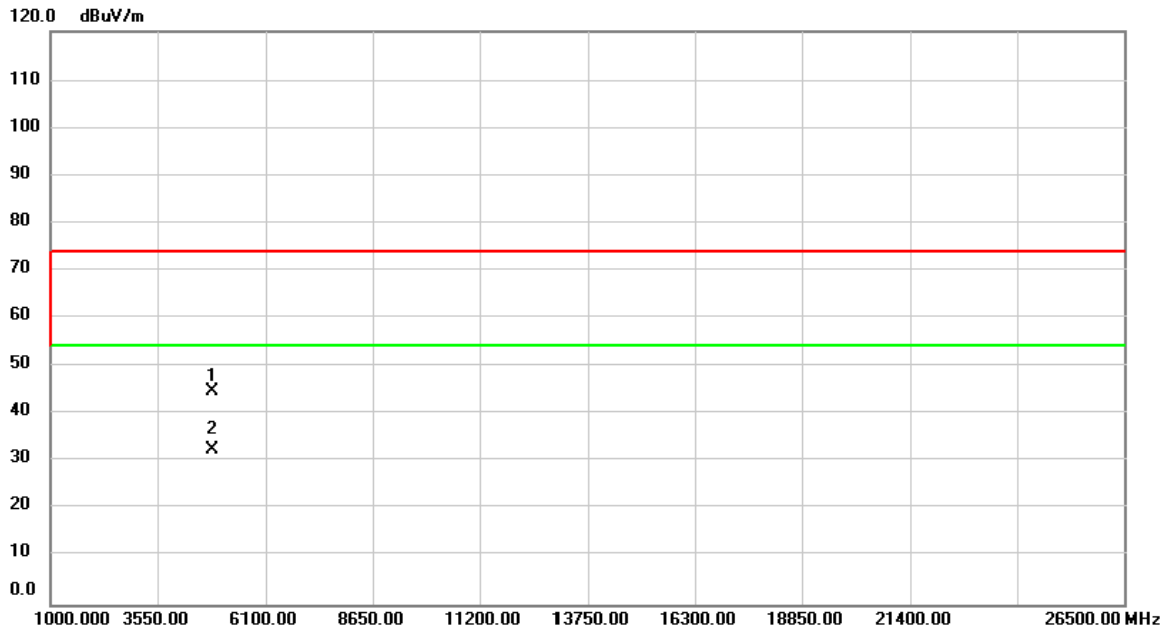

No.	Mk.	Freq. MHz	Reading Level dBuV	Correct Factor dB	Measure- ment dBuV/m	Limit dBuV/m	Over dB	Detector	Comment
1		4874.000	55.33	-10.40	44.93	74.00	-29.07	peak	
2	*	4874.000	42.88	-10.40	32.48	54.00	-21.52	AVG	

Test Mode: TX N-20M MODE 2462MHz

Vertical

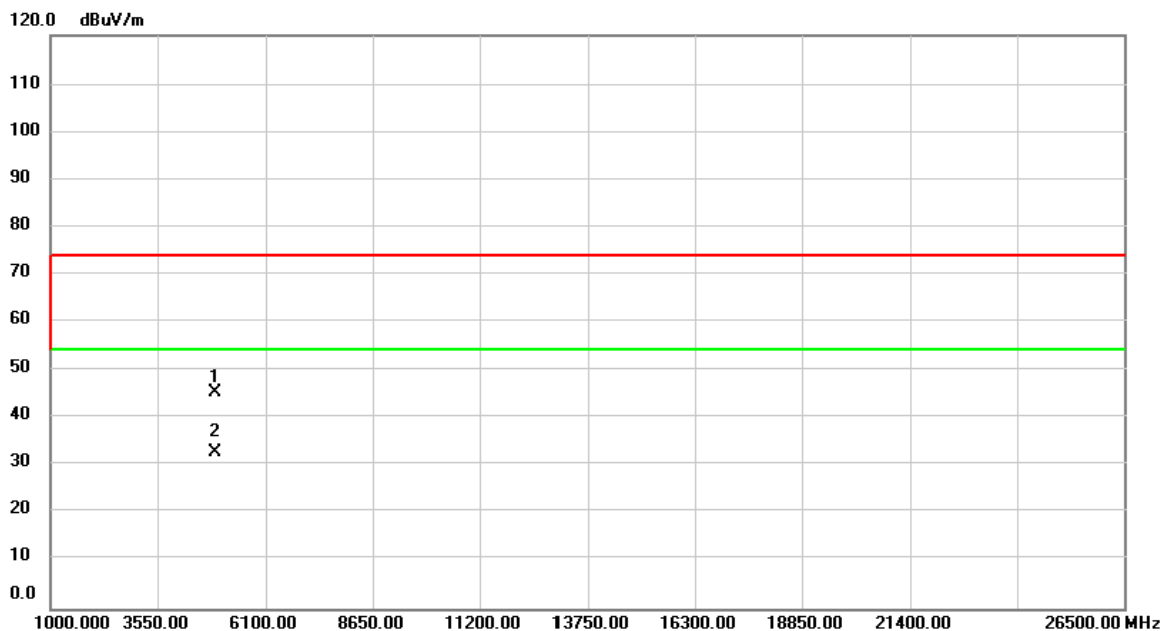

No.	Mk.	Freq. MHz	Reading Level dBuV	Correct Factor dB	Measure- ment dBuV/m	Limit dBuV/m	Over dB	Detector	Comment
1		4924.000	55.68	-10.32	45.36	74.00	-28.64	peak	
2	*	4924.000	43.18	-10.32	32.86	54.00	-21.14	AVG	

Test Mode: TX N-20M MODE 2462MHz

Horizontal

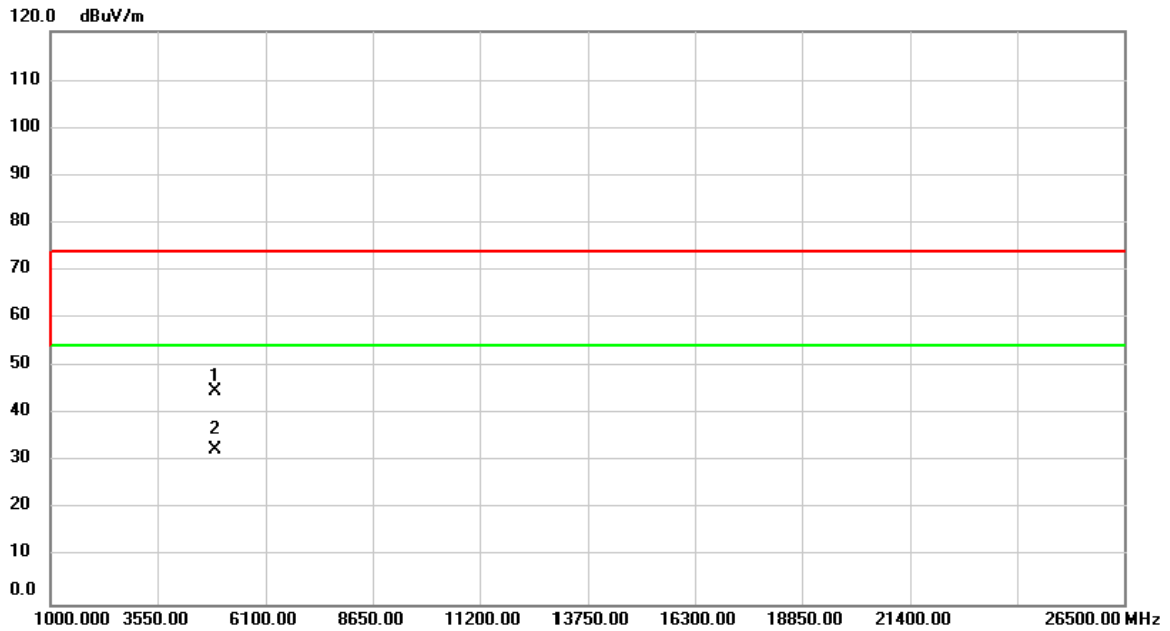

No.	Mk.	Freq. MHz	Reading Level dBuV	Correct Factor dB	Measure- ment dBuV/m	Limit dBuV/m	Over dB	Detector	Comment
1		4924.000	55.12	-10.32	44.80	74.00	-29.20	peak	
2	*	4924.000	42.97	-10.32	32.65	54.00	-21.35	AVG	

ATTACHMENT E - BAND EDGE AND FUNDAMENTAL EMISSIONS

Test Mode: TX B MODE 2412MHz

Vertical

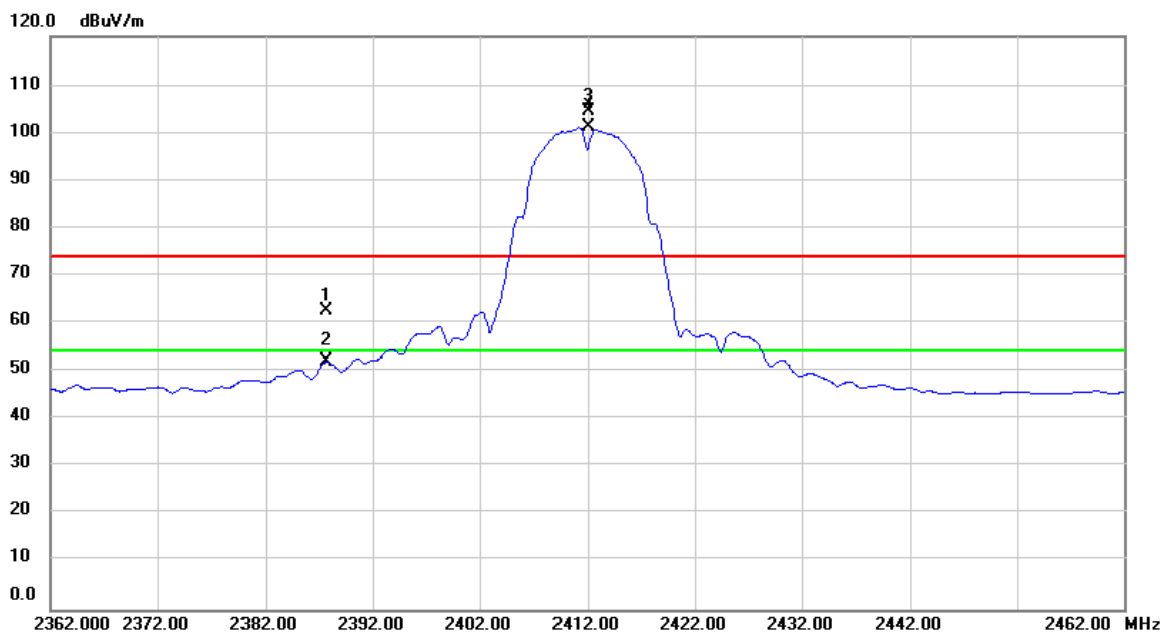

No.	Mk.	Freq. MHz	Reading Level dBuV	Correct Factor dB	Measure- ment dBuV/m	Limit dBuV/m	Over dB	Detector	Comment
1		2387.700	30.71	31.70	62.41	74.00	-11.59	peak	
2		2387.700	20.37	31.70	52.07	54.00	-1.93	AVG	
3	X	2412.000	72.78	31.79	104.57	74.00	30.57	peak	No Limit
4	*	2412.000	69.35	31.79	101.14	54.00	47.14	AVG	No Limit

Test Mode: TX B MODE 2412MHz

Horizontal

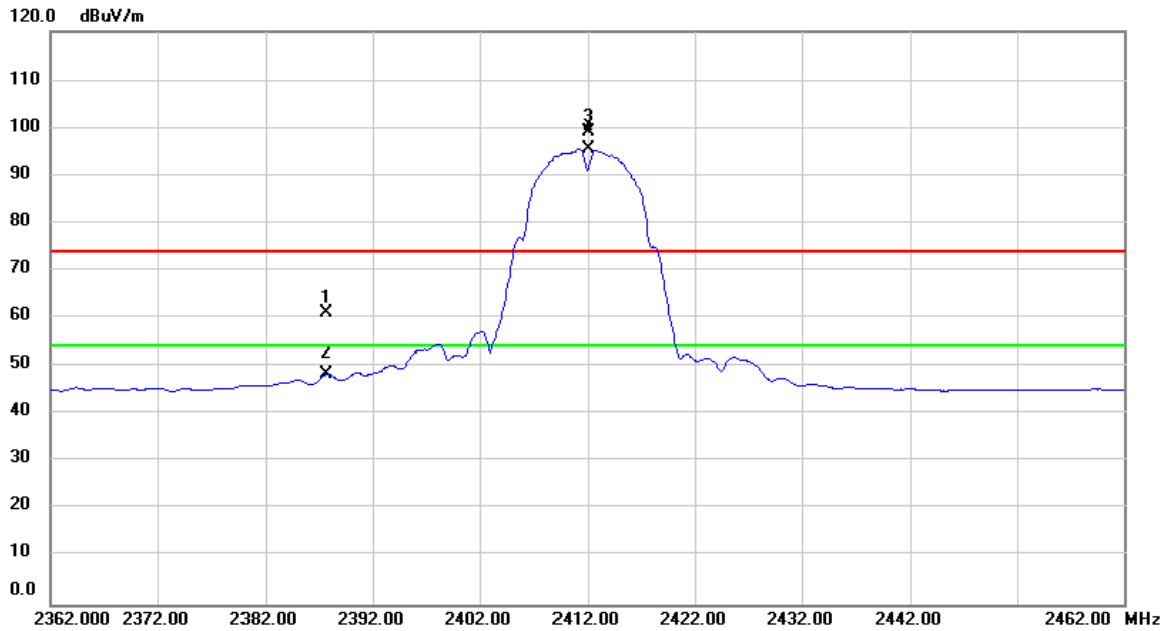

No.	Mk.	Freq. MHz	Reading Level dBuV	Correct Factor dB	Measure- ment dBuV/m	Limit dBuV/m	Over dB	Detector	Comment
1		2387.700	29.27	31.70	60.97	74.00	-13.03	peak	
2		2387.700	16.72	31.70	48.42	54.00	-5.58	AVG	
3	X	2412.000	67.24	31.79	99.03	74.00	25.03	peak	No Limit
4	*	2412.000	63.84	31.79	95.63	54.00	41.63	AVG	No Limit

Test Mode: TX B MODE 2437MHz

Vertical

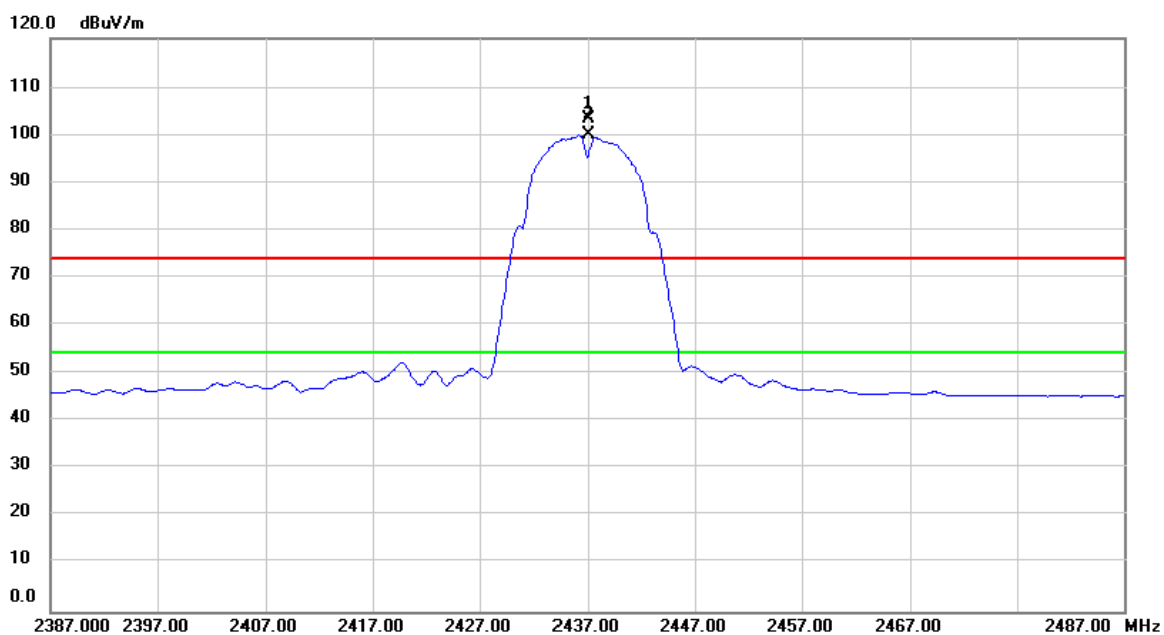

No.	Mk.	Freq. MHz	Reading Level dBuV	Correct Factor dB	Measure- ment dBuV/m	Limit dBuV/m	Over dB	Detector	Comment
1	X	2437.000	71.50	31.88	103.38	74.00	29.38	peak	No Limit
2	*	2437.000	68.08	31.88	99.96	54.00	45.96	AVG	No Limit

Test Mode: TX B MODE 2437MHz

Horizontal

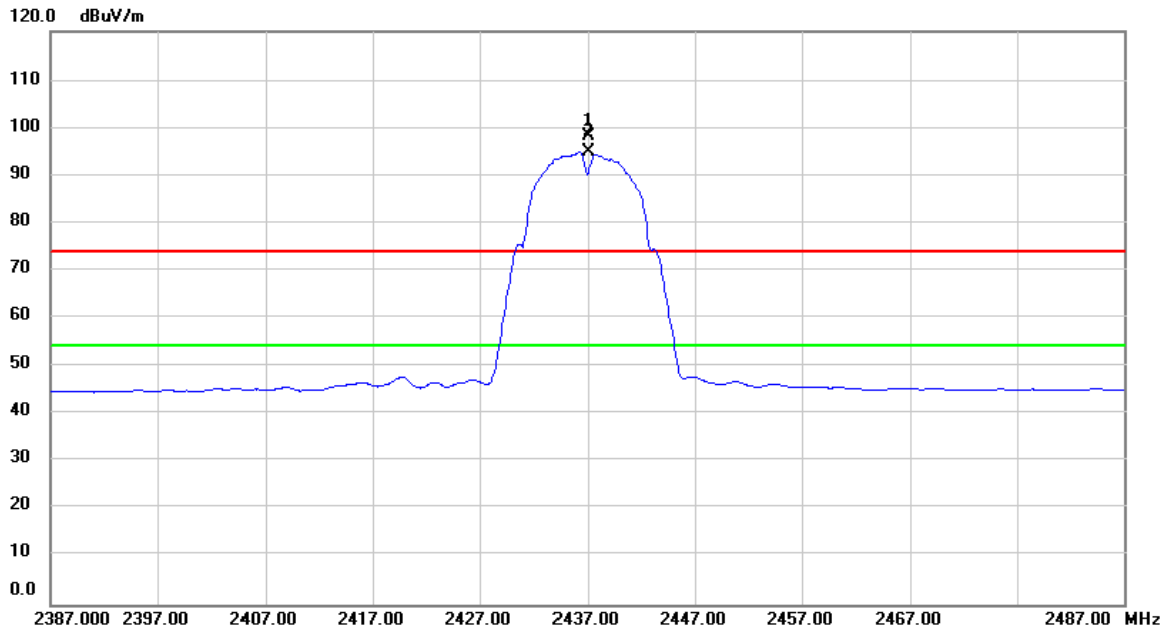

No.	Mk.	Freq. MHz	Reading Level dBuV	Correct Factor dB	Measure- ment dBuV/m	Limit dBuV/m	Over dB	Detector	Comment
1	X	2437.000	66.44	31.88	98.32	74.00	24.32	peak	No Limit
2	*	2437.000	63.01	31.88	94.89	54.00	40.89	AVG	No Limit

Test Mode: TX B MODE 2462MHz

Vertical

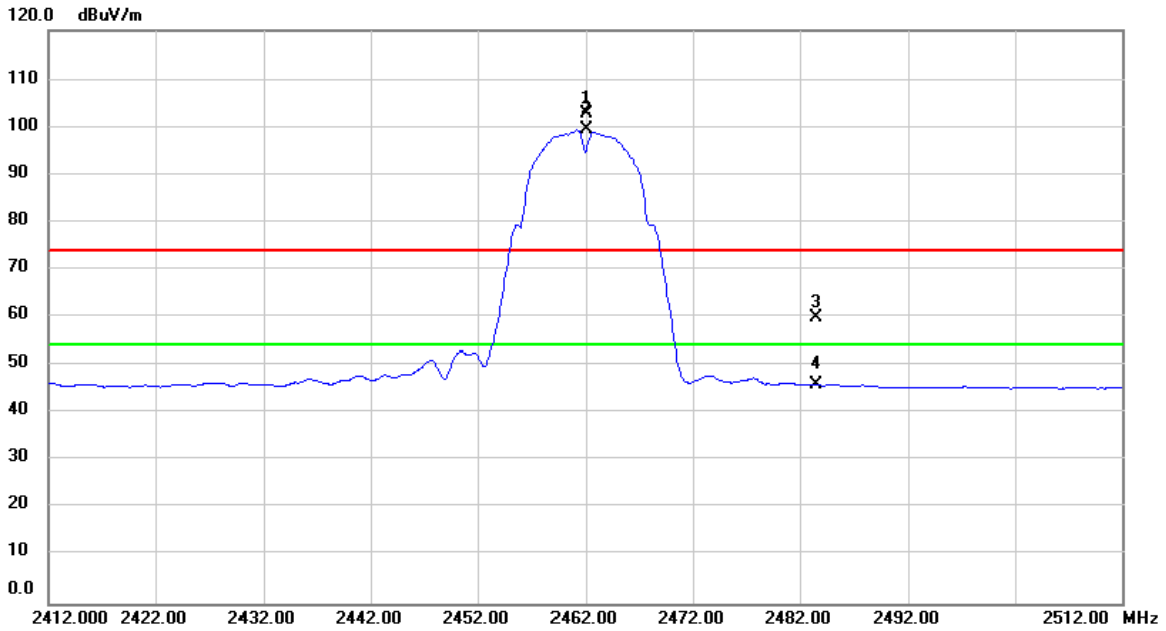

No.	Mk.	Freq. MHz	Reading Level dBuV	Correct Factor dB	Measure- ment dBuV/m	Limit dBuV/m	Over dB	Detector	Comment
1	X	2462.000	70.74	31.98	102.72	74.00	28.72	peak	No Limit
2	*	2462.000	67.36	31.98	99.34	54.00	45.34	AVG	No Limit
3		2483.500	27.69	32.06	59.75	74.00	-14.25	peak	
4		2483.500	13.99	32.06	46.05	54.00	-7.95	AVG	

Test Mode: TX B MODE 2462MHz

Horizontal

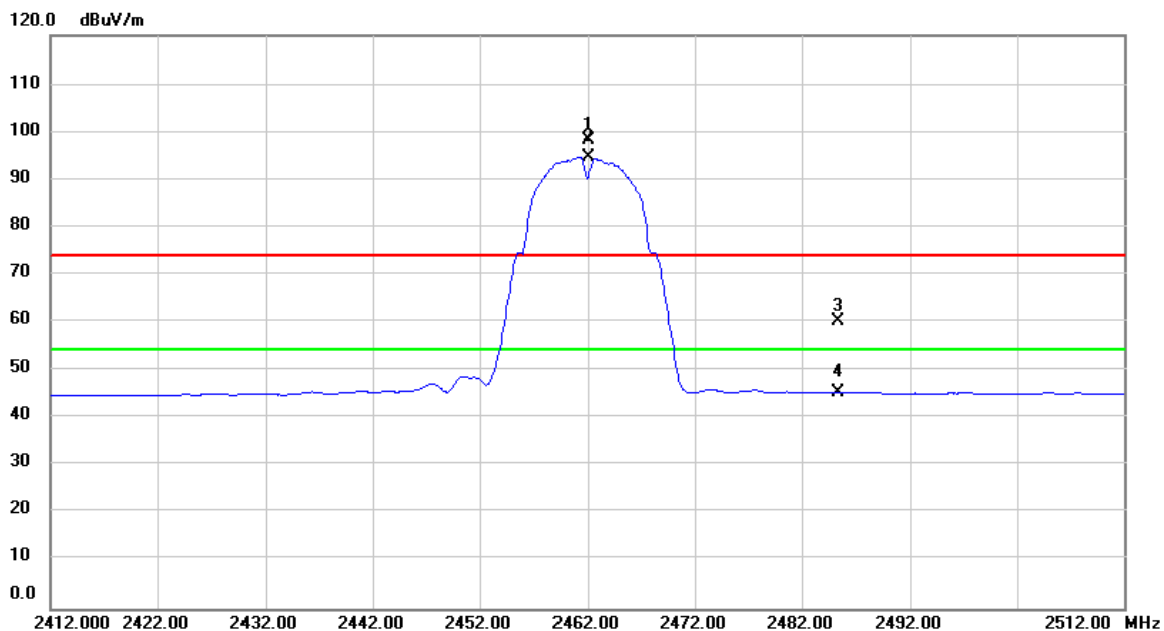

No.	Mk.	Freq. MHz	Reading Level dBuV	Correct Factor dB	Measure- ment dBuV/m	Limit dBuV/m	Over dB	Detector	Comment
1	X	2462.000	66.23	31.98	98.21	74.00	24.21	peak	No Limit
2	*	2462.000	62.82	31.98	94.80	54.00	40.80	AVG	No Limit
3		2485.400	28.14	32.07	60.21	74.00	-13.79	peak	
4		2485.400	13.35	32.07	45.42	54.00	-8.58	AVG	

Test Mode: TX G MODE 2412MHz

Vertical

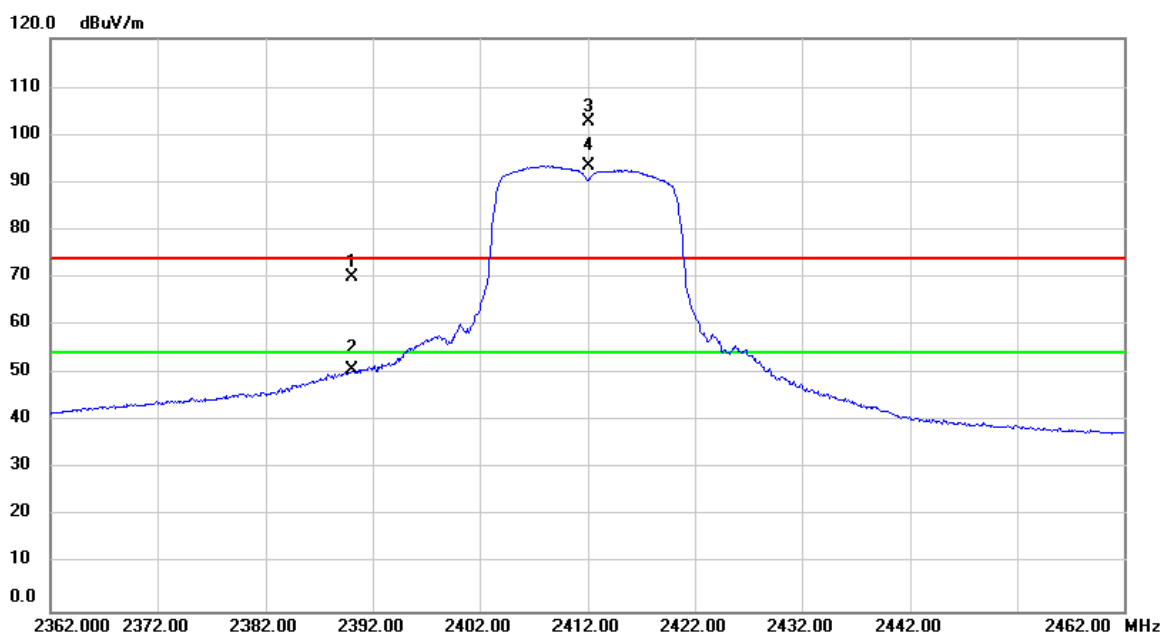

No. Mk.	Freq. MHz	Reading Level dBuV	Correct Factor dB	Measurement dBuV/m	Limit dBuV/m	Over dB	Detector	Comment
1	2390.000	38.29	31.70	69.99	74.00	-4.01	peak	
2	2390.000	19.07	31.70	50.77	54.00	-3.23	AVG	
3 X	2412.000	71.02	31.79	102.81	74.00	28.81	peak	No Limit
4 *	2412.000	61.71	31.79	93.50	54.00	39.50	AVG	No Limit

Test Mode: TX G MODE 2412MHz

Horizontal

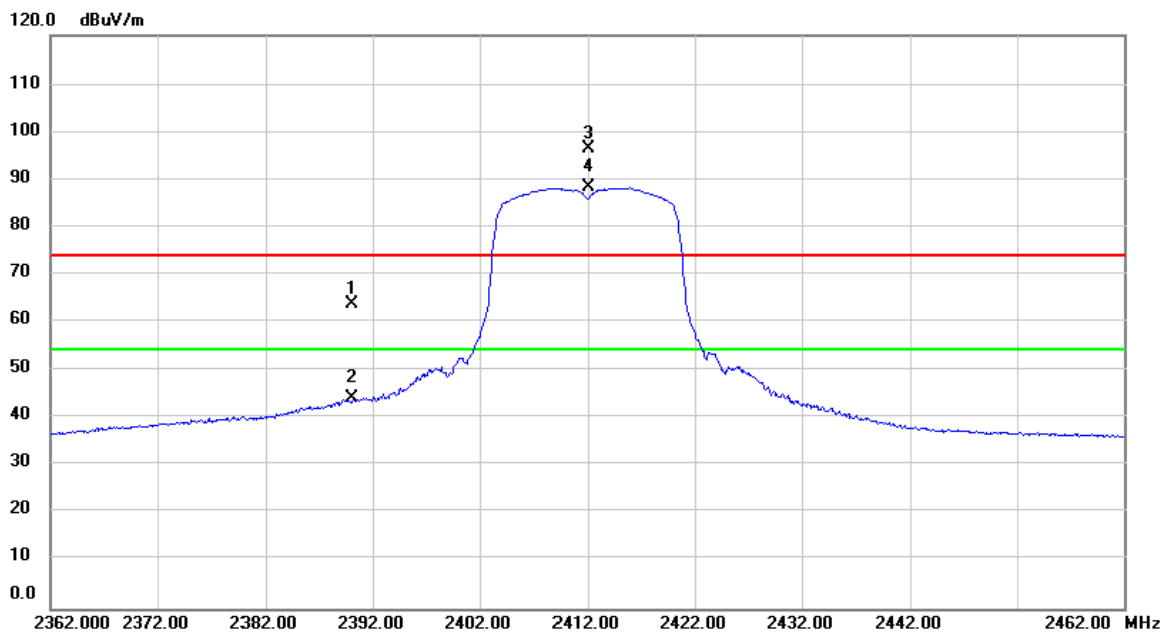

No.	Mk.	Freq. MHz	Reading Level dBuV	Correct Factor dB	Measure- ment dBuV/m	Limit dBuV/m	Over dB	Detector	Comment
1		2390.000	32.13	31.70	63.83	74.00	-10.17	peak	
2		2390.000	12.48	31.70	44.18	54.00	-9.82	AVG	
3	X	2412.000	64.76	31.79	96.55	74.00	22.55	peak	No Limit
4	*	2412.000	56.43	31.79	88.22	54.00	34.22	AVG	No Limit

Test Mode: TX G MODE 2437MHz

Vertical

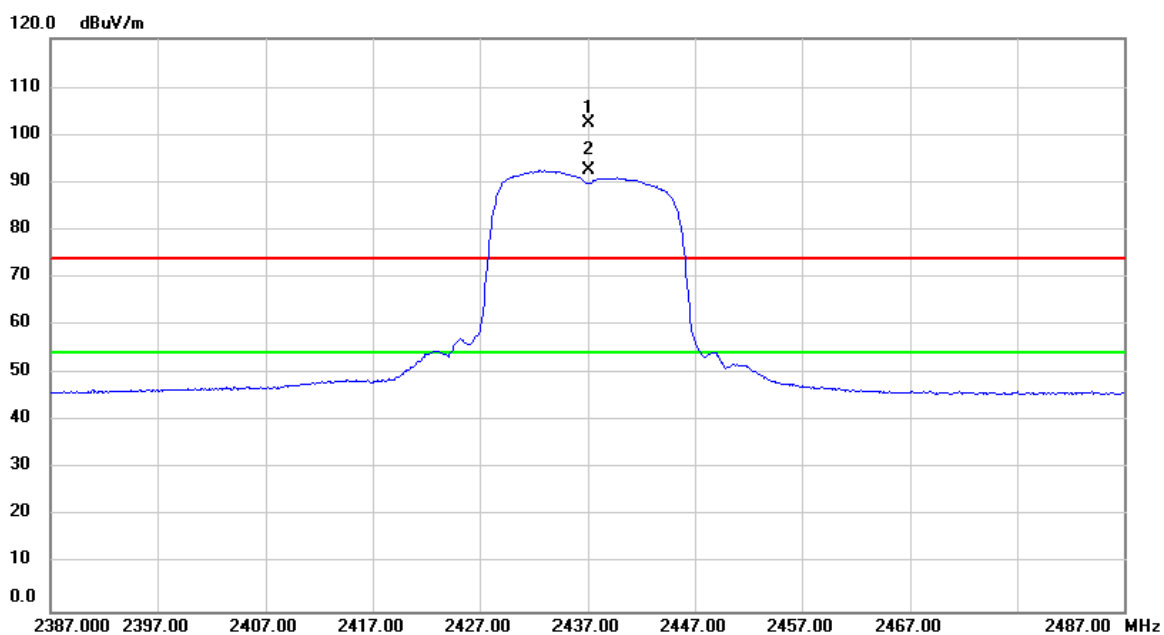

No.	Mk.	Freq. MHz	Reading Level dBuV	Correct Factor dB	Measure- ment dBuV/m	Limit dBuV/m	Over dB	Detector	Comment
1	X	2437.000	70.50	31.88	102.38	74.00	28.38	peak	No Limit
2	*	2437.000	60.65	31.88	92.53	54.00	38.53	AVG	No Limit

Test Mode: TX G MODE 2437MHz

Horizontal

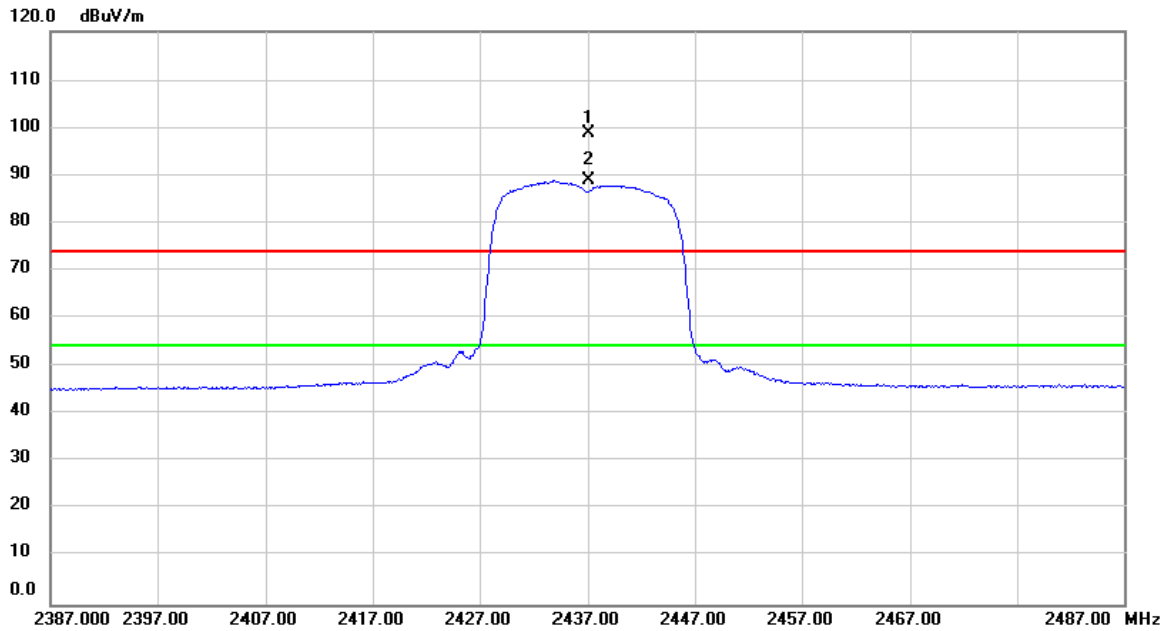

No.	Mk.	Freq. MHz	Reading Level dBuV	Correct Factor dB	Measure- ment dBuV/m	Limit dBuV/m	Over dB	Detector	Comment
1	X	2437.000	66.98	31.88	98.86	74.00	24.86	peak	No Limit
2	*	2437.000	56.99	31.88	88.87	54.00	34.87	AVG	No Limit

Test Mode: TX G MODE 2462MHz

Vertical

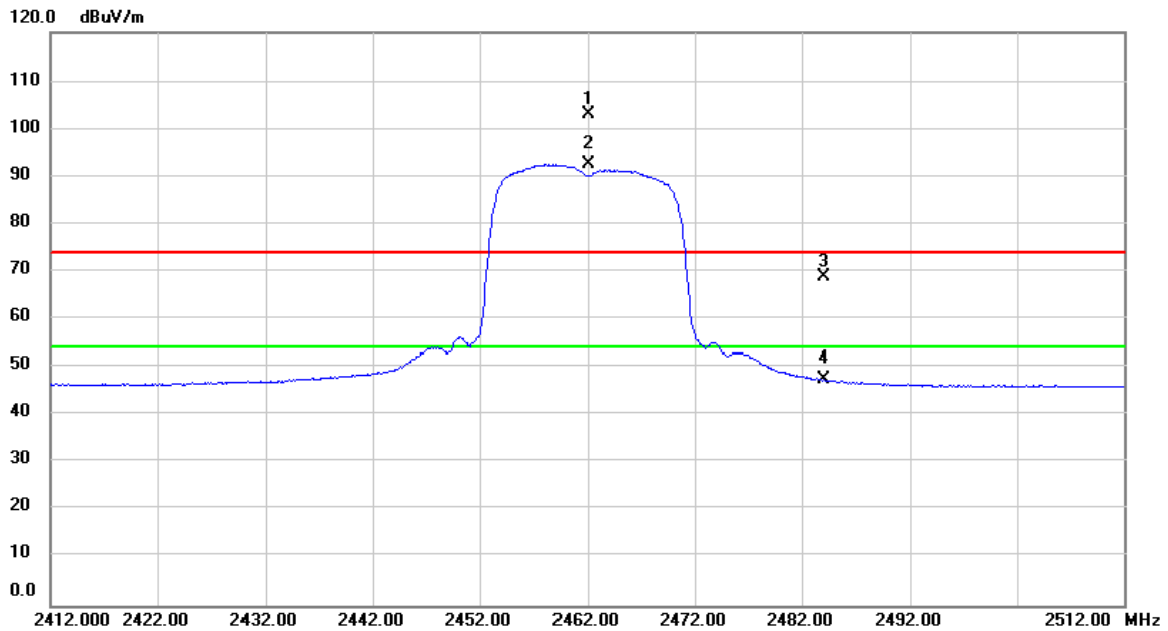

No.	Mk.	Freq. MHz	Reading Level dBuV	Correct Factor dB	Measure- ment dBuV/m	Limit dBuV/m	Over dB	Detector	Comment
1	X	2462.000	71.16	31.98	103.14	74.00	29.14	peak	No Limit
2	*	2462.000	60.48	31.98	92.46	54.00	38.46	AVG	No Limit
3		2484.100	36.92	32.07	68.99	74.00	-5.01	peak	
4		2484.100	15.51	32.07	47.58	54.00	-6.42	AVG	

Test Mode: TX G MODE 2462MHz

Horizontal

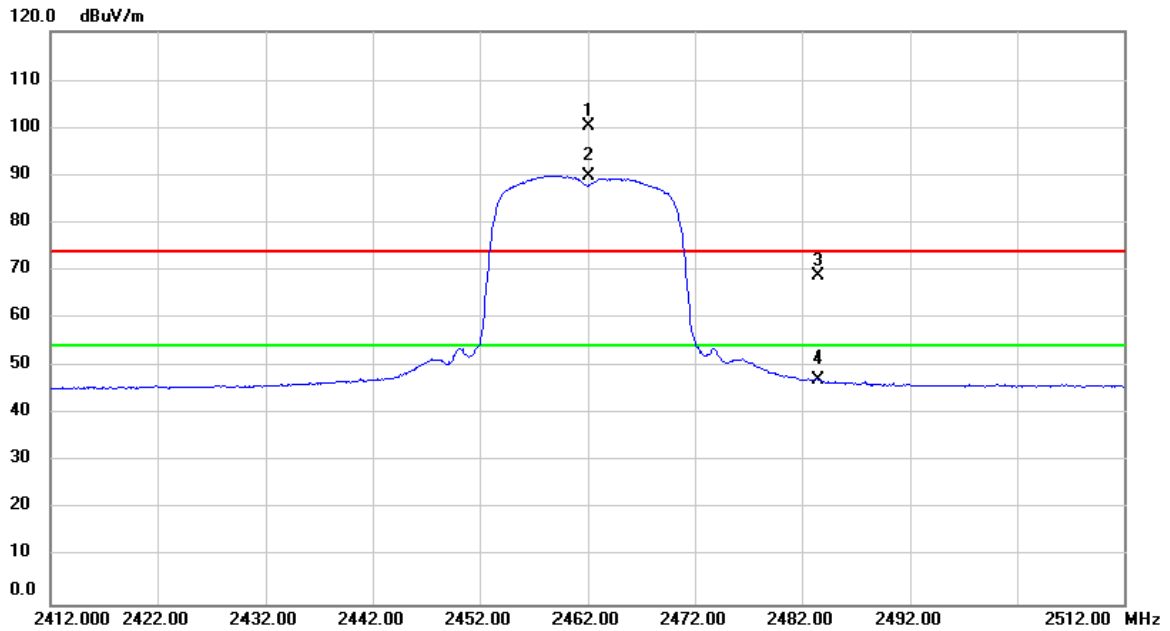

No.	Mk.	Freq. MHz	Reading Level dBuV	Correct Factor dB	Measure- ment dBuV/m	Limit dBuV/m	Over dB	Detector	Comment
1	X	2462.000	68.46	31.98	100.44	74.00	26.44	peak	No Limit
2	*	2462.000	57.91	31.98	89.89	54.00	35.89	AVG	No Limit
3		2483.600	36.75	32.06	68.81	74.00	-5.19	peak	
4		2483.600	15.12	32.06	47.18	54.00	-6.82	AVG	

Test Mode: TX N-20M MODE 2412MHz

Vertical

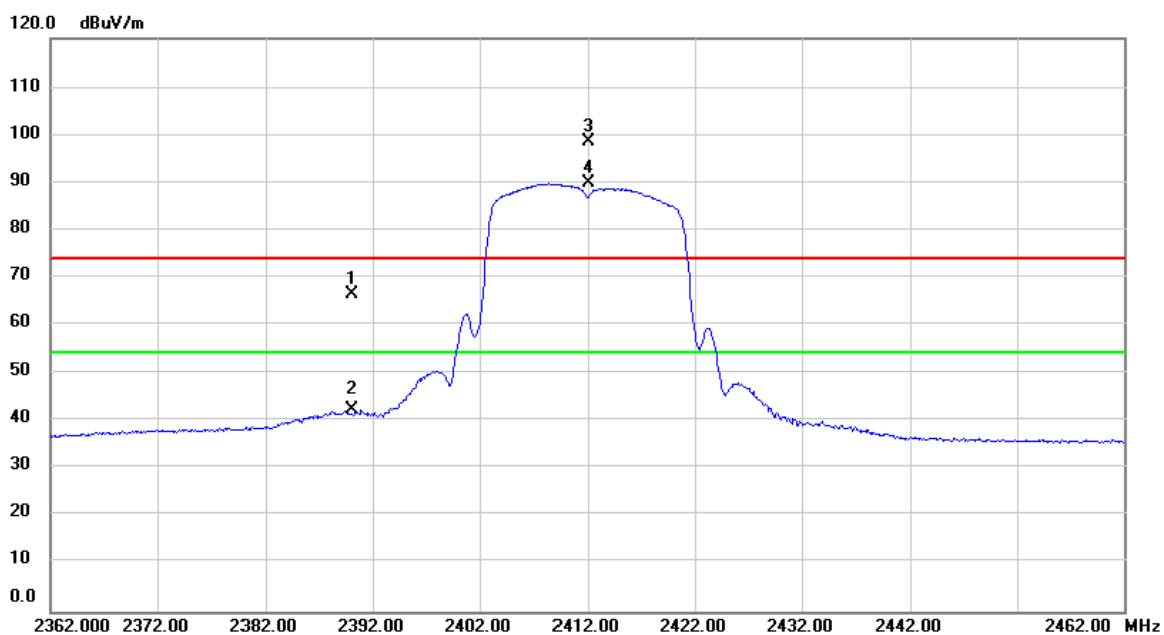

No. Mk.	Freq. MHz	Reading Level dBuV	Correct Factor dB	Measurement dBuV/m	Limit dBuV/m	Over dB	Detector	Comment
1	2390.000	34.87	31.70	66.57	74.00	-7.43	peak	
2	2390.000	10.70	31.70	42.40	54.00	-11.60	AVG	
3 *	2412.000	66.63	31.79	98.42	74.00	24.42	peak	No Limit
4 X	2412.000	57.96	31.79	89.75	74.00	15.75	peak	No Limit

Test Mode: TX N-20M MODE 2412MHz

Horizontal

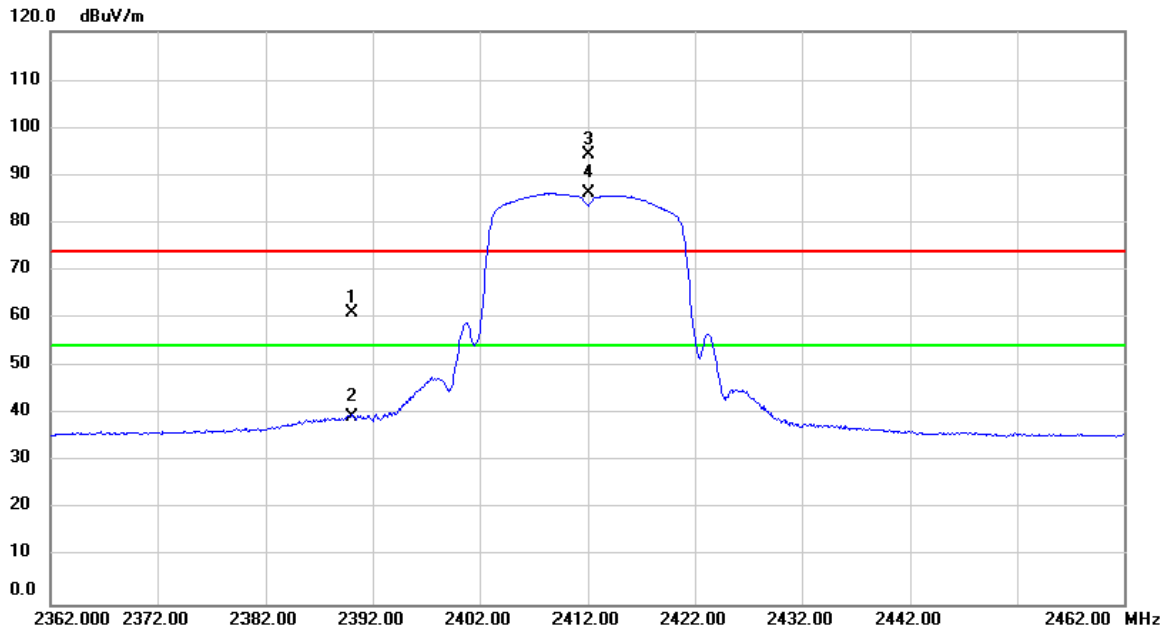

No.	Mk.	Freq. MHz	Reading Level dBuV	Correct Factor dB	Measure- ment dBuV/m	Limit dBuV/m	Over dB	Detector	Comment
1		2390.000	29.49	31.70	61.19	74.00	-12.81	peak	
2		2390.000	7.82	31.70	39.52	54.00	-14.48	AVG	
3	X	2412.000	62.65	31.79	94.44	74.00	20.44	peak	No Limit
4	*	2412.000	54.39	31.79	86.18	54.00	32.18	AVG	No Limit

Test Mode: TX N-20M MODE 2437MHz

Vertical

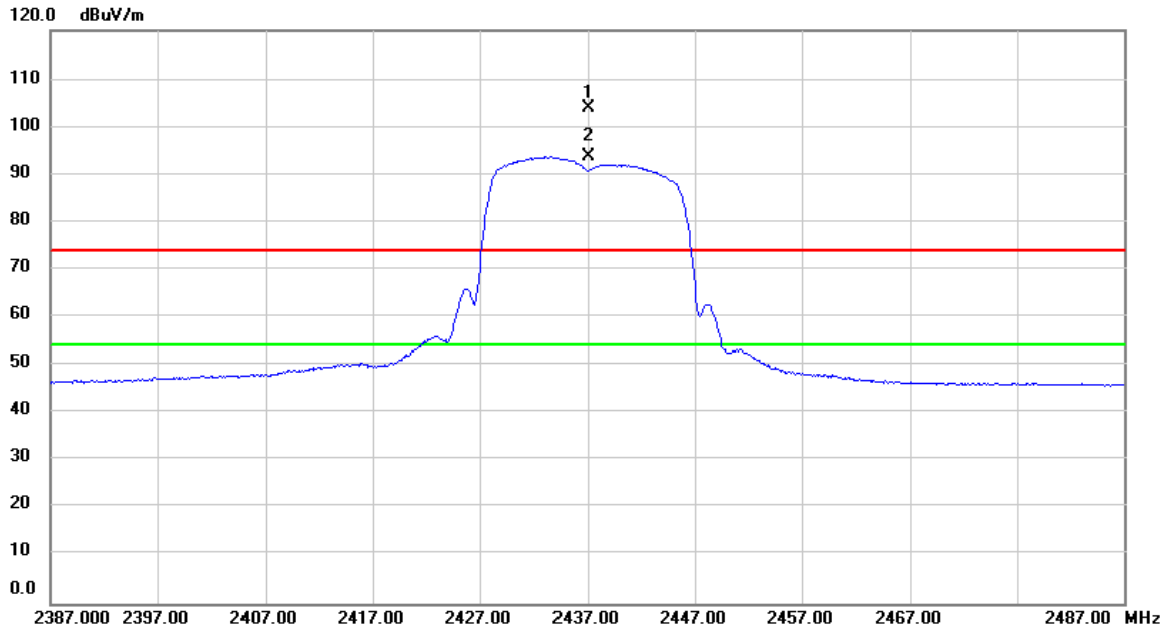

No.	Mk.	Freq. MHz	Reading Level dBuV	Correct Factor dB	Measure- ment dBuV/m	Limit dBuV/m	Over dB	Detector	Comment
1	X	2437.000	72.11	31.88	103.99	74.00	29.99	peak	No Limit
2	*	2437.000	61.80	31.88	93.68	54.00	39.68	AVG	No Limit

Test Mode: TX N-20M MODE 2437MHz

Horizontal

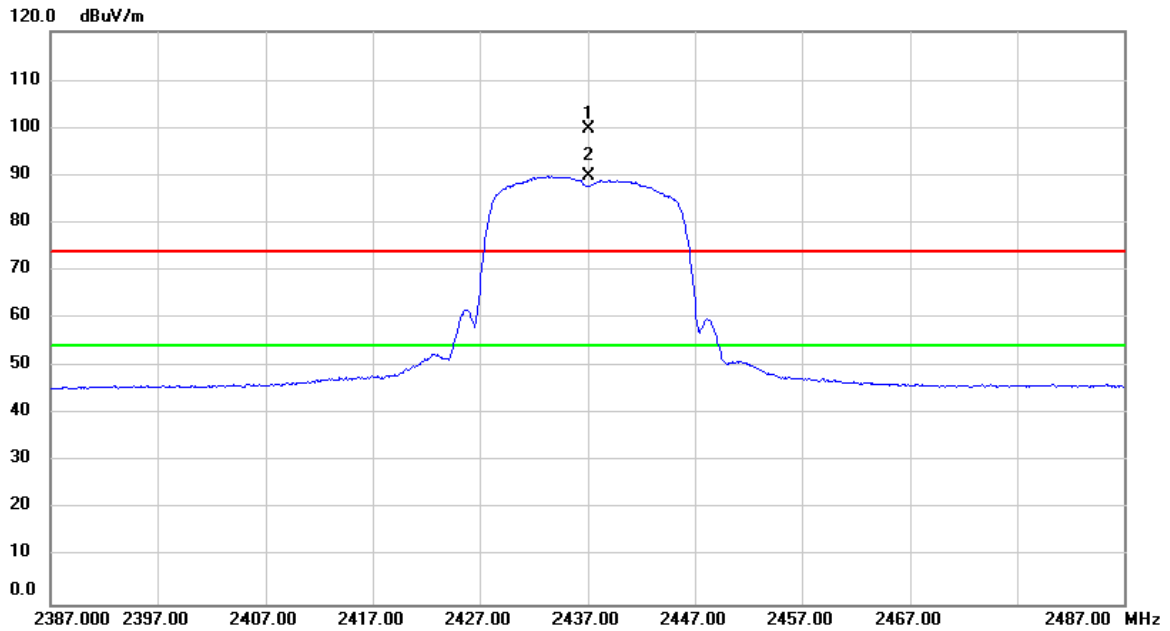

No.	Mk.	Freq. MHz	Reading Level dBuV	Correct Factor dB	Measure- ment dBuV/m	Limit dBuV/m	Over dB	Detector	Comment
1	X	2437.000	67.76	31.88	99.64	74.00	25.64	peak	No Limit
2	*	2437.000	57.86	31.88	89.74	54.00	35.74	AVG	No Limit

Test Mode: TX N-20M MODE 2462MHz

Vertical

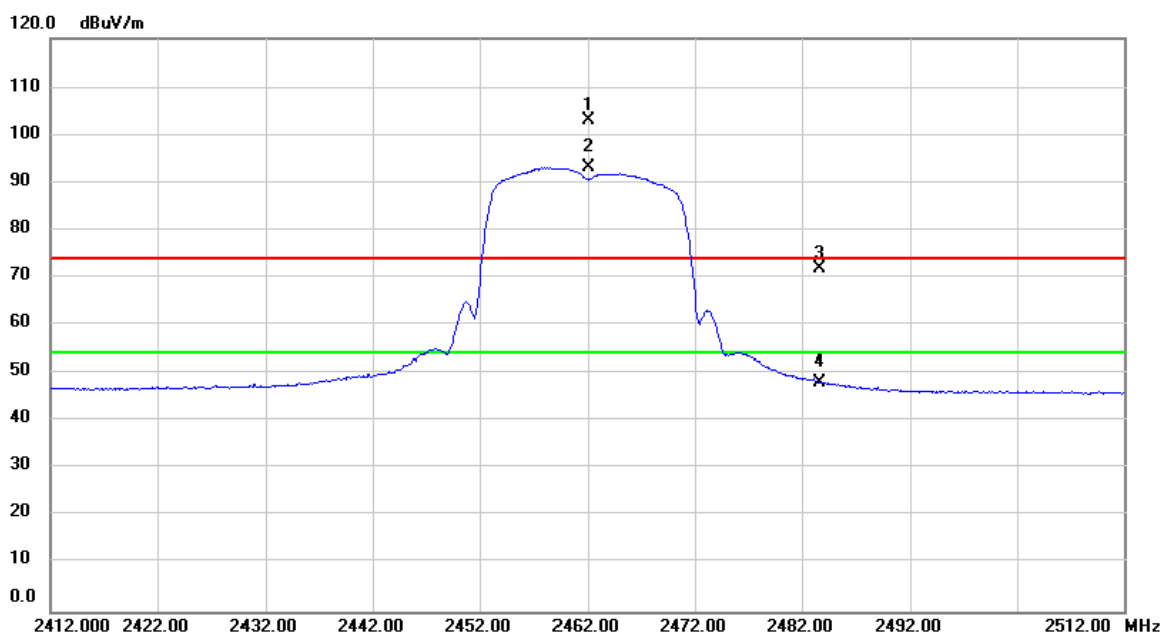

No.	Mk.	Freq. MHz	Reading Level dBuV	Correct Factor dB	Measure- ment dBuV/m	Limit dBuV/m	Over dB	Detector	Comment
1	X	2462.000	71.21	31.98	103.19	74.00	29.19	peak	No Limit
2	*	2462.000	61.17	31.98	93.15	54.00	39.15	AVG	No Limit
3		2483.700	39.84	32.06	71.90	74.00	-2.10	peak	
4		2483.700	16.21	32.06	48.27	54.00	-5.73	AVG	

Test Mode: TX N-20M MODE 2462MHz

Horizontal

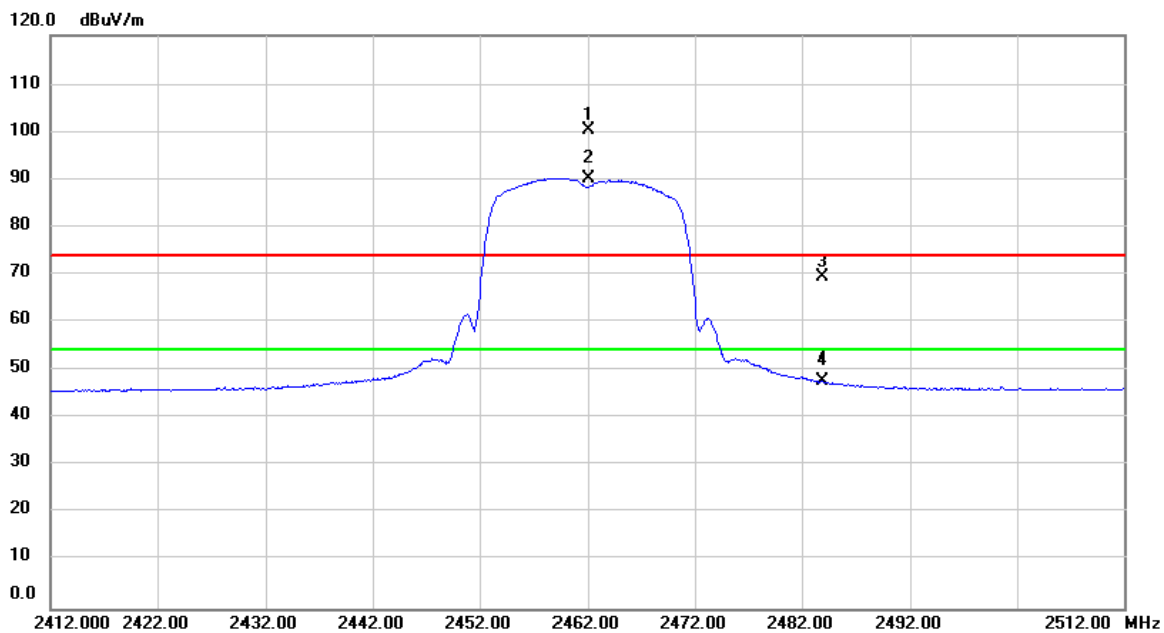

No.	Mk.	Freq. MHz	Reading Level dBuV	Correct Factor dB	Measure- ment dBuV/m	Limit dBuV/m	Over dB	Detector	Comment
1	X	2462.000	68.27	31.98	100.25	74.00	26.25	peak	No Limit
2	*	2462.000	58.23	31.98	90.21	54.00	36.21	AVG	No Limit
3		2483.900	37.48	32.06	69.54	74.00	-4.46	peak	
4		2483.900	15.71	32.06	47.77	54.00	-6.23	AVG	

ATTACHMENT F - BANDWIDTH

Test Mode: TX B Mode_CH01/06/11

Frequency (MHz)	6dB Bandwidth (MHz)	99% Occupied BW (MHz)	Min. Limit (kHz)	Test Result
2412	8.10	10.20	500	Complies
2437	8.08	10.20	500	Complies
2462	8.10	10.16	500	Complies

TX CH01

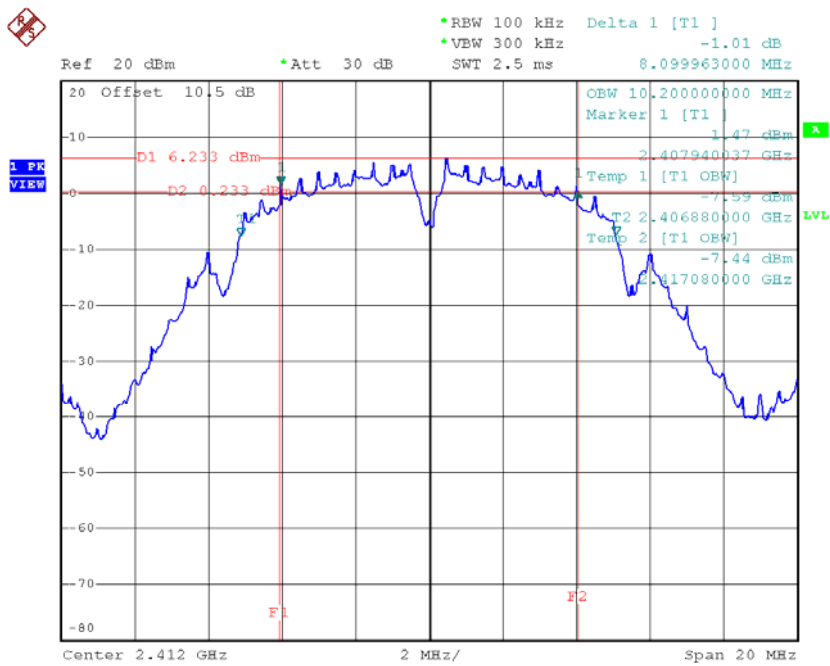

Date: 16.MAY.2016 14:35:27

TX CH06

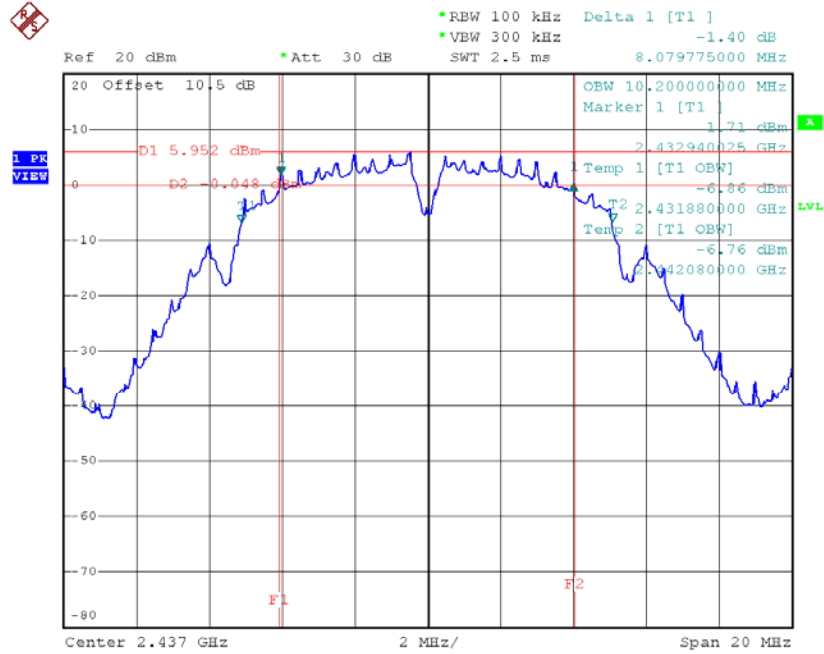

Date: 16.MAY.2016 14:37:05

TX CH11

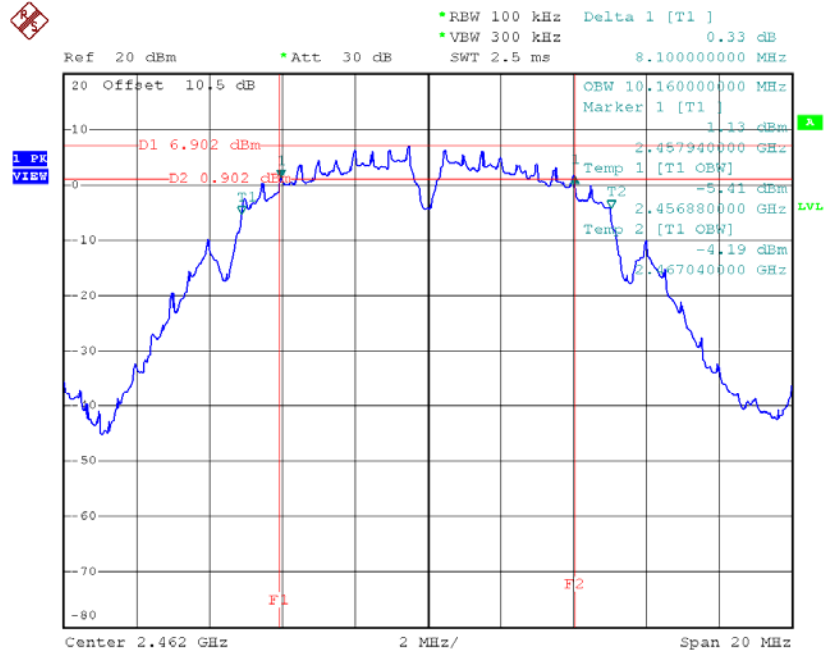

Date: 16.MAY.2016 14:38:17

Test Mode: TX G Mode_CH01/06/11

Frequency (MHz)	6dB Bandwidth (MHz)	99% Occupied BW (MHz)	Min. Limit (kHz)	Test Result
2412	15.60	16.36	500	Complies
2437	15.48	16.36	500	Complies
2462	15.18	16.36	500	Complies

TX CH01

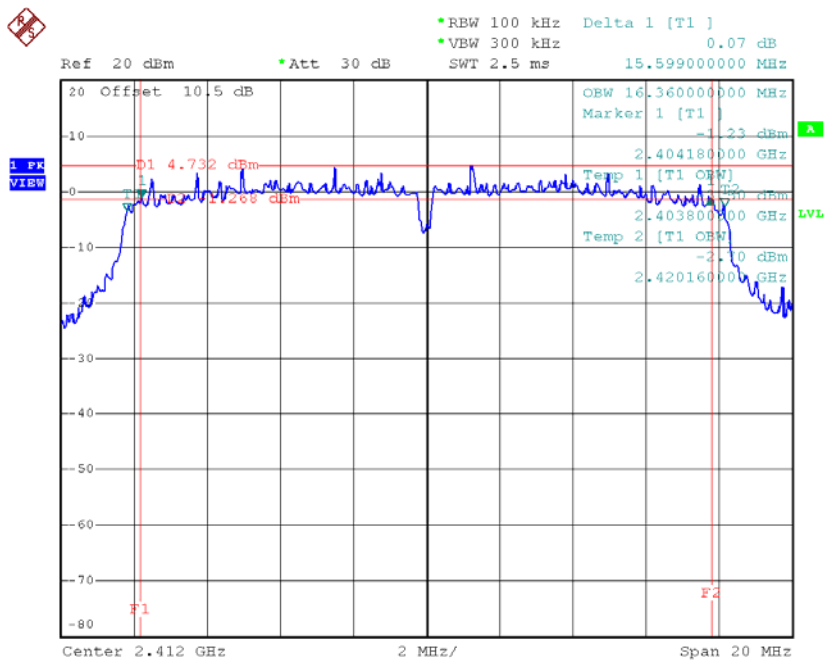

Date: 16.MAY.2016 14:39:32

TX CH06

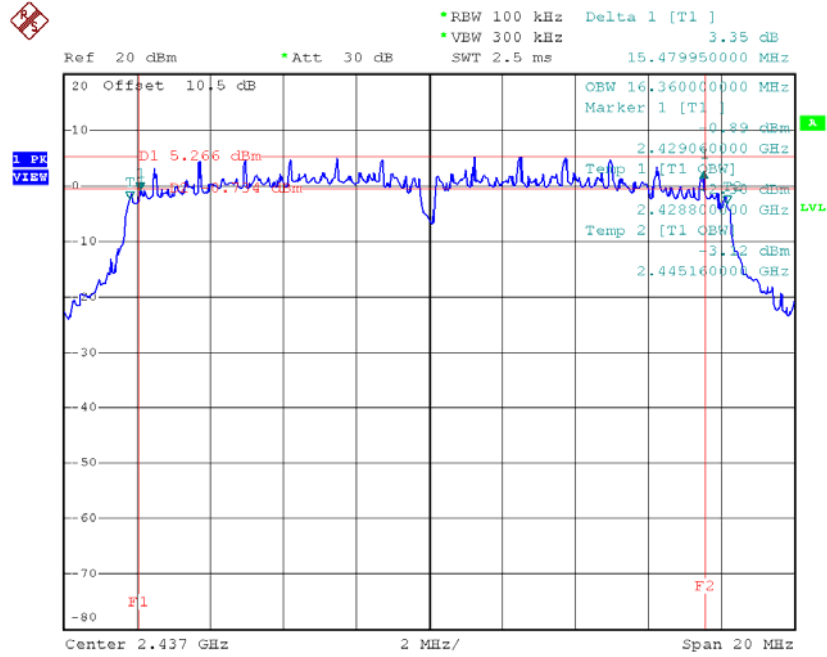

Date: 16.MAY.2016 14:40:49

TX CH11

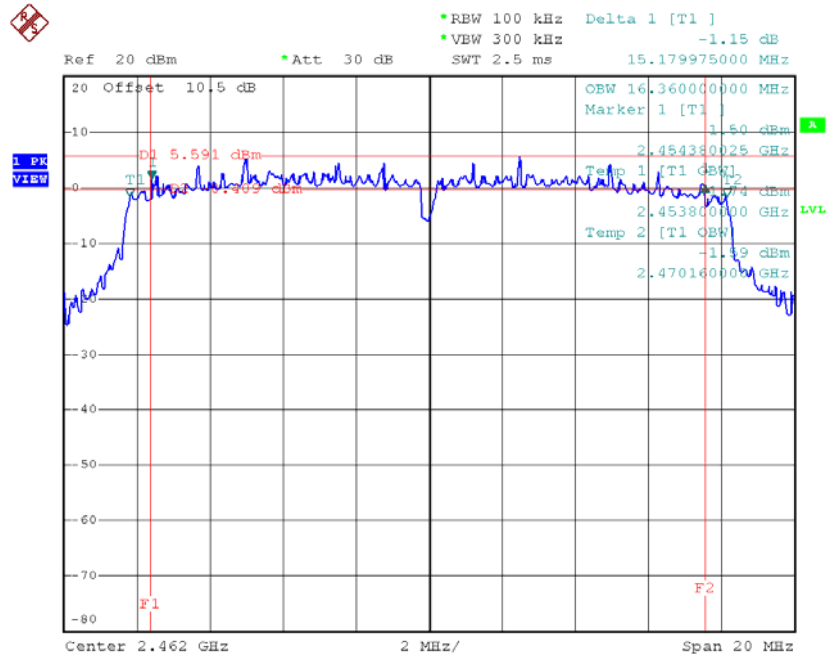

Date: 16.MAY.2016 14:41:47

Test Mode: TX N-20MHz Mode_CH01/06/11

Frequency (MHz)	6dB Bandwidth (MHz)	99% Occupied BW (MHz)	Min. Limit (kHz)	Test Result
2412	15.43	17.48	500	Complies
2437	15.19	17.48	500	Complies
2462	15.16	17.48	500	Complies

TX CH01

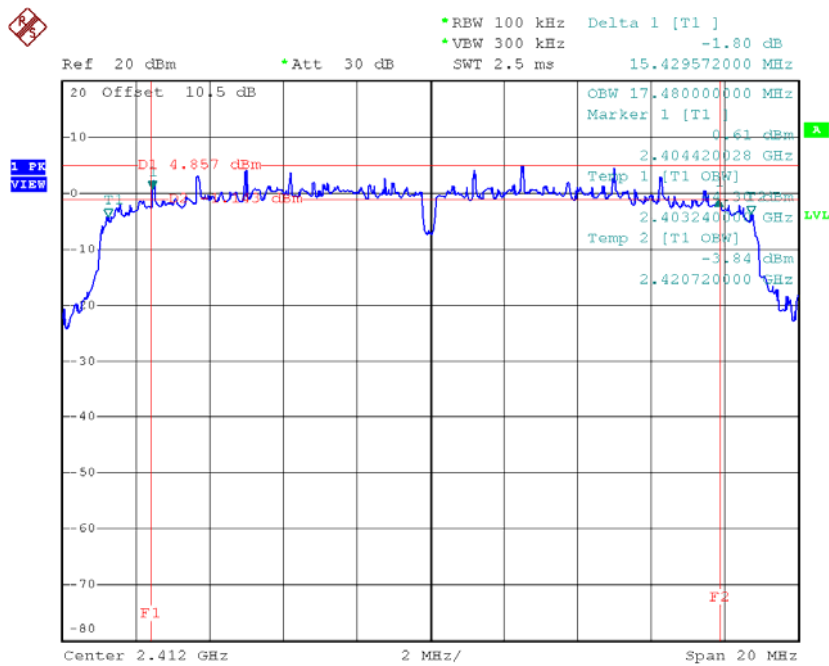

Date: 16.MAY.2016 14:43:19

TX CH06

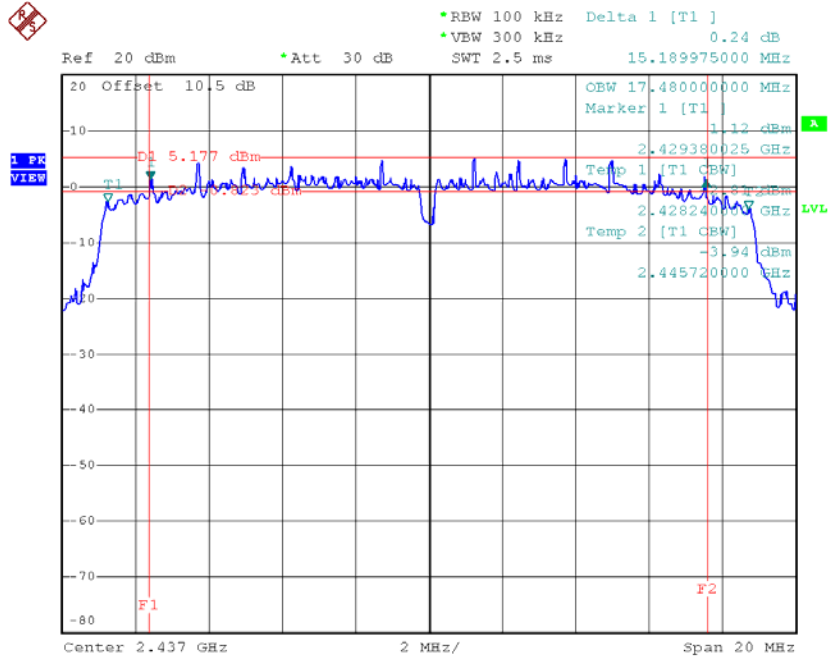

Date: 16.MAY.2016 14:44:21

TX CH11

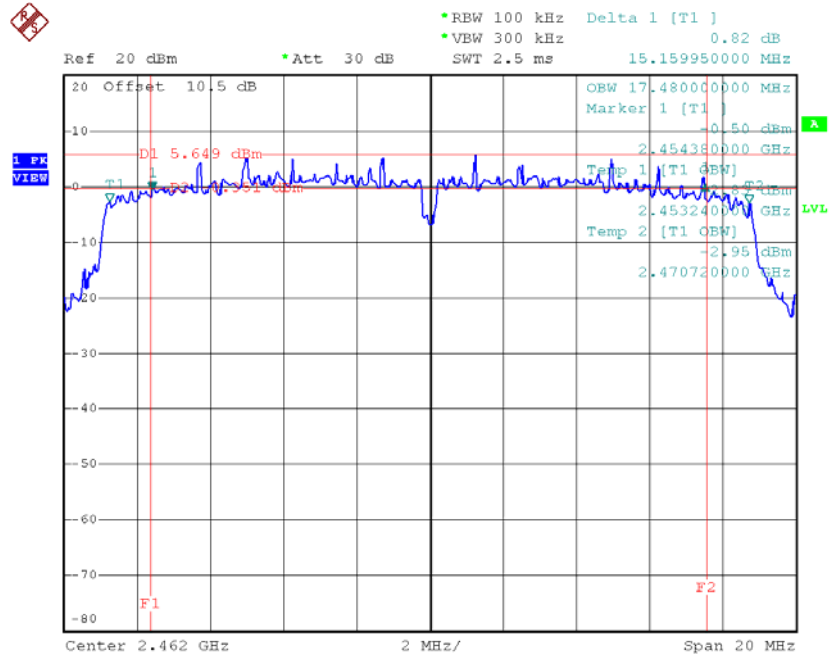

Date: 16.MAY.2016 14:48:58

ATTACHMENT G – MAXIMUM PEAK CONDUCTED OUTPUT POWER

Test Mode: TX B Mode_CH01/06/11					
Frequency (MHz)	Conducted Power (dBm)	Conducted Power (W)	Max. Limit (dBm)	Max. Limit (W)	Result
2412	17.00	0.0501	30.00	1.00	Complies
2437	17.35	0.0543	30.00	1.00	Complies
2462	17.75	0.0596	30.00	1.00	Complies

Test Mode: TX G Mode_CH01/06/11					
Frequency (MHz)	Conducted Power (dBm)	Conducted Power (W)	Max. Limit (dBm)	Max. Limit (W)	Result
2412	21.20	0.1318	30.00	1.00	Complies
2437	21.51	0.1416	30.00	1.00	Complies
2462	21.96	0.1570	30.00	1.00	Complies

Test Mode: TX N20 Mode_CH01/06/11					
Frequency (MHz)	Conducted Power (dBm)	Conducted Power (W)	Max. Limit (dBm)	Max. Limit (W)	Result
2412	21.08	0.1282	30.00	1.00	Complies
2437	21.47	0.1403	30.00	1.00	Complies
2462	21.82	0.1521	30.00	1.00	Complies

ATTACHMENT H - ANTENNA CONDUCTED SPURIOUS EMISSION

Test Mode: TX B Mode

TX B mode CH01

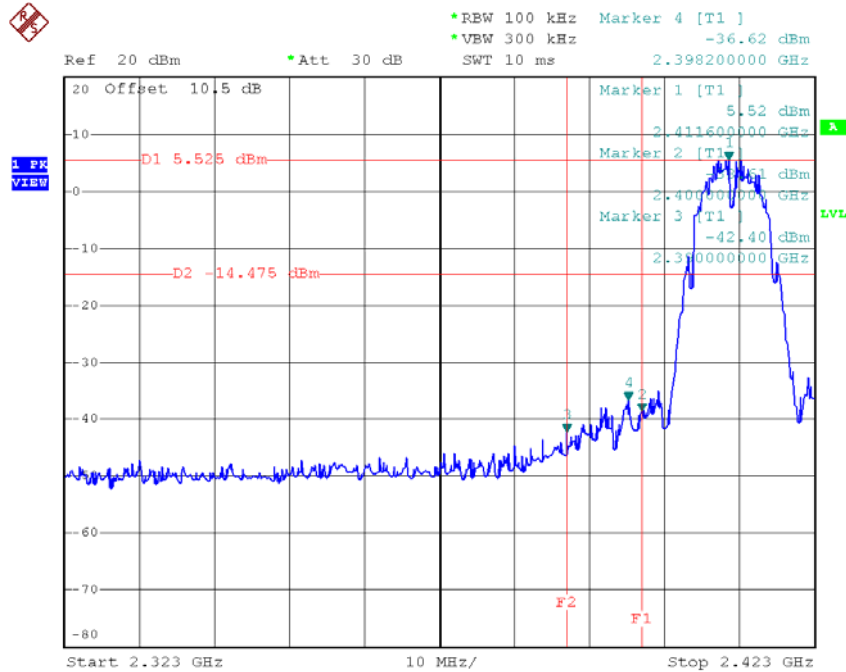

Date: 16.MAY.2016 14:36:03

TX B mode CH11

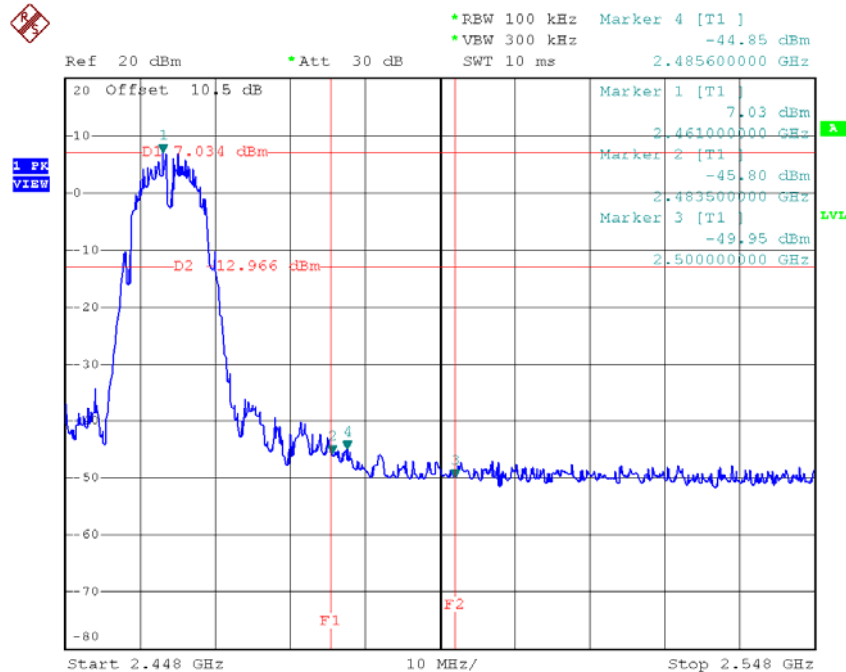

Date: 16.MAY.2016 14:38:52

TX B mode CH01 (10 Harmonic of the frequency)

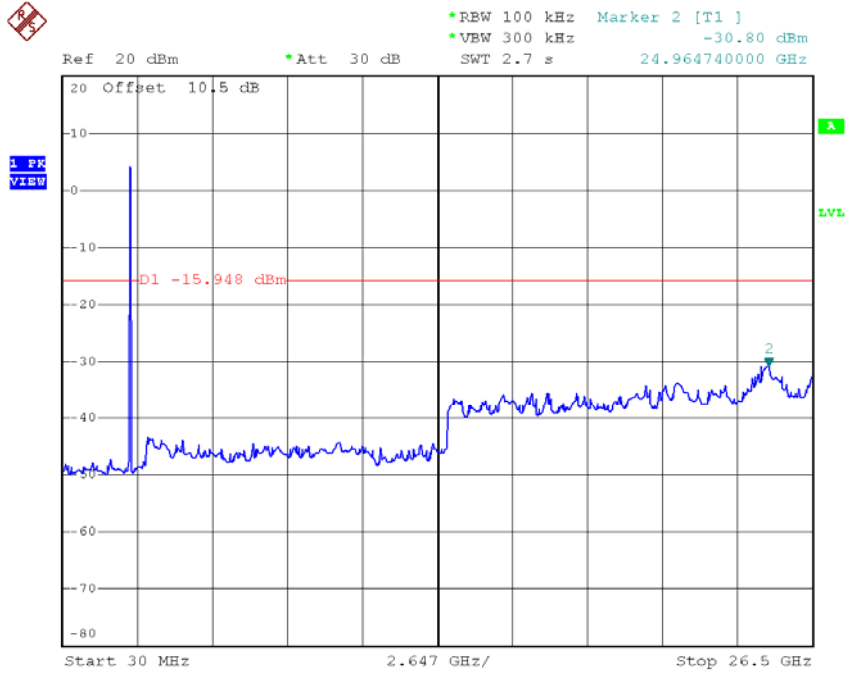

Date: 16.MAY.2016 14:37:17

TX B mode CH06 (10 Harmonic of the frequency)

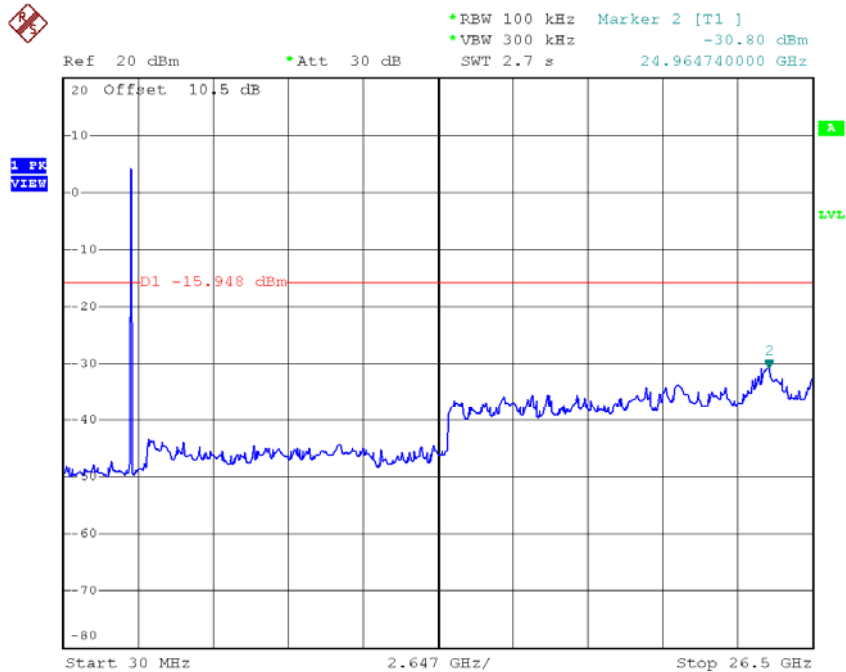

Date: 16.MAY.2016 14:37:17

TX B mode CH11 (10 Harmonic of the frequency)

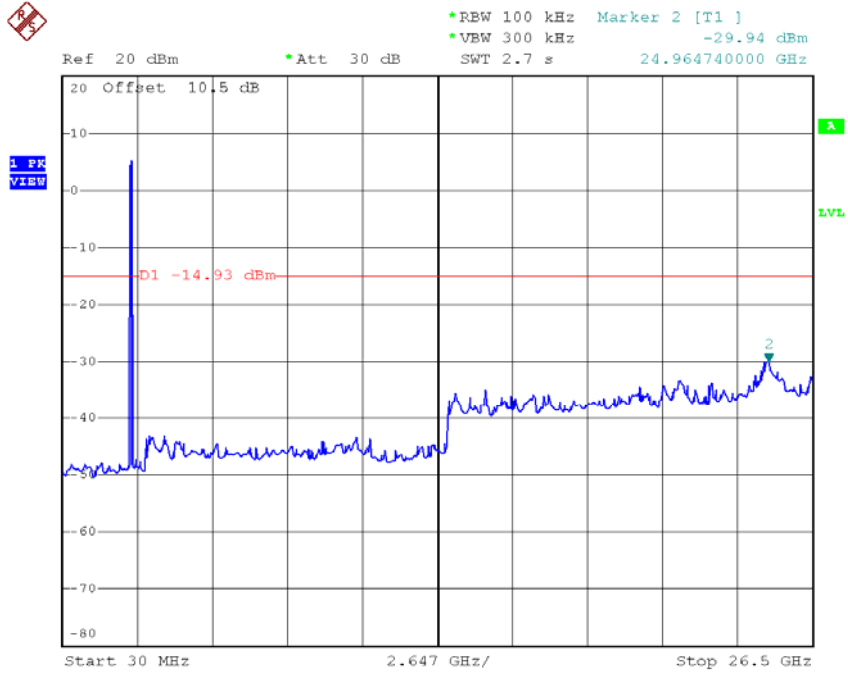

Date: 16.MAY.2016 14:38:29

Test Mode: TX G Mode

TX G mode CH01

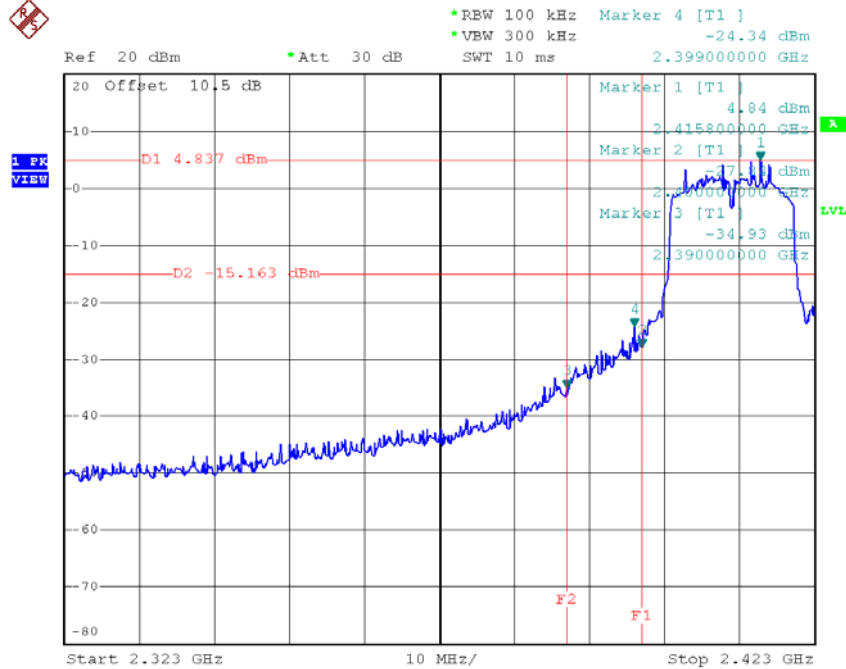

Date: 16.MAY.2016 14:40:08

TX G mode CH11

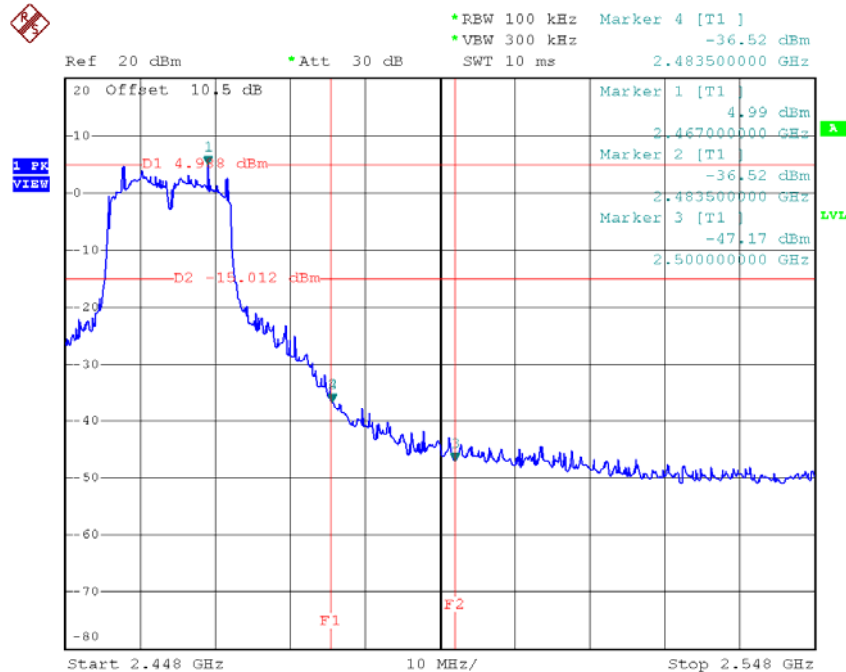

Date: 16.MAY.2016 14:42:23

TX G mode CH01 (10 Harmonic of the frequency)

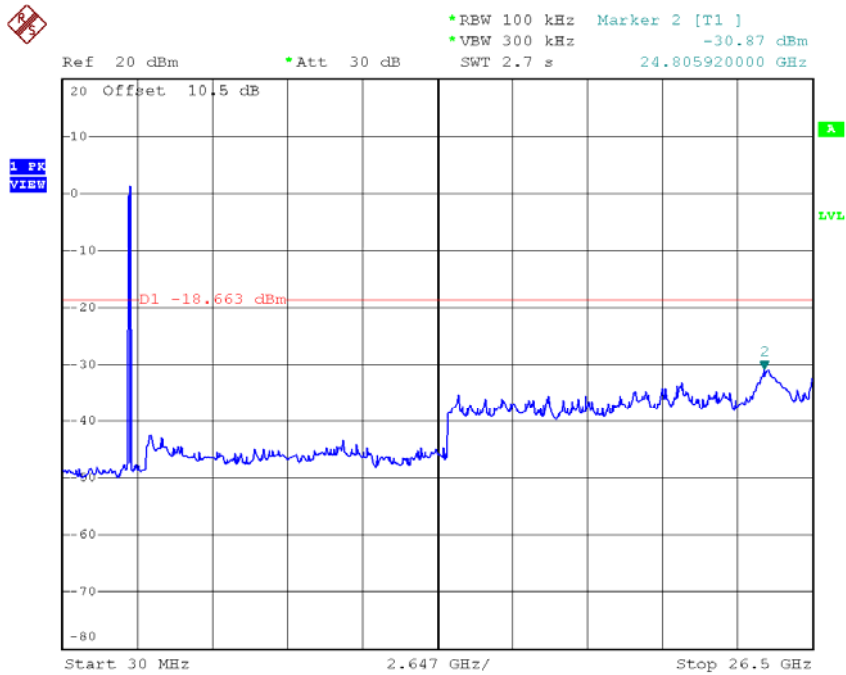

Date: 16.MAY.2016 14:39:45

TX G mode CH06 (10 Harmonic of the frequency)

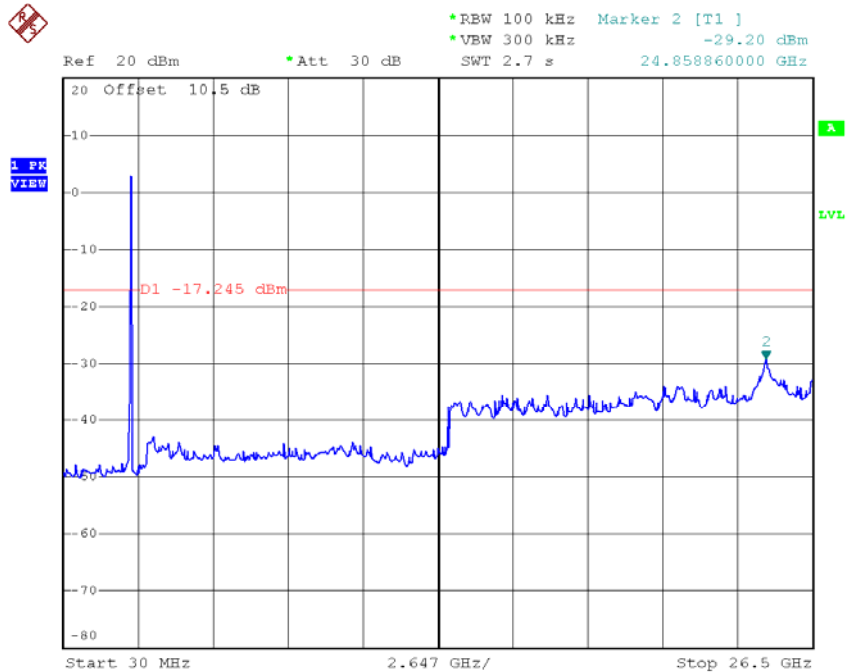

Date: 16.MAY.2016 14:41:01

TX G mode CH11 (10 Harmonic of the frequency)



*REW 100 kHz Marker 2 [T1]
*VBW 300 kHz -29.77 dBm
SWT 2.7 s 24.858860000 GHz

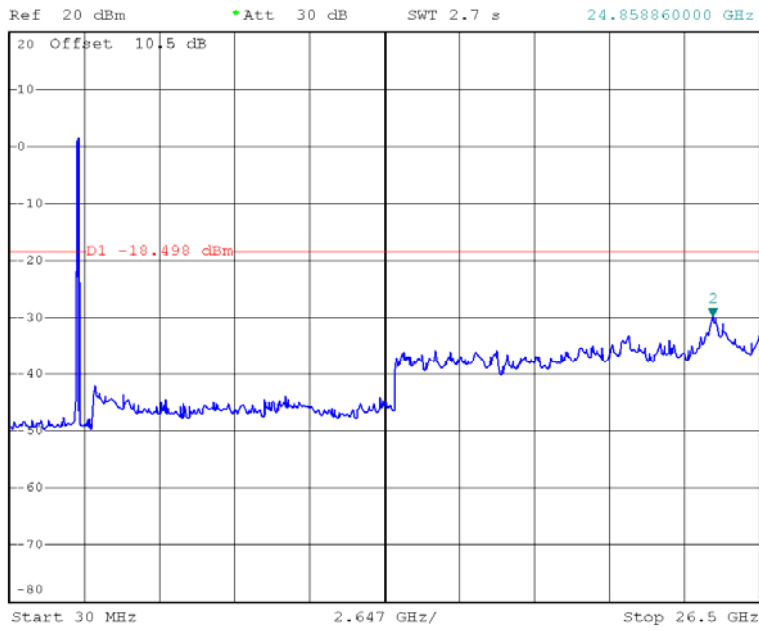

Date: 16.MAY.2016 14:42:00

Test Mode: TX N-20M Mode

TX HT20 mode CH01

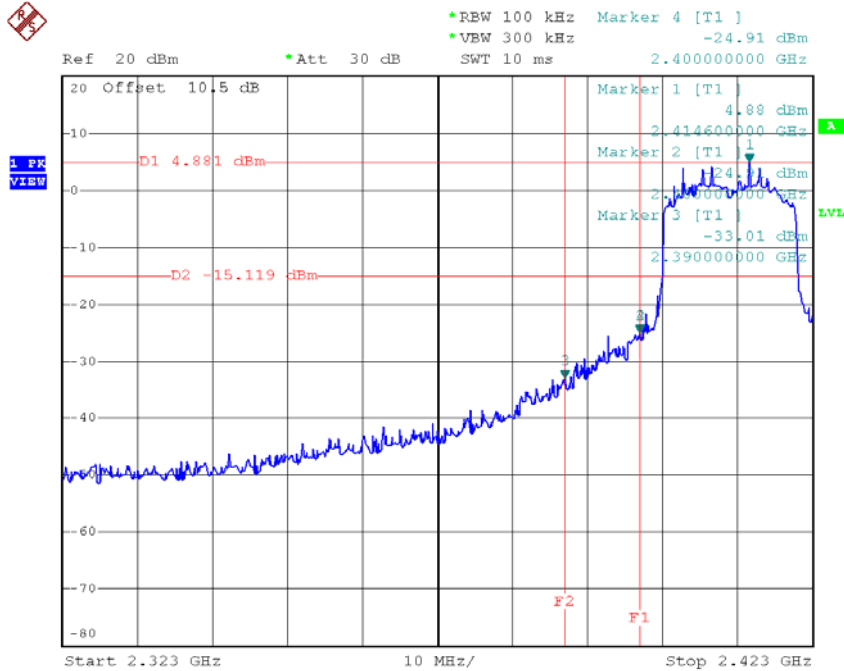

Date: 16.MAY.2016 14:43:38

TX HT20 mode CH11

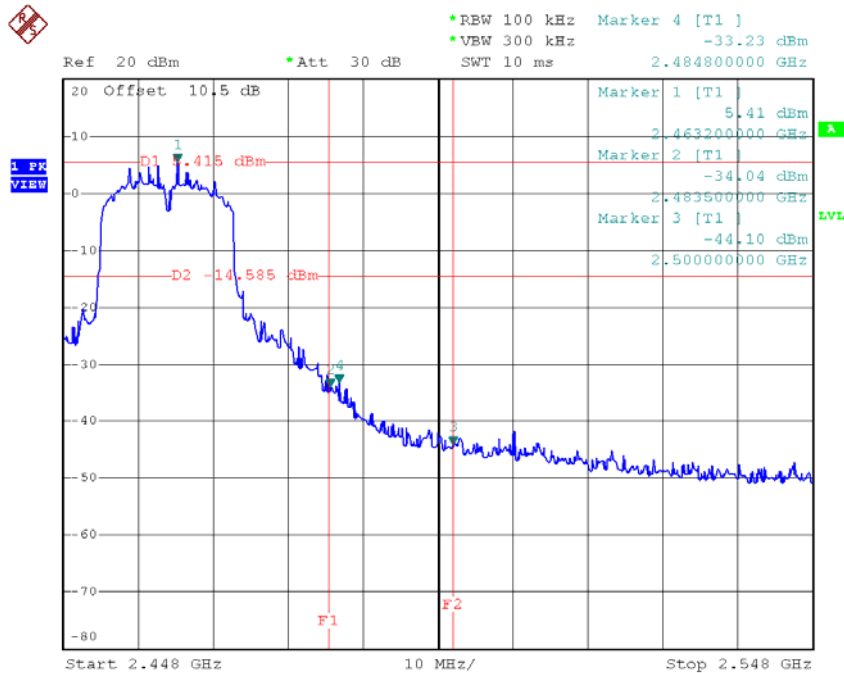

Date: 16.MAY.2016 14:49:34

TX HT20 mode CH01 (10 Harmonic of the frequency)

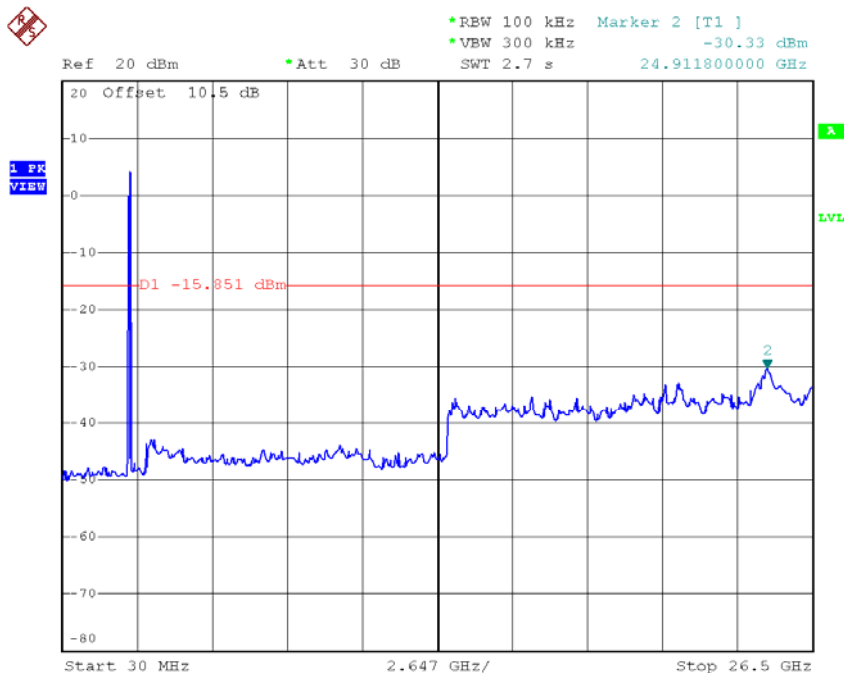

Date: 16.MAY.2016 14:43:32

TX HT20 mode CH06 (10 Harmonic of the frequency)

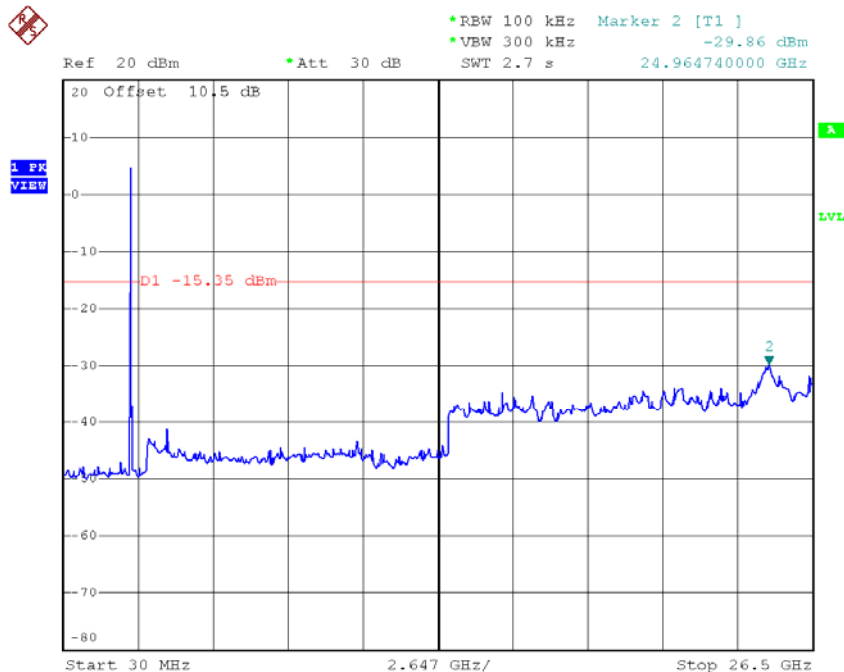

Date: 16.MAY.2016 14:44:33

TX HT20 mode CH11 (10 Harmonic of the frequency)



Ref 20 dBm *Att 30 dB *REW 100 kHz Marker 2 [T1]
*VBW 300 kHz -30.35 dBm
SWT 2.7 s 24.858860000 GHz

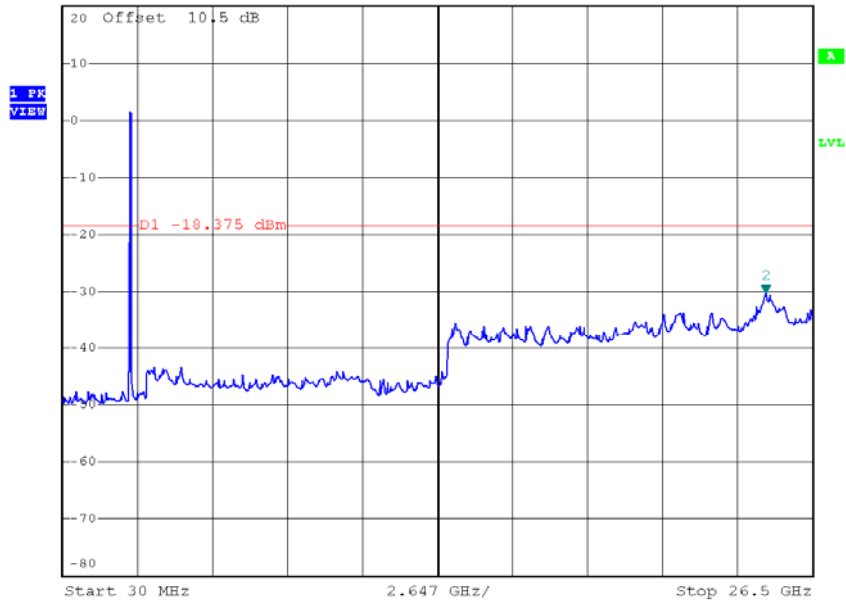

Date: 16.MAY.2016 14:49:10

ATTACHMENT I - POWER SPECTRAL DENSITY

Test Mode: TX B Mode_CH01/06/11

Frequency (MHz)	Power Density (dBm/3kHz)	Power Density (mW/3kHz)	Max. Limit (dBm/3kHz)	Result
2412	-8.23	0.15	8.00	Complies
2437	-8.91	0.13	8.00	Complies
2462	-8.15	0.15	8.00	Complies

TX CH01

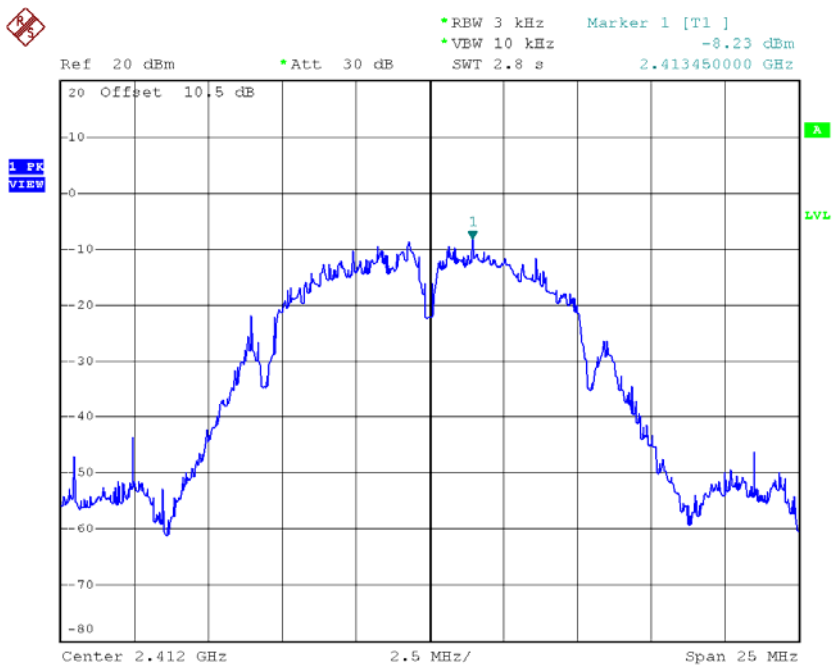

Date: 16.MAY.2016 14:36:11

TX CH06

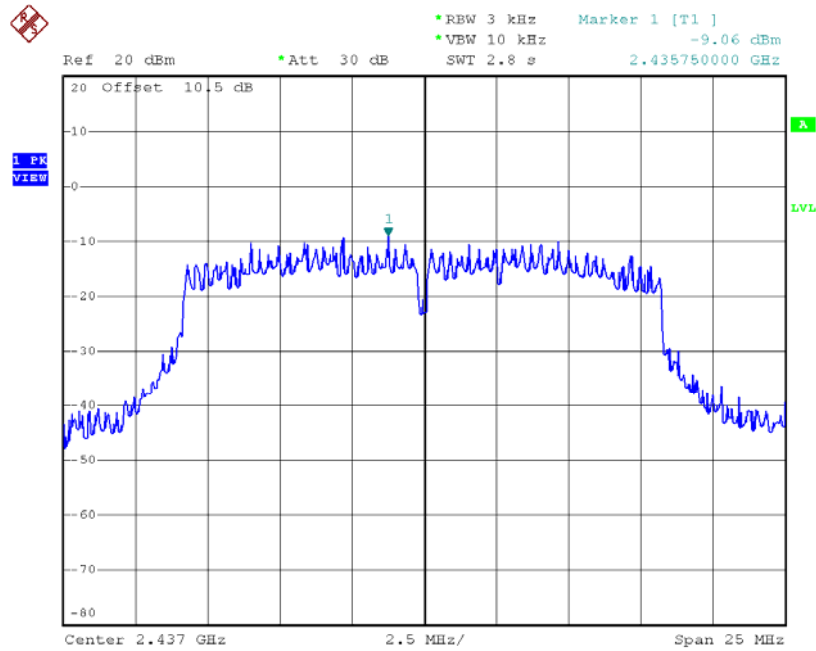

Date: 16.MAY.2016 14:41:09

TX CH11

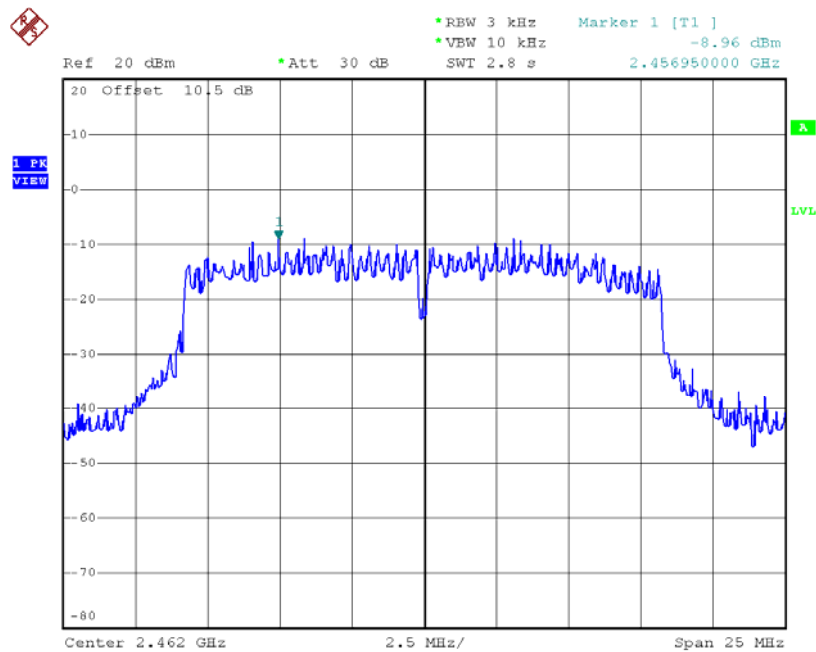

Date: 16.MAY.2016 14:42:31

Test Mode: TX N-20M Mode_CH01/06/11

Frequency (MHz)	Power Density (dBm/3kHz)	Power Density (mW/3kHz)	Max. Limit (dBm/3kHz)	Result
2412	-10.19	0.10	8.00	Complies
2437	-9.13	0.12	8.00	Complies
2462	-9.22	0.12	8.00	Complies

TX CH01

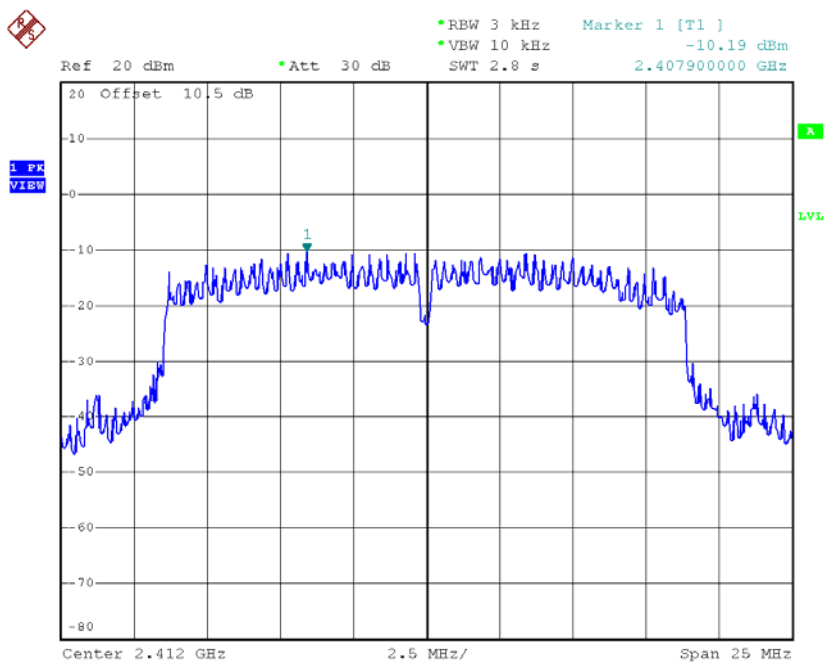

Date: 16.MAY.2016 14:43:46

TX CH06

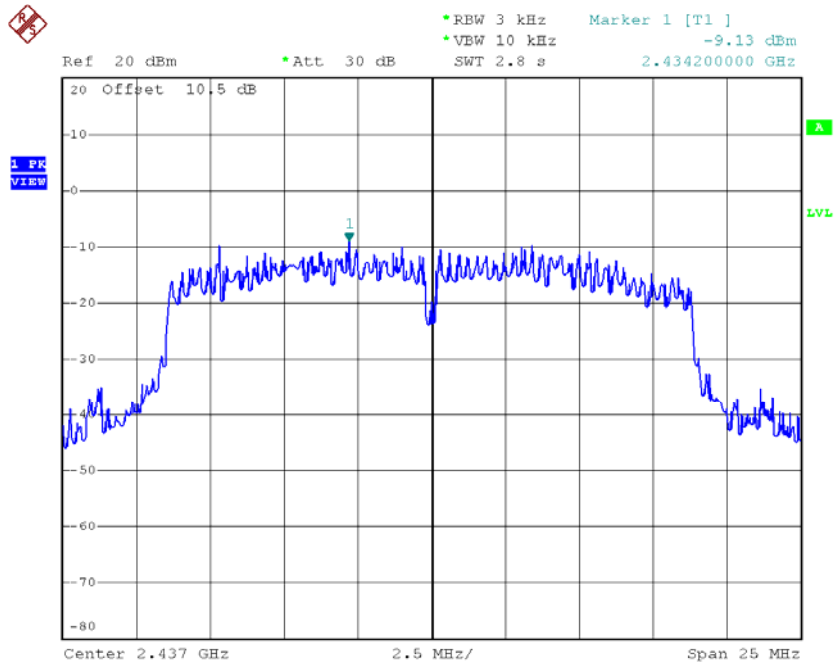

Date: 16.MAY.2016 14:44:41

TX CH11

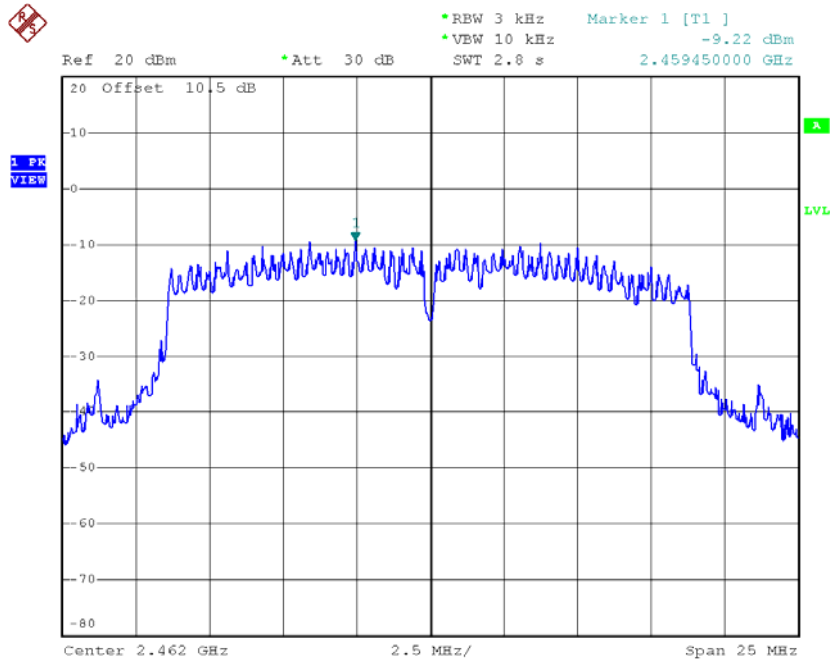

Date: 16.MAY.2016 14:49:42