

TEST REPORT

of

FCC Part 15 Subpart E §15.407 / RSS-210 Issue 8, RSS-Gen Issue 3

FCC ID/IC Certification : A3LWIDT30Q / 649E-WIDT30Q

Equipment Under Test : WiFi Module
Model Name : WIDT30Q
Serial No. : N/A
Applicant : SAMSUNG ELECTRONICS CO., LTD.
Manufacturer : SAMSUNG ELECTRONICS CO., LTD.
Date of Test(s) : 2013. 12.05 ~ 2013. 12.30
Date of Issue : 2013.12.31

In the configuration tested, the EUT complied with the standards specified above.

Tested By:



Date

2013. 12. 31

Wonjun Sim

Approved By:



Date

2013. 12. 31

Feel Jeong

The results shown in this test report refer only to the sample(s) tested unless otherwise stated. This test report cannot be reproduced, except in full, without prior written permission of the Company.

SGS Korea Co., Ltd. (Gunpo Laboratory) 18-34, Sanbon-dong, Gunpo-si, Gyeonggi-do, Korea, 435-040

RTT5041-20(2013.07.27)(1)

Tel. +82 31 428 5700 / Fax. +82 31 427 2371

www.ee.sgs.com/korea

Table of contents

| | |
|---|---|
| 1. General information ----- | 3 |
| 2. DFS (Dynamic Frequency Selection)----- | 5 |

The results shown in this test report refer only to the sample(s) tested unless otherwise stated. This test report cannot be reproduced, except in full, without prior written permission of the Company.

SGS Korea Co., Ltd. (Gunpo Laboratory) 18-34, Sanbon-dong, Gunpo-si, Gyeonggi-do, Korea, 435-040

RTT5041-20(2013.07.27)(1)

Tel. +82 31 428 5700 / Fax. +82 31 427 2371

www.ee.sgs.com/korea

1. General information

1.1 Testing laboratory

SGS Korea Co., Ltd. (Gunpo Laboratory)

- Wireless Div. 3FL, 18-34, Sanbon-dong, Gunpo-si, Gyeonggi-do, Korea 435-040

All SGS services are rendered in accordance with the applicable SGS conditions of service available on request and accessible at <http://www.sgs.com/en/Terms-and-Conditions.aspx>.

Phone No. : +82 31 428 5700

Fax No. : +82 31 427 2371

1.2 Details of applicant

Applicant : SAMSUNG ELECTRONICS CO., LTD.

Address : 129, Samsung-ro, Maetan-Dong, Yeongtong-gu, Suwon-si, Gyeonggi-do, 443-742
Rep. of Korea

Contact Person : Lee, Jaywoo

Phone No. : +82 31 277 2659

1.3. Description of EUT

| | | |
|-----------------------------|--|--|
| Kind of Product | WiFi Module | |
| Model Name | WIDT30Q | |
| Power Supply | DC 5.0 V | |
| Frequency Range | 2 412 MHz ~ 2 462 MHz (11b/g/n_HT20), 2 422 MHz ~ 2 452 MHz (11n_HT40), 5 745 MHz ~ 5 825 MHz (11a/n_HT20), 5 755 MHz ~ 5 795 MHz (11n_HT40), 5 180 MHz ~ 5 240 MHz (11a/n_HT20 – Non DFS), 5 190 MHz ~ 5 230 MHz (11n_HT40 – Non DFS), 5 260 MHz ~ 5 320 MHz (11a/n_HT20 – DFS), 5 270 MHz ~ 5 310 MHz (11n_HT40 – DFS), 5 500 MHz ~ 5 700 MHz (11a/n_HT20 – DFS), 5 510 MHz ~ 5 670 MHz (11n_HT40 – DFS) | |
| Modulation Technique | DSSS, OFDM, GFSK, $\pi/4$ DQPSK, 8DPSK | |
| Number of Channels | 11 channel (11b/g/n_HT20), 7 channel (11n_HT40), 5 channel (11a/n_HT20), 2 channel (11n_HT40), 4 channel (11a/n_HT20–Non DFS), 2 channel (11n_HT40 – Non DFS), 15 channel (11a/n_HT20 – DFS), 7 channel (11n_HT40 – DFS) | |
| Antenna Type | Internal type (MIMO - 2 Tx / 2 Rx) | |
| Antenna Gain | Ant0: 2 402 MHz ~ 2 480 MHz: 2.05 dB i, 5 180 MHz ~ 5 320 MHz: 2.69 dB i, 5 500 MHz ~ 5 700 MHz: -0.26 dB i, 5 745 MHz ~ 5 805 MHz: 1.35 dB i | Ant1: 2 402 MHz ~ 2 480 MHz: 0.94 dB i, 5 180 MHz ~ 5 320 MHz: 2.50 dB i, 5 500 MHz ~ 5 700 MHz: -1.66 dB i, 5 745 MHz ~ 5 805 MHz: -0.90 dB i |

1.4. Declaration by the manufacturer

- EUT is SLAVE without DFS and TPC.

The results shown in this test report refer only to the sample(s) tested unless otherwise stated. This test report cannot be reproduced, except in full, without prior written permission of the Company.

SGS Korea Co., Ltd. (Gunpo Laboratory) 18-34, Sanbon-dong, Gunpo-si, Gyeonggi-do, Korea, 435-040

RTT5041-20(2013.07.27)(1)

Tel. +82 31 428 5700 / Fax. +82 31 427 2371

www.ee.sgs.com/korea

1.5. Test equipment list

| Equipment | Manufacturer | Model | S/N | Cal Date | Cal Interval | Cal Due. |
|-------------------|------------------|------------|------------|---------------|--------------|---------------|
| Spectrum Analyzer | R&S | FSW43 | 100637 | Jul. 26, 2013 | Annual | Jul. 26, 2014 |
| Attenuator | AEROFLEX / INMET | 18N-20dB | 3 | Apr. 01, 2013 | Annual | Apr. 01, 2014 |
| Power Splitter | Mini-Circuits | ZFSC-2-10G | 001 | Jun. 07, 2013 | Annual | Jun. 07, 2014 |
| Power Splitter | Mini-Circuits | ZFSC-2-10G | 002 | Jun. 07, 2013 | Annual | Jun. 07, 2014 |
| DC Power Supply | Agilent | U8002A | MY50060028 | Mar. 28, 2013 | Annual | Mar. 28, 2014 |

► Support equipment

| Description | Manufacturer | Model | Serial Number / FCC ID |
|-----------------------|--------------|------------------|---------------------------------|
| Access Point(master) | Cisco | AIR-AP1262N-K-K9 | FTX1553K03A FCC ID:LDK102073 |
| Notebook | IBM | T43 | 2669CC8 |

1.6. Summary of test result

The EUT has been tested according to the following specifications:

| APPLIED STANDARD:FCC Part15, RSS-210,RSS-Gen | | | |
|--|--------------|---|----------|
| Standard section | | Test Item(s) | Result |
| 15.407(h) | RSS-210 A9.3 | DFS -Channel closing transmission time -Channel move time -Non occupied period | Complied |

1.7. Test report revision

| Revision | Report number | Description |
|----------|----------------------|-------------|
| 0 | F690501/RF-RTL007280 | Initial |

The results shown in this test report refer only to the sample(s) tested unless otherwise stated. This test report cannot be reproduced, except in full, without prior written permission of the Company.

SGS Korea Co., Ltd. (Gunpo Laboratory) 18-34, Sanbon-dong, Gunpo-si, Gyeonggi-do, Korea, 435-040

RTT5041-20(2013.07.27)(1)

Tel. +82 31 428 5700 / Fax. +82 31 427 2371

www.ee.sgs.com/korea

2. DFS (Dynamic Frequency Selection)

2.1. System overview

2.1.1. Set up of EUT

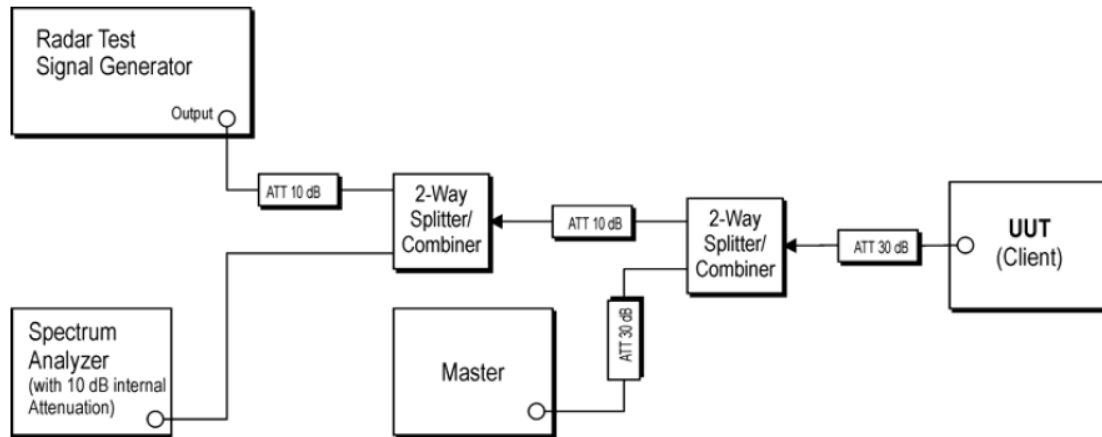

The radar signal generation equipment consists of a vector signal generator

The signal monitoring equipment consists of a spectrum analyzer set to display 8001 bins on the horizontal axis. The time domain resolution is 2 msec/bin with a 16 second sweep time, meeting the 10 second short pulse reporting criteria. The aggregate ON time is calculated by multiplying the number of bins above a threshold during a particular observation period by the dwell time per bin, with the analyzer set to peak detection and max hold.

The Slave is tested separately for compliance with the Channel Shutdown requirements, for the situation when the Slave device vacates the channel in response to detection of a radar by the Master.

All tests were performed at a channel center frequency of 5 300 MHz and 5 700 MHz. Measurements were performed using conducted test methods.

Stream the MPEG test file from the Master Device to the Client Device on the test Channel for the entire period of the test.

The designated MPEG test file and instructions are located at: <http://ntiacsd.ntia.doc.gov/dfs/>

The test file name is 'TestFile.mpg.'

The results shown in this test report refer only to the sample(s) tested unless otherwise stated. This test report cannot be reproduced, except in full, without prior written permission of the Company.

2.2 Limit

§15.407 (h) and FCC 06-96 APPENDIX “COMPLIANCE MEASUREMENT PROCEDURES FOR UNLICENSED-NATIONAL INFORMATION INFRASTRUCTURE DEVICES OPERATING IN THE 5250-5350 MHz AND 5470-5725 MHz BANDS INCORPORATING DYNAMIC FREQUENCY SELECTION

Table 1: Applicability of DFS requirements prior to use of a channel

| Requirement | Operational Mode | | |
|---------------------------------|------------------|----------------------------------|-------------------|
| | Master | Client (without DFS) | Client (with DFS) |
| Non-Occupancy Period | Yes | Yes (according to KDB 848637) | Yes |
| DFS Detection Threshold | Yes | Yes (according to KDB 848637) | Yes |
| Channel Availability Check Time | Yes | Not required | Not required |
| Uniform Spreading | Yes | Not required | Not required |

Table 2: Applicability of DFS requirements during normal operation

| Requirement | Operational Mode | | |
|-----------------------------------|------------------|----------------------|-------------------|
| | Master | Client (without DFS) | Client (with DFS) |
| DFS Detection Threshold | Yes | Not required | Yes |
| Channel Closing Transmission Time | Yes | Yes | Yes |
| Channel Move Time | Yes | Yes | Yes |

Table 3: Interference Threshold values, Master or Client incorporating In-Service Monitoring

| Maximum Transmit Power | Value (see note) |
|------------------------|------------------|
| ≥ 200 milliwatt | -64 dB m |
| < 200 milliwatt | -62 dB m |

Note 1: This is the level at the input of the receiver assuming a 0 dB i receive antenna Note 2: Throughout these test procedures an additional 1 dB has been added to the amplitude of the test transmission waveforms to account for variations in measurement equipment. This will ensure that the test signal is at or above the detection threshold level to trigger a DFS response.

KDB 848637 : Non-Occupancy Period for Client Device without radar detection

- Test results demonstrating an associated client link is established with the master on a test frequency;
 - The client and DFS-certified master device are associated, and a movie can be streamed as specified in the DFS Order for a non-occupancy period test;
 - The test frequency has been monitored to ensure no transmission of any type has occurred for 30 minutes.
- Note: If the client moves with the master, the device is considered compliant if nothing appears in the client non-occupancy period test. For devices that shut down (rather than moving channels), no beacons should appear;
- An analyzer plot that contains a single 30-minute sweep on the original channel.

The results shown in this test report refer only to the sample(s) tested unless otherwise stated. This test report cannot be reproduced, except in full, without prior written permission of the Company.

Table 4: DFS Response requirement values

| Parameter | Value |
|-----------------------------------|--|
| Non-occupancy period | 30 minutes |
| Channel Availability Check Time | 60 seconds |
| Channel Move Time | 10 seconds |
| Channel Closing Transmission Time | 200 milliseconds + approx. 60 milliseconds over remaining 10 second period |

The instant that the Channel Move Time and the Channel Closing Transmission Time begins is as follows: For the Short pulse radar Test Signals this instant is the end of the Burst. For the Frequency Hopping radar Test Signal, this instant is the end of the last radar burst generated. For the Long Pulse radar Test Signal this instant is the end of the 12 second period defining the radar transmission. The Channel Closing Transmission Time is comprised of 200 milliseconds starting at the beginning of the Channel Move Time plus any additional intermittent control signals required to facilitate channel changes (an aggregate of approximately 60 milliseconds) during the remainder of the 10 second period. The aggregate duration of control signals will not count quiet periods in between transmissions.

Table 5 – Short Pulse Radar Test Waveforms

| Radar Type | Pulse Width (Microseconds) | PRI (Microseconds) | Pulses | Minimum Percentage of Successful Detection | Minimum Trials |
|-----------------------------|----------------------------|--------------------|--------|--|----------------|
| 1 | 1 | 1428 | 18 | 60% | 30 |
| 2 | 1-5 | 150-230 | 23-29 | 60% | 30 |
| 3 | 6-10 | 200-500 | 16-18 | 60% | 30 |
| 4 | 11-20 | 200-500 | 12-16 | 60% | 30 |
| Aggregate (Radar Types 1-4) | | | | 80% | 120 |

Table 6 – Long Pulse Radar Test Signal

| Radar Waveform | Bursts | Pulses per Burst | Pulse Width (µsec) | Chirp Width (MHz) | PRI (µsec) | Minimum Percentage of Successful Detection | Minimum Trials |
|----------------|--------|------------------|--------------------|-------------------|------------|--|----------------|
| 5 | 8-20 | 1-3 | 50-100 | 5-20 | 10002000 | 80% | 30 |

Table 7 – Frequency Hopping Radar Test Signal

| Radar Waveform | Pulse Width (µsec) | PRI (µsec) | Burst Length (ms) | Pulses per Hop | Hopping Rate (kHz) | Minimum Percentage of Successful Detection | Minimum Trials |
|----------------|--------------------|------------|-------------------|----------------|--------------------|--|----------------|
| 6 | 1 | 333 | 300 | 9 | 0.333 | 70% | 30 |

The results shown in this test report refer only to the sample(s) tested unless otherwise stated. This test report cannot be reproduced, except in full, without prior written permission of the Company.

2.3. Description of EUT

The EUT operates over the 5 260 MHz ~ 5 320 MHz (11a/n-HT20-DFS), 5 270 MHz ~ 5 310 MHz (11n-HT40-DFS), 5 500 MHz ~ 5700 MHz (11a/n-HT20-DFS), and 5 510 MHz ~ 5670 MHz (11n-HT40-DFS) range.

The gain antenna assembly utilized with the master has a gain of 3.5 dB i.

The rated output power of the master unit is <200 milliwatt. Therefore the required interference threshold level is -62 dB m. After correction for antenna gain and procedure adjustments the required conducted threshold at the antenna port is $-62 + 3.5 = -58.50$ dB m

The calibrated conducted DFS Detection Threshold level is is -60 dB m

The results shown in this test report refer only to the sample(s) tested unless otherwise stated. This test report cannot be reproduced, except in full, without prior written permission of the Company.

SGS Korea Co., Ltd. (Gunpo Laboratory) 18-34, Sanbon-dong, Gunpo-si, Gyeonggi-do, Korea, 435-040

RTT5041-20(2013.07.27)(1)

Tel. +82 31 428 5700 / Fax. +82 31 427 2371

www.ee.sgs.com/korea

PLOTS OF RADAR WAVEFORMS AND WLAN TRAFFIC

Plot of radar waveform type 1

5 280 MHz

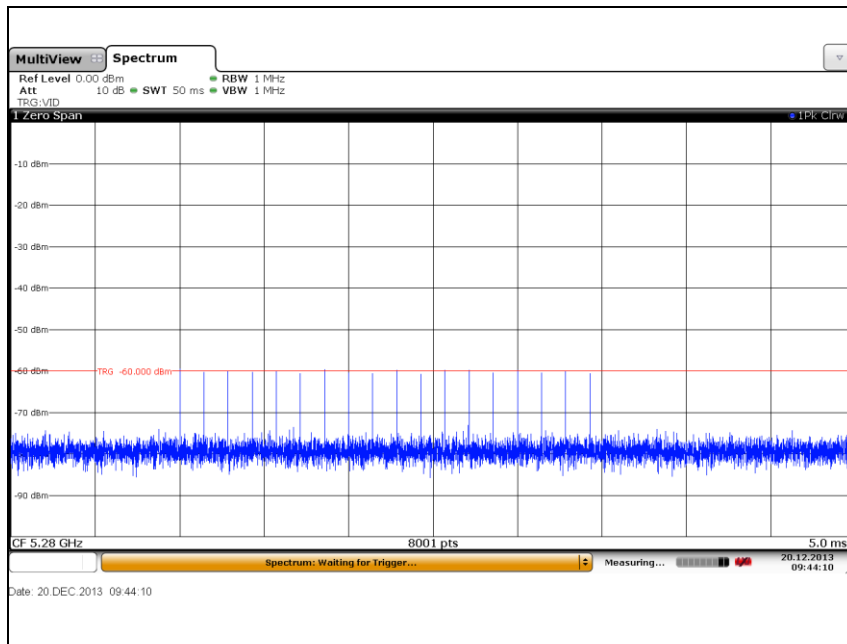

5 540 MHz

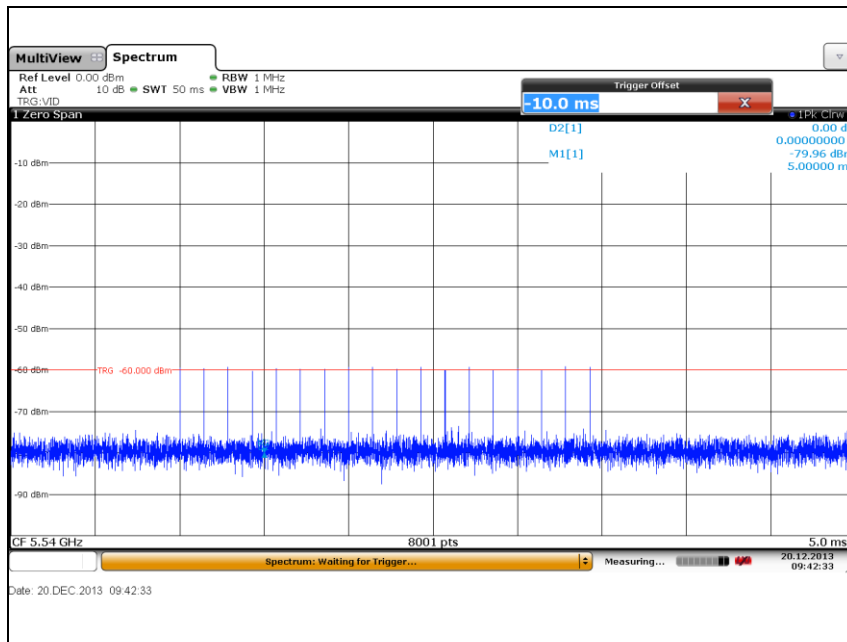

The results shown in this test report refer only to the sample(s) tested unless otherwise stated. This test report cannot be reproduced, except in full, without prior written permission of the Company.

Plot of LAN traffic

5 280 MHz

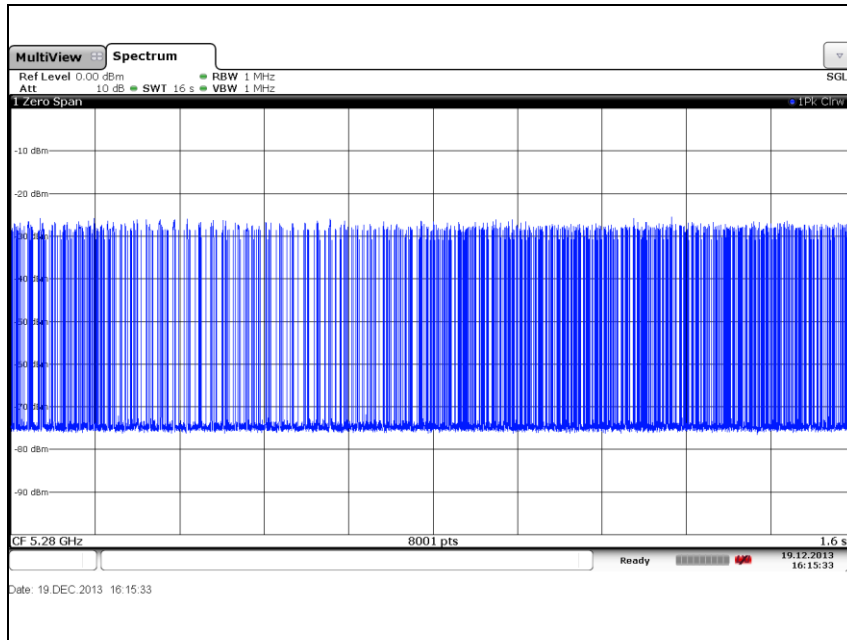

5 540 MHz

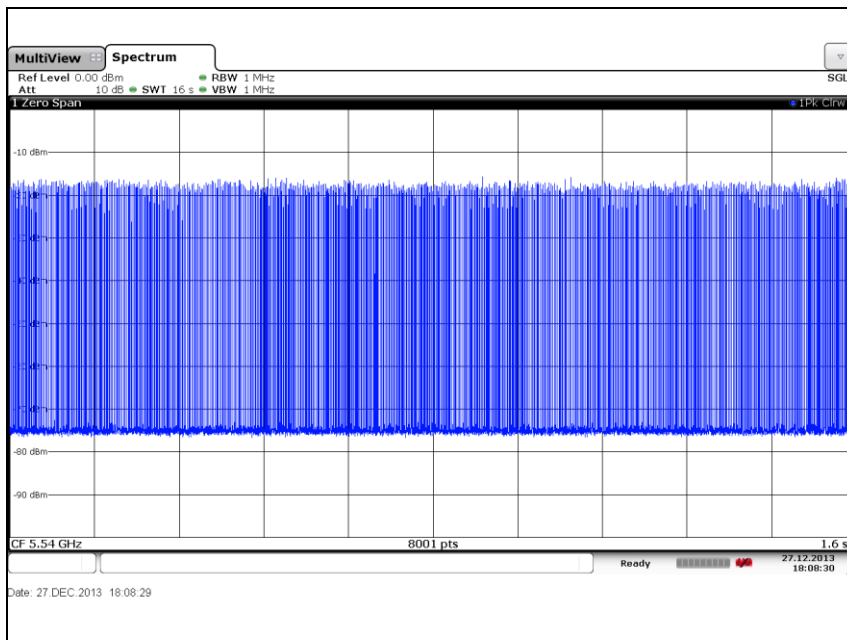

The results shown in this test report refer only to the sample(s) tested unless otherwise stated. This test report cannot be reproduced, except in full, without prior written permission of the Company.

SGS Korea Co., Ltd. (Gunpo Laboratory) 18-34, Sanbon-dong, Gunpo-si, Gyeonggi-do, Korea, 435-040

RTT5041-20(2013.07.27)(1)

Tel. +82 31 428 5700 / Fax. +82 31 427 2371

www.ee.sgs.com/korea

The reference maker is set after 200 ms from the end of Last radar pulse.

The delta is set at the end of the last WLAN transmission following the radar pulse. This delta is the channel move time within the 10 sec.

The aggregate channel closing transmission time is calculated as follows:

Aggregate Transmission Time= (Number of analyzer bins showing transmission)*(dwell time per bin)

The observation period over which the aggregated time is calculated begins at (Reference Maker) and ends no earlier than (Reference Maker +10 sec)

2.3. Test result

| Frequency (MHz) | Channel Move Time (sec) | Limit |
|-----------------|--|--------------------|
| 5 280 | 4.010 | Not exceed 10 sec |
| 5 540 | 3.872 | |
| Frequency (MHz) | Aggregate channel closing transmission time (msec) | Limit |
| 5 280 | 6 | Not exceed 60 msec |
| 5 540 | 8 | |

Aggregate channel closing transmission time

[16s (sweep time) / 8001 (sweep point)] × The number of channel bin from 200 ms at the end of radar pulse.

Time of a bin = 2 ms

5 260 MHz: (16 / 8001) × 3 = 6 ms

5 500 MHz: (16 / 8001) × 4 = 8 ms

| Frequency (MHz) | Non-occupancy period (min) | Limit |
|-----------------|----------------------------|----------------------------|
| 5 300 | Above 30 | Not be less than 30 minute |
| 5 700 | Above 30 | |

The results shown in this test report refer only to the sample(s) tested unless otherwise stated. This test report cannot be reproduced, except in full, without prior written permission of the Company.

Plot of channel move time & aggregate channel closing transmission time

5 280 MHz

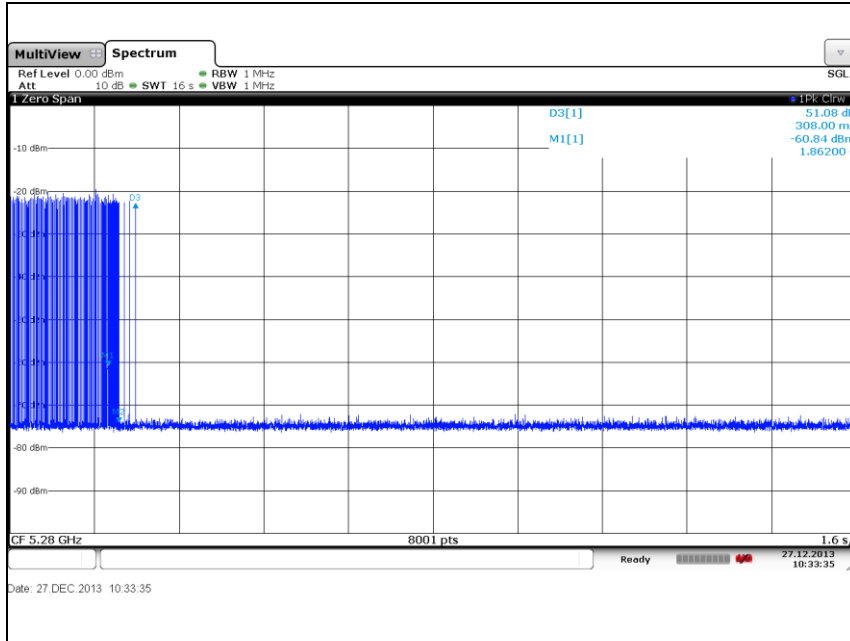

5 540 MHz

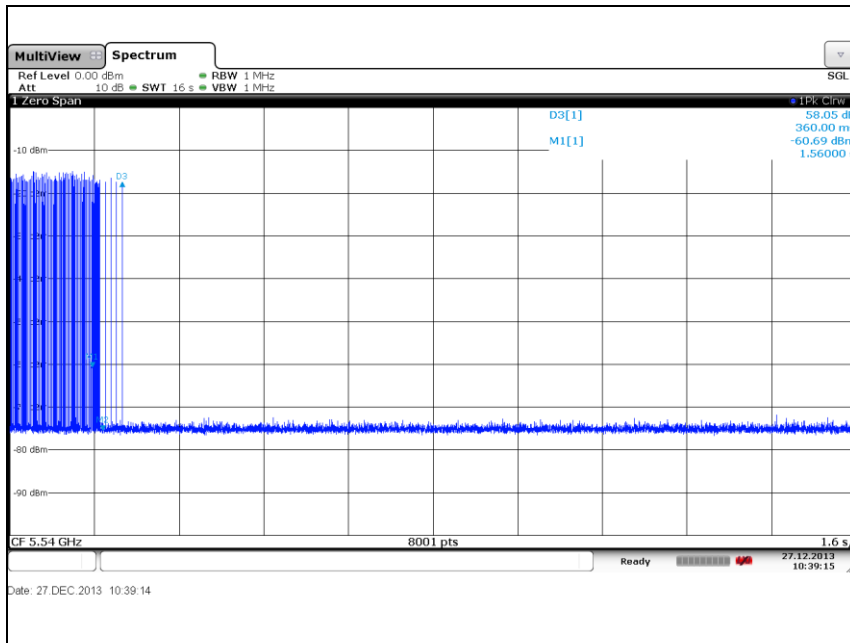

The results shown in this test report refer only to the sample(s) tested unless otherwise stated. This test report cannot be reproduced, except in full, without prior written permission of the Company.

Plot of Non-occupancy period

5 280 MHz

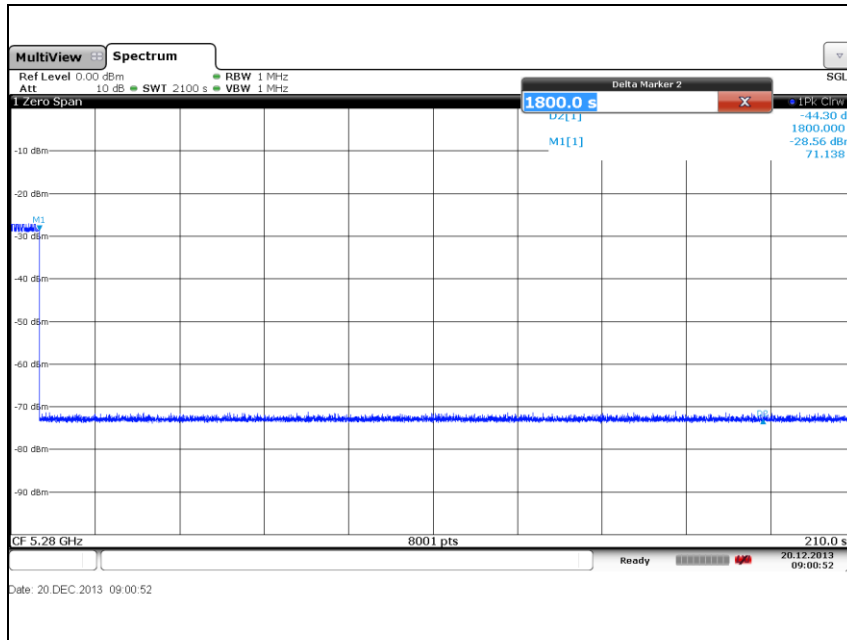

5 540 MHz

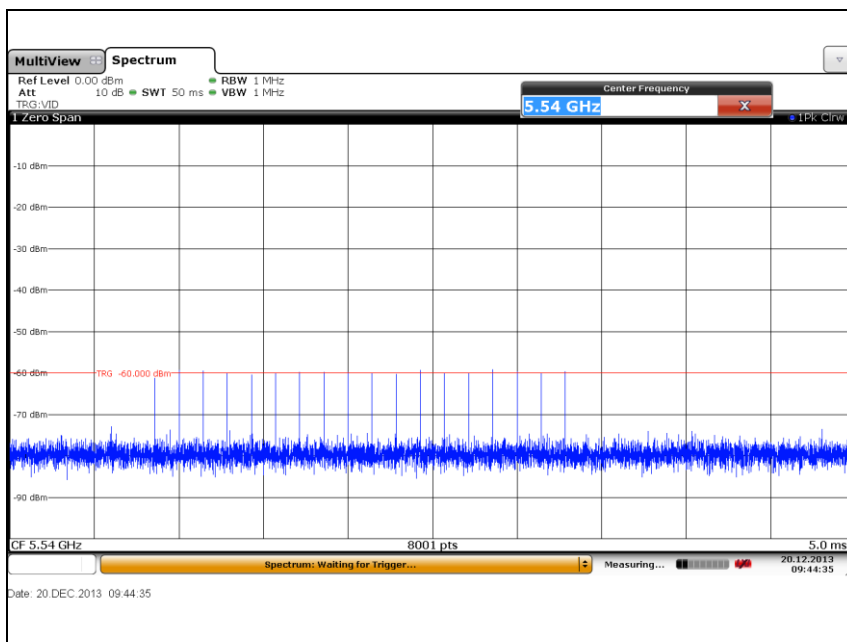

The results shown in this test report refer only to the sample(s) tested unless otherwise stated. This test report cannot be reproduced, except in full, without prior written permission of the Company.

SGS Korea Co., Ltd. (Gunpo Laboratory) 18-34, Sanbon-dong, Gunpo-si, Gyeonggi-do, Korea, 435-040

RTT5041-20(2013.07.27)(1)

Tel. +82 31 428 5700 / Fax. +82 31 427 2371

www.ee.sgs.com/korea