



**FCC 47 CFR PART 15 SUBPART C &  
INDUSTRY CANADA RSS-210**

**TEST REPORT**

**For**

**Wifi Module**

**Model: WDF710Q**

**Trade Name: Samsung**

*Issued to*

**For FCC**

**SAMSUNG ELECTRONICS CO., LTD.**

**19 Chapin Rd., Building D Pine Brook, New Jersey, United States, 07058**

**For IC:**

**SAMSUNG ELECTRONICS CO., LTD.**

**#129 Samsung-Ro, Yeongtong-Gu**

**Suwon-Si, Gyeonggi-Do 443-742 Korea, Republic of**

*Issued by*

**Compliance Certification Services Inc.**

**No.11, Wugong 6th Rd., Wugu Dist.,**

**New Taipei City 24891, Taiwan. (R.O.C.)**

**<http://www.ccsrf.com>**

**[service@ccsrf.com](mailto:service@ccsrf.com)**

**Issued Date: August 28, 2013**



*Note: This report shall not be reproduced except in full, without the written approval of Compliance Certification Services Inc. This document may be altered or revised by Compliance Certification Services Inc. personnel only, and shall be noted in the revision section of the document.*



**Revision History**

| Rev. | Issue Date      | Revisions     | Effect Page | Revised By  |
|------|-----------------|---------------|-------------|-------------|
| 00   | August 28, 2013 | Initial Issue | ALL         | Eunice Shen |



## TABLE OF CONTENTS

|   |            |
|---|------------|
| <b>1. TEST RESULT CERTIFICATION.....</b>                | <b>4</b>   |
| <b>2. EUT DESCRIPTION .....</b>                         | <b>5</b>   |
| <b>3. TEST METHODOLOGY .....</b>                        | <b>6</b>   |
| 3.1 EUT CONFIGURATION .....                             | 6          |
| 3.2 EUT EXERCISE.....                                   | 6          |
| 3.3 GENERAL TEST PROCEDURES.....                        | 6          |
| 3.4 FCC PART 15.205 RESTRICTED BANDS OF OPERATIONS..... | 7          |
| 3.5 DESCRIPTION OF TEST MODES .....                     | 8          |
| <b>4. INSTRUMENT CALIBRATION.....</b>                   | <b>9</b>   |
| 4.1 MEASURING INSTRUMENT CALIBRATION .....              | 9          |
| 4.2 MEASUREMENT EQUIPMENT USED .....                    | 9          |
| 4.3 MEASUREMENT UNCERTAINTY .....                       | 10         |
| <b>5 FACILITIES AND ACCREDITATIONS.....</b>             | <b>11</b>  |
| 5.1 FACILITIES .....                                    | 11         |
| 5.2 LABORATORY ACCREDITATIONS AND LISTING.....          | 11         |
| 5.3 TABLE OF ACCREDITATIONS AND LISTINGS.....           | 12         |
| <b>6 SETUP OF EQUIPMENT UNDER TEST .....</b>            | <b>13</b>  |
| 6.1 SETUP CONFIGURATION OF EUT.....                     | 13         |
| 6.2 SUPPORT EQUIPMENT .....                             | 13         |
| <b>7 APPLICABLE RULES .....</b>                         | <b>14</b>  |
| <b>8 RSS 210 REQUIREMENTS .....</b>                     | <b>23</b>  |
| 8.1 99% BANDWIDTH.....                                  | 23         |
| 8.2 6DB BANDWIDTH.....                                  | 36         |
| 8.3 PEAK POWER.....                                     | 59         |
| 8.4 AVERAGE POWER .....                                 | 62         |
| 8.5 BAND EDGES MEASUREMENT .....                        | 65         |
| 8.6 PEAK POWER SPECTRAL DENSITY .....                   | 92         |
| 8.7 RADIATED EMISSIONS.....                             | 115        |
| 8.8 POWERLINE CONDUCTED EMISSIONS.....                  | 140        |
| <b>APPENDIX I PHOTOGRAPHS OF TEST SETUP .....</b>       | <b>143</b> |
| <b>APPENDIX 1 - PHOTOGRAPHS OF EUT</b>                  |            |



# 1. TEST RESULT CERTIFICATION

**Applicant:** **For FCC**  
 SAMSUNG ELECTRONICS CO., LTD.  
 19 Chapin Rd., Building D Pine Brook, New Jersey,  
 United States, 07058  
**For IC**  
 #129 Samsung-Ro, Yeongtong-Gu  
 Suwon-Si, Gyeonggi-Do 443-742 Korea, Republic of

**Manufacturer:** SAMSUNG ELECTRONICS CO., LTD.  
 19 Chapin Rd., Building D Pine Brook, New Jersey,  
 United States, 07058

**Equipment Under Test:** Wifi Module

**Trade Name:** Samsung

**Model:** WDF710Q

**Date of Test:** July 26 ~ August 27, 2013

| APPLICABLE STANDARDS  |                         |
|---|-------------------------|
| STANDARD  | TEST RESULT             |
| FCC 47 CFR Part 15 Subpart C<br>&<br>Industry Canada RSS-210 Issue 8 December, 2010 | No non-compliance noted |

### We hereby certify that:

Compliance Certification Services Inc. tested the above equipment in accordance with the requirements set forth in the above standards. The test results show that the equipment tested is capable of demonstrating compliance with the requirements as documented in this report.

The test results of this report relate only to the tested sample identified in this report.

*Approved by*

*Reviewed by*

---

Miller Lee  
 Section Manager  
 Compliance Certification Services Inc.

---

Gina Lo  
 Section Manager  
 Compliance Certification Services Inc.



## 2. EUT DESCRIPTION

|  |   |
|--|---|
| <b>Product</b>                                       | Wifi Module   |
| <b>Trade Name</b>                                    | Samsung   |
| <b>Model Number</b>                                  | WDF710Q   |
| <b>Model Discrepancy</b>                             | N/A   |
| <b>Power Supply</b>                                  | Powered from host device  |
| <b>Received Date</b>                                 | July 11, 2013   |
| <b>Frequency Range</b>                               | IEEE 802.11a/ IEEE 802.11n HT 20 MHz: 5.725~5.850 GHz<br>IEEE 802.11b/g/ IEEE 802.11n HT 20 MHz: 2.412~2.462 GHz<br>IEEE 802.11n HT 40 MHz: 2.422~2.452 GHz   |
| <b>Transmit Power</b>                                | IEEE 802.11a mode: 21.72 dBm<br>IEEE 802.11n HT 20 MHz mode: 21.71 dBm<br>IEEE 802.11n HT 40 MHz mode: 21.73 dBm<br>IEEE 802.11b mode: 20.04 dBm<br>IEEE 802.11g mode: 25.36 dBm<br>IEEE 802.11n HT 20 MHz mode: 25.23 dBm<br>IEEE 802.11n HT 40 MHz mode: 25.07 dBm  |
| <b>Modulation Technique &amp; Transmit Data Rate</b> | IEEE 802.11a: OFDM (54, 48, 36, 24, 18, 12, 9, 6 Mbps)<br>IEEE 802.11n HT 20 MHz mode: OFDM (6.5, 7.2, 13, 14.4, 14.44, 19.5, 21.7, 26, 28.89, 28.9, 39, 43.3, 43.33 52, 57.78, 57.8, 58.5, 65.0, 72.2, 78, 86.67, 104, 115.56, 117, 130, 144.44 Mbps)<br>IEEE 802.11n HT 40 MHz mode: OFDM (13.5, 15, 27, 30, 40.5, 45, 54, 60, 81, 90, 108, 120, 121.5, 135, 150, 162, 180, 216, 240, 243, 270, 300 Mbps)<br>IEEE 802.11b mode: DSSS (1, 2, 5.5 and 11 Mpbs)<br>IEEE 802.11g mode: OFDM (6, 9, 12, 18, 24, 36, 48 and 54 Mpbs)<br>IEEE 802.11n HT 20 MHz mode: OFDM (6.5, 7.2, 13, 14.4, 14.44, 19.5, 21.7, 26, 28.89, 28.9, 39, 43.3, 43.33 52, 57.78, 57.8, 58.5, 65.0, 72.2, 78, 86.67, 104, 115.56, 117, 130, 144.44 Mbps)<br>IEEE 802.11n HT 40 MHz mode: OFDM (13.5, 15, 27, 30, 40.5, 45, 54, 60, 81, 90, 108, 120, 121.5, 135, 150, 162, 180, 216, 240, 243, 270, 300 Mbps) |
| <b>Number of Channels</b>                            | IEEE 802.11a mode: 5 Channels<br>IEEE 802.11n HT 20 MHz mode: 5 Channels<br>IEEE 802.11n HT 40 MHz mode: 2 Channels<br>IEEE 802.11b/g mode: 11 Channels<br>IEEE 802.11n HT 20 MHz mode: 11 Channels<br>IEEE 802.11n HT 40 MHz mode: 7 Channels  |
| <b>Antenna Specification</b>                         | For 2.4G: 3.4 dBi<br>For 5G: 2.6 dBi  |
| <b>Antenna Designation</b>                           | PIFA Antenna  |



### 3. TEST METHODOLOGY

The tests documented in this report were performed in accordance with ANSI C63.4: 2009 and FCC CFR 47 Part 15.207, 15.209, 15.247 and DA00-705.

The tests documented in this report were performed in accordance with IC RSS-210, IC RSS-Gen, IC RSS-102, and ANSI C63.4.

This submittal(s) (test report) is intended for IC Certification with Industry Canada RSS-210.

#### 3.1 EUT CONFIGURATION

The EUT configuration for testing is installed on RF field strength measurement to meet the Commissions requirement and operating in a manner that intends to maximize its emission characteristics in a continuous normal application.

#### 3.2 EUT EXERCISE

The EUT was operated in the engineering mode to fix the TX frequency that was for the purpose of the measurements.

According to its specifications, the EUT must comply with the requirements of the Section 15.207, 15.209 and 15.247 under the FCC Rules Part 15 Subpart C.

The tests documented in this report were performed in accordance with IC RSS-210, IC RSS-Gen, IC RSS-102, and ANSI C63.4.

#### 3.3 GENERAL TEST PROCEDURES

##### Conducted Emissions

The EUT is placed on the turntable, which is 0.8 m above ground plane. According to the requirements in Section 13.1.4.1 of ANSI C63.4 Conducted emissions from the EUT measured in the frequency range between 0.15 MHz and 30MHz using CISPR Quasi-peak and average detector modes.

##### Radiated Emissions

The EUT is placed on a turn table, which is 0.8 m above ground plane. The turntable shall rotate 360 degrees to determine the position of maximum emission level. EUT is set 3m away from the receiving antenna, which varied from 1m to 4m to find out the highest emission. And also, each emission was to be maximized by changing the polarization of receiving antenna both horizontal and vertical. In order to find out the maximum emissions, exploratory radiated emission measurements were made according to the requirements in Section 13.1.4.1 of ANSI C63.4.



### 3.4 FCC PART 15.205 RESTRICTED BANDS OF OPERATIONS

(a) Except as shown in paragraph (d) of this section, only spurious emissions are permitted in any of the frequency bands listed below:

| MHz                        | MHz                 | MHz             | GHz              |
|----------------------------|---------------------|-----------------|------------------|
| 0.090 - 0.110              | 16.42 - 16.423      | 399.9 - 410     | 4.5 - 5.15       |
| <sup>1</sup> 0.495 - 0.505 | 16.69475 - 16.69525 | 608 - 614       | 5.35 - 5.46      |
| 2.1735 - 2.1905            | 16.80425 - 16.80475 | 960 - 1240      | 7.25 - 7.75      |
| 4.125 - 4.128              | 25.5 - 25.67        | 1300 - 1427     | 8.025 - 8.5      |
| 4.17725 - 4.17775          | 37.5 - 38.25        | 1435 - 1626.5   | 9.0 - 9.2        |
| 4.20725 - 4.20775          | 73 - 74.6           | 1645.5 - 1646.5 | 9.3 - 9.5        |
| 6.215 - 6.218              | 74.8 - 75.2         | 1660 - 1710     | 10.6 - 12.7      |
| 6.26775 - 6.26825          | 108 - 121.94        | 1718.8 - 1722.2 | 13.25 - 13.4     |
| 6.31175 - 6.31225          | 123 - 138           | 2200 - 2300     | 14.47 - 14.5     |
| 8.291 - 8.294              | 149.9 - 150.05      | 2310 - 2390     | 15.35 - 16.2     |
| 8.362 - 8.366              | 156.52475 -         | 2483.5 - 2500   | 17.7 - 21.4      |
| 8.37625 - 8.38675          | 156.52525           | 2655 - 2900     | 22.01 - 23.12    |
| 8.41425 - 8.41475          | 156.7 - 156.9       | 3260 - 3267     | 23.6 - 24.0      |
| 12.29 - 12.293             | 162.0125 - 167.17   | 3332 - 3339     | 31.2 - 31.8      |
| 12.51975 - 12.52025        | 167.72 - 173.2      | 3345.8 - 3358   | 36.43 - 36.5     |
| 12.57675 - 12.57725        | 240 - 285           | 3600 - 4400     | ( <sup>2</sup> ) |
| 13.36 - 13.41              | 322 - 335.4         |                 |                  |

<sup>1</sup> Until February 1, 1999, this restricted band shall be 0.490-0.510 MHz.

<sup>2</sup> Above 38.6

(b) Except as provided in paragraphs (d) and (e), the field strength of emissions appearing within these frequency bands shall not exceed the limits shown in Section 15.209. At frequencies equal to or less than 1000 MHz, compliance with the limits in Section 15.209 shall be demonstrated using measurement instrumentation employing a CISPR quasi-peak detector. Above 1000 MHz, compliance with the emission limits in Section 15.209 shall be demonstrated based on the average value of the measured emissions. The provisions in Section 15.35 apply to these measurements.



### 3.5 DESCRIPTION OF TEST MODES

The EUT (model: WDF710Q) had been tested under operating condition.

Software used to control the EUT for staying in continuous transmitting and receiving mode was programmed.

After verification, all tests carried out are with the worst-case test modes as shown below except radiated spurious emission below 1GHz and power line conducted emissions below 30MHz,

**IEEE 802.11b mode:**

Channel Low (2412MHz), Channel Mid (2442MHz) and Channel High (2462MHz) with 1Mbps data rate were chosen for full testing.

**IEEE 802.11g mode:**

Channel Low (2412MHz), Channel Mid (2442MHz) and Channel High (2462MHz) with 6Mbps data rate were chosen for full testing.

**IEEE 802.11n HT 20 MHz mode:**

Channel Low (2412MHz), Channel Mid (2442MHz) and Channel High (2462MHz) with 6.5Mbps data rate were chosen for full testing.

**IEEE 802.11n HT 40 MHz mode:**

Channel Low (2422MHz), Channel Mid (2442MHz) and Channel High (2452MHz) with 13.5Mbps data rate were chosen for full testing.

**IEEE 802.11a mode:**

Channel Low (5745MHz), Channel Mid (5785MHz) and Channel High (5825MHz) with 6Mbps data rate were chosen for full testing.

**IEEE 802.11n HT 20 MHz mode:**

Channel Low(5745MHz), Channel Mid(5785MHz) and Channel High(5825MHz) with 6.5Mbps data rate were chosen for full testing.

**IEEE 802.11n HT 40 MHz mode:**

Channel Low(5755MHz) and Channel High(5795MHz) with 13.5Mbps data rate were chosen for full testing.





## 4. INSTRUMENT CALIBRATION

### 4.1 MEASURING INSTRUMENT CALIBRATION

The measuring equipment, which was utilized in performing the tests documented herein, has been calibrated in accordance with the manufacturer's recommendations for utilizing calibration equipment, which is traceable to recognized national standards.

### 4.2 MEASUREMENT EQUIPMENT USED

#### Equipment Used for Emissions Measurement

*Remark: Each piece of equipment is scheduled for calibration once a year and Loop Antenna is scheduled for calibration once three years.*

| Conducted Emissions Test Site |              |         |               |                 |
|-------------------------------|--------------|---------|---------------|-----------------|
| Name of Equipment             | Manufacturer | Model   | Serial Number | Calibration Due |
| Spectrum Analyzer             | Agilent      | E4446A  | MY43360131    | 03/27/2014      |
| Power Meter                   | Anritsu      | ML2495A | 1012009       | 06/04/2014      |
| Power Sensor                  | Anritsu      | MA2411A | 0917072       | 06/04/2014      |

| 3M Chamber Test Site |                    |            |               |                 |
|----------------------|--------------------|------------|---------------|-----------------|
| Name of Equipment    | Manufacturer       | Model      | Serial Number | Calibration Due |
| Spectrum Analyzer    | Agilent            | E4446A     | US42510268    | 11/06/2013      |
| EMI Test Receiver    | R&S                | ESCI       | 100064        | 02/17/2014      |
| Pre-Amplifier        | Mini-Circuits      | ZFL-1000LN | SF350700823   | 01/13/2014      |
| Bilog Antenna        | Sunol Sciences     | JB3        | A030105       | 10/02/2013      |
| Horn Antenna         | EMCO               | 3117       | 00055165      | 02/17/2014      |
| Turn Table           | CCS                | CC-T-1F    | N/A           | N.C.R           |
| Antenna Tower        | CCS                | CC-A-1F    | N/A           | N.C.R           |
| Controller           | CCS                | CC-C-1F    | N/A           | N.C.R           |
| Site NSA             | CCS                | N/A        | N/A           | 12/22/2013      |
| Test S/W             | EZ-EMC (CCS-3A1RE) |            |               |                 |

| Conducted Emission room # A |              |           |               |                 |
|-----------------------------|--------------|-----------|---------------|-----------------|
| Name of Equipment           | Manufacturer | Model     | Serial Number | Calibration Due |
| TEST RECEIVER               | R&S          | ESCI      | 101201        | 09/10/2013      |
| LISN (EUT)                  | SCHWARZBECK  | NSLK 8127 | 8127527       | 12/11/2013      |
| LISN                        | SCHWARZBECK  | NSLK 8127 | 8127526       | 12/11/2013      |
| BNC CABLE                   | EMCI         | 5Dr       | BNC A6        | 12/11/2013      |
| Pulse Limiter               | R&S          | ESH3-Z2   | C3010026-2    | 09/07/2013      |
| Test S/W                    | EZ-EMC       |           |               |                 |



### 4.3 MEASUREMENT UNCERTAINTY

| PARAMETER                             | UNCERTAINTY |
|---------------------------------------|-------------|
| Powerline Conducted Emission          | +/- 1.56    |
| 3M Semi Anechoic Chamber / 30M~200M   | +/- 4.0138  |
| 3M Semi Anechoic Chamber / 200M~1000M | +/- 3.9483  |
| 3M Semi Anechoic Chamber / 1G~8G      | +/- 2.5975  |
| 3M Semi Anechoic Chamber / 8G~18G     | +/- 2.6112  |
| 3M Semi Anechoic Chamber / 18G~26G    | +/- 2.7389  |
| 3M Semi Anechoic Chamber / 26G~40G    | +/- 2.9683  |

**Remark:** This uncertainty represents an expanded uncertainty expressed at approximately the 95% confidence level using a coverage factor of  $k=2$ .



## 5 FACILITIES AND ACCREDITATIONS

### 5.1 FACILITIES

All measurement facilities used to collect the measurement data are located at

No.199, Chungshen Road, Hsintien City, Taipei Hsien, Taiwan, R.O.C.

Tel: 886-2-2217-0894 / Fax: 886-2-2217-1029

*Remark: The powerline conducted emissions test items was tested at Compliance Certification Services Inc. (Hsintien Lab.) The test equipments were listed in page 9 and the test data, please refer page 141-142.*

No.11, Wugong 6th Rd., Wugu Dist., New Taipei City 24891, Taiwan. (R.O.C.)

Tel: 886-2-2299-9720 / Fax: 886-2-2298-4045

No.81-1, Lane 210, Bade 2nd Rd., Lujhu Township, Taoyuan County 33841, TAIWAN, R.O.C.

Tel: 886-3-324-0332 / Fax: 886-3-324-5235

The sites are constructed in conformance with the requirements of ANSI C63.7, ANSI C63.4 and CISPR Publication 22.



All receiving equipment conforms to CISPR Publication 16-1, "Radio Interference Measuring Apparatus and Measurement Methods."

### 5.2 LABORATORY ACCREDITATIONS AND LISTING

The test facilities used to perform radiated and conducted emissions tests are accredited by American Association for Laboratory Accreditation Program for the specific scope accreditation under Lab Code: 0824-01 to perform Electromagnetic Interference tests according to FCC Part 15 and CISPR 22 requirements. In addition, the test facilities are listed with Industry Canada, Certification and Engineering Bureau, IC 2324G-1 for 3M Semi Anechoic Chamber A, IC 2324G-2 for 3M Semi Anechoic Chamber B.



### 5.3 TABLE OF ACCREDITATIONS AND LISTINGS

| Country | Agency          | Scope of Accreditation   | Logo  |
|---------|-----------------|--|---|
| USA     | FCC             | 3M Semi Anechoic Chamber (FCC MRA: TW1039) to perform FCC Part 15 measurements   | <br>FCC MRA: TW1039          |
| Taiwan  | TAF             | LP0002, RTTE01, FCC Method-47 CFR Part 15 Subpart C, D, E, RSS-210, RSS-310<br>IDA TS SRD, AS/NZS 4268, AS/NZS 4771, TS 12.1 & 12.2, ETSI EN 300 440-1, ETSI EN 300 440-2, ETSI EN 300 328, ETSI EN 300 220-1, ETSI EN 300 220-2, ETSI EN 301 893, ETSI EN 301 489-1/3/7/17<br>FCC OET Bulletin 65 + Supplement C,<br>EN 50360, EN 50361, EN 50371, RSS 102, EN 50383, EN 50385, EN 50392, IEC 62209, CNS 14958-1, CNS 14959<br>FCC Method -47 CFR Part 15 Subpart B<br>IEC / EN 61000-3-2, IEC / EN 61000-3-3,<br>IEC / EN 61000-4-2/3/4/5/6/8/11 |                              |
| Canada  | Industry Canada | 3M Semi Anechoic Chamber (IC 2324G-1 / IC 2324G-2) to perform  | <br>IC 2324G-1<br>IC 2324G-2 |

\* No part of this report may be used to claim or imply product endorsement by A2LA or any agency of the US Government.



## 6 SETUP OF EQUIPMENT UNDER TEST

### 6.1 SETUP CONFIGURATION OF EUT

See test photographs attached in Appendix II for the actual connections between EUT and support equipment.

### 6.2 SUPPORT EQUIPMENT

| No. | Device Type           | Brand  | Model         | Series No.     | FCC ID  | Data Cable       | Power Cord   |
|-----|-----------------------|--------|---------------|----------------|---------|------------------|--|
| 1   | Notebook PC           | IBM    | 1951-I3V(T60) | L3B2188        | FCC DoC | N/A              | AC I/P: Unshielded, 1.8m<br>DC O/P: Unshielded, 1.8m with a core |
| 2   | Notebook PC           | DELL   | PP19L         | 61G6Q1S        | FCC DoC | N/A              | AC I/P: Unshielded, 1.8m<br>DC O/P: Unshielded, 1.8m with a core |
| 3   | USB Mouse             | Hp     | KU-0316       | BC3870FVBWH079 | FCC DoC | Shielded, 1.8m   | N/A  |
| 4   | Earphone & Microphone | Atayal | SEP912        | N/A            | N/A     | Unshielded, 1.8m | N/A  |
| 5   | Notebook              | Hp     | HP 2140       | N/A            | FCC DoC | Shielded, 1.8m   | Unshielded, 1.8m   |
| 6   | IP DSLAM              | ZYXEL  | IES-1000      | N/A            | N/A     | N/A              | Unshielded, 1.8m   |

**Remark:**

1. All the equipment/cables were placed in the worst-case configuration to maximize the emission during the test.
2. Grounding was established in accordance with the manufacturer's requirements and conditions for the intended use.



## 7 APPLICABLE RULES

### **RSS-210 §2 General Certification Requirements and Specifications**

#### **RSS-210 §2.1 RSS-Gen Compliance**

In addition to RSS-210, the requirements in RSS-Gen, *General Requirements and Information for the Certification of Radio Apparatus*, must be met.

#### **RSS-210 §2.2 Emissions Falling Within Restricted Frequency Bands**

Category I licence-exempt equipment is required to comply with the provisions in RSS-Gen with respect to emissions falling within restricted frequency bands. These restricted frequency bands are listed in RSS-Gen.

#### **RSS-210 §2.3 Receivers**

Category I equipment receivers for use with transmitters subject to RSS-210 must comply with the applicable requirements set out in RSS-Gen and be certified under RSS-210. Category II equipment receivers for use with transmitters subject to RSS-210 are exempt from certification, but are subject to compliance with RSS-Gen and RSS-310.

#### **RSS-210 §2.5 General Field Strength Limits**

RSS-Gen includes the general field strength limits of unwanted emissions, where applicable, for transmitters and receivers operating in accordance with the provisions specified in this standard. Unwanted emissions of transmitters and receivers are permitted to fall within the restricted bands listed in RSS-Gen, and including the TV bands, but fundamental emissions are prohibited in the restricted bands.

#### **RSS-210 §2.5.1 Transmitters with Wanted Emissions that are Within the General Field Strength Limits**

Whether or not their operation is addressed by published RSS standards, transmitters whose wanted and unwanted emissions are within the general field strength limits shown in RSS-Gen, they may operate in any of the frequency bands, other than the restricted bands listed in RSS-Gen and including the TV bands, and shall be certified under RSS-210. Under no conditions may the level of any unwanted emissions exceed the level of the fundamental emission.

**Note:** Devices operating below 490 kHz in which all emissions are at least 40 dB below the limit listed in RSS-Gen (*General Field Strength Limits for Transmitters at Frequencies below 30 MHz*) are Category II devices and are subject to RSS-310.



## **RSS-210 §2.7 Tables**

### **RSS-210 §Annex A2.9: Frequency Hopping and Digital Modulation Systems Operating in the 902-928 MHz, 2400-2483.5 MHz, and 5725-5850 MHz Bands**

This section applies to systems that employ frequency hopping (FH) and digital modulation technology in the 902-928 MHz, 2400-2483.5 MHz and 5725-5850 MHz bands. Systems in these bands may employ frequency hopping, digital modulation and or a combination (hybrid) of both techniques.

A frequency hopping system that synchronizes with another or several other systems (to avoid frequency collision among them) via off-air sensing or via connecting cables is not hopping randomly and therefore is not in compliance with RSS-210.

### **RSS-210 §A8.1 Frequency Hopping Systems**

Frequency hopping systems are spread spectrum systems in which the carrier is modulated with coded information in a conventional manner causing a conventional spreading of the RF energy about the carrier frequency. The frequency of the carrier is not fixed but changes at fixed intervals under the direction of a coded sequence.

Frequency hopping systems are not required to employ all available hopping frequencies during each transmission. However, the system, consisting of both the transmitter and the receiver, must be designed to comply with all of the regulations in this section should the transmitter be presented with a continuous data (or information) stream.

Incorporation of intelligence into a frequency hopping system that enables it to recognize other users of the band and to avoid occupied frequencies is permitted, provided that the frequency hopping system does it individually, and independently chooses or adapts its hopset. The coordination of frequency hopping systems in any other manner for the express purpose of avoiding the simultaneous occupancy of individual hopping frequencies by multiple transmitters is not permitted.

The following applies to frequency hopping systems in each of the three bands.

(a) The bandwidth of a frequency hopping channel is the 20 dB emission bandwidth, measured with the hopping stopped. The system RF bandwidth is equal to the channel bandwidth multiplied by the number of channels in the hopset. The hopset shall be such that the near term distribution of frequencies appears random, with sequential hops randomly distributed in both direction and magnitude of change in the hopset while the long term distribution appears evenly distributed.



(b) Frequency hopping systems shall have hopping channel carrier frequencies separated by a minimum of 25 kHz or the 20 dB bandwidth of the hopping channel, whichever is greater. Alternatively, frequency hopping systems operating in the 2400-2483.5 MHz band may have hopping channel carrier frequencies that are separated by 25 kHz or two-thirds of the 20 dB bandwidth of the hopping channel, whichever is greater, provided the systems operate with an output power no greater than 0.125 W. The system receivers shall have input bandwidths that match the hopping channel bandwidths of their corresponding transmitters and shall shift frequencies in synchronization with the transmitted signals.

(d) Frequency hopping systems operating in the 2400-2483.5 MHz band shall use at least 15 hopping channels. The average time of occupancy on any channel shall not be greater than 0.4 seconds within a period of 0.4 seconds multiplied by the number of hopping channels employed. Transmissions on particular hopping frequencies may be avoided or suppressed provided that a minimum of 15 hopping channels are used.

### **RSS-210 §A8.2 Digital Modulation Systems**

These include systems employing digital modulation techniques resulting in spectral characteristics similar to direct sequence systems. The following applies to all three bands.

### **RSS-210 §A8.4 Transmitter Output Power and e.i.r.p. Requirements**

(4) For systems employing digital modulation techniques operating in the 902-928 MHz, 2400-2483.5 MHz and 5725-5850 MHz bands, the maximum peak conducted power shall not exceed 1 W. Except as provided in Section A8.4(5), the e.i.r.p. shall not exceed 4 W.

As an alternative to a peak power measurement, compliance can be based on a measurement of the maximum conducted output power (see RSS-Gen)

(5) Point-to-point systems in the bands 2400-2483.5 MHz and 5725-5850 MHz are permitted to have an e.i.r.p. higher than 4 W, provided that the higher e.i.r.p. is achieved by employing higher gain directional antennas and not higher transmitter output powers. Point-to-multipoint systems, omni-directional applications and multiple co-located transmitters transmitting the same information are prohibited from exceeding 4 W e.i.r.p. However, remote stations of point-to-multipoint systems shall be allowed to operate at greater than 4 W e.i.r.p. under the same conditions as for point-to-point systems.

**Note:** "Fixed, point-to-point operation", excludes point-to-multipoint systems, omnidirectional applications and multiple co-located transmitters transmitting the same information.





## **RSS-210 §A8.5 Out-of-band Emissions**

In any 100 kHz bandwidth outside the frequency band in which the spread spectrum or digitally modulated device is operating, the radio frequency power that is produced shall be at least 20 dB below that in the 100 kHz bandwidth within the band that contains the highest level of the desired power, based on either an RF conducted or a radiated measurement, provided the transmitter demonstrates compliance with the peak conducted power limits. If the transmitter complies with the conducted power limits based on the use of RMS averaging over a time interval, as permitted under section A8.4(4), the attenuation required shall be 30 dB instead of 20 dB. Attenuation below the general limits specified in Tables 2 and 3 is not required.

## **RSS-Gen §2 General Information**

### **RSS-Gen §2.1.2 Category II Equipment**

Category II equipment comprises radio devices where a standard has been prescribed but for which a TAC is not required, that is, equipment certification by Industry Canada or a Certification Body (CB) is not required (certification exempt), pursuant to subsection 4(3) of the Radiocommunication Act. The manufacturer or importer shall nevertheless ensure that the standards are complied with. A test report shall be available on request and the device shall be properly labelled.

### **RSS-Gen §2.2 Receivers**

Receivers that are used for radiocommunication other than broadcasting are defined as Category I equipment or Category II equipment, subject to compliance with applicable Industry Canada standards.

Receivers shall be capable of operation only with transmitters for which RSSs are published. Receivers are classified as described in sections 2.2.1 and 2.2.2.

#### **RSS-Gen §2.2.1 Category I Equipment Receivers**

A receiver is classified as Category I equipment if it meets one of the following conditions:

- (a) a stand-alone receiver (see Note 1, below), which operates on any frequency in the band 30-960 MHz, and is used for the reception of signals in that frequency band from a transmitter classified as Category I equipment;
- (b) a Citizen's Band (CB) receiver (26.96-27.410 MHz);
- (c) a scanner receiver.

**Note 1:** A *stand-alone receiver* is defined as any receiver that is not permanently combined together with a transmitter in a single case (transceiver), in which it functions as the receiver component of the transceiver.

Receivers classified as Category I equipment shall comply with the limits for receiver spurious emissions set out in RSS-Gen; however, equipment certification is granted under the applicable RSS standard along with the associated transmitter classified as Category I equipment. Scanner receivers are covered under their own specific RSS.

#### **RSS-Gen §2.2.2 Category II Equipment Receivers**

A receiver is classified as Category II equipment if it does not meet any of the conditions of Section 2.2.1.

Category II receivers shall comply with the applicable testing, labelling and user manual requirements in RSS-310.



**RSS-Gen §5.6 Exposure of Humans to RF Fields**

Category I and Category II equipment shall comply with the applicable requirements of RSS-102.

**RSS-Gen §6 Receiver Spurious Emission Standard**

Receivers shall comply with the limits of spurious emissions set out in this section, measured over the frequency range determined in accordance with Section 4.10.

**RSS-Gen §6.1 Radiated Limits**

Radiated spurious emission measurements shall be performed with the receiver antenna connected to the receiver antenna terminals.

Spurious emissions from receivers shall not exceed the radiated limits shown in the table below:

**RSS-Gen Table 2 - Spurious Emission Limits for Receivers**

| Frequency (MHz) | Field Strength microvolts/m at 3 metres |
|-----------------|---|
| 30-88           | 100                                     |
| 88-216          | 150                                     |
| 216-960         | 200                                     |
| Above 960       | 500                                     |

\*Measurements for compliance with limits in the above table may be performed at distances other than 3 metres, in accordance with Section 7.2.7.



**RSS- Gen Table 3: Restricted Frequency Bands** <sup>(Note)</sup>

| MHz             | MHz                | MHz                 | MHz           | GHz         |
|-----------------|--------------------|---------------------|---------------|-------------|
| 0.090-0.110     | 8.37625-8.38675    | --                  | 1718.8-1722.2 | 9.0-9.2     |
| --              | 8.41425-8.41475    | 156.52475-156.52525 | 2200-2300     | 9.3-9.5     |
| 2.1735-2.1905   | 12.29-12.293       | 156.7-156.9         | 2310-2390     | 10.6-12.7   |
| 3.020-3.026     | 12.51975-12.52025  | --                  | --            | 13.25-13.4  |
| 4.125-4.128     | 12.57675-12.57725  | --                  | 2655-2900     | 14.47-14.5  |
| 4.17725-4.17775 | 13.36-13.41        | 240-285             | 3260-3267     | 15.35-16.2  |
| 4.20725-4.20775 | 16.42-16.423       | 322-335.4           | 3332-3339     | 17.7-21.4   |
| 5.677-5.683     | 16.69475-16.69525  | 399.9-410           | 3345.8-3358   | 22.01-23.12 |
| 6.215-6.218     | 16.80425-16.80475  | 608-614             | 3500-4400     | 23.6-24.0   |
| 6.26775-6.26825 | 25.5-25.67         | 960-1427            | 4500-5150     | 31.2-31.8   |
| 6.31175-6.31225 | 37.5-38.25         | 1435-1626.5         | 5350-5460     | 36.43-36.5  |
| 8.291-8.294     | 73-74.6; 74.8-75.2 | 1645.5-1646.5       | 7250-7750     | Above 38.6  |
| 8.362-8.366     | 108-138            | 1660-1710           | 8025-8500     |             |

*Note: Certain frequency bands listed in Table 2 and above 38.6 GHz are designated for low-power licence-exempt applications. These frequency bands and the requirements that apply to the devices are set out in this Standard as well as RSS-310.*

**RSS- Gen Table 5: General Field Strength Limits for Transmitters at Frequencies Above 30 MHz**

| Frequency (MHz) | Field Strength (microvolt/m at 3 metres) |
|-----------------|--|
| 30-88           | 100                                      |
| 88-216          | 150                                      |
| 216-960         | 200                                      |
| Above 960       | 500                                      |

*Note: Transmitting devices are not permitted in Table 1 bands or, unless stated otherwise, in TV bands(54-72 MHz, 76-88 MHz, 174-216 MHz, 470-608 MHz and 614-806 MHz).*



**RSS- Gen Table 6: General Field Strength Limits for Transmitters at Frequencies Below 30 MHz (Transmit)**

| Frequency<br>(fundamental<br>or spurious) | Field Strength<br>(microvolts/m) | Magnetic<br>H-Field<br>(microamperes/m) | Measurement<br>Distance<br>(metres) |
|---|----------------------------------|---|-------------------------------------|
| 9-490 kHz                                 | 2,400/F<br>(F in kHz)            | 2,400/377F<br>(F in Hz)                 | 300                                 |
| 490-1.705 kHz                             | 24,000/F<br>(F in kHz)           | 24,000/377F<br>(F in kHz)               | 30                                  |
| 1.705-30 MHz                              | 30                               | N/A                                     | 30                                  |

*Note: The emission limits for the bands 9-90 kHz and 110-490 kHz are based on measurements employing an average detector.*



### **RSS-Gen §7.1.2 Transmitter Antenna**

A transmitter can only be sold or operated with antennas with which it was approved. Transmitter may be approved with multiple antenna types. An antenna type comprises antennas having similar in-band and out-of-band radiation patterns. Testing shall be performed using the highest gain antenna of each combination of transmitter and antenna type for which approval is being sought, with the transmitter output power set at the maximum level. Any antenna of the same type having equal or lesser gain as an antenna that had been successfully tested with the transmitter, will also be considered approved with the transmitter, and may be used and marketed with the transmitter. For Category I transmitters, the manufacturer shall include with the application for certification a list of acceptable antenna types to be used with the transmitter.

When a measurement at the antenna connector is used to determine RF output power, the effective gain of the device's antenna shall be stated, based on measurement or on data from the antenna manufacturer.

For transmitters of RF output power of 10 milliwatts or less, only the portion of the antenna gain that is in excess of 6 dBi (6 dB above isotropic gain) shall be added to the measured RF output power to demonstrate compliance with the radiated power limits specified in the applicable standard. For transmitters of output power greater than 10 milliwatts, the total antenna gain shall be added to the measured RF output power to demonstrate compliance to the specified radiated power limits. User manuals for transmitters shall display the following notice in a conspicuous location:

*Under Industry Canada regulations, this radio transmitter may only operate using an antenna of a type and maximum (or lesser) gain approved for the transmitter by Industry Canada. To reduce potential radio interference to other users, the antenna type and its gain should be so chosen that the equivalent isotropically radiated power (e.i.r.p.) is not more than that necessary for successful communication.*

The above notice may be affixed to the device instead of displayed in the user manual.

User manuals for transmitters equipped with detachable antennas shall also contain the following notice in a conspicuous location:

*This radio transmitter (identify the device by certification number, or model number if Category II) has been approved by Industry Canada to operate with the antenna types listed below with the maximum permissible gain and required antenna impedance for each antenna type indicated. Antenna types not included in this list, having a gain greater than the maximum gain indicated for that type, are strictly prohibited for use with this device.*

Immediately following the above notice, the manufacturer shall provide a list of all antenna types approved for use with the transmitter, indicating the maximum permissible antenna gain (in dBi) and required impedance for each.



**RSS-Gen §7.2.4 Transmitter and Receiver AC Power Lines Conducted Emission Limits**

Except when the requirements applicable to a given device state otherwise, for any radio apparatus equipped to operate from the public utility AC power supply, either directly or indirectly (such as with a battery charger), the radio frequency voltage of emissions conducted back onto the AC power lines in the frequency range of 0.15 MHz to 30 MHz shall not exceed the limits shown in the table below. The more stringent limit applies at the frequency range boundaries.

The conducted emissions shall be measured with a 50 ohm/50 microhenry line impedance stabilization network (LISN).

**RSS-Gen Table 4 – AC Power Line Conducted Emission Limits**

| Frequency Range (MHz) | Conducted limit (dBμV) |           |
|-----------------------|------------------------|-----------|
|                       | Quasi-peak             | Average   |
| 0.15 to 0.5           | 66 to 56*              | 56 to 46* |
| 0.5 to 5              | 56                     | 46        |
| 5 to 30               | 60                     | 50        |

*\*Decreases with the logarithm of the frequency.*



## 8 RSS 210 REQUIREMENTS

### 8.1 99%BANDWIDTH

#### Test Configuration

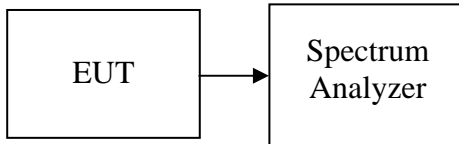

#### TEST PROCEDURE

The resolution bandwidth shall be set to as close to 1% of the selected span as is possible without being below 1%. The video bandwidth shall be set to 3 times the resolution bandwidth. Video averaging is not permitted. Where practical, a sampling detector shall be used since a peak or, peak hold.

#### TEST RESULTS

*No non-compliance noted.*



**Test Data**

**Test mode: IEEE 802.11b mode**

| Channel | Frequency (MHz) | 99% Bandwidth (MHz) |
|---------|-----------------|---------------------|
| Low     | 2412            | 13.8951             |
| Mid     | 2442            | 13.8806             |
| High    | 2462            | 13.8689             |

**Test mode: IEEE 802.11g mode**

| Channel | Frequency (MHz) | 99% Bandwidth (MHz) |
|---------|-----------------|---------------------|
| Low     | 2412            | 17.3584             |
| Mid     | 2442            | 17.5957             |
| High    | 2462            | 17.3465             |

**Test mode: IEEE 802.11n HT 20 MHz mode**

| Channel | Frequency (MHz) | 99% Bandwidth (MHz) |
|---------|-----------------|---------------------|
| Low     | 2412            | 18.3108             |
| Mid     | 2442            | 18.5576             |
| High    | 2462            | 18.3831             |

**Test mode: IEEE 802.11n HT 40 MHz mode**

| Channel | Frequency (MHz) | 99% Bandwidth (MHz) |
|---------|-----------------|---------------------|
| Low     | 2422            | 36.2782             |
| Mid     | 2442            | 36.3288             |
| High    | 2452            | 36.3149             |





**Test mode: IEEE 802.11a mode**

| <b>Channel</b> | <b>Frequency (MHz)</b> | <b>99% Bandwidth (MHz)</b> |
|----------------|------------------------|----------------------------|
| Low            | 5745                   | 16.9499                    |
| Mid            | 5785                   | 16.9352                    |
| High           | 5825                   | 16.9532                    |

**Test mode: IEEE 802.11n HT 20 MHz mode**

| <b>Channel</b> | <b>Frequency (MHz)</b> | <b>99% Bandwidth (MHz)</b> |
|----------------|------------------------|----------------------------|
| Low            | 5745                   | 18.0643                    |
| Mid            | 5785                   | 18.1487                    |
| High           | 5825                   | 18.0141                    |

**Test mode: IEEE 802.11n HT 40 MHz mode**

| <b>Channel</b> | <b>Frequency (MHz)</b> | <b>99% Bandwidth (MHz)</b> |
|----------------|------------------------|----------------------------|
| Low            | 5755                   | 36.2618                    |
| High           | 5795                   | 37.2174                    |



**Test Plot**

**IEEE 802.11b mode**

**99% Bandwidth (CH Low)**

Agilent 19:12:39 Aug 27, 2013

R L

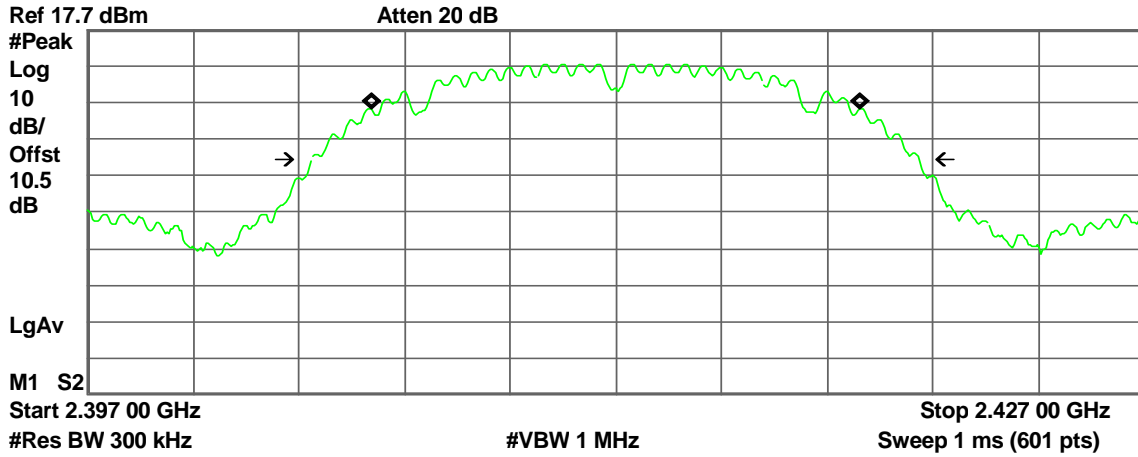

Occupied Bandwidth  
13.8951 MHz

Occ BW % Pwr 99.00 %  
x dB -26.00 dB

Transmit Freq Error -1.355 kHz  
x dB Bandwidth 17.248 MHz

**99% Bandwidth (CH Mid)**

Agilent 19:19:38 Aug 27, 2013

R L

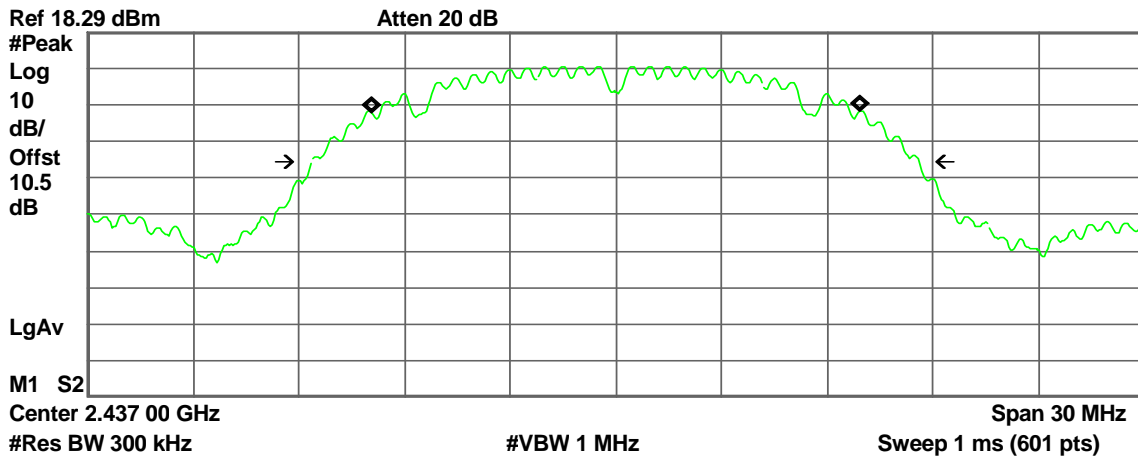

Occupied Bandwidth  
13.8806 MHz

Occ BW % Pwr 99.00 %  
x dB -26.00 dB

Transmit Freq Error -1.038 kHz  
x dB Bandwidth 17.258 MHz



### 99% Bandwidth (CH High)

Agilent 19:25:52 Aug 27, 2013

R L

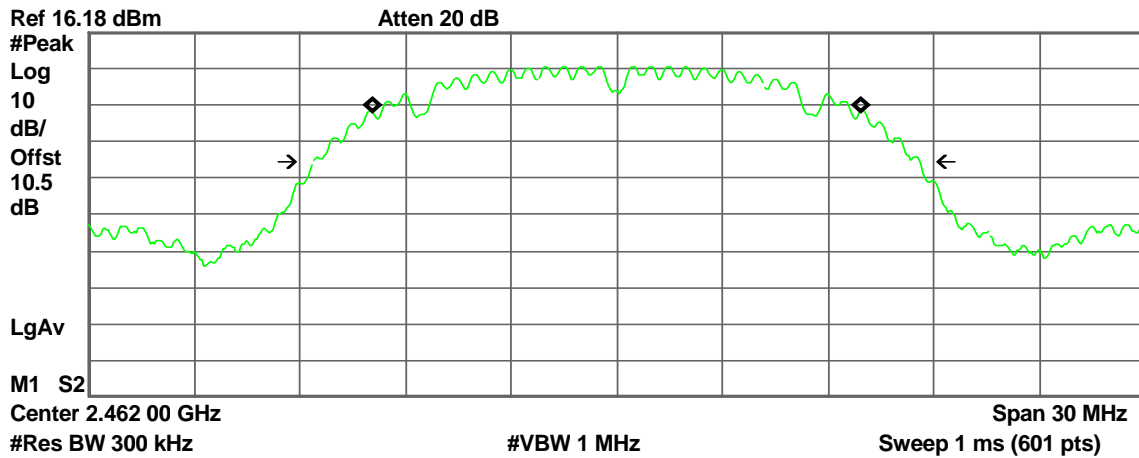

Occupied Bandwidth  
13.8689 MHz

Occ BW % Pwr      99.00 %  
x dB      -26.00 dB

Transmit Freq Error      -6.627 kHz  
x dB Bandwidth      17.239 MHz

### IEEE 802.11g mode

### 99% Bandwidth (CH Low)

Agilent 19:34:19 Aug 27, 2013

R L

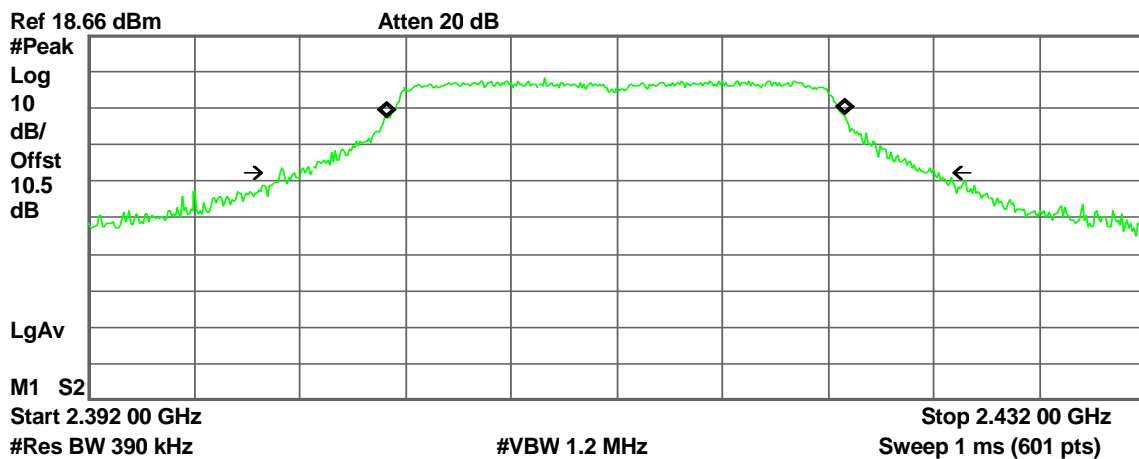

Occupied Bandwidth  
17.3584 MHz

Occ BW % Pwr      99.00 %  
x dB      -26.00 dB

Transmit Freq Error      -43.283 kHz  
x dB Bandwidth      24.771 MHz



### 99% Bandwidth (CH Mid)

Agilent 19:40:59 Aug 27, 2013

R L

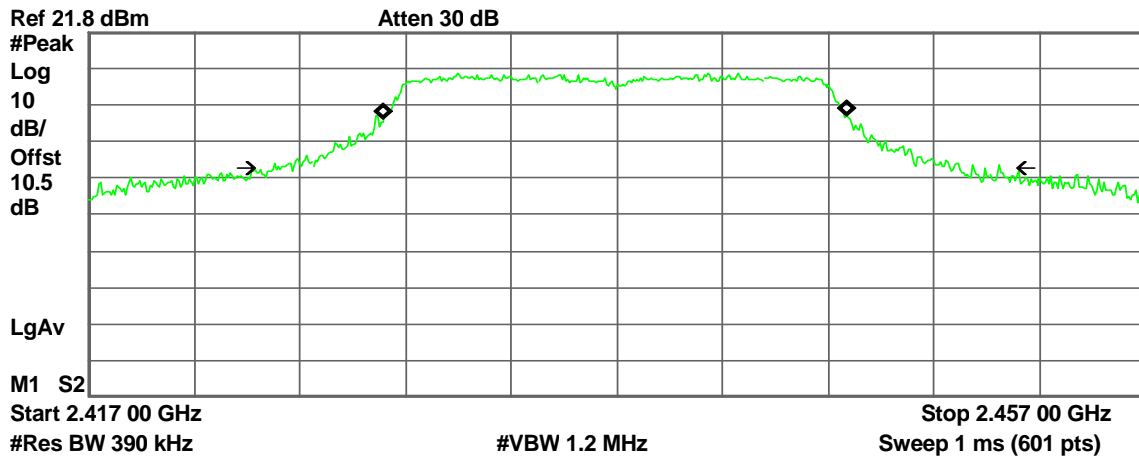

Occupied Bandwidth  
17.5957 MHz

Occ BW % Pwr 99.00 %  
x dB -26.00 dB

Transmit Freq Error -41.462 kHz  
x dB Bandwidth 27.477 MHz

### 99% Bandwidth (CH High)

Agilent 19:47:29 Aug 27, 2013

R L

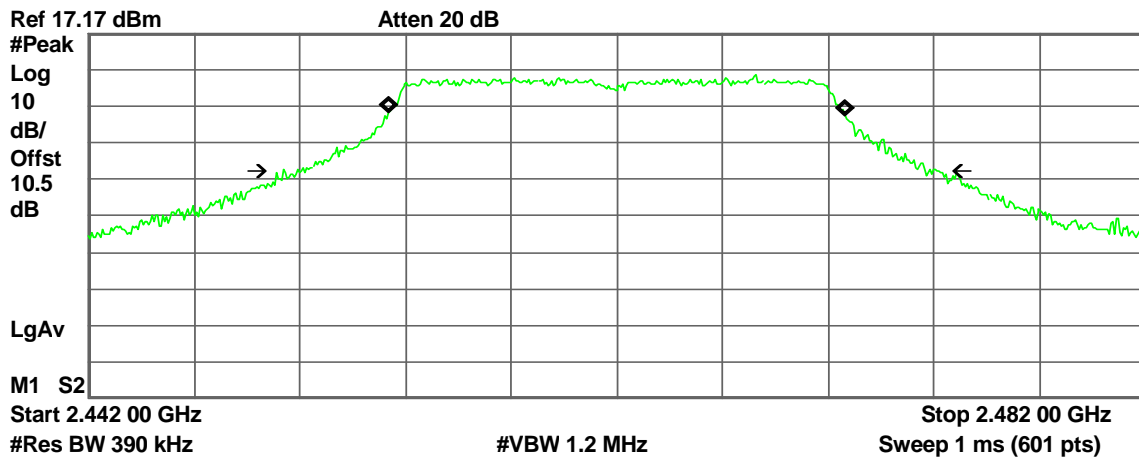

Occupied Bandwidth  
17.3465 MHz

Occ BW % Pwr 99.00 %  
x dB -26.00 dB

Transmit Freq Error 6.404 kHz  
x dB Bandwidth 24.683 MHz



### IEEE 802.11n HT 20 MHz mode

#### 99% Bandwidth (CH Low)

Agilent 19:55:29 Aug 27, 2013

R L

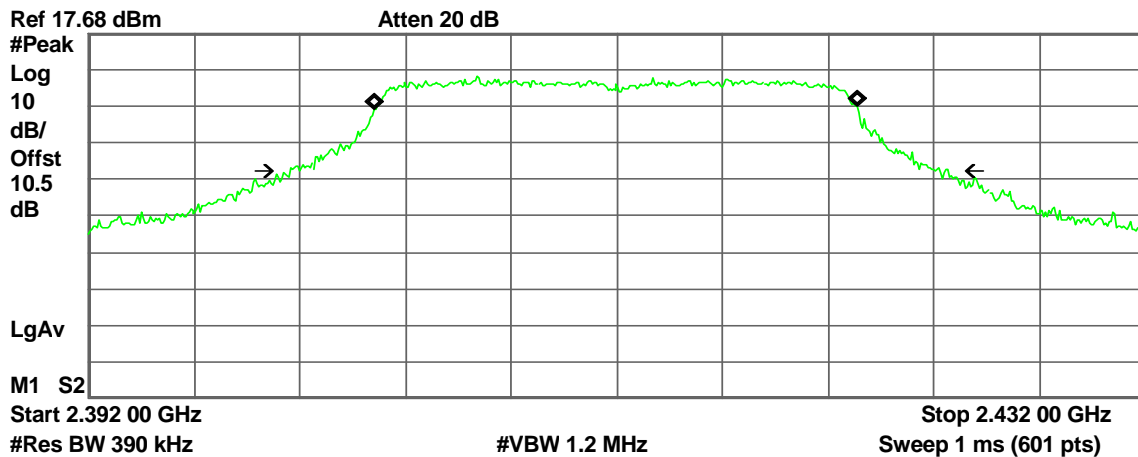

Occupied Bandwidth  
18.3108 MHz

Occ BW % Pwr      99.00 %  
x dB      -26.00 dB

Transmit Freq Error      -17.000 kHz  
x dB Bandwidth      24.916 MHz

#### 99% Bandwidth (CH Mid)

Agilent 20:02:08 Aug 27, 2013

R L

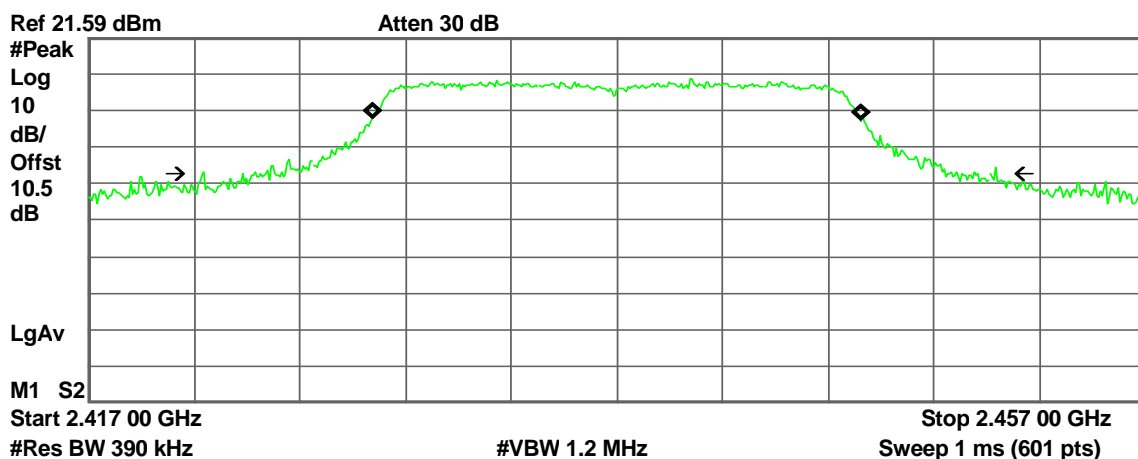

Occupied Bandwidth  
18.5576 MHz

Occ BW % Pwr      99.00 %  
x dB      -26.00 dB

Transmit Freq Error      13.395 kHz  
x dB Bandwidth      30.020 MHz



### 99% Bandwidth (CH High)

Agilent 20:10:10 Aug 27, 2013

R L

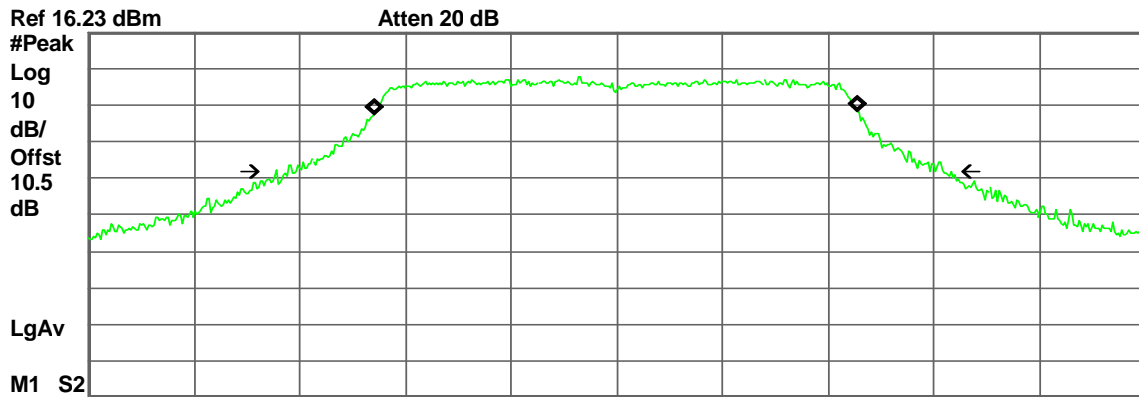

Start 2.442 00 GHz  
#Res BW 390 kHz

#VBW 1.2 MHz

Stop 2.482 00 GHz  
Sweep 1 ms (601 pts)

Occupied Bandwidth  
18.3831 MHz

Occ BW % Pwr 99.00 %  
x dB -26.00 dB

Transmit Freq Error -28.664 kHz  
x dB Bandwidth 25.265 MHz

### IEEE 802.11n HT 40 MHz mode

### 99% Bandwidth (CH Low)

Agilent 20:21:06 Aug 27, 2013

R L

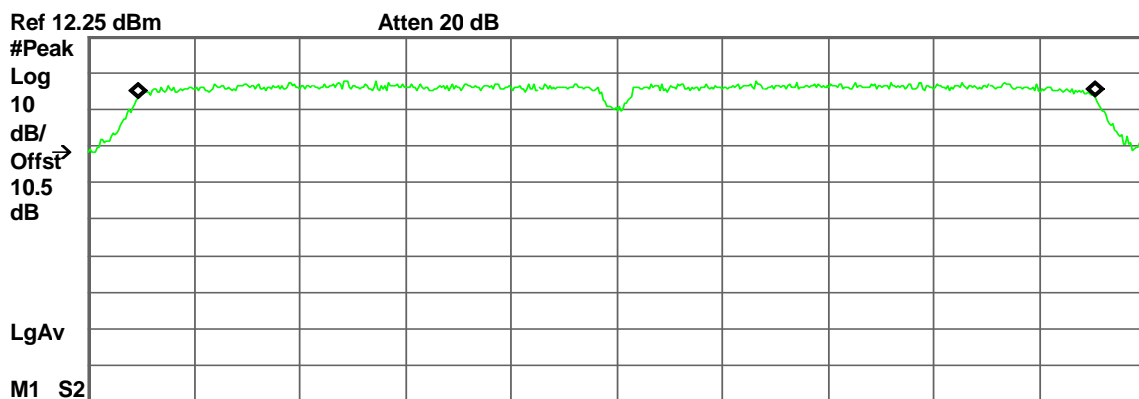

Start 2.402 00 GHz  
#Res BW 390 kHz

#VBW 1.2 MHz

Stop 2.442 00 GHz  
Sweep 1 ms (601 pts)

Occupied Bandwidth  
36.2782 MHz

Occ BW % Pwr 99.00 %  
x dB -26.00 dB

Transmit Freq Error -7.496 kHz  
x dB Bandwidth 40.000 MHz



### 99% Bandwidth (CH Mid)

Agilent 20:35:02 Aug 27, 2013

R L

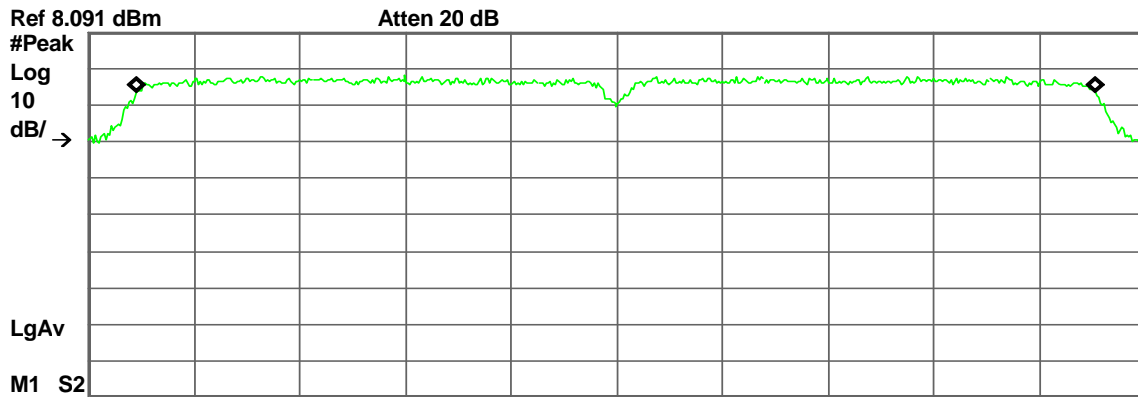

Start 2.417 00 GHz  
#Res BW 390 kHz  
#VBW 1.2 MHz  
Stop 2.457 00 GHz  
Sweep 1 ms (601 pts)

Occupied Bandwidth  
36.3288 MHz

Occ BW % Pwr 99.00 %  
x dB -26.00 dB

Transmit Freq Error -24.866 kHz  
x dB Bandwidth 40.000 MHz

### 99% Bandwidth (CH High)

Agilent 20:47:21 Aug 27, 2013

R L

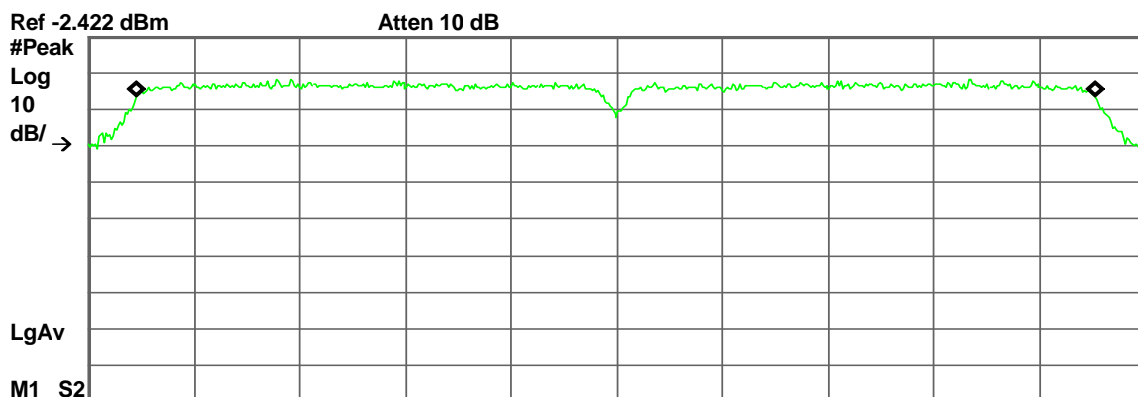

Start 2.432 00 GHz  
#Res BW 390 kHz  
#VBW 1.2 MHz  
Stop 2.472 00 GHz  
Sweep 1 ms (601 pts)

Occupied Bandwidth  
36.3149 MHz

Occ BW % Pwr 99.00 %  
x dB -26.00 dB

Transmit Freq Error -16.003 kHz  
x dB Bandwidth 40.000 MHz



**IEEE 802.11a mode**

**99% Bandwidth (CH Low)**

Agilent 00:21:09 Aug 28, 2013

R L

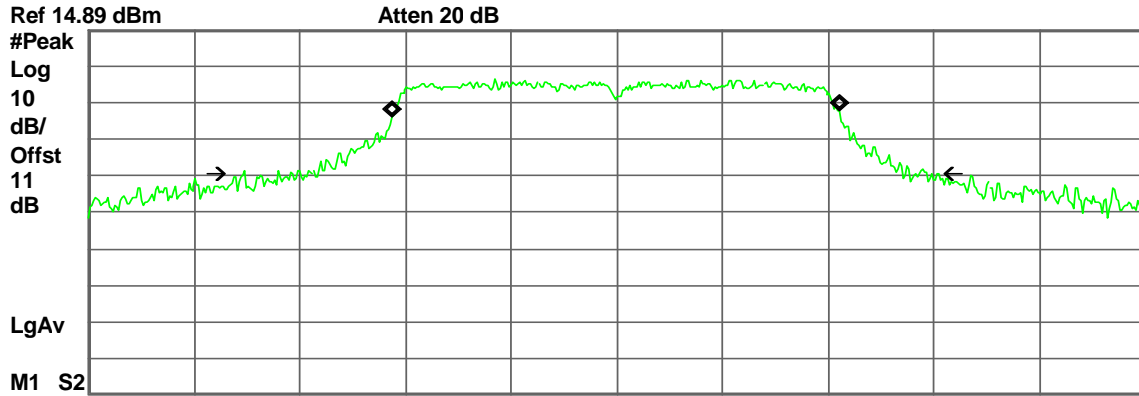

Start 5.725 00 GHz      Stop 5.765 00 GHz  
 #Res BW 300 kHz      #VBW 1 MHz      Sweep 1 ms (601 pts)

Occupied Bandwidth  
 16.9499 MHz

Occ BW % Pwr      99.00 %  
 x dB      -26.00 dB

Transmit Freq Error      -29.575 kHz  
 x dB Bandwidth      25.863 MHz

**99% Bandwidth (CH Mid)**

Agilent 00:27:40 Aug 28, 2013

R L

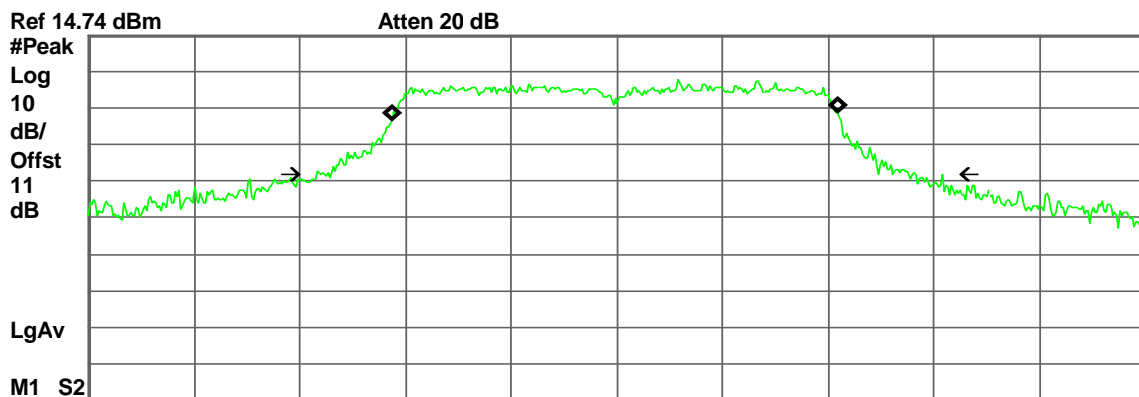

Start 5.765 00 GHz      Stop 5.805 00 GHz  
 #Res BW 300 kHz      #VBW 1 MHz      Sweep 1 ms (601 pts)

Occupied Bandwidth  
 16.9352 MHz

Occ BW % Pwr      99.00 %  
 x dB      -26.00 dB

Transmit Freq Error      -65.838 kHz  
 x dB Bandwidth      23.702 MHz





### 99% Bandwidth (CH High)

Agilent 00:33:28 Aug 28, 2013

R L

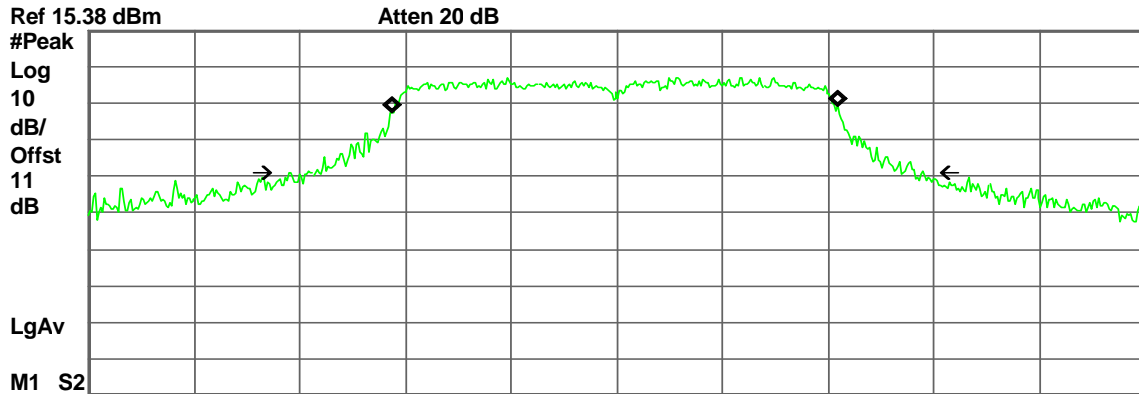

Ref 15.38 dBm      Atten 20 dB  
 #Peak  
 Log  
 10  
 dB/  
 Offst  
 11  
 dB  
 LgAv  
 M1 S2  
 Start 5.805 00 GHz      Stop 5.845 00 GHz  
 #Res BW 300 kHz      #VBW 1 MHz      Sweep 1 ms (601 pts)

Occupied Bandwidth  
 16.9532 MHz

Occ BW % Pwr      99.00 %  
 x dB      -26.00 dB

Transmit Freq Error      -65.956 kHz  
 x dB Bandwidth      24.031 MHz

### IEEE 802.11n HT 20 MHz mode

### 99% Bandwidth (CH Low)

Agilent 00:00:27 Aug 28, 2013

R L

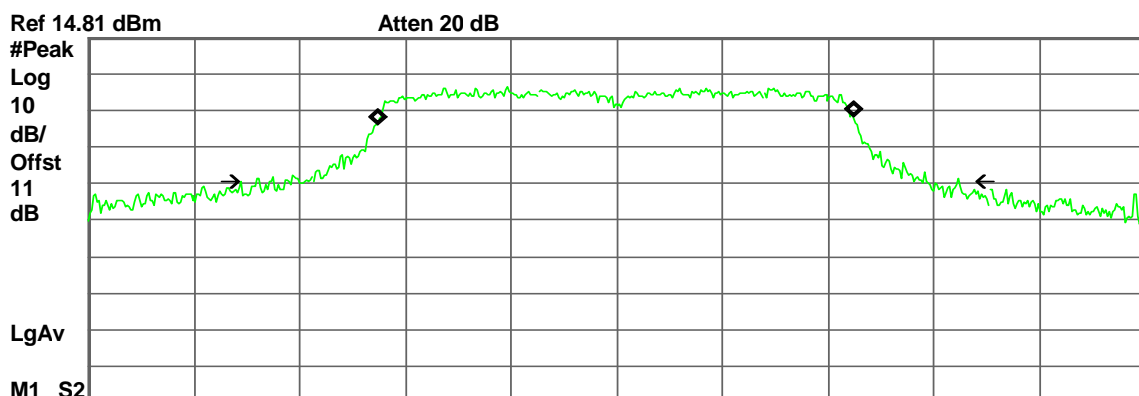

Ref 14.81 dBm      Atten 20 dB  
 #Peak  
 Log  
 10  
 dB/  
 Offst  
 11  
 dB  
 LgAv  
 M1 S2  
 Start 5.725 00 GHz      Stop 5.765 00 GHz  
 #Res BW 300 kHz      #VBW 1 MHz      Sweep 1 ms (601 pts)

Occupied Bandwidth  
 18.0643 MHz

Occ BW % Pwr      99.00 %  
 x dB      -26.00 dB

Transmit Freq Error      -45.810 kHz  
 x dB Bandwidth      26.573 MHz



### 99% Bandwidth (CH Mid)

Agilent 00:07:10 Aug 28, 2013

R L

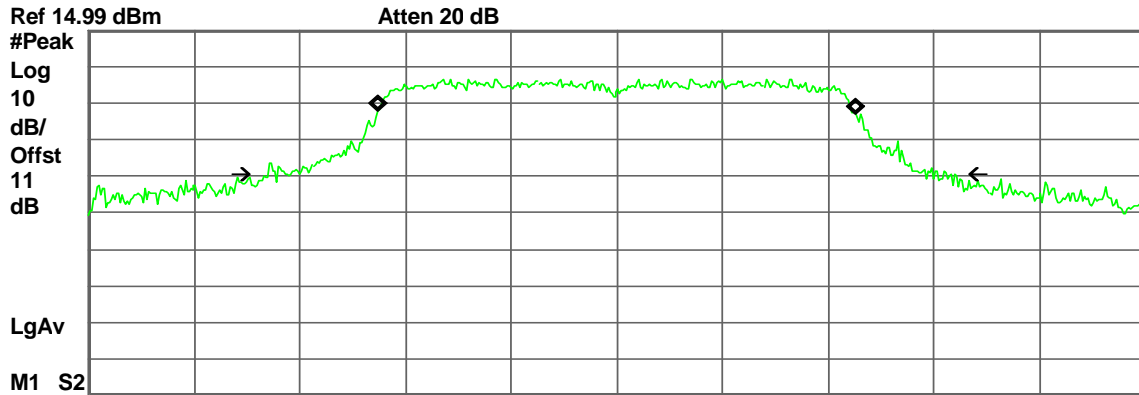

Start 5.765 00 GHz  
#Res BW 300 kHz  
#VBW 1 MHz  
Stop 5.805 00 GHz  
Sweep 1 ms (601 pts)

Occupied Bandwidth  
18.1487 MHz

Occ BW % Pwr 99.00 %  
x dB -26.00 dB

Transmit Freq Error 3.699 kHz  
x dB Bandwidth 25.856 MHz

### 99% Bandwidth (CH High)

Agilent 00:13:53 Aug 28, 2013

R L

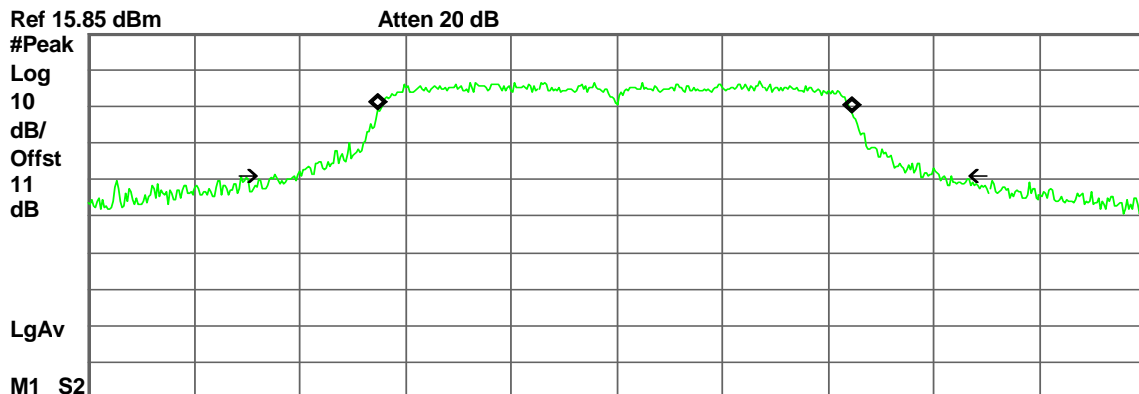

Start 5.805 00 GHz  
#Res BW 300 kHz  
#VBW 1 MHz  
Stop 5.845 00 GHz  
Sweep 1 ms (601 pts)

Occupied Bandwidth  
18.0141 MHz

Occ BW % Pwr 99.00 %  
x dB -26.00 dB

Transmit Freq Error -62.055 kHz  
x dB Bandwidth 25.630 MHz



### IEEE 802.11n HT 40 MHz mode

#### 99% Bandwidth (CH Low)

Agilent 00:39:51 Aug 28, 2013

R L



Occupied Bandwidth  
36.2618 MHz

Occ BW % Pwr      99.00 %  
x dB      -26.00 dB

Transmit Freq Error      -61.106 kHz  
x dB Bandwidth      45.720 MHz

#### 99% Bandwidth (CH High)

Agilent 09:43:58 Mar 12, 2013

R L

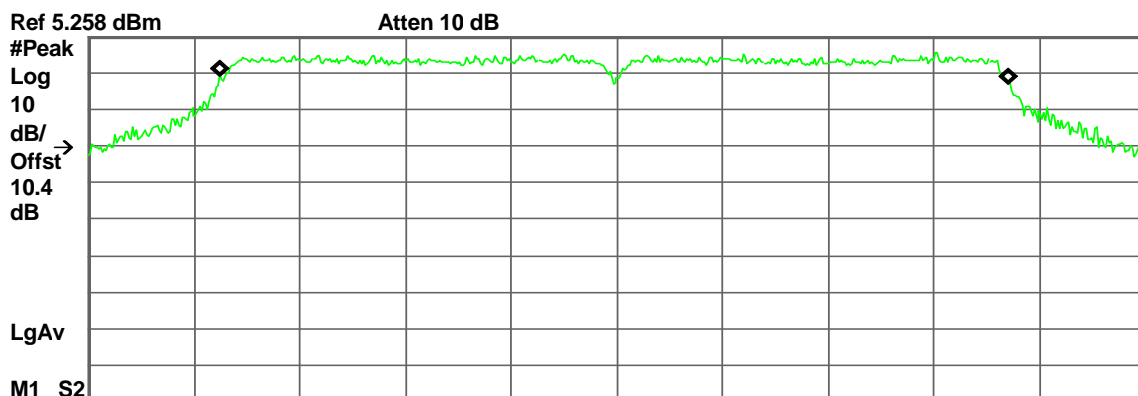

Occupied Bandwidth  
37.2174 MHz

Occ BW % Pwr      99.00 %  
x dB      -26.00 dB

Transmit Freq Error      -115.362 kHz  
x dB Bandwidth      49.751 MHz



## 8.2 6DB BANDWIDTH

### LIMIT

According to §15.247(a)(2) & RSS-210 §A8.2(a), systems using digital modulation techniques may operate in the 902 - 928 MHz, 2400 - 2483.5 MHz, and 5725 - 5850 MHz bands. The minimum 6dB bandwidth shall be at least 500 kHz.

### Test Configuration

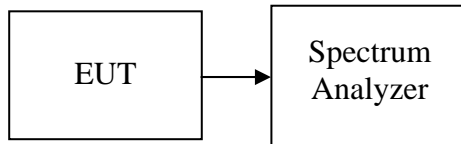

### TEST PROCEDURE

1. Place the EUT on the table and set it in the transmitting mode.
2. Remove the antenna from the EUT and then connect a low loss RF cable from the antenna port to the spectrum analyzer.
3. Set the spectrum analyzer as RBW = 300kHz, VBW = 1000kHz, Sweep = 500ms.
4. Mark the peak frequency and -6dB (upper and lower) frequency.
5. Repeat until all the rest channels are investigated.

### TEST RESULTS

*No non-compliance noted*



**Test Data**

**Test mode: IEEE 802.11b mode**

| Channel | Frequency (MHz) | 6dB Bandwidth (MHz) | Limit (kHz) | Result |
|---------|-----------------|---------------------|-------------|--------|
| Low     | 2412            | 10.3334             | >500        | PASS   |
| Mid     | 2442            | 10.3334             |             | PASS   |
| High    | 2462            | 10.4167             |             | PASS   |

**Test mode: IEEE 802.11g mode**

| Channel | Frequency (MHz) | 6dB Bandwidth (MHz) | Limit (kHz) | Result |
|---------|-----------------|---------------------|-------------|--------|
| Low     | 2412            | 16.5833             | >500        | PASS   |
| Mid     | 2442            | 16.5833             |             | PASS   |
| High    | 2462            | 16.5833             |             | PASS   |

**Test mode: IEEE 802.11n HT 20 MHz mode**

| Channel | Frequency (MHz) | 6dB Bandwidth (MHz) | Limit (kHz) | Result |
|---------|-----------------|---------------------|-------------|--------|
| Low     | 2412            | 17.8334             | >500        | PASS   |
| Mid     | 2442            | 17.8334             |             | PASS   |
| High    | 2462            | 17.8334             |             | PASS   |

**Test mode: IEEE 802.11n HT 40 MHz mode**

| Channel | Frequency (MHz) | 6dB Bandwidth (MHz) | Limit (kHz) | Result |
|---------|-----------------|---------------------|-------------|--------|
| Low     | 2422            | 36.6666             | >500        | PASS   |
| Mid     | 2442            | 36.6666             |             | PASS   |
| High    | 2452            | 36.5833             |             | PASS   |



**Test mode: IEEE 802.11a mode**

| Channel | Frequency (MHz) | 6dB Bandwidth (MHz) | Limit (kHz) | Result |
|---------|-----------------|---------------------|-------------|--------|
| Low     | 5745            | 16.5833             | >500        | PASS   |
| Mid     | 5785            | 16.5833             |             | PASS   |
| High    | 5825            | 16.5833             |             | PASS   |

**Test mode: IEEE 802.11n HT 20 MHz mode**

| Channel | Frequency (MHz) | 6dB Bandwidth (MHz) | Limit (kHz) | Result |
|---------|-----------------|---------------------|-------------|--------|
| Low     | 5745            | 17.75               | >500        | PASS   |
| Mid     | 5785            | 17.75               |             | PASS   |
| High    | 5825            | 17.75               |             | PASS   |

**Test mode: IEEE 802.11n HT 40 MHz mode**

| Channel | Frequency (MHz) | 6dB Bandwidth (MHz) | Limit (kHz) | Result |
|---------|-----------------|---------------------|-------------|--------|
| Low     | 5755            | 36.4                | >500        | PASS   |
| High    | 5795            | 37.1                |             | PASS   |



**Test Plot**

**IEEE 802.11b mode**

**6dB Bandwidth (CH Low)**

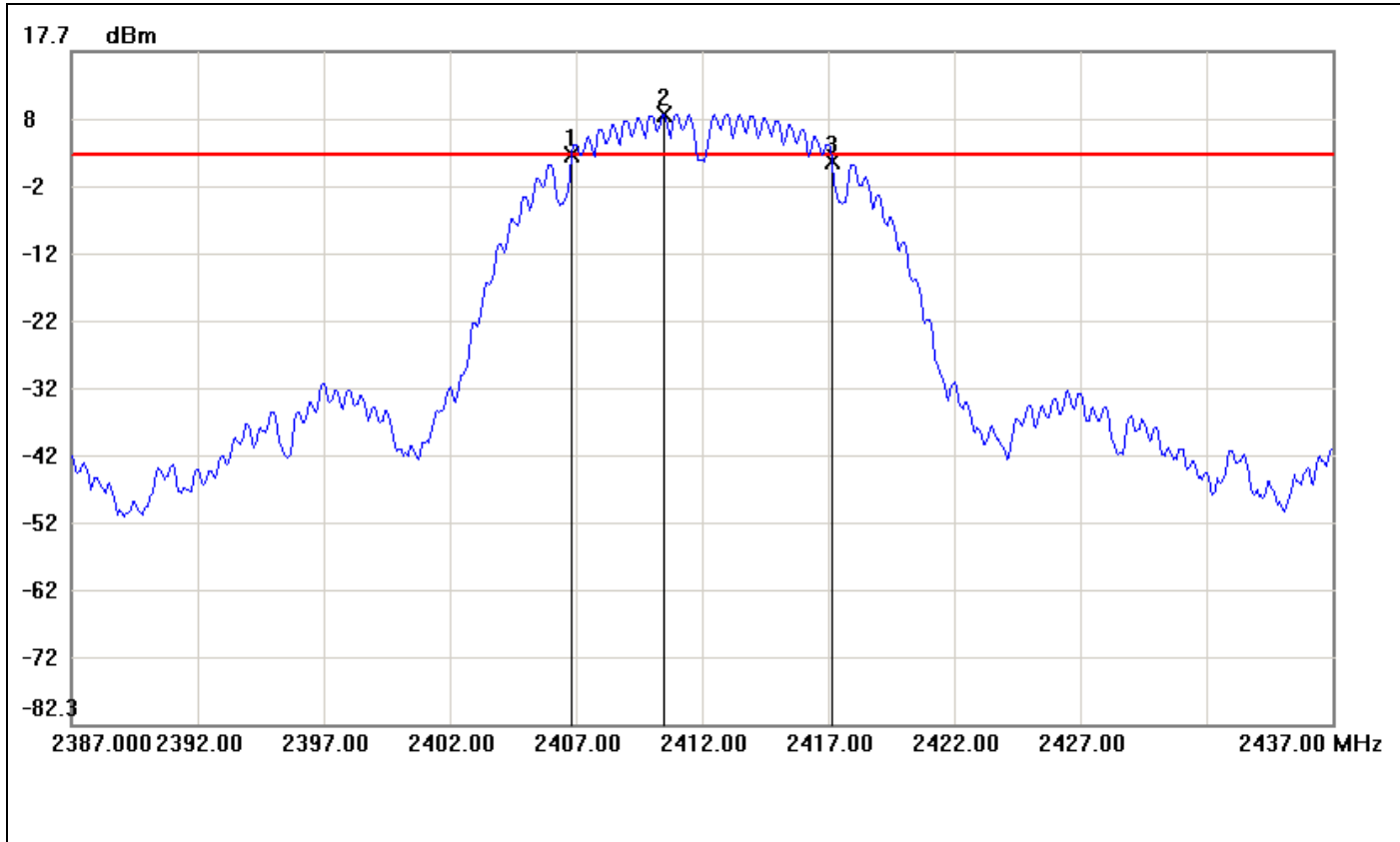

| No. | Frequency(MHz) | Result(dBm) | Limit(dBm) | Margin(dBm) |
|-----|----------------|-------------|------------|-------------|
| 1   | 2406.8333      | 2.27        | 2.30       | -0.03       |
| 2   | 2410.5000      | 8.30        | 2.30       | 6.00        |
| 3   | 2417.1667      | 1.30        | 2.30       | -1.00       |

| No. |         | $\Delta$ Frequency(MHz) | $\Delta$ Level(dB) |
|-----|---------|-------------------------|--------------------|
| 1   | mk3-mk1 | 10.3334                 | -0.97              |



### 6dB Bandwidth (CH Mid)

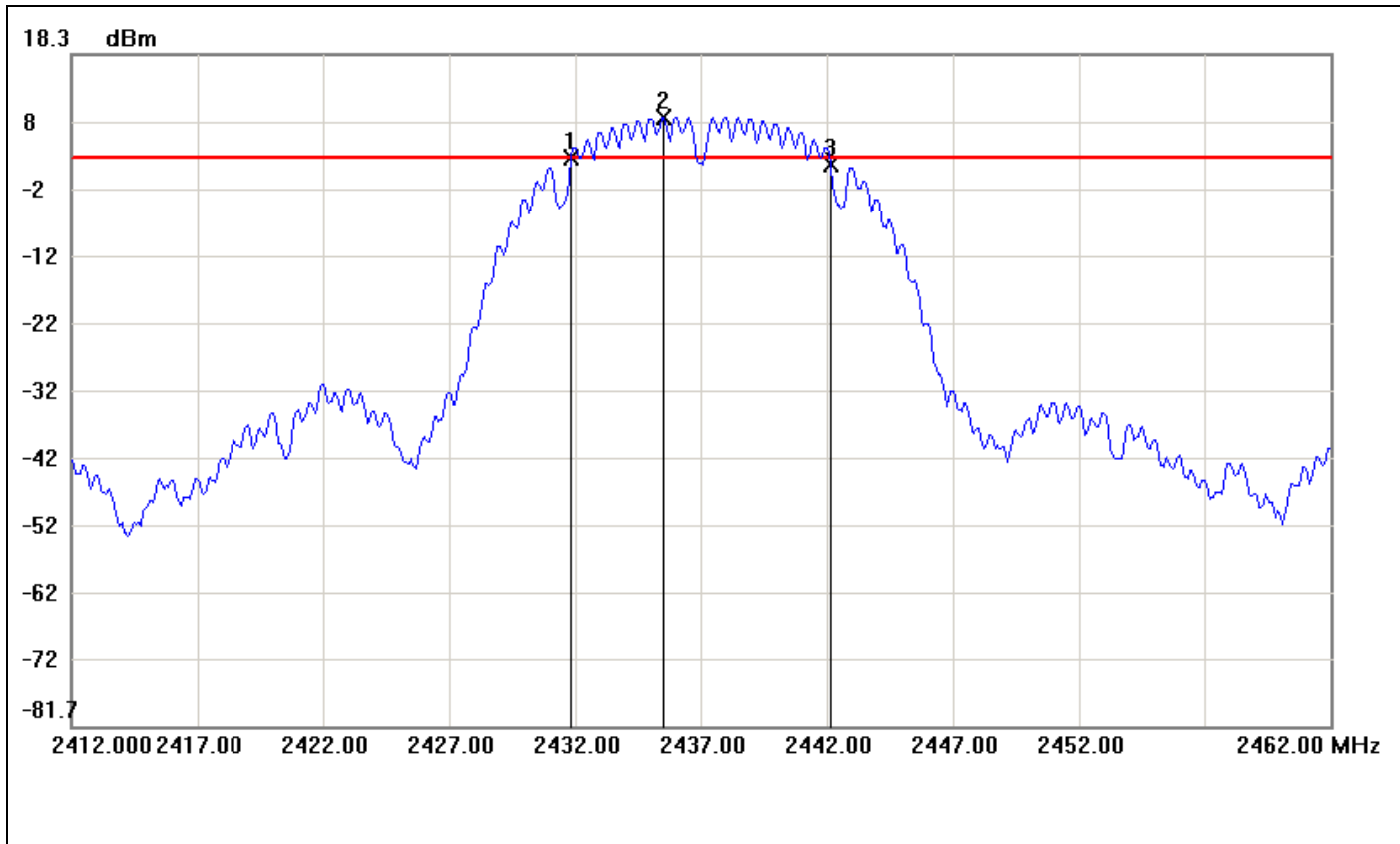

| No. | Frequency(MHz) | Result(dBm) | Limit(dBm) | Margin(dBm) |
|-----|----------------|-------------|------------|-------------|
| 1   | 2431.8333      | 2.87        | 2.89       | -0.02       |
| 2   | 2435.5000      | 8.89        | 2.89       | 6.00        |
| 3   | 2442.1667      | 1.90        | 2.89       | -0.99       |

| No. |         | $\Delta$ Frequency(MHz) | $\Delta$ Level(dB) |
|-----|---------|-------------------------|--------------------|
| 1   | mk3-mk1 | 10.3334                 | -0.97              |





**6dB Bandwidth (CH High)**

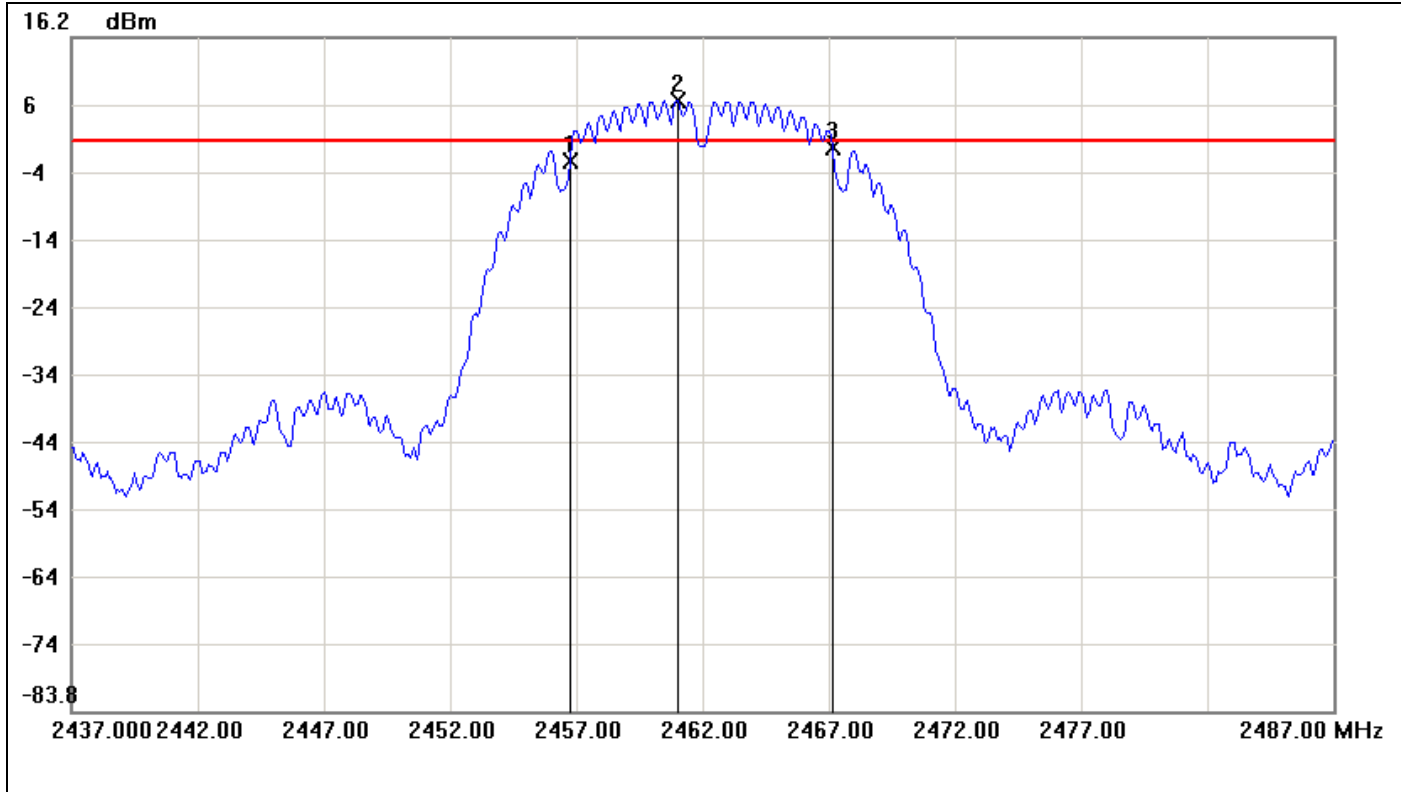

| No. | Frequency(MHz) | Result(dBm) | Limit(dBm) | Margin(dBm) |
|-----|----------------|-------------|------------|-------------|
| 1   | 2456.7500      | -2.25       | 0.70       | -2.95       |
| 2   | 2461.0000      | 6.70        | 0.70       | 6.00        |
| 3   | 2467.1667      | -0.28       | 0.70       | -0.98       |

| No. |         | $\Delta$ Frequency(MHz) | $\Delta$ Level(dB) |
|-----|---------|-------------------------|--------------------|
| 1   | mk3-mk1 | 10.4167                 | 1.97               |



**IEEE 802.11g mode**

**6dB Bandwidth (CH Low)**

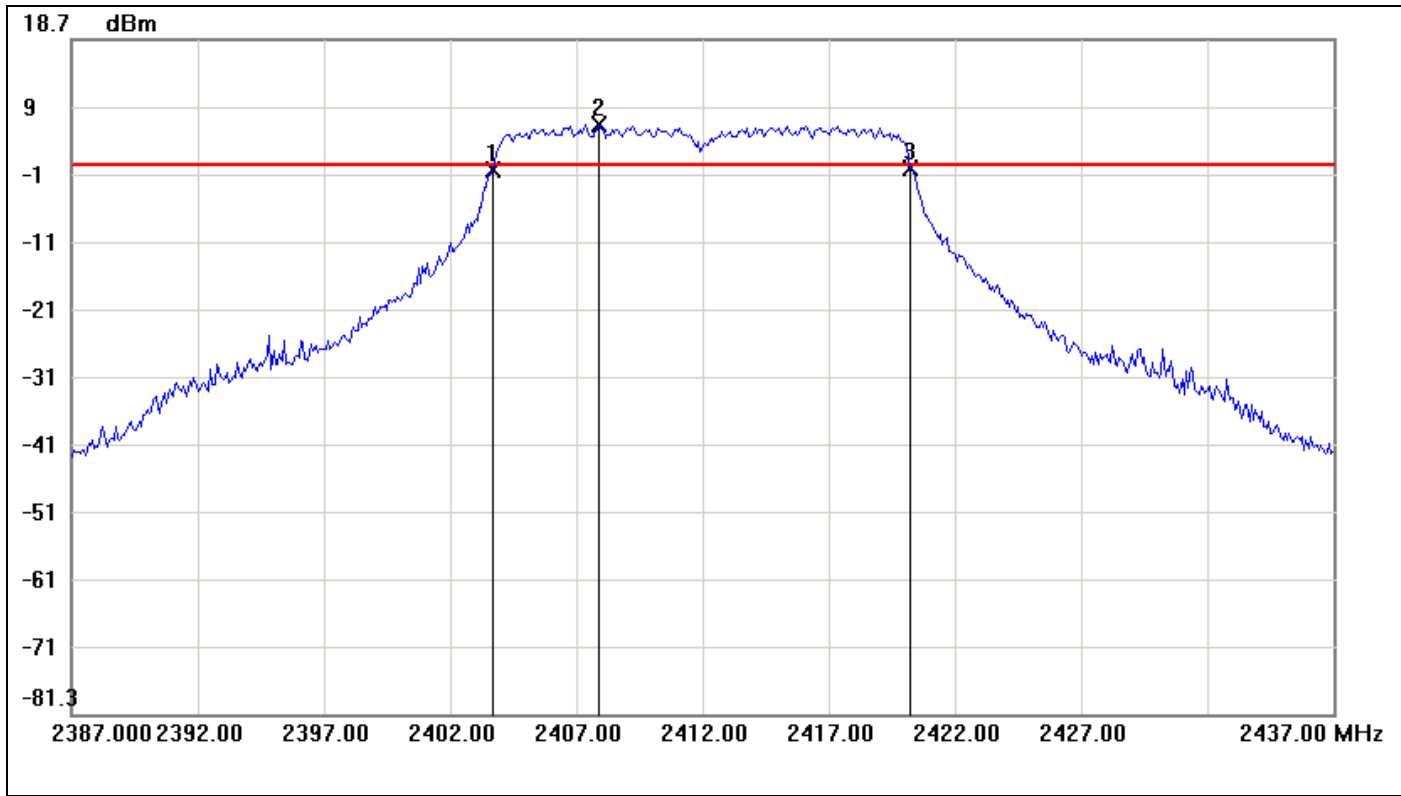

| No. | Frequency(MHz) | Result(dBm) | Limit(dBm) | Margin(dBm) |
|-----|----------------|-------------|------------|-------------|
| 1   | 2403.6667      | -0.79       | 0.13       | -0.92       |
| 2   | 2407.9167      | 6.13        | 0.13       | 6.00        |
| 3   | 2420.2500      | -0.40       | 0.13       | -0.53       |

| No. |         | $\Delta$ Frequency(MHz) | $\Delta$ Level(dB) |
|-----|---------|-------------------------|--------------------|
| 1   | mk3-mk1 | 16.5833                 | 0.39               |



6dB Bandwidth (CH Mid)

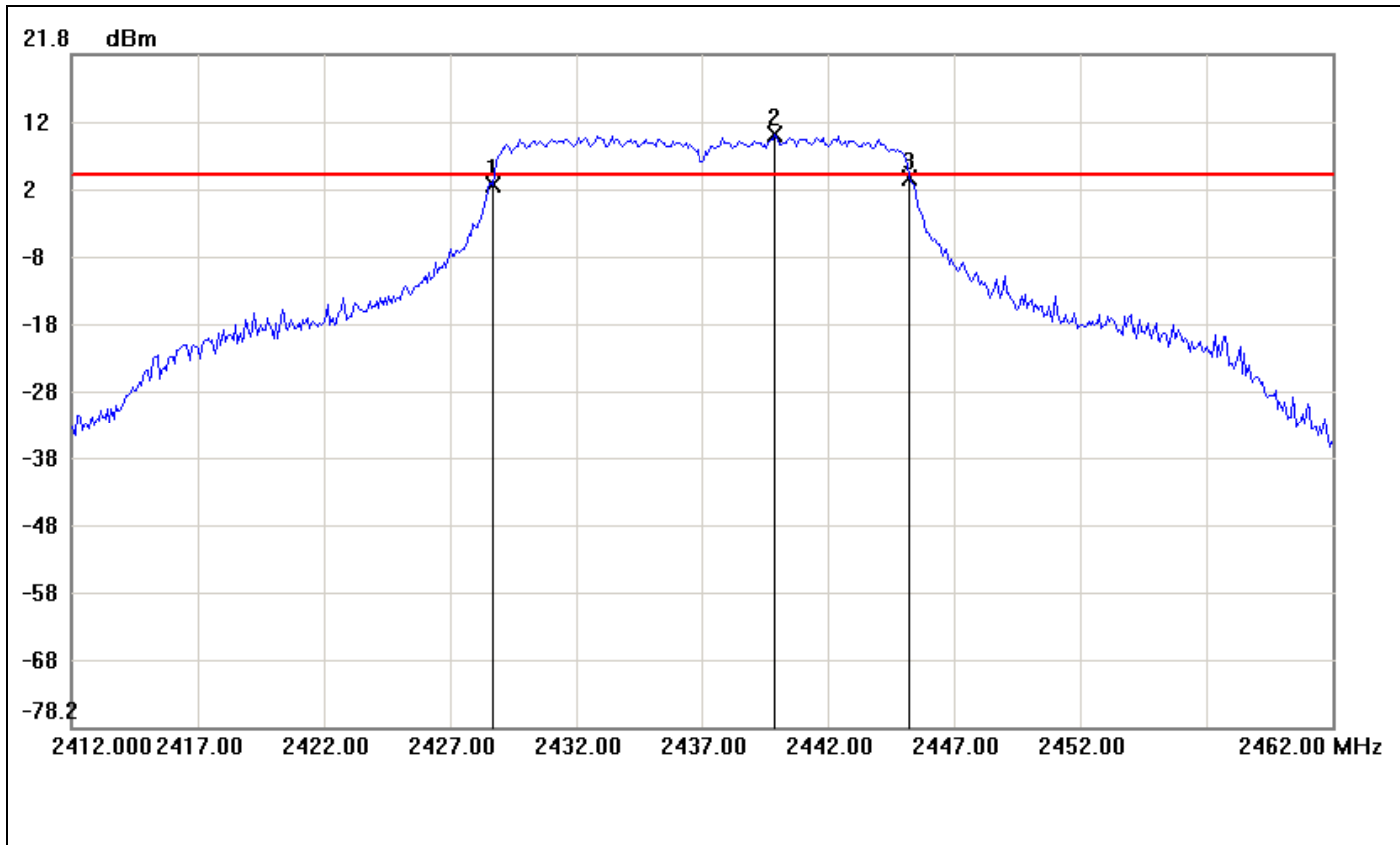

| No. | Frequency(MHz) | Result(dBm) | Limit(dBm) | Margin(dBm) |
|-----|----------------|-------------|------------|-------------|
| 1   | 2428.6667      | 2.52        | 3.82       | -1.30       |
| 2   | 2439.9167      | 9.82        | 3.82       | 6.00        |
| 3   | 2445.2500      | 3.32        | 3.82       | -0.50       |

| No. |         | $\Delta$ Frequency(MHz) | $\Delta$ Level(dB) |
|-----|---------|-------------------------|--------------------|
| 1   | mk3-mk1 | 16.5833                 | 0.8                |



6dB Bandwidth (CH High)

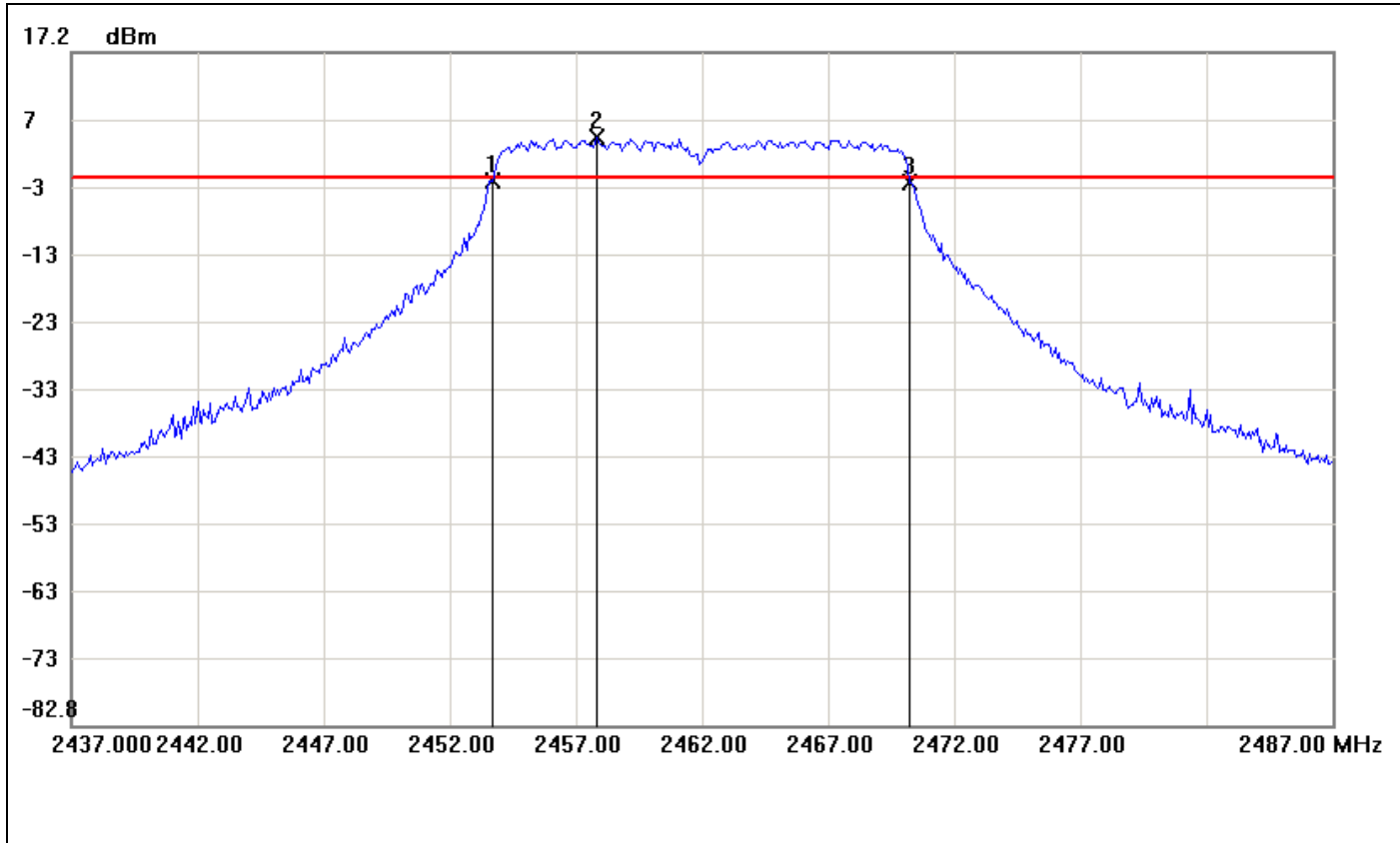

| No. | Frequency(MHz) | Result(dBm) | Limit(dBm) | Margin(dBm) |
|-----|----------------|-------------|------------|-------------|
| 1   | 2453.6667      | -1.93       | -1.53      | -0.40       |
| 2   | 2457.8333      | 4.47        | -1.53      | 6.00        |
| 3   | 2470.2500      | -2.12       | -1.53      | -0.59       |

| No. |         | $\Delta$ Frequency(MHz) | $\Delta$ Level(dB) |
|-----|---------|-------------------------|--------------------|
| 1   | mk3-mk1 | 16.5833                 | -0.19              |



**IEEE 802.11n HT 20 MHz mode**

**6dB Bandwidth (CH Low)**

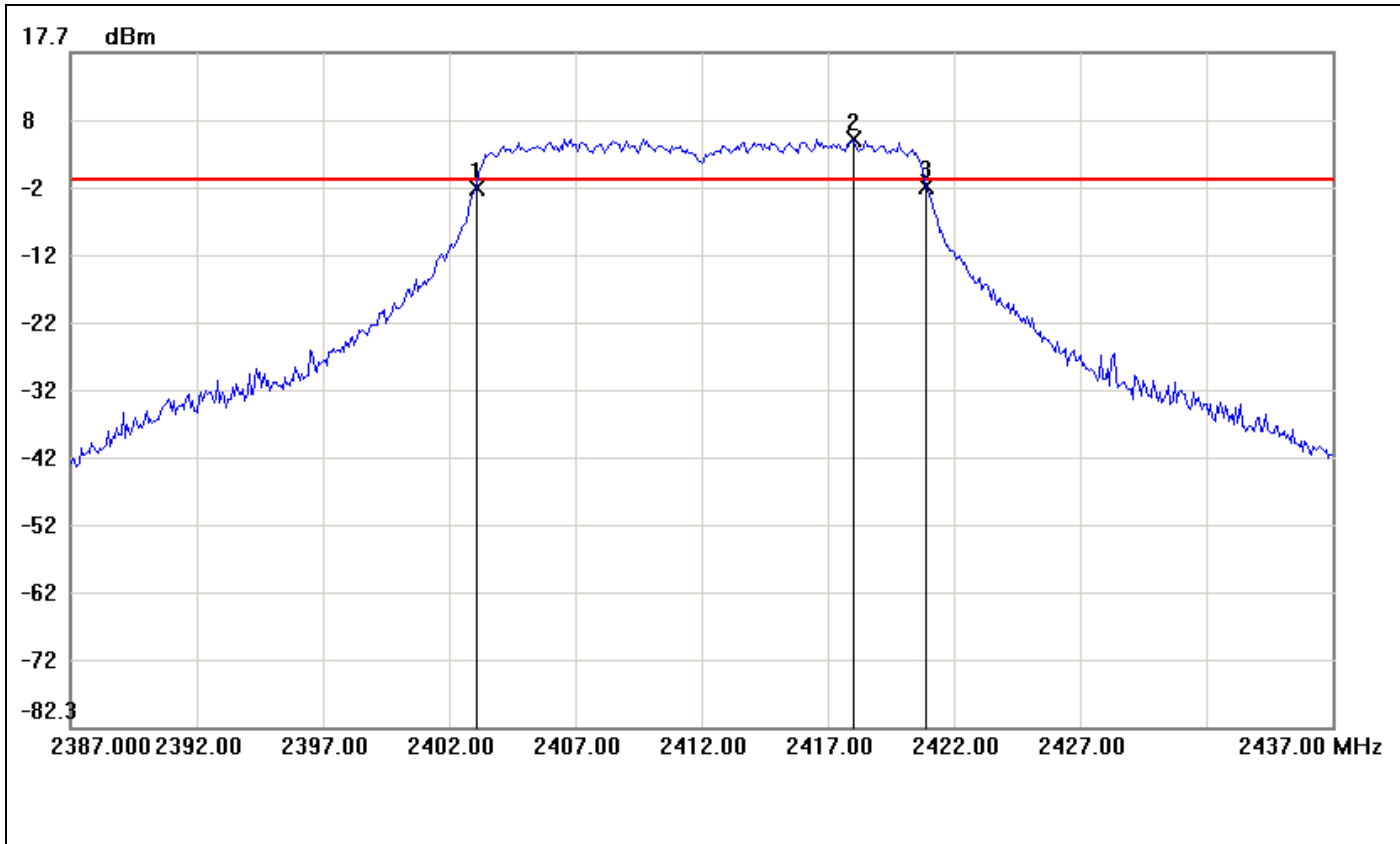

| No. | Frequency(MHz) | Result(dBm) | Limit(dBm) | Margin(dBm) |
|-----|----------------|-------------|------------|-------------|
| 1   | 2403.0833      | -2.37       | -1.12      | -1.25       |
| 2   | 2418.0000      | 4.88        | -1.12      | 6.00        |
| 3   | 2420.9167      | -2.23       | -1.12      | -1.11       |

| No. |         | $\Delta$ Frequency(MHz) | $\Delta$ Level(dB) |
|-----|---------|-------------------------|--------------------|
| 1   | mk3-mk1 | 17.8334                 | 0.14               |



**6dB Bandwidth (CH Mid)**

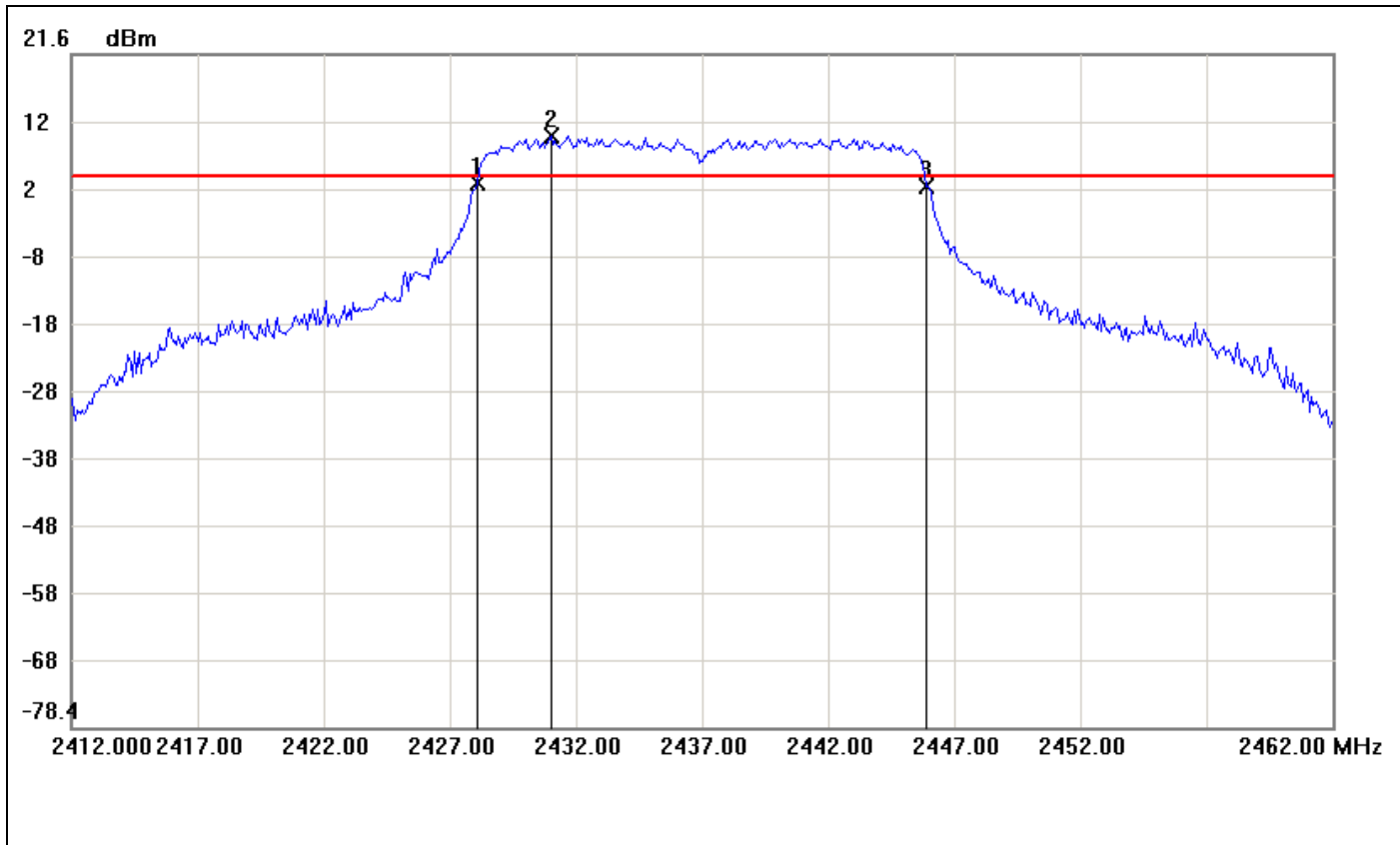

| No. | Frequency(MHz) | Result(dBm) | Limit(dBm) | Margin(dBm) |
|-----|----------------|-------------|------------|-------------|
| 1   | 2428.0833      | 2.46        | 3.54       | -1.08       |
| 2   | 2431.0000      | 9.54        | 3.54       | 6.00        |
| 3   | 2445.9167      | 1.94        | 3.54       | -1.60       |

| No. |         | $\Delta$ Frequency(MHz) | $\Delta$ Level(dB) |
|-----|---------|-------------------------|--------------------|
| 1   | mk3-mk1 | 17.8334                 | -0.52              |



### 6dB Bandwidth (CH High)

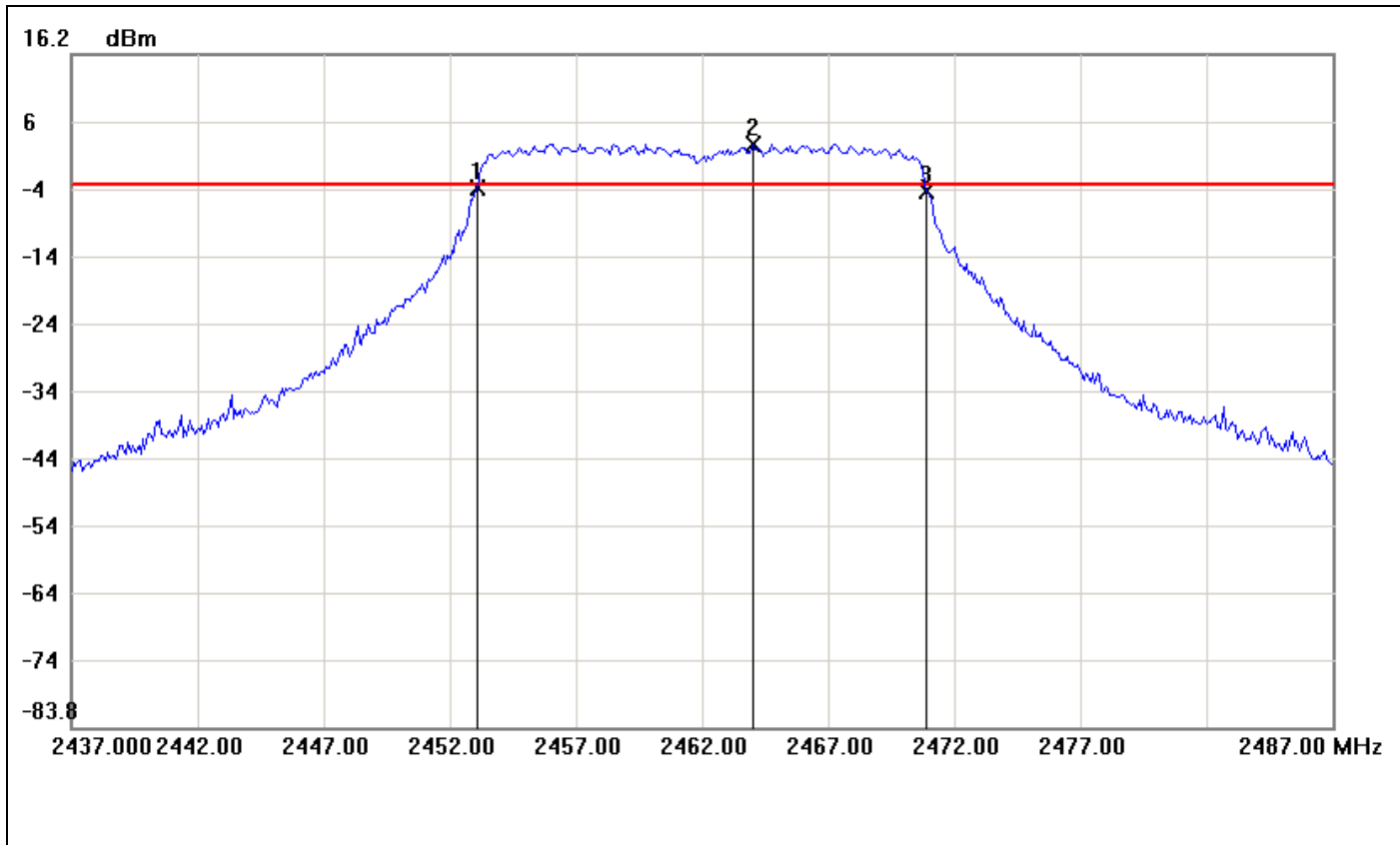

| No. | Frequency(MHz) | Result(dBm) | Limit(dBm) | Margin(dBm) |
|-----|----------------|-------------|------------|-------------|
| 1   | 2453.0833      | -3.56       | -3.03      | -0.53       |
| 2   | 2464.0000      | 2.97        | -3.03      | 6.00        |
| 3   | 2470.9167      | -4.23       | -3.03      | -1.20       |

| No. |         | $\Delta$ Frequency(MHz) | $\Delta$ Level(dB) |
|-----|---------|-------------------------|--------------------|
| 1   | mk3-mk1 | 17.8334                 | -0.67              |



**IEEE 802.11n HT 40 MHz mode**

**6dB Bandwidth (CH Low)**

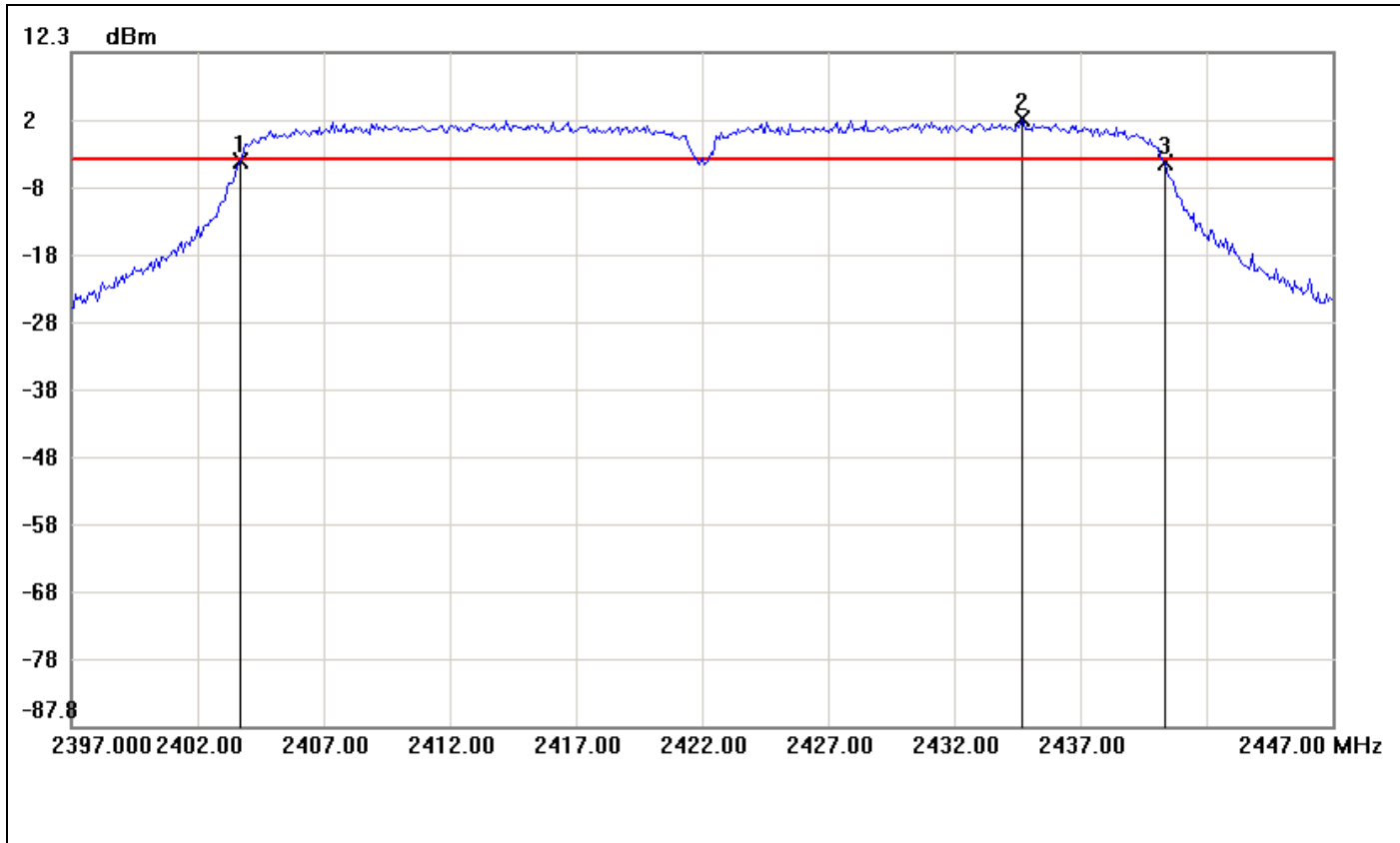

| No. | Frequency(MHz) | Result(dBm) | Limit(dBm) | Margin(dBm) |
|-----|----------------|-------------|------------|-------------|
| 1   | 2403.6667      | -3.97       | -3.66      | -0.31       |
| 2   | 2434.6667      | 2.34        | -3.66      | 6.00        |
| 3   | 2440.3333      | -4.03       | -3.66      | -0.37       |

| No. |         | $\Delta$ Frequency(MHz) | $\Delta$ Level(dB) |
|-----|---------|-------------------------|--------------------|
| 1   | mk3-mk1 | 36.6666                 | -0.06              |





### 6dB Bandwidth (CH Mid)

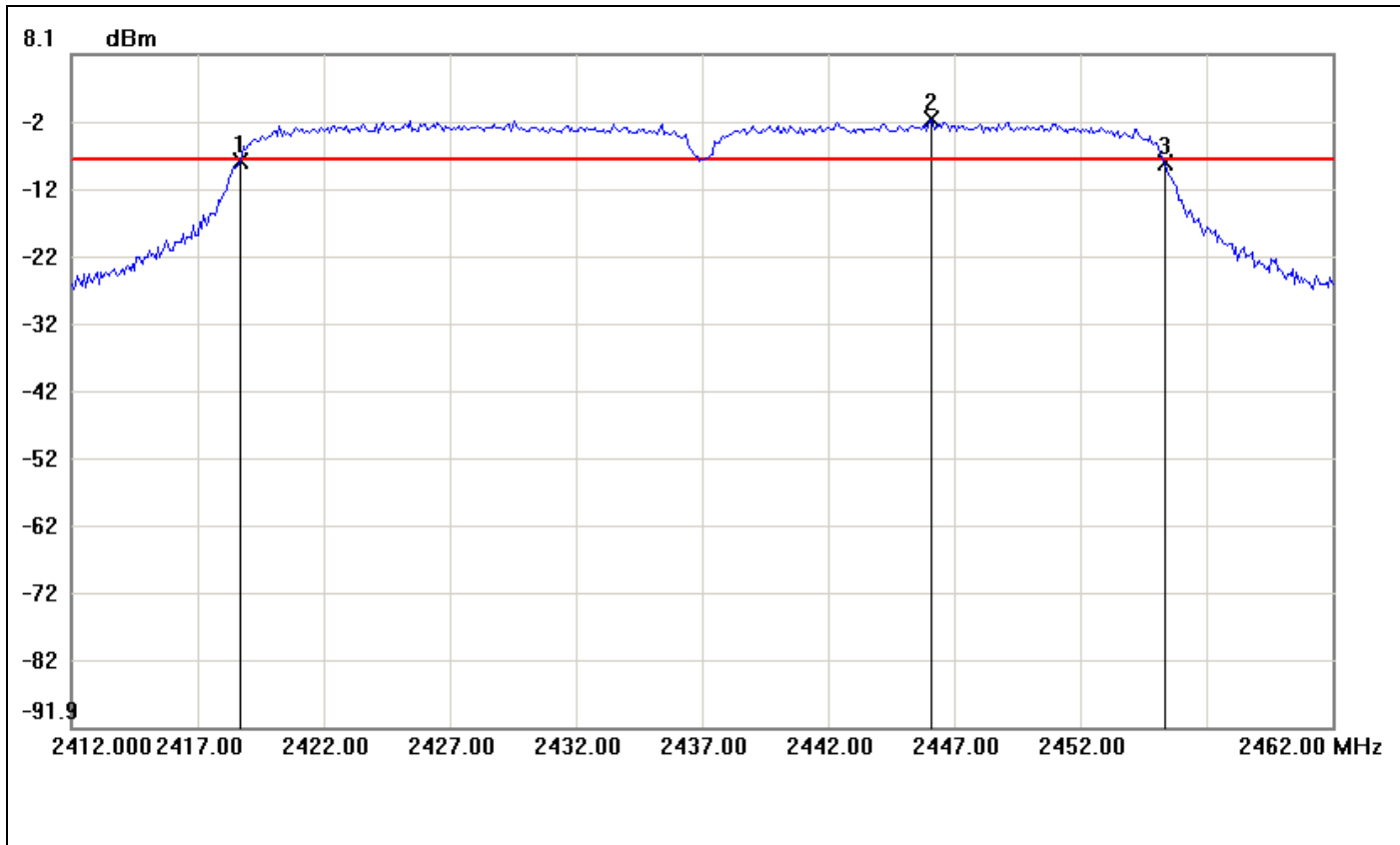

| No. | Frequency(MHz) | Result(dBm) | Limit(dBm) | Margin(dBm) |
|-----|----------------|-------------|------------|-------------|
| 1   | 2418.6667      | -7.71       | -7.65      | -0.06       |
| 2   | 2446.0833      | -1.65       | -7.65      | 6.00        |
| 3   | 2455.3333      | -8.03       | -7.65      | -0.38       |

| No. |         | $\Delta$ Frequency(MHz) | $\Delta$ Level(dB) |
|-----|---------|-------------------------|--------------------|
| 1   | mk3-mk1 | 36.6666                 | -0.32              |



6dB Bandwidth (CH High)

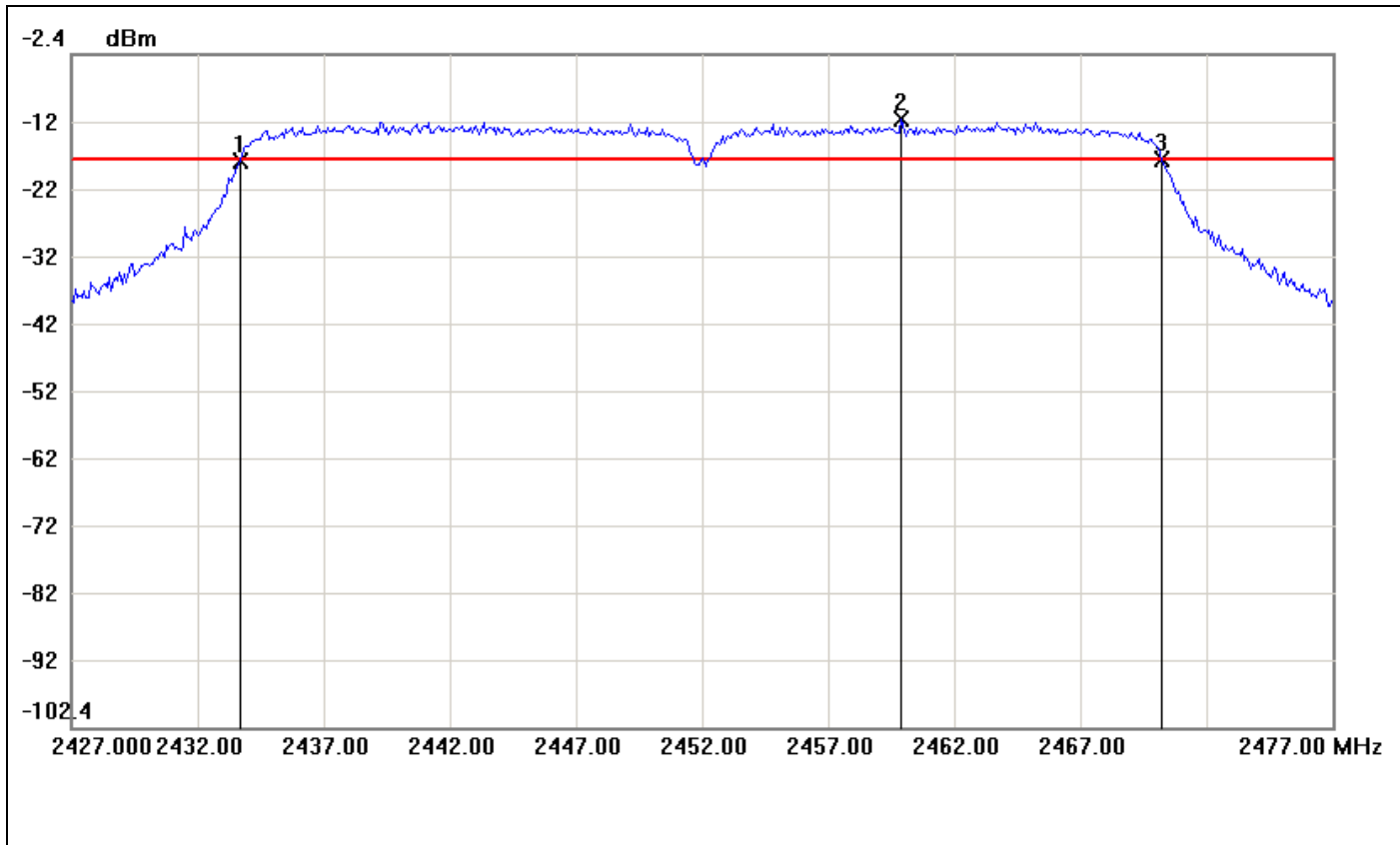

| No. | Frequency(MHz) | Result(dBm) | Limit(dBm) | Margin(dBm) |
|-----|----------------|-------------|------------|-------------|
| 1   | 2433.6667      | -18.30      | -18.01     | -0.29       |
| 2   | 2459.9167      | -12.01      | -18.01     | 6.00        |
| 3   | 2470.2500      | -18.02      | -18.01     | -0.01       |

| No. |         | $\Delta$ Frequency(MHz) | $\Delta$ Level(dB) |
|-----|---------|-------------------------|--------------------|
| 1   | mk3-mk1 | 36.5833                 | 0.28               |



**IEEE 802.11a mode**

**6dB Bandwidth (CH Low)**

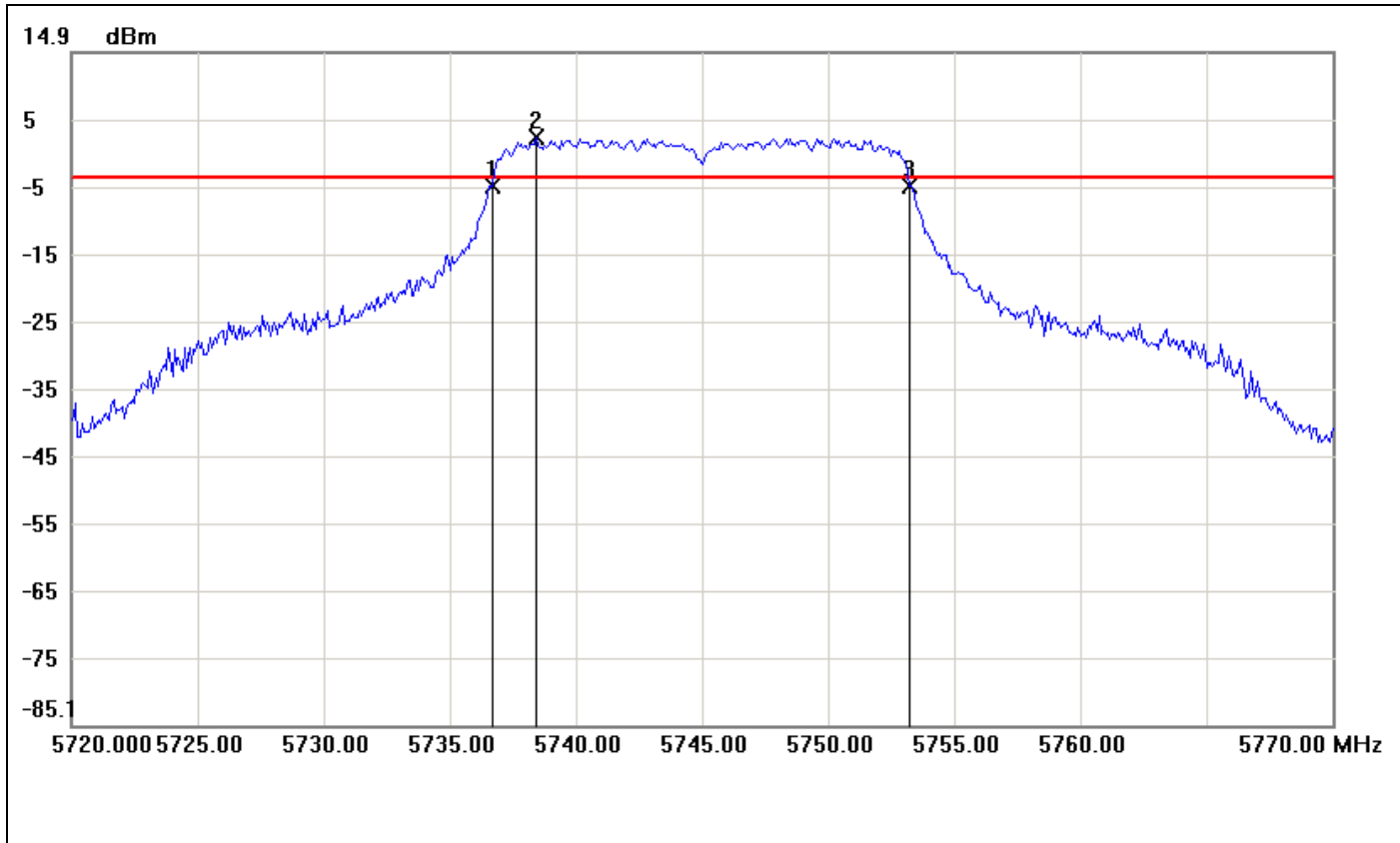

| No. | Frequency(MHz) | Result(dBm) | Limit(dBm) | Margin(dBm) |
|-----|----------------|-------------|------------|-------------|
| 1   | 5736.6667      | -4.98       | -3.68      | -1.30       |
| 2   | 5738.4167      | 2.32        | -3.68      | 6.00        |
| 3   | 5753.2500      | -5.08       | -3.68      | -1.40       |

| No. |         | $\Delta$ Frequency(MHz) | $\Delta$ Level(dB) |
|-----|---------|-------------------------|--------------------|
| 1   | mk3-mk1 | 16.5833                 | -0.1               |



6dB Bandwidth (CH Mid)

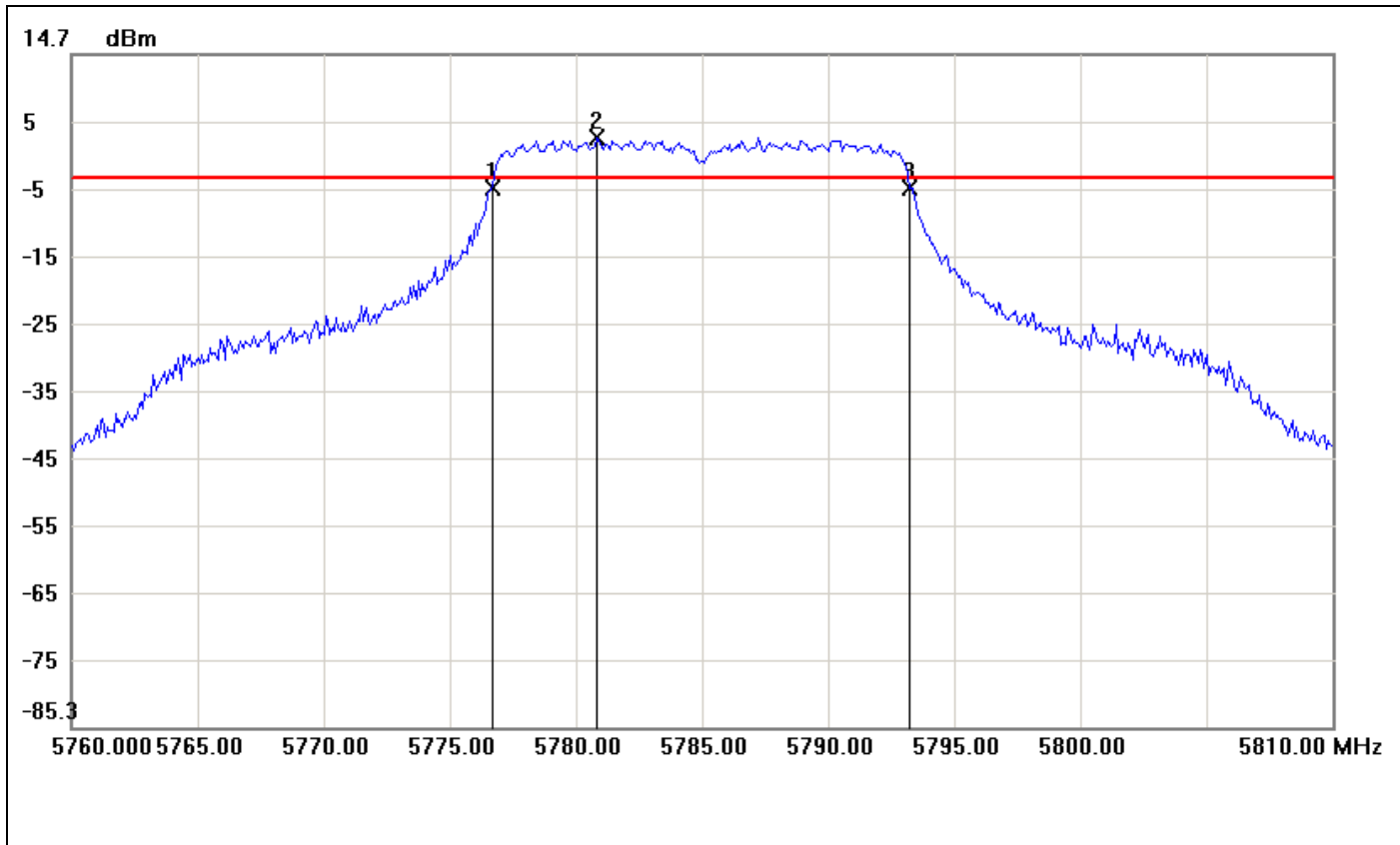

| No. | Frequency(MHz) | Result(dBm) | Limit(dBm) | Margin(dBm) |
|-----|----------------|-------------|------------|-------------|
| 1   | 5776.6667      | -5.01       | -3.54      | -1.47       |
| 2   | 5780.8333      | 2.46        | -3.54      | 6.00        |
| 3   | 5793.2500      | -5.07       | -3.54      | -1.53       |

| No. |         | $\Delta$ Frequency(MHz) | $\Delta$ Level(dB) |
|-----|---------|-------------------------|--------------------|
| 1   | mk3-mk1 | 16.5833                 | -0.06              |



6dB Bandwidth (CH High)

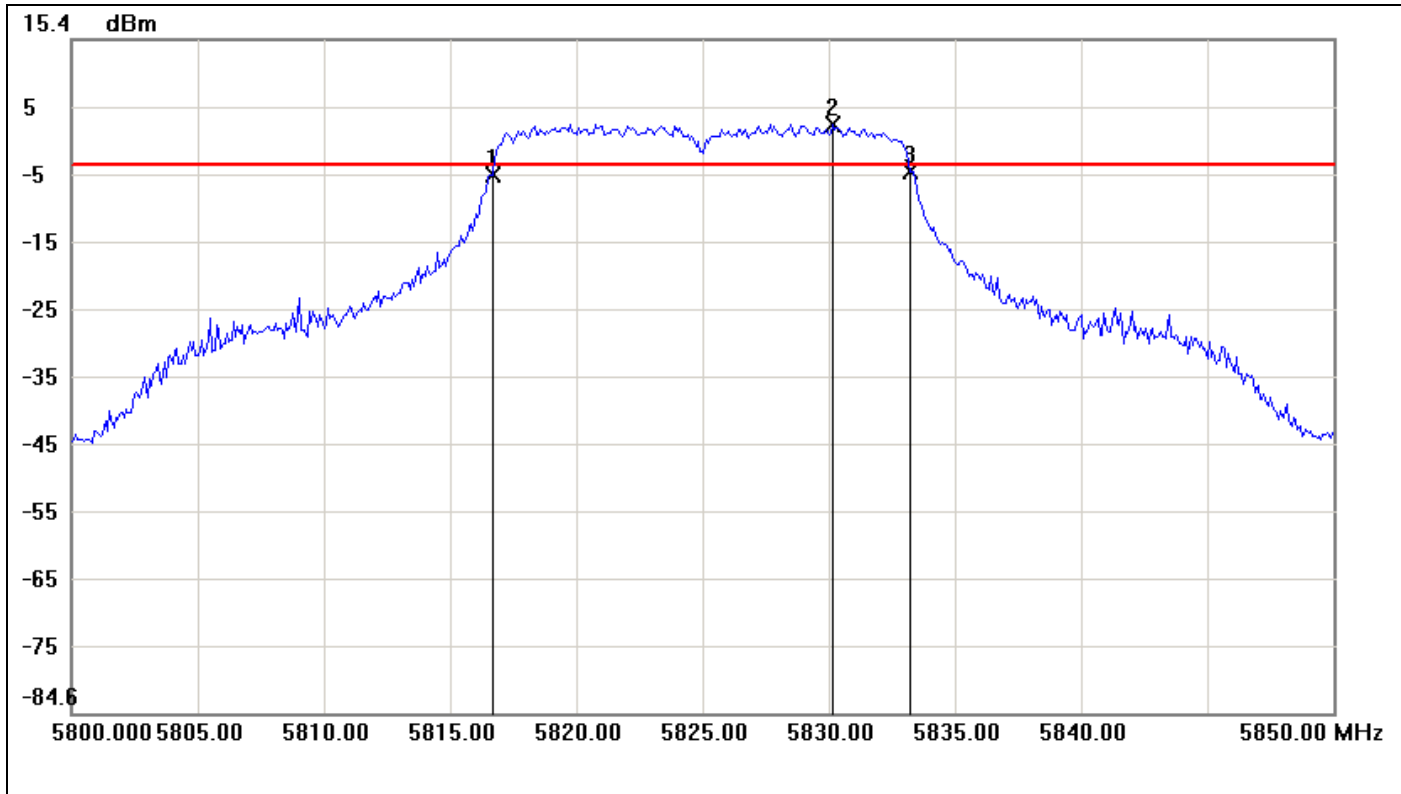

| No. | Frequency(MHz) | Result(dBm) | Limit(dBm) | Margin(dBm) |
|-----|----------------|-------------|------------|-------------|
| 1   | 5816.6667      | -4.63       | -3.25      | -1.38       |
| 2   | 5830.1667      | 2.75        | -3.25      | 6.00        |
| 3   | 5833.2500      | -4.31       | -3.25      | -1.06       |

| No. |         | $\Delta$ Frequency(MHz) | $\Delta$ Level(dB) |
|-----|---------|-------------------------|--------------------|
| 1   | mk3-mk1 | 16.5833                 | 0.32               |



**IEEE 802.11n HT 20 MHz mode**

**6dB Bandwidth (CH Low)**

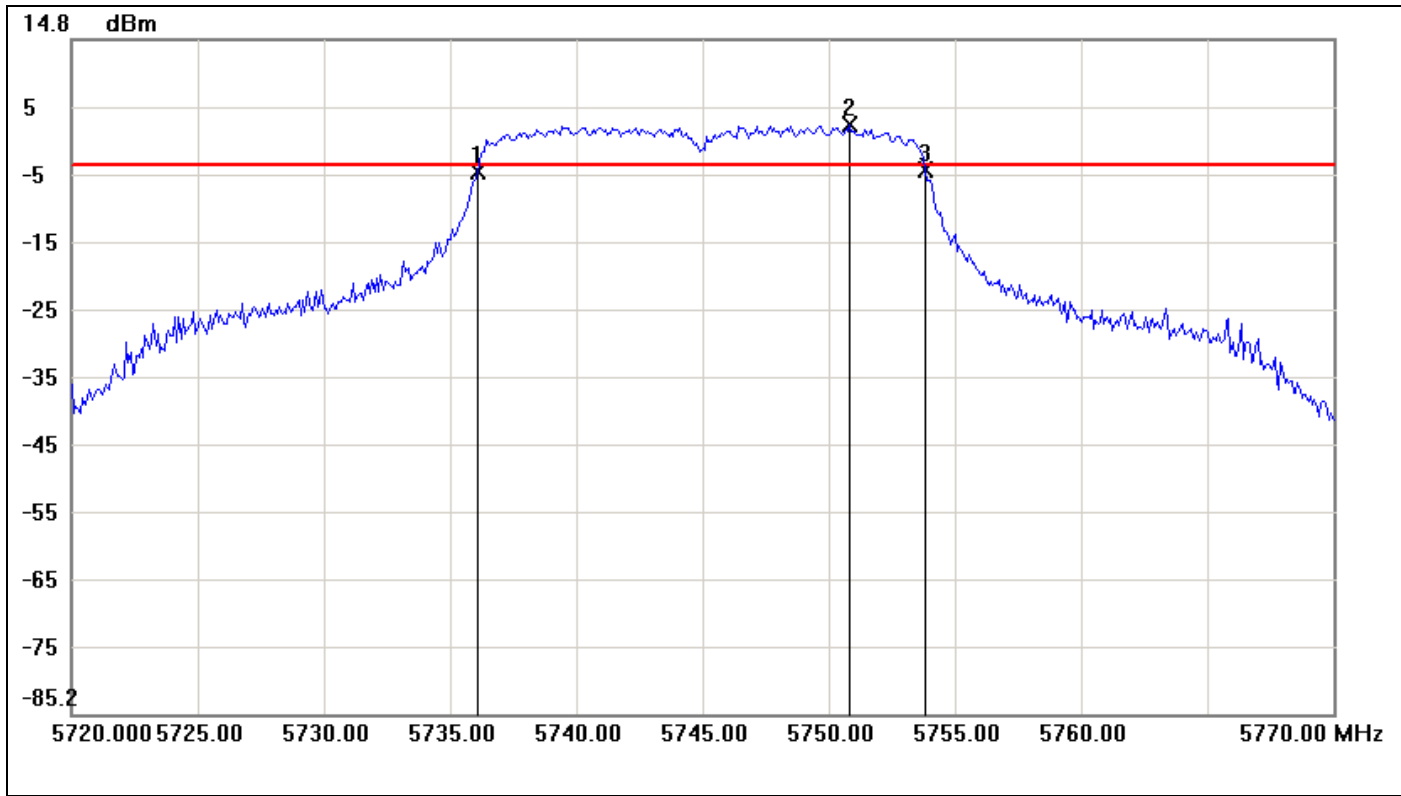

| No. | Frequency(MHz) | Result(dBm) | Limit(dBm) | Margin(dBm) |
|-----|----------------|-------------|------------|-------------|
| 1   | 5736.0833      | -4.74       | -3.82      | -0.92       |
| 2   | 5750.8333      | 2.18        | -3.82      | 6.00        |
| 3   | 5753.8333      | -4.52       | -3.82      | -0.70       |

| No. |         | $\Delta$ Frequency(MHz) | $\Delta$ Level(dB) |
|-----|---------|-------------------------|--------------------|
| 1   | mk3-mk1 | 17.75                   | 0.22               |



**6dB Bandwidth (CH Mid)**

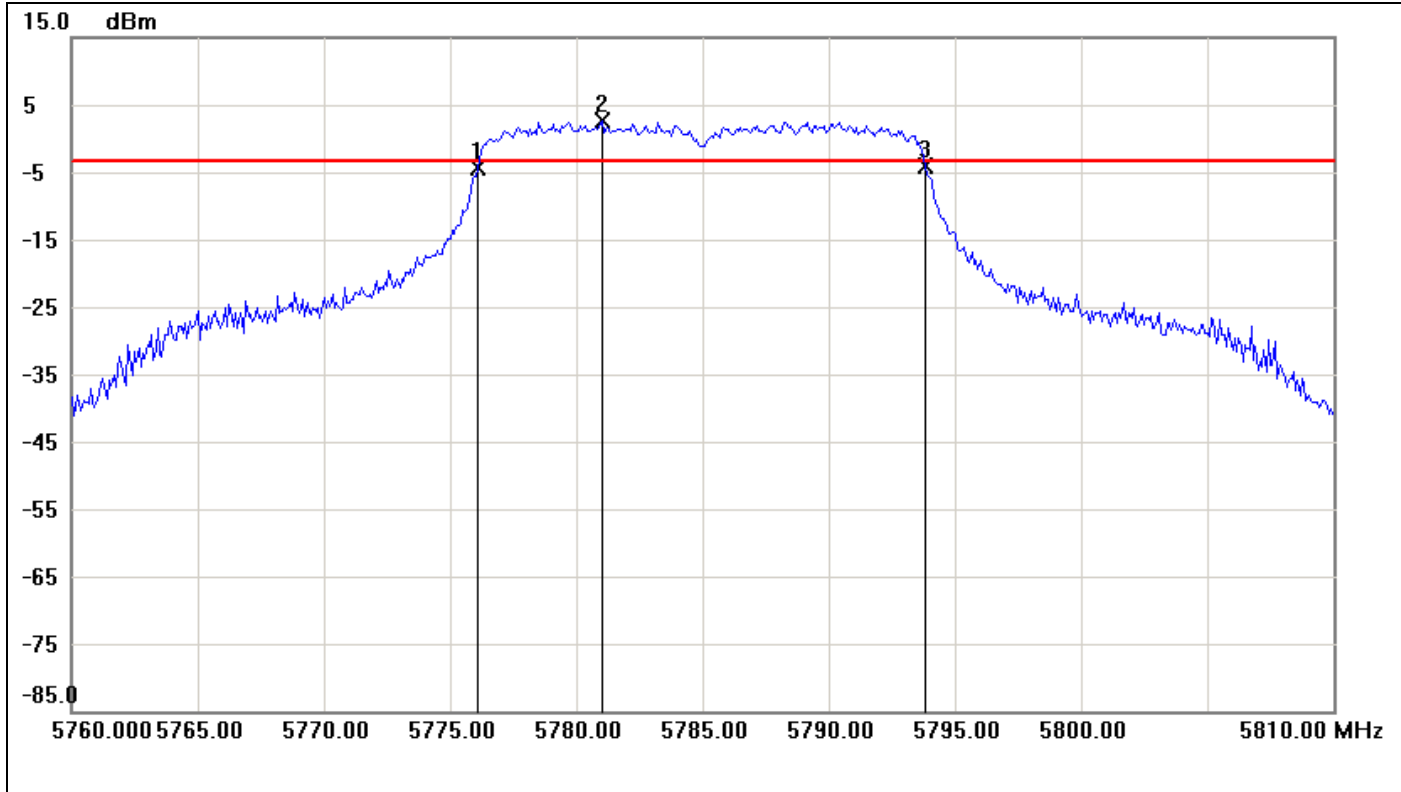

| No. | Frequency(MHz) | Result(dBm) | Limit(dBm) | Margin(dBm) |
|-----|----------------|-------------|------------|-------------|
| 1   | 5776.0833      | -4.49       | -3.33      | -1.16       |
| 2   | 5781.0000      | 2.67        | -3.33      | 6.00        |
| 3   | 5793.8333      | -4.03       | -3.33      | -0.70       |

| No. |         | $\Delta$ Frequency(MHz) | $\Delta$ Level(dB) |
|-----|---------|-------------------------|--------------------|
| 1   | mk3-mk1 | 17.75                   | 0.46               |



### 6dB Bandwidth (CH High)

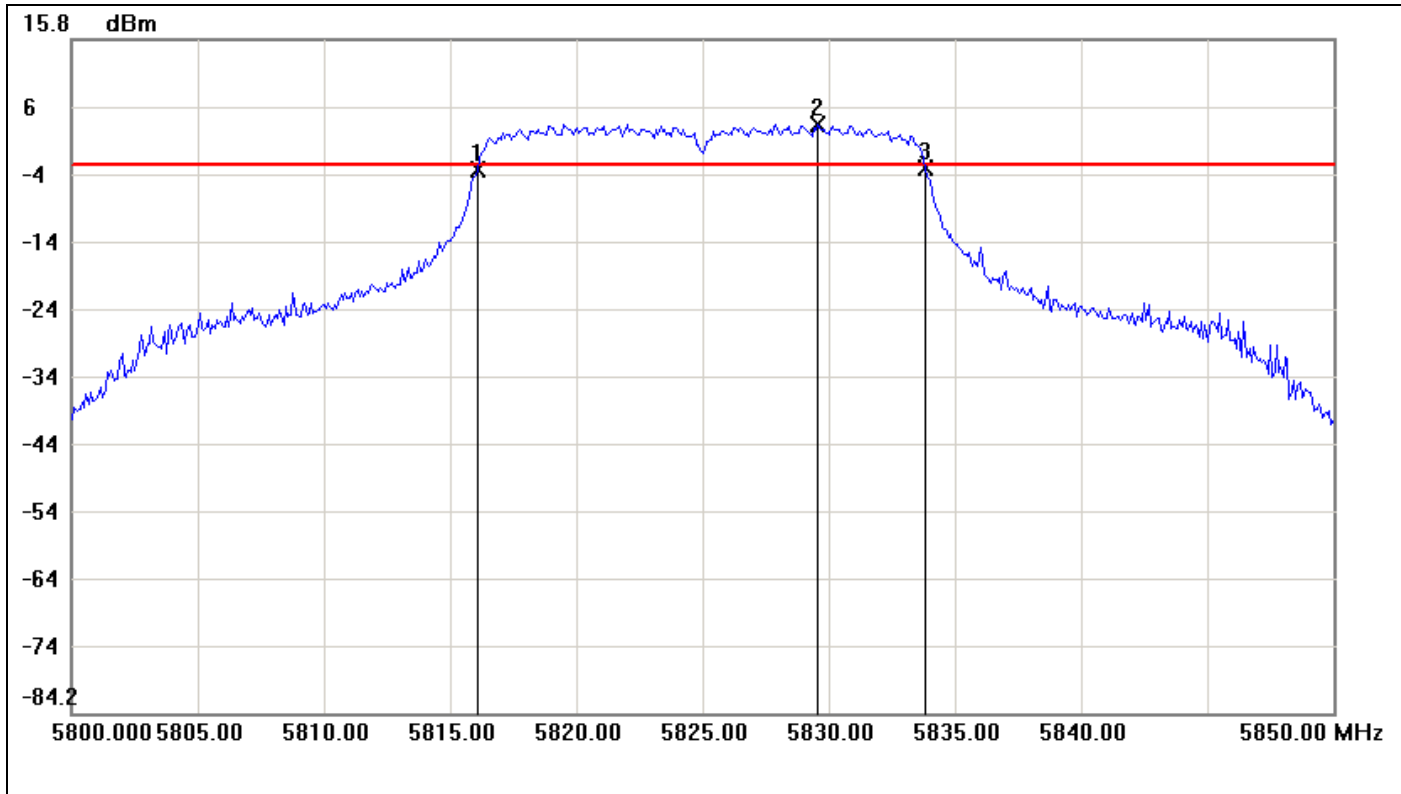

| No. | Frequency(MHz) | Result(dBm) | Limit(dBm) | Margin(dBm) |
|-----|----------------|-------------|------------|-------------|
| 1   | 5816.0833      | -3.48       | -2.75      | -0.73       |
| 2   | 5829.5833      | 3.25        | -2.75      | 6.00        |
| 3   | 5833.8333      | -3.35       | -2.75      | -0.60       |

| No. |         | $\Delta$ Frequency(MHz) | $\Delta$ Level(dB) |
|-----|---------|-------------------------|--------------------|
| 1   | mk3-mk1 | 17.75                   | 0.13               |





**IEEE 802.11n HT 40 MHz mode**

**6dB Bandwidth (CH Low)**

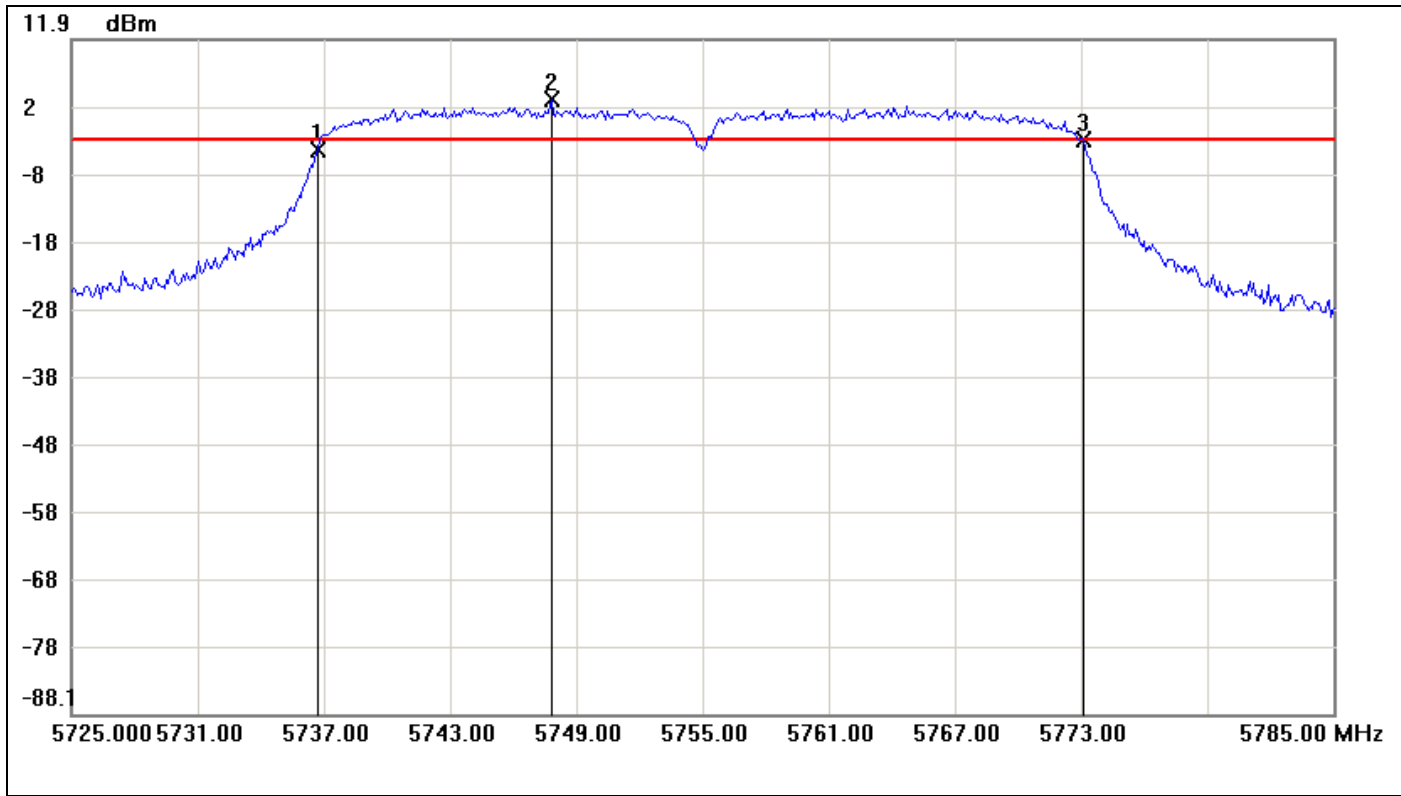

| No. | Frequency(MHz) | Result(dBm) | Limit(dBm) | Margin(dBm) |
|-----|----------------|-------------|------------|-------------|
| 1   | 5736.7000      | -4.58       | -3.05      | -1.53       |
| 2   | 5747.8000      | 2.95        | -3.05      | 6.00        |
| 3   | 5773.1000      | -3.09       | -3.05      | -0.04       |

| No. |         | $\Delta$ Frequency(MHz) | $\Delta$ Level(dB) |
|-----|---------|-------------------------|--------------------|
| 1   | mk3-mk1 | 36.4                    | 1.49               |



6dB Bandwidth (CH High)

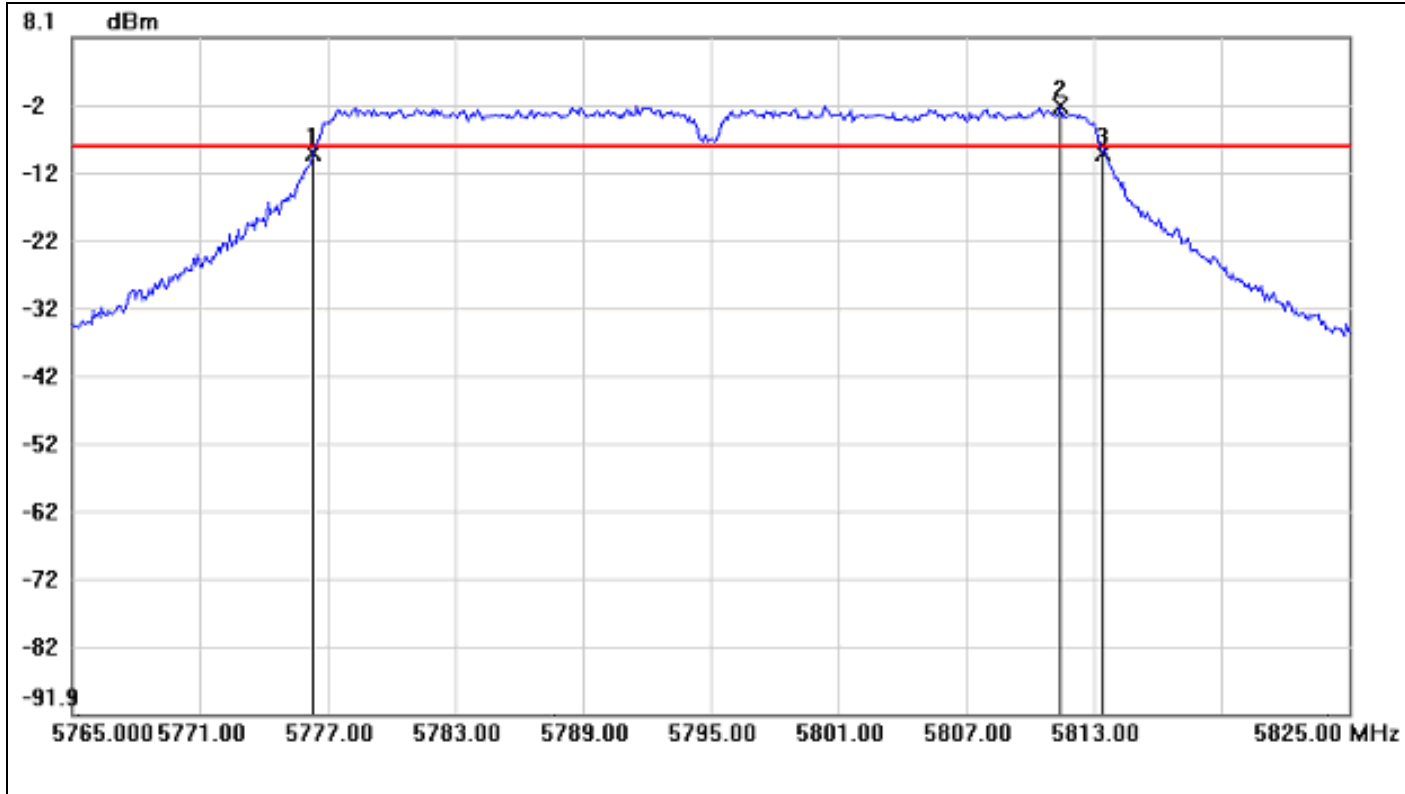

| No. | Frequency(MHz) | Result(dBm) | Limit(dBm) | Margin(dBm) |
|-----|----------------|-------------|------------|-------------|
| 1   | 5776.3000      | -9.16       | -7.99      | -1.17       |
| 2   | 5811.4000      | -1.99       | -7.99      | 6.00        |
| 3   | 5813.4000      | -8.98       | -7.99      | -0.99       |

| No. |         | $\Delta$ Frequency(MHz) | $\Delta$ Level(dB) |
|-----|---------|-------------------------|--------------------|
| 1   | mk3-mk1 | 37.1                    | 0.18               |



### 8.3 PEAK POWER

#### LIMIT

The maximum peak output power of the intentional radiator shall not exceed the following:

1. According to §15.247(b)(3), for systems using digital modulation in the bands of 902-928 MHz, 2400-2483.5 MHz, and 5725-5850 MHz: 1 Watt.
2. According to §15.247(b)(4), the conducted output power limit specified in paragraph (b) of this section is based on the use of antennas with directional gains that do not exceed 6 dBi. Except as shown in paragraph (c) of this section, if transmitting antennas of directional gain greater than 6 dBi are used, the conducted output power from the intentional radiator shall be reduced below the stated values in paragraphs (b)(1), (b)(2), and (b)(3) of this section, as appropriate, by the amount in dB that the directional gain of the antenna exceeds 6 dBi.
3. According to RSS-210 §A8.4(4), for systems employing digital modulation techniques operating in the bands 902-928 MHz, 2400-2483.5 MHz and 5725-5850 MHz, the maximum peak conducted output power shall not exceed 1 W.

#### Test Configuration

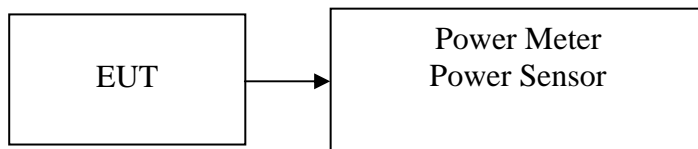

#### TEST PROCEDURE

The transmitter output is connected to the Power Meter. The Power Meter is set to the peak power detection.

#### TEST RESULTS

*No non-compliance noted*



**Test Data**

**Test mode: IEEE 802.11b mode**

| Channel | Frequency (MHz) | Output Power (dBm) | Output Power (W) | Limit (W) | Result |
|---------|-----------------|--------------------|------------------|-----------|--------|
| Low     | 2412            | 19.77              | 0.0948           | 1.00      | PASS   |
| Mid     | 2442            | 20.04              | 0.1009           |           | PASS   |
| High    | 2462            | 18.24              | 0.0667           |           | PASS   |

**Test mode: IEEE 802.11g mode**

| Channel | Frequency (MHz) | Output Power (dBm) | Output Power (W) | Limit (W) | Result |
|---------|-----------------|--------------------|------------------|-----------|--------|
| Low     | 2412            | 23.47              | 0.2223           | 1.00      | PASS   |
| Mid     | 2442            | 25.36              | 0.3436           |           | PASS   |
| High    | 2462            | 22.56              | 0.1803           |           | PASS   |

**Test mode: IEEE 802.11n HT 20 MHz mode**

| Channel | Frequency (MHz) | Output Power (dBm) | Output Power (W) | Limit (W) | Result |
|---------|-----------------|--------------------|------------------|-----------|--------|
| Low     | 2412            | 23.02              | 0.2004           | 1.00      | PASS   |
| Mid     | 2442            | 25.23              | 0.3334           |           | PASS   |
| High    | 2462            | 21.87              | 0.1538           |           | PASS   |

**Test mode: IEEE 802.11n HT 40 MHz mode**

| Channel | Frequency (MHz) | Output Power (dBm) | Output Power (W) | Limit (W) | Result |
|---------|-----------------|--------------------|------------------|-----------|--------|
| Low     | 2422            | 21.65              | 0.1462           | 1.00      | PASS   |
| Mid     | 2442            | 25.07              | 0.3214           |           | PASS   |
| High    | 2452            | 17.79              | 0.0601           |           | PASS   |



**Test mode: IEEE 802.11a mode**

| Channel | Frequency (MHz) | Output Power (dBm) | Output Power (W) | Limit (W) | Result |
|---------|-----------------|--------------------|------------------|-----------|--------|
| Low     | 5745            | 21.72              | 0.1486           | 1.00      | PASS   |
| Mid     | 5785            | 21.51              | 0.1416           |           | PASS   |
| High    | 5825            | 21.35              | 0.1365           |           | PASS   |

**Test mode: IEEE 802.11n HT 20 MHz mode**

| Channel | Frequency (MHz) | Output Power (dBm) | Output Power (W) | Limit (W) | Result |
|---------|-----------------|--------------------|------------------|-----------|--------|
| Low     | 5745            | 21.58              | 0.1439           | 1.00      | PASS   |
| Mid     | 5785            | 21.71              | 0.1483           |           | PASS   |
| High    | 5825            | 21.67              | 0.1469           |           | PASS   |

**Test mode: IEEE 802.11n HT 40 MHz mode**

| Channel | Frequency (MHz) | Output Power (dBm) | Output Power (W) | Limit (W) | Result |
|---------|-----------------|--------------------|------------------|-----------|--------|
| Low     | 5755            | 21.73              | 0.1489           | 1.00      | PASS   |
| High    | 5795            | 21.32              | 0.1355           |           | PASS   |



## 8.4 AVERAGE POWER

### LIMIT

None; for reporting purposes only.

### Test Configuration

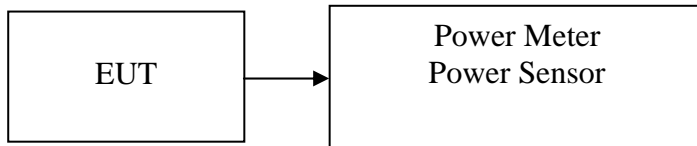

### TEST PROCEDURE

The transmitter output is connected to the Power Meter. The Power Meter is set to the average power detection.

### TEST RESULTS

*No non-compliance noted*



**Test Data**

**Test mode: IEEE 802.11b mode**

| Channel | Frequency (MHz) | Output Power (dBm) | Output Power (W) |
|---------|-----------------|--------------------|------------------|
| Low     | 2412            | 17.39              | 0.0548           |
| Mid     | 2442            | 17.77              | 0.0598           |
| High    | 2462            | 15.84              | 0.0384           |

**Test mode: IEEE 802.11g mode**

| Channel | Frequency (MHz) | Output Power (dBm) | Output Power (W) |
|---------|-----------------|--------------------|------------------|
| Low     | 2412            | 14.24              | 0.0265           |
| Mid     | 2442            | 17.97              | 0.0627           |
| High    | 2462            | 12.64              | 0.0184           |

**Test mode: IEEE 802.11n HT 20 MHz mode**

| Channel | Frequency (MHz) | Output Power (dBm) | Output Power (W) |
|---------|-----------------|--------------------|------------------|
| Low     | 2412            | 13.26              | 0.0212           |
| Mid     | 2442            | 17.72              | 0.0592           |
| High    | 2462            | 11.48              | 0.0141           |

**Test mode: IEEE 802.11n HT 40 MHz mode**

| Channel | Frequency (MHz) | Output Power (dBm) | Output Power (W) |
|---------|-----------------|--------------------|------------------|
| Low     | 2422            | 11.39              | 0.0138           |
| Mid     | 2442            | 17.81              | 0.0604           |
| High    | 2452            | 7.24               | 0.0053           |



**Test mode: IEEE 802.11a mode**

| Channel | Frequency (MHz) | Output Power (dBm) | Output Power (W) |
|---------|-----------------|--------------------|------------------|
| Low     | 5745            | 14.44              | 0.0278           |
| Mid     | 5785            | 14.78              | 0.0301           |
| High    | 5825            | 14.43              | 0.0277           |

**Test mode: IEEE 802.11n HT 20 MHz mode**

| Channel | Frequency (MHz) | Output Power (dBm) | Output Power (W) |
|---------|-----------------|--------------------|------------------|
| Low     | 5745            | 14.07              | 0.0255           |
| Mid     | 5785            | 14.12              | 0.0258           |
| High    | 5825            | 14.3               | 0.0269           |

**Test mode: IEEE 802.11n HT 40 MHz mode**

| Channel | Frequency (MHz) | Output Power (dBm) | Output Power (W) |
|---------|-----------------|--------------------|------------------|
| Low     | 5755            | 14                 | 0.0251           |
| High    | 5795            | 13.78              | 0.0239           |





## 8.5 BAND EDGES MEASUREMENT

### LIMIT

According to §15.247(d) & RSS-210 §A8.5, in any 100 kHz bandwidth outside the frequency bands in which the spread spectrum intentional radiator is operating, the radio frequency power that is produced by the intentional radiator shall be at least 20 dB below that in the 100 kHz bandwidth within the band that contains the highest level of the desired power, based on either an RF conducted or a radiated measurement, provided the transmitter demonstrates compliance with the peak conducted power limits. In addition, radiated emissions which fall in the restricted bands, as defined in §15.205(a), must also comply with the radiated emission limits specified in 15.209(a) (see Section 15.205(c)).

### Test Configuration

#### For Radiated

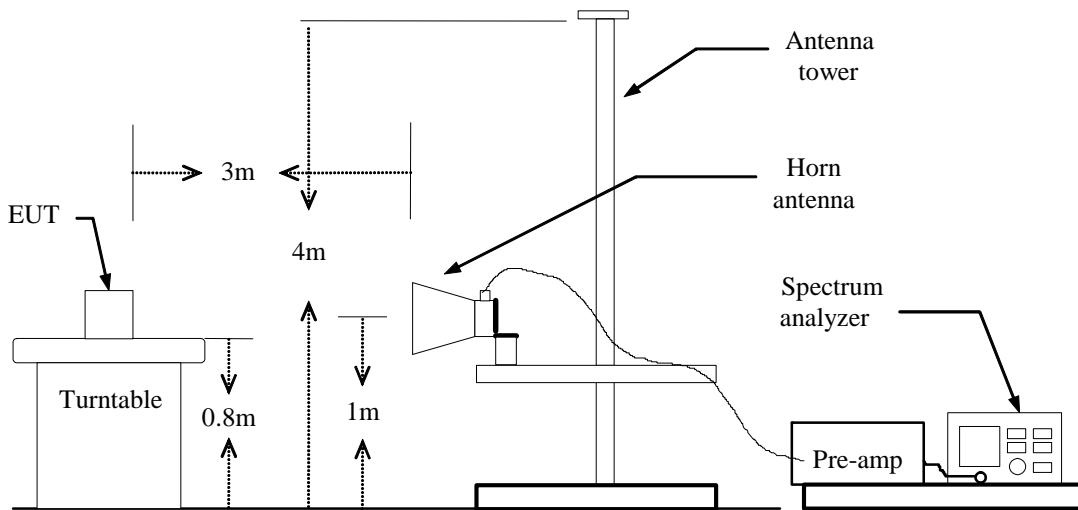

#### For Conducted

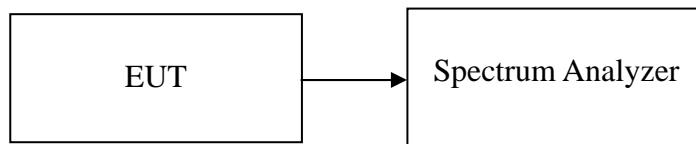



## **TEST PROCEDURE**

### **For Radiated**

1. The EUT is placed on a turntable, which is 0.8m above the ground plane.
2. The turntable shall be rotated for 360 degrees to determine the position of maximum emission level.
3. EUT is set 3m away from the receiving antenna, which is varied from 1m to 4m to find out the highest emission.
4. Set the spectrum analyzer in the following setting in order to capture the lower and upper band-edges of the emission:
  - (a) PEAK: RBW=1MHz,VBW=3MHz / Sweep=AUTO
  - (b) AVERAGE: RBW=1MHz / VBW=300Hz / Sweep=AUTO
5. Repeat the procedures until all the PEAK and AVERAGE versus POLARIZATION are measured.

### **For Conducted**

Conducted RF measurements of the transmitter output were made to confirm that the EUT antenna port conducted emissions meet the specified limit and to identify any spurious signals that require further investigation or measurements on the radiated emissions site.

The transmitter output is connected to the spectrum analyzer. The resolution bandwidth is set to 100 kHz. The video bandwidth is set to 300 kHz.

## **TEST RESULTS**

Refer to attach spectrum analyzer data chart.



**802.11a Mode**

1. Operating Frequency: 5725-5875MHz
2. CH Low: 5745MHz, CH High: 5825MHz
3. 6dB bandwidth: CH Low: 16.58MHz, CH High: 16.58MHz

Because the mentioned conditions, the test is not applicable.



### Band Edges (IEEE 802.11b mode / CH Low)

Detector mode: Peak

Polarity: Vertical

Agilent

R T

Mkr1 2.385 60 GHz  
56.32 dB $\mu$ V/m

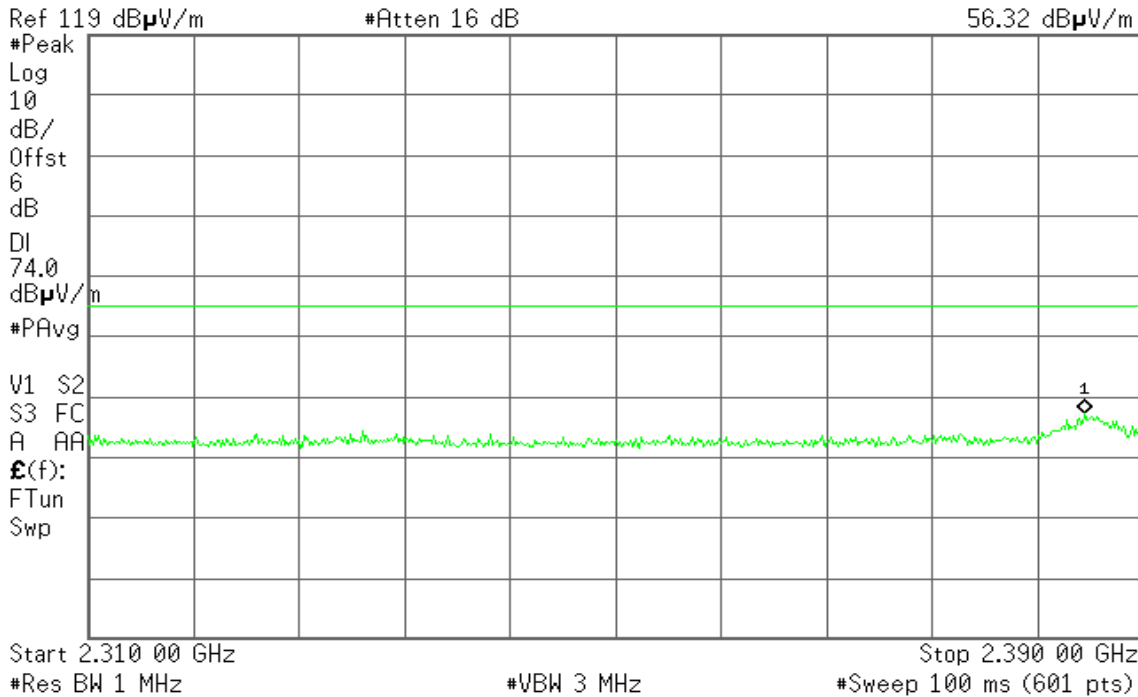

Detector mode: Average

Polarity: Vertical

Agilent

R T

Mkr1 2.386 40 GHz  
48.38 dB $\mu$ V/m





Detector mode: Peak

Polarity: Horizontal

Agilent

R T

Mkr1 2.386 00 GHz  
57.84 dB $\mu$ V/m

Ref 119 dB $\mu$ V/m

#Atten 16 dB

#Peak

Log

10

dB/

Offst

6

dB

DI

74.0

dB $\mu$ V/m

#PAvg

V1 S2

S3 FC

A AA

$\mathcal{E}(f)$ :

FTun

Swp

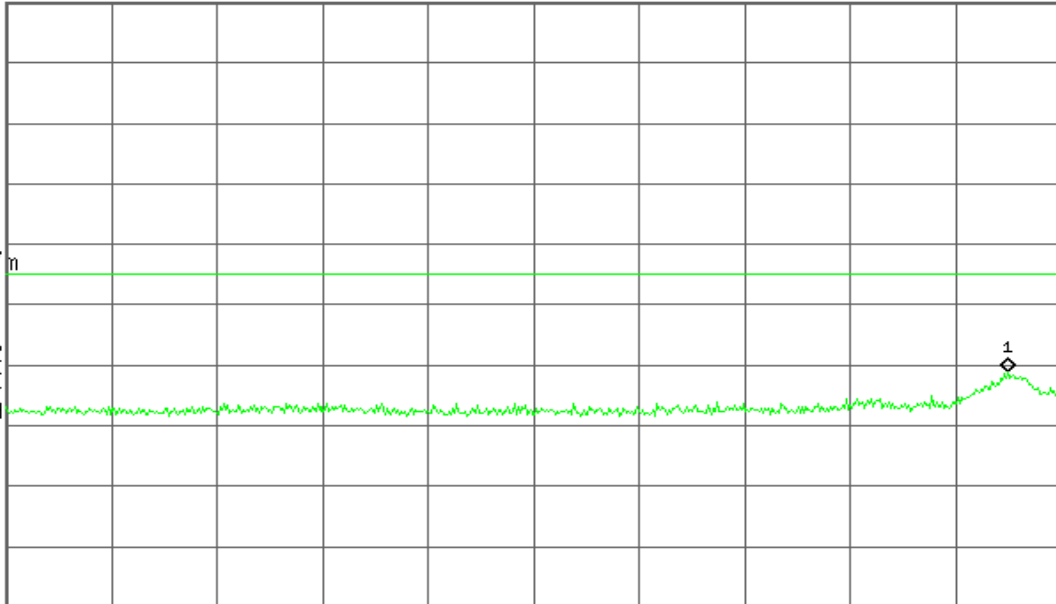

Start 2.310 00 GHz

Stop 2.390 00 GHz

#Res BW 1 MHz

#VBW 3 MHz

#Sweep 100 ms (601 pts)

Detector mode: Average

Polarity: Horizontal

Agilent

R T

Mkr1 2.386 40 GHz  
50.77 dB $\mu$ V/m

Ref 119 dB $\mu$ V/m

#Atten 16 dB

#Peak

Log

10

dB/

Offst

6

dB

DI

54.0

dB $\mu$ V/m

#PAvg

M1 S2

S3 FC

A AA

$\mathcal{E}(f)$ :

FTun

Swp

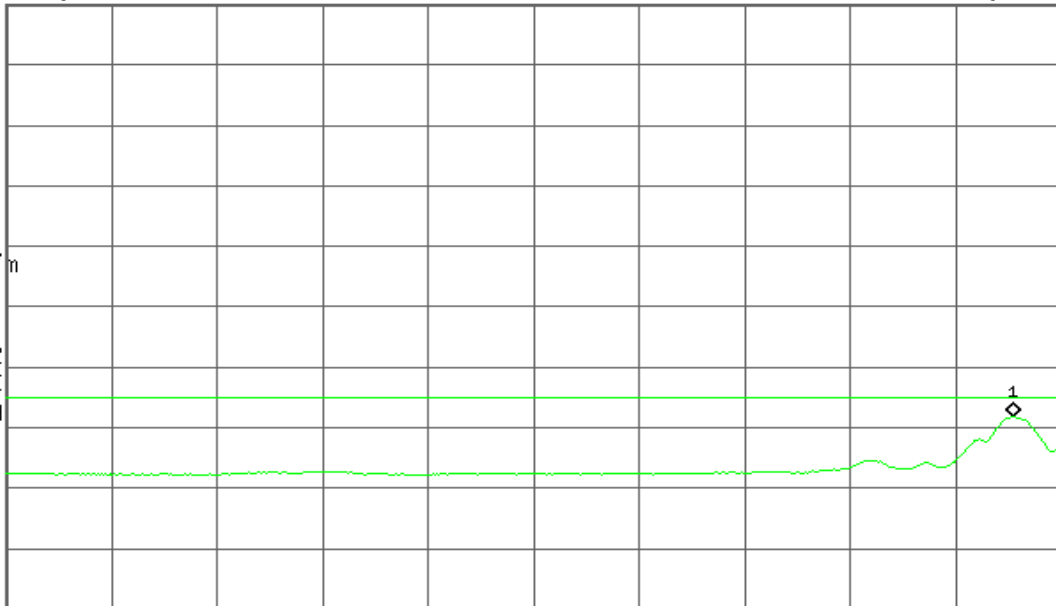

Start 2.310 00 GHz

Stop 2.390 00 GHz

#Res BW 1 MHz

#VBW 300 Hz

Sweep 208 ms (601 pts)



### Band Edges (IEEE 802.11b mode / CH High)

Detector mode: Peak

Polarity: Vertical

Agilent

R T

Mkr1 2.487 79 GHz  
56.39 dB $\mu$ V/m

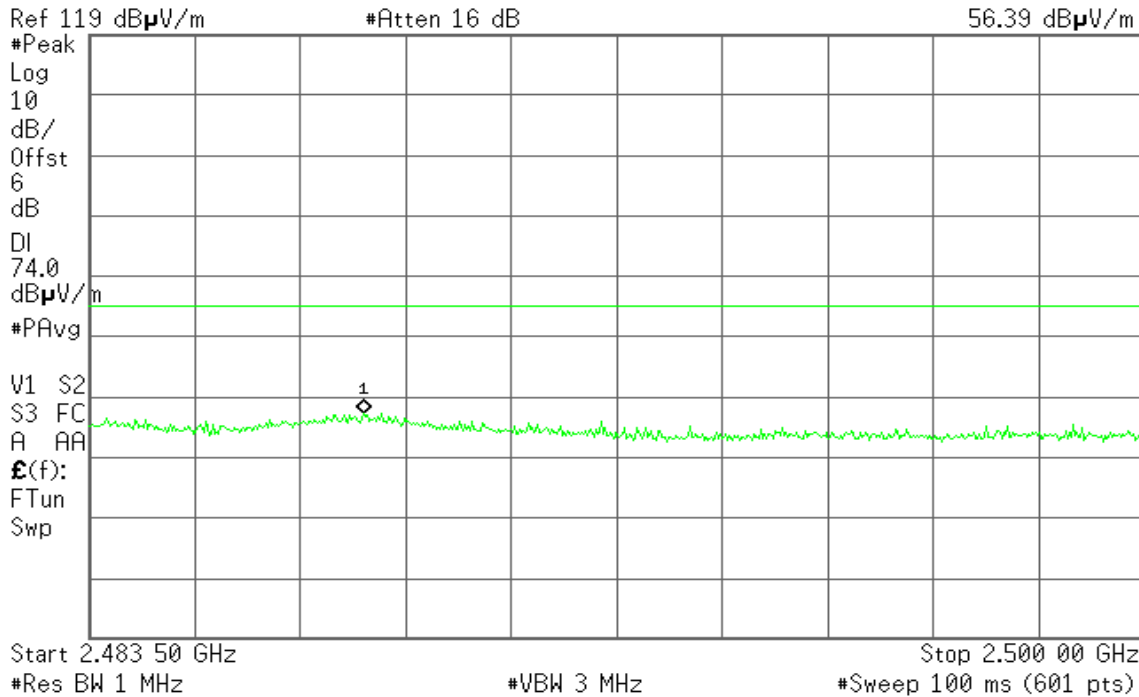

Detector mode: Average

Polarity: Vertical

Agilent

R T

Mkr1 2.487 49 GHz  
48.12 dB $\mu$ V/m

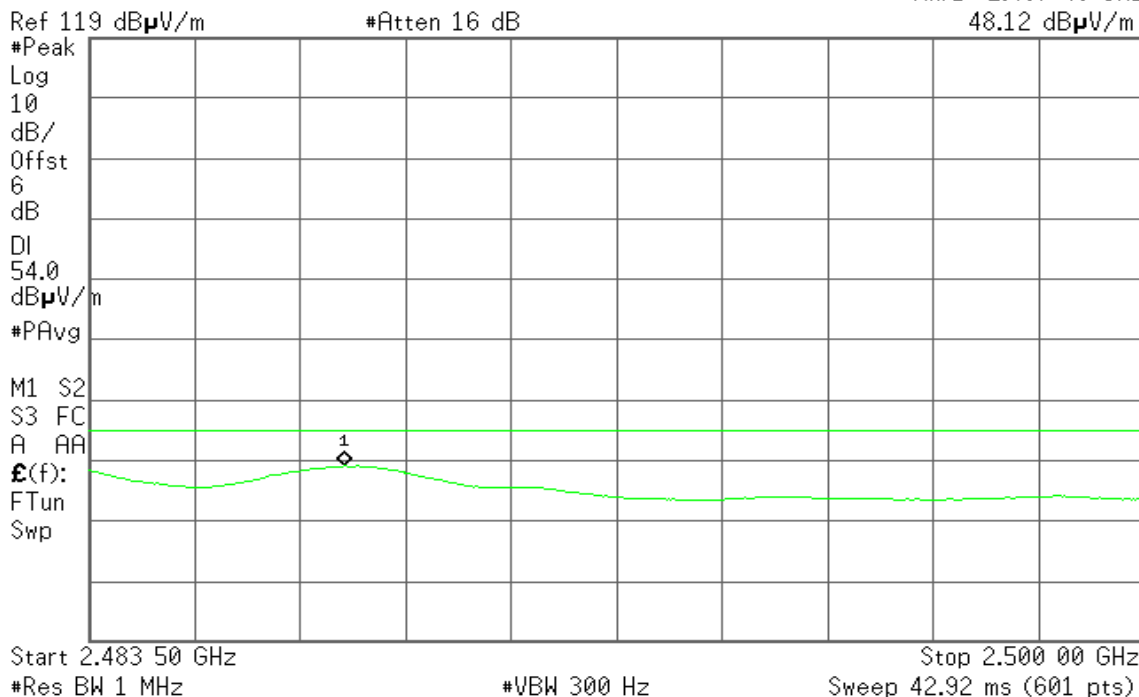



Detector mode: Peak

Polarity: Horizontal

Agilent

R T

Mkr1 2.487 76 GHz  
58.80 dBµV/m

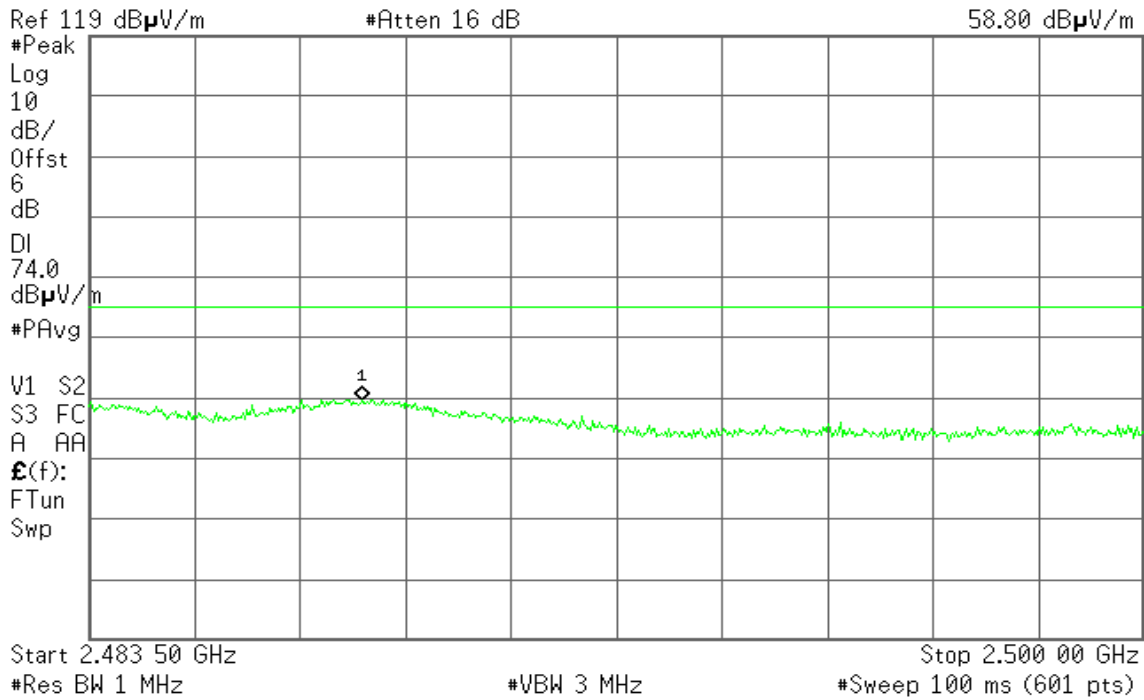

Detector mode: Average

Polarity: Horizontal

Agilent

R T

Mkr1 2.487 62 GHz  
51.67 dBµV/m

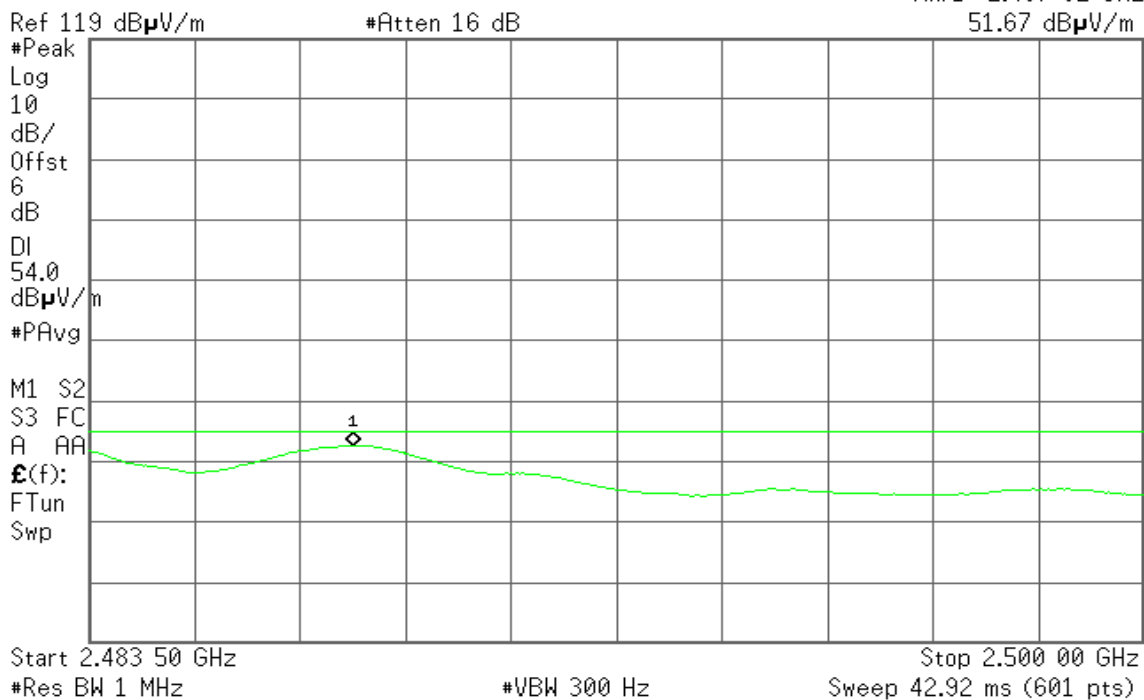



Band Edges (IEEE 802.11g mode / CH Low)

Detector mode: Peak

Polarity: Vertical

Agilent

R T

Mkr1 2.390 00 GHz

65.54 dBµV/m

Ref 119 dBµV/m

#Atten 16 dB

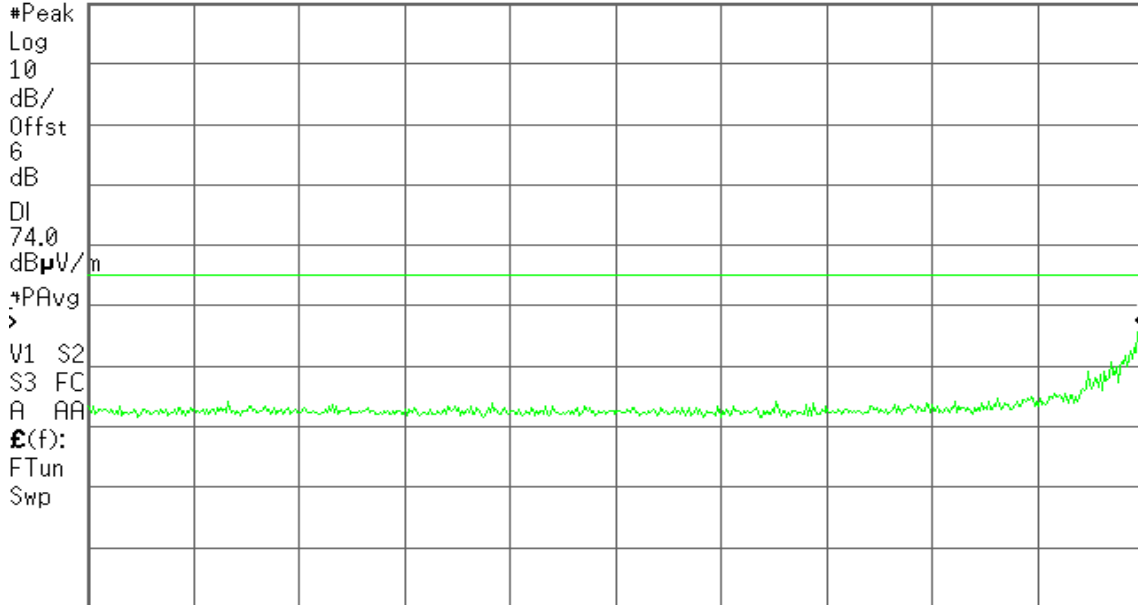

Start 2.310 00 GHz

Stop 2.390 00 GHz

#Res BW 1 MHz

#VBW 3 MHz

#Sweep 100 ms (601 pts)

Detector mode: Average

Polarity: Vertical

Agilent

R T

Mkr1 2.390 00 GHz

47.81 dBµV/m

Ref 119 dBµV/m

#Atten 16 dB



Start 2.310 00 GHz

Stop 2.390 00 GHz

#Res BW 1 MHz

#VBW 510 Hz

Sweep 122.3 ms (601 pts)





Detector mode: Peak

Polarity: Horizontal

Agilent

R T

Mkr1 2.390 00 GHz  
69.27 dBµV/m

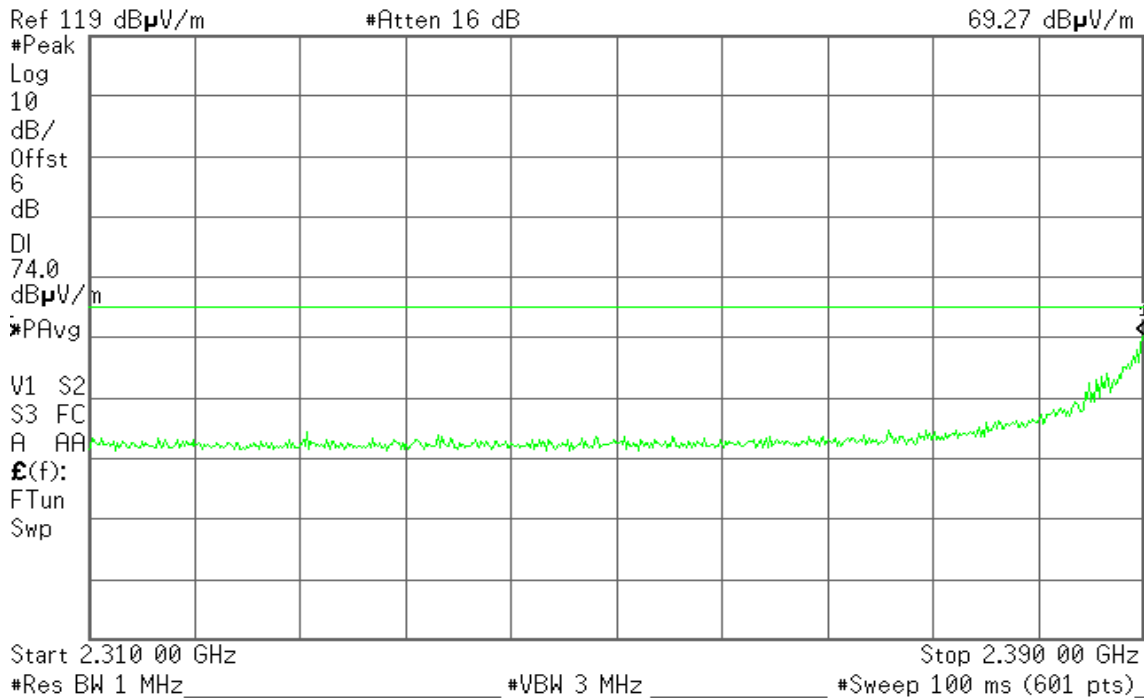

Detector mode: Average

Polarity: Horizontal

Agilent

R T

Mkr1 2.390 00 GHz  
51.16 dBµV/m

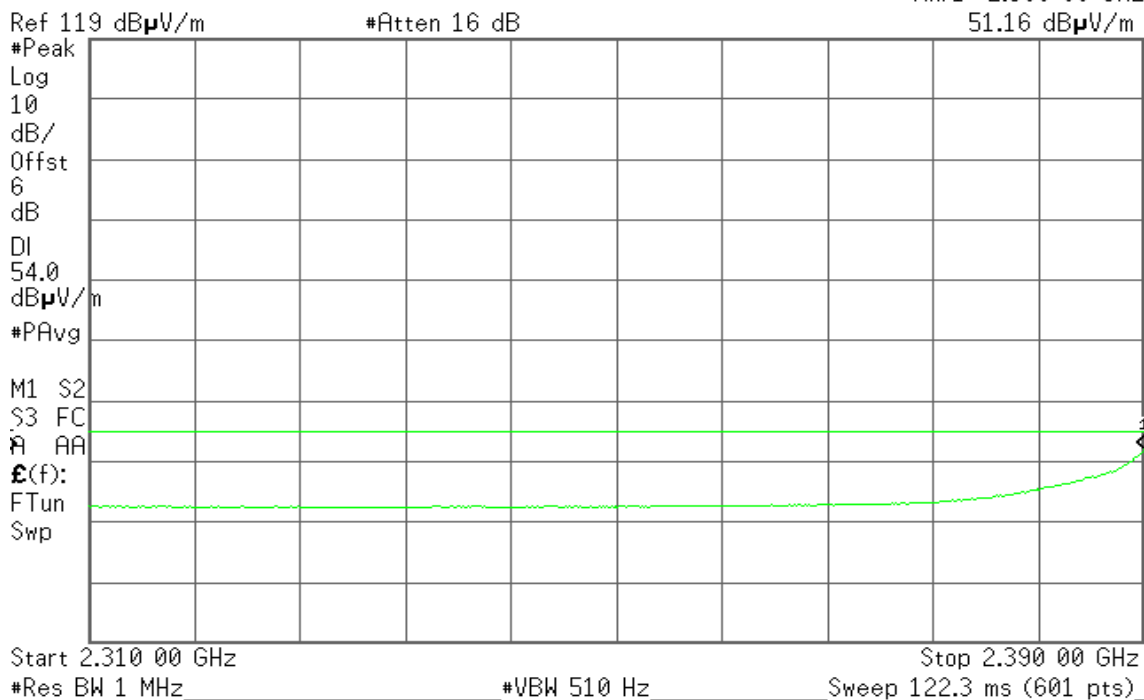



### Band Edges (IEEE 802.11g mode / CH High)

Detector mode: Peak

Polarity: Vertical

Agilent

R T

Mkr1 2.483 58 GHz  
60.59 dBμV/m

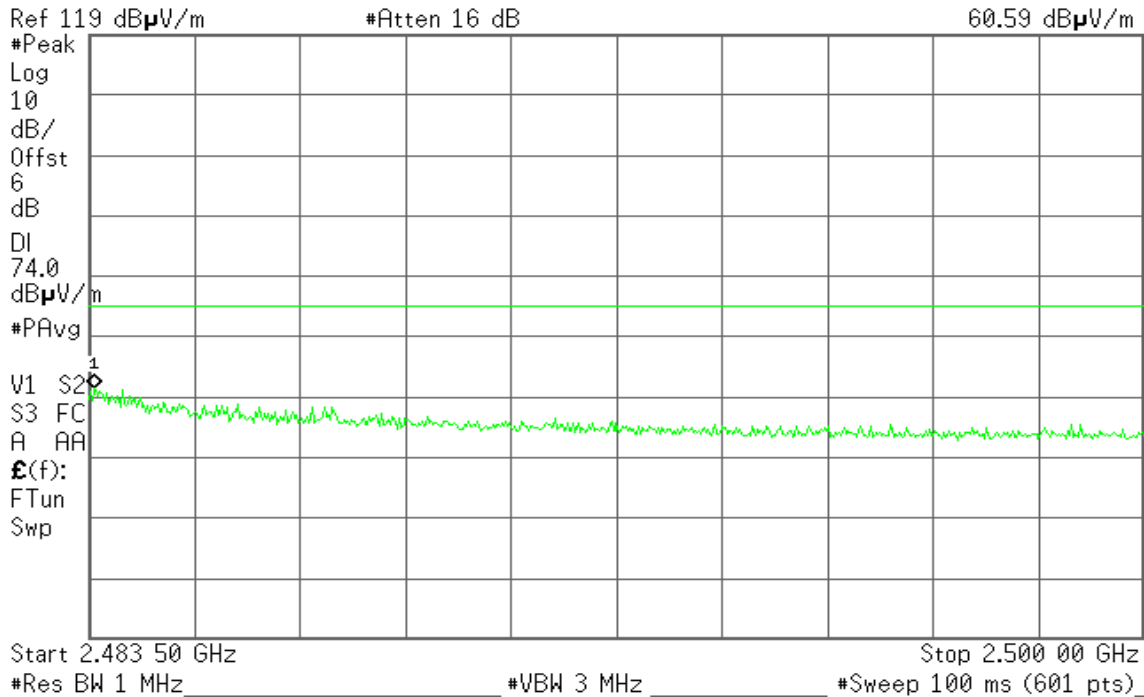

Detector mode: Average

Polarity: Vertical

Agilent

R T

Mkr1 2.483 50 GHz  
47.06 dBμV/m

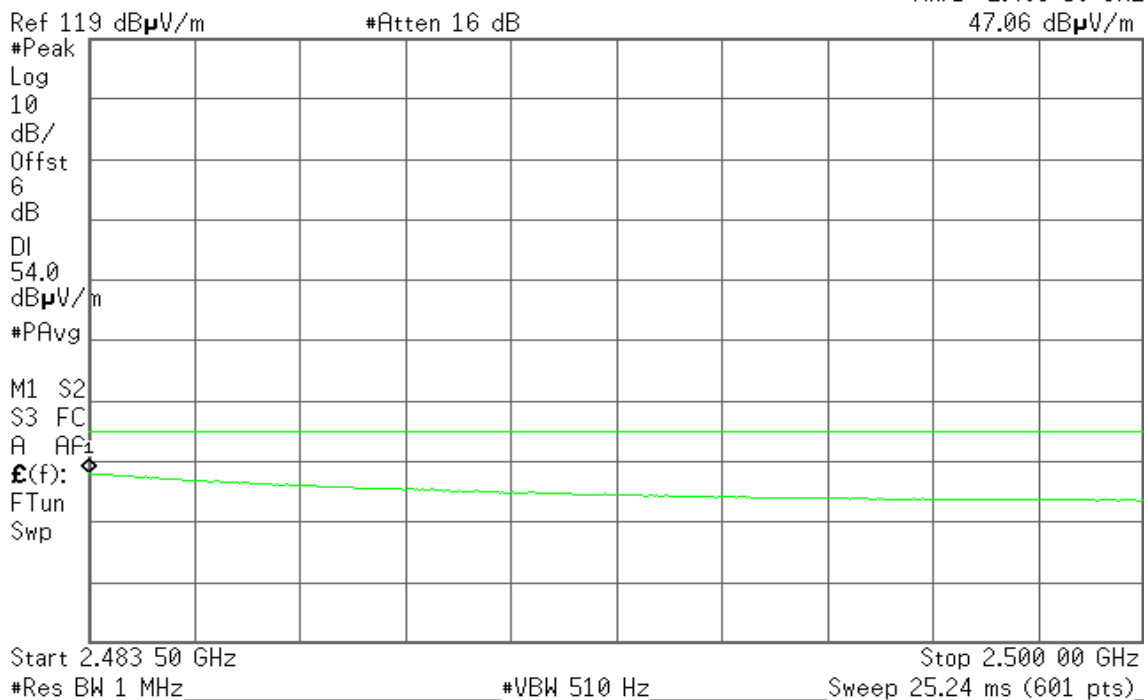



Detector mode: Peak

Polarity: Horizontal

Agilent

R T

Mkr1 2.483 64 GHz  
64.54 dBμV/m

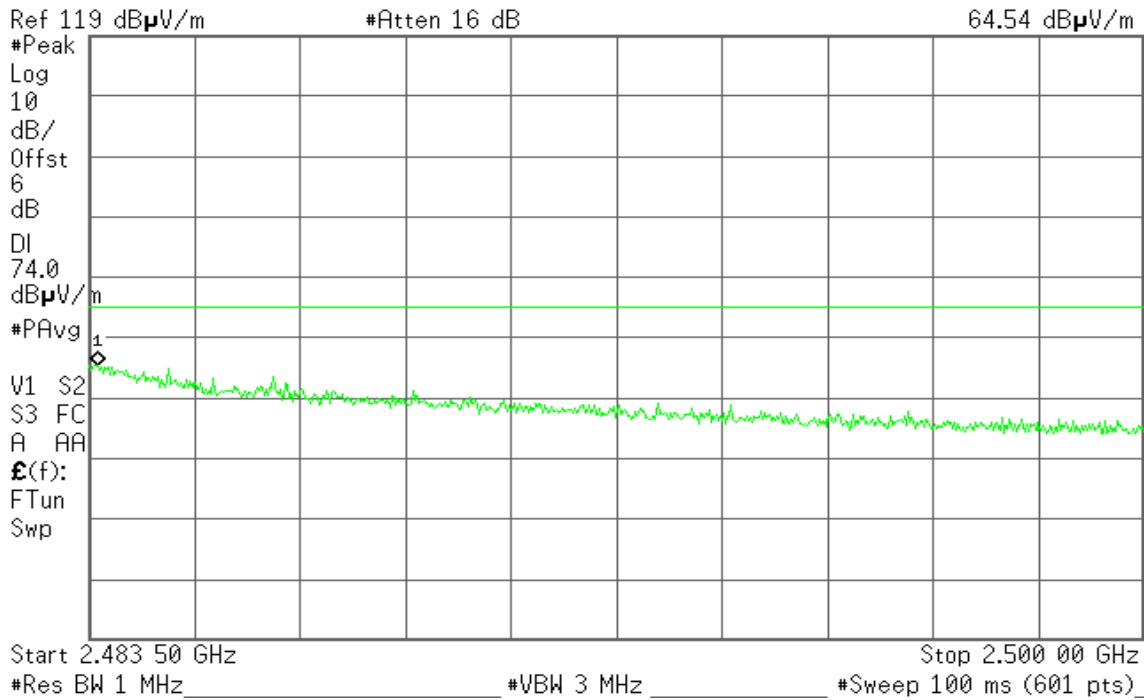

Detector mode: Average

Polarity: Horizontal

Agilent

R T

Mkr1 2.483 58 GHz  
50.84 dBμV/m

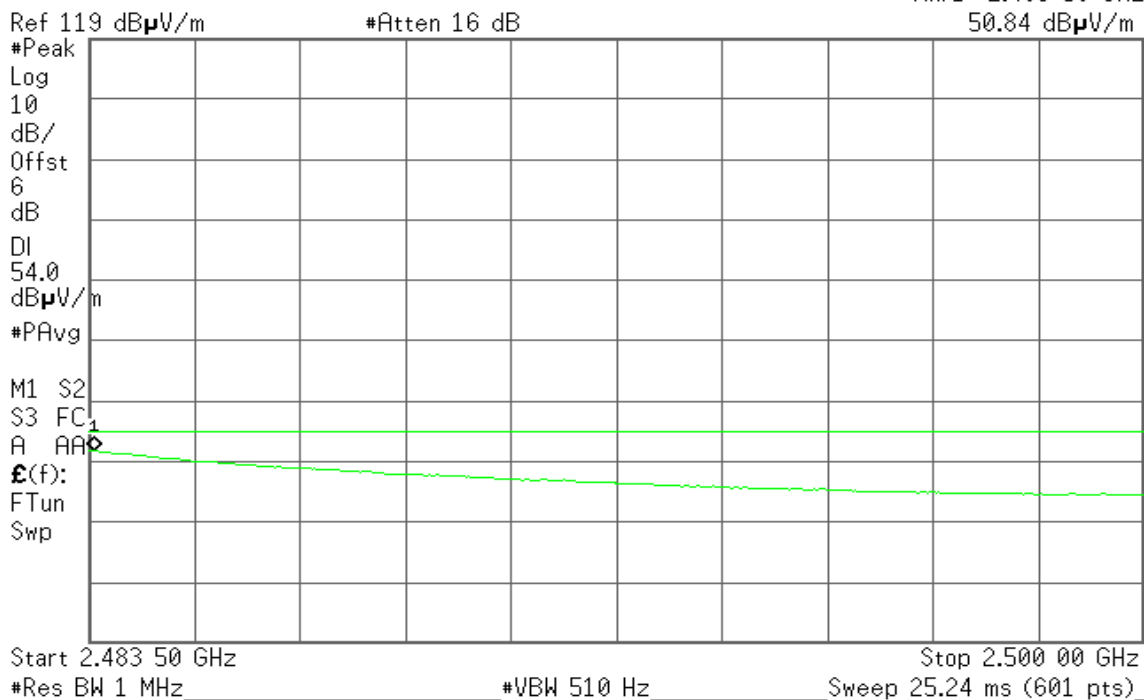



### Band Edges (IEEE 802.11n HT 20 MHz mode / CH Low)

Detector mode: Peak

Polarity: Vertical

Agilent

R T

Mkr1 2.390 00 GHz  
67.25 dB $\mu$ V/m

Ref 119 dB $\mu$ V/m

#Atten 16 dB

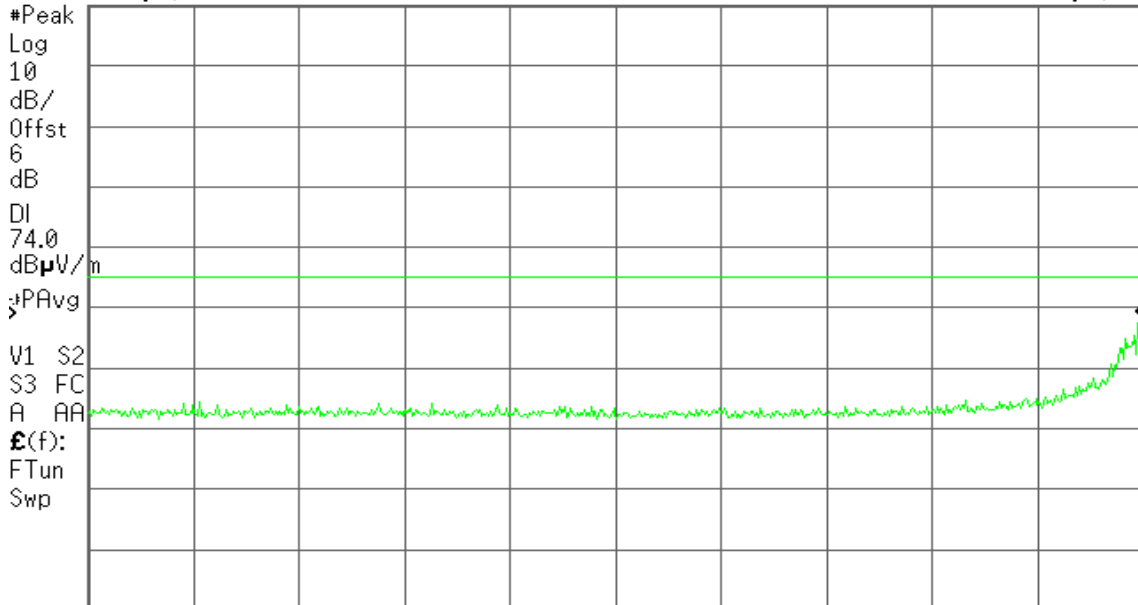

Start 2.310 00 GHz

Stop 2.390 00 GHz

#Res BW 1 MHz

#VBW 3 MHz

#Sweep 100 ms (601 pts)

Detector mode: Average

Polarity: Vertical

Agilent

R T

Mkr1 2.390 00 GHz  
48.37 dB $\mu$ V/m

Ref 119 dB $\mu$ V/m

#Atten 16 dB

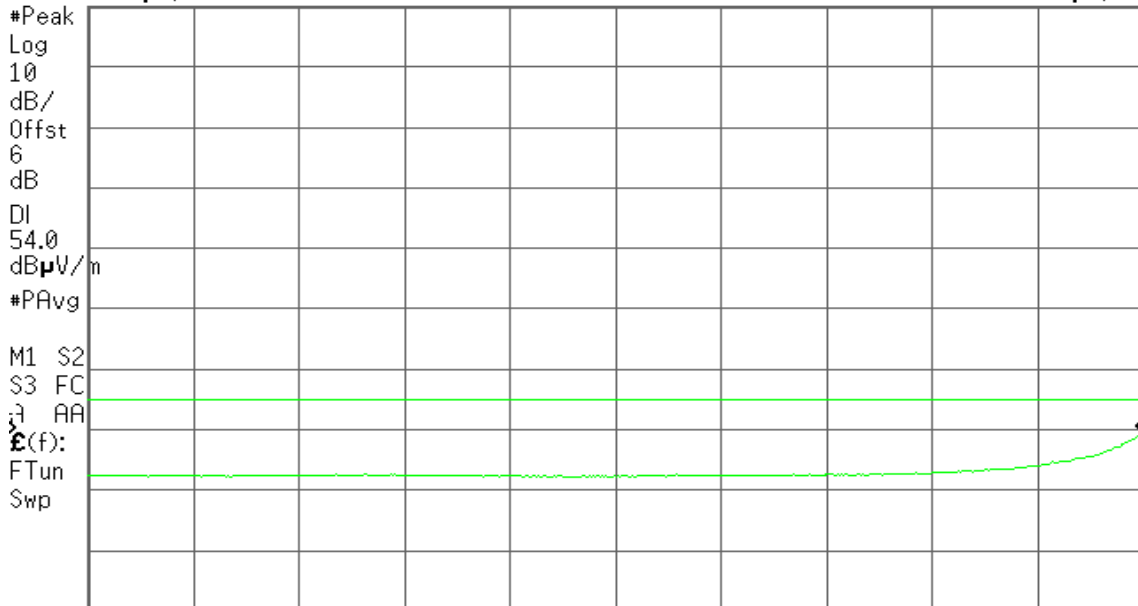

Start 2.310 00 GHz

Stop 2.390 00 GHz

#Res BW 1 MHz

#VBW 560 Hz

Sweep 111.4 ms (601 pts)



Detector mode: Peak

Polarity: Horizontal

Agilent

R T

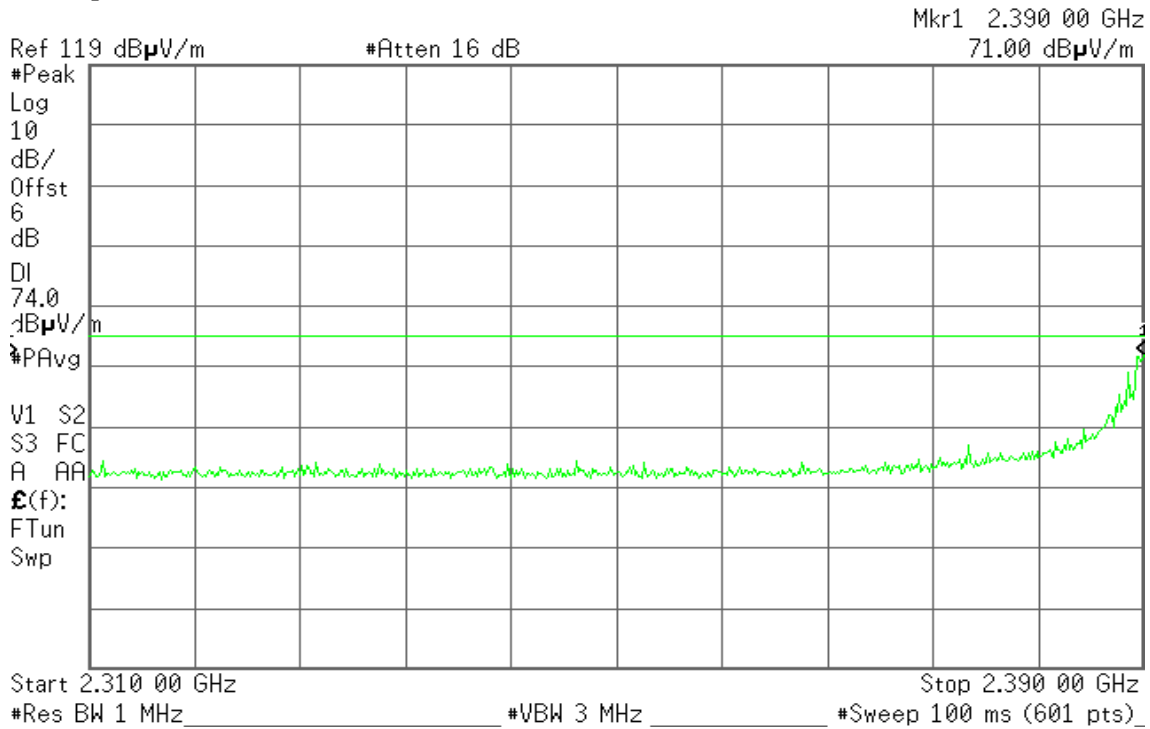

Detector mode: Average

Polarity: Horizontal

Agilent

R T

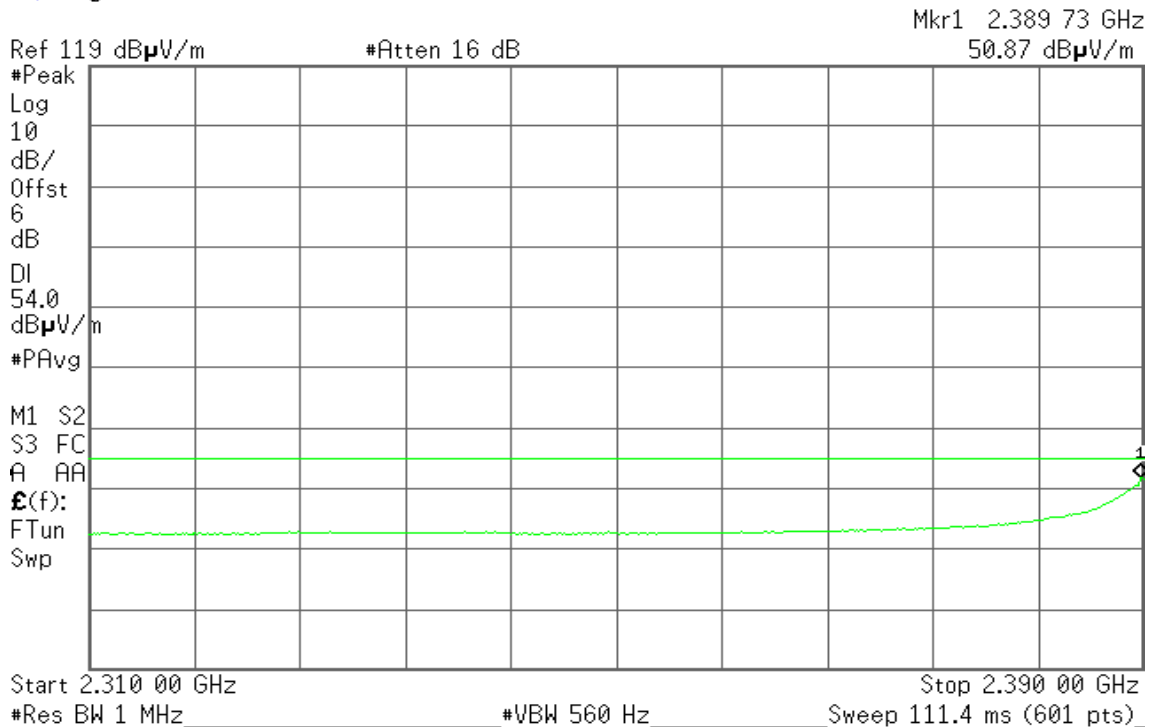



### Band Edges (IEEE 802.11n HT 20 MHz mode / CH High)

Detector mode: Peak

Polarity: Vertical

Agilent

R T

Mkr1 2.484 44 GHz  
59.97 dB $\mu$ V/m

Ref 119 dB $\mu$ V/m

#Atten 16 dB

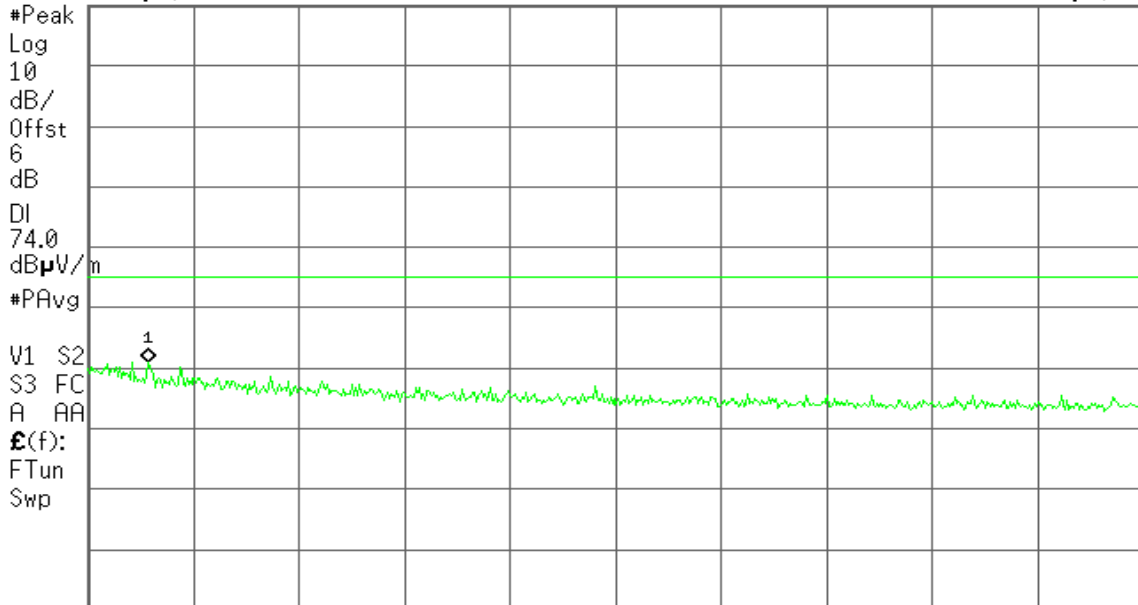

Start 2.483 50 GHz

Stop 2.500 00 GHz

#Res BW 1 MHz

#VBW 3 MHz

#Sweep 100 ms (601 pts)

Detector mode: Average

Polarity: Vertical

Agilent

R T

Mkr1 2.483 56 GHz  
46.88 dB $\mu$ V/m

Ref 119 dB $\mu$ V/m

#Atten 16 dB

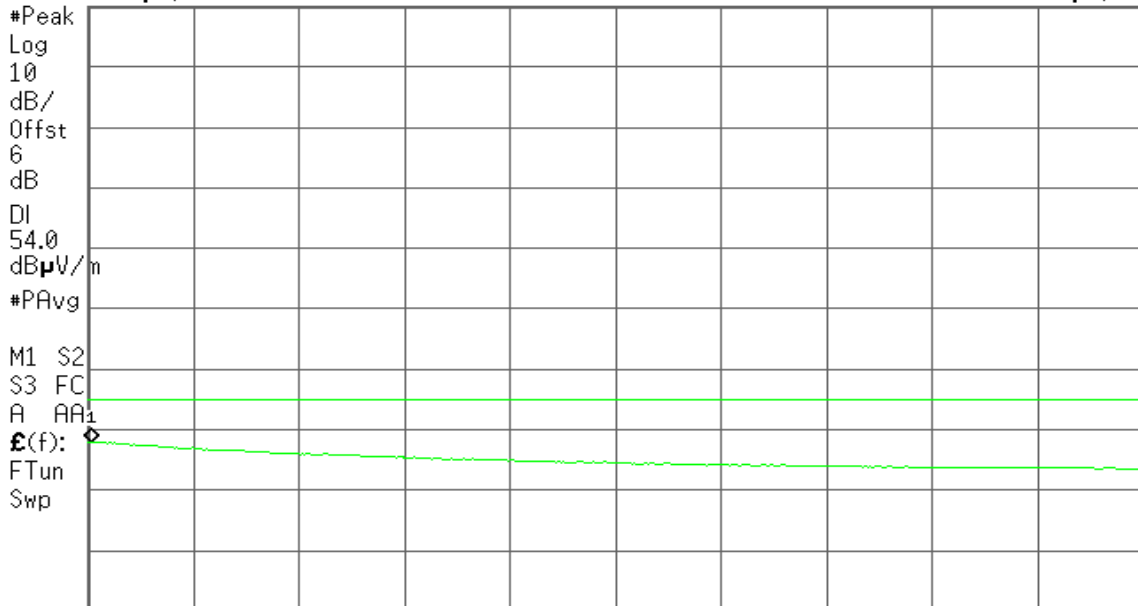

Start 2.483 50 GHz

Stop 2.500 00 GHz

#Res BW 1 MHz

#VBW 560 Hz

Sweep 23 ms (601 pts)



Detector mode: Peak

Polarity: Horizontal

Agilent

R T

Mkr1 2.483 80 GHz  
68.94 dBµV/m

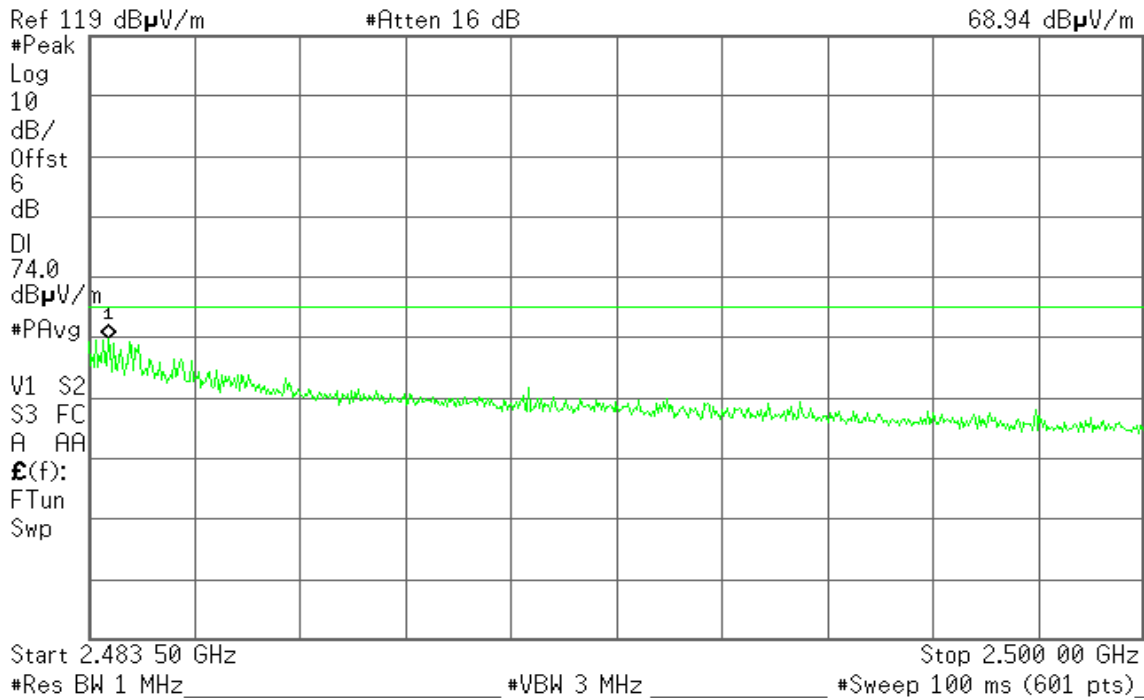

Detector mode: Average

Polarity: Horizontal

Agilent

R T

Mkr1 2.483 50 GHz  
51.50 dBµV/m

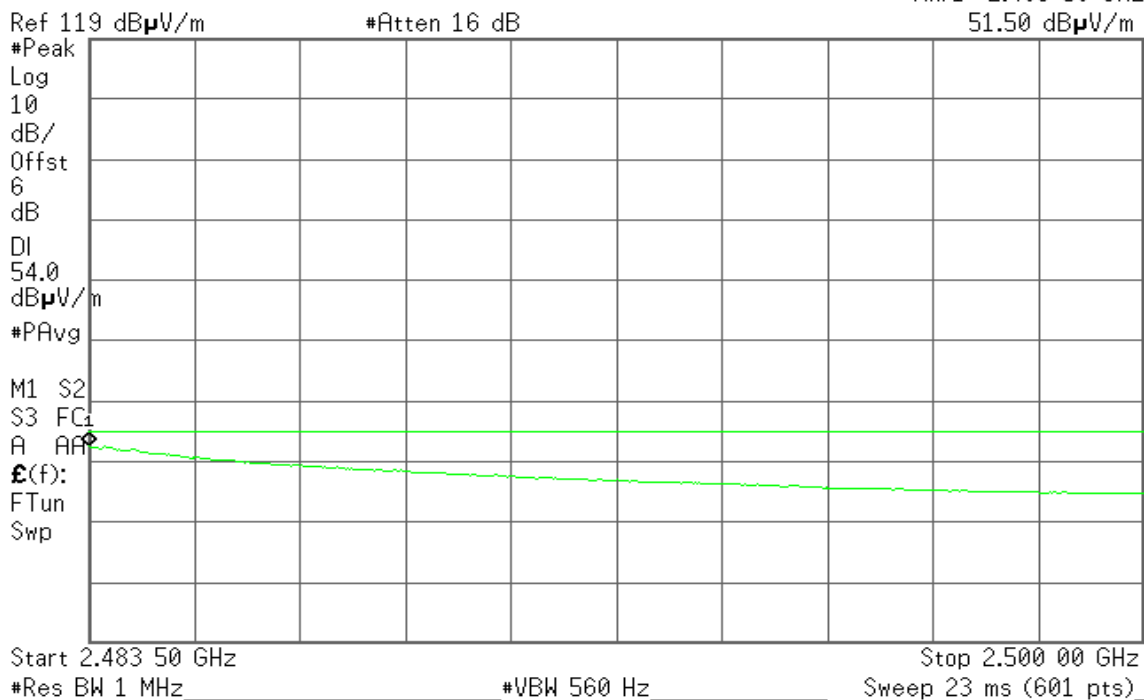



### Band Edges (IEEE 802.11n HT 40 MHz mode / CH Low)

Detector mode: Peak

Polarity: Vertical

Agilent

R T

Mkr1 2.389 60 GHz  
63.63 dB $\mu$ V/m

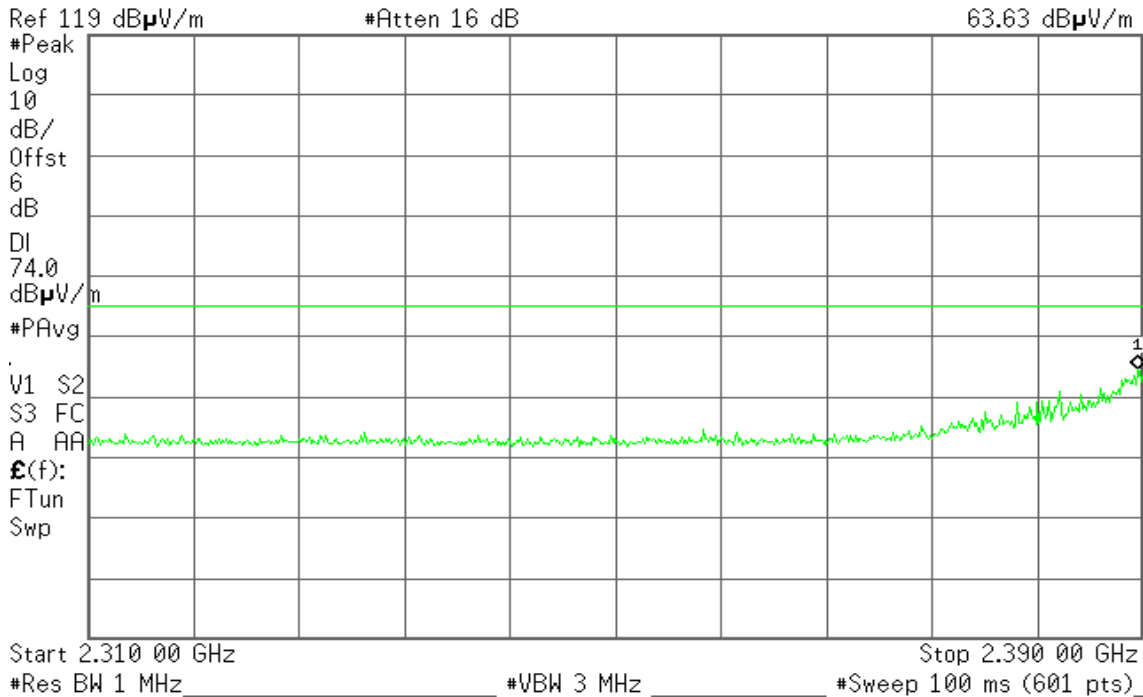

Detector mode: Average

Polarity: Vertical

Agilent

R T

Mkr1 2.389 87 GHz  
49.03 dB $\mu$ V/m

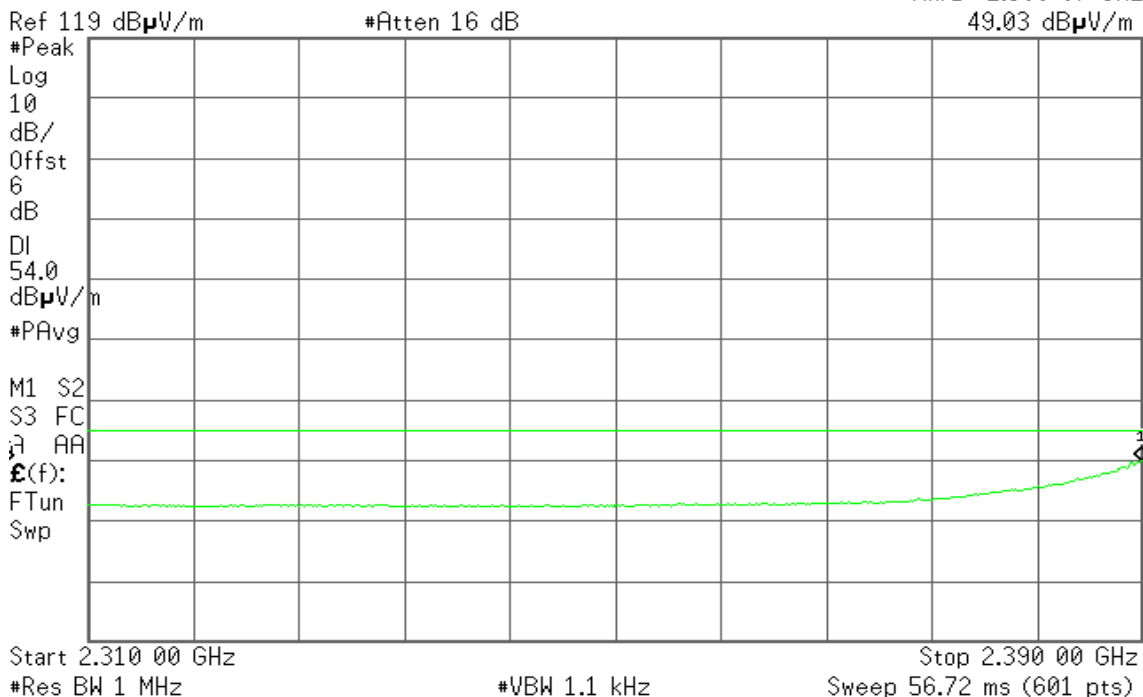





Detector mode: Peak

Polarity: Horizontal

Agilent

R T

Mkr1 2.390 00 GHz  
66.72 dBμV/m

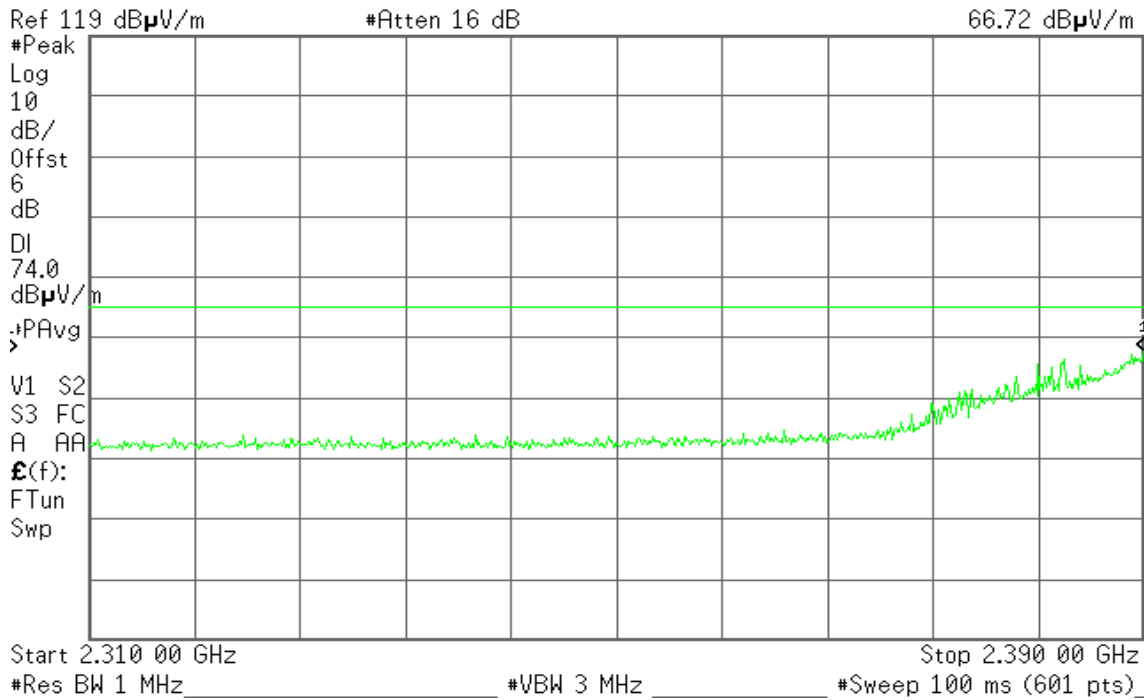

Detector mode: Average

Polarity: Horizontal

Agilent

R T

Mkr1 2.390 00 GHz  
51.76 dBμV/m

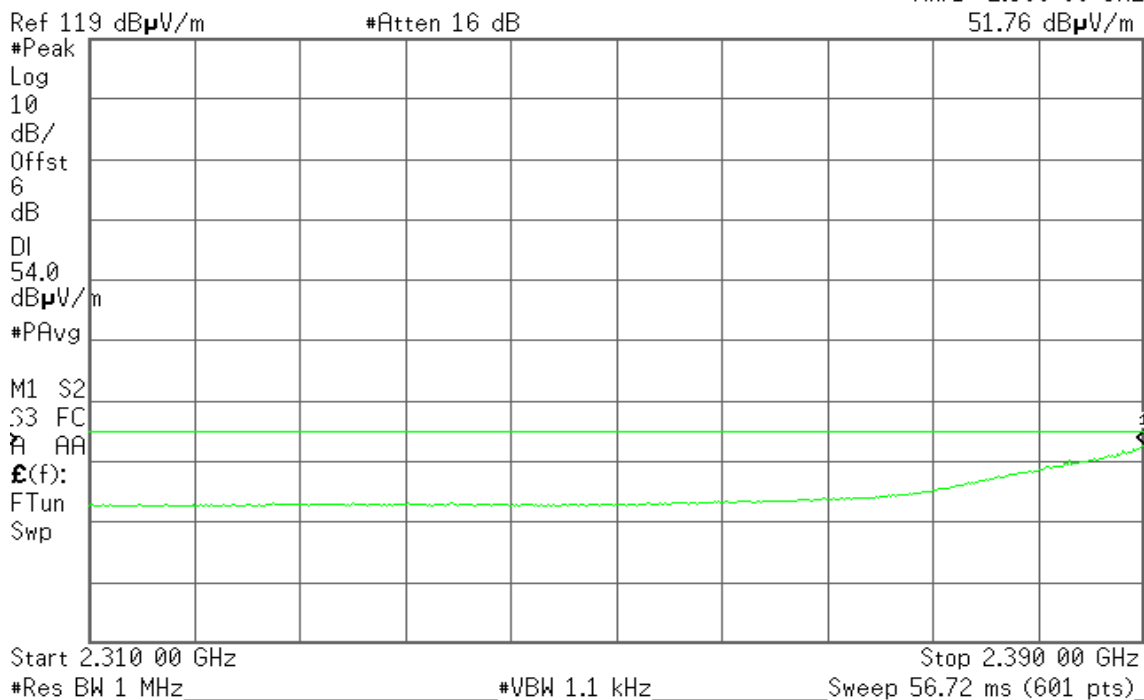



### Band Edges (IEEE 802.11n HT 40 MHz mode / CH High)

Detector mode: Peak

Polarity: Vertical

Agilent

R T

Mkr1 2.483 50 GHz  
63.08 dB $\mu$ V/m

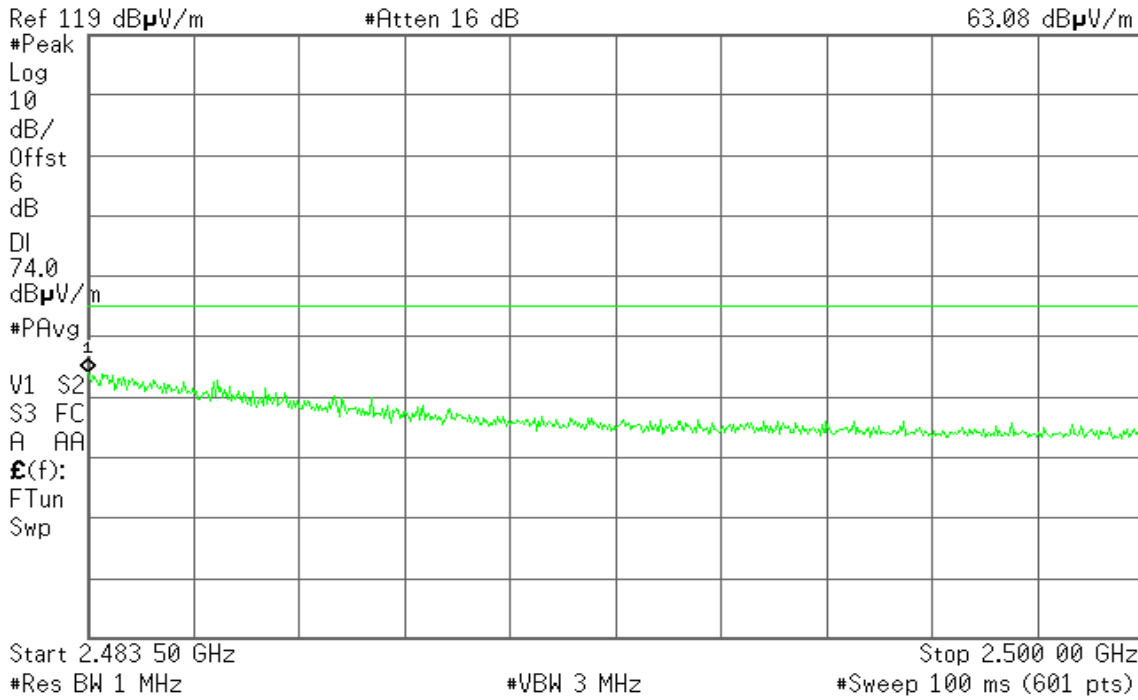

Detector mode: Average

Polarity: Vertical

Agilent

R T

Mkr1 2.483 58 GHz  
48.40 dB $\mu$ V/m

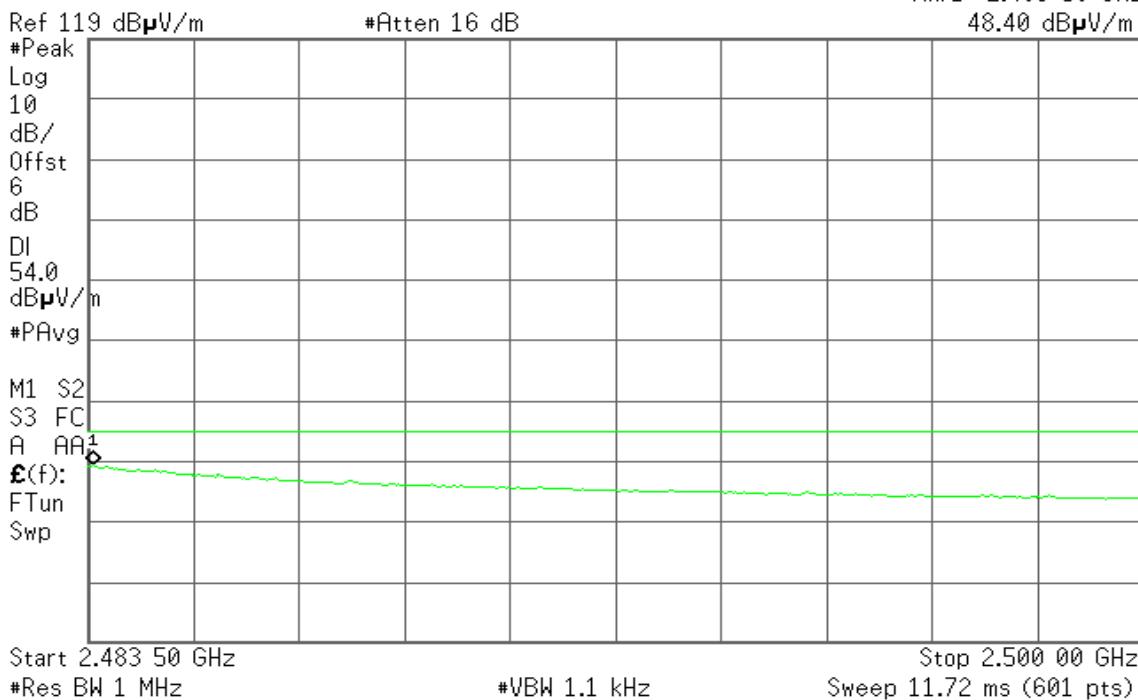



Detector mode: Peak

Polarity: Horizontal

Agilent

R T

Mkr1 2.483 94 GHz  
67.24 dBµV/m

Ref 119 dBµV/m

#Atten 16 dB

#Peak

Log

10

dB/

Offst

6

dB

DI

74.0

dBµV/m

#PAvg

V1 S2

S3 FC

A AA

£(f):

FTun

Swp

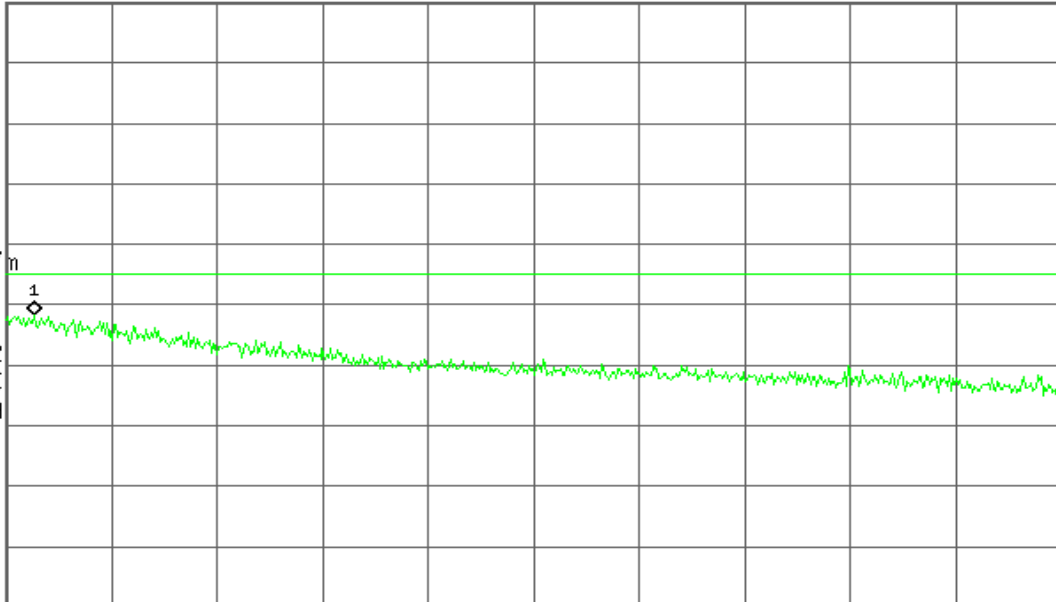

Start 2.483 50 GHz

Stop 2.500 00 GHz

#Res BW 1 MHz

#VBW 3 MHz

#Sweep 100 ms (601 pts)

Detector mode: Average

Polarity: Horizontal

Agilent

R T

Mkr1 2.483 50 GHz  
51.85 dBµV/m

Ref 119 dBµV/m

#Atten 16 dB

#Peak

Log

10

dB/

Offst

6

dB

DI

54.0

dBµV/m

#PAvg

M1 S2

S3 FC

A AA

£(f):

FTun

Swp

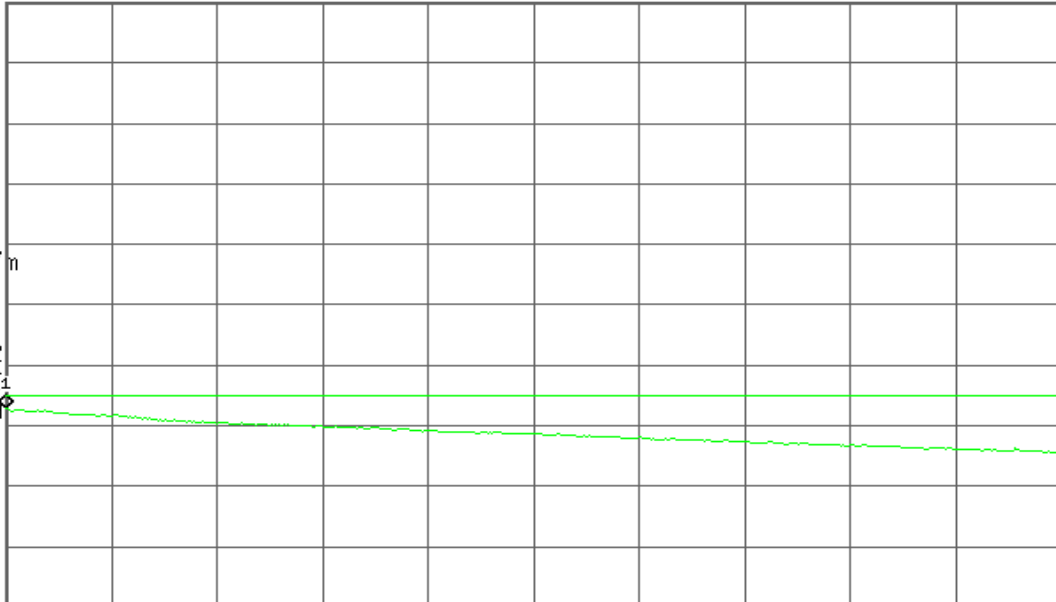

Start 2.483 50 GHz

Stop 2.500 00 GHz

#Res BW 1 MHz

#VBW 1.1 kHz

Sweep 11.72 ms (601 pts)



**Test Plot**

**Conducted Band Edges (IEEE 802.11b mode / CH Low)**

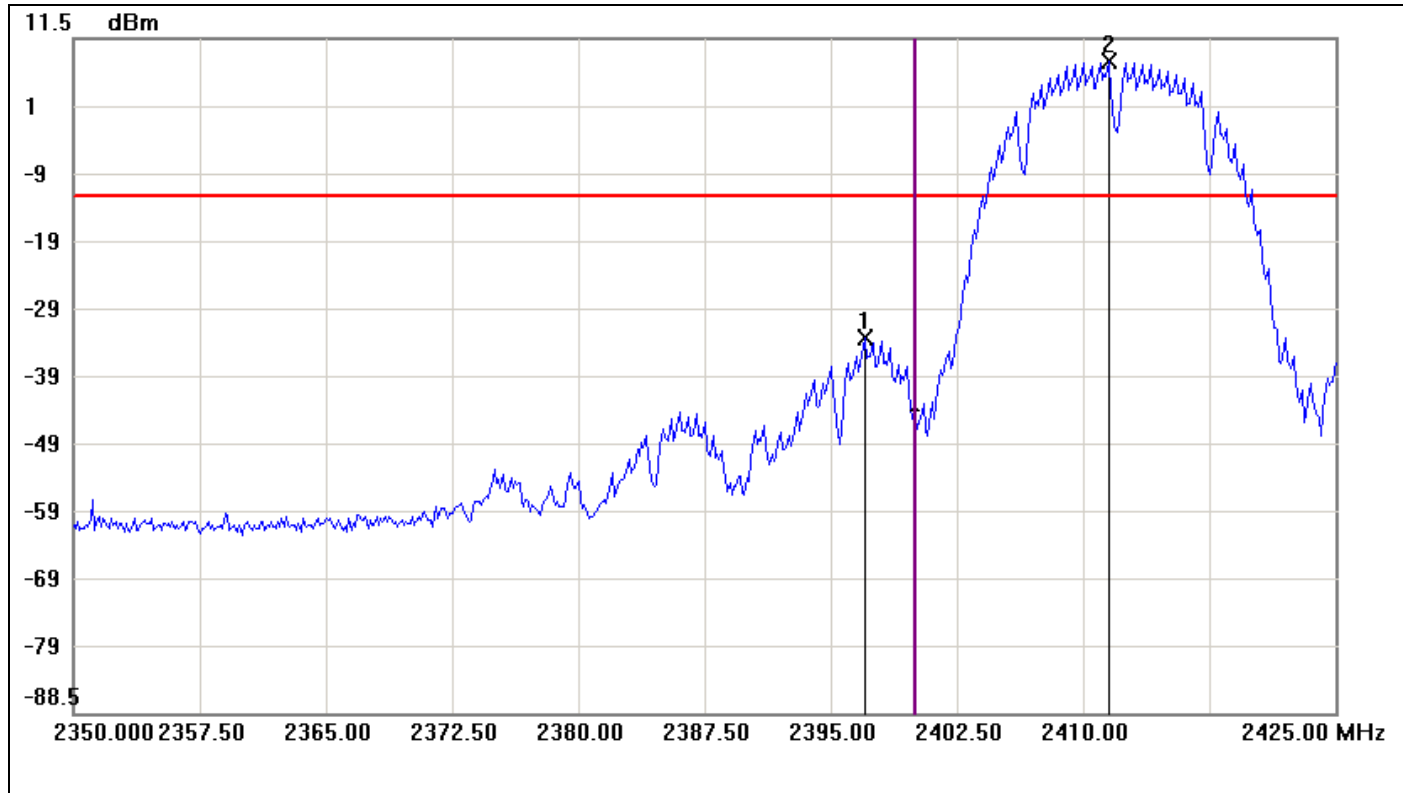

| No. | Frequency(MHz) | Result(dBm) | Limit(dBm) | Margin(dBm) |
|-----|----------------|-------------|------------|-------------|
| 1   | 2397.0000      | -32.82      | -11.96     | -20.86      |
| 2   | 2411.5000      | 8.04        | -11.96     | 20.00       |



Conducted Band Edges (IEEE 802.11b mode / CH High)

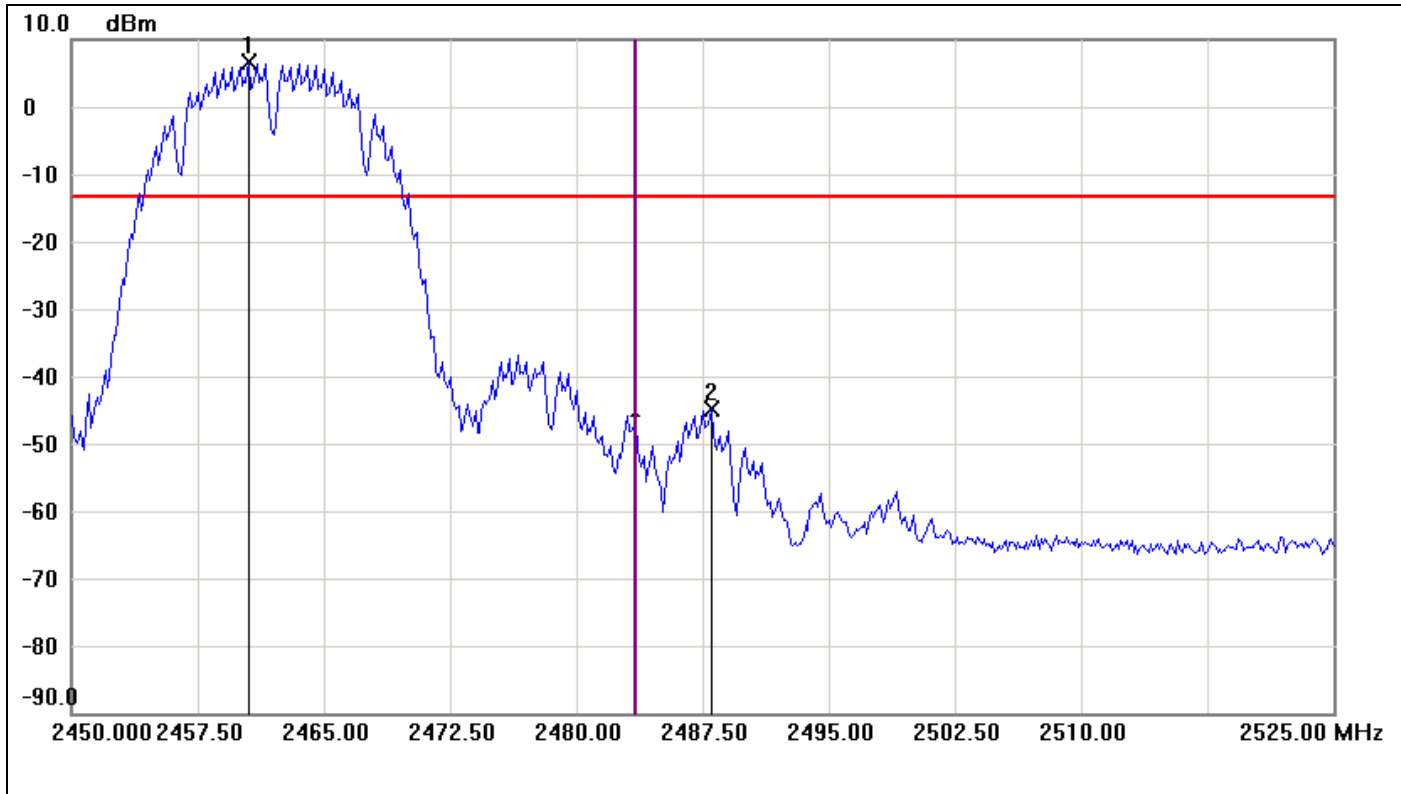

| No. | Frequency(MHz) | Result(dBm) | Limit(dBm) | Margin(dBm) |
|-----|----------------|-------------|------------|-------------|
| 1   | 2460.5000      | 6.73        | -13.27     | 20.00       |
| 2   | 2488.0000      | -44.78      | -13.27     | -31.51      |



### Conducted Band Edges (IEEE 802.11g mode / CH Low)

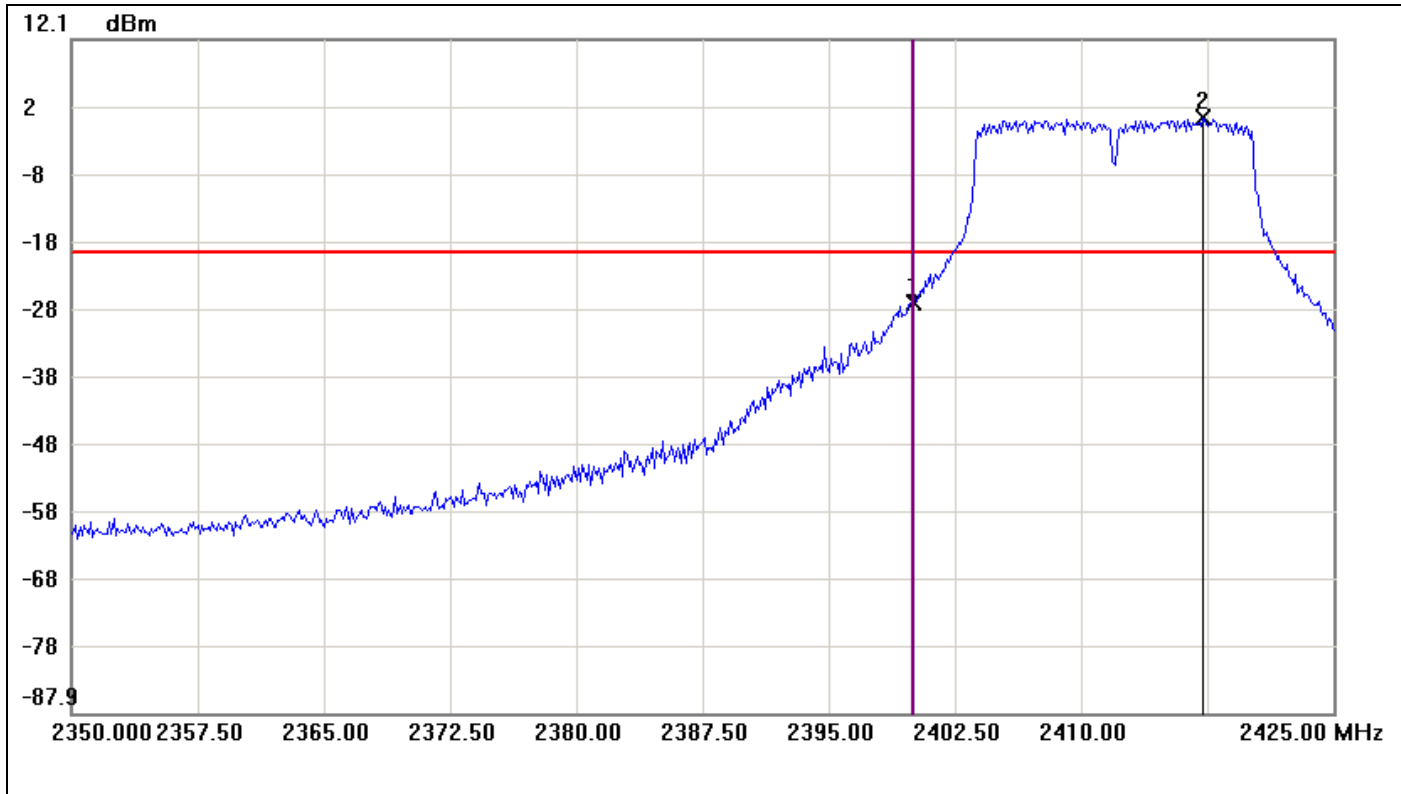

| No. | Frequency(MHz) | Result(dBm) | Limit(dBm) | Margin(dBm) |
|-----|----------------|-------------|------------|-------------|
| 1   | 2400.0000      | -27.05      | -19.58     | -7.47       |
| 2   | 2417.2500      | 0.42        | -19.58     | 20.00       |



Conducted Band Edges (IEEE 802.11g mode / CH High)

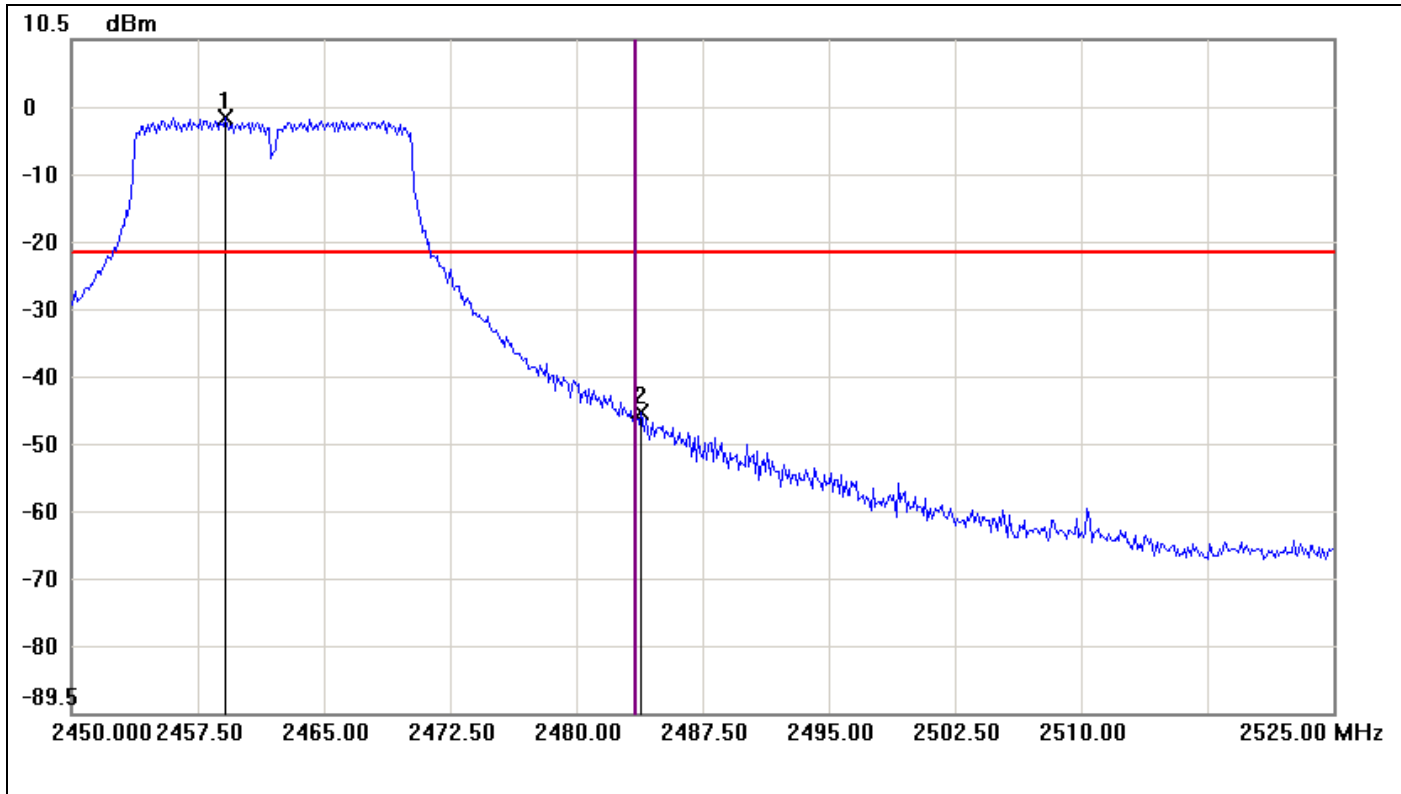

| No. | Frequency(MHz) | Result(dBm) | Limit(dBm) | Margin(dBm) |
|-----|----------------|-------------|------------|-------------|
| 1   | 2459.1250      | -1.13       | -21.13     | 20.00       |
| 2   | 2483.8750      | -44.87      | -21.13     | -23.74      |



Conducted Band Edges (IEEE 802.11n HT 20 MHz mode / CH Low)

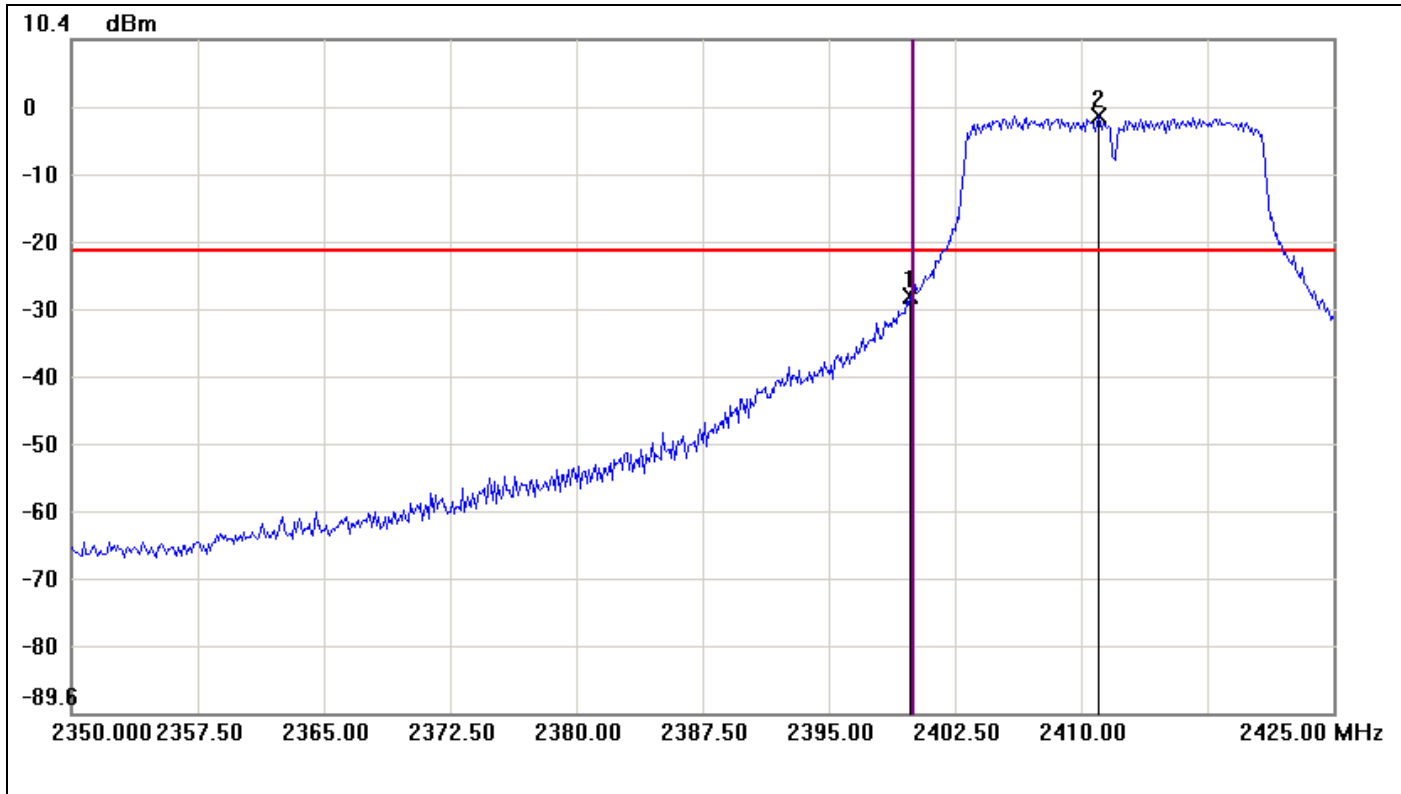

| No. | Frequency(MHz) | Result(dBm) | Limit(dBm) | Margin(dBm) |
|-----|----------------|-------------|------------|-------------|
| 1   | 2399.8750      | -27.80      | -20.94     | -6.86       |
| 2   | 2411.0000      | -0.94       | -20.94     | 20.00       |





Conducted Band Edges (IEEE 802.11n HT 20 MHz mode / CH High)

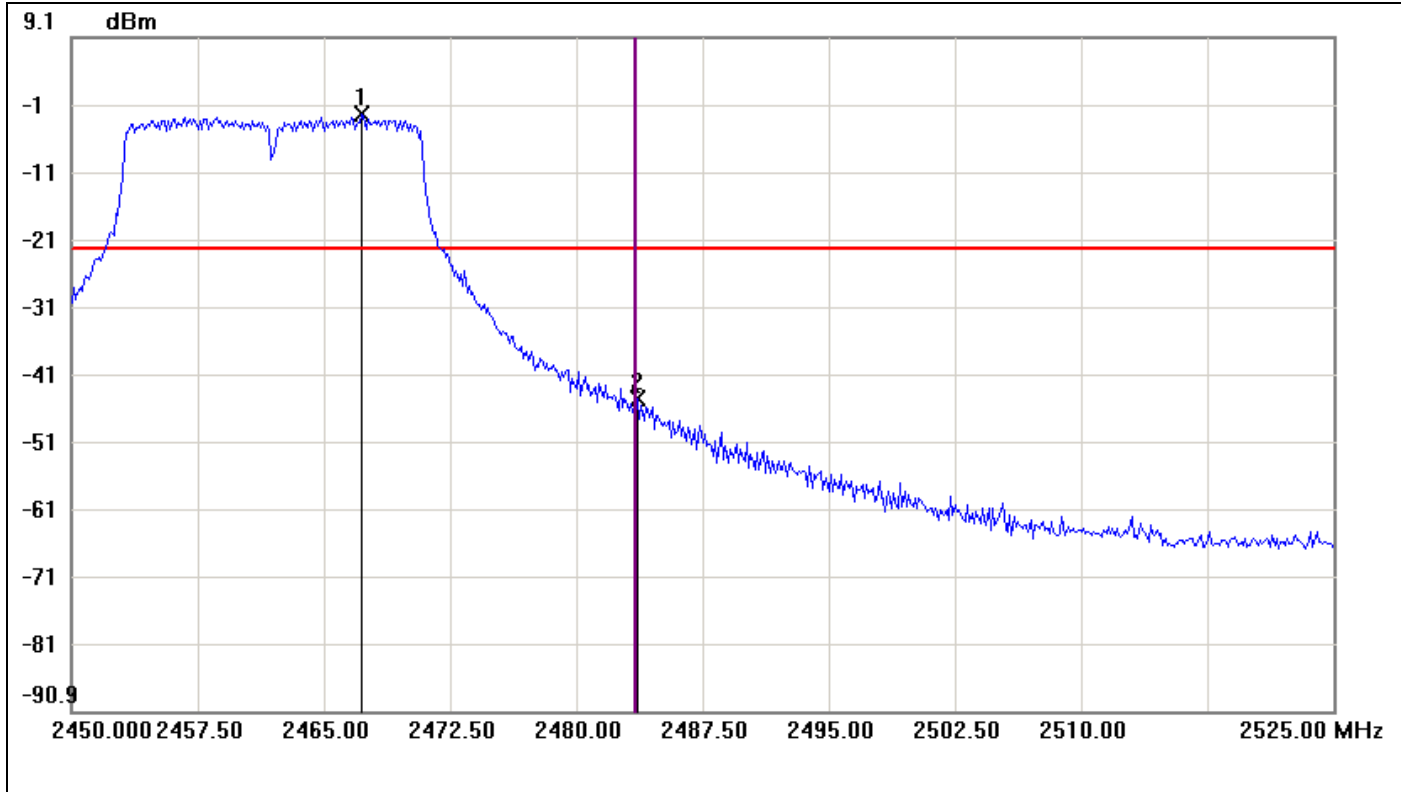

| No. | Frequency(MHz) | Result(dBm) | Limit(dBm) | Margin(dBm) |
|-----|----------------|-------------|------------|-------------|
| 1   | 2467.2500      | -2.31       | -22.31     | 20.00       |
| 2   | 2483.6250      | -44.50      | -22.31     | -22.19      |



Conducted Band Edges (IEEE 802.11n HT 40 MHz mode / CH Low)

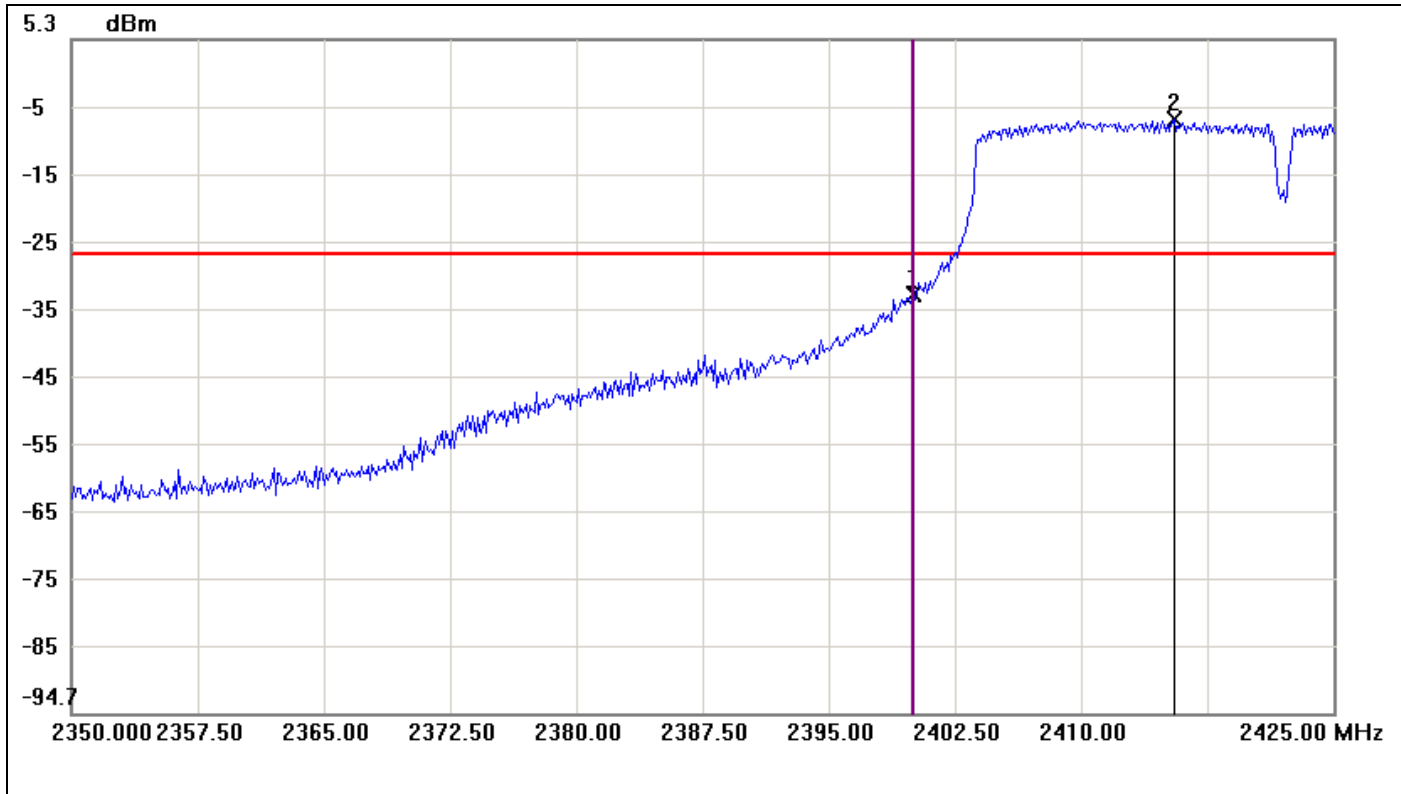

| No. | Frequency(MHz) | Result(dBm) | Limit(dBm) | Margin(dBm) |
|-----|----------------|-------------|------------|-------------|
| 1   | 2400.0000      | -32.58      | -26.54     | -6.04       |
| 2   | 2415.5000      | -6.54       | -26.54     | 20.00       |



Conducted Band Edges (IEEE 802.11n HT 40 MHz mode / CH High)

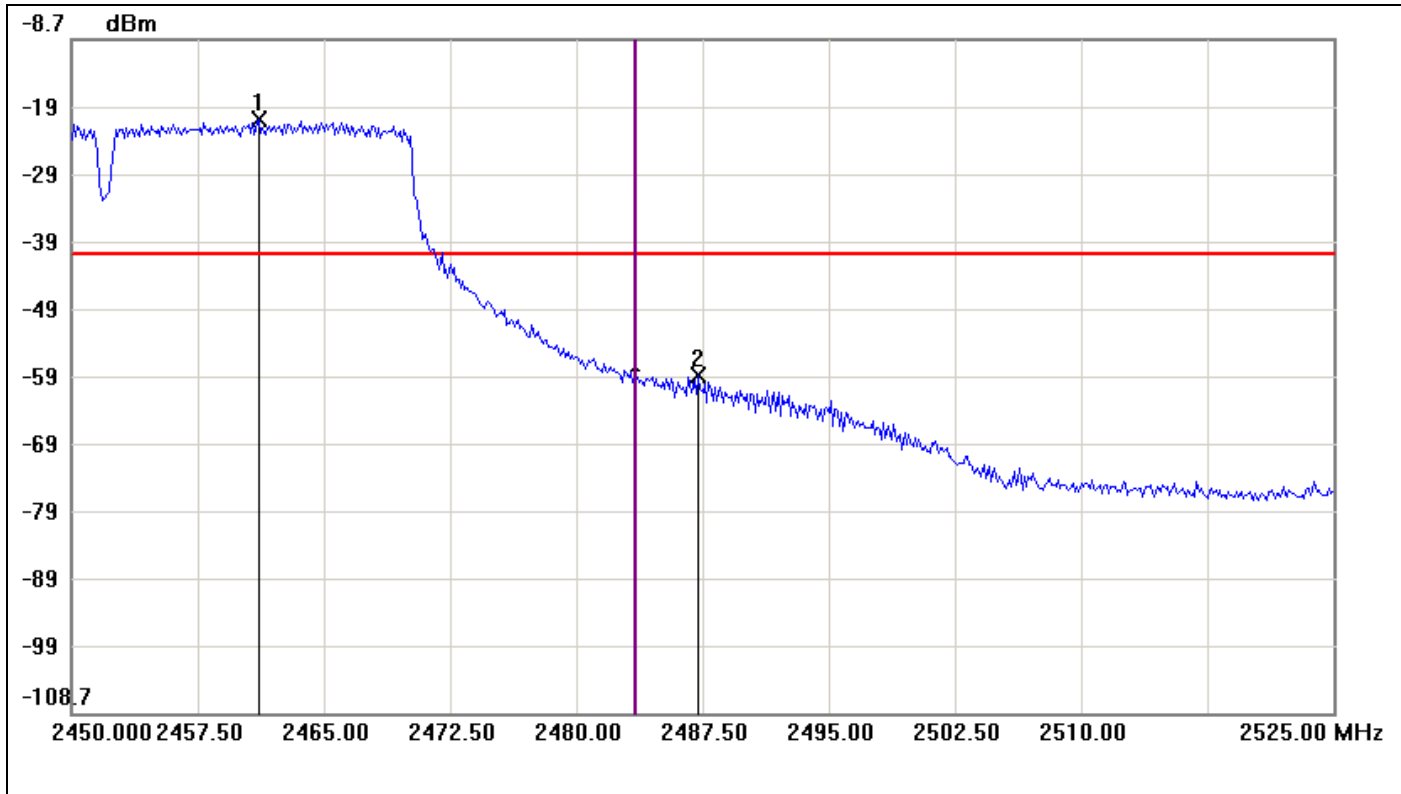

| No. | Frequency(MHz) | Result(dBm) | Limit(dBm) | Margin(dBm) |
|-----|----------------|-------------|------------|-------------|
| 1   | 2461.1250      | -20.59      | -40.59     | 20.00       |
| 2   | 2487.2500      | -58.49      | -40.59     | -17.90      |



## 8.6 PEAK POWER SPECTRAL DENSITY

### LIMIT

1. According to §15.247(e) & RSS-210 §A8.2, for digitally modulated systems, the power spectral density conducted from the intentional radiator to the antenna shall not be greater than 8 dBm in any 3 kHz band during any time interval of continuous transmission.
2. According to §15.247(f) & RSS-210 §A8.3, the digital modulation operation of the hybrid system, with the frequency hopping turned off, shall comply with the power density requirements of paragraph (d) of this section.

### Test Configuration

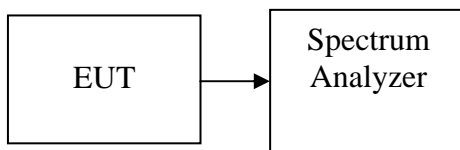

### TEST PROCEDURE

1. Place the EUT on the table and set it in transmitting mode.  
Remove the antenna from the EUT and then connect a low loss RF cable from the antenna port to the spectrum analyzer.
2. Set the spectrum analyzer as RBW = 10kHz, VBW = 100kHz, Sweep= auto couple.
3. Record the max. reading.
4. Repeat the above procedure until the measurements for all frequencies are completed.

### TEST RESULTS

*No non-compliance noted*



**Test Data**

**Test mode: IEEE 802.11b mode**

| Channel | Frequency (MHz) | PPSD (dBm) | Limit (dBm) | Result |
|---------|-----------------|------------|-------------|--------|
| Low     | 2412            | -0.45      | 8.00        | PASS   |
| Mid     | 2442            | 0.91       |             | PASS   |
| High    | 2462            | -2.04      |             | PASS   |

**Test mode: IEEE 802.11g mode**

| Channel | Frequency (MHz) | PPSD (dBm) | Limit (dBm) | Result |
|---------|-----------------|------------|-------------|--------|
| Low     | 2412            | -4.11      | 8.00        | PASS   |
| Mid     | 2442            | -1.61      |             | PASS   |
| High    | 2462            | -6.16      |             | PASS   |

**Test mode: IEEE 802.11n HT 20 MHz mode**

| Channel | Frequency (MHz) | PPSD (dBm) | Limit (dBm) | Result |
|---------|-----------------|------------|-------------|--------|
| Low     | 2412            | -6.18      | 8.00        | PASS   |
| Mid     | 2442            | -1.23      |             | PASS   |
| High    | 2462            | -7.58      |             | PASS   |

**Test mode: IEEE 802.11n HT 40 MHz mode**

| Channel | Frequency (MHz) | PPSD (dBm) | Limit (dBm) | Result |
|---------|-----------------|------------|-------------|--------|
| Low     | 2422            | -11.90     | 8.00        | PASS   |
| Mid     | 2442            | -16.34     |             | PASS   |
| High    | 2452            | -26.39     |             | PASS   |



**Test mode: IEEE 802.11a mode**

| Channel | Frequency (MHz) | PPSD (dBm) | Limit (dBm) | Result |
|---------|-----------------|------------|-------------|--------|
| Low     | 5745            | -8.15      | 8.00        | PASS   |
| Mid     | 5785            | -8.01      |             | PASS   |
| High    | 5825            | -8.04      |             | PASS   |

**Test mode: IEEE 802.11n HT 20 MHz mode**

| Channel | Frequency (MHz) | PPSD (dBm) | Limit (dBm) | Result |
|---------|-----------------|------------|-------------|--------|
| Low     | 5745            | -8.86      | 8.00        | PASS   |
| Mid     | 5785            | -8.28      |             | PASS   |
| High    | 5825            | -8.28      |             | PASS   |

**Test mode: IEEE 802.11n HT 40 MHz mode**

| Channel | Frequency (MHz) | PPSD (dBm) | Limit (dBm) | Result |
|---------|-----------------|------------|-------------|--------|
| Low     | 5755            | -12.08     | 8.00        | PASS   |
| High    | 5795            | -14.32     |             | PASS   |



**Test Plot**

**IEEE 802.11b mode**

**PPSD (CH Low)**

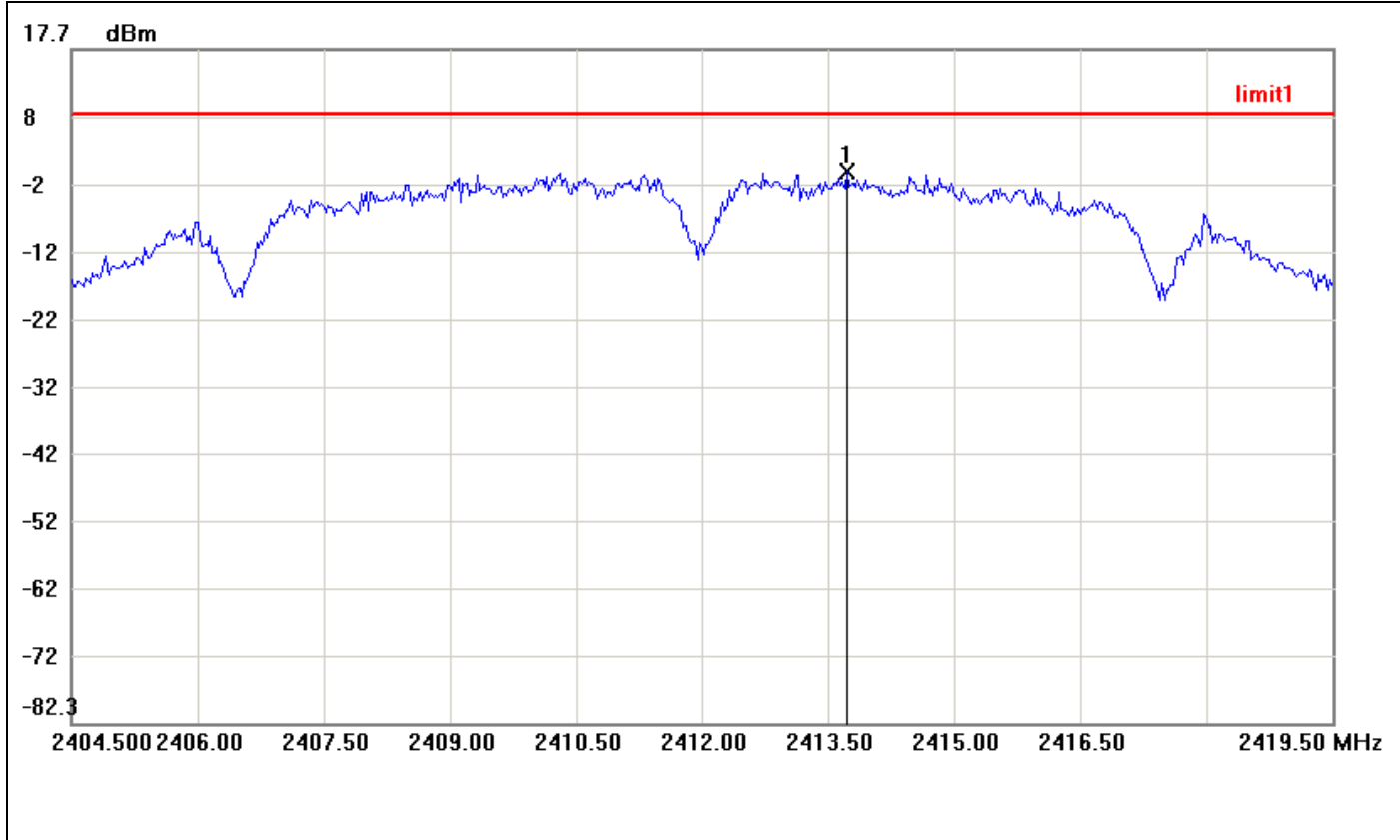

| No. | Frequency(MHz) | Result(dBm) | Limit(dBm) | Margin(dBm) |
|-----|----------------|-------------|------------|-------------|
| 1   | 2413.7250      | -0.45       | 8.00       | -8.45       |



PPSD (CH Mid)

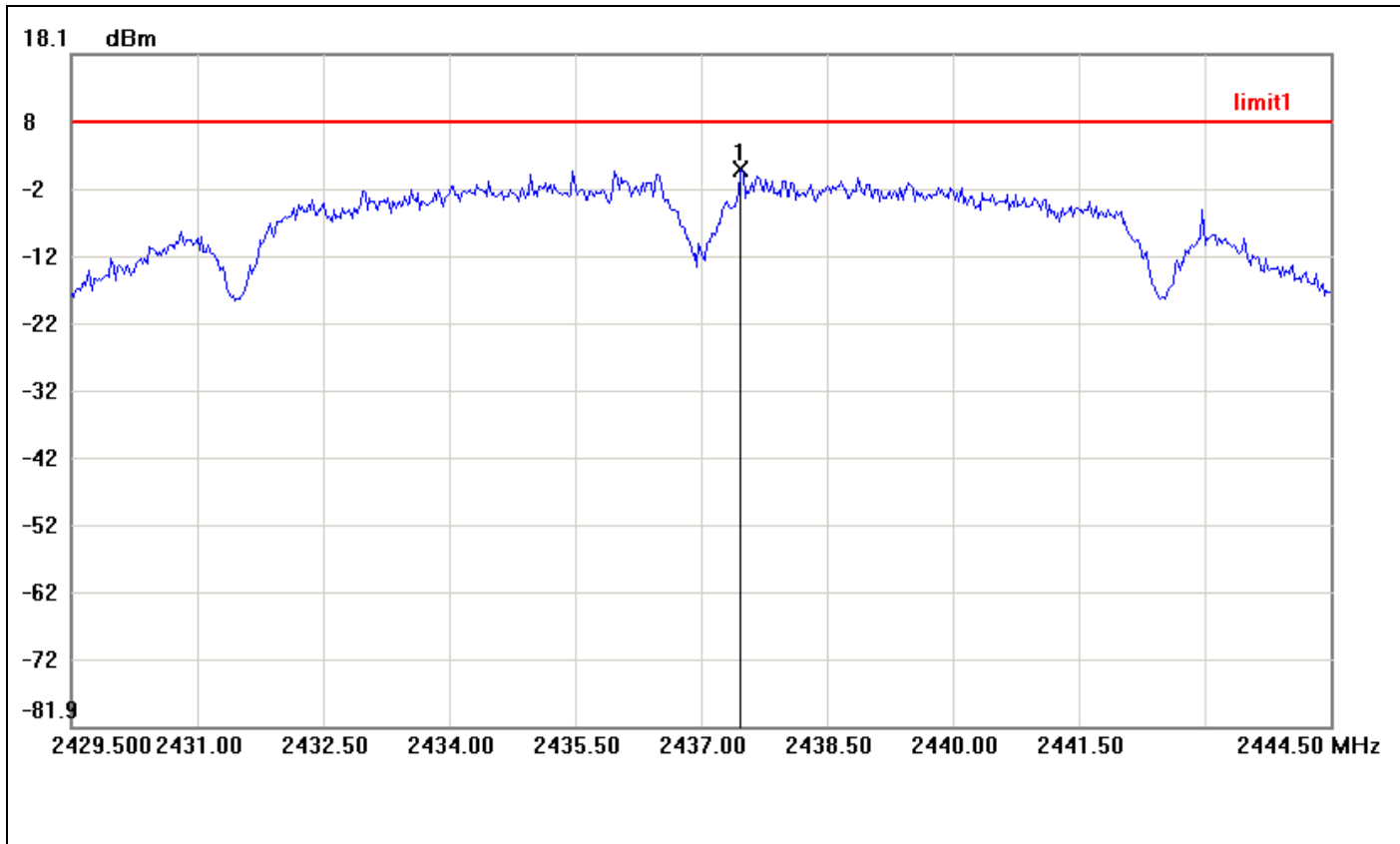

| No. | Frequency(MHz) | Result(dBm) | Limit(dBm) | Margin(dBm) |
|-----|----------------|-------------|------------|-------------|
| 1   | 2437.4750      | 0.91        | 8.00       | -7.09       |





PPSD (CH High)

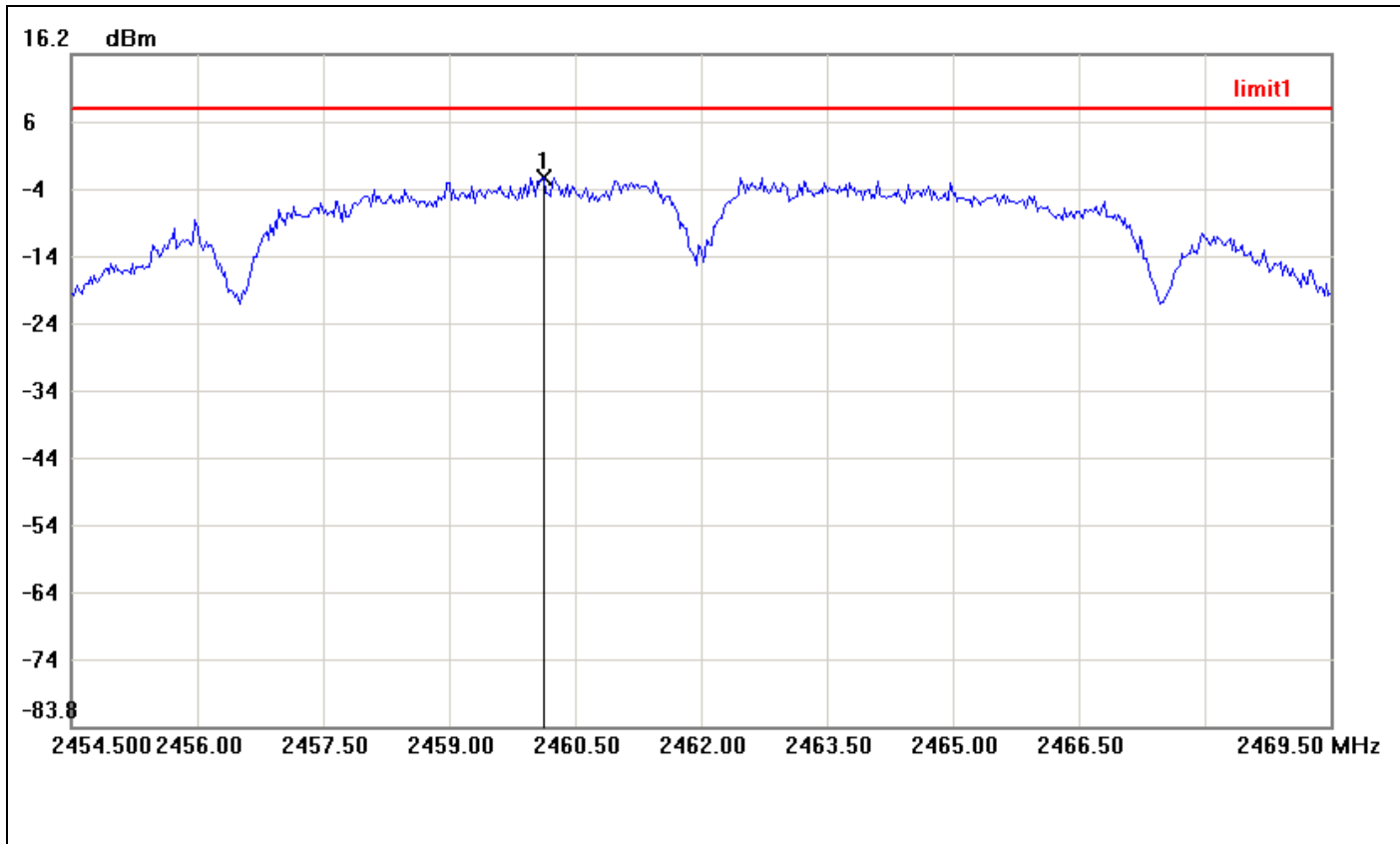

| No. | Frequency(MHz) | Result(dBm) | Limit(dBm) | Margin(dBm) |
|-----|----------------|-------------|------------|-------------|
| 1   | 2460.1250      | -2.04       | 8.00       | -10.04      |



**IEEE 802.11g mode**

**PPSD (CH Low)**

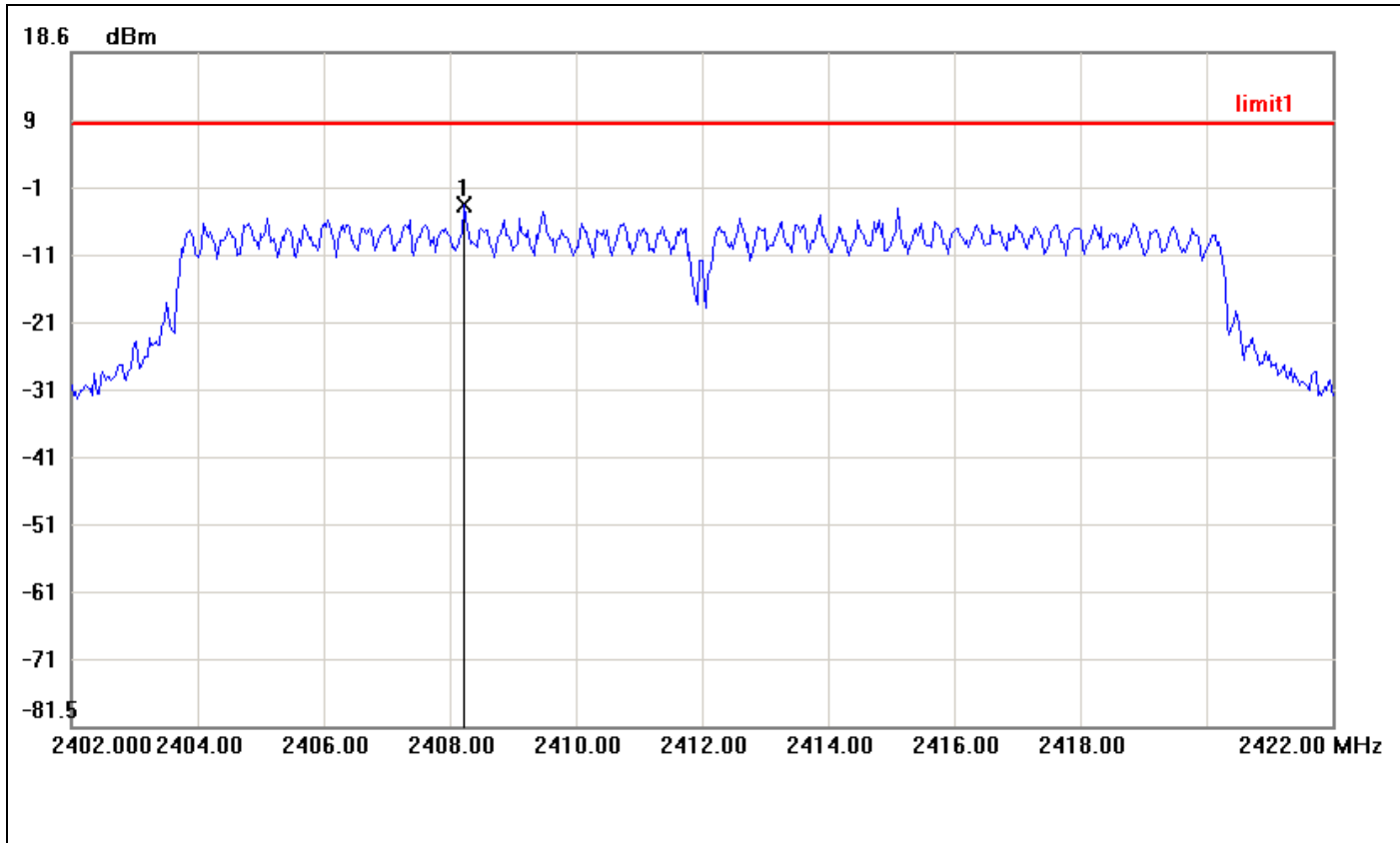

| No. | Frequency(MHz) | Result(dBm) | Limit(dBm) | Margin(dBm) |
|-----|----------------|-------------|------------|-------------|
| 1   | 2408.2333      | -4.11       | 8.00       | -12.11      |



PPSD (CH Mid)

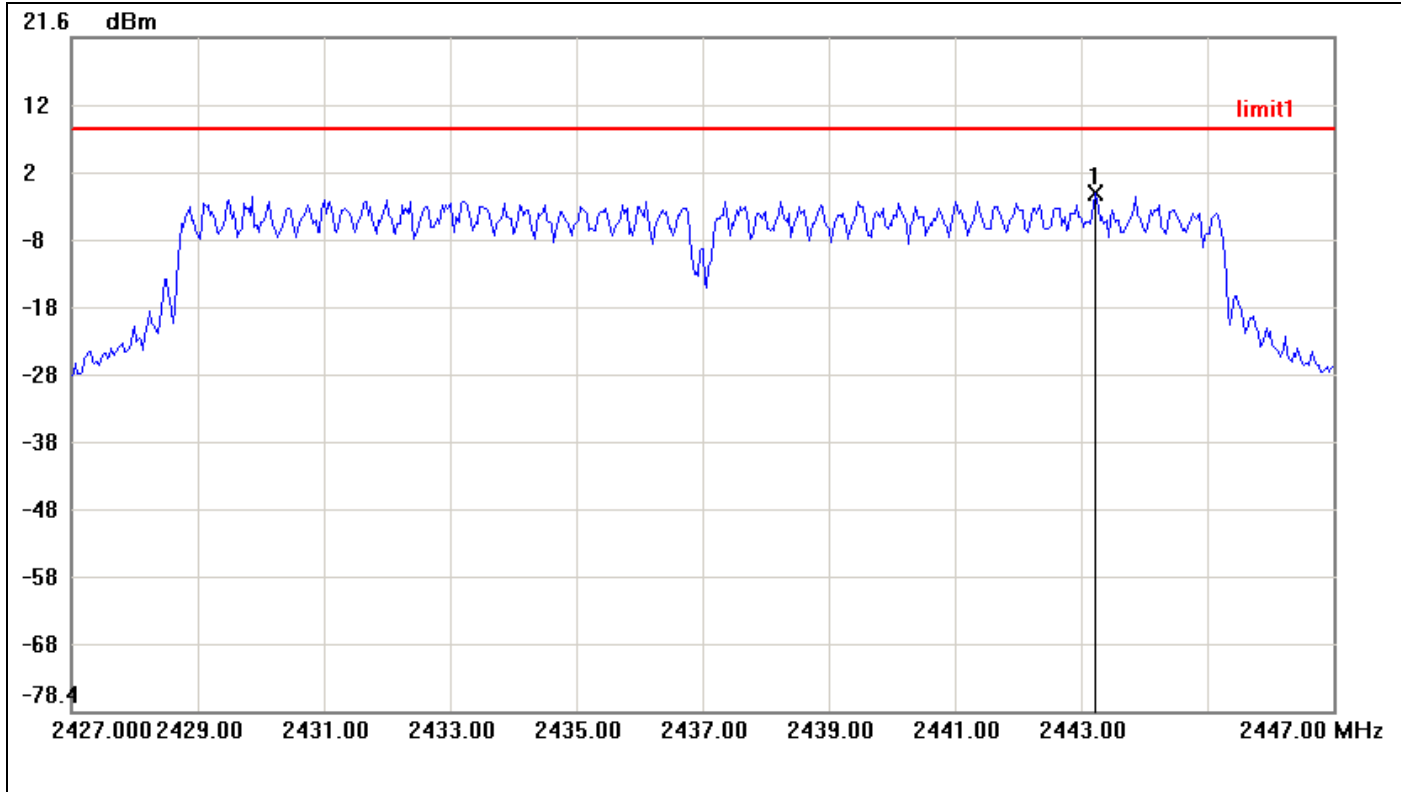

| No. | Frequency(MHz) | Result(dBm) | Limit(dBm) | Margin(dBm) |
|-----|----------------|-------------|------------|-------------|
| 1   | 2443.2333      | -1.61       | 8.00       | -9.61       |



PPSD (CH High)

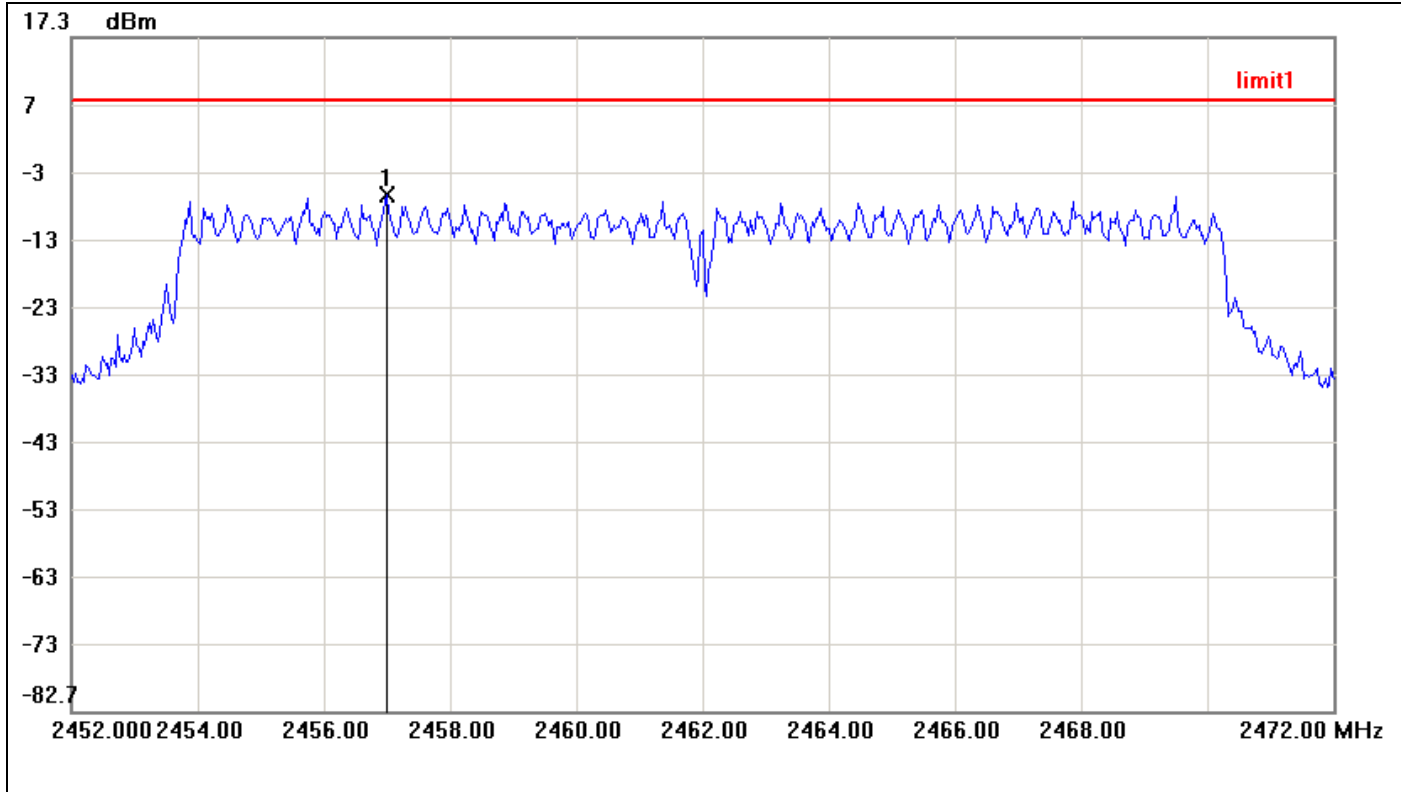

| No. | Frequency(MHz) | Result(dBm) | Limit(dBm) | Margin(dBm) |
|-----|----------------|-------------|------------|-------------|
| 1   | 2457.0000      | -6.16       | 8.00       | -14.16      |



**IEEE 802.11n HT 20 MHz mode**

**PPSD (CH Low)**

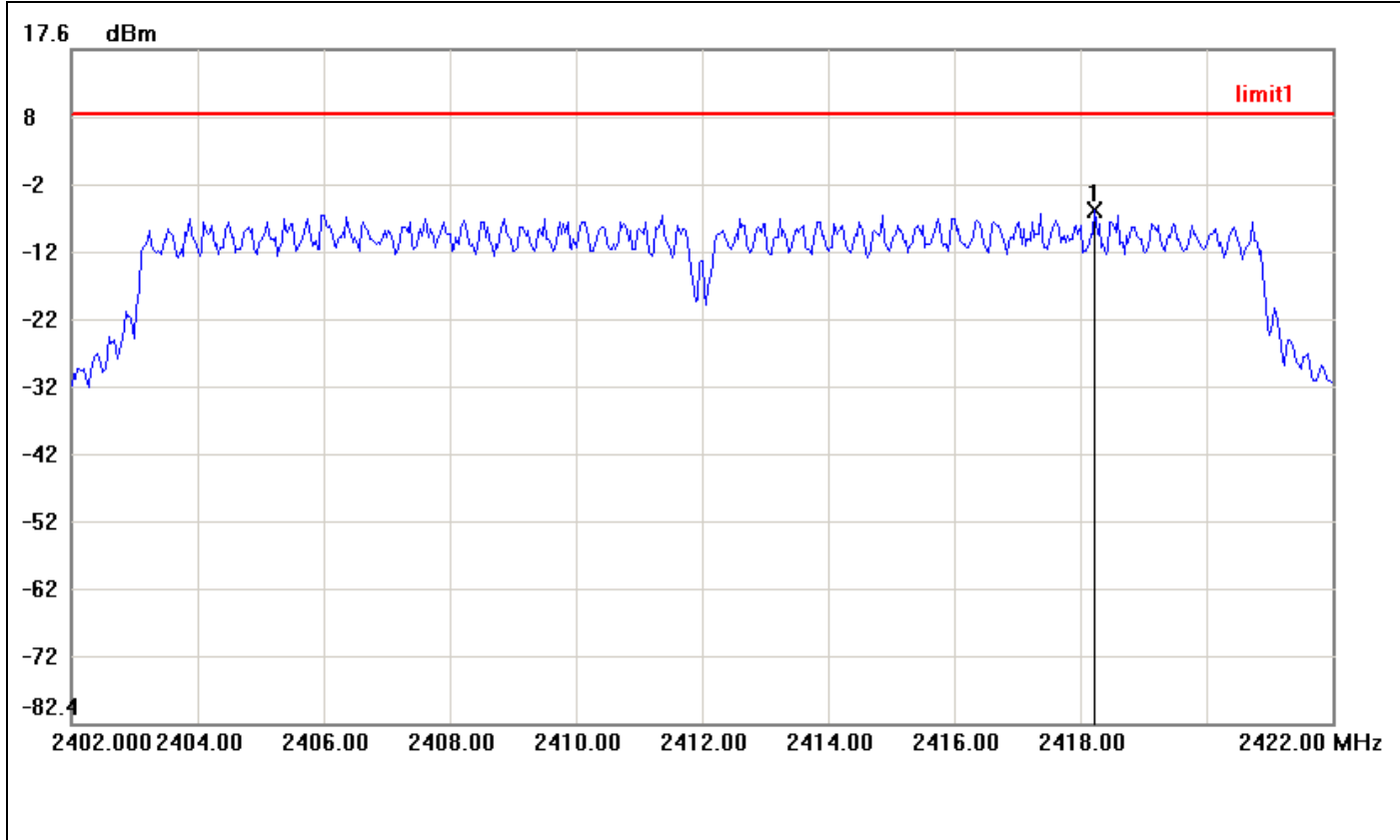

| No. | Frequency(MHz) | Result(dBm) | Limit(dBm) | Margin(dBm) |
|-----|----------------|-------------|------------|-------------|
| 1   | 2418.2333      | -6.18       | 8.00       | -14.18      |



### PPSD (CH Mid)

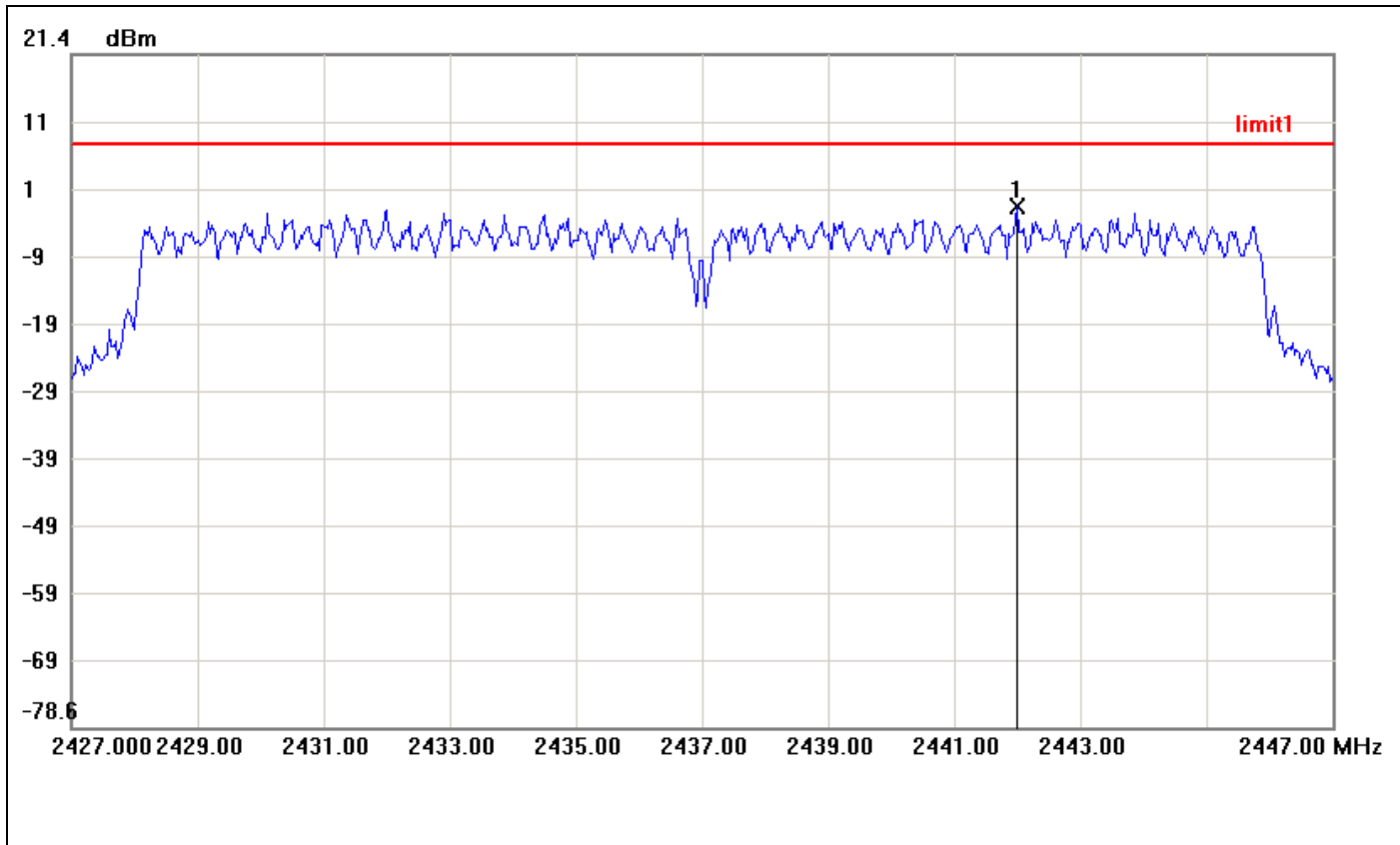

| No. | Frequency(MHz) | Result(dBm) | Limit(dBm) | Margin(dBm) |
|-----|----------------|-------------|------------|-------------|
| 1   | 2442.0000      | -1.23       | 8.00       | -9.23       |



PPSD (CH High)

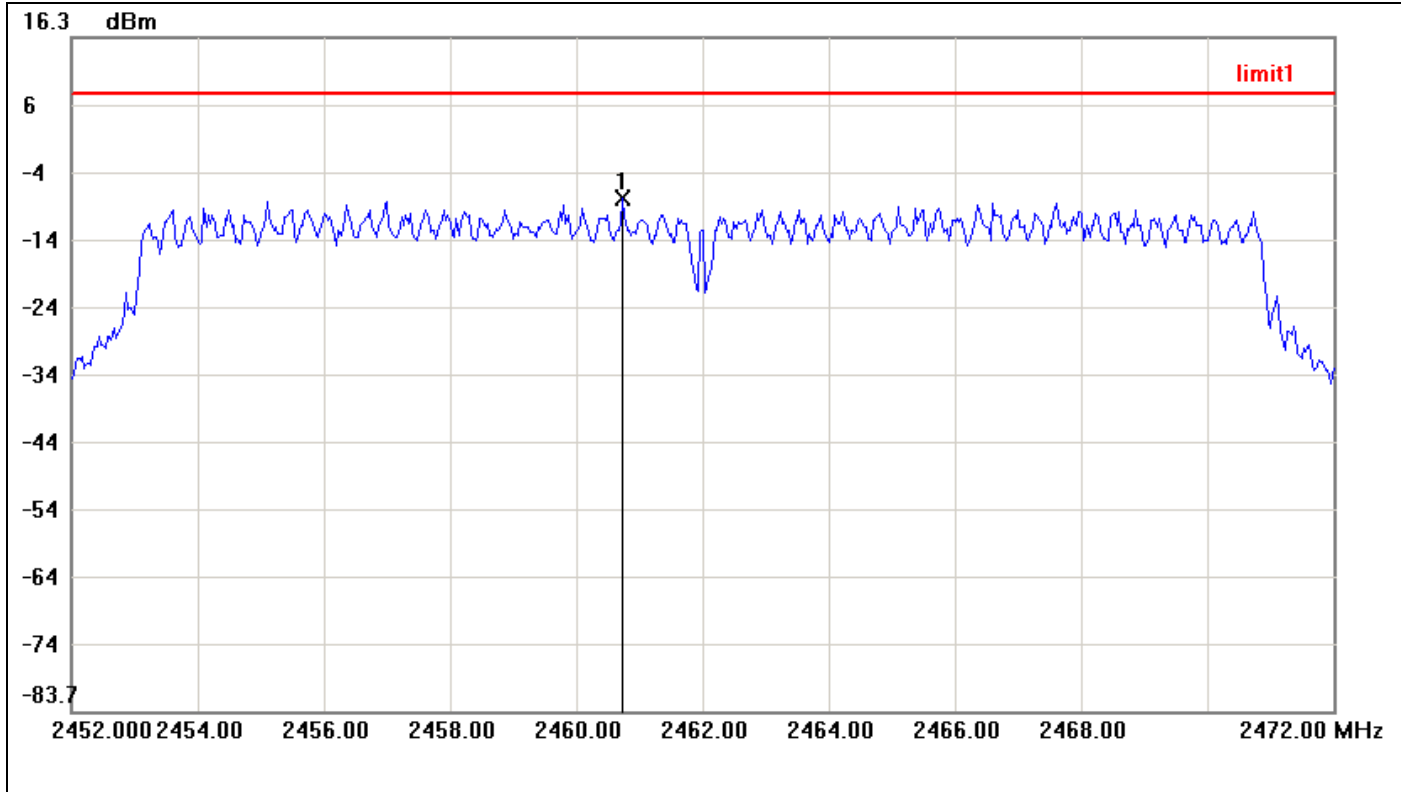

| No. | Frequency(MHz) | Result(dBm) | Limit(dBm) | Margin(dBm) |
|-----|----------------|-------------|------------|-------------|
| 1   | 2460.7333      | -7.58       | 8.00       | -15.58      |



**IEEE 802.11n HT 40 MHz mode**

**PPSD (CH Low)**

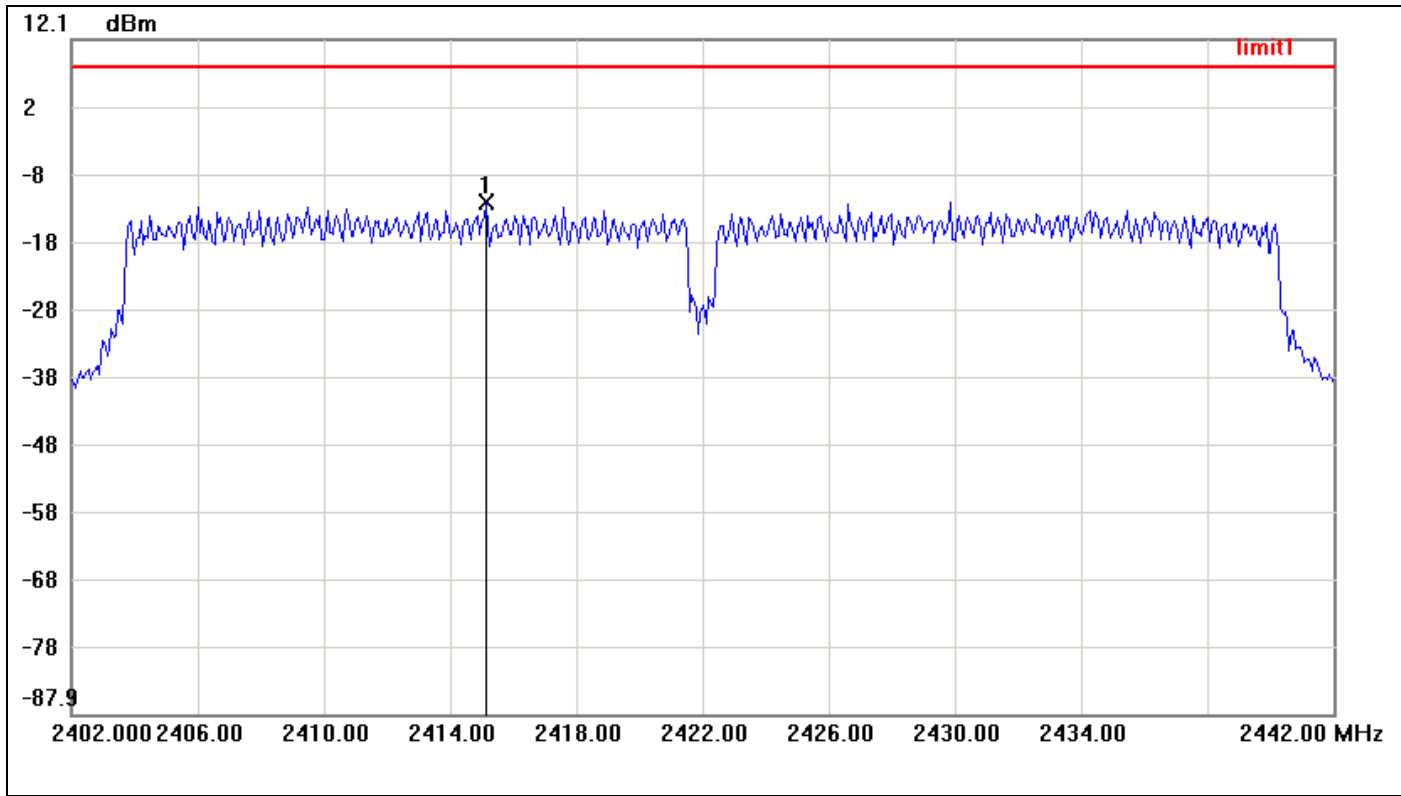

| No. | Frequency(MHz) | Result(dBm) | Limit(dBm) | Margin(dBm) |
|-----|----------------|-------------|------------|-------------|
| 1   | 2415.1333      | -11.90      | 8.00       | -19.90      |





PPSD (CH Mid)

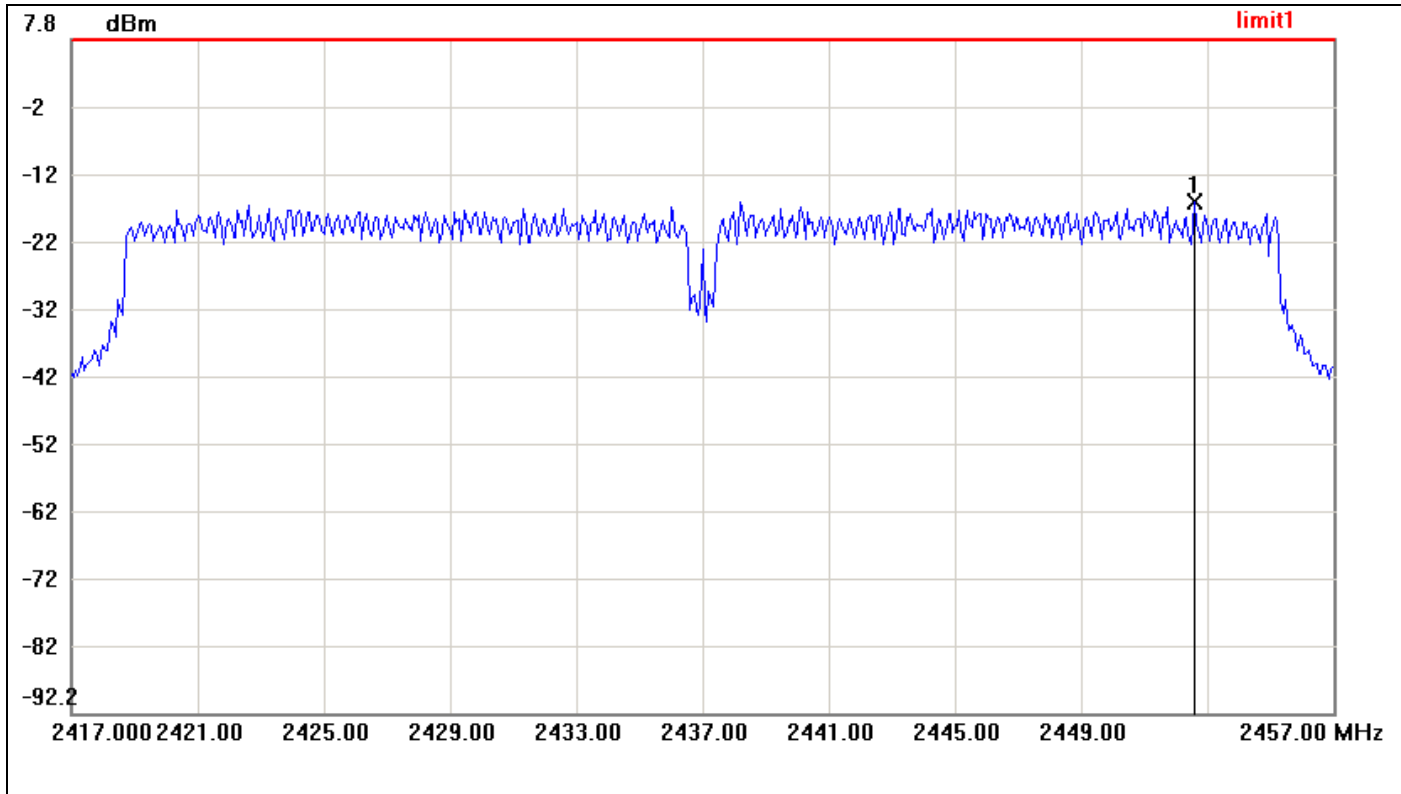

| No. | Frequency(MHz) | Result(dBm) | Limit(dBm) | Margin(dBm) |
|-----|----------------|-------------|------------|-------------|
| 1   | 2452.6000      | -16.34      | 8.00       | -24.34      |



PPSD (CH High)

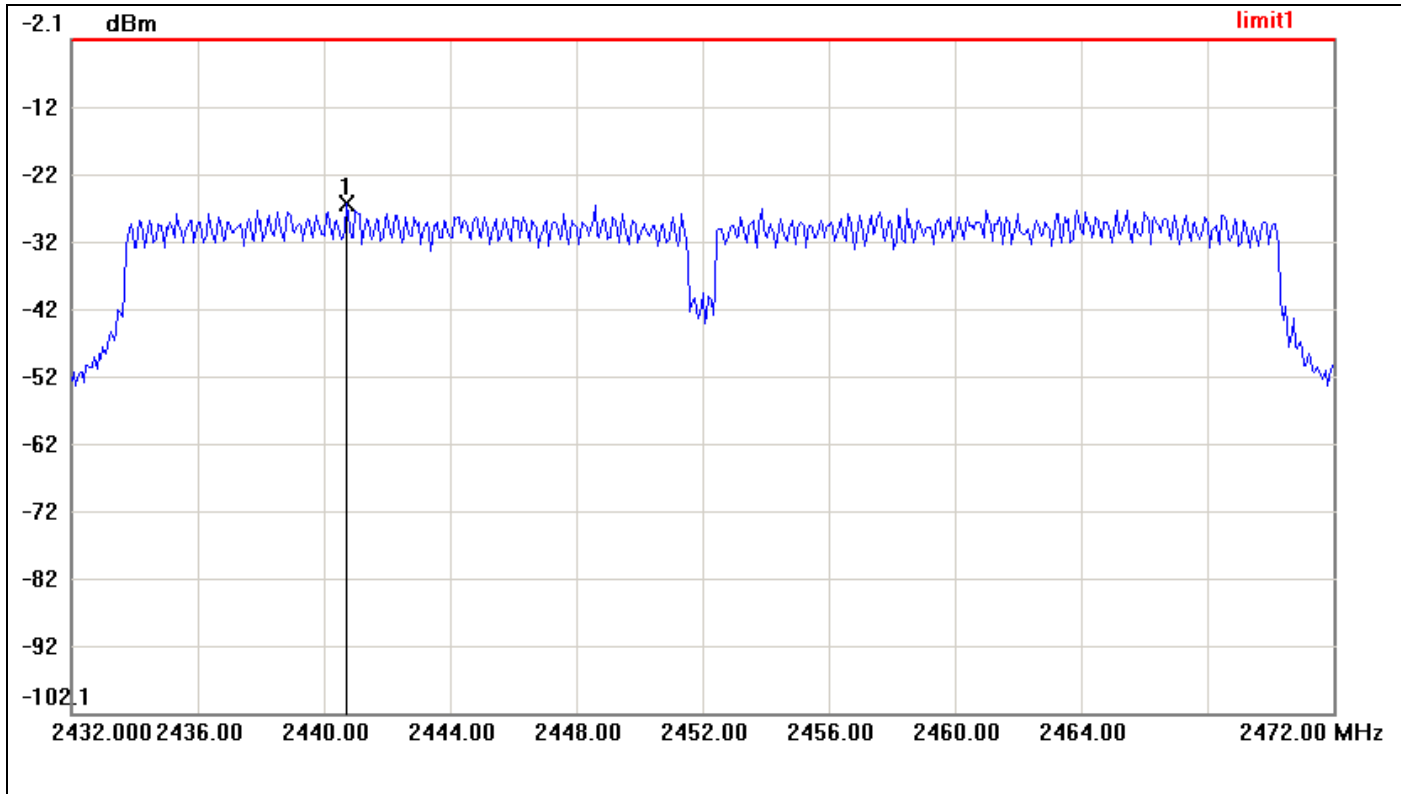

| No. | Frequency(MHz) | Result(dBm) | Limit(dBm) | Margin(dBm) |
|-----|----------------|-------------|------------|-------------|
| 1   | 2440.7333      | -26.39      | 8.00       | -34.39      |



**IEEE 802.11a mode**

**PPSD (CH Low)**

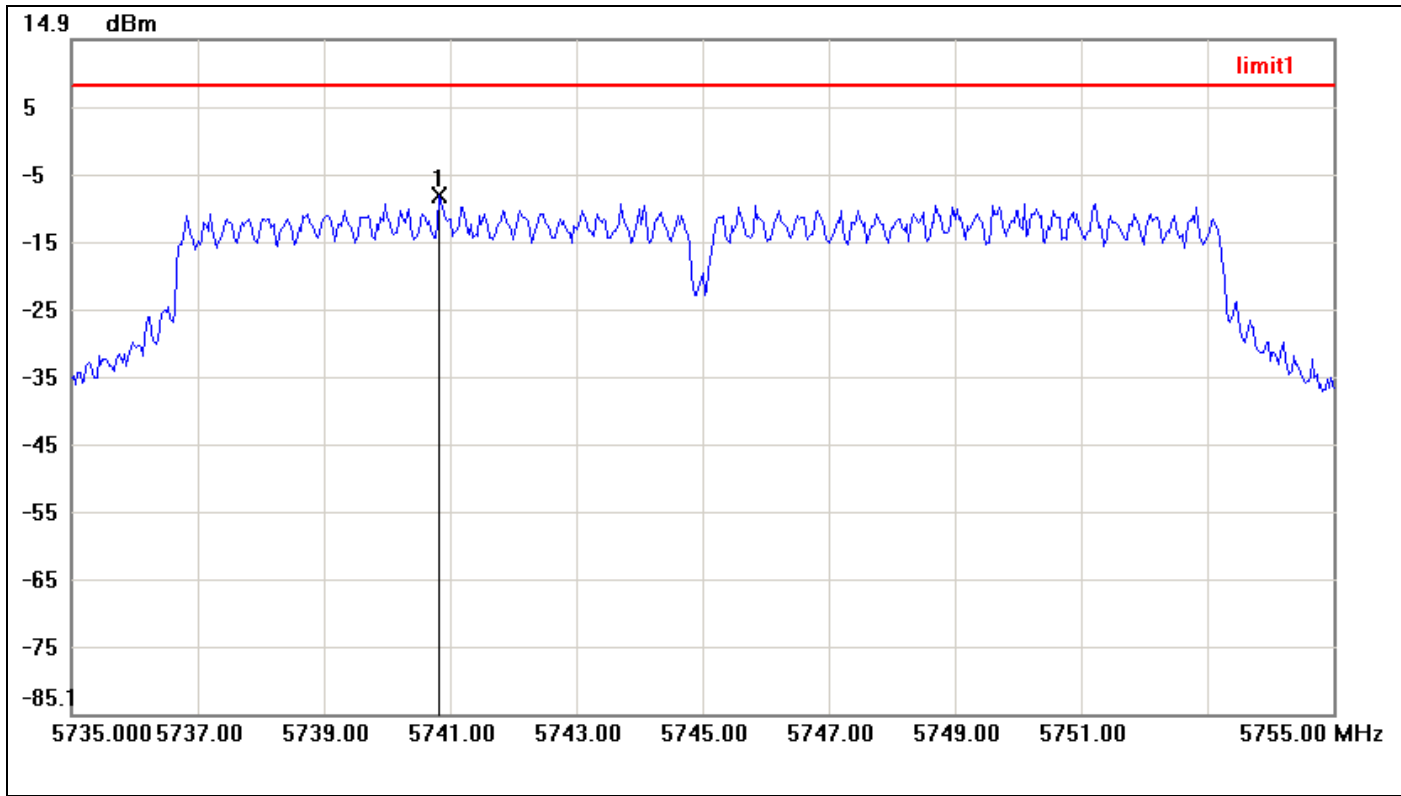

| No. | Frequency(MHz) | Result(dBm) | Limit(dBm) | Margin(dBm) |
|-----|----------------|-------------|------------|-------------|
| 1   | 5740.8333      | -8.15       | 8.00       | -16.15      |



PPSD (CH Mid)

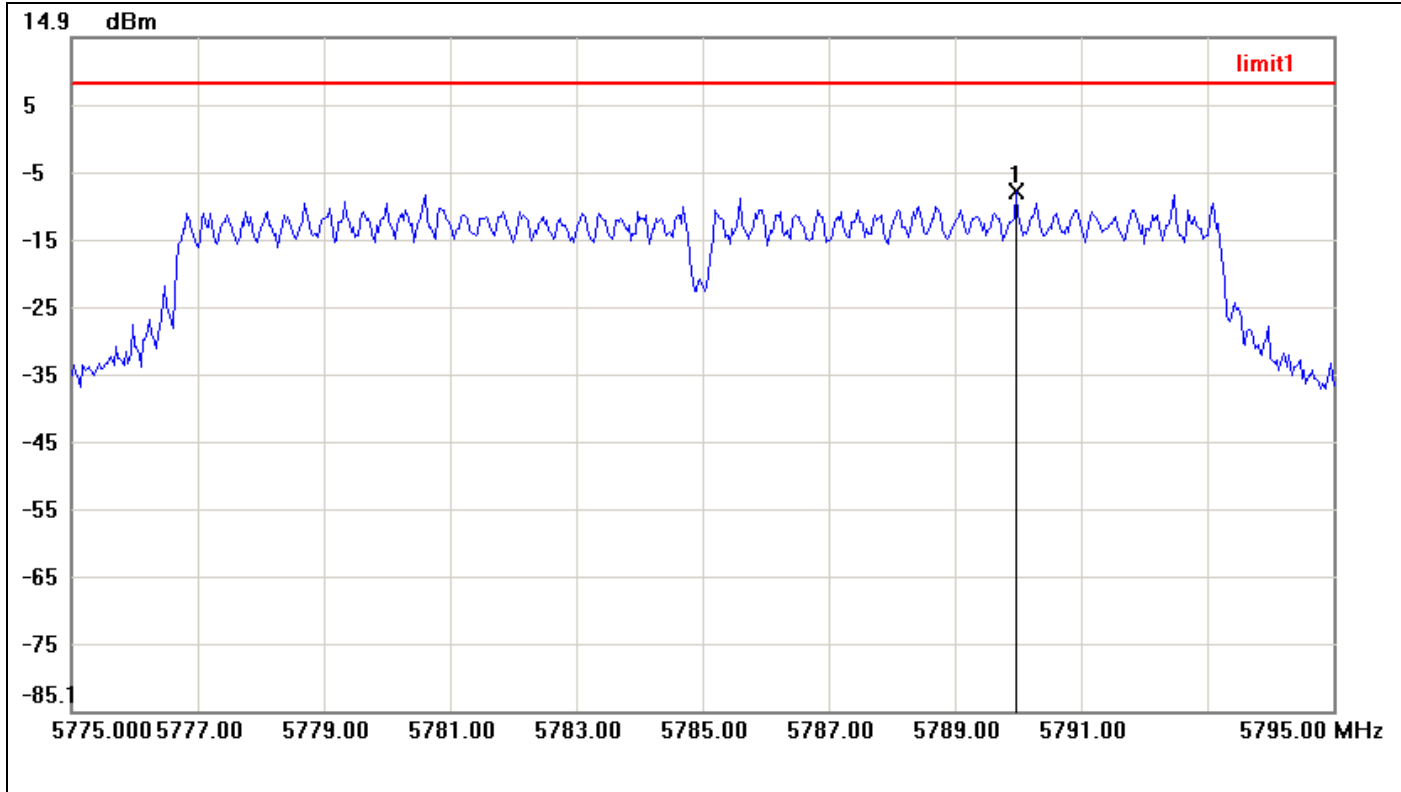

| No. | Frequency(MHz) | Result(dBm) | Limit(dBm) | Margin(dBm) |
|-----|----------------|-------------|------------|-------------|
| 1   | 5789.9667      | -8.01       | 8.00       | -16.01      |



### PPSD (CH High)

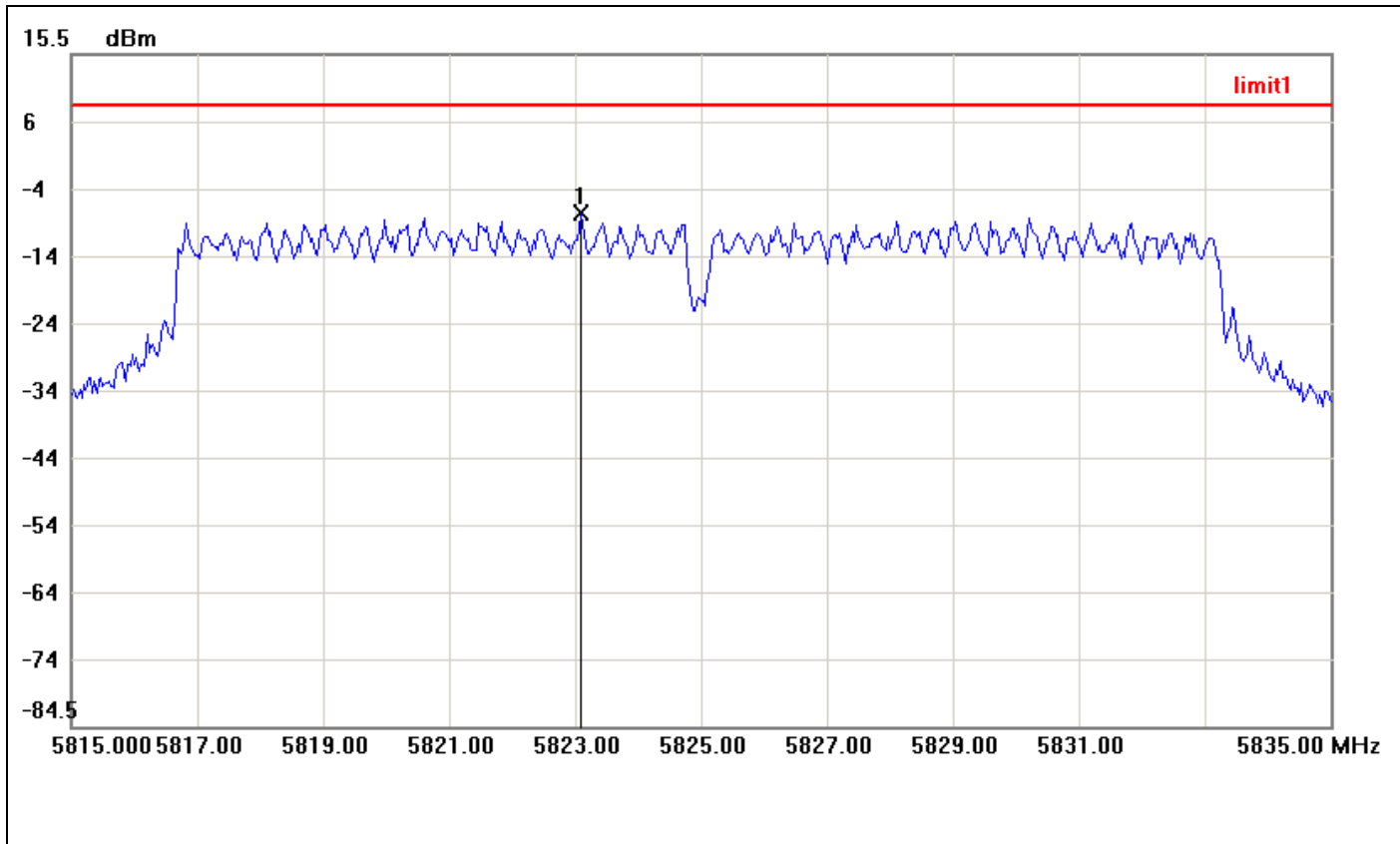

| No. | Frequency(MHz) | Result(dBm) | Limit(dBm) | Margin(dBm) |
|-----|----------------|-------------|------------|-------------|
| 1   | 5823.1000      | -8.04       | 8.00       | -16.04      |



**IEEE 802.11n HT 20 MHz mode**

**PPSD (CH Low)**

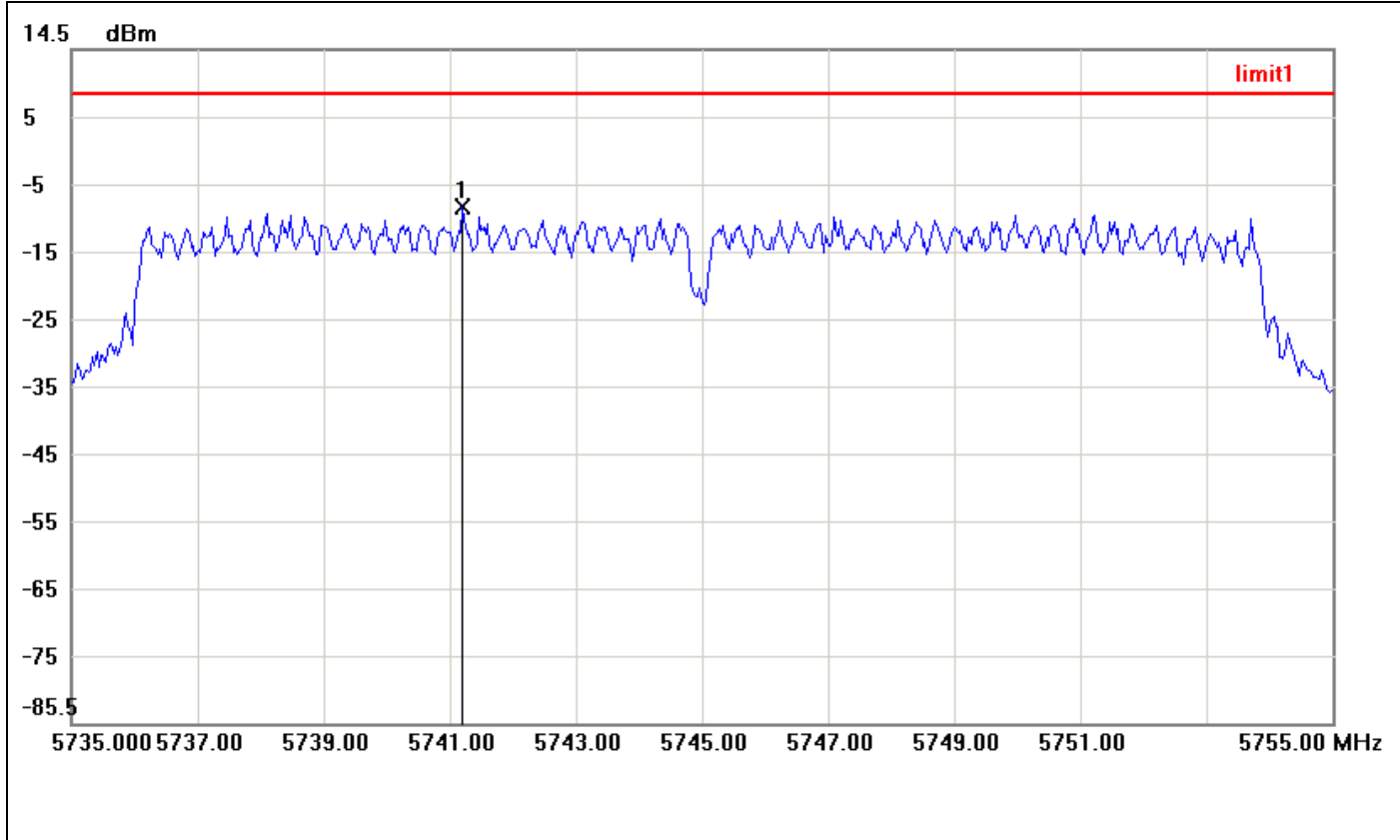

| No. | Frequency(MHz) | Result(dBm) | Limit(dBm) | Margin(dBm) |
|-----|----------------|-------------|------------|-------------|
| 1   | 5741.2000      | -8.86       | 8.00       | -16.86      |



PPSD (CH Mid)

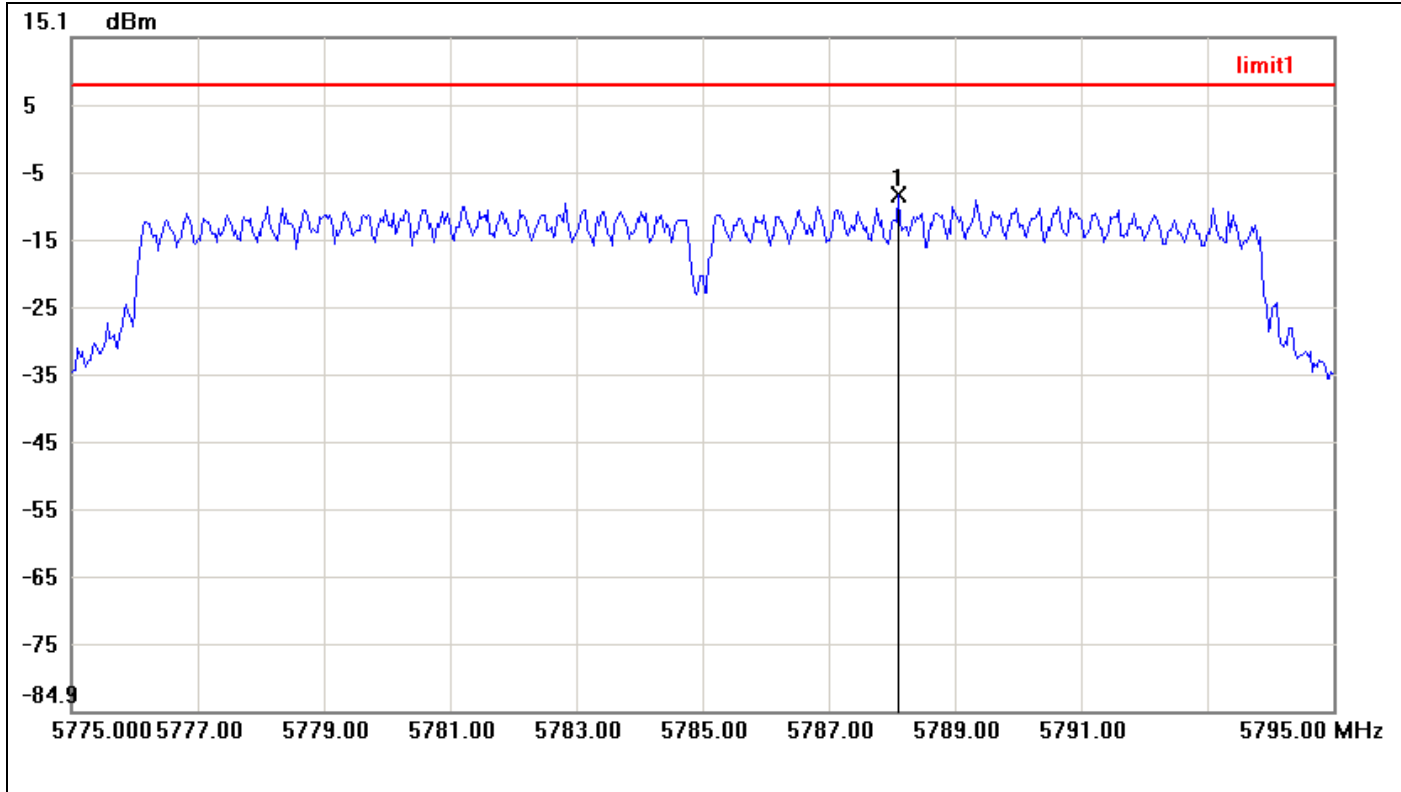

| No. | Frequency(MHz) | Result(dBm) | Limit(dBm) | Margin(dBm) |
|-----|----------------|-------------|------------|-------------|
| 1   | 5788.1000      | -8.28       | 8.00       | -16.28      |



PPSD (CH High)

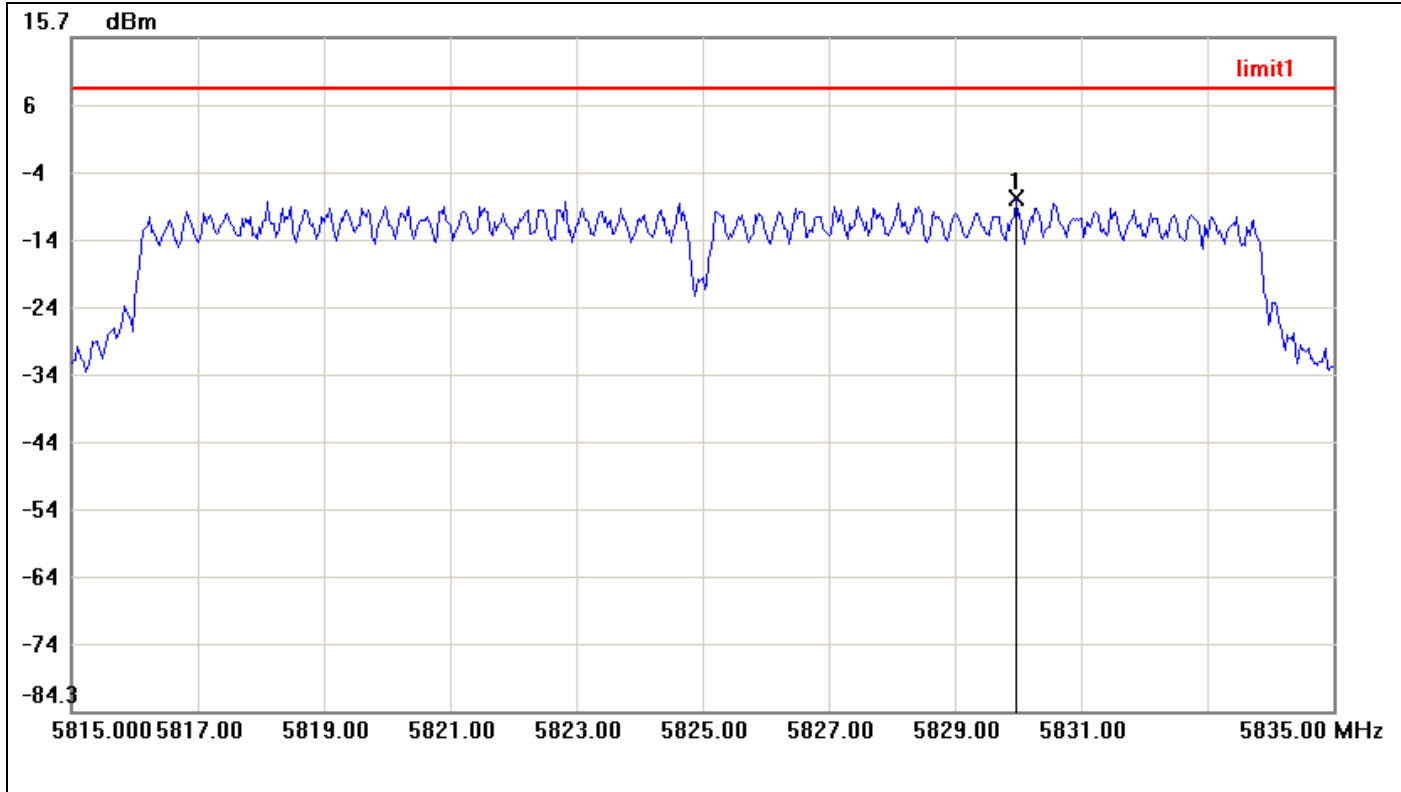

| No. | Frequency(MHz) | Result(dBm) | Limit(dBm) | Margin(dBm) |
|-----|----------------|-------------|------------|-------------|
| 1   | 5829.9667      | -8.28       | 8.00       | -16.28      |





**IEEE 802.11n HT 40 MHz mode**

**PPSD (CH Low)**

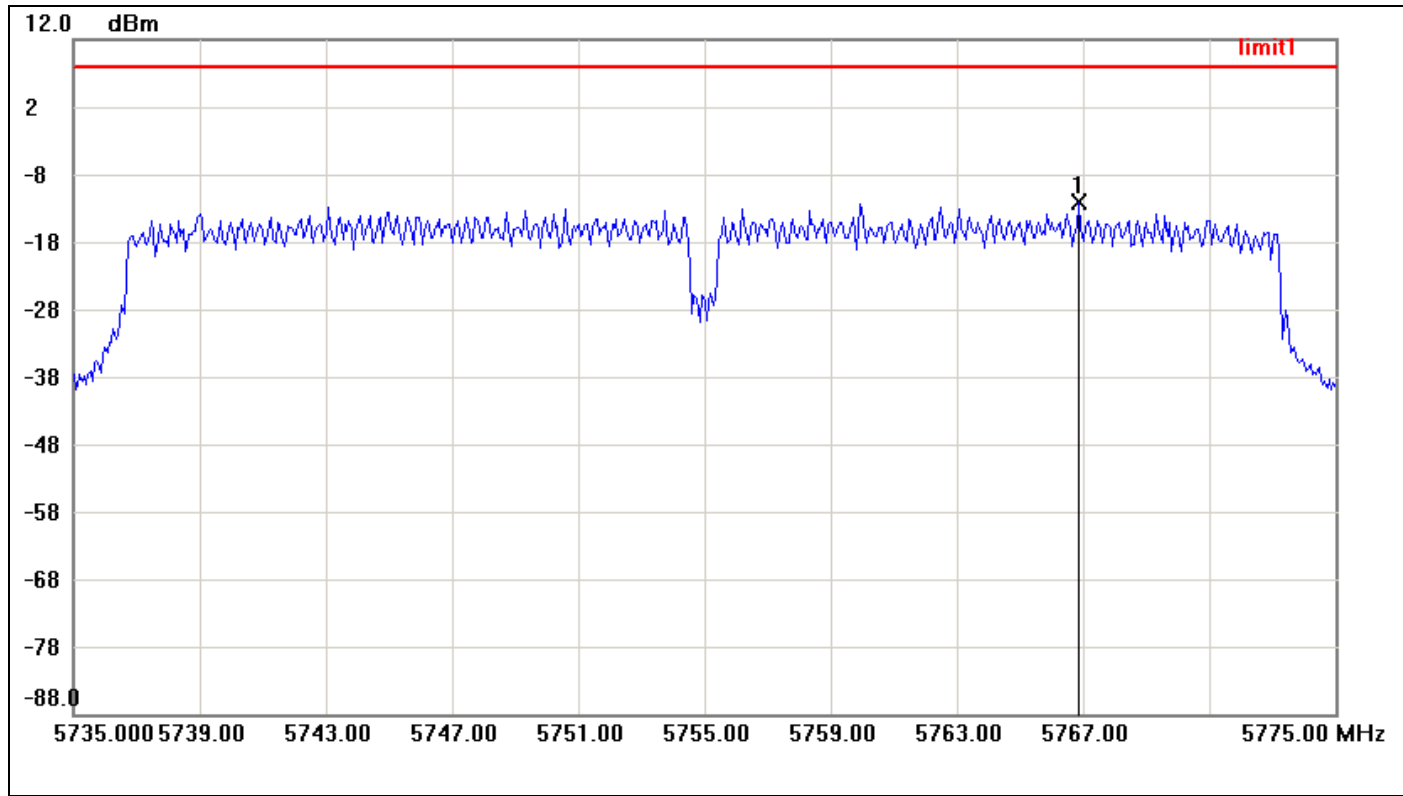

| No. | Frequency(MHz) | Result(dBm) | Limit(dBm) | Margin(dBm) |
|-----|----------------|-------------|------------|-------------|
| 1   | 5766.8667      | -12.08      | 8.00       | -20.08      |



PPSD (CH High)

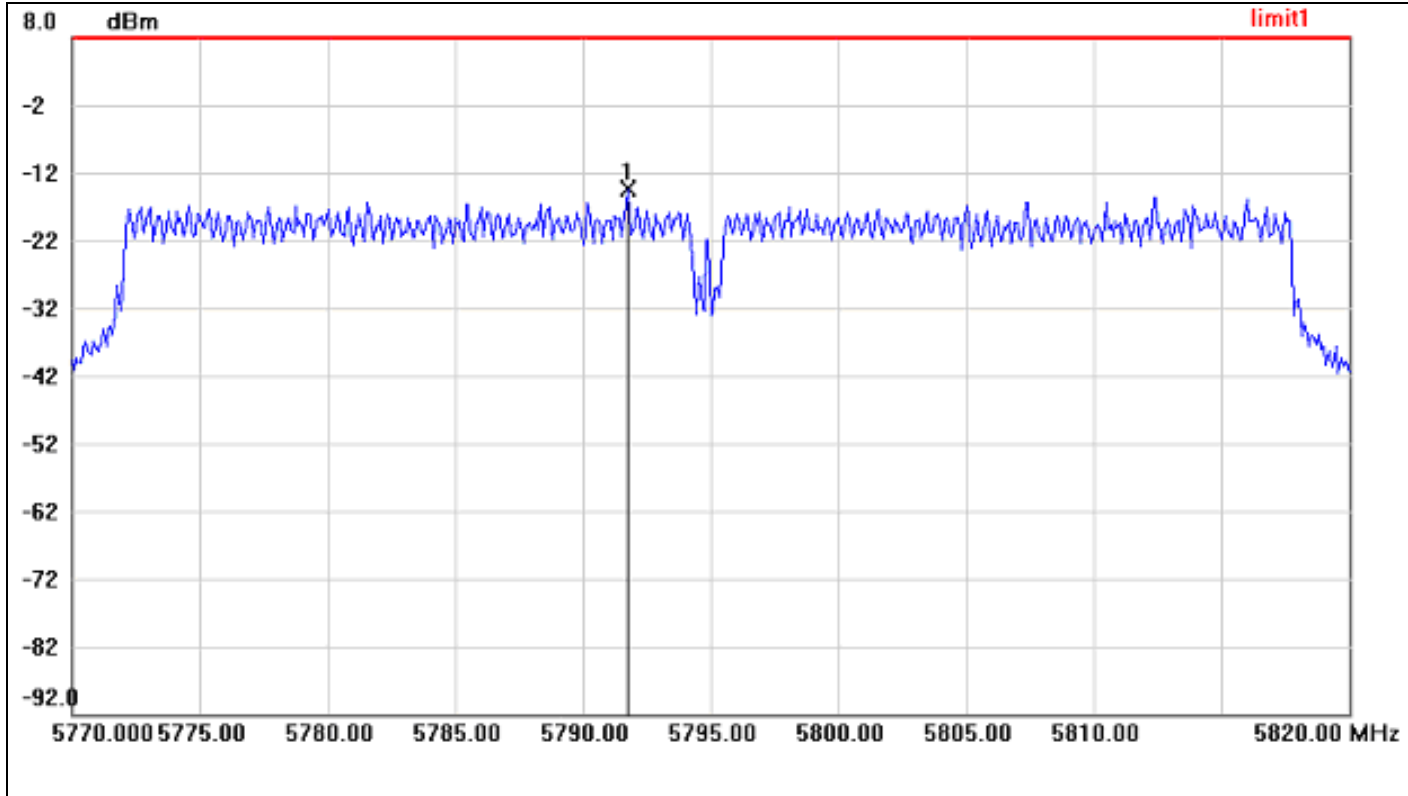

| No. | Frequency(MHz) | Result(dBm) | Limit(dBm) | Margin(dBm) |
|-----|----------------|-------------|------------|-------------|
| 1   | 5792.4000      | -14.32      | 8.00       | -22.32      |



### 8.7 RADIATED EMISSIONS

#### LIMIT

All spurious emissions shall comply with the limits of §15.209(a) and RSS-Gen Table 2 & Table 5.

#### RSS-Gen Table 2 & Table 5: General Field Strength Limits for Transmitters and Receivers at Frequencies Above 30 MHz <sup>(Note)</sup>

| Frequency (MHz) | Field Strength<br>microvolts/m at 3 metres (watts, e.i.r.p.) |              |
|-----------------|--|--------------|
|                 | Transmitters   | Receivers    |
| 30-88           | 100 (3 nW)   | 100 (3 nW)   |
| 88-216          | 150 (6.8 nW)   | 150 (6.8 nW) |
| 216-960         | 200 (12 nW)  | 200 (12 nW)  |
| Above 960       | 500 (75 nW)  | 500 (75 nW)  |

*Note:* \*Measurements for compliance with limits in the above table may be performed at distances other than 3 metres, in accordance with Section 7.2.7.

Transmitting devices are not permitted in Table 1 bands or, unless stated otherwise, in TV bands (54-72 MHz, 76-88 MHz, 174-216 MHz, 470-608 MHz and 614-806 MHz).

#### RSS-Gen Table 6: General Field Strength Limits for Transmitters at Frequencies Below 30 MHz (Transmit)

| Frequency     | Field Strength (microvolts/m) | Magnetic H-Field (microamperes/m) | Measurement Distance (metres) |
|---------------|-------------------------------|-----------------------------------|-------------------------------|
| 9-490 kHz     | 2,400/F (F in kHz)            | 2,400/377F (F in kHz)             | 3000                          |
| 490-1,705 kHz | 24,000/F (F in kHz)           | 24,000/377F (F in kHz)            | 30                            |
| 1.705-30 MHz  | 30                            | N/A                               | 30                            |

*Note:* The emission limits for the bands 9-90 kHz and 110-490 kHz are based on measurements employing an average detector.



**Test Configuration**

**9kHz ~ 30MHz**

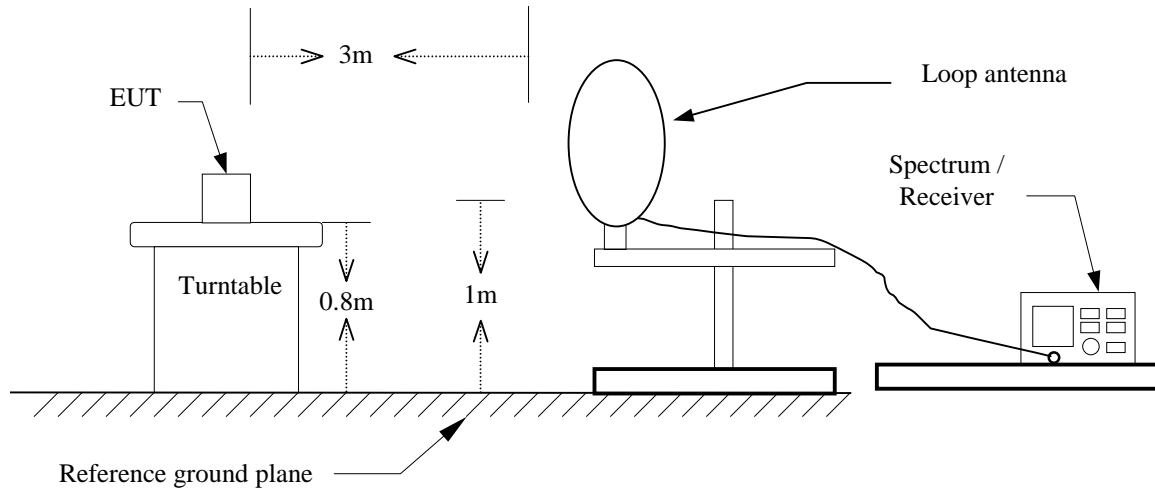

**30MHz ~ 1GHz**

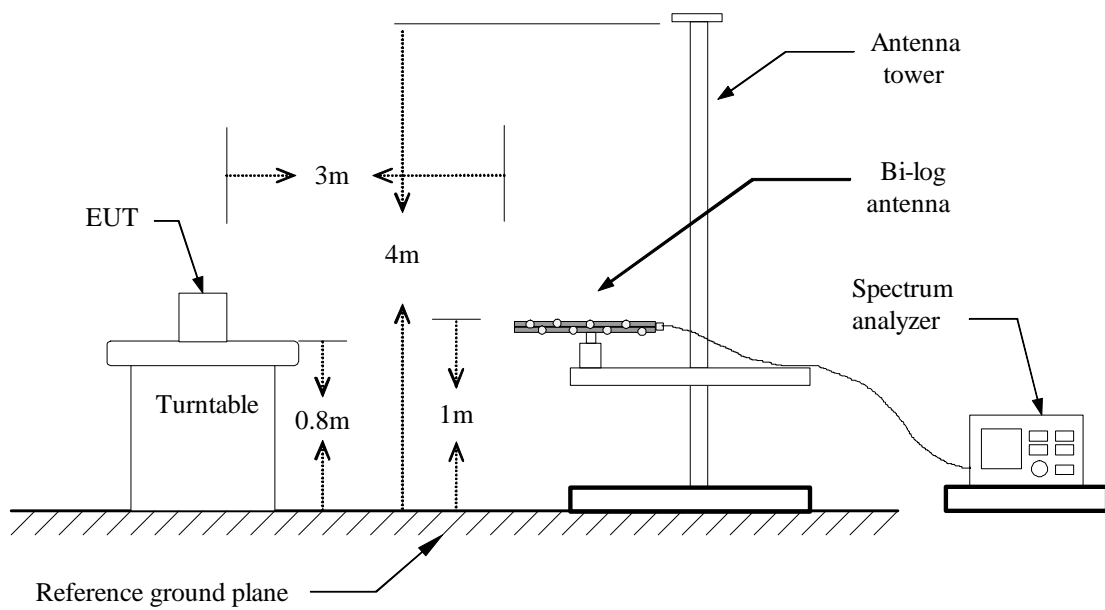



Above 1 GHz

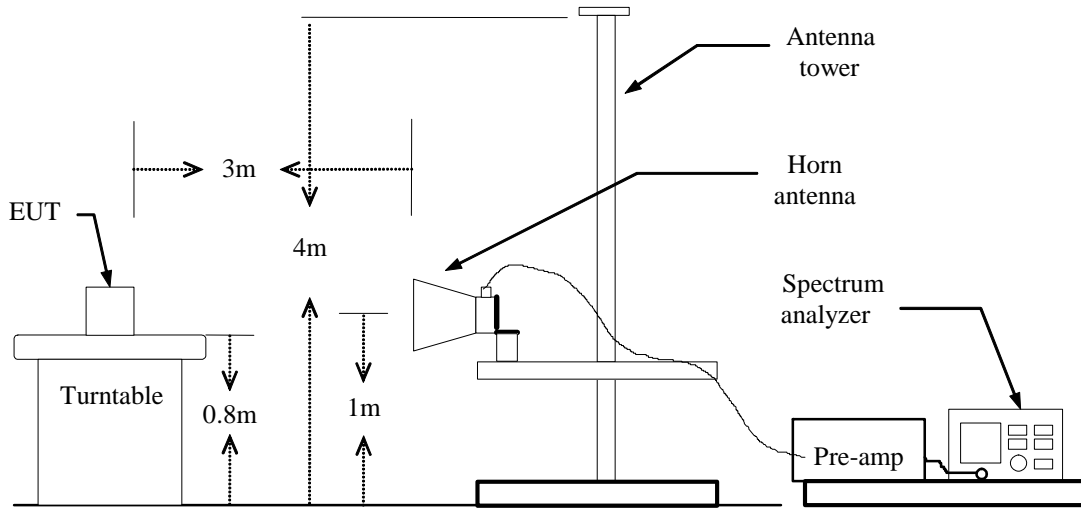



## **TEST PROCEDURE**

1. The EUT is placed on a turntable, which is 0.8m above ground plane.
2. The turntable shall be rotated for 360 degrees to determine the position of maximum emission level.
3. EUT is set 3m away from the receiving antenna, which is varied from 1m to 4m to find out the highest emissions.
4. Maximum procedure was performed on the six highest emissions to ensure EUT compliance.
5. And also, each emission was to be maximized by changing the polarization of receiving antenna both horizontal and vertical.
6. Set the spectrum analyzer in the following setting as:  
Below 1GHz:  
RBW=100kHz / VBW=300kHz / Sweep=AUTO  
Above 1GHz:  
(a) PEAK: RBW=VBW=1MHz / Sweep=AUTO  
(b) AVERAGE: RBW=1MHz / VBW=10Hz / Sweep=AUTO
7. Repeat above procedures until the measurements for all frequencies are complete.

**Below 1 GHz**

**Operation Mode:** Normal Link      **Test Date:** July 26, 2013  
**Temperature:** 27°C      **Tested by:** Rex Huang  
**Humidity:** 53% RH      **Polarity:** Ver. / Hor.

| Frequency (MHz) | Reading (dBuV) | Correction Factor (dB/m) | Result (dBuV/m) | Limit (dBuV/m) | Margin (dB) | Remark | Ant.Pol. (H/V) |
|-----------------|----------------|--------------------------|-----------------|----------------|-------------|--------|----------------|
| 72.0333         | 69.96          | -33.47                   | 36.49           | 40.00          | -3.51       | Peak   | V              |
| 96.2833         | 73.04          | -32.61                   | 40.43           | 43.50          | -3.07       | Peak   | V              |
| 120.5333        | 68.41          | -28.26                   | 40.15           | 43.50          | -3.35       | Peak   | V              |
| 144.7833        | 68.56          | -28.77                   | 39.79           | 43.50          | -3.71       | Peak   | V              |
| 191.6667        | 69.85          | -29.37                   | 40.48           | 43.50          | -3.02       | Peak   | V              |
| 666.9667        | 63.71          | -20.59                   | 43.12           | 46.00          | -2.88       | Peak   | V              |
| 107.6000        | 70.43          | -30.39                   | 40.04           | 43.50          | -3.46       | Peak   | H              |
| 167.4167        | 69.51          | -29.67                   | 39.84           | 43.50          | -3.66       | Peak   | H              |
| 204.6000        | 69.44          | -29.01                   | 40.43           | 43.50          | -3.07       | Peak   | H              |
| 227.2333        | 72.80          | -30.02                   | 42.78           | 46.00          | -3.22       | Peak   | H              |
| 335.5500        | 68.44          | -26.90                   | 41.54           | 46.00          | -4.46       | Peak   | H              |
| 663.7333        | 63.35          | -20.61                   | 42.74           | 46.00          | -3.26       | Peak   | H              |

**Remark:**

1. No emission found between lowest internal used/generated frequency to 30MHz (9kHz~30MHz).
2. Radiated emissions measured in frequency range from 30 MHz to 1000MHz were made with an instrument using peak/quasi-peak detector mode.
3. Quasi-peak test would be performed if the peak result were greater than the quasi-peak limit or as required by the applicant.
4. Measurements above show only up to 6 maximum emissions noted, or would be lesser, with " N/A " remark, if no specific emissions from the EUT are recorded (ie: margin>20dB from the applicable limit) and considered that's already beyond the background noise floor.
5. Margin (dB) = Remark result (dBuV/m) – Quasi-peak limit (dBuV/m).



**Above 1 GHz**

**Operation Mode:** TX / IEEE 802.11b mode / CH Low

**Test Date:** August 26, 2013

**Temperature:** 27°C

**Tested by:** Rex Huang

**Humidity:** 53 % RH

**Polarity:** Ver. / Hor.

| Frequency (MHz) | Reading (dBuV) | Correction Factor (dB/m) | Result (dBuV/m) | Limit (dBuV/m) | Margin (dB) | Remark | Ant.Pol. (H/V) |
|-----------------|----------------|--------------------------|-----------------|----------------|-------------|--------|----------------|
| 2306.667        | 52.13          | -0.19                    | 51.94           | 74.00          | -22.06      | peak   | V              |
| 4825.000        | 43.06          | 5.42                     | 48.48           | 74.00          | -25.52      | peak   | V              |
| N/A             |                |                          |                 |                |             |        |                |
|                 |                |                          |                 |                |             |        |                |
|                 |                |                          |                 |                |             |        |                |
|                 |                |                          |                 |                |             |        |                |
| 2273.333        | 51.80          | -0.29                    | 51.51           | 74.00          | -22.49      | peak   | H              |
| 4825.000        | 47.09          | 5.42                     | 52.51           | 74.00          | -21.49      | peak   | H              |
| 4825.000        | 45.77          | 5.42                     | 51.19           | 54.00          | -2.81       | AVG    | H              |
| N/A             |                |                          |                 |                |             |        |                |
|                 |                |                          |                 |                |             |        |                |
|                 |                |                          |                 |                |             |        |                |

**Remark:**

1. Measuring frequencies from 1 GHz to the 10th harmonic of highest fundamental frequency.
2. Radiated emissions measured in frequency above 1000MHz were made with an instrument using peak/average detector mode.
3. Average test would be performed if the peak result were greater than the average limit.
4. Data of measurement within this frequency range shown “ --- ” in the table above means the reading of emissions are attenuated more than 20dB below the permissible limits or the field strength is too small to be measured.
5. Measurements above show only up to 6 maximum emissions noted, or would be lesser, with “ N/A ” remark, if no specific emissions from the EUT are recorded (ie: margin>20dB from the applicable limit) and considered that's already beyond the background noise floor.
6. Margin (dB) = Remark result (dBuV/m) – Average limit (dBuV/m).





Operation Mode: TX / IEEE 802.11b mode / CH Mid

Test Date: August 26, 2013

Temperature: 27°C

Tested by: Rex Huang

Humidity: 53 % RH

Polarity: Ver. / Hor.

| Frequency (MHz) | Reading (dBuV) | Correction Factor (dB/m) | Result (dBuV/m) | Limit (dBuV/m) | Margin (dB) | Remark | Ant.Pol. (H/V) |
|-----------------|----------------|--------------------------|-----------------|----------------|-------------|--------|----------------|
| 2356.667        | 54.87          | -0.65                    | 54.22           | 74.00          | -19.78      | peak   | V              |
| 2356.667        | 49.42          | -0.65                    | 48.77           | 54.00          | -5.23       | AVG    | V              |
| 4875.000        | 43.44          | 5.48                     | 48.92           | 74.00          | -25.08      | peak   | V              |
| N/A             |                |                          |                 |                |             |        | V              |
|                 |                |                          |                 |                |             |        | V              |
|                 |                |                          |                 |                |             |        | V              |
| 2340.000        | 52.69          | -0.71                    | 51.98           | 74.00          | -22.02      | peak   | H              |
| 4875.000        | 47.19          | 5.48                     | 52.67           | 74.00          | -21.33      | peak   | H              |
| 4875.000        | 45.78          | 5.48                     | 51.26           | 54.00          | -2.74       | AVG    | H              |
| N/A             |                |                          |                 |                |             |        | H              |
|                 |                |                          |                 |                |             |        | H              |
|                 |                |                          |                 |                |             |        | H              |

**Remark:**

1. Measuring frequencies from 1 GHz to the 10th harmonic of highest fundamental frequency.
2. Radiated emissions measured in frequency above 1000MHz were made with an instrument using peak/average detector mode.
3. Average test would be performed if the peak result were greater than the average limit.
4. Data of measurement within this frequency range shown “ --- ” in the table above means the reading of emissions are attenuated more than 20dB below the permissible limits or the field strength is too small to be measured.
5. Measurements above show only up to 6 maximum emissions noted, or would be lesser, with “ N/A ” remark, if no specific emissions from the EUT are recorded (ie: margin>20dB from the applicable limit) and considered that's already beyond the background noise floor.
6.  $Margin (dB) = Remark\ result (dBuV/m) - Average\ limit (dBuV/m)$ .



Operation Mode: TX / IEEE 802.11b mode / CH High

Test Date: August 26, 2013

Temperature: 27°C

Tested by: Rex Huang

Humidity: 53 % RH

Polarity: Ver. / Hor.

| Frequency (MHz) | Reading (dBuV) | Correction Factor (dB/m) | Result (dBuV/m) | Limit (dBuV/m) | Margin (dB) | Remark | Ant.Pol. (H/V) |
|-----------------|----------------|--------------------------|-----------------|----------------|-------------|--------|----------------|
| 2356.667        | 51.92          | -0.11                    | 51.81           | 74.00          | -22.19      | peak   | V              |
| 4925.000        | 45.21          | 5.54                     | 50.75           | 74.00          | -23.25      | peak   | V              |
| N/A             |                |                          |                 |                |             |        |                |
|                 |                |                          |                 |                |             |        |                |
|                 |                |                          |                 |                |             |        |                |
|                 |                |                          |                 |                |             |        |                |
| 2306.667        | 51.80          | -0.19                    | 51.61           | 74.00          | -22.39      | peak   | H              |
| 4925.000        | 45.45          | 5.54                     | 50.99           | 74.00          | -23.01      | peak   | H              |
| N/A             |                |                          |                 |                |             |        |                |
|                 |                |                          |                 |                |             |        |                |
|                 |                |                          |                 |                |             |        |                |
|                 |                |                          |                 |                |             |        |                |

Remark:

1. Measuring frequencies from 1 GHz to the 10th harmonic of highest fundamental frequency.
2. Radiated emissions measured in frequency above 1000MHz were made with an instrument using peak/average detector mode.
3. Average test would be performed if the peak result were greater than the average limit.
4. Data of measurement within this frequency range shown “ --- ” in the table above means the reading of emissions are attenuated more than 20dB below the permissible limits or the field strength is too small to be measured.
5. Measurements above show only up to 6 maximum emissions noted, or would be lesser, with “ N/A ” remark, if no specific emissions from the EUT are recorded (ie: margin>20dB from the applicable limit) and considered that's already beyond the background noise floor.
6.  $Margin (dB) = Remark\ result (dBuV/m) - Average\ limit (dBuV/m)$ .



Operation Mode: TX / IEEE 802.11g mode / CH Low

Test Date: August 26, 2013

Temperature: 27°C

Tested by: Rex Huang

Humidity: 53 % RH

Polarity: Ver. / Hor.

| Frequency (MHz) | Reading (dBuV) | Correction Factor (dB/m) | Result (dBuV/m) | Limit (dBuV/m) | Margin (dB) | Remark | Ant.Pol. (H/V) |
|-----------------|----------------|--------------------------|-----------------|----------------|-------------|--------|----------------|
| 2213.333        | 51.69          | -0.48                    | 51.21           | 74.00          | -22.79      | peak   | V              |
| 4825.000        | 43.78          | 6.12                     | 49.90           | 74.00          | -24.10      | peak   | V              |
| N/A             |                |                          |                 |                |             |        |                |
|                 |                |                          |                 |                |             |        |                |
|                 |                |                          |                 |                |             |        |                |
|                 |                |                          |                 |                |             |        |                |
| 2140.000        | 51.87          | -0.72                    | 51.15           | 74.00          | -22.85      | peak   | H              |
| N/A             |                |                          |                 |                |             |        |                |
|                 |                |                          |                 |                |             |        |                |
|                 |                |                          |                 |                |             |        |                |
|                 |                |                          |                 |                |             |        |                |
|                 |                |                          |                 |                |             |        |                |

Remark:

1. Measuring frequencies from 1 GHz to the 10th harmonic of highest fundamental frequency.
2. Radiated emissions measured in frequency above 1000MHz were made with an instrument using peak/average detector mode.
3. Average test would be performed if the peak result were greater than the average limit.
4. Data of measurement within this frequency range shown “ --- ” in the table above means the reading of emissions are attenuated more than 20dB below the permissible limits or the field strength is too small to be measured.
5. Measurements above show only up to 6 maximum emissions noted, or would be lesser, with “ N/A ” remark, if no specific emissions from the EUT are recorded (ie: margin>20dB from the applicable limit) and considered that's already beyond the background noise floor.
6. Margin (dB) = Remark result (dBuV/m) – Average limit (dBuV/m).



Operation Mode: TX / IEEE 802.11g mode / CH Mid

Test Date: August 26, 2013

Temperature: 27°C

Tested by: Rex Huang

Humidity: 53 % RH

Polarity: Ver. / Hor.

| Frequency (MHz) | Reading (dBuV) | Correction Factor (dB/m) | Result (dBuV/m) | Limit (dBuV/m) | Margin (dB) | Remark | Ant.Pol. (H/V) |
|-----------------|----------------|--------------------------|-----------------|----------------|-------------|--------|----------------|
| 2363.333        | 54.45          | -0.62                    | 53.83           | 74.00          | -20.17      | peak   | V              |
| 2363.333        | 46.24          | -0.62                    | 45.62           | 54.00          | -8.38       | AVG    | V              |
| 2493.333        | 55.83          | -0.13                    | 55.70           | 74.00          | -18.30      | peak   | V              |
| 2493.333        | 45.85          | -0.13                    | 45.72           | 54.00          | -8.28       | AVG    | V              |
| 4866.667        | 42.28          | 5.47                     | 47.75           | 74.00          | -26.25      | peak   | V              |
| 7308.333        | 42.11          | 9.76                     | 51.87           | 74.00          | -22.13      | peak   | V              |
| 2363.333        | 53.17          | -0.62                    | 52.55           | 74.00          | -21.45      | peak   | H              |
| 2363.333        | 45.36          | -0.62                    | 44.74           | 54.00          | -9.26       | AVG    | H              |
| 2520.000        | 53.56          | -0.04                    | 53.52           | 74.00          | -20.48      | peak   | H              |
| 2520.000        | 45.96          | -0.04                    | 45.92           | 54.00          | -8.08       | AVG    | H              |
| 4866.667        | 43.56          | 5.47                     | 49.03           | 74.00          | -24.97      | peak   | H              |
| N/A             |                |                          |                 |                |             |        |                |

**Remark:**

1. Measuring frequencies from 1 GHz to the 10th harmonic of highest fundamental frequency.
2. Radiated emissions measured in frequency above 1000MHz were made with an instrument using peak/average detector mode.
3. Average test would be performed if the peak result were greater than the average limit.
4. Data of measurement within this frequency range shown “ --- ” in the table above means the reading of emissions are attenuated more than 20dB below the permissible limits or the field strength is too small to be measured.
5. Measurements above show only up to 6 maximum emissions noted, or would be lesser, with “ N/A ” remark, if no specific emissions from the EUT are recorded (ie: margin>20dB from the applicable limit) and considered that's already beyond the background noise floor.
6.  $Margin (dB) = Remark\ result (dBuV/m) - Average\ limit (dBuV/m)$ .



Operation Mode: TX / IEEE 802.11g mode / CH High

Test Date: August 26, 2013

Temperature: 27°C

Tested by: Rex Huang

Humidity: 53 % RH

Polarity: Ver. / Hor.

| Frequency (MHz) | Reading (dBuV) | Correction Factor (dB/m) | Result (dBuV/m) | Limit (dBuV/m) | Margin (dB) | Remark | Ant.Pol. (H/V) |
|-----------------|----------------|--------------------------|-----------------|----------------|-------------|--------|----------------|
| 2300.000        | 52.12          | -0.20                    | 51.92           | 74.00          | -22.08      | peak   | V              |
| N/A             |                |                          |                 |                |             |        |                |
|                 |                |                          |                 |                |             |        |                |
|                 |                |                          |                 |                |             |        |                |
|                 |                |                          |                 |                |             |        |                |
|                 |                |                          |                 |                |             |        |                |
| 2250.000        | 52.03          | -0.36                    | 51.67           | 74.00          | -22.33      | peak   | H              |
| N/A             |                |                          |                 |                |             |        |                |
|                 |                |                          |                 |                |             |        |                |
|                 |                |                          |                 |                |             |        |                |
|                 |                |                          |                 |                |             |        |                |
|                 |                |                          |                 |                |             |        |                |

**Remark:**

1. Measuring frequencies from 1 GHz to the 10th harmonic of highest fundamental frequency.
2. Radiated emissions measured in frequency above 1000MHz were made with an instrument using peak/average detector mode.
3. Average test would be performed if the peak result were greater than the average limit.
4. Data of measurement within this frequency range shown “ --- ” in the table above means the reading of emissions are attenuated more than 20dB below the permissible limits or the field strength is too small to be measured.
5. Measurements above show only up to 6 maximum emissions noted, or would be lesser, with “ N/A ” remark, if no specific emissions from the EUT are recorded (ie: margin>20dB from the applicable limit) and considered that's already beyond the background noise floor.
6.  $Margin (dB) = Remark\ result (dBuV/m) - Average\ limit (dBuV/m)$ .



Operation Mode: TX / IEEE 802.11n HT 20 MHz mode / CH Low

Test Date: August 26, 2013

Temperature: 27°C

Tested by: Rex Huang

Humidity: 53 % RH

Polarity: Ver. / Hor.

| Frequency (MHz) | Reading (dBuV) | Correction Factor (dB/m) | Result (dBuV/m) | Limit (dBuV/m) | Margin (dB) | Remark | Ant.Pol. (H/V) |
|-----------------|----------------|--------------------------|-----------------|----------------|-------------|--------|----------------|
| 2220.000        | 51.72          | -0.46                    | 51.26           | 74.00          | -22.74      | peak   | V              |
| 4825.000        | 46.27          | 6.12                     | 52.39           | 74.00          | -21.61      | peak   | V              |
| 4825.000        | 36.87          | 6.12                     | 42.99           | 54.00          | -11.01      | AVG    | V              |
| N/A             |                |                          |                 |                |             |        |                |
|                 |                |                          |                 |                |             |        |                |
|                 |                |                          |                 |                |             |        |                |
| 2190.000        | 52.30          | -0.56                    | 51.74           | 74.00          | -22.26      | peak   | H              |
| N/A             |                |                          |                 |                |             |        |                |
|                 |                |                          |                 |                |             |        |                |
|                 |                |                          |                 |                |             |        |                |
|                 |                |                          |                 |                |             |        |                |
|                 |                |                          |                 |                |             |        |                |

Remark:

1. Measuring frequencies from 1 GHz to the 10th harmonic of highest fundamental frequency.
2. Radiated emissions measured in frequency above 1000MHz were made with an instrument using peak/average detector mode.
3. Average test would be performed if the peak result were greater than the average limit or as required by the applicant.
4. Data of measurement within this frequency range shown " --- " in the table above means the reading of emissions are attenuated more than 20dB below the permissible limits or the field strength is too small to be measured.
5. Measurements above show only up to 6 maximum emissions noted, or would be lesser, with " N/A " remark, if no specific emissions from the EUT are recorded (ie: margin > 20dB from the applicable limit) and considered that's already beyond the background noise floor.
6. Margin (dB) = Remark result (dBuV/m) – Average limit (dBuV/m).



Operation Mode: TX / IEEE 802.11n HT 20 MHz mode / CH Mid

Test Date: August 26, 2013

Temperature: 27°C

Tested by: Rex Huang

Humidity: 53 % RH

Polarity: Ver. / Hor.

| Frequency (MHz) | Reading (dBuV) | Correction Factor (dB/m) | Result (dBuV/m) | Limit (dBuV/m) | Margin (dB) | Remark | Ant.Pol. (H/V) |
|-----------------|----------------|--------------------------|-----------------|----------------|-------------|--------|----------------|
| 2363.333        | 54.75          | -0.62                    | 54.13           | 74.00          | -19.87      | peak   | V              |
| 2363.333        | 44.19          | -0.62                    | 43.57           | 54.00          | -10.43      | AVG    | V              |
| 4875.000        | 43.13          | 5.48                     | 48.61           | 74.00          | -25.39      | peak   | V              |
| N/A             |                |                          |                 |                |             |        |                |
|                 |                |                          |                 |                |             |        |                |
|                 |                |                          |                 |                |             |        |                |
| 2356.667        | 52.86          | -0.65                    | 52.21           | 74.00          | -21.79      | peak   | H              |
| 2356.667        | 45.57          | -0.65                    | 44.92           | 54.00          | -9.08       | AVG    | H              |
| 4875.000        | 45.37          | 5.48                     | 50.85           | 74.00          | -23.15      | peak   | H              |
| N/A             |                |                          |                 |                |             |        |                |
|                 |                |                          |                 |                |             |        |                |
|                 |                |                          |                 |                |             |        |                |

Remark:

1. Measuring frequencies from 1 GHz to the 10th harmonic of highest fundamental frequency.
2. Radiated emissions measured in frequency above 1000MHz were made with an instrument using peak/average detector mode.
3. Average test would be performed if the peak result were greater than the average limit or as required by the applicant.
4. Data of measurement within this frequency range shown “ --- ” in the table above means the reading of emissions are attenuated more than 20dB below the permissible limits or the field strength is too small to be measured.
5. Measurements above show only up to 6 maximum emissions noted, or would be lesser, with “ N/A ” remark, if no specific emissions from the EUT are recorded (ie: margin>20dB from the applicable limit) and considered that's already beyond the background noise floor.
6. Margin (dB) = Remark result (dBuV/m) – Average limit (dBuV/m).



Operation Mode: TX / IEEE 802.11n HT 20 MHz mode / CH High

Test Date: August 26, 2013

Temperature: 27°C

Tested by: Rex Huang

Humidity: 53 % RH

Polarity: Ver. / Hor.

| Frequency (MHz) | Reading (dBuV) | Correction Factor (dB/m) | Result (dBuV/m) | Limit (dBuV/m) | Margin (dB) | Remark | Ant.Pol. (H/V) |
|-----------------|----------------|--------------------------|-----------------|----------------|-------------|--------|----------------|
| 2233.333        | 51.71          | -0.42                    | 51.29           | 74.00          | -22.71      | peak   | V              |
| N/A             |                |                          |                 |                |             |        |                |
|                 |                |                          |                 |                |             |        |                |
|                 |                |                          |                 |                |             |        |                |
|                 |                |                          |                 |                |             |        |                |
|                 |                |                          |                 |                |             |        |                |
| 2270.000        | 52.17          | -0.30                    | 51.87           | 74.00          | -22.13      | peak   | H              |
| N/A             |                |                          |                 |                |             |        |                |
|                 |                |                          |                 |                |             |        |                |
|                 |                |                          |                 |                |             |        |                |
|                 |                |                          |                 |                |             |        |                |
|                 |                |                          |                 |                |             |        |                |

Remark:

1. Measuring frequencies from 1 GHz to the 10th harmonic of highest fundamental frequency.
2. Radiated emissions measured in frequency above 1000MHz were made with an instrument using peak/average detector mode.
3. Average test would be performed if the peak result were greater than the average limit or as required by the applicant.
4. Data of measurement within this frequency range shown “ --- ” in the table above means the reading of emissions are attenuated more than 20dB below the permissible limits or the field strength is too small to be measured.
5. Measurements above show only up to 6 maximum emissions noted, or would be lesser, with “ N/A ” remark, if no specific emissions from the EUT are recorded (ie: margin>20dB from the applicable limit) and considered that's already beyond the background noise floor.
6. Margin (dB) = Remark result (dBuV/m) – Average limit (dBuV/m).





Operation Mode: TX / IEEE 802.11n HT 40 MHz mode / CH Low

Test Date: August 26, 2013

Temperature: 27°C

Tested by: Rex Huang

Humidity: 53 % RH

Polarity: Ver. / Hor.

| Frequency (MHz) | Reading (dBuV) | Correction Factor (dB/m) | Result (dBuV/m) | Limit (dBuV/m) | Margin (dB) | Remark | Ant.Pol. (H/V) |
|-----------------|----------------|--------------------------|-----------------|----------------|-------------|--------|----------------|
| 2313.333        | 52.11          | -0.18                    | 51.93           | 74.00          | -22.07      | peak   | V              |
| N/A             |                |                          |                 |                |             |        |                |
|                 |                |                          |                 |                |             |        |                |
|                 |                |                          |                 |                |             |        |                |
|                 |                |                          |                 |                |             |        |                |
|                 |                |                          |                 |                |             |        |                |
| 2200.000        | 52.14          | -0.53                    | 51.61           | 74.00          | -22.39      | peak   | H              |
| N/A             |                |                          |                 |                |             |        |                |
|                 |                |                          |                 |                |             |        |                |
|                 |                |                          |                 |                |             |        |                |
|                 |                |                          |                 |                |             |        |                |
|                 |                |                          |                 |                |             |        |                |

Remark:

1. Measuring frequencies from 1 GHz to the 10th harmonic of highest fundamental frequency.
2. Radiated emissions measured in frequency above 1000MHz were made with an instrument using peak/average detector mode.
3. Average test would be performed if the peak result were greater than the average limit or as required by the applicant.
4. Data of measurement within this frequency range shown “ --- ” in the table above means the reading of emissions are attenuated more than 20dB below the permissible limits or the field strength is too small to be measured.
5. Measurements above show only up to 6 maximum emissions noted, or would be lesser, with “ N/A ” remark, if no specific emissions from the EUT are recorded (ie: margin>20dB from the applicable limit) and considered that's already beyond the background noise floor.
6. Margin (dB) = Remark result (dBuV/m) – Average limit (dBuV/m).



Operation Mode: TX / IEEE 802.11n HT 40 MHz mode / CH Mid

Test Date: August 26, 2013

Temperature: 27°C

Tested by: Rex Huang

Humidity: 53 % RH

Polarity: Ver. / Hor.

| Frequency (MHz) | Reading (dBuV) | Correction Factor (dB/m) | Result (dBuV/m) | Limit (dBuV/m) | Margin (dB) | Remark | Ant.Pol. (H/V) |
|-----------------|----------------|--------------------------|-----------------|----------------|-------------|--------|----------------|
| 2233.333        | 52.38          | -0.98                    | 51.40           | 74.00          | -22.60      | peak   | V              |
| N/A             |                |                          |                 |                |             |        |                |
|                 |                |                          |                 |                |             |        |                |
|                 |                |                          |                 |                |             |        |                |
|                 |                |                          |                 |                |             |        |                |
|                 |                |                          |                 |                |             |        |                |
| 2276.667        | 52.82          | -0.90                    | 51.92           | 74.00          | -22.08      | peak   | H              |
| 4875.000        | 42.03          | 5.48                     | 47.51           | 74.00          | -26.49      | peak   | H              |
| N/A             |                |                          |                 |                |             |        |                |
|                 |                |                          |                 |                |             |        |                |
|                 |                |                          |                 |                |             |        |                |
|                 |                |                          |                 |                |             |        |                |

Remark:

1. Measuring frequencies from 1 GHz to the 10th harmonic of highest fundamental frequency.
2. Radiated emissions measured in frequency above 1000MHz were made with an instrument using peak/average detector mode.
3. Average test would be performed if the peak result were greater than the average limit or as required by the applicant.
4. Data of measurement within this frequency range shown “ --- ” in the table above means the reading of emissions are attenuated more than 20dB below the permissible limits or the field strength is too small to be measured.
5. Measurements above show only up to 6 maximum emissions noted, or would be lesser, with “ N/A ” remark, if no specific emissions from the EUT are recorded (ie: margin>20dB from the applicable limit) and considered that's already beyond the background noise floor.
6. Margin (dB) = Remark result (dBuV/m) – Average limit (dBuV/m).



Operation Mode: TX / IEEE 802.11n HT 40 MHz mode / CH High

Test Date: August 26, 2013

Temperature: 27°C

Tested by: Rex Huang

Humidity: 53 % RH

Polarity: Ver. / Hor.

| Frequency (MHz) | Reading (dBuV) | Correction Factor (dB/m) | Result (dBuV/m) | Limit (dBuV/m) | Margin (dB) | Remark | Ant.Pol. (H/V) |
|-----------------|----------------|--------------------------|-----------------|----------------|-------------|--------|----------------|
| 2296.667        | 51.80          | -0.21                    | 51.59           | 74.00          | -22.41      | peak   | V              |
| N/A             |                |                          |                 |                |             |        |                |
|                 |                |                          |                 |                |             |        |                |
|                 |                |                          |                 |                |             |        |                |
|                 |                |                          |                 |                |             |        |                |
|                 |                |                          |                 |                |             |        |                |
| 2213.333        | 52.06          | -0.48                    | 51.58           | 74.00          | -22.42      | peak   | H              |
| N/A             |                |                          |                 |                |             |        |                |
|                 |                |                          |                 |                |             |        |                |
|                 |                |                          |                 |                |             |        |                |
|                 |                |                          |                 |                |             |        |                |
|                 |                |                          |                 |                |             |        |                |

Remark:

1. Measuring frequencies from 1 GHz to the 10th harmonic of highest fundamental frequency.
2. Radiated emissions measured in frequency above 1000MHz were made with an instrument using peak/average detector mode.
3. Average test would be performed if the peak result were greater than the average limit or as required by the applicant.
4. Data of measurement within this frequency range shown “ --- ” in the table above means the reading of emissions are attenuated more than 20dB below the permissible limits or the field strength is too small to be measured.
5. Measurements above show only up to 6 maximum emissions noted, or would be lesser, with “ N/A ” remark, if no specific emissions from the EUT are recorded (ie: margin>20dB from the applicable limit) and considered that's already beyond the background noise floor.
6. Margin (dB) = Remark result (dBuV/m) – Average limit (dBuV/m).



Operation Mode: TX / IEEE 802.11a mode / CH Low

Test Date: August 26, 2013

Temperature: 27°C

Tested by: Rex Huang

Humidity: 53 % RH

Polarity: Ver. / Hor.

| Frequency (MHz) | Reading (dBuV) | Correction Factor (dB/m) | Result (dBuV/m) | Limit (dBuV/m) | Margin (dB) | Remark | Ant.Pol. (H/V) |
|-----------------|----------------|--------------------------|-----------------|----------------|-------------|--------|----------------|
| 2878.333        | 50.89          | 0.96                     | 51.85           | 74.00          | -22.15      | peak   | V              |
| N/A             |                |                          |                 |                |             |        |                |
|                 |                |                          |                 |                |             |        |                |
|                 |                |                          |                 |                |             |        |                |
|                 |                |                          |                 |                |             |        |                |
|                 |                |                          |                 |                |             |        |                |
| 2738.333        | 50.95          | 0.57                     | 51.52           | 74.00          | -22.48      | peak   | H              |
| N/A             |                |                          |                 |                |             |        |                |
|                 |                |                          |                 |                |             |        |                |
|                 |                |                          |                 |                |             |        |                |
|                 |                |                          |                 |                |             |        |                |
|                 |                |                          |                 |                |             |        |                |

**Remark:**

1. Measuring frequencies from 1 GHz to the 10th harmonic of highest fundamental frequency.
2. Radiated emissions measured in frequency above 1000MHz were made with an instrument using peak/average detector mode.
3. Average test would be performed if the peak result were greater than the average limit.
4. Data of measurement within this frequency range shown “ --- ” in the table above means the reading of emissions are attenuated more than 20dB below the permissible limits or the field strength is too small to be measured.
5. Measurements above show only up to 6 maximum emissions noted, or would be lesser, with “ N/A ” remark, if no specific emissions from the EUT are recorded (ie: margin>20dB from the applicable limit) and considered that's already beyond the background noise floor.
6.  $Margin (dB) = Remark\ result (dBuV/m) - Average\ limit (dBuV/m)$ .



Operation Mode: TX / IEEE 802.11a mode / CH Mid

Test Date: August 26, 2013

Temperature: 27°C

Tested by: Rex Huang

Humidity: 53 % RH

Polarity: Ver. / Hor.

| Frequency (MHz) | Reading (dBuV) | Correction Factor (dB/m) | Result (dBuV/m) | Limit (dBuV/m) | Margin (dB) | Remark | Ant.Pol. (H/V) |
|-----------------|----------------|--------------------------|-----------------|----------------|-------------|--------|----------------|
| 2750.000        | 50.75          | 0.60                     | 51.35           | 74.00          | -22.65      | peak   | V              |
| N/A             |                |                          |                 |                |             |        |                |
|                 |                |                          |                 |                |             |        |                |
|                 |                |                          |                 |                |             |        |                |
|                 |                |                          |                 |                |             |        |                |
|                 |                |                          |                 |                |             |        |                |
| 2761.667        | 51.31          | 0.63                     | 51.94           | 74.00          | -22.06      | peak   | H              |
| N/A             |                |                          |                 |                |             |        |                |
|                 |                |                          |                 |                |             |        |                |
|                 |                |                          |                 |                |             |        |                |
|                 |                |                          |                 |                |             |        |                |
|                 |                |                          |                 |                |             |        |                |

**Remark:**

1. Measuring frequencies from 1 GHz to the 10th harmonic of highest fundamental frequency.
2. Radiated emissions measured in frequency above 1000MHz were made with an instrument using peak/average detector mode.
3. Average test would be performed if the peak result were greater than the average limit.
4. Data of measurement within this frequency range shown “ --- ” in the table above means the reading of emissions are attenuated more than 20dB below the permissible limits or the field strength is too small to be measured.
5. Measurements above show only up to 6 maximum emissions noted, or would be lesser, with “ N/A ” remark, if no specific emissions from the EUT are recorded (ie: margin>20dB from the applicable limit) and considered that's already beyond the background noise floor.
6.  $Margin (dB) = Remark\ result (dBuV/m) - Average\ limit (dBuV/m)$ .



Operation Mode: TX / IEEE 802.11a mode / CH High

Test Date: August 26, 2013

Temperature: 27°C

Tested by: Rex Huang

Humidity: 53 % RH

Polarity: Ver. / Hor.

| Frequency (MHz) | Reading (dBuV) | Correction Factor (dB/m) | Result (dBuV/m) | Limit (dBuV/m) | Margin (dB) | Remark | Ant.Pol. (H/V) |
|-----------------|----------------|--------------------------|-----------------|----------------|-------------|--------|----------------|
| 2691.667        | 51.22          | 0.44                     | 51.66           | 74.00          | -22.34      | peak   | V              |
| N/A             |                |                          |                 |                |             |        |                |
|                 |                |                          |                 |                |             |        |                |
|                 |                |                          |                 |                |             |        |                |
|                 |                |                          |                 |                |             |        |                |
|                 |                |                          |                 |                |             |        |                |
| 2936.667        | 50.66          | 1.12                     | 51.78           | 74.00          | -22.22      | peak   | H              |
| 11650.000       | 39.95          | 15.14                    | 55.09           | 74.00          | -18.91      | peak   | H              |
| 11650.000       | 33.44          | 15.14                    | 48.58           | 54.00          | -5.42       | AVG    | H              |
| N/A             |                |                          |                 |                |             |        |                |
|                 |                |                          |                 |                |             |        |                |
|                 |                |                          |                 |                |             |        |                |

**Remark:**

1. Measuring frequencies from 1 GHz to the 10th harmonic of highest fundamental frequency.
2. Radiated emissions measured in frequency above 1000MHz were made with an instrument using peak/average detector mode.
3. Average test would be performed if the peak result were greater than the average limit.
4. Data of measurement within this frequency range shown “ --- ” in the table above means the reading of emissions are attenuated more than 20dB below the permissible limits or the field strength is too small to be measured.
5. Measurements above show only up to 6 maximum emissions noted, or would be lesser, with “ N/A ” remark, if no specific emissions from the EUT are recorded (ie: margin>20dB from the applicable limit) and considered that's already beyond the background noise floor.
6.  $Margin (dB) = Remark\ result (dBuV/m) - Average\ limit (dBuV/m)$ .



Operation Mode: TX / IEEE 802.11n HT 20 MHz mode / CH Low

Test Date: August 26, 2013

Temperature: 27°C

Tested by: Rex Huang

Humidity: 53 % RH

Polarity: Ver. / Hor.

| Frequency (MHz) | Reading (dBuV) | Correction Factor (dB/m) | Result (dBuV/m) | Limit (dBuV/m) | Margin (dB) | Remark | Ant.Pol. (H/V) |
|-----------------|----------------|--------------------------|-----------------|----------------|-------------|--------|----------------|
| 2738.333        | 51.32          | 0.57                     | 51.89           | 74.00          | -22.11      | peak   | V              |
| N/A             |                |                          |                 |                |             |        |                |
|                 |                |                          |                 |                |             |        |                |
|                 |                |                          |                 |                |             |        |                |
|                 |                |                          |                 |                |             |        |                |
|                 |                |                          |                 |                |             |        |                |
| 2656.667        | 51.09          | 0.34                     | 51.43           | 74.00          | -22.57      | peak   | H              |
| N/A             |                |                          |                 |                |             |        |                |
|                 |                |                          |                 |                |             |        |                |
|                 |                |                          |                 |                |             |        |                |
|                 |                |                          |                 |                |             |        |                |
|                 |                |                          |                 |                |             |        |                |

Remark:

1. Measuring frequencies from 1 GHz to the 10th harmonic of highest fundamental frequency.
2. Radiated emissions measured in frequency above 1000MHz were made with an instrument using peak/average detector mode.
3. Average test would be performed if the peak result were greater than the average limit or as required by the applicant.
4. Data of measurement within this frequency range shown “ --- ” in the table above means the reading of emissions are attenuated more than 20dB below the permissible limits or the field strength is too small to be measured.
5. Measurements above show only up to 6 maximum emissions noted, or would be lesser, with “ N/A ” remark, if no specific emissions from the EUT are recorded (ie: margin>20dB from the applicable limit) and considered that's already beyond the background noise floor.
6. Margin (dB) = Remark result (dBuV/m) – Average limit (dBuV/m).



Operation Mode: TX / IEEE 802.11n HT 20 MHz mode / CH Mid

Test Date: August 26, 2013

Temperature: 27°C

Tested by: Rex Huang

Humidity: 53 % RH

Polarity: Ver. / Hor.

| Frequency (MHz) | Reading (dBuV) | Correction Factor (dB/m) | Result (dBuV/m) | Limit (dBuV/m) | Margin (dB) | Remark | Ant.Pol. (H/V) |
|-----------------|----------------|--------------------------|-----------------|----------------|-------------|--------|----------------|
| 2680.000        | 51.27          | 0.40                     | 51.67           | 74.00          | -22.33      | peak   | V              |
| N/A             |                |                          |                 |                |             |        |                |
|                 |                |                          |                 |                |             |        |                |
|                 |                |                          |                 |                |             |        |                |
|                 |                |                          |                 |                |             |        |                |
|                 |                |                          |                 |                |             |        |                |
| 2691.667        | 51.37          | 0.44                     | 51.81           | 74.00          | -22.19      | peak   | H              |
| N/A             |                |                          |                 |                |             |        |                |
|                 |                |                          |                 |                |             |        |                |
|                 |                |                          |                 |                |             |        |                |
|                 |                |                          |                 |                |             |        |                |
|                 |                |                          |                 |                |             |        |                |

Remark:

1. Measuring frequencies from 1 GHz to the 10th harmonic of highest fundamental frequency.
2. Radiated emissions measured in frequency above 1000MHz were made with an instrument using peak/average detector mode.
3. Average test would be performed if the peak result were greater than the average limit or as required by the applicant.
4. Data of measurement within this frequency range shown “ --- ” in the table above means the reading of emissions are attenuated more than 20dB below the permissible limits or the field strength is too small to be measured.
5. Measurements above show only up to 6 maximum emissions noted, or would be lesser, with “ N/A ” remark, if no specific emissions from the EUT are recorded (ie: margin>20dB from the applicable limit) and considered that's already beyond the background noise floor.
6. Margin (dB) = Remark result (dBuV/m) – Average limit (dBuV/m).





Operation Mode: TX / IEEE 802.11n HT 20 MHz mode / CH High

Test Date: August 26, 2013

Temperature: 27°C

Tested by: Rex Huang

Humidity: 53 % RH

Polarity: Ver. / Hor.

| Frequency (MHz) | Reading (dBuV) | Correction Factor (dB/m) | Result (dBuV/m) | Limit (dBuV/m) | Margin (dB) | Remark | Ant.Pol. (H/V) |
|-----------------|----------------|--------------------------|-----------------|----------------|-------------|--------|----------------|
| 2715.000        | 51.25          | 0.50                     | 51.75           | 74.00          | -22.25      | peak   | V              |
| N/A             |                |                          |                 |                |             |        |                |
|                 |                |                          |                 |                |             |        |                |
|                 |                |                          |                 |                |             |        |                |
|                 |                |                          |                 |                |             |        |                |
|                 |                |                          |                 |                |             |        |                |
| 2890.000        | 50.72          | 0.99                     | 51.71           | 74.00          | -22.29      | peak   | H              |
| N/A             |                |                          |                 |                |             |        |                |
|                 |                |                          |                 |                |             |        |                |
|                 |                |                          |                 |                |             |        |                |
|                 |                |                          |                 |                |             |        |                |
|                 |                |                          |                 |                |             |        |                |

Remark:

1. Measuring frequencies from 1 GHz to the 10th harmonic of highest fundamental frequency.
2. Radiated emissions measured in frequency above 1000MHz were made with an instrument using peak/average detector mode.
3. Average test would be performed if the peak result were greater than the average limit or as required by the applicant.
4. Data of measurement within this frequency range shown “ --- ” in the table above means the reading of emissions are attenuated more than 20dB below the permissible limits or the field strength is too small to be measured.
5. Measurements above show only up to 6 maximum emissions noted, or would be lesser, with “ N/A ” remark, if no specific emissions from the EUT are recorded (ie: margin>20dB from the applicable limit) and considered that's already beyond the background noise floor.
6. Margin (dB) = Remark result (dBuV/m) – Average limit (dBuV/m).



Operation Mode: TX / IEEE 802.11n HT 40 MHz mode / CH Low

Test Date: August 26, 2013

Temperature: 27°C

Tested by: Rex Huang

Humidity: 53 % RH

Polarity: Ver. / Hor.

| Frequency (MHz) | Reading (dBuV) | Correction Factor (dB/m) | Result (dBuV/m) | Limit (dBuV/m) | Margin (dB) | Remark | Ant.Pol. (H/V) |
|-----------------|----------------|--------------------------|-----------------|----------------|-------------|--------|----------------|
| 2831.667        | 50.82          | 0.83                     | 51.65           | 74.00          | -22.35      | peak   | V              |
| N/A             |                |                          |                 |                |             |        |                |
|                 |                |                          |                 |                |             |        |                |
|                 |                |                          |                 |                |             |        |                |
|                 |                |                          |                 |                |             |        |                |
|                 |                |                          |                 |                |             |        |                |
| 2656.667        | 51.50          | 0.34                     | 51.84           | 74.00          | -22.16      | peak   | H              |
| N/A             |                |                          |                 |                |             |        |                |
|                 |                |                          |                 |                |             |        |                |
|                 |                |                          |                 |                |             |        |                |
|                 |                |                          |                 |                |             |        |                |
|                 |                |                          |                 |                |             |        |                |

Remark:

1. Measuring frequencies from 1 GHz to the 10th harmonic of highest fundamental frequency.
2. Radiated emissions measured in frequency above 1000MHz were made with an instrument using peak/average detector mode.
3. Average test would be performed if the peak result were greater than the average limit or as required by the applicant.
4. Data of measurement within this frequency range shown “ --- ” in the table above means the reading of emissions are attenuated more than 20dB below the permissible limits or the field strength is too small to be measured.
5. Measurements above show only up to 6 maximum emissions noted, or would be lesser, with “ N/A ” remark, if no specific emissions from the EUT are recorded (ie: margin>20dB from the applicable limit) and considered that's already beyond the background noise floor.
6. Margin (dB) = Remark result (dBuV/m) – Average limit (dBuV/m).



Operation Mode: TX / IEEE 802.11n HT 40 MHz mode / CH High

Test Date: August 26, 2013

Temperature: 27°C

Tested by: Rex Huang

Humidity: 53 % RH

Polarity: Ver. / Hor.

| Frequency (MHz) | Reading (dBuV) | Correction Factor (dB/m) | Result (dBuV/m) | Limit (dBuV/m) | Margin (dB) | Remark | Ant.Pol. (H/V) |
|-----------------|----------------|--------------------------|-----------------|----------------|-------------|--------|----------------|
| 2925.000        | 50.72          | 1.09                     | 51.81           | 74.00          | -22.19      | peak   | V              |
| N/A             |                |                          |                 |                |             |        |                |
|                 |                |                          |                 |                |             |        |                |
|                 |                |                          |                 |                |             |        |                |
|                 |                |                          |                 |                |             |        |                |
|                 |                |                          |                 |                |             |        |                |
| 2691.667        | 51.18          | 0.44                     | 51.62           | 74.00          | -22.38      | peak   | H              |
| N/A             |                |                          |                 |                |             |        |                |
|                 |                |                          |                 |                |             |        |                |
|                 |                |                          |                 |                |             |        |                |
|                 |                |                          |                 |                |             |        |                |
|                 |                |                          |                 |                |             |        |                |

Remark:

1. Measuring frequencies from 1 GHz to the 10th harmonic of highest fundamental frequency.
2. Radiated emissions measured in frequency above 1000MHz were made with an instrument using peak/average detector mode.
3. Average test would be performed if the peak result were greater than the average limit or as required by the applicant.
4. Data of measurement within this frequency range shown “ --- ” in the table above means the reading of emissions are attenuated more than 20dB below the permissible limits or the field strength is too small to be measured.
5. Measurements above show only up to 6 maximum emissions noted, or would be lesser, with “ N/A ” remark, if no specific emissions from the EUT are recorded (ie: margin>20dB from the applicable limit) and considered that's already beyond the background noise floor.
6. Margin (dB) = Remark result (dBuV/m) – Average limit (dBuV/m).



## 8.8 POWERLINE CONDUCTED EMISSIONS

### LIMIT

According to §15.207(a) & RSS-Gen §7.2.4, except when the requirements applicable to a given device state otherwise, for any licence-exempt radiocommunication device equipped to operate from the public utility AC power supply, either directly or indirectly, the radio frequency voltage that is conducted back onto the AC power lines in the frequency range of 0.15 MHz to 30 MHz shall not exceed the limits shown in Table 2. The tighter limit applies at the frequency range boundaries.

The conducted emissions shall be measured with a 50 ohm/50 microhenry line impedance stabilization network.

### RSS-Gen Table 2 – AC Power Lines Conducted Emission Limits

| Frequency Range (MHz) | Conducted limit (dBµV) |           |
|-----------------------|------------------------|-----------|
|                       | Quasi-peak             | Average   |
| 0.15 to 0.5           | 66 to 56*              | 56 to 46* |
| 0.5 to 5              | 56                     | 46        |
| 5 to 30               | 60                     | 50        |

*\*Decreases with the logarithm of the frequency*

### Test Configuration

See test photographs attached in Appendix 1 for the actual connections between EUT and support equipment.

### TEST PROCEDURE

1. The EUT was placed on a table, which is 0.8m above ground plane.
2. Maximum procedure was performed on the six highest emissions to ensure EUT compliance.
3. Repeat above procedures until all frequency measured were complete.



**TEST RESULTS**

The initial step in collecting conducted data is a spectrum analyzer peak scan of the measurement range. Significant peaks are then marked as shown on the following data page, and these signals are then quasi-peaked.

**Test Data**

|                        |             |                   |               |
|------------------------|-------------|-------------------|---------------|
| <b>Operation Mode:</b> | Normal Link | <b>Test Date:</b> | July 26, 2013 |
| <b>Temperature:</b>    | 22°C        | <b>Tested by:</b> | Jason Lee     |
| <b>Humidity:</b>       | 55% RH      |                   |               |

| Conducted Emission Readings  |                |             |               |                   |             |                  |              |
|------------------------------|----------------|-------------|---------------|-------------------|-------------|------------------|--------------|
| Frequency Range Investigated |                |             |               | 150 kHz to 30 MHz |             |                  |              |
| Freq. (MHz)                  | Reading (dBuV) | Factor (dB) | Result (dBuV) | Limit (dBuV)      | Margin (dB) | Detector (P/Q/A) | Line (L1/L2) |
| 0.2020                       | 39.47          | 10.07       | 49.54         | 63.52             | -13.98      | P                | L1           |
| 0.2660                       | 33.37          | 10.06       | 43.43         | 61.24             | -17.81      | P                | L1           |
| 0.3300                       | 28.27          | 10.05       | 38.32         | 59.45             | -21.13      | P                | L1           |
| 0.4660                       | 28.48          | 10.06       | 38.54         | 56.58             | -18.04      | P                | L1           |
| 0.5299                       | 26.74          | 10.06       | 36.80         | 56.00             | -19.20      | P                | L1           |
| 0.9260                       | 25.88          | 10.12       | 36.00         | 56.00             | -20.00      | P                | L1           |
| 0.1980                       | 40.59          | 10.05       | 50.64         | 63.69             | -13.05      | P                | L2           |
| 0.2580                       | 33.52          | 10.04       | 43.56         | 61.49             | -17.93      | P                | L2           |
| 0.3339                       | 27.26          | 10.03       | 37.29         | 59.35             | -22.06      | P                | L2           |
| 0.4620                       | 27.06          | 10.04       | 37.10         | 56.66             | -19.56      | P                | L2           |
| 0.5299                       | 26.74          | 10.04       | 36.78         | 56.00             | -19.22      | P                | L2           |
| 0.7940                       | 23.17          | 10.08       | 33.25         | 56.00             | -22.75      | P                | L2           |

**Remark:**

1. Measuring frequencies from 0.15 MHz to 30MHz.
2. The emissions measured in frequency range from 0.15 MHz to 30MHz were made with an instrument using Quasi-peak detector and average detector.
3. The IF bandwidth of SPA between 0.15MHz to 30MHz was 10kHz; the IF bandwidth of Test Receiver between 0.15MHz to 30MHz was 9kHz;
4. L1 = Line One (Live Line) / L2 = Line Two (Neutral Line)



**Test Plots**

**Conducted emissions (Line 1)**

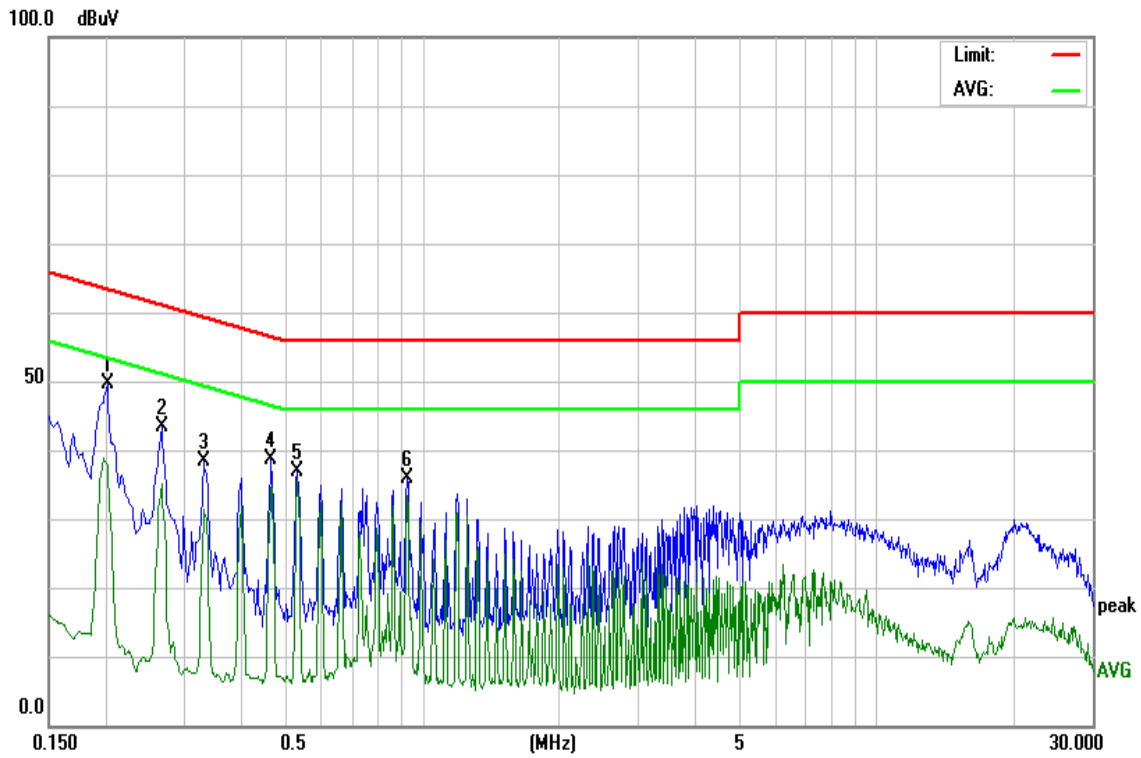

**Conducted emissions (Line 2)**

