

Test Band				WLAN_2.4GHz			
Antenna				Ant 1			
Test Parameters							
Test Item	No.	Mode	Frquency	Bandwidth	Detector	Harmonic	Polarization
Harmonic	1	802.11 b	4824	20 MHz	AVG	2	Horizontal
Harmonic	2	802.11 b	4824	20 MHz	PEAK	2	Horizontal
Harmonic	3	802.11 b	4824	20 MHz	AVG	2	Vertical
Harmonic	4	802.11 b	4824	20 MHz	PEAK	2	Vertical
Harmonic	5	802.11 b	4874	20 MHz	AVG	2	Horizontal
Harmonic	6	802.11 b	4874	20 MHz	PEAK	2	Horizontal
Harmonic	7	802.11 b	4874	20 MHz	AVG	2	Vertical
Harmonic	8	802.11 b	4874	20 MHz	PEAK	2	Vertical
Harmonic	9	802.11 b	4924	20 MHz	AVG	2	Horizontal
Harmonic	10	802.11 b	4924	20 MHz	PEAK	2	Horizontal
Harmonic	11	802.11 b	4924	20 MHz	AVG	2	Vertical
Harmonic	12	802.11 b	4924	20 MHz	PEAK	2	Vertical
Harmonic	13	802.11 b	4934	20 MHz	AVG	2	Horizontal
Harmonic	14	802.11 b	4934	20 MHz	PEAK	2	Horizontal
Harmonic	15	802.11 b	4934	20 MHz	AVG	2	Vertical
Harmonic	16	802.11 b	4934	20 MHz	PEAK	2	Vertical
Harmonic	17	802.11 b	4944	20 MHz	AVG	2	Horizontal
Harmonic	18	802.11 b	4944	20 MHz	PEAK	2	Horizontal
Harmonic	19	802.11 b	4944	20 MHz	AVG	2	Vertical
Harmonic	20	802.11 b	4944	20 MHz	PEAK	2	Vertical

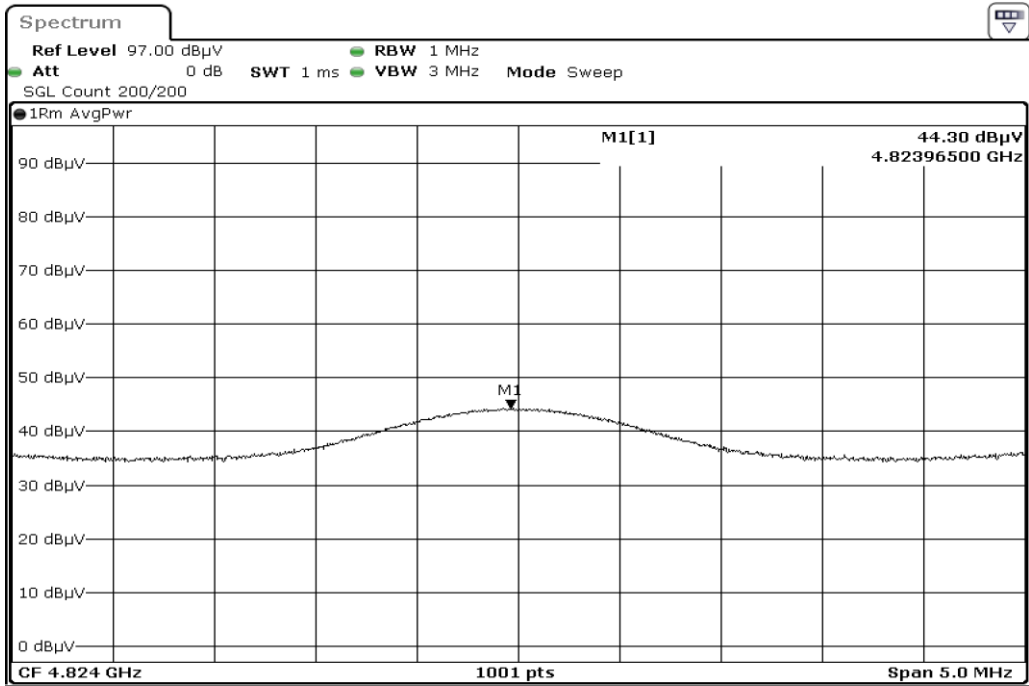

Date: 11.OCT.2023 14:36:45

1	Harmonic
---	----------

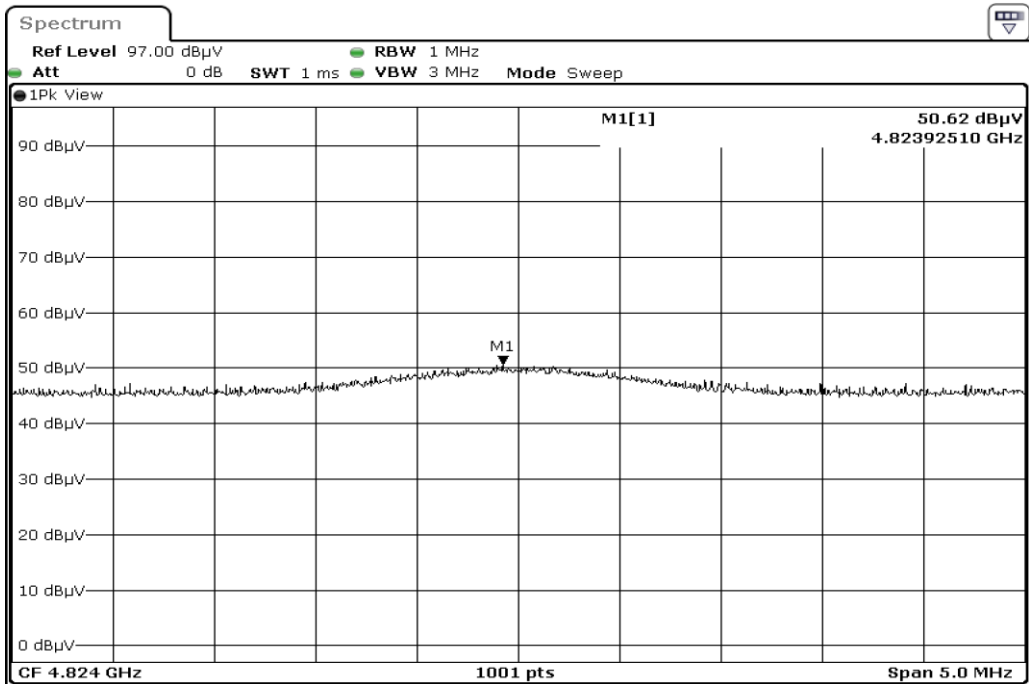

Date: 11.OCT.2023 14:36:41

2	Harmonic
---	----------

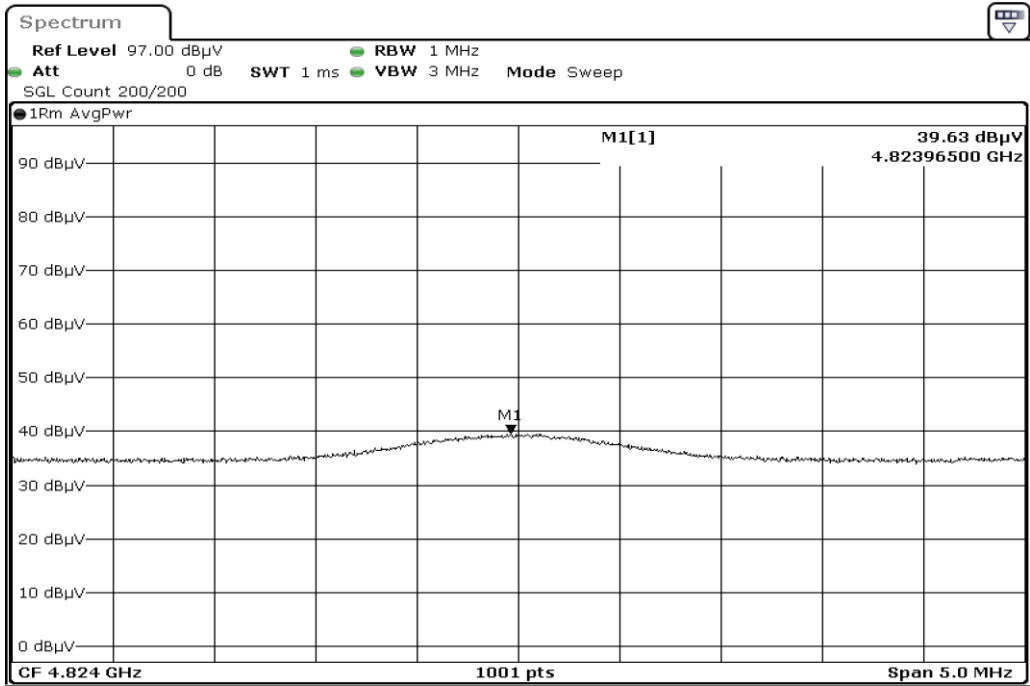

Date: 11.OCT.2023 15:09:34

3	Harmonic
---	----------

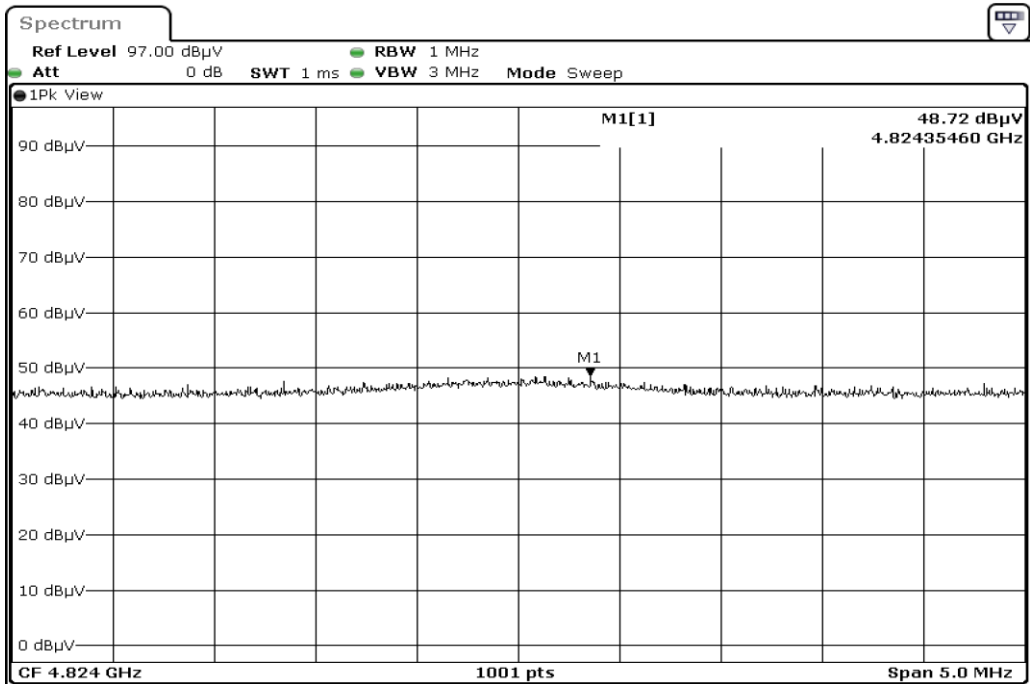

Date: 11.OCT.2023 15:09:29

4	Harmonic
---	----------

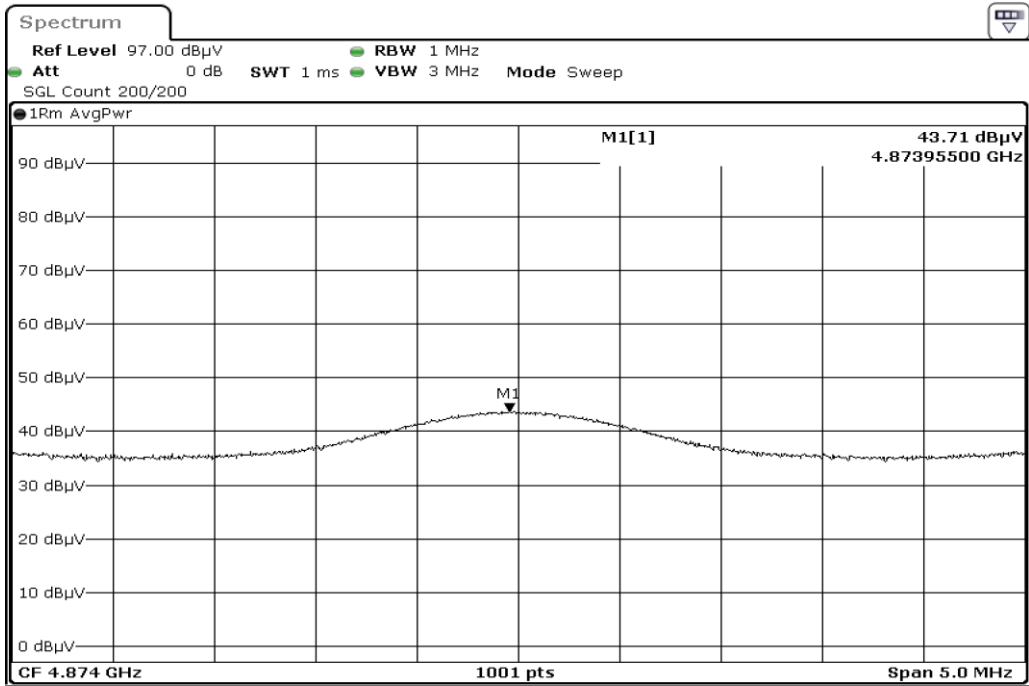

Date: 11.OCT.2023 14:40:44

5	Harmonic
---	----------

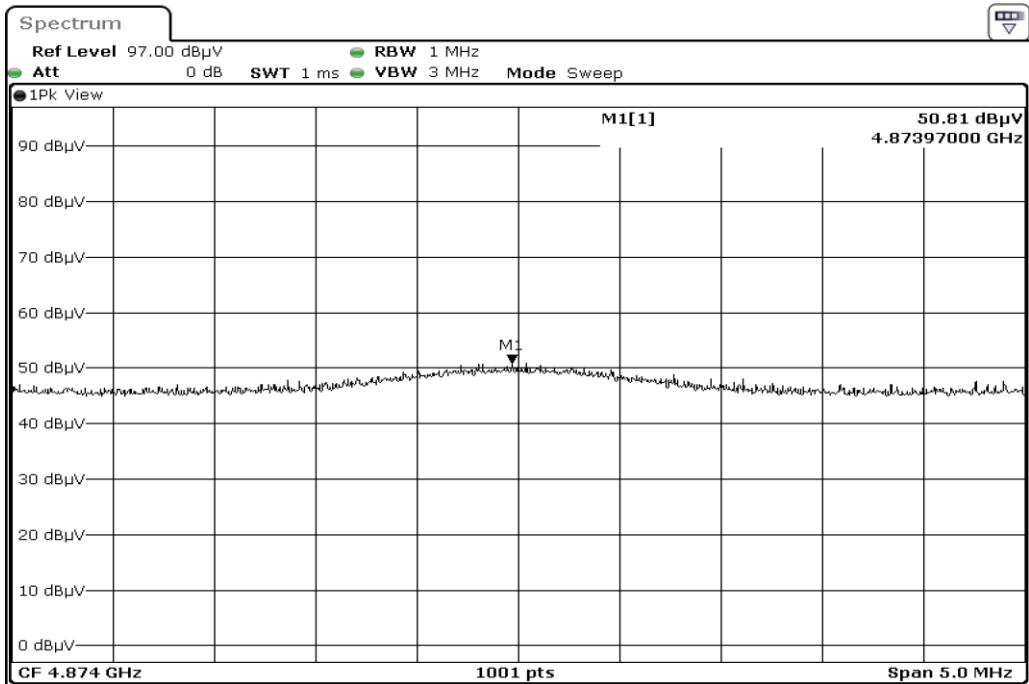

Date: 11.OCT.2023 14:40:39

6	Harmonic
---	----------

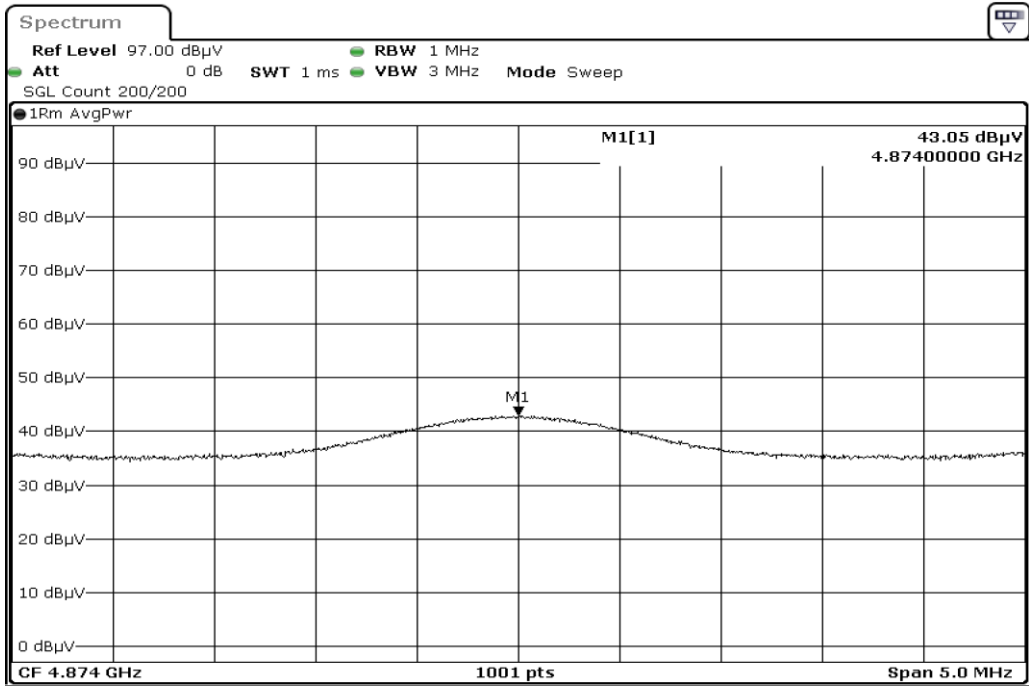

Date: 11.OCT.2023 15:02:26

7	Harmonic
---	----------

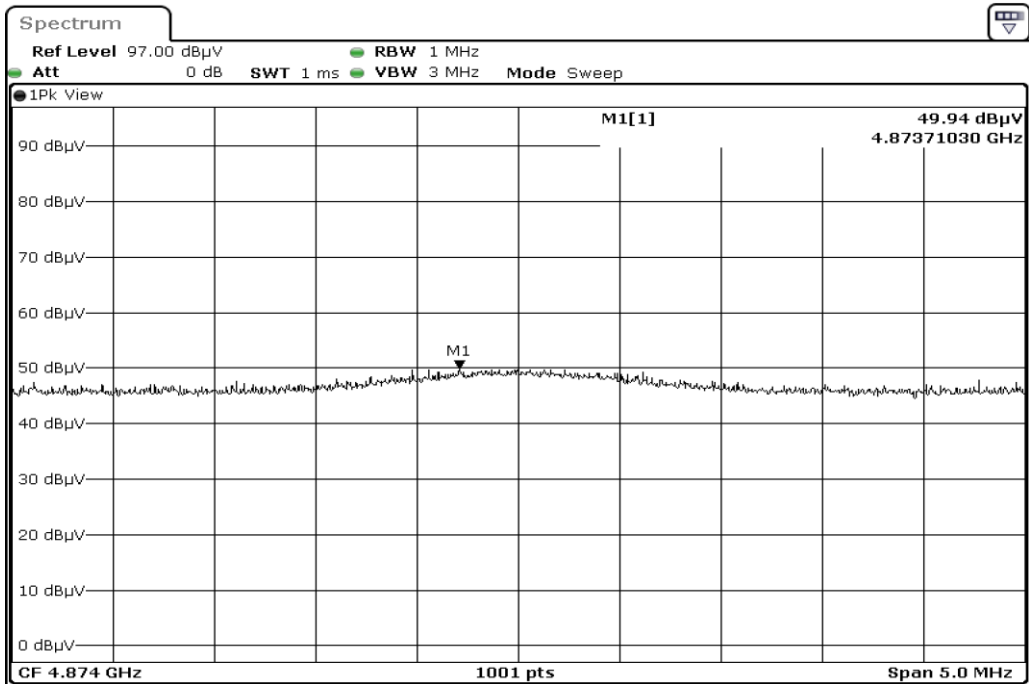

Date: 11.OCT.2023 15:02:22

8	Harmonic
---	----------

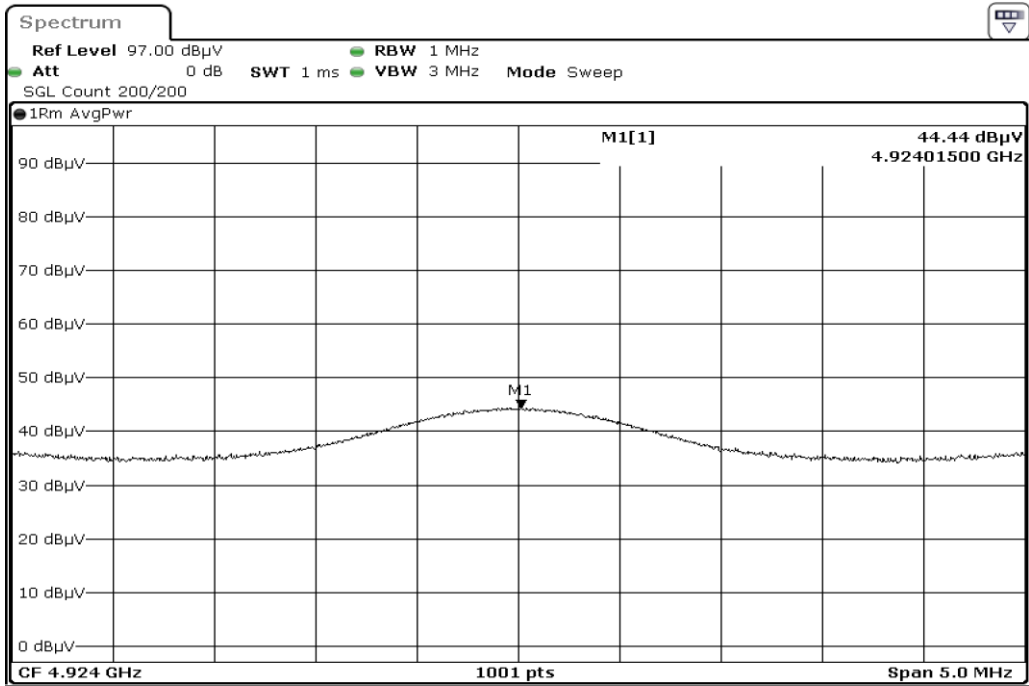

Date: 11.OCT.2023 14:47:39

9	Harmonic
---	----------

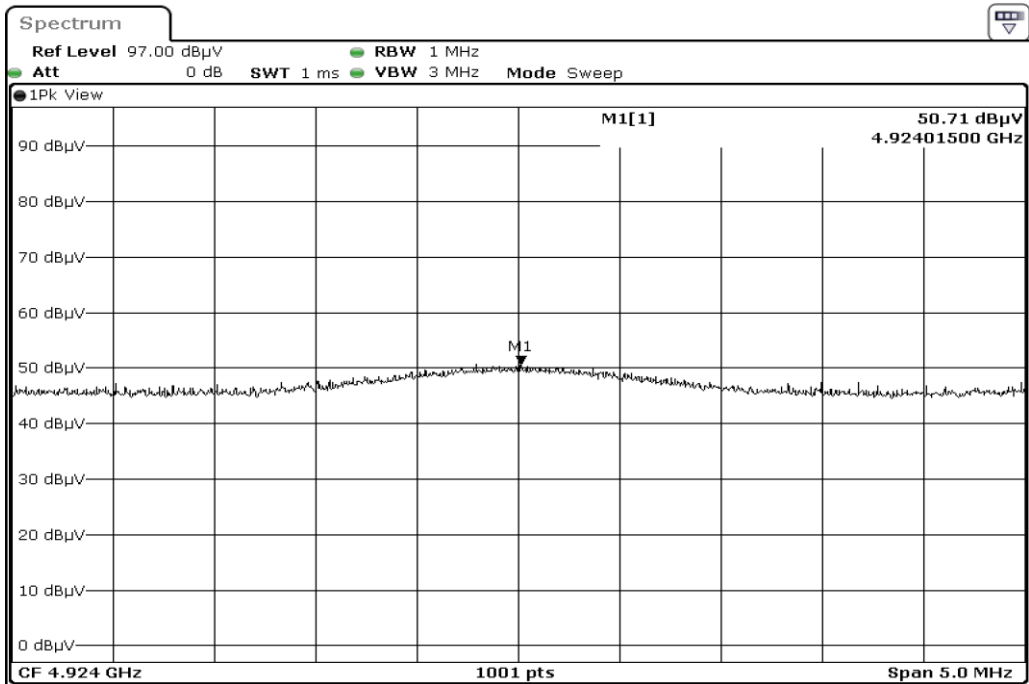

Date: 11.OCT.2023 14:47:34

10	Harmonic
----	----------

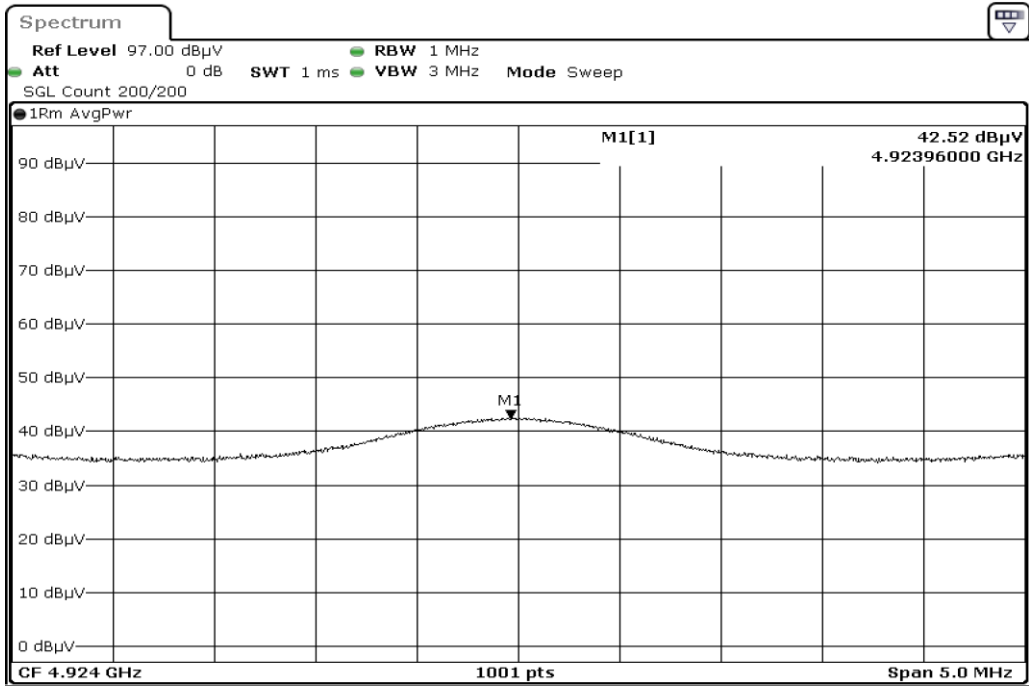

Date: 11.OCT.2023 14:57:43

11	Harmonic
----	----------

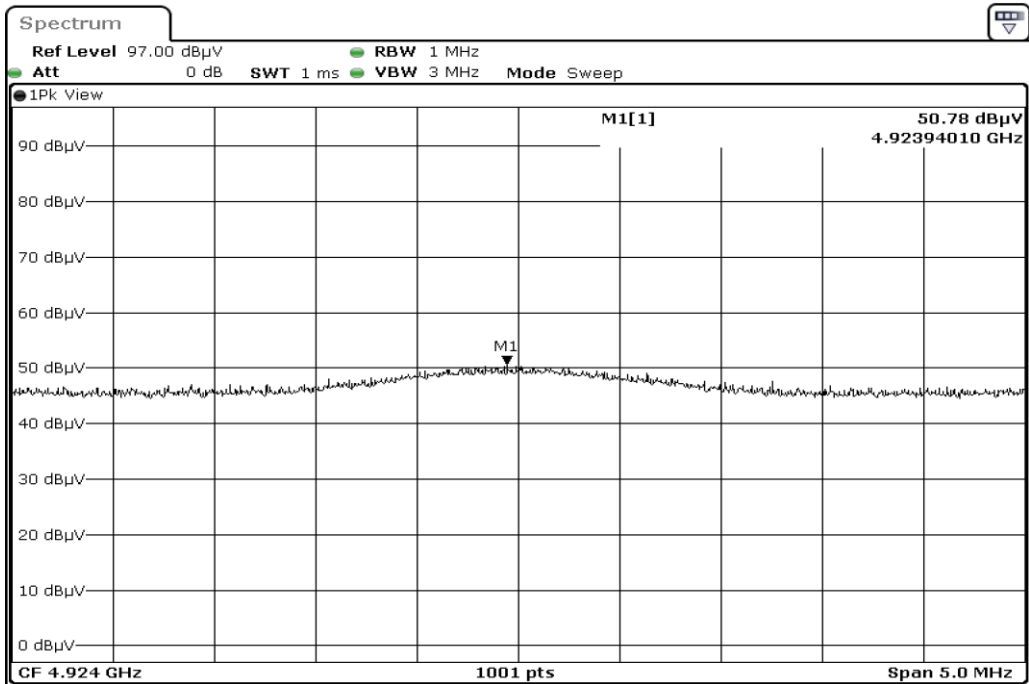

Date: 11.OCT.2023 14:57:38

12	Harmonic
----	----------

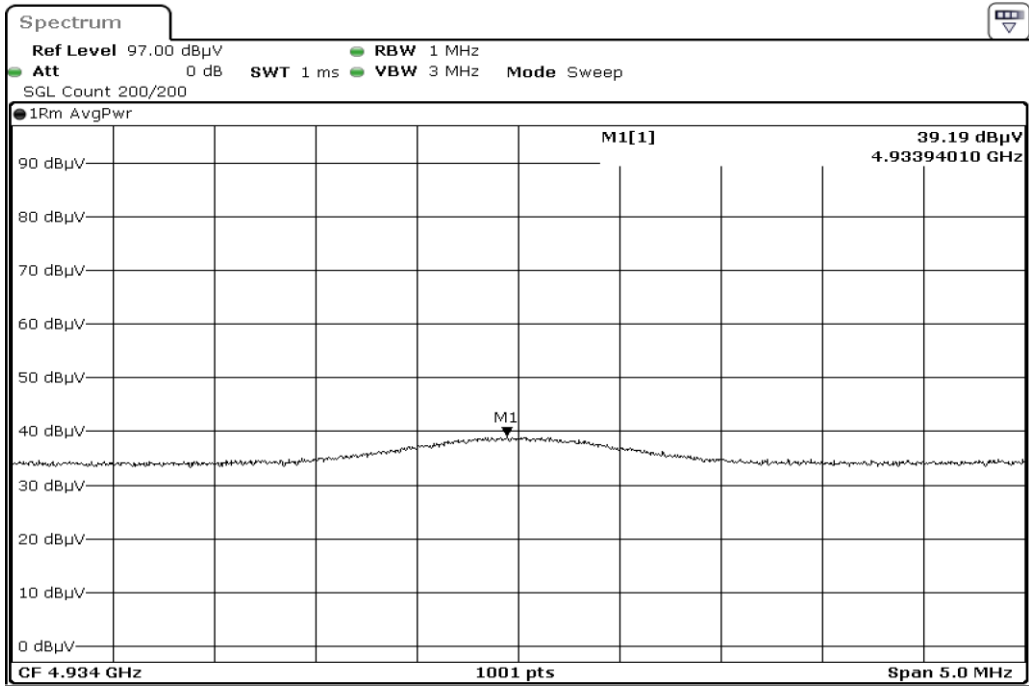

Date: 11.OCT.2023 13:34:02

13	Harmonic
----	----------

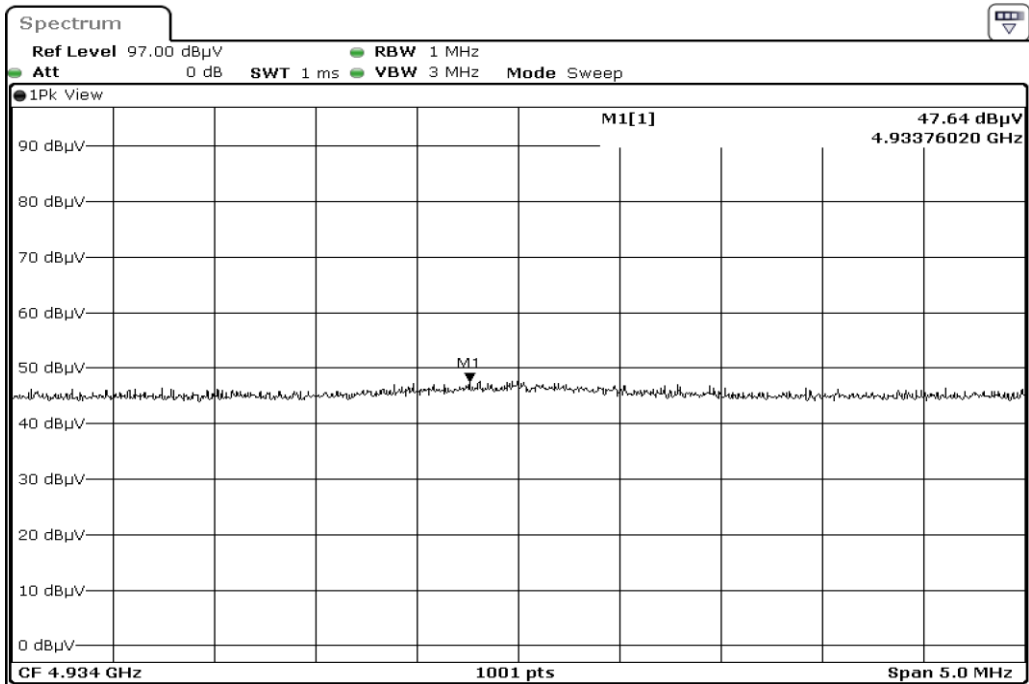

Date: 11.OCT.2023 13:33:58

14	Harmonic
----	----------



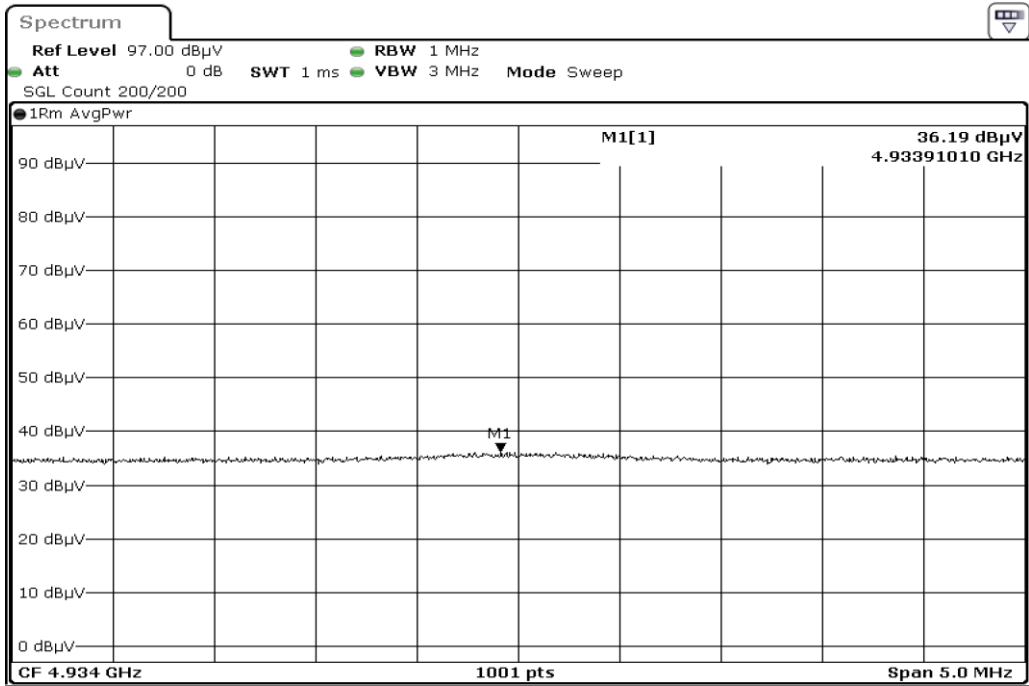

Date: 11.OCT.2023 14:06:16

15	Harmonic
----	----------

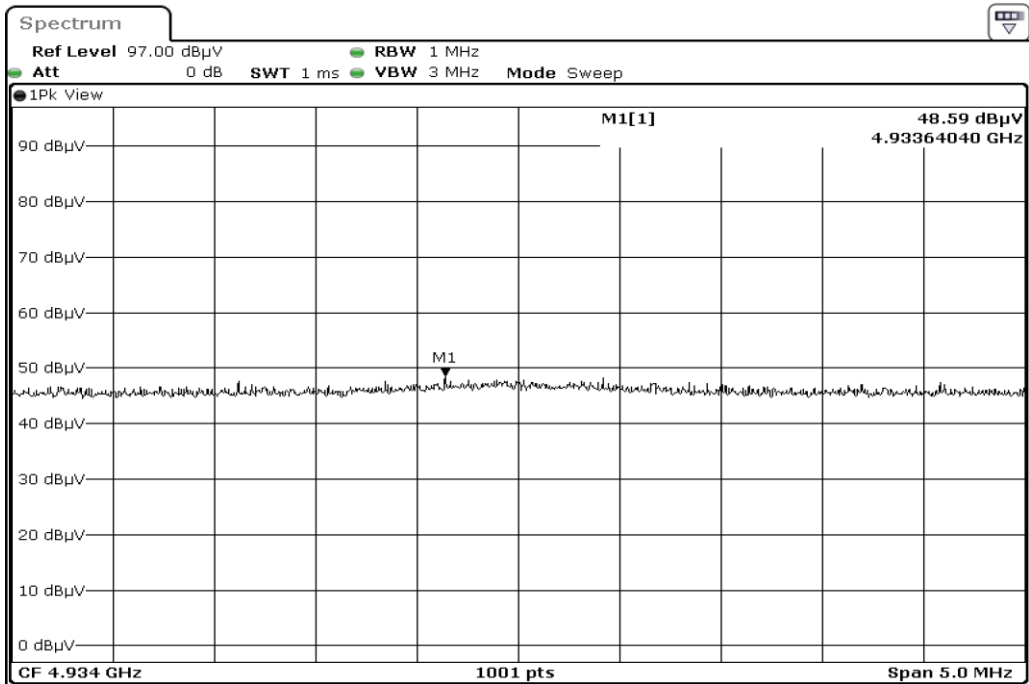

Date: 11.OCT.2023 14:06:11

16	Harmonic
----	----------

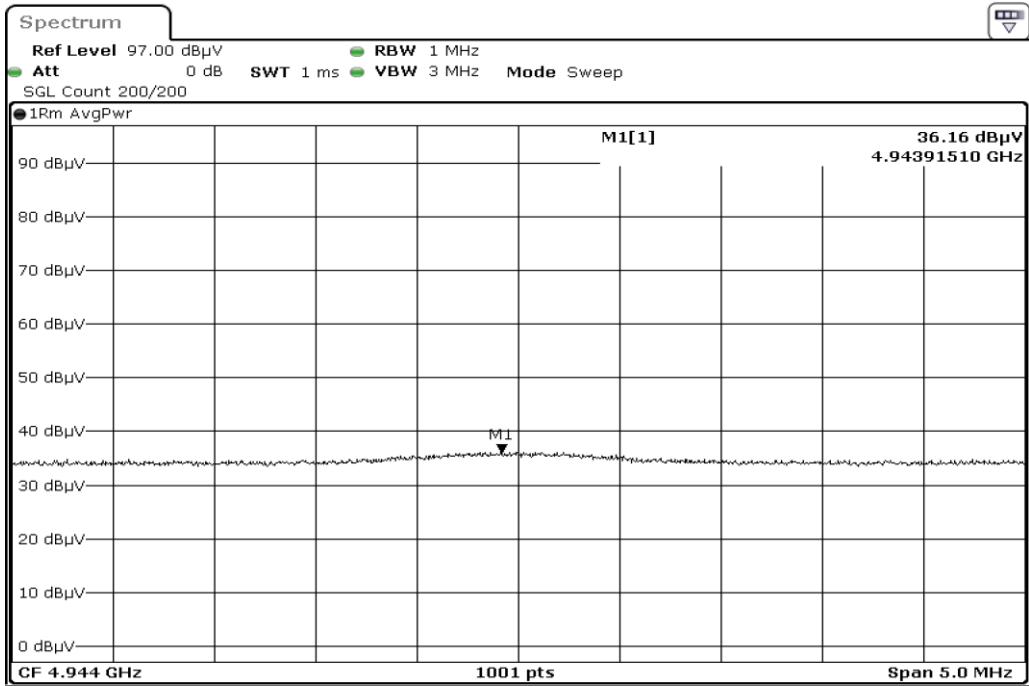

Date: 11.OCT.2023 13:41:05

17	Harmonic
----	----------

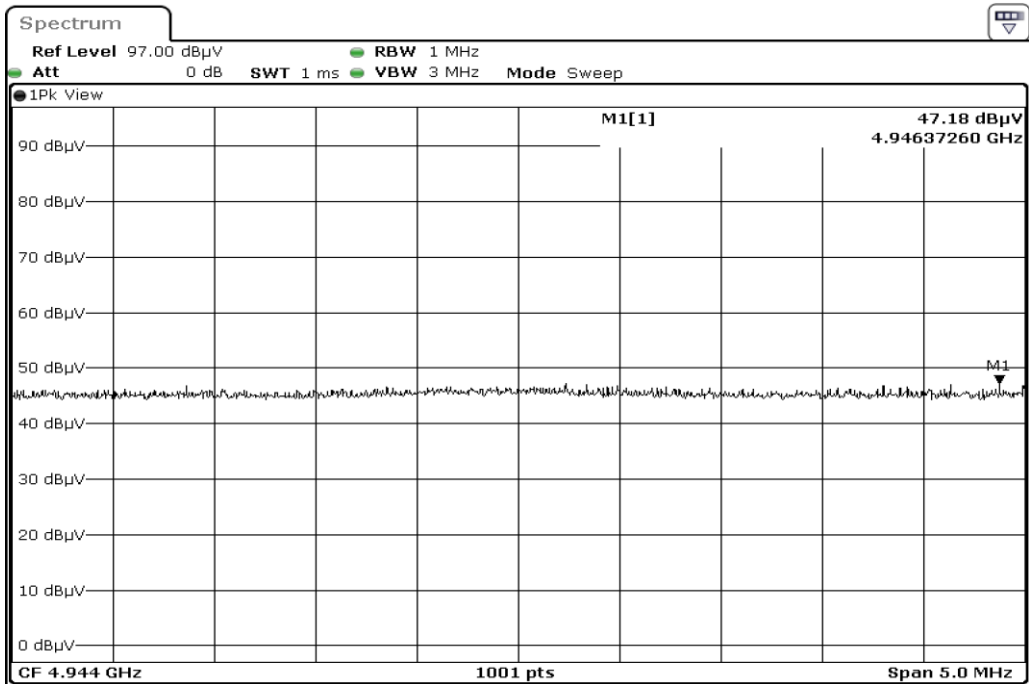

Date: 11.OCT.2023 13:41:01

18	Harmonic
----	----------

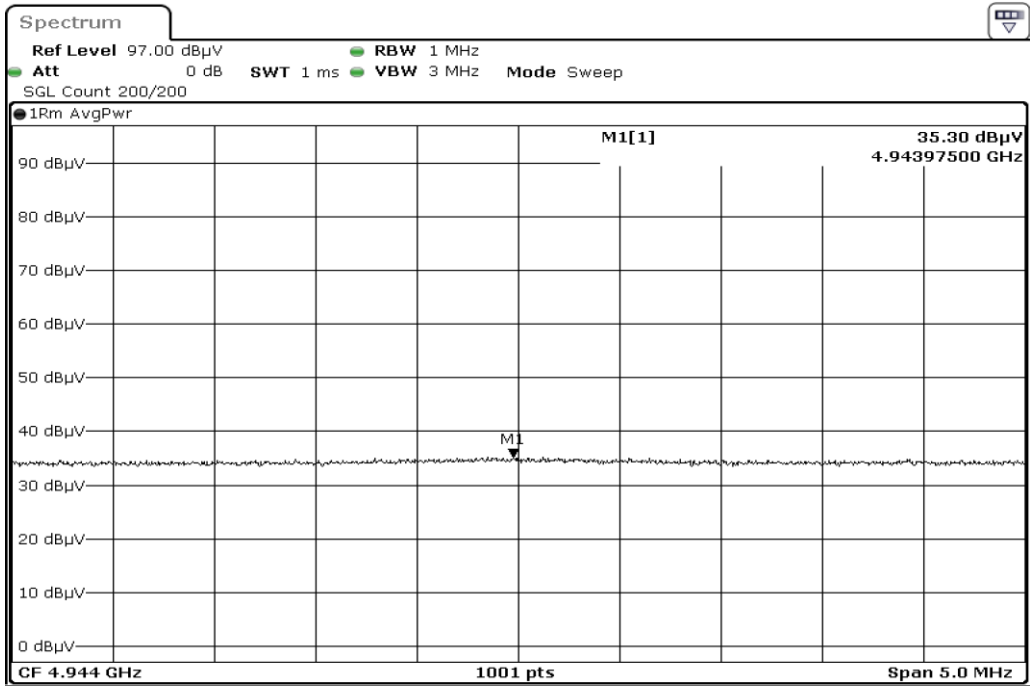

Date: 11.OCT.2023 13:57:24

19	Harmonic
----	----------

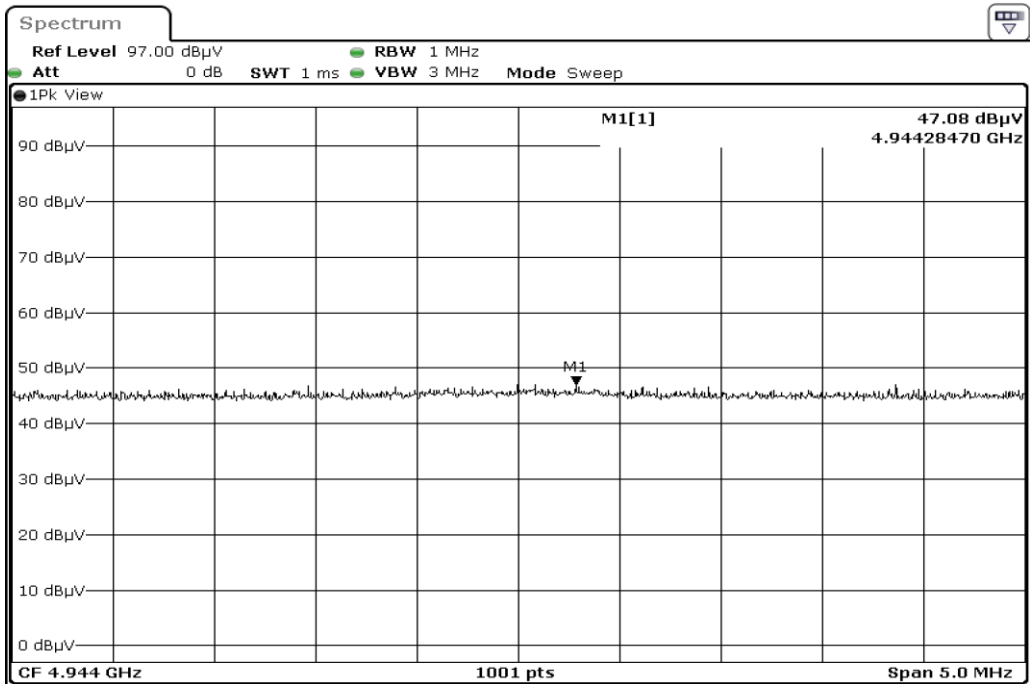

Date: 11.OCT.2023 13:57:19

20	Harmonic
----	----------

Test Band				WLAN_2.4GHz			
Antenna				ANT2			
Test Parameters							
Test Item	No.	Mode	Frquency	Bandwidth	Detector	Harmonic	Polarization
Harmonic	1	802.11 b	4824	20 MHz	AVG	2	Horizontal
Harmonic	2	802.11 b	4824	20 MHz	PEAK	2	Horizontal
Harmonic	3	802.11 b	4824	20 MHz	AVG	2	Vertical
Harmonic	4	802.11 b	4824	20 MHz	PEAK	2	Vertical
Harmonic	5	802.11 b	4874	20 MHz	AVG	2	Horizontal
Harmonic	6	802.11 b	4874	20 MHz	PEAK	2	Horizontal
Harmonic	7	802.11 b	4874	20 MHz	AVG	2	Vertical
Harmonic	8	802.11 b	4874	20 MHz	PEAK	2	Vertical
Harmonic	9	802.11 b	4924	20 MHz	AVG	2	Horizontal
Harmonic	10	802.11 b	4924	20 MHz	PEAK	2	Horizontal
Harmonic	11	802.11 b	4924	20 MHz	AVG	2	Vertical
Harmonic	12	802.11 b	4924	20 MHz	PEAK	2	Vertical
Harmonic	13	802.11 b	4934	20 MHz	AVG	2	Horizontal
Harmonic	14	802.11 b	4934	20 MHz	PEAK	2	Horizontal
Harmonic	15	802.11 b	4934	20 MHz	AVG	2	Vertical
Harmonic	16	802.11 b	4934	20 MHz	PEAK	2	Vertical
Harmonic	17	802.11 b	4944	20 MHz	AVG	2	Horizontal
Harmonic	18	802.11 b	4944	20 MHz	PEAK	2	Horizontal
Harmonic	19	802.11 b	4944	20 MHz	AVG	2	Vertical
Harmonic	20	802.11 b	4944	20 MHz	PEAK	2	Vertical

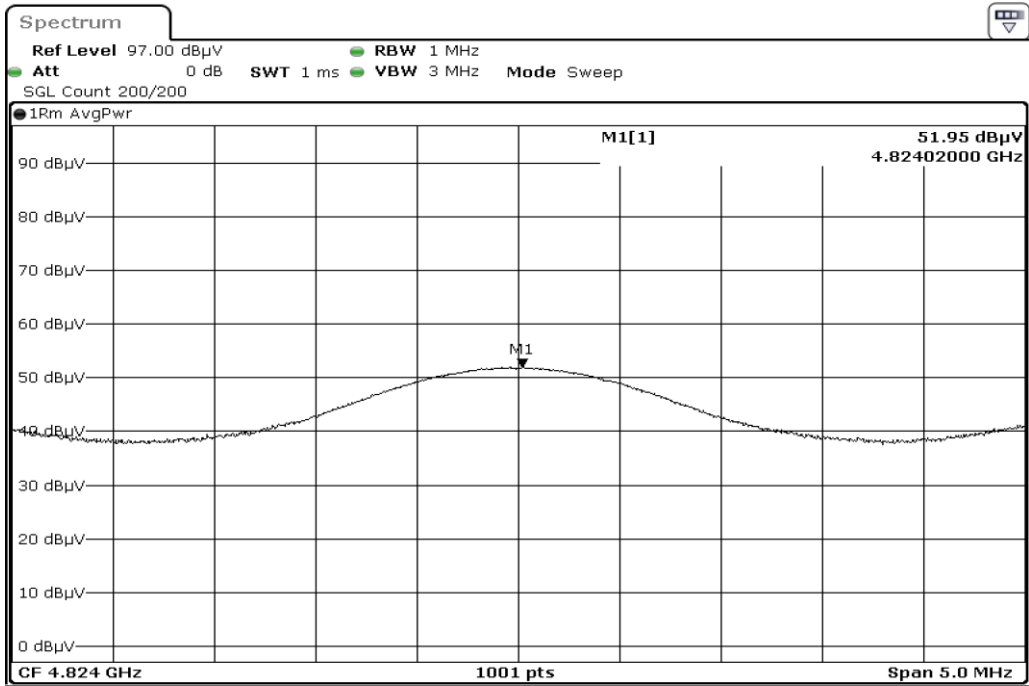

Date: 12.OCT.2023 10:58:24

1	Harmonic
---	----------

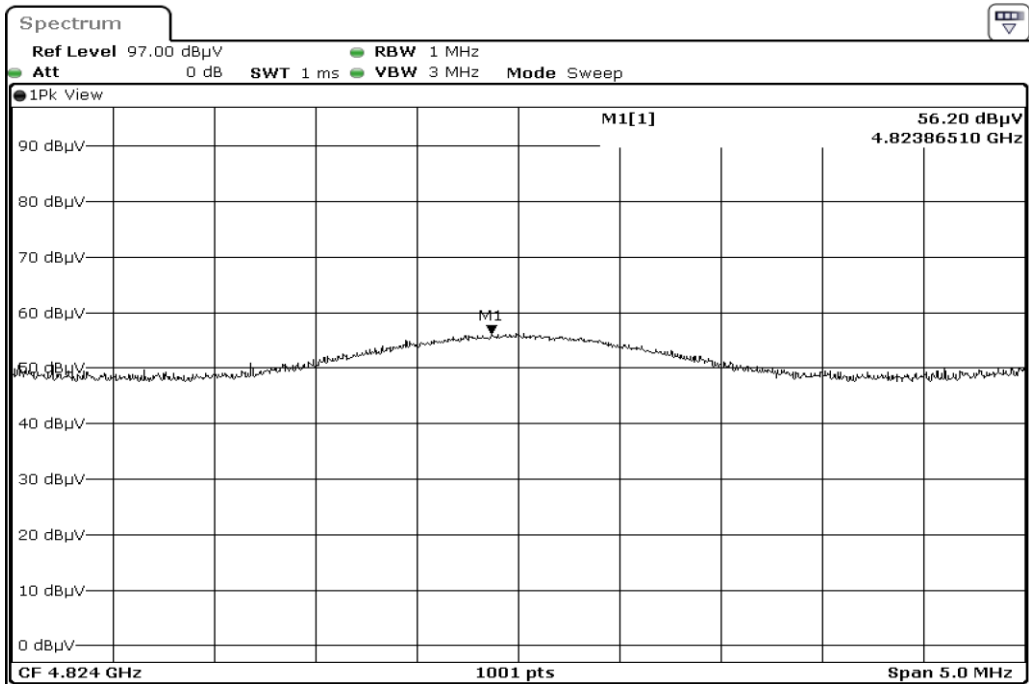

Date: 12.OCT.2023 10:58:20

2	Harmonic
---	----------

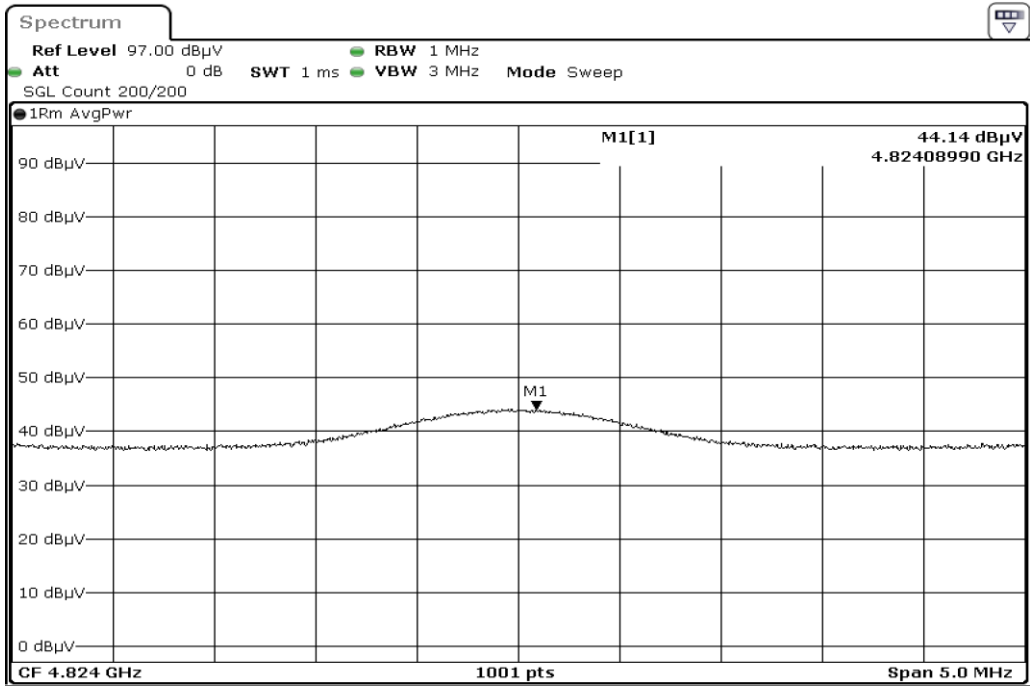

Date: 12.OCT.2023 11:18:15

3	Harmonic
---	----------

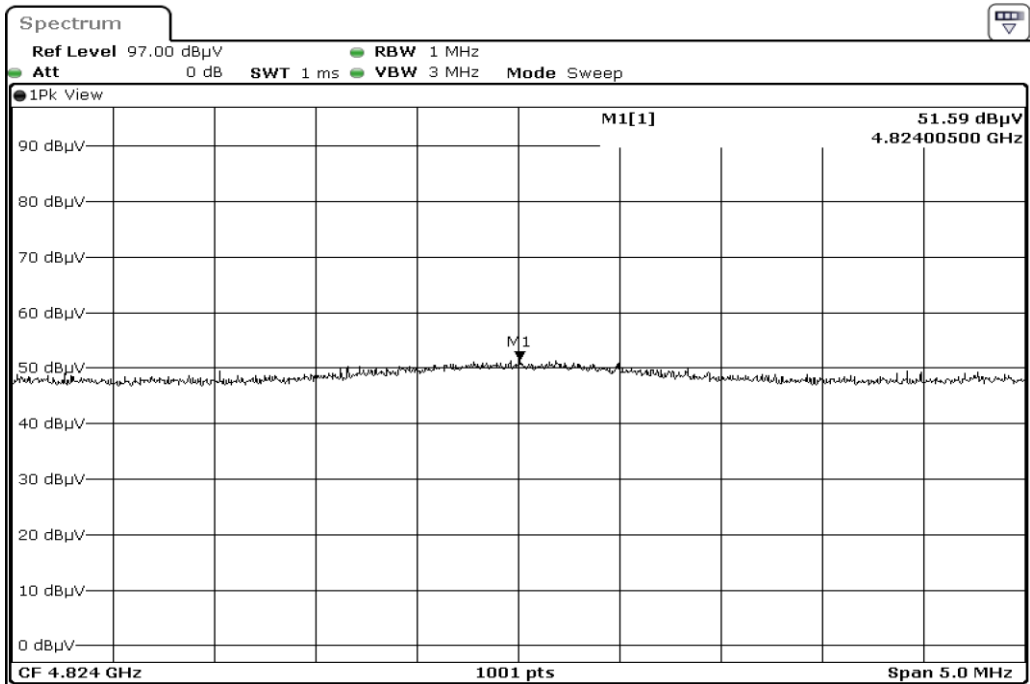

Date: 12.OCT.2023 11:18:11

4	Harmonic
---	----------

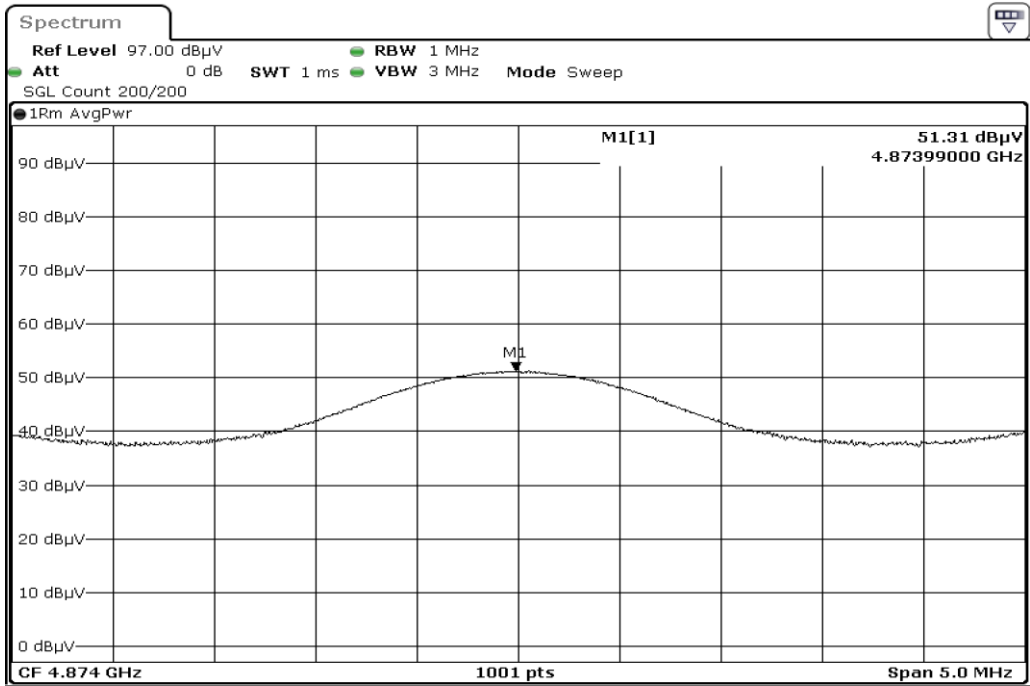

Date: 12.OCT.2023 10:39:19

5	Harmonic
---	----------

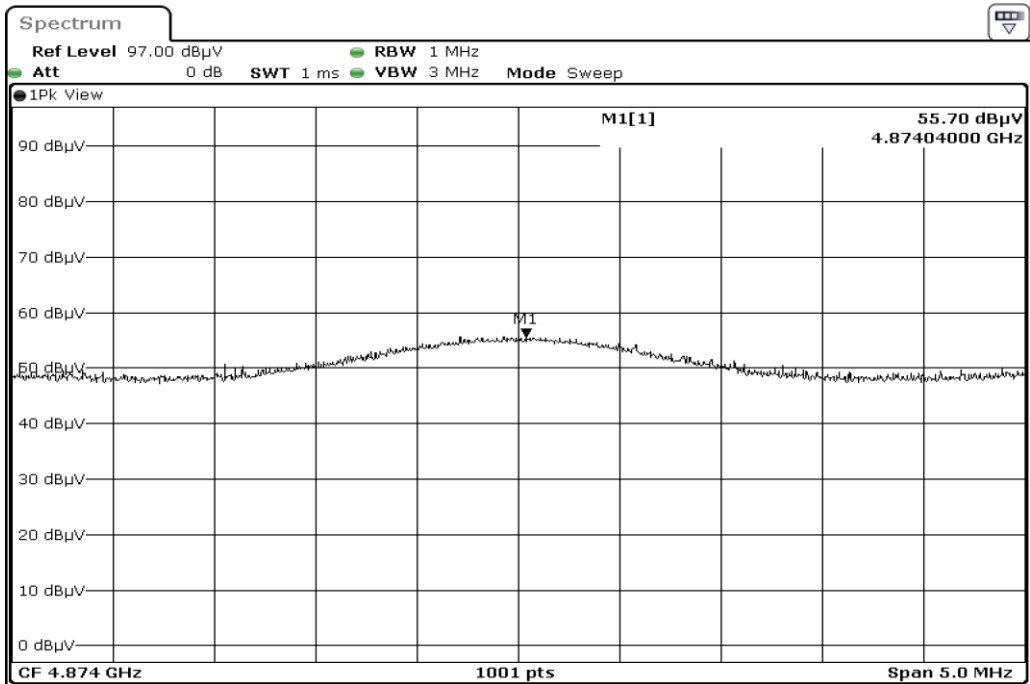

Date: 12.OCT.2023 10:39:15

6	Harmonic
---	----------

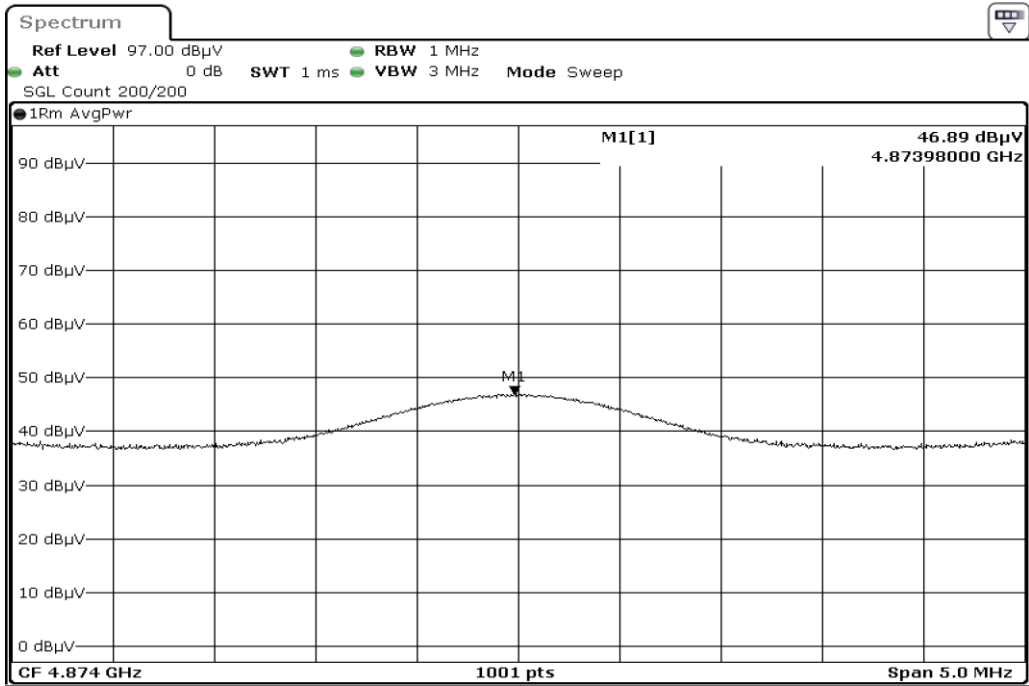

Date: 12.OCT.2023 11:11:17

7	Harmonic
---	----------

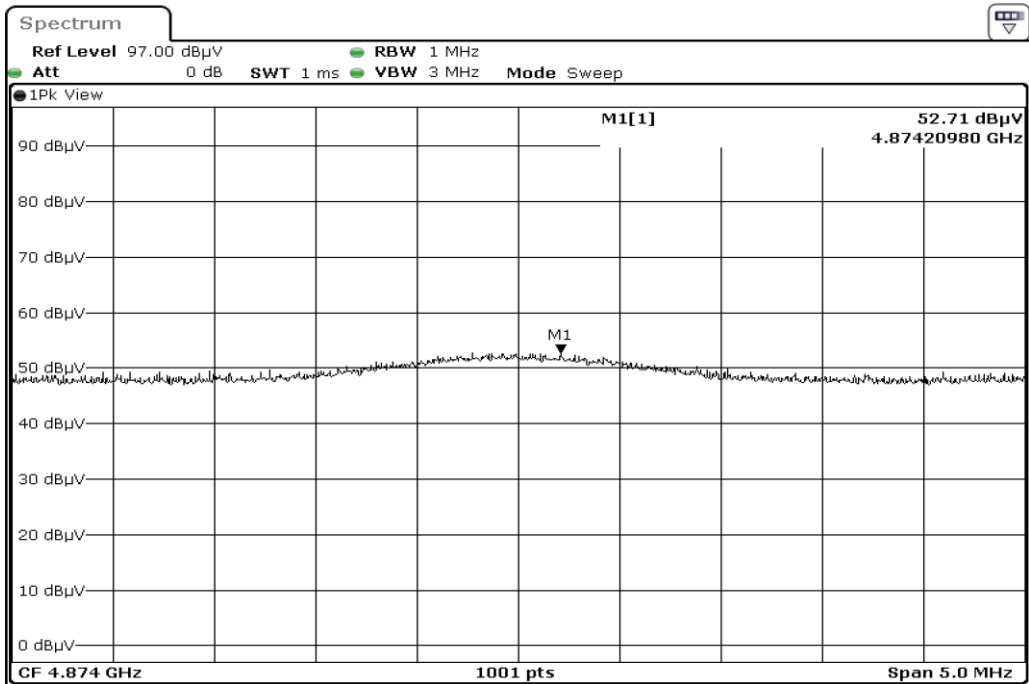

Date: 12.OCT.2023 11:11:13

8	Harmonic
---	----------



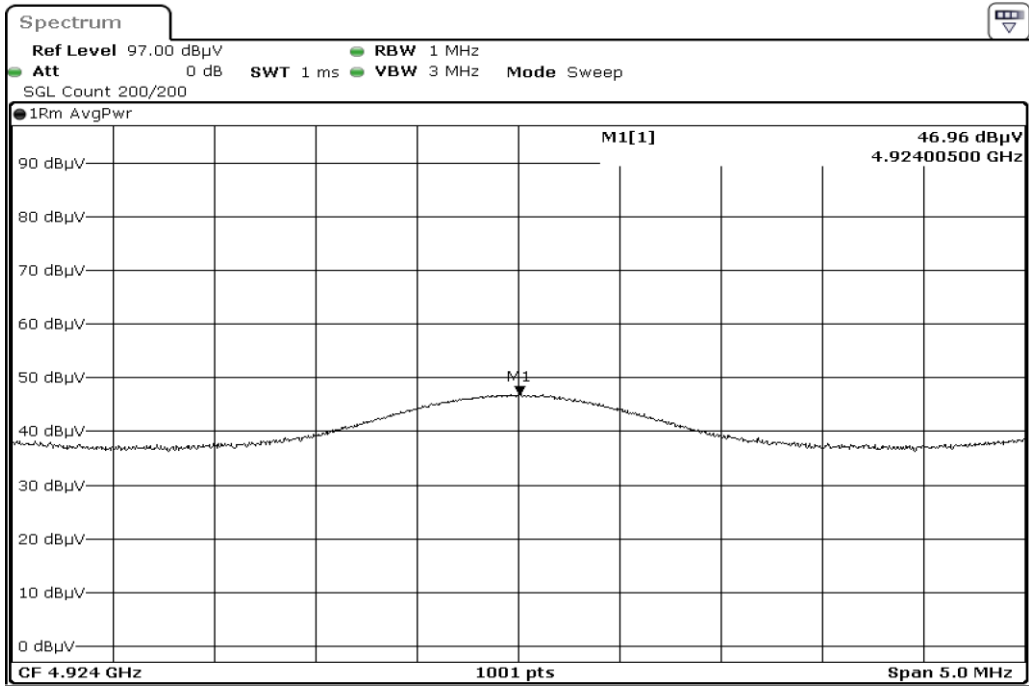

Date: 12.OCT.2023 10:46:25

9	Harmonic
---	----------

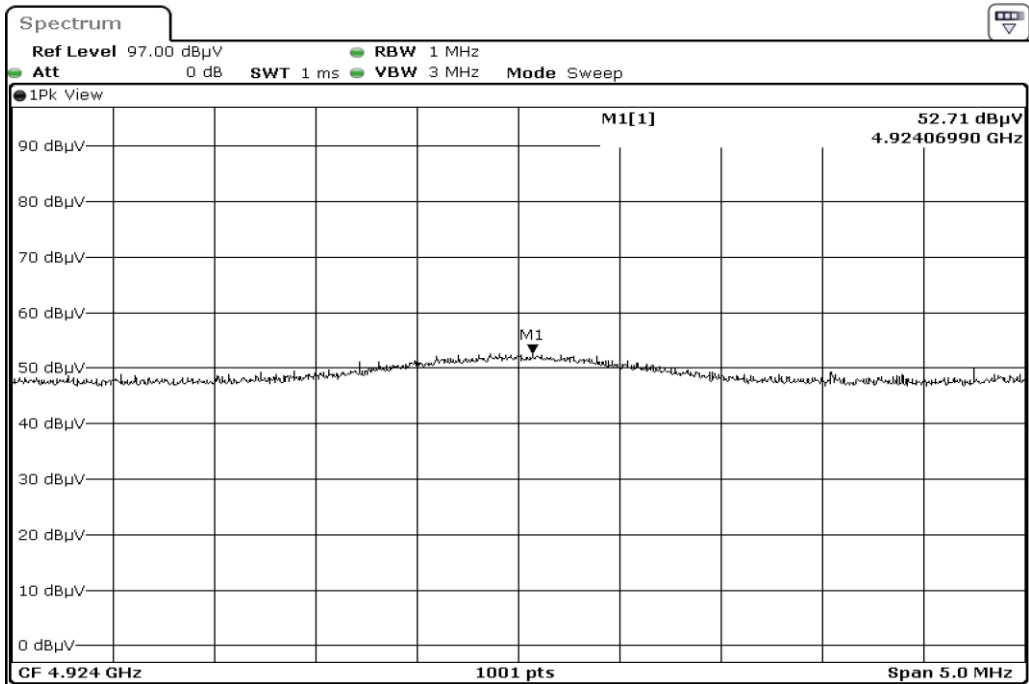

Date: 12.OCT.2023 10:46:21

10	Harmonic
----	----------

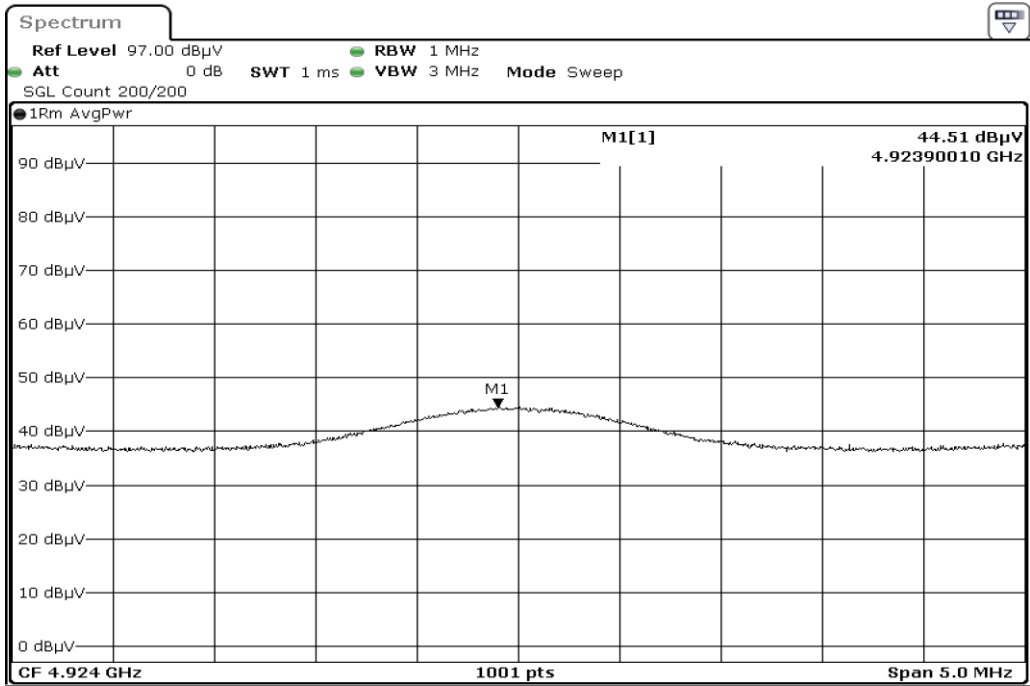

Date: 12.OCT.2023 11:07:08

11	Harmonic
----	----------

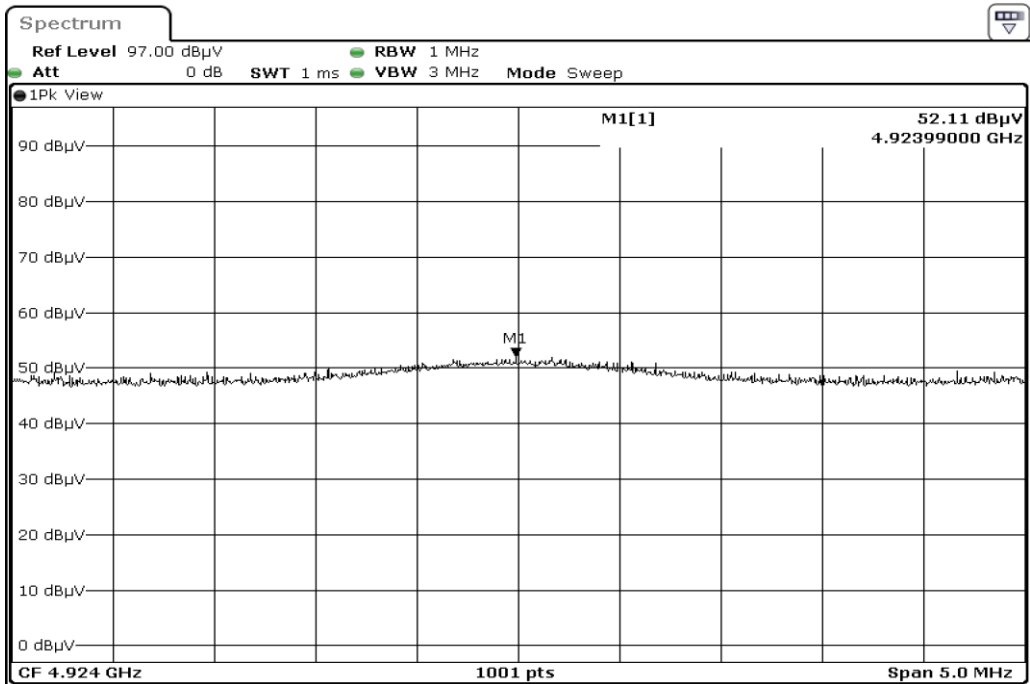

Date: 12.OCT.2023 11:07:04

12	Harmonic
----	----------

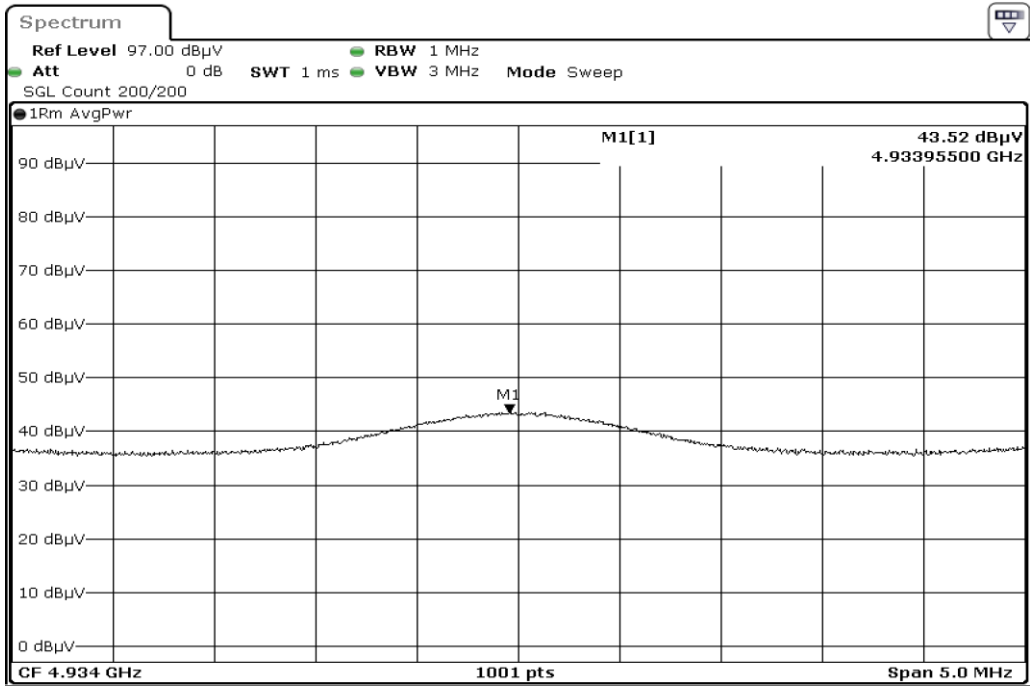

Date: 11.OCT.2023 15:50:29

13	Harmonic
----	----------

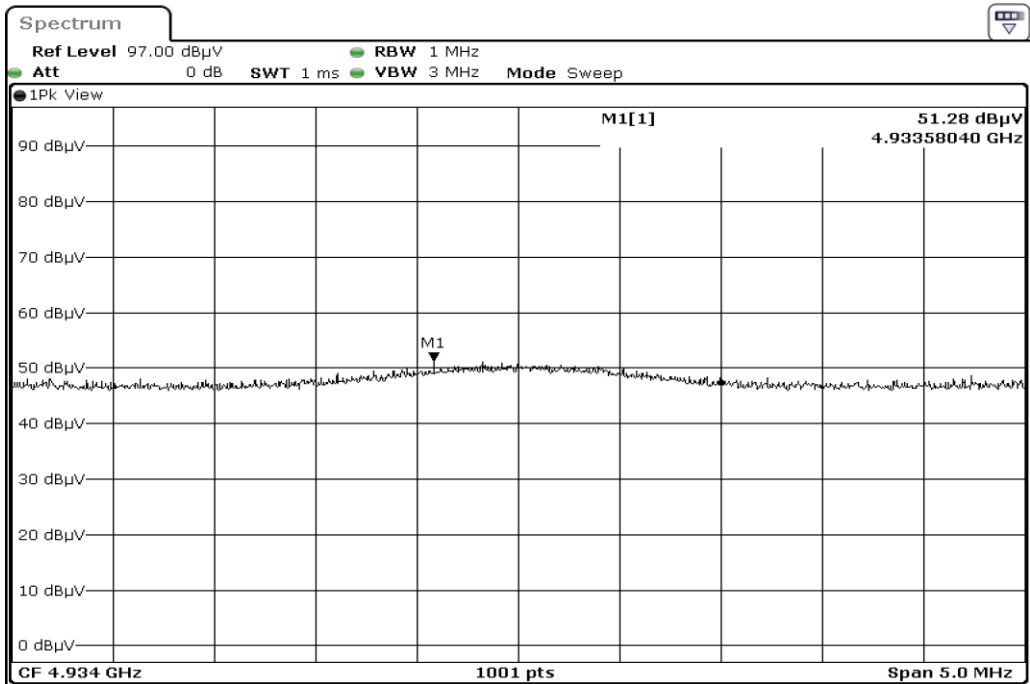

Date: 11.OCT.2023 15:50:24

14	Harmonic
----	----------

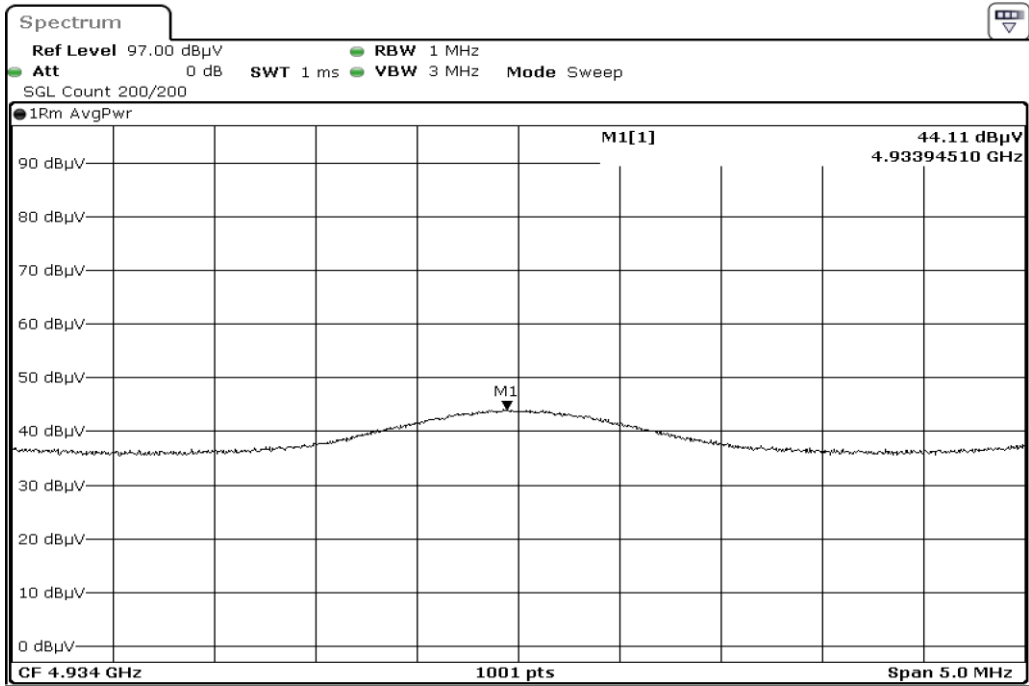

Date: 11.OCT.2023 16:18:27

15	Harmonic
----	----------

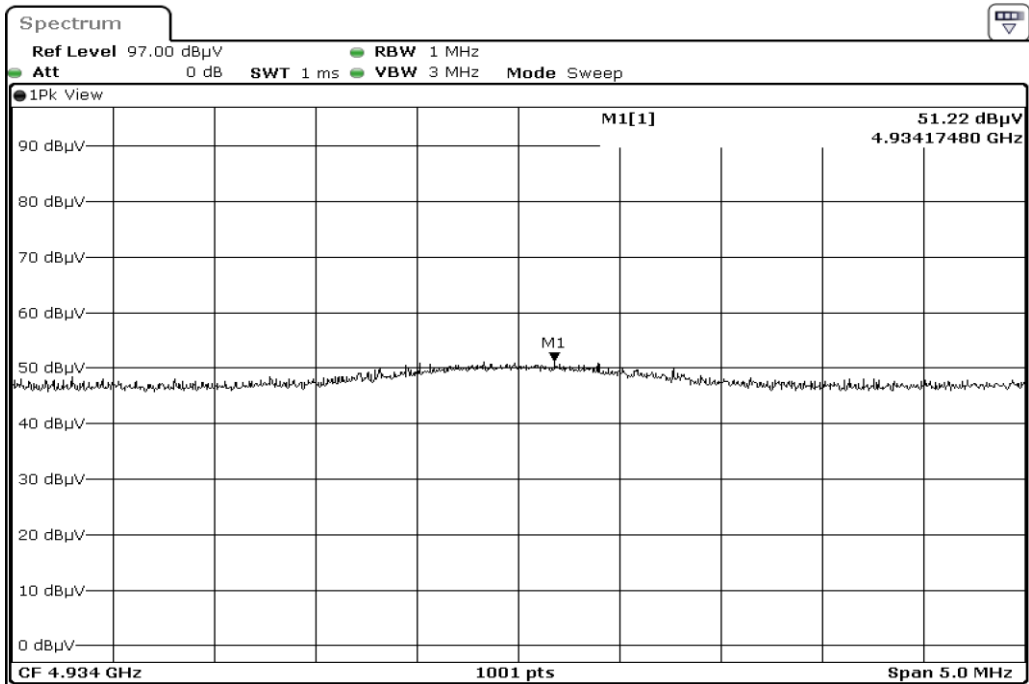

Date: 11.OCT.2023 16:18:23

16	Harmonic
----	----------

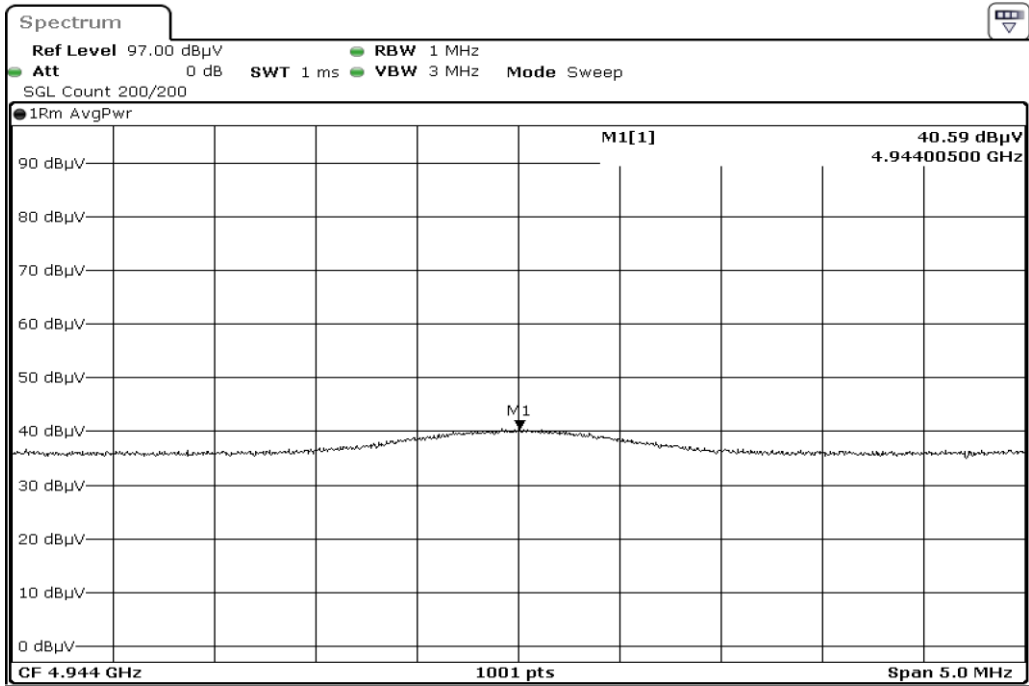

Date: 11.OCT.2023 15:56:58

17	Harmonic
----	----------

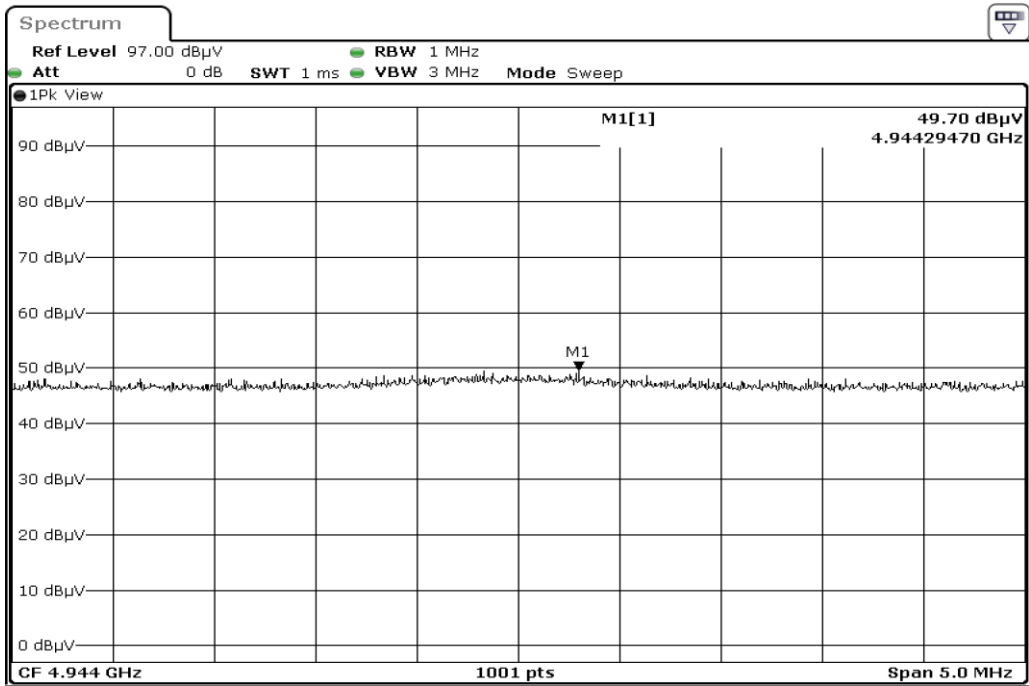

Date: 11.OCT.2023 15:56:54

18	Harmonic
----	----------

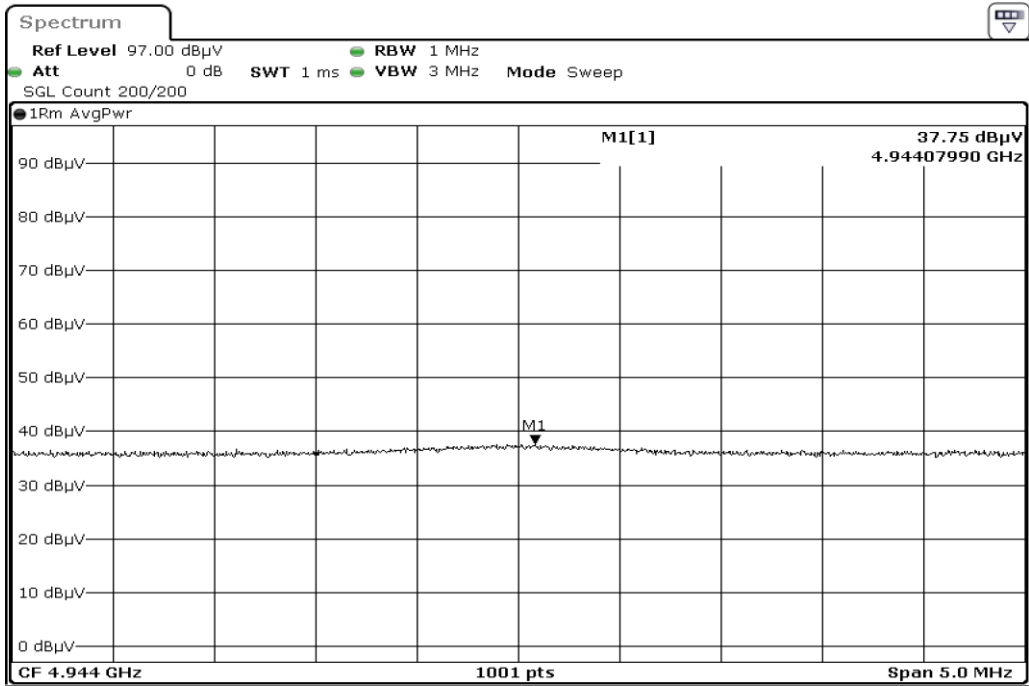

Date: 11.OCT.2023 16:07:55

19	Harmonic
----	----------

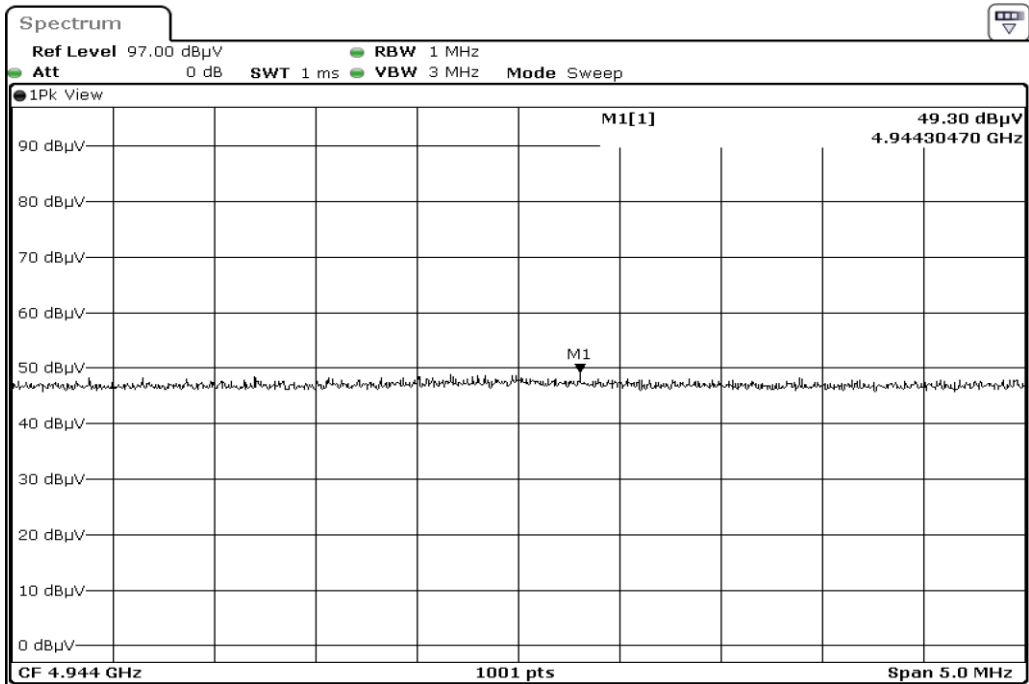

Date: 11.OCT.2023 16:07:51

20	Harmonic
----	----------

Test Band				WLAN_2.4GHz			
Antenna				Ant 1 + Ant 2			
Test Parameters							
Test Item	No.	Mode	Frquency	Bandwidth	Detector	Harmonic	Polarization
Harmonic	1	802.11 g	4824	20 MHz	AVG	2	Horizontal
Harmonic	2	802.11 g	4824	20 MHz	PEAK	2	Horizontal
Harmonic	3	802.11 g	4824	20 MHz	AVG	2	Vertical
Harmonic	4	802.11 g	4824	20 MHz	PEAK	2	Vertical
Harmonic	5	802.11 g	4874	20 MHz	AVG	2	Horizontal
Harmonic	6	802.11 g	4874	20 MHz	PEAK	2	Horizontal
Harmonic	7	802.11 g	4874	20 MHz	AVG	2	Vertical
Harmonic	8	802.11 g	4874	20 MHz	PEAK	2	Vertical
Harmonic	9	802.11 g	4924	20 MHz	AVG	2	Horizontal
Harmonic	10	802.11 g	4924	20 MHz	PEAK	2	Horizontal
Harmonic	11	802.11 g	4924	20 MHz	AVG	2	Vertical
Harmonic	12	802.11 g	4924	20 MHz	PEAK	2	Vertical
Harmonic	13	802.11 g	4934	20 MHz	AVG	2	Horizontal
Harmonic	14	802.11 g	4934	20 MHz	PEAK	2	Horizontal
Harmonic	15	802.11 g	4934	20 MHz	AVG	2	Vertical
Harmonic	16	802.11 g	4934	20 MHz	PEAK	2	Vertical
Harmonic	17	802.11 g	4944	20 MHz	AVG	2	Horizontal
Harmonic	18	802.11 g	4944	20 MHz	PEAK	2	Horizontal
Harmonic	19	802.11 g	4944	20 MHz	AVG	2	Vertical
Harmonic	20	802.11 g	4944	20 MHz	PEAK	2	Vertical

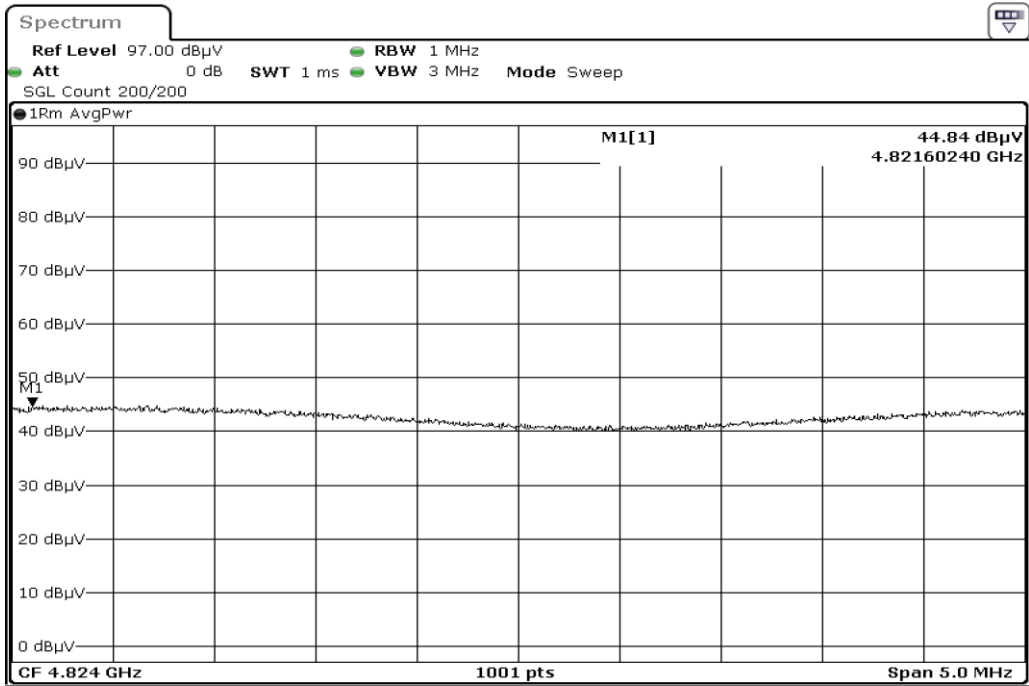

Date: 11.OCT.2023 18:39:34

1	Harmonic
---	----------

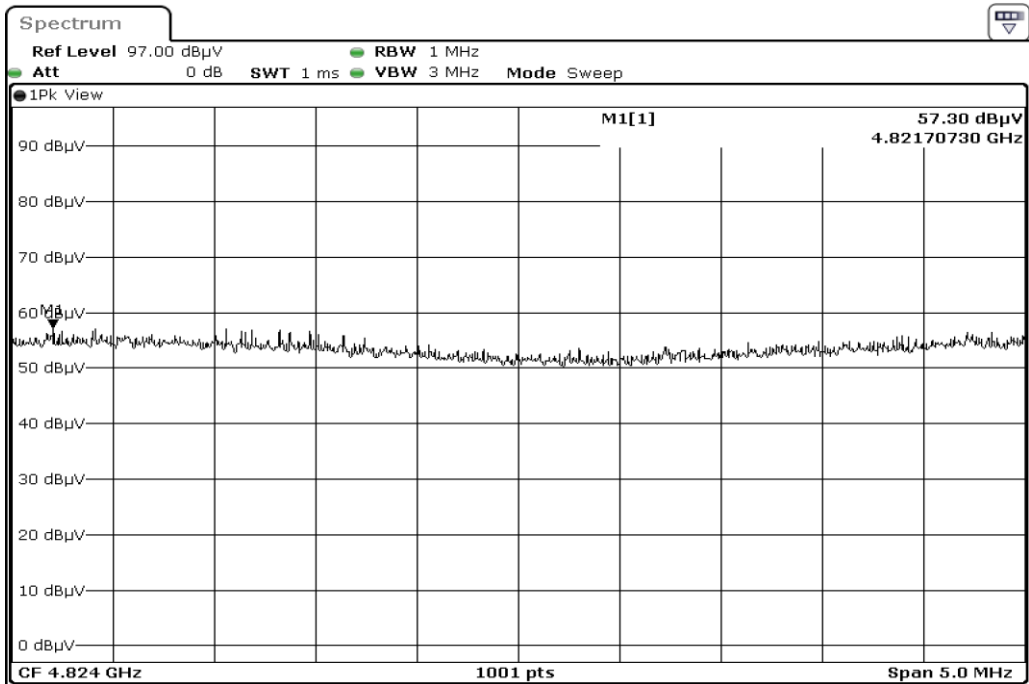

Date: 11.OCT.2023 18:39:30

2	Harmonic
---	----------



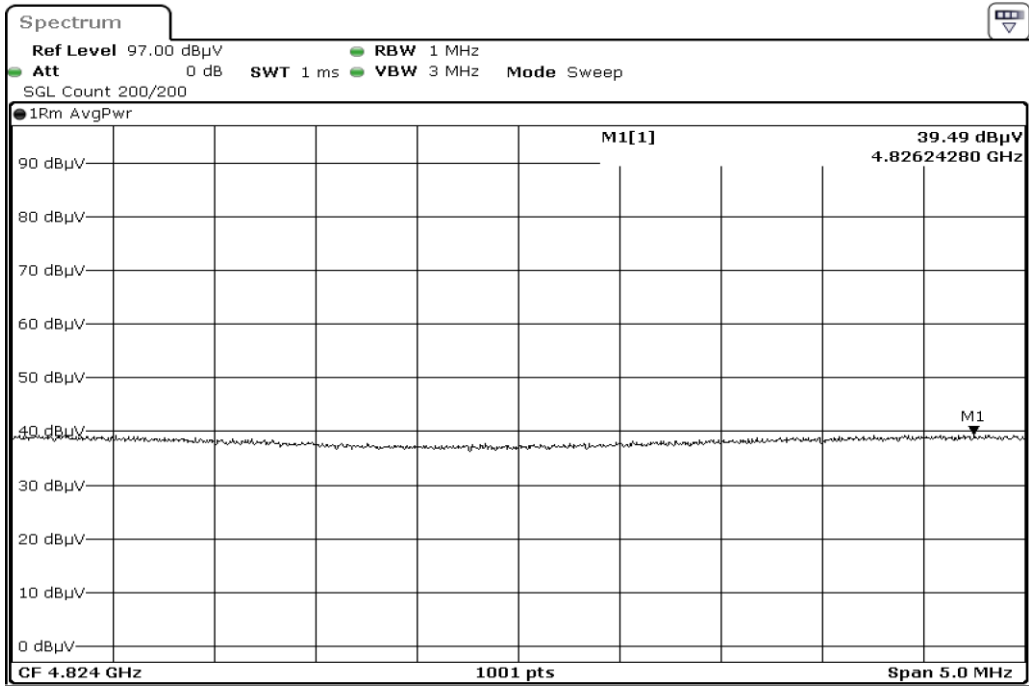

Date: 11.OCT.2023 19:26:30

3	Harmonic
---	----------

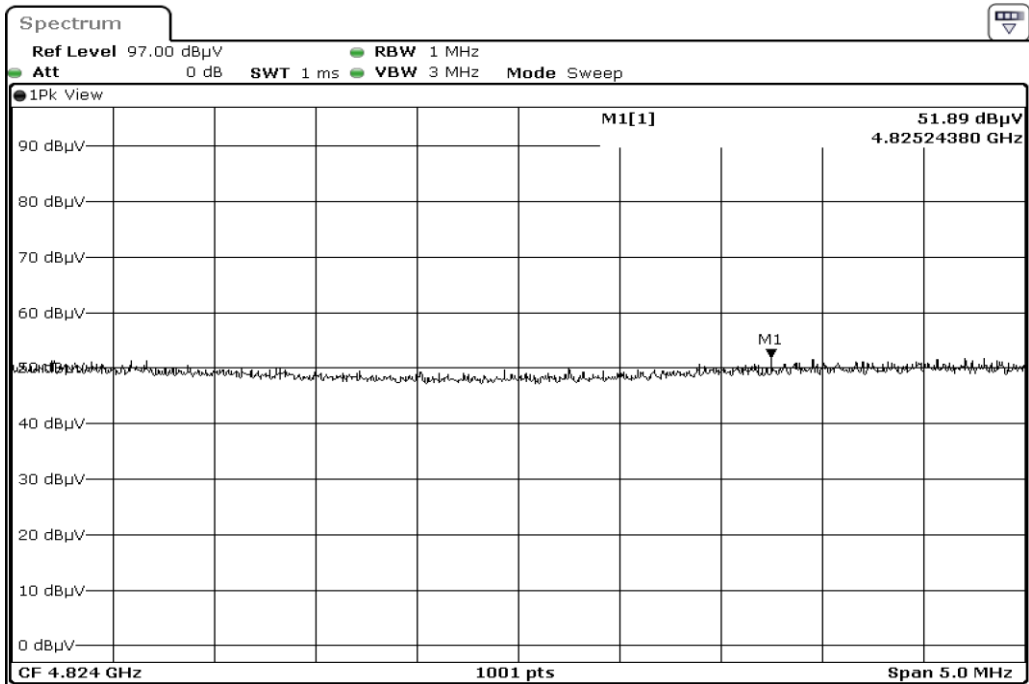

Date: 11.OCT.2023 19:26:26

4	Harmonic
---	----------

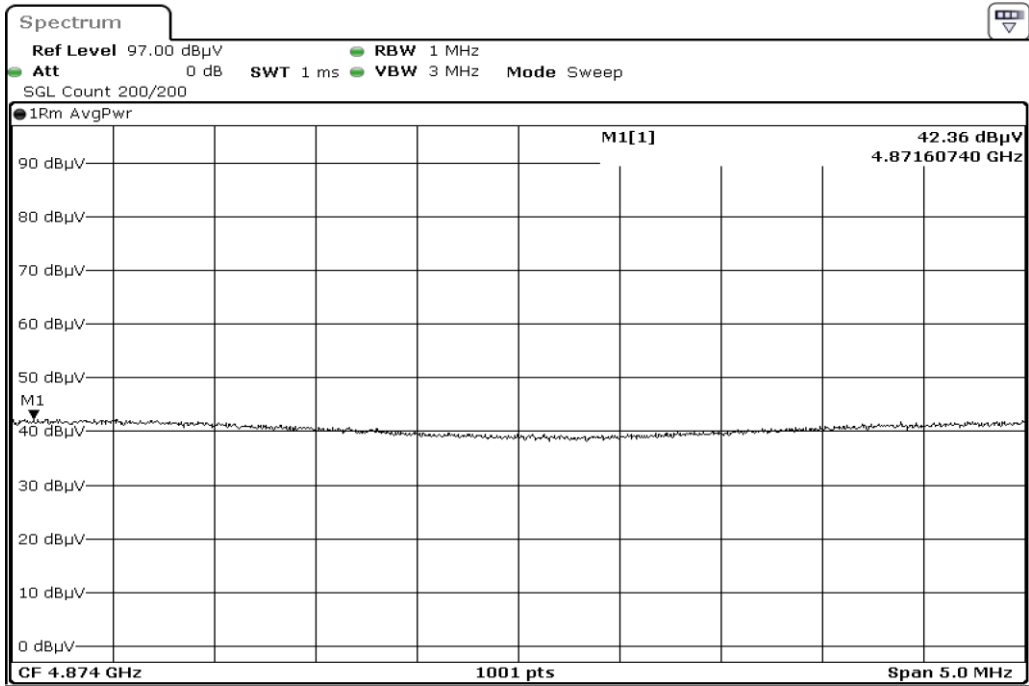

Date: 11.OCT.2023 18:43:28

5	Harmonic
---	----------

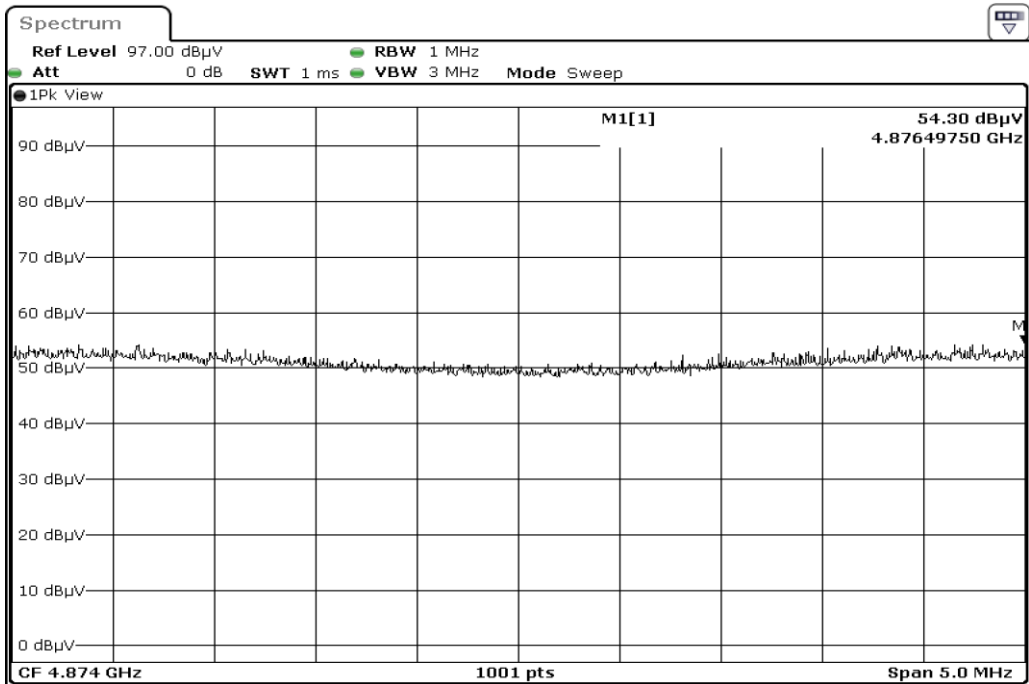

Date: 11.OCT.2023 18:43:23

6	Harmonic
---	----------

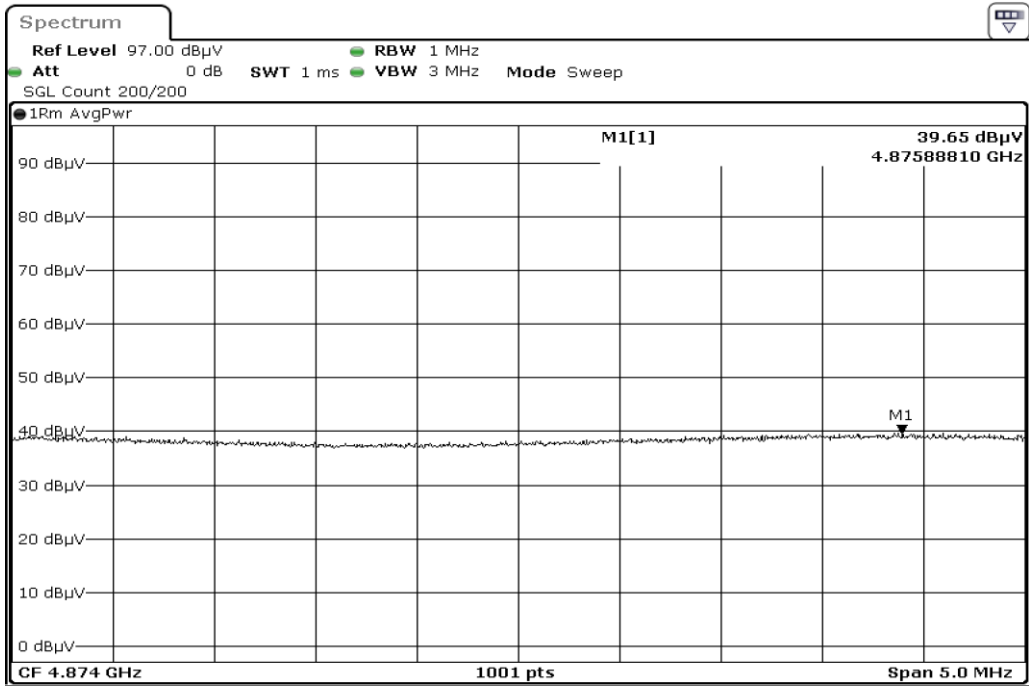

Date: 11.OCT.2023 19:09:34

7	Harmonic
---	----------

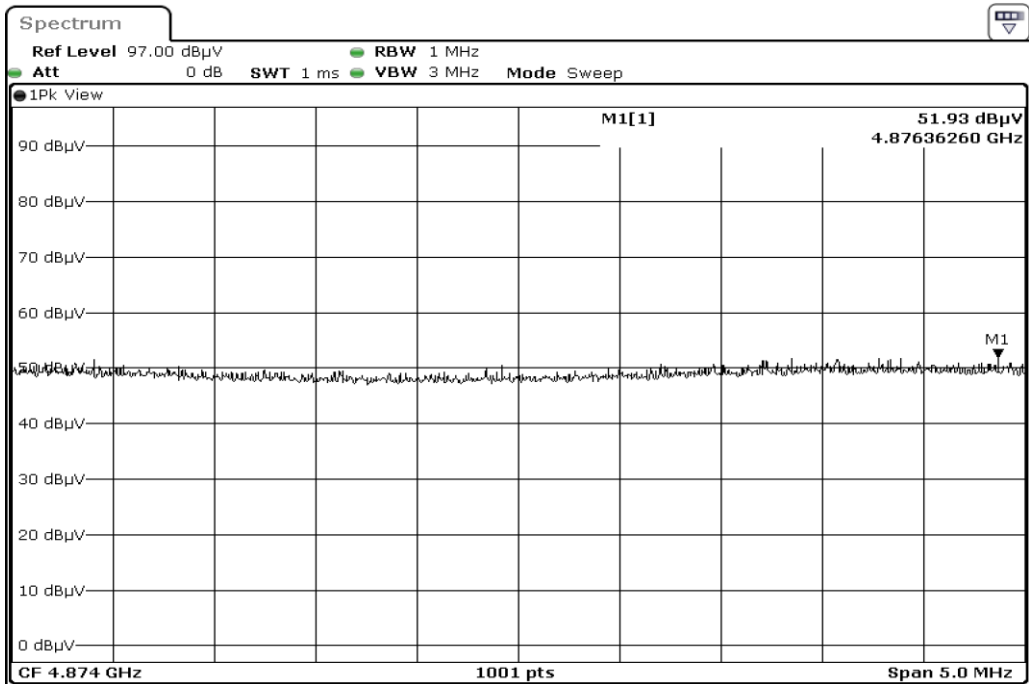

Date: 11.OCT.2023 19:09:30

8	Harmonic
---	----------

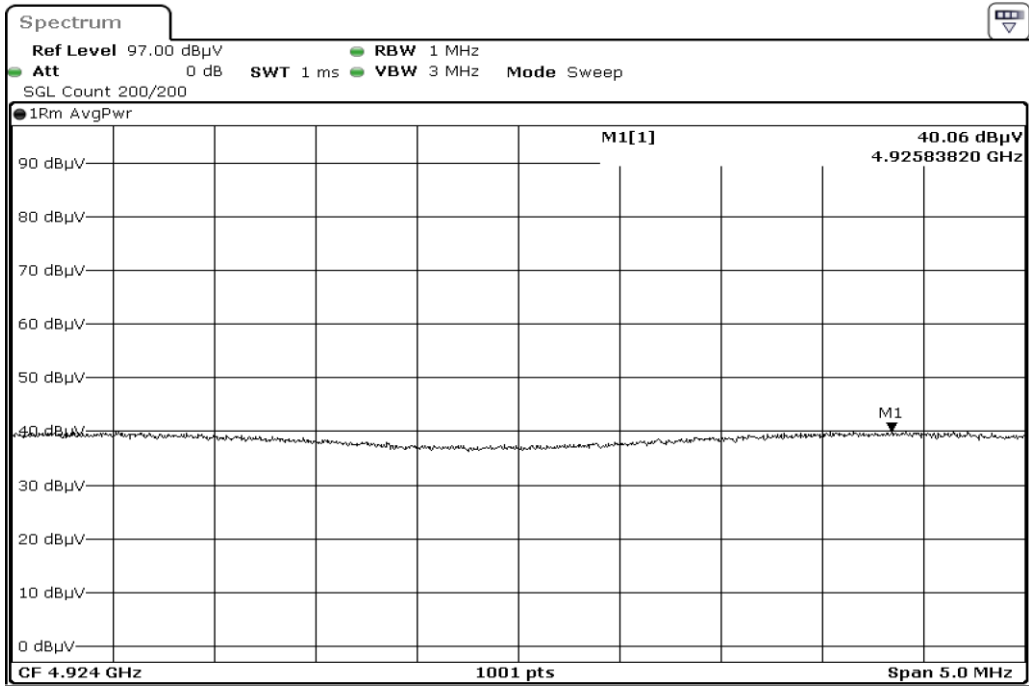

Date: 11.OCT.2023 18:50:11

9	Harmonic
---	----------

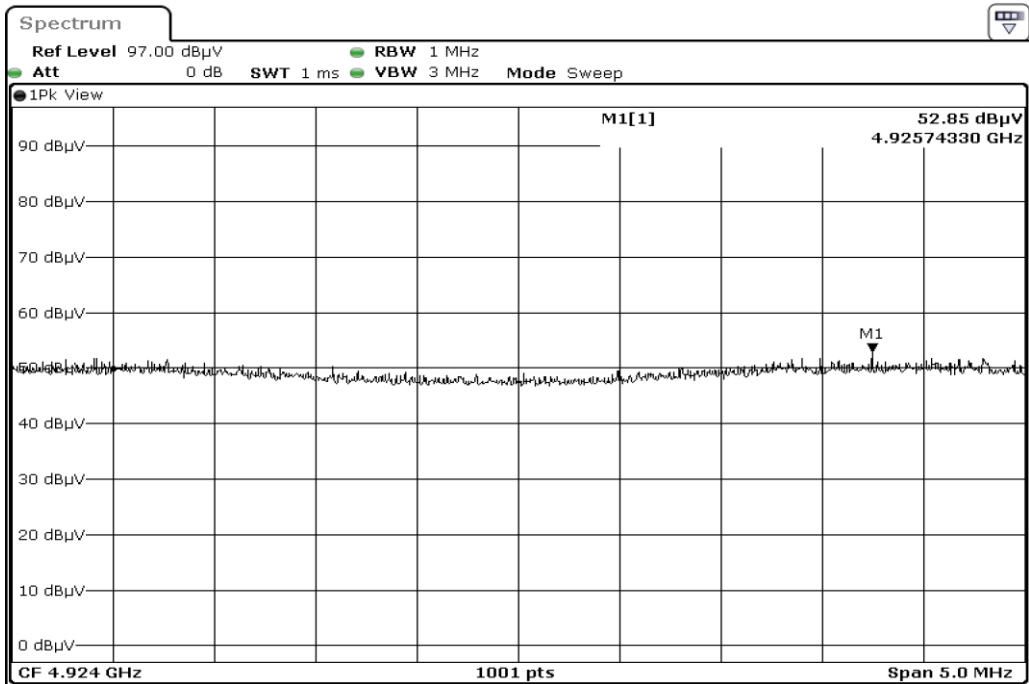

Date: 11.OCT.2023 18:50:07

10	Harmonic
----	----------

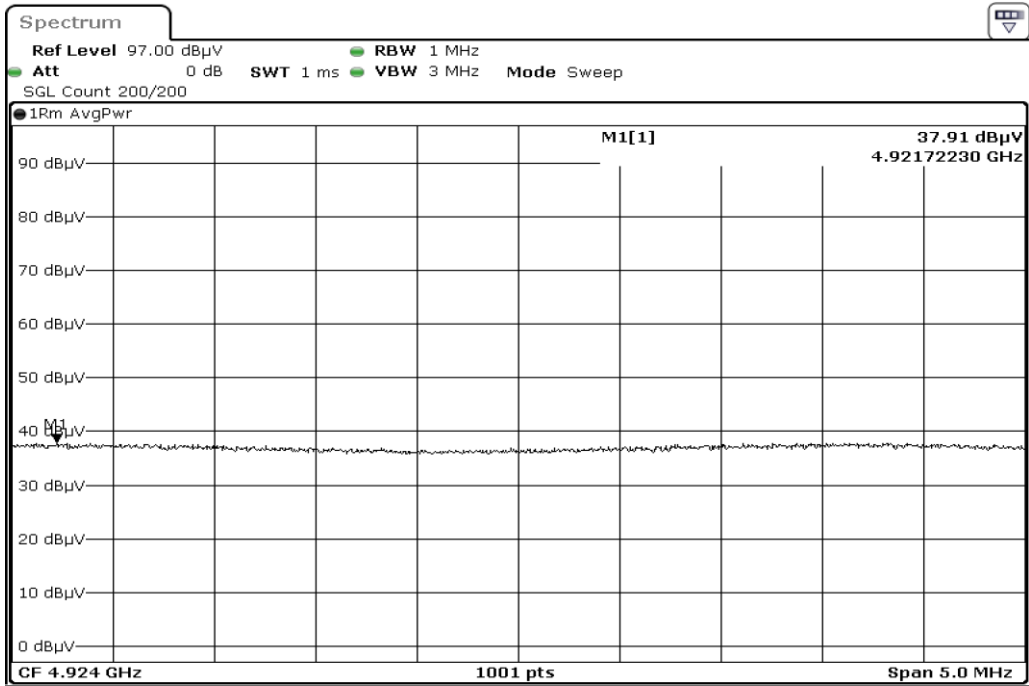

Date: 11.OCT.2023 19:04:47

11	Harmonic
----	----------

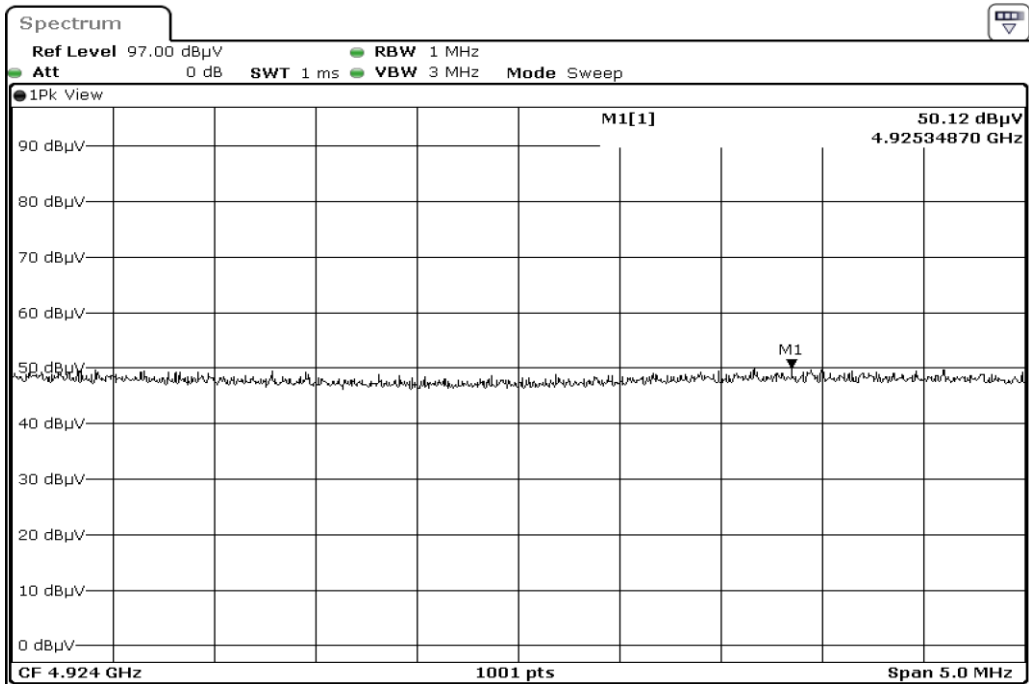

Date: 11.OCT.2023 19:04:43

12	Harmonic
----	----------

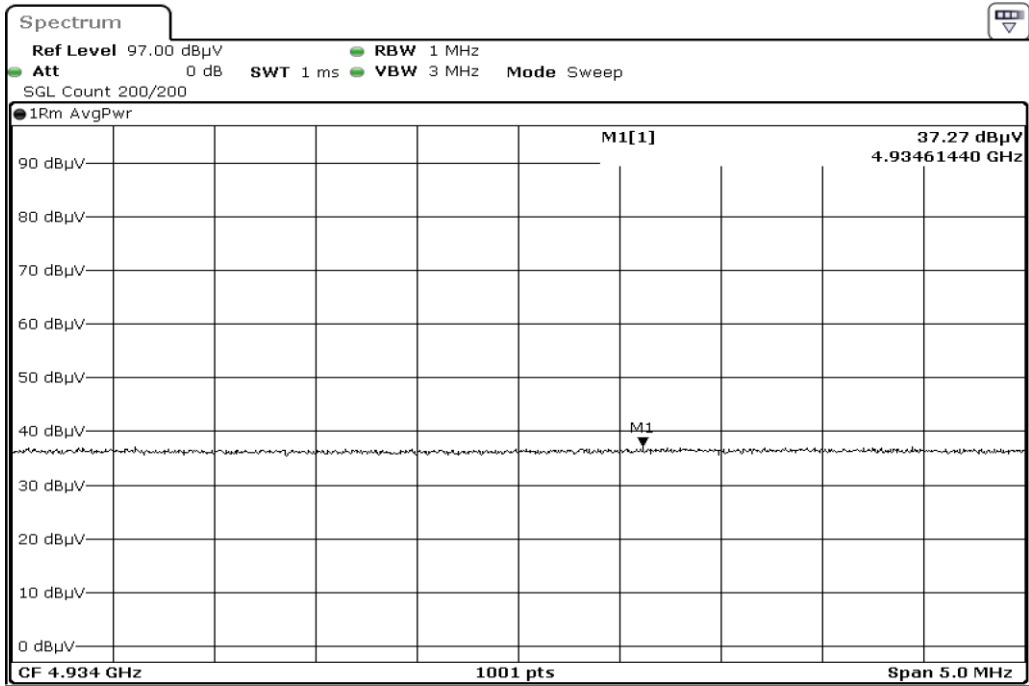

Date: 11.OCT.2023 18:06:14

13	Harmonic
----	----------

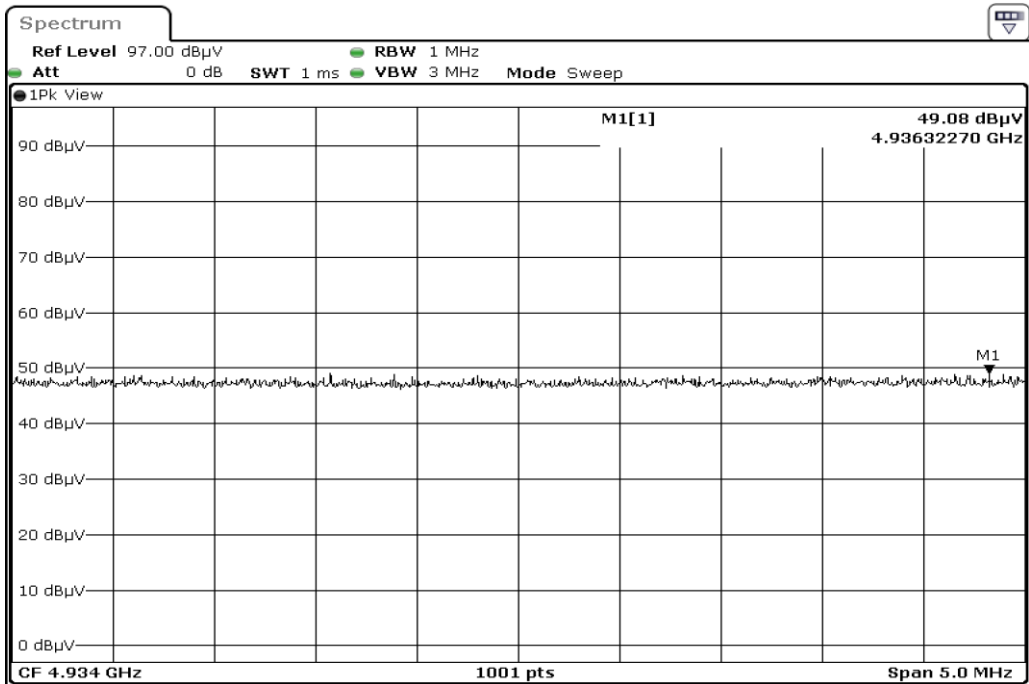

Date: 11.OCT.2023 18:06:09

14	Harmonic
----	----------

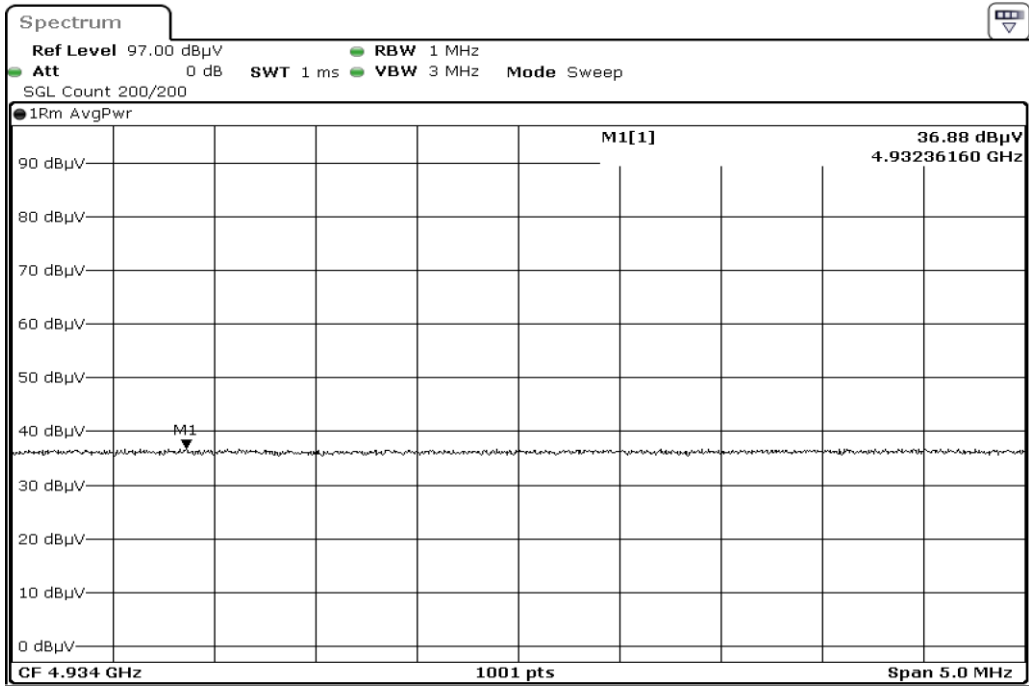

Date: 11.OCT.2023 17:58:14

15	Harmonic
----	----------

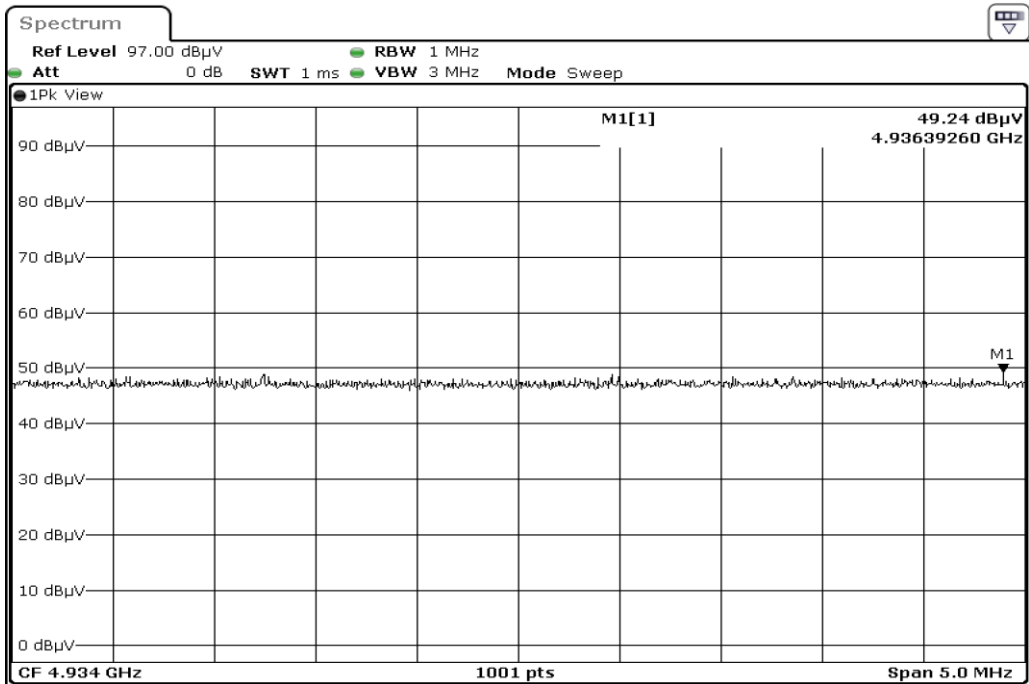

Date: 11.OCT.2023 17:58:10

16	Harmonic
----	----------

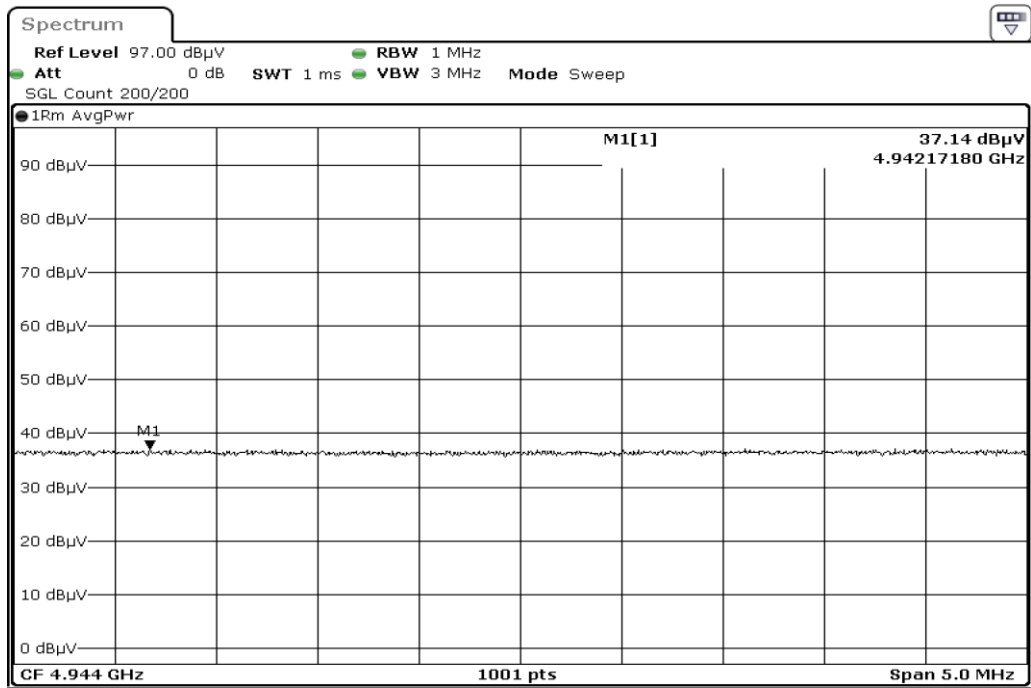

Date: 11.OCT.2023 18:13:00

17	Harmonic
----	----------

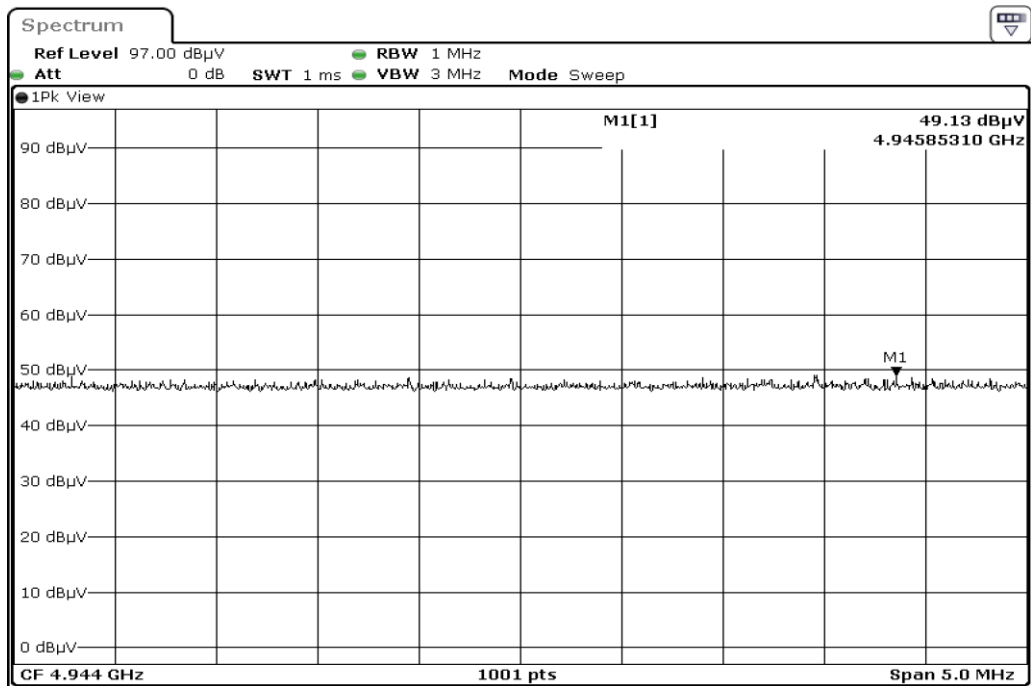

Date: 11.OCT.2023 18:12:55

18	Harmonic
----	----------



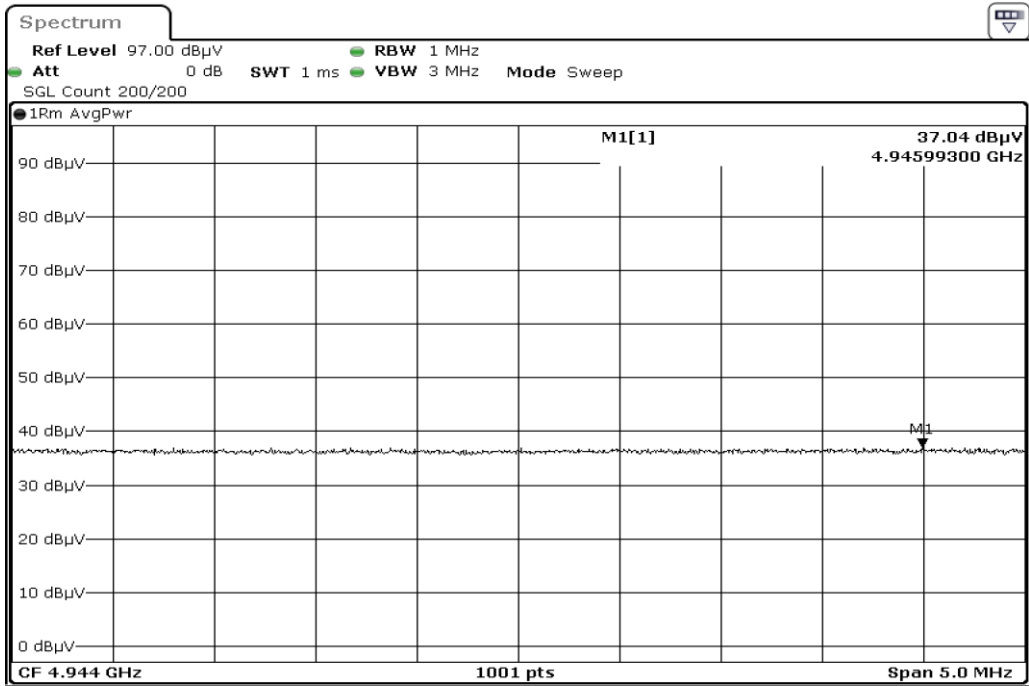

Date: 11.OCT.2023 17:51:25

19	Harmonic
----	----------

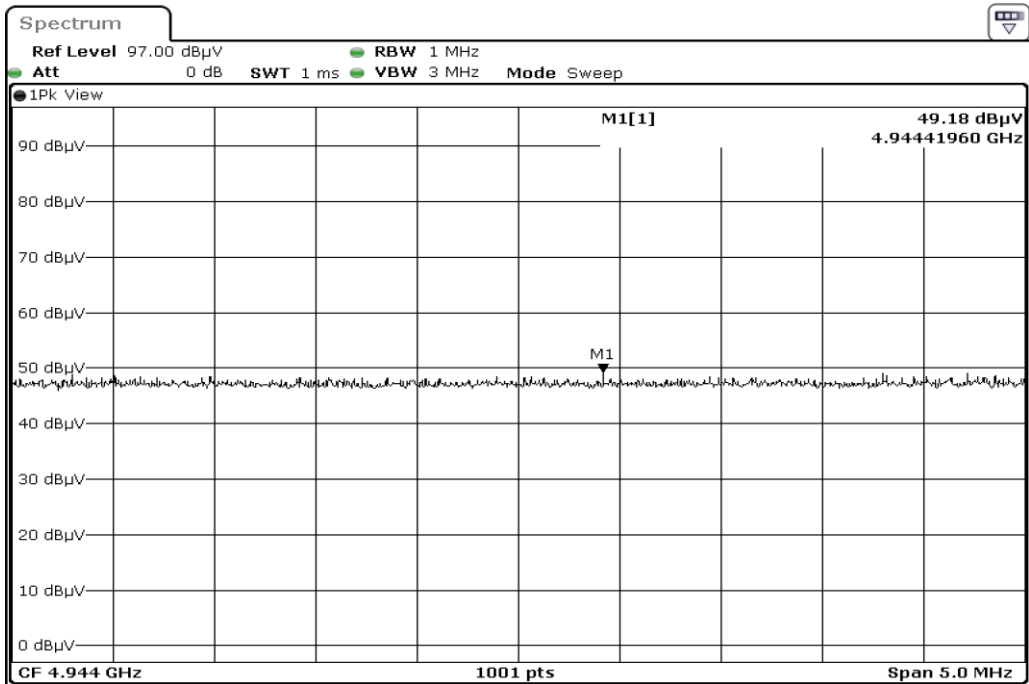

Date: 11.OCT.2023 17:51:21

20	Harmonic
----	----------

Test Band				WLAN_2.4GHz			
Antenna				Ant 1 + Ant 2			
Test Parameters							
Test Item	No.	Mode	Frquency	Bandwidth	Detector	Harmonic	Polarization
Harmonic	1	802.11 n20	4824	20 MHz	AVG	2	Horizontal
Harmonic	2	802.11 n20	4824	20 MHz	PEAK	2	Horizontal
Harmonic	3	802.11 n20	4824	20 MHz	AVG	2	Vertical
Harmonic	4	802.11 n20	4824	20 MHz	PEAK	2	Vertical
Harmonic	5	802.11 n20	4874	20 MHz	AVG	2	Horizontal
Harmonic	6	802.11 n20	4874	20 MHz	PEAK	2	Horizontal
Harmonic	7	802.11 n20	4874	20 MHz	AVG	2	Vertical
Harmonic	8	802.11 n20	4874	20 MHz	PEAK	2	Vertical
Harmonic	9	802.11 n20	4924	20 MHz	AVG	2	Horizontal
Harmonic	10	802.11 n20	4924	20 MHz	PEAK	2	Horizontal
Harmonic	11	802.11 n20	4924	20 MHz	AVG	2	Vertical
Harmonic	12	802.11 n20	4924	20 MHz	PEAK	2	Vertical
Harmonic	13	802.11 n20	4934	20 MHz	AVG	2	Horizontal
Harmonic	14	802.11 n20	4934	20 MHz	PEAK	2	Horizontal
Harmonic	15	802.11 n20	4934	20 MHz	AVG	2	Vertical
Harmonic	16	802.11 n20	4934	20 MHz	PEAK	2	Vertical
Harmonic	17	802.11 n20	4944	20 MHz	AVG	2	Horizontal
Harmonic	18	802.11 n20	4944	20 MHz	PEAK	2	Horizontal
Harmonic	19	802.11 n20	4944	20 MHz	AVG	2	Vertical
Harmonic	20	802.11 n20	4944	20 MHz	PEAK	2	Vertical

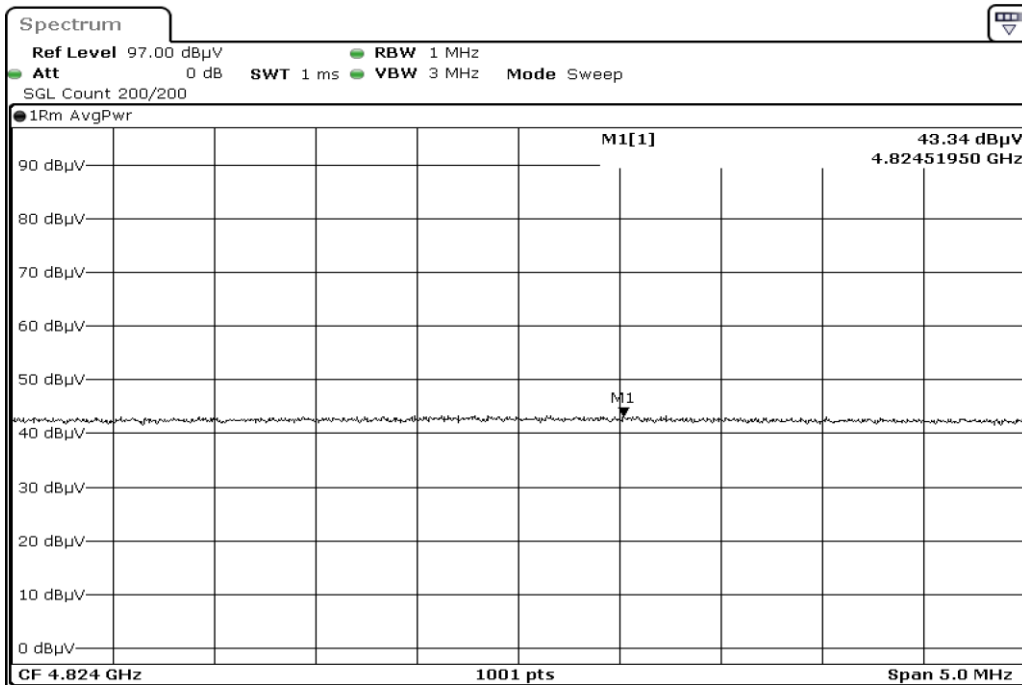

Date: 12.OCT.2023 09:23:47

1	Harmonic
---	----------

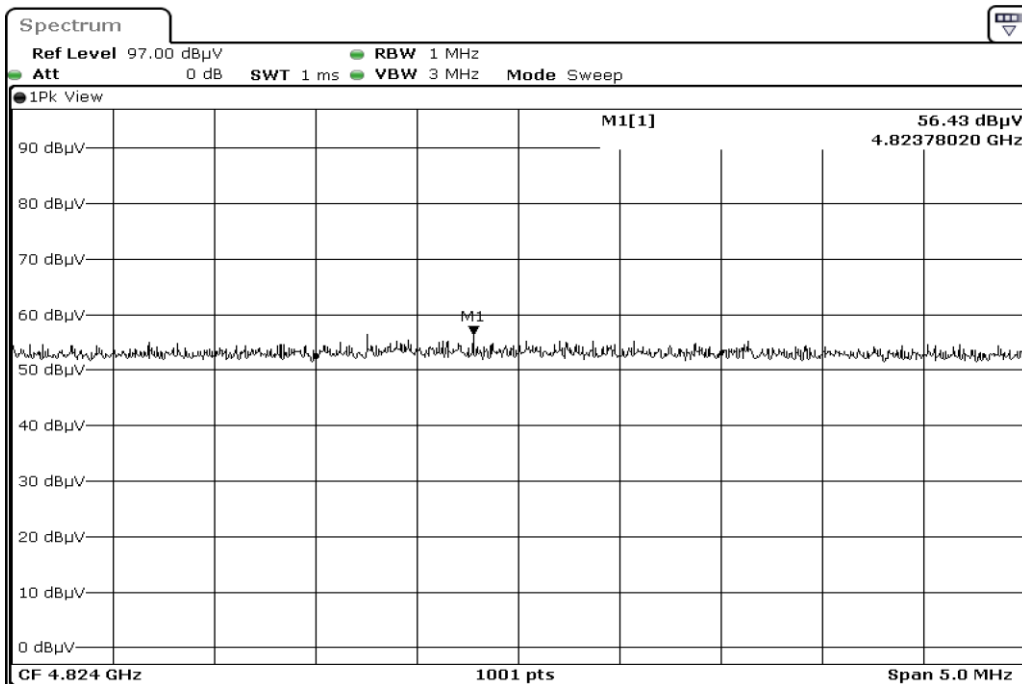

Date: 12.OCT.2023 09:23:43

2	Harmonic
---	----------

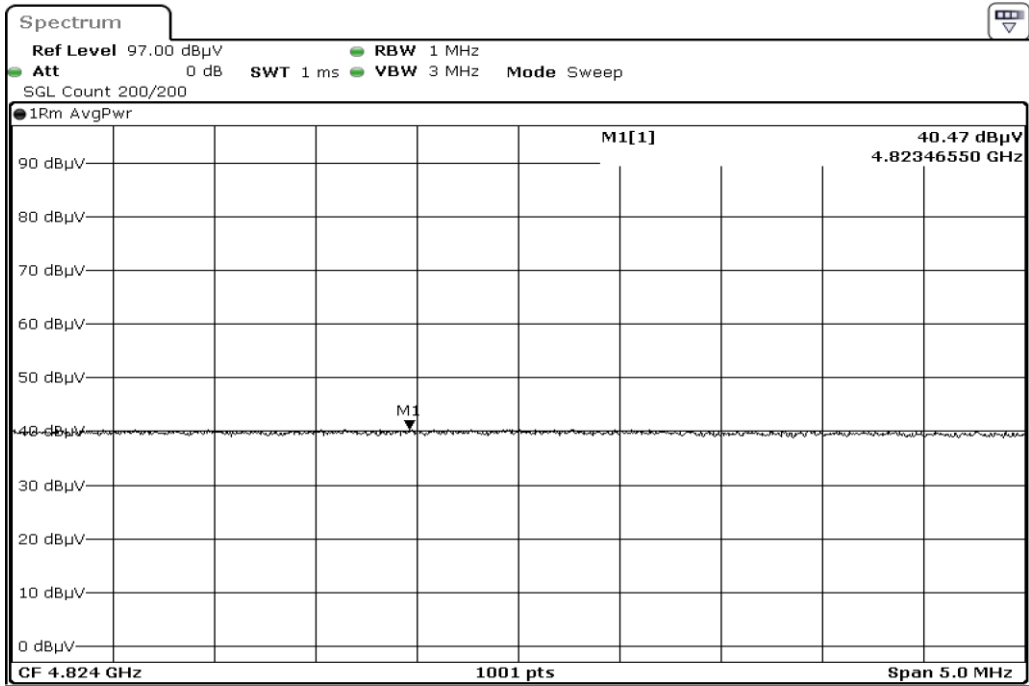

Date: 12.OCT.2023 10:16:55

3	Harmonic
---	----------

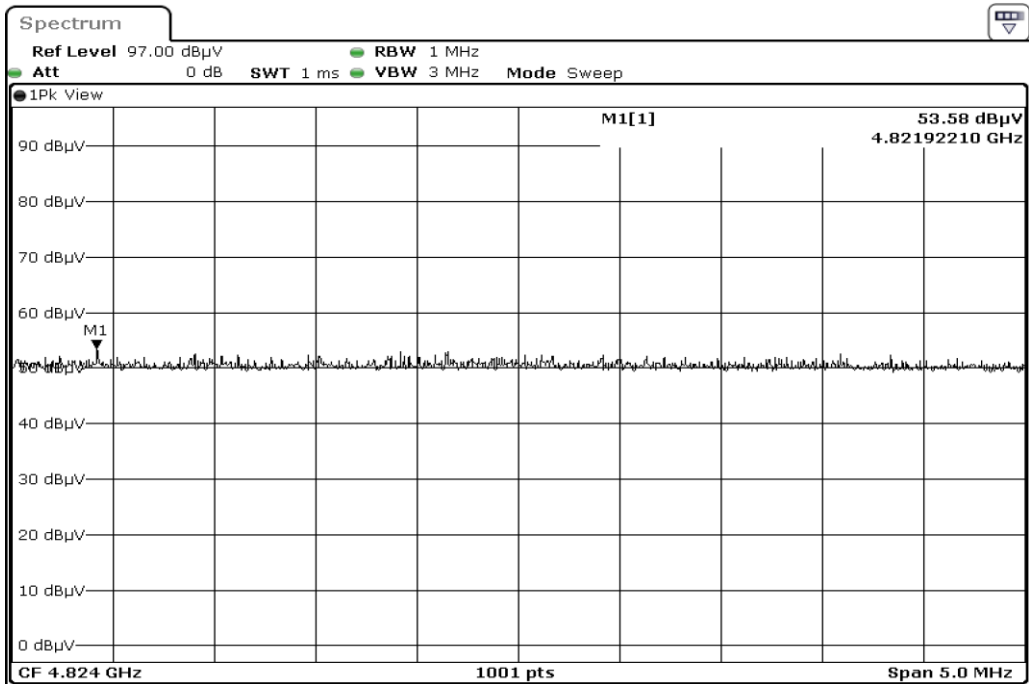

Date: 12.OCT.2023 10:16:51

4	Harmonic
---	----------

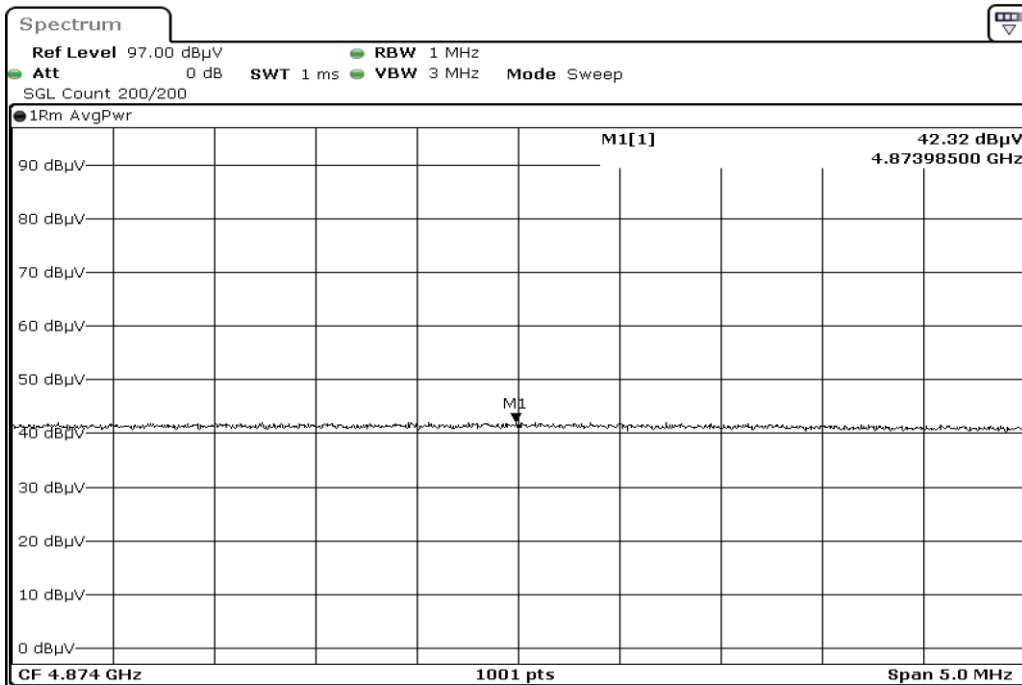

Date: 12.OCT.2023 09:27:50

5	Harmonic
---	----------

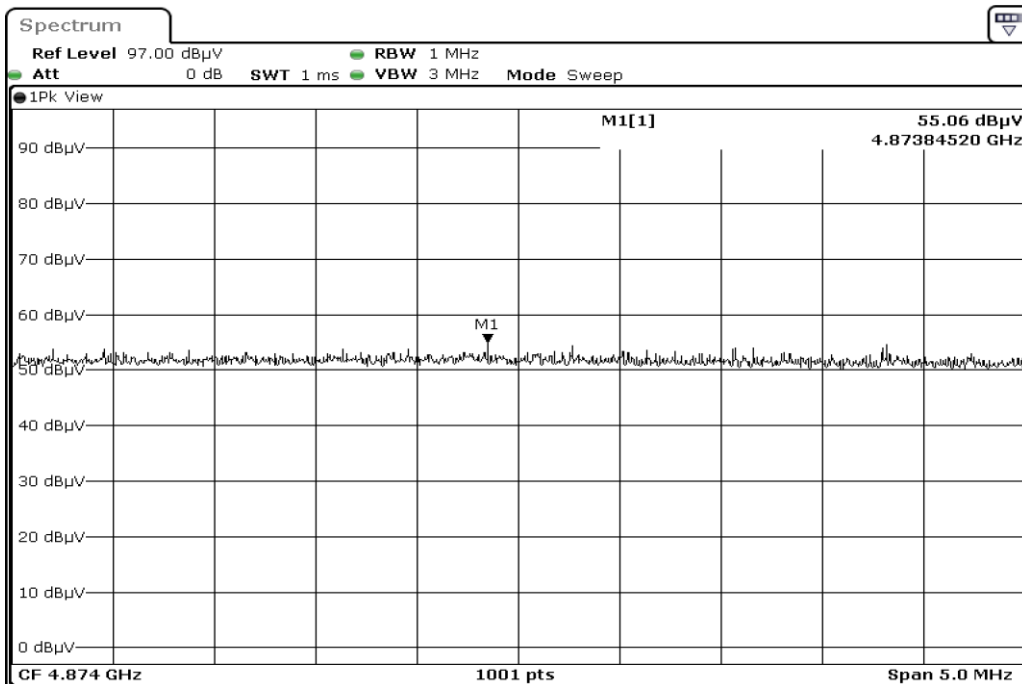

Date: 12.OCT.2023 09:27:46

6	Harmonic
---	----------

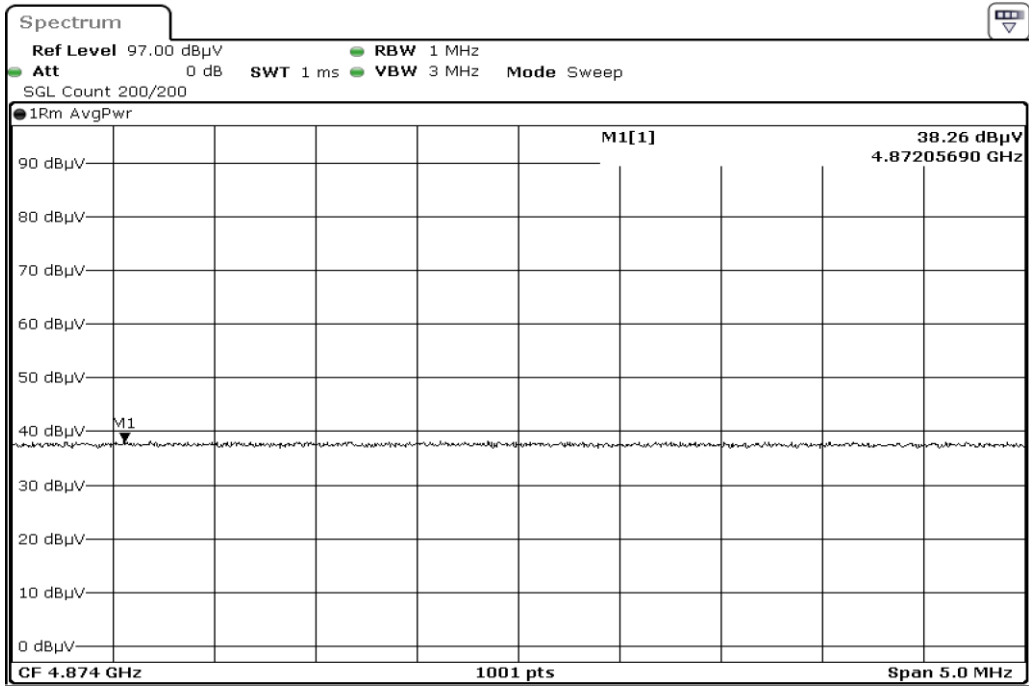

Date: 12.OCT.2023 10:10:35

7	Harmonic
---	----------

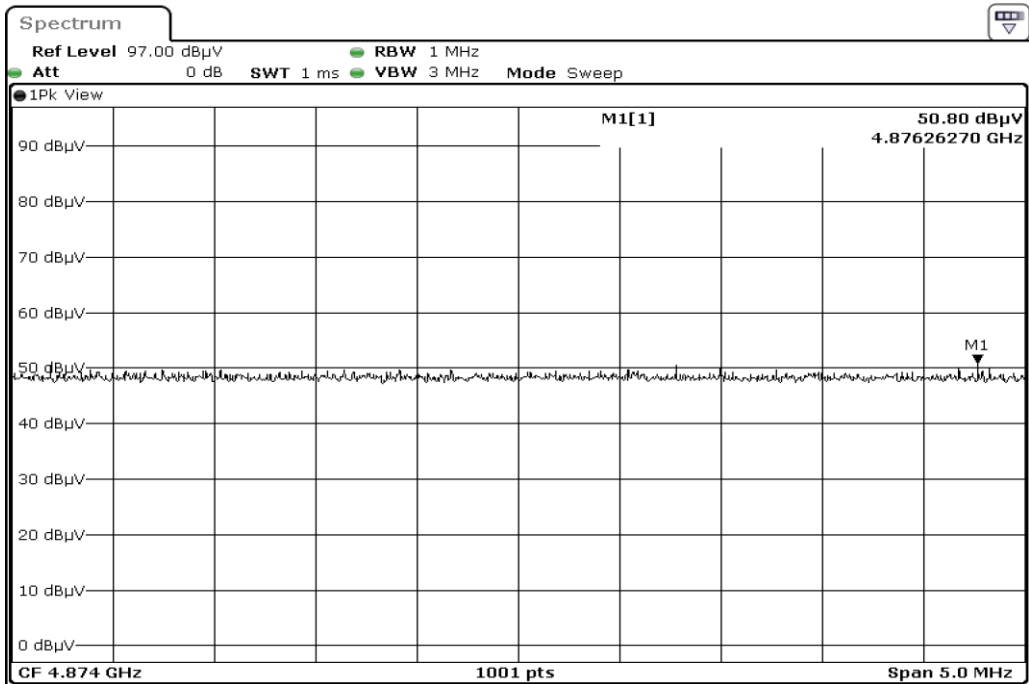

Date: 12.OCT.2023 10:10:30

8	Harmonic
---	----------

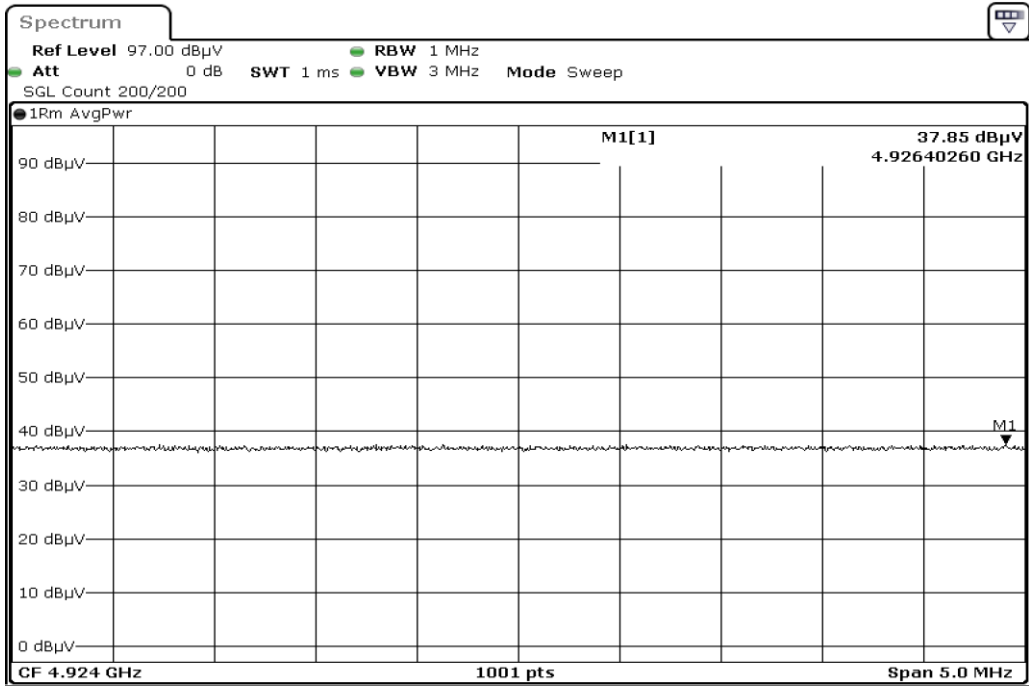

Date: 12.OCT.2023 09:34:18

9	Harmonic
---	----------

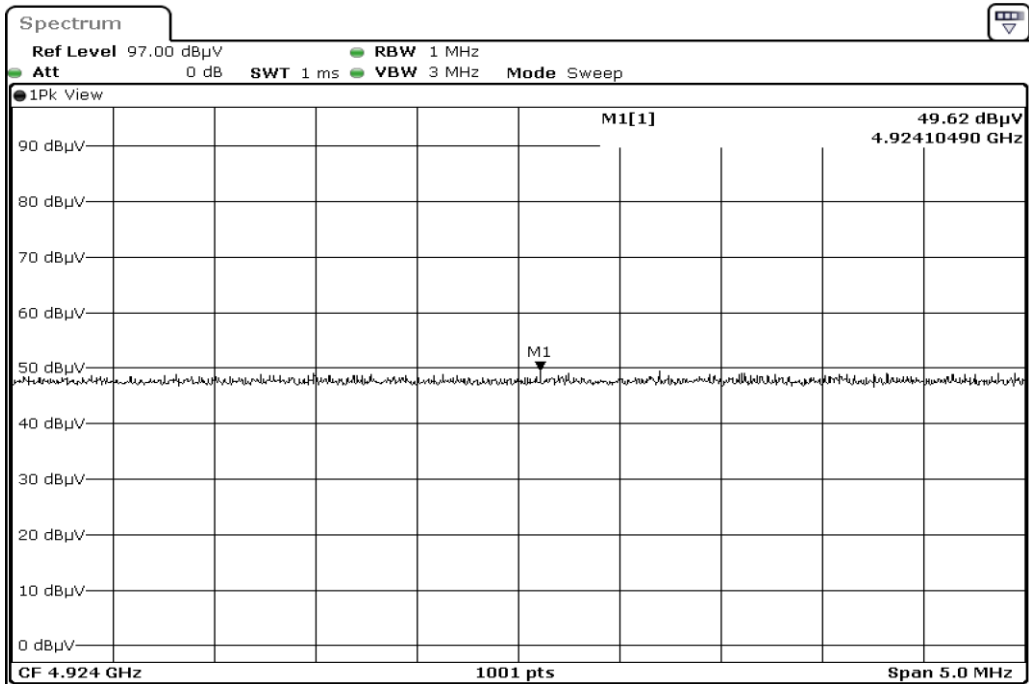

Date: 12.OCT.2023 09:34:13

10	Harmonic
----	----------

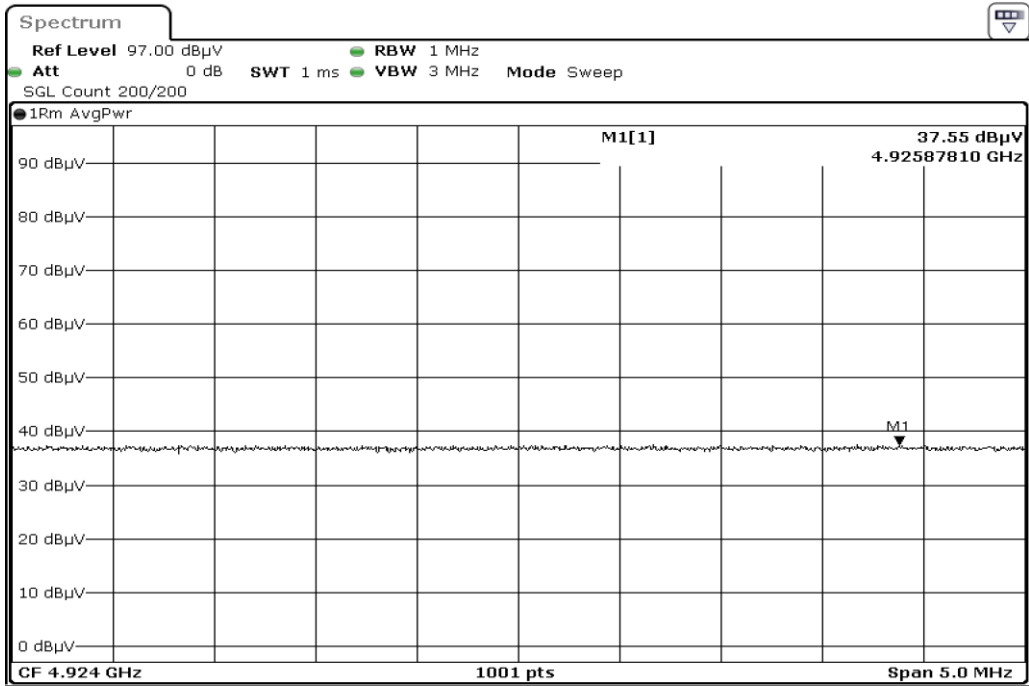

Date: 12.OCT.2023 10:06:41

11	Harmonic
----	----------

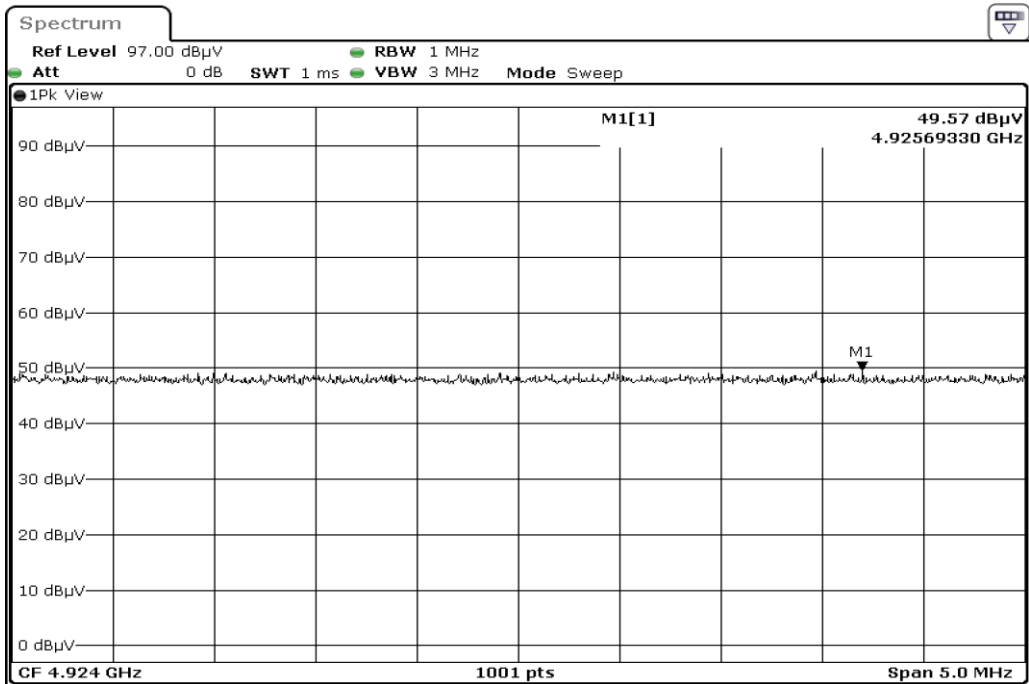

Date: 12.OCT.2023 10:06:37

12	Harmonic
----	----------



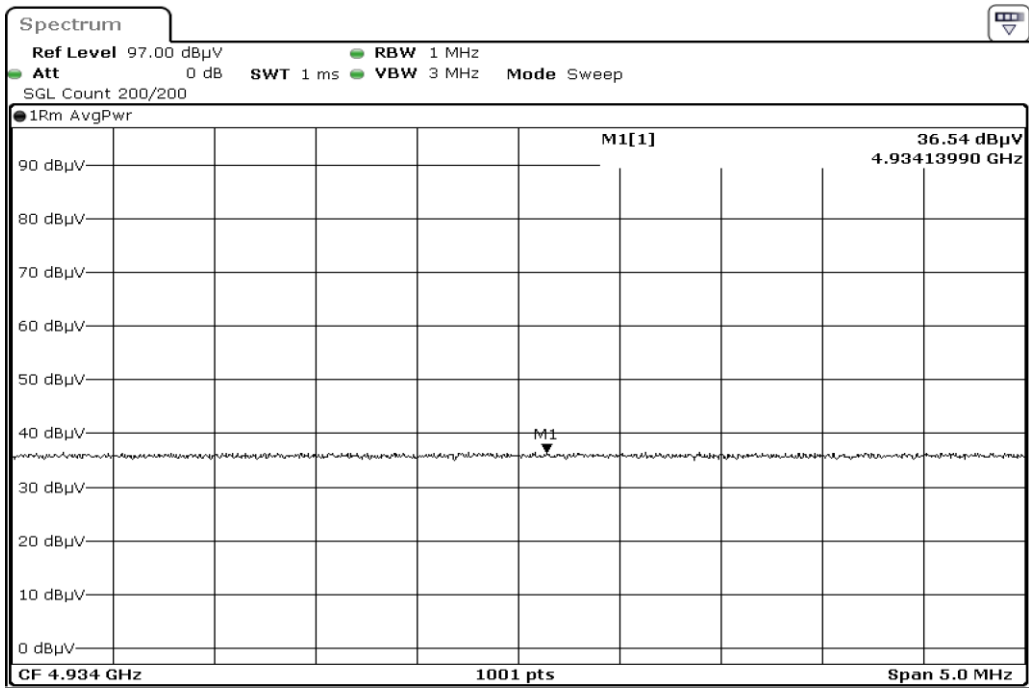

Date: 11.OCT.2023 20:06:27

13	Harmonic
----	----------

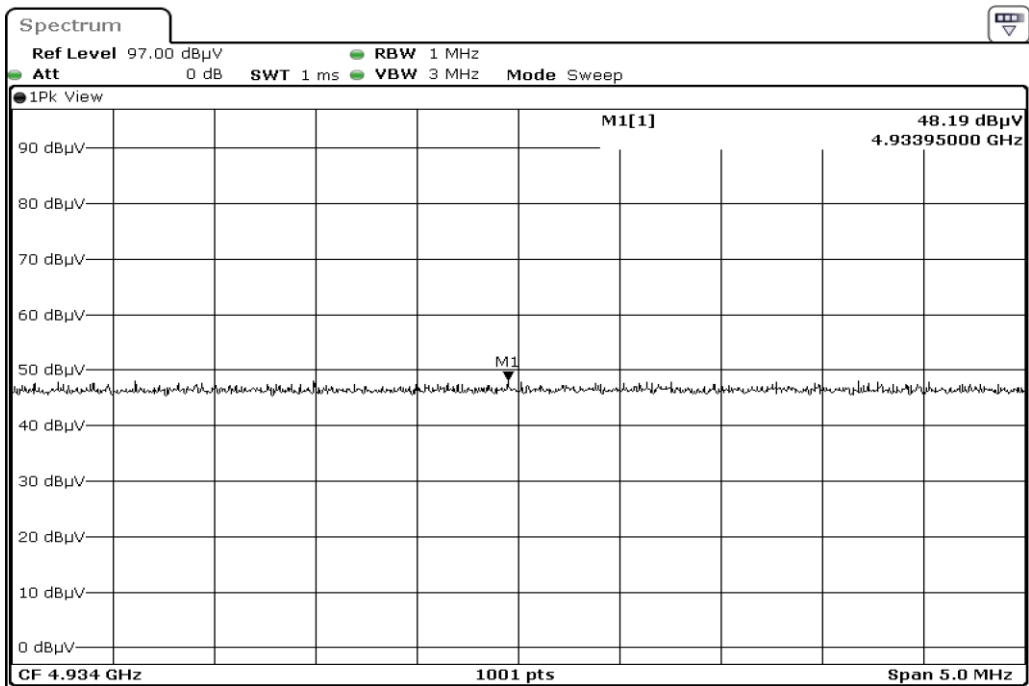

Date: 11.OCT.2023 20:06:23

14	Harmonic
----	----------

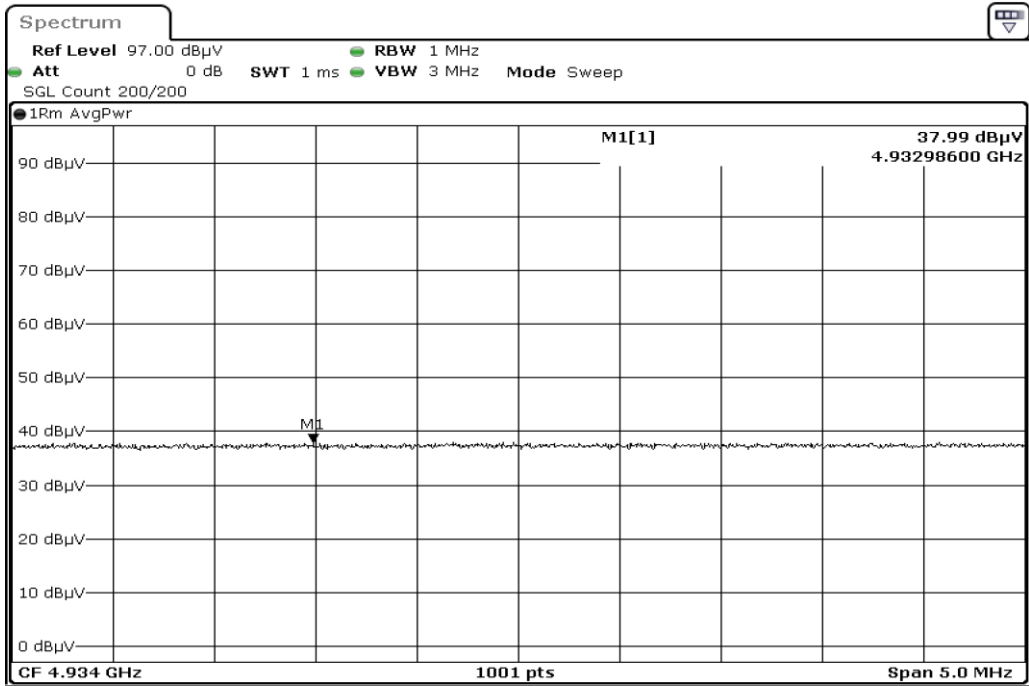

Date: 12.OCT.2023 09:14:42

15	Harmonic
----	----------

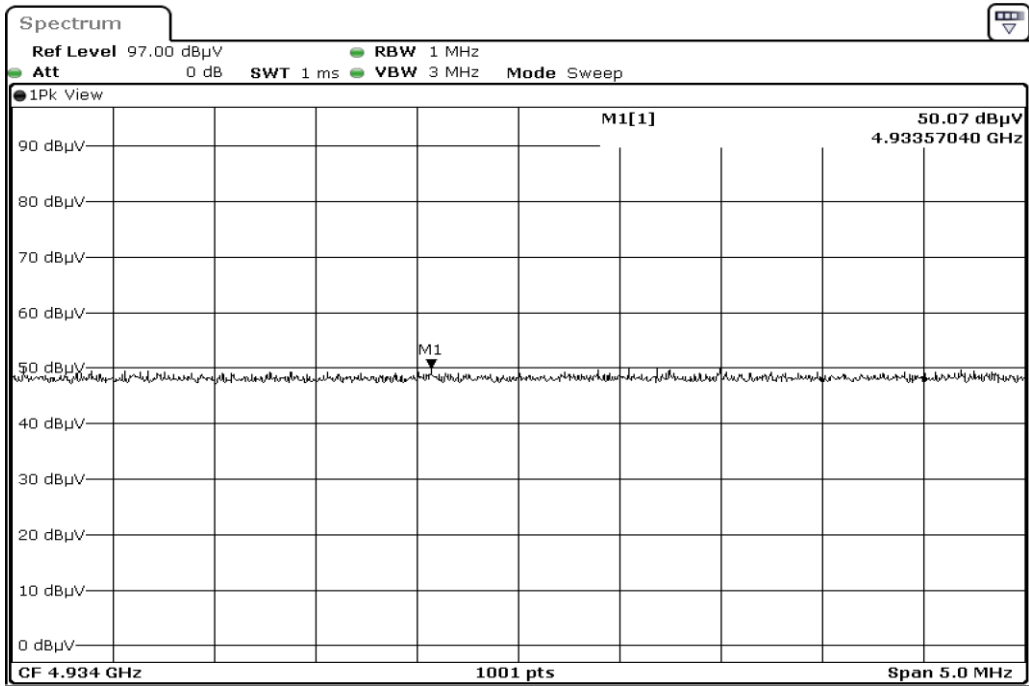

Date: 12.OCT.2023 09:14:38

16	Harmonic
----	----------

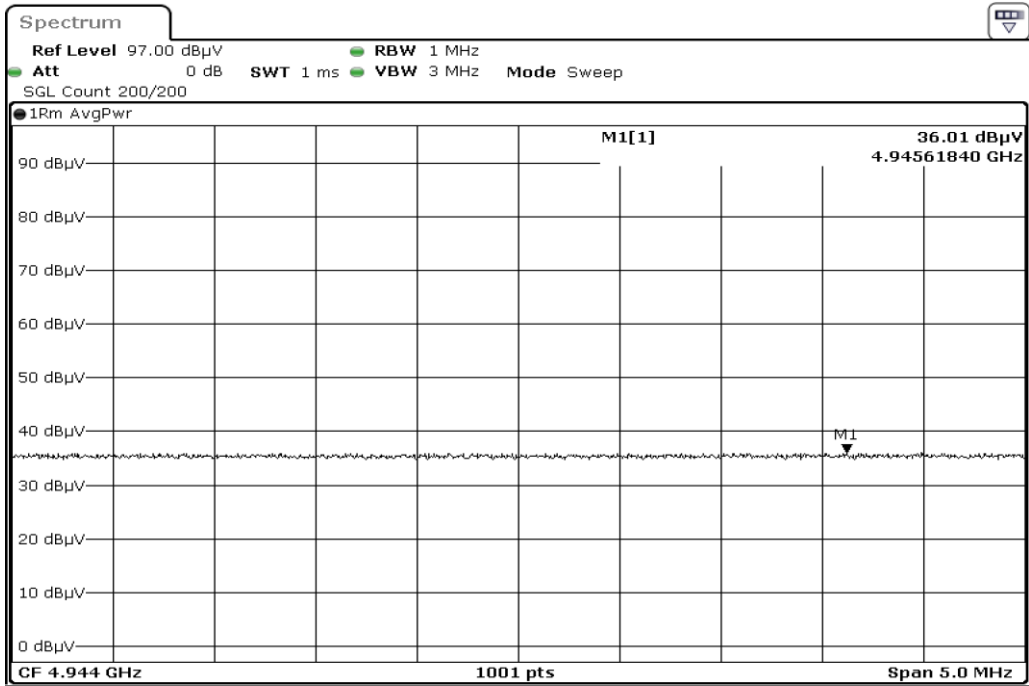

Date: 11.OCT.2023 20:13:07

17	Harmonic
----	----------

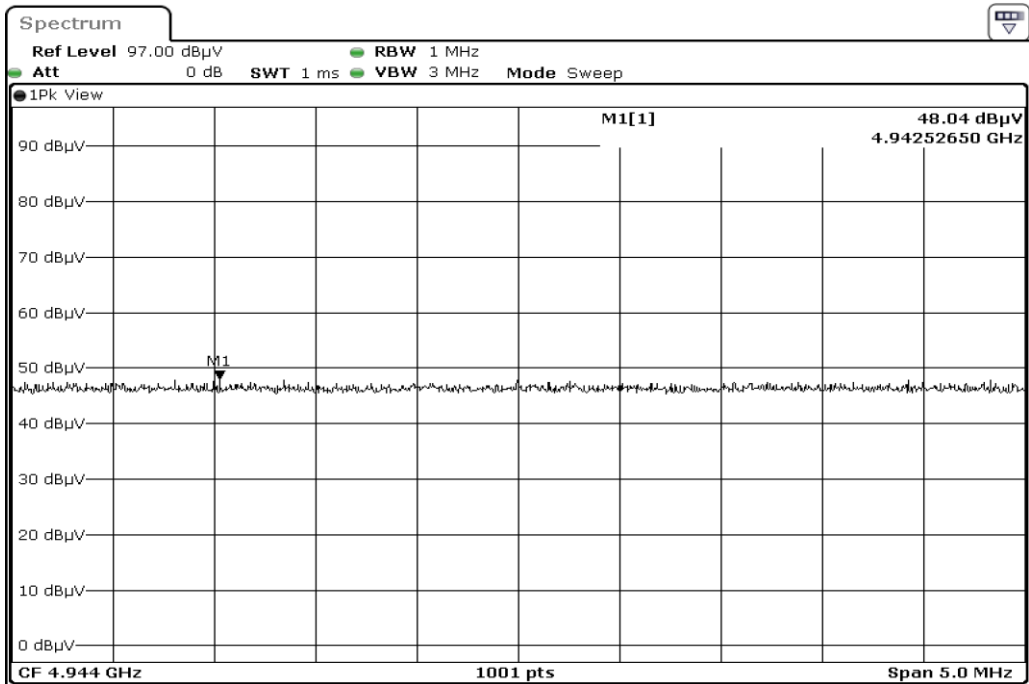

Date: 11.OCT.2023 20:13:02

18	Harmonic
----	----------

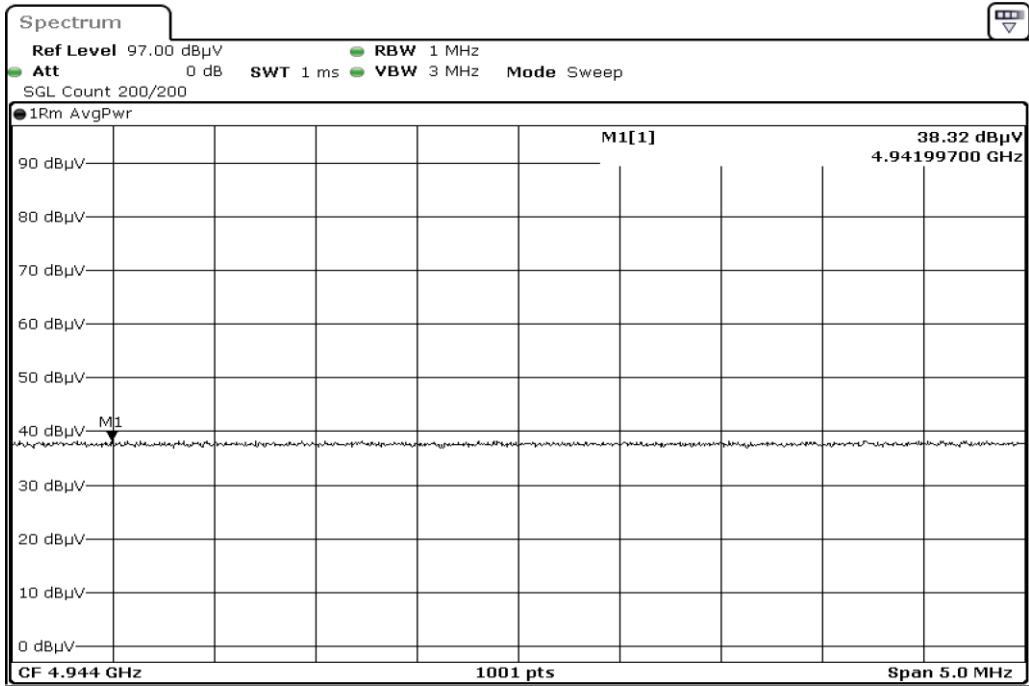

Date: 12.OCT.2023 09:07:01

19	Harmonic
----	----------

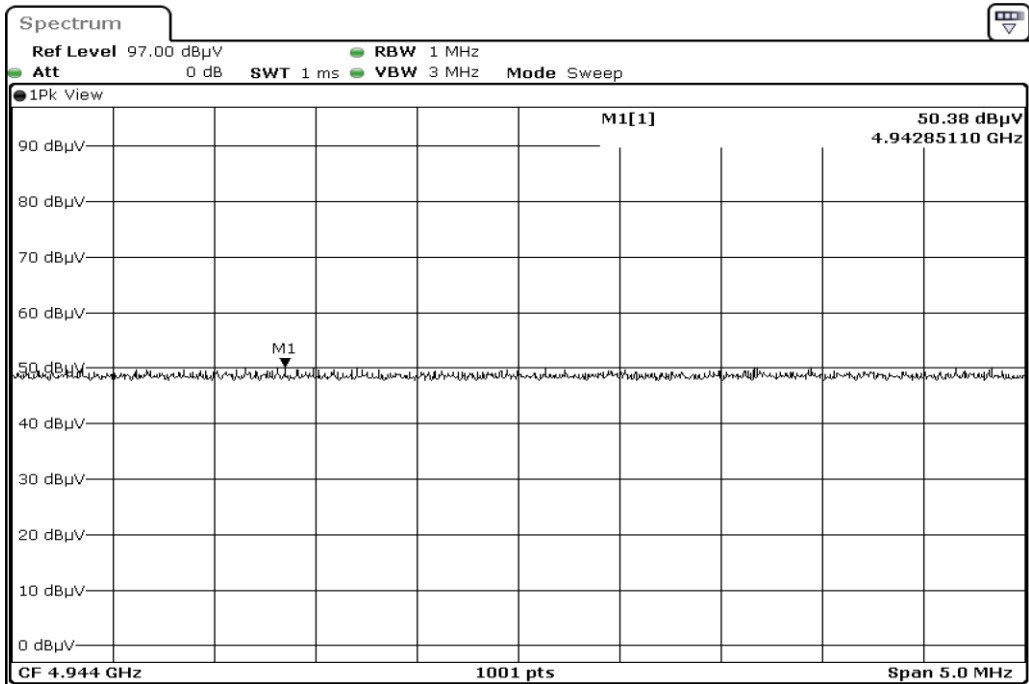

Date: 12.OCT.2023 09:06:56

20	Harmonic
----	----------