

TEST REPORT



CTK Co., Ltd.
(Ho-dong), 113, Yejik-ro, Cheoin-gu,
Yongin-si, Gyeonggi-do, Korea
Tel: +82-31-339-9970
Fax: +82-31-624-9501

Report No.:
CTK-2020-04549
Page (1) / (26) Pages

1. Client

- Name : Samsung Electronics Co Ltd
- Address : 19 Chapin Rd, Building D. Pine Brook, New Jersey, United States
- Date of Receipt : 2020-10-26

2. Manufacturer

- Name : Samsung Electronics Co., Ltd.
- Address : 129, Samsung-ro, Yeongtong-gu, Suwon-si, Gyeonggi-do, 16677, Korea

3. Use of Report : For FCC Conformance / ISED Conformance

4. Test Sample / Model: Wi-Fi/BT Transceiver / WCA942M



5. Date of Test : 2020-11-05 to 2020-11-25

6. Test Standard(method) used : FCC 47 CFR part 15 subpart C 15.247
RSS-247 & RSS-Gen

7. Testing Environment: Temp.: (23 ± 1) °C, Humidity: (49 ± 3) % R.H.

8. Test Results : Compliance

The results shown in this test report refer only to the sample(s) tested unless otherwise stated. This Test Report cannot be reproduced, except in full.

Affirmation	Tested by  Ji-Hye, Kim: (Signature)	Technical Manager  Won-Jae, Hwang: (Signature)
-------------	------------------------------------------------------------------------------------------------------------------------------	-------------------------------------------------------------------------------------------------------------------------------------------

2020-11-25

Republic of KOREA **CTK Co., Ltd.**



CTK Co., Ltd.
(Ho-dong), 113, Yejik-ro, Cheoin-gu,
Yongin-si, Gyeonggi-do, Korea
Tel: +82-31-339-9970
Fax: +82-31-624-9501

Report No.:
CTK-2020-04549
Page (2) / (26) Pages

REPORT REVISION HISTORY

Date	Revision	Page No
2020-11-25	Issued (CTK-2020-04549)	all

This report shall not be reproduced except in full, without the written approval of CTK Co., Ltd. This document may be altered or revised by CTK Co., Ltd. personnel only, and shall be noted in the revision section of the document. Any alteration of this document not carried out by CTK Co., Ltd. will constitute fraud and shall nullify the document.



CTK Co., Ltd.
(Ho-dong), 113, Yejik-ro, Cheoin-gu,
Yongin-si, Gyeonggi-do, Korea
Tel: +82-31-339-9970
Fax: +82-31-624-9501

Report No.:
CTK-2020-04549
Page (3) / (26) Pages

CONTENTS

1. General Product Description	4
1.1 Client Information	4
1.2 Product Information.....	4
1.3 Peripheral Devices	5
1.4 Model Differences.....	5
2. Facility and Accreditations.....	6
2.1 Test Facility	6
2.2 Laboratory Accreditations and Listings.....	6
2.3 Calibration Details of Equipment Used for Measurement.....	6
3. Summary of tests.....	7
3.1 Description of Dynamic Frequency Selection Test	8
3.2 Measuring Systematic diagram	12
3.3 Description of EUT.....	13
3.4 Test Results.....	14
3.4.1 Test Channel	14
3.4.2 Radar waveform, Traffic and Dwell time per bin	14
3.4.3 Channel move time and Channel closing Transmission time	20
3.4.4 Client beacon test	24
APPENDIX A – Test Equipment Used For Tests	26



CTK Co., Ltd.
 (Ho-dong), 113, Yejik-ro, Cheoin-gu,
 Yongin-si, Gyeonggi-do, Korea
 Tel: +82-31-339-9970
 Fax: +82-31-624-9501

Report No.:
 CTK-2020-04549
 Page (4) / (26) Pages

1. General Product Description

1.1 Client Information

Company	Samsung Electronics Co., Ltd.
Contact Point	129, Samsung-ro, Yeongtong-gu, Suwon-si, Gyeonggi-do, 16677, Korea
Contact Person	Name : Youngjoong Noh E-mail : monk.noh@samsung.com Tel : +82-277-0598 Fax : -

1.2 Product Information

FCC ID	A3LWCA942M
ISED	649E-WCA942M
Product Description	Wi-Fi/BT Transceiver
Model name	WCA942M
Variant Model name	-
Operating Frequency	UNII 1 : 5 180 MHz – 5 240 MHz (20 MHz_BW) 5 190 MHz – 5 230 MHz (40 MHz_BW) 5 210 MHz (80 MHz_BW) UNII 2A : 5 260 MHz – 5 320 MHz (20 MHz_BW) 5 270 MHz – 5 310 MHz (40 MHz_BW) 5 290 MHz (80 MHz_BW) UNII 2C : 5 500 MHz – 5 720 MHz (20 MHz_BW) 5 510 MHz – 5 710 MHz (40 MHz_BW) 5 530 MHz – 5 690 MHz (80 MHz_BW) UNII 3 : 5 745 MHz – 5 825 MHz (20 MHz_BW) 5 755 MHz – 5 795 MHz (40 MHz_BW) 5 775 MHz (80 MHz)
RF Output Power	802.11a : 18.82 dBm (76.16 mW) 802.11n_HT20 : 18.79 dBm (75.60 mW) 802.11n_HT40 : 21.27 dBm (134.04 mW) 802.11ac_VHT20 : 18.60 dBm (72.42 mW) 802.11ac_VHT40 : 21.21 dBm (132.00 mW) 802.11ac_VHT80 : 17.93 dBm (62.15 mW) 802.11ax_HE20 : 18.81 dBm (76.00 mW) 802.11ax_HE40 : 21.51 dBm (141.61 mW) 802.11ax_HE80 : 18.27 dBm (67.15 mW)
Antenna Specification	Antenna type : Chip Antenna Peak Gain : -0.07 dBi (ANT1), 1.65 dBi (ANT2)
Type of Modulation	OFDM, OFDMA
Data Rate	802.11a : 54 / 48 / 36 / 24 / 18 / 12 / 9 / 6 Mbps 802.11n : up to 300 Mbps 802.11ac : up to 867 Mbps 802.11ax : up to 1 200 Mbps
Power Source	DC 5 V
Hardware Rev	V2.0
Software Rev	FC2



CTK Co., Ltd.
(Ho-dong), 113, Yejik-ro, Cheoin-gu,
Yongin-si, Gyeonggi-do, Korea
Tel: +82-31-339-9970
Fax: +82-31-624-9501

Report No.:
CTK-2020-04549
Page (5) / (26) Pages

DFS Mode of Operation	Master Device	<input type="checkbox"/>
	Client Device (No radar detection)	<input checked="" type="checkbox"/>
	Client Device With Radar Detection	<input type="checkbox"/>

1.3 Peripheral Devices

Device	Manufacturer	Model No.	Serial No.
Note Computer	HP	15-bs563TU	CND7253QPR
AC/DC Adapter	HP	HSTNN-LA40	-
Note Computer	Lenovo	X240	-
AC/DC Adapter	Lenovo	ADLX45NCC3A	-
WLAN Access Point	ASUS	RT-AX88U	L6IKHP000005
AC/DC Adapter	ASUS	ADP-65GD B	

1.4 Model Differences

Not applicable



CTK Co., Ltd.
(Ho-dong), 113, Yejik-ro, Cheoin-gu,
Yongin-si, Gyeonggi-do, Korea
Tel: +82-31-339-9970
Fax: +82-31-624-9501

Report No.:
CTK-2020-04549
Page (6) / (26) Pages

2. Facility and Accreditations

2.1 Test Facility

The measurement facility is located at (Ho-dong), 113, Yejik-ro, Cheoin-gu, Yongin-si, Gyeonggi-do, Korea.

2.2 Laboratory Accreditations and Listings

Country	Agency	Registration Number
USA	FCC	805871
CANADA	ISED	8737A-2
KOREA	NRRA	KR0025

2.3 Calibration Details of Equipment Used for Measurement

Test equipment and test accessories are calibrated on regular basis. The maximum time between calibrations is one year or what is recommended by the manufacturer, whichever is less. All test equipment calibrations are traceable to the Korea Research Institute of Standards and Science (KRISS), therefore, all test data recorded in this report is traceable to KRISS.



CTK Co., Ltd.
(Ho-dong), 113, Yejik-ro, Cheoin-gu,
Yongin-si, Gyeonggi-do, Korea
Tel: +82-31-339-9970
Fax: +82-31-624-9501

Report No.:
CTK-2020-04549
Page (7) / (26) Pages

3. Summary of tests

Parameter	Limit	Status (note 1)
Channel Move Time	10 seconds	C
Channel Closing Transmission Time	200ms + aggregate of 60ms over remaining 10 second period	C
Client beacon test	Monitored for 10 minutes with no client transmission	C

Note 1: C=Complies NC=Not Complies NT=Not Tested NA=Not Applicable



3.1 Description of Dynamic Frequency Selection Test

Table 1: Applicability of DFS Requirements Prior to Use of a Channel

Requirement	Operational Mode		
	Master	Client Without Radar Detection	Client With Radar Detection
<i>Non-Occupancy Period</i>	Yes	Not required	Yes
<i>DFS Detection Threshold</i>	Yes	Not required	Yes
<i>Channel Availability Check Time</i>	Yes	Not required	Not required
<i>U-NII Detection Bandwidth</i>	Yes	Not required	Yes

Table 2: Applicability of DFS requirements during normal operation

Requirement	Operational Mode	
	Master Device or Client with Radar Detection	Client Without Radar Detection
<i>DFS Detection Threshold</i>	Yes	Not required
<i>Channel Closing Transmission Time</i>	Yes	Yes
<i>Channel Move Time</i>	Yes	Yes
<i>U-NII Detection Bandwidth</i>	Yes	Not required

Additional requirements for devices with multiple bandwidth modes	Master Device or Client with Radar Detection	Client Without Radar Detection
<i>U-NII Detection Bandwidth and Statistical Performance Check</i>	All BW modes must be tested	Not required
<i>Channel Move Time and Channel Closing Transmission Time</i>	Test using widest BW mode available	Test using the widest BW mode available for the link
<i>All other tests</i>	Any single BW mode	Not required

Note: Frequencies selected for statistical performance check (Section 7.8.4) should include several frequencies within the radar detection bandwidth and frequencies near the edge of the radar detection bandwidth. For 802.11 devices it is suggested to select frequencies in each of the bonded 20 MHz channels and the channel center frequency.



Table 3: DFS Detection Thresholds for Master Devices and Client Devices with Radar Detection

Maximum Transmit Power	Value (See Notes 1, 2, and 3)
EIRP \geq 200 milliwatt	-64 dBm
EIRP < 200 milliwatt and power spectral density < 10 dBm/MHz	-62 dBm
EIRP < 200 milliwatt that do not meet the power spectral density requirement	-64 dBm
<p>Note 1: This is the level at the input of the receiver assuming a 0 dBi receive antenna. Note 2: Throughout these test procedures an additional 1 dB has been added to the amplitude of the test transmission waveforms to account for variations in measurement equipment. This will ensure that the test signal is at or above the detection threshold level to trigger a DFS response. Note3: EIRP is based on the highest antenna gain. For MIMO devices refer to KDB Publication 662911 D01.</p>	

Table 4: DFS Response Requirement Values

Parameter	Value
<i>Non-occupancy period</i>	Minimum 30 minutes
<i>Channel Availability Check Time</i>	60 seconds
<i>Channel Move Time</i>	10 seconds See Note 1.
<i>Channel Closing Transmission Time</i>	200 milliseconds + an aggregate of 60 milliseconds over remaining 10 second period. See Notes 1 and 2.
<i>U-NII Detection Bandwidth</i>	Minimum 100% of the U-NII 99% transmission power bandwidth. See Note 3.
<p>Note 1: <i>Channel Move Time</i> and the <i>Channel Closing Transmission Time</i> should be performed with Radar Type 0. The measurement timing begins at the end of the Radar Type 0 burst. Note 2: The <i>Channel Closing Transmission Time</i> is comprised of 200 milliseconds starting at the beginning of the <i>Channel Move Time</i> plus any additional intermittent control signals required to facilitate a <i>Channel</i> move (an aggregate of 60 milliseconds) during the remainder of the 10 second period. The aggregate duration of control signals will not count quiet periods in between transmissions. Note 3: During the <i>U-NII Detection Bandwidth</i> detection test, radar type 0 should be used. For each frequency step the minimum percentage of detection is 90 percent. Measurements are performed with no data traffic.</p>	



CTK Co., Ltd.
 (Ho-dong), 113, Yejik-ro, Cheoin-gu,
 Yongin-si, Gyeonggi-do, Korea
 Tel: +82-31-339-9970
 Fax: +82-31-624-9501

Report No.:
 CTK-2020-04549
 Page (10) / (26) Pages

Table 5 – Short Pulse Radar Test Waveforms

Radar Type	Pulse Width (μsec)	PRI (μsec)	Number of Pulses	Minimum Percentage of Successful Detection	Minimum Number of Trials
0	1	1428	18	See Note 1	See Note 1
1	1	Test A: 15 unique PRI values randomly selected from the list of 23 PRI values in Table 5a	Roundup $\left\{ \left(\frac{1}{360} \right) \cdot \left(\frac{19 \cdot 10^6}{\text{PRI}_{\mu\text{sec}}} \right) \right\}$	60%	30
		Test B: 15 unique PRI values randomly selected within the range of 518-3066 μsec, with a minimum increment of 1 μsec, excluding PRI values selected in Test A			
2	1-5	150-230	23-29	60%	30
3	6-10	200-500	16-18	60%	30
4	11-20	200-500	12-16	60%	30
Aggregate (Radar Types 1-4)				80%	120
Note 1: Short Pulse Radar Type 0 should be used for the detection bandwidth test, channel move time, and channel closing time tests.					

Table 5a - Pulse Repetition Intervals Values for Test A

Pulse Repetition Frequency Number	Pulse Repetition Frequency (Pulses Per Second)	Pulse Repetition Interval (Microseconds)
1	1930.5	518
2	1858.7	538
3	1792.1	558
4	1730.1	578
5	1672.2	598
6	1618.1	618
7	1567.4	638
8	1519.8	658
9	1474.9	678
10	1432.7	698
11	1392.8	718
12	1355	738
13	1319.3	758
14	1285.3	778
15	1253.1	798
16	1222.5	818
17	1193.3	838
18	1165.6	858
19	1139	878
20	1113.6	898
21	1089.3	918
22	1066.1	938
23	326.2	3066

Table 6 – Long Pulse Radar Test Waveform

Radar Type	Pulse Width (μsec)	Chirp Width (MHz)	PRI (μsec)	Number of Pulses per <i>Burst</i>	Number of <i>Bursts</i>	Minimum Percentage of Successful Detection	Minimum Number of Trials
5	50-100	5-20	1000-2000	1-3	8-20	80%	30

Table 7 – Frequency Hopping Radar Test Waveform

Radar Type	Pulse Width (μsec)	PRI (μsec)	Pulses per Hop	Hopping Rate (kHz)	Hopping Sequence Length (msec)	Minimum Percentage of Successful Detection	Minimum Number of Trials
6	1	333	9	0.333	300	70%	30

3.2 Measuring Systematic diagram

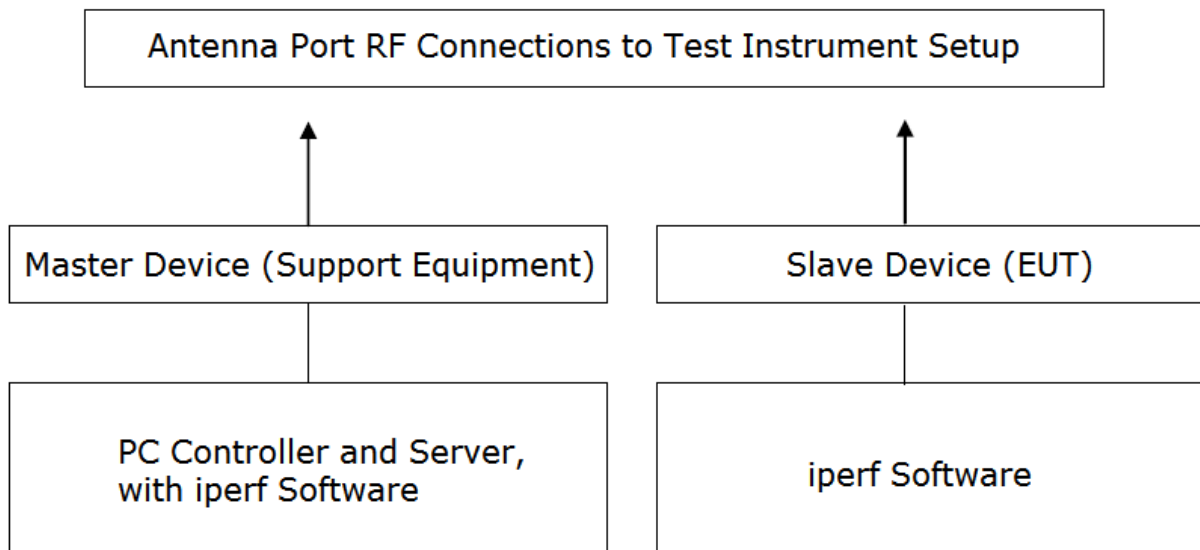
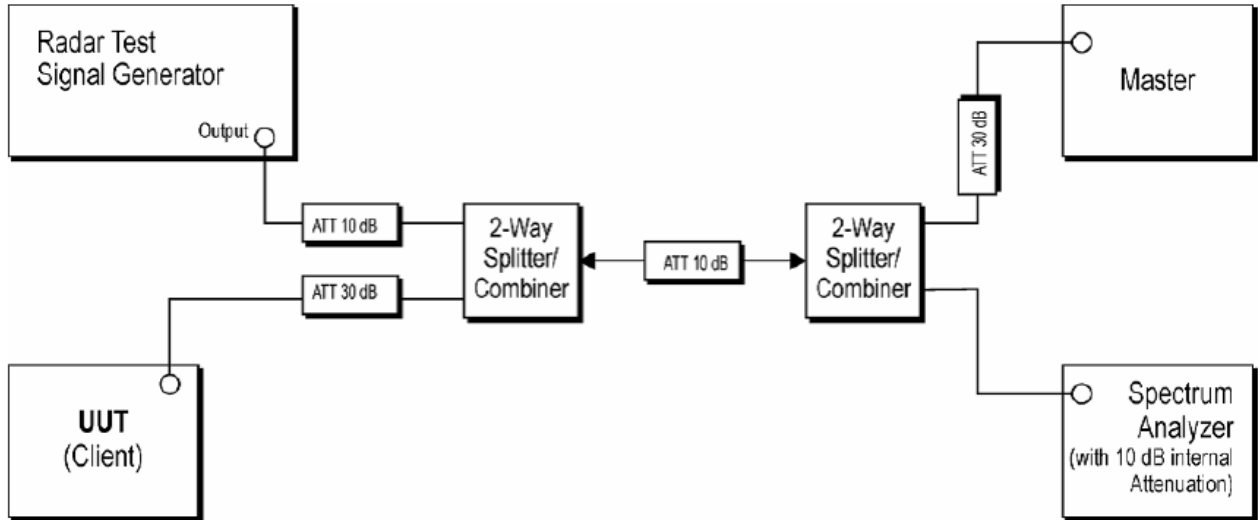

 <p>CTK Co., Ltd. The Prime Leader of Global Regulatory Certification</p>	<p>CTK Co., Ltd. (Ho-dong), 113, Yejik-ro, Cheoin-gu, Yongin-si, Gyeonggi-do, Korea Tel: +82-31-339-9970 Fax: +82-31-624-9501</p>	<p>Report No.: CTK-2020-04549 Page (13) / (26) Pages</p>	
-----------------------------------------------------------------------------------------------------------------------------------------------------------------------	----------------------------------------------------------------------------------------------------------------------------------------------------------	------------------------------------------------------------------	--

3.3 Description of EUT

Overview Of EUT With Respect To §15.407 (H) Requirements

The EUT operates over the 5250-5350 MHz and 5470-5725 MHz range.
The EUT is a Client Device that does not have radar detection capability.
The Slave device associated with the EUT during these tests does not have radar detection capability.

All tests are conducted with Pulse Type 0.

A sample with temporary antenna connector was provided to perform the measurements in a conducted way.

Iperf was used to generate the required channel load (duty cycle greater 17 percent).

The EUT utilizes the 802.11a/n/ac architecture, with a nominal channel bandwidth of 20/40/80 MHz.

The Master Device is a ASUS RT-AX88U 802.11a/b/g/n/ac/ax WLAN Access Point,
FCC ID: MSQ-RTAXHP00

Threshold level is lower than the required level hence it provides margin to the limit.

3.4 Test Results

3.4.1 Test Channel

All test were performed at a channel center frequency of 5500 MHz for 20 MHz Bandwidth.
 All test were performed at a channel center frequency of 5510 MHz for 40 MHz Bandwidth.
 All test were performed at a channel center frequency of 5530 MHz for 80 MHz Bandwidth.

3.4.2 Radar waveform, Traffic and Dwell time per bin

Radar Waveform (20 MHz)

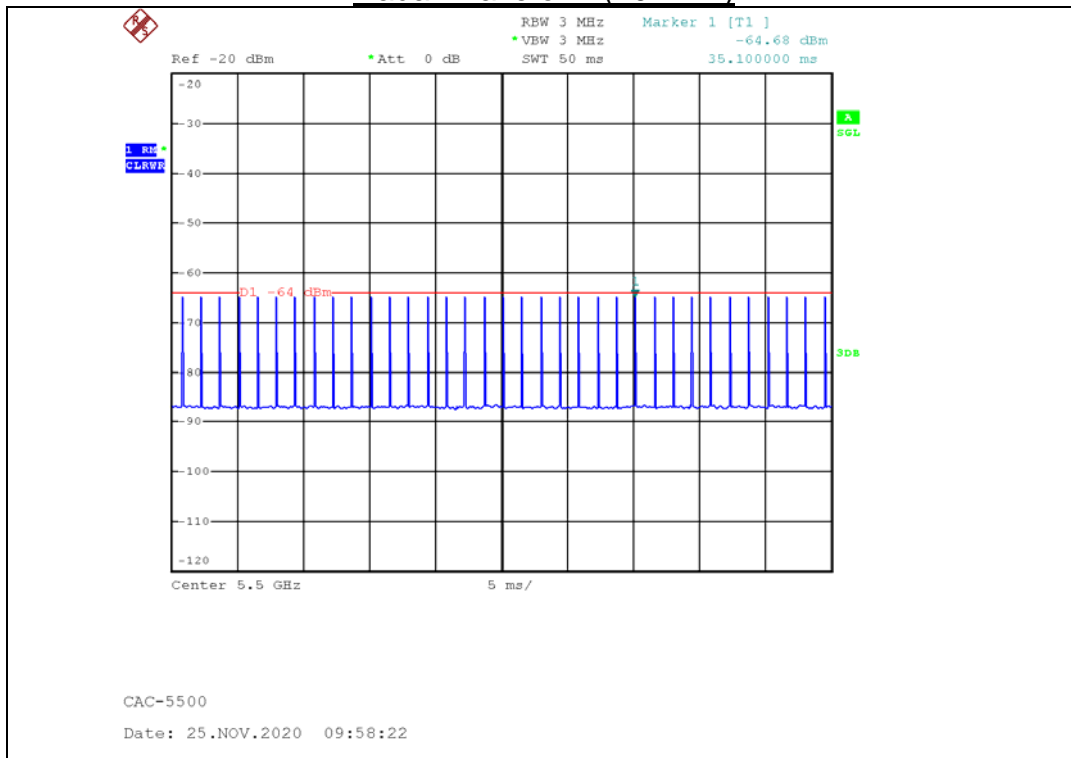

Radar Waveform (40 MHz)

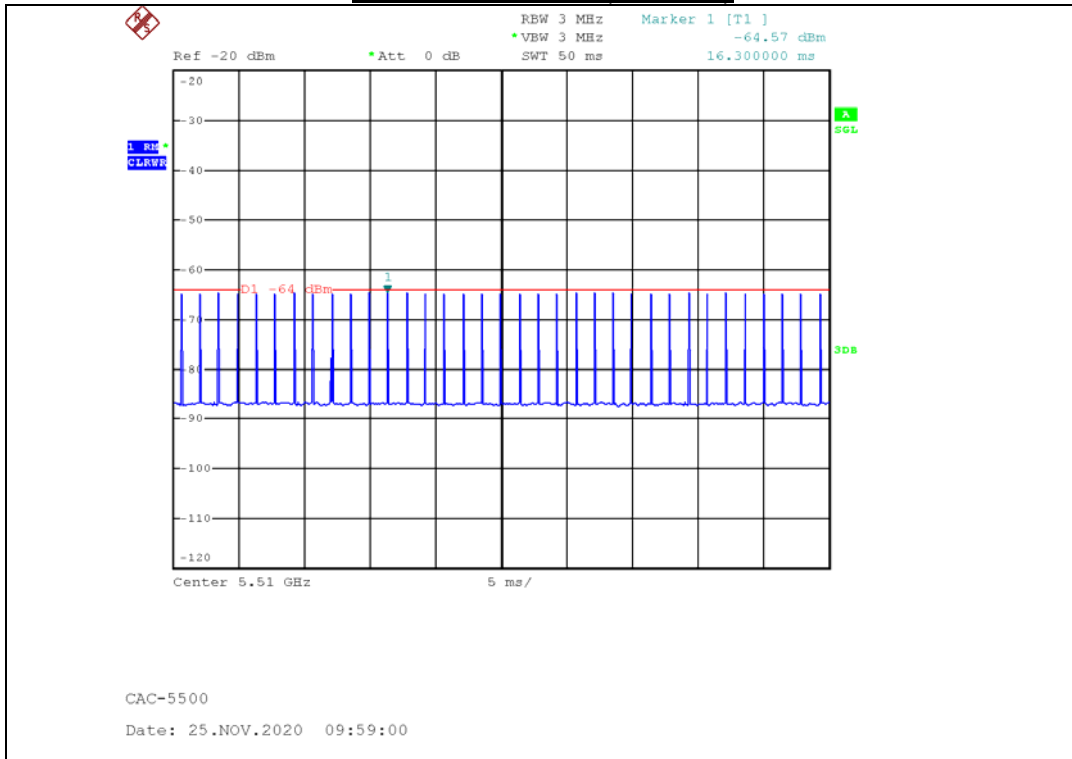

Radar Waveform (80 MHz)

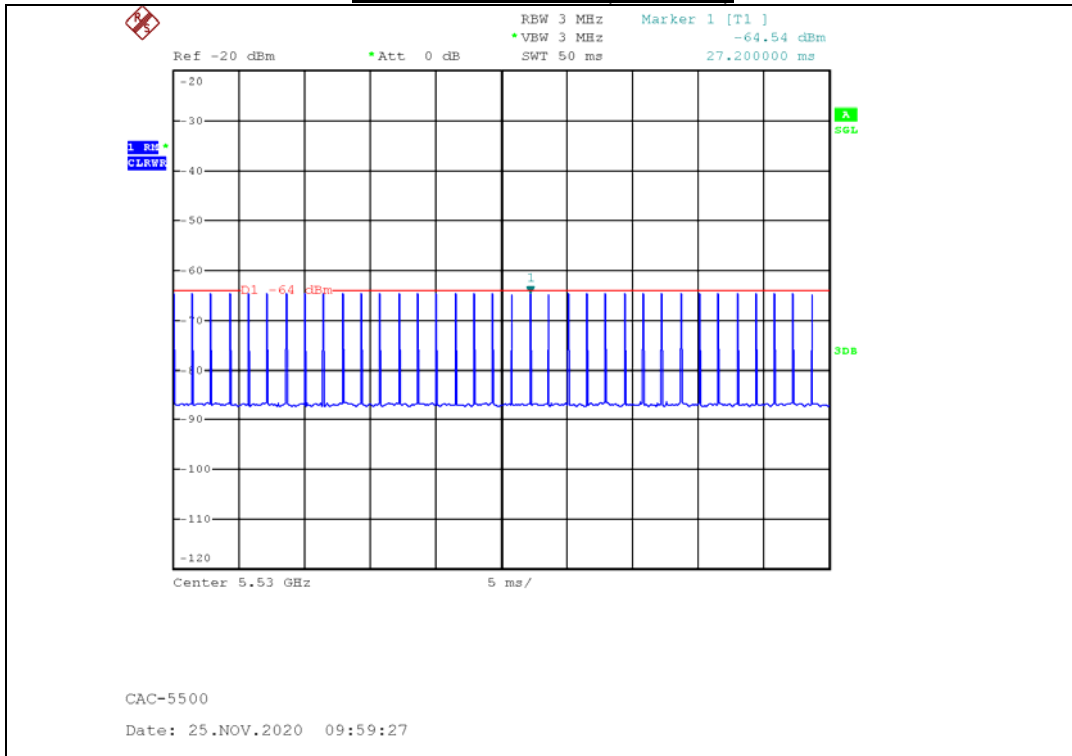



CTK Co., Ltd.
(Ho-dong), 113, Yejik-ro, Cheoin-gu,
Yongin-si, Gyeonggi-do, Korea
Tel: +82-31-339-9970
Fax: +82-31-624-9501

Report No.:
CTK-2020-04549
Page (16) / (26) Pages

Traffic (20 MHz)

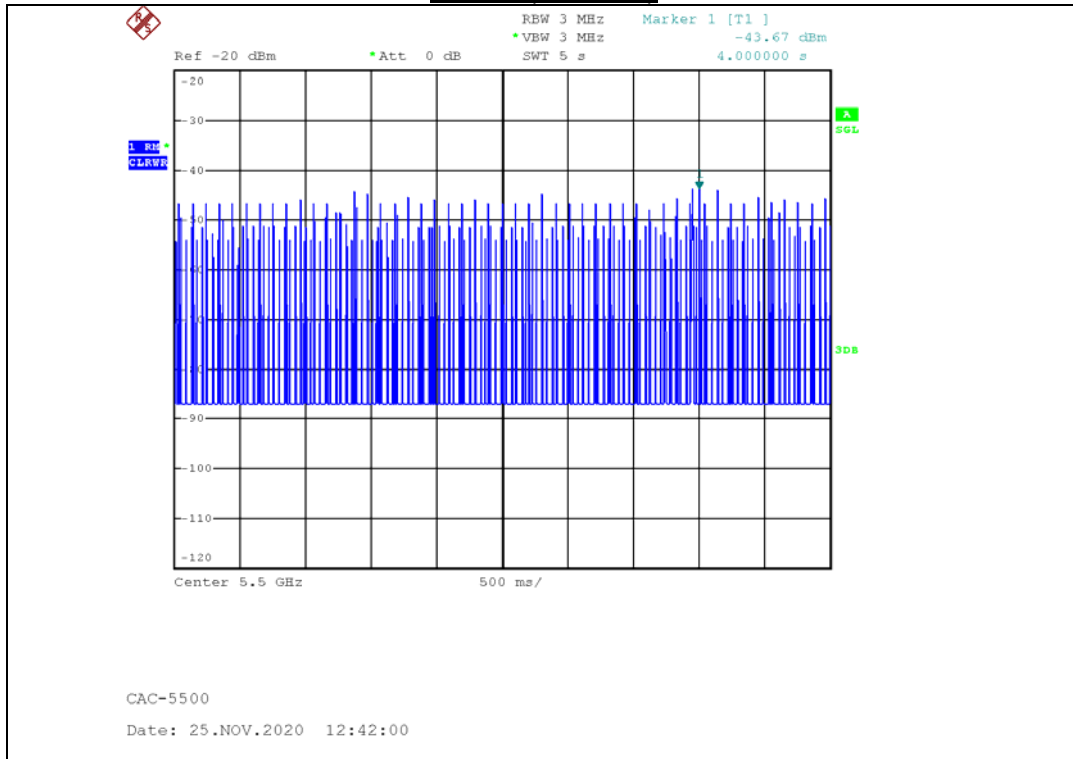

Traffic (40 MHz)

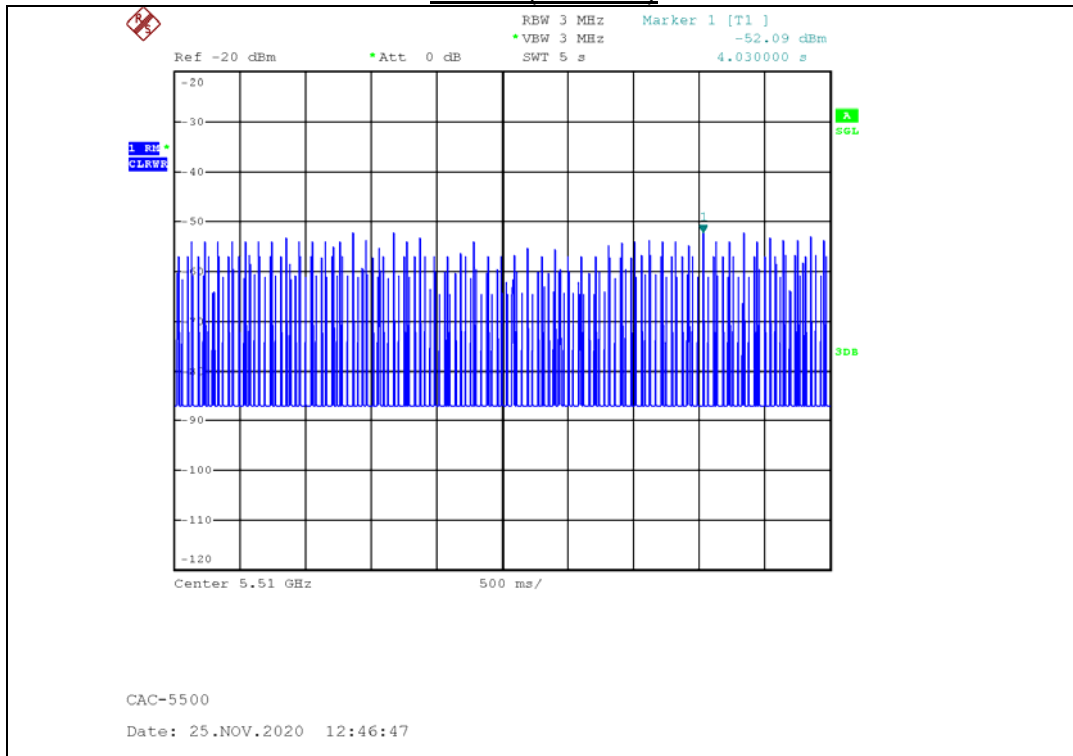



CTK Co., Ltd.
(Ho-dong), 113, Yejik-ro, Cheoin-gu,
Yongin-si, Gyeonggi-do, Korea
Tel: +82-31-339-9970
Fax: +82-31-624-9501

Report No.:
CTK-2020-04549
Page (17) / (26) Pages

Traffic (80 MHz)

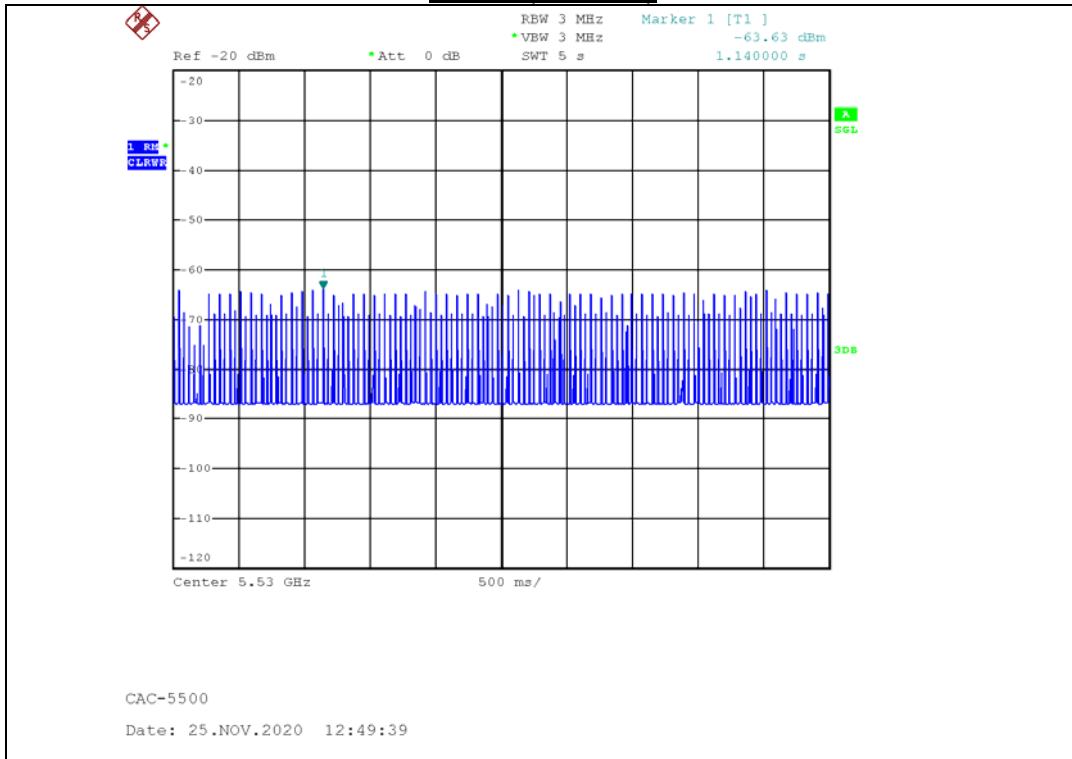

Dwell time per bin (20 MHz)

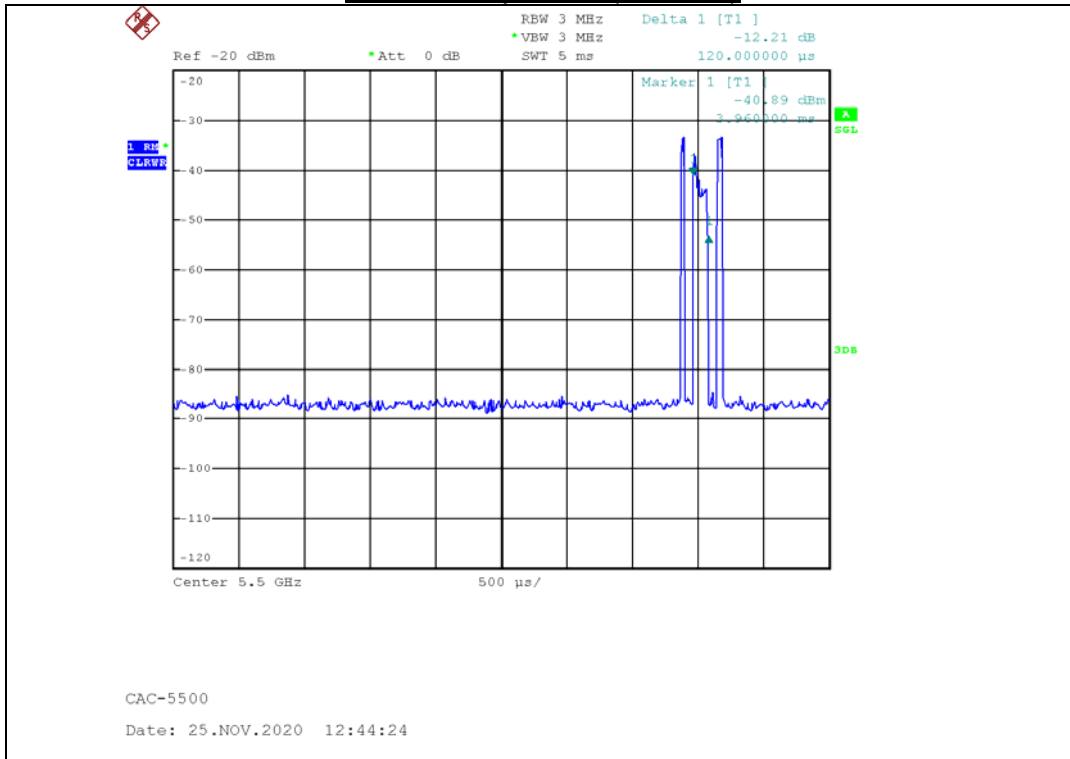

Dwell time per bin (40 MHz)

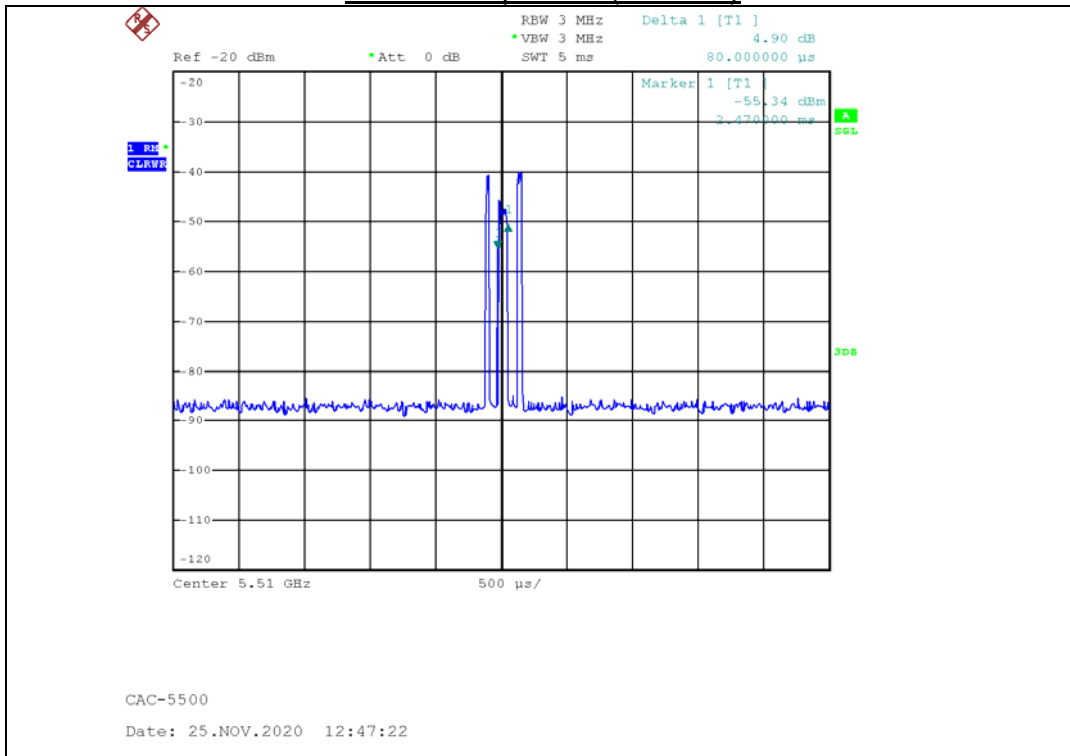



CTK Co., Ltd.
(Ho-dong), 113, Yejik-ro, Cheoin-gu,
Yongin-si, Gyeonggi-do, Korea
Tel: +82-31-339-9970
Fax: +82-31-624-9501

Report No.:
CTK-2020-04549
Page (19) / (26) Pages

Dwell time per bin (80 MHz)

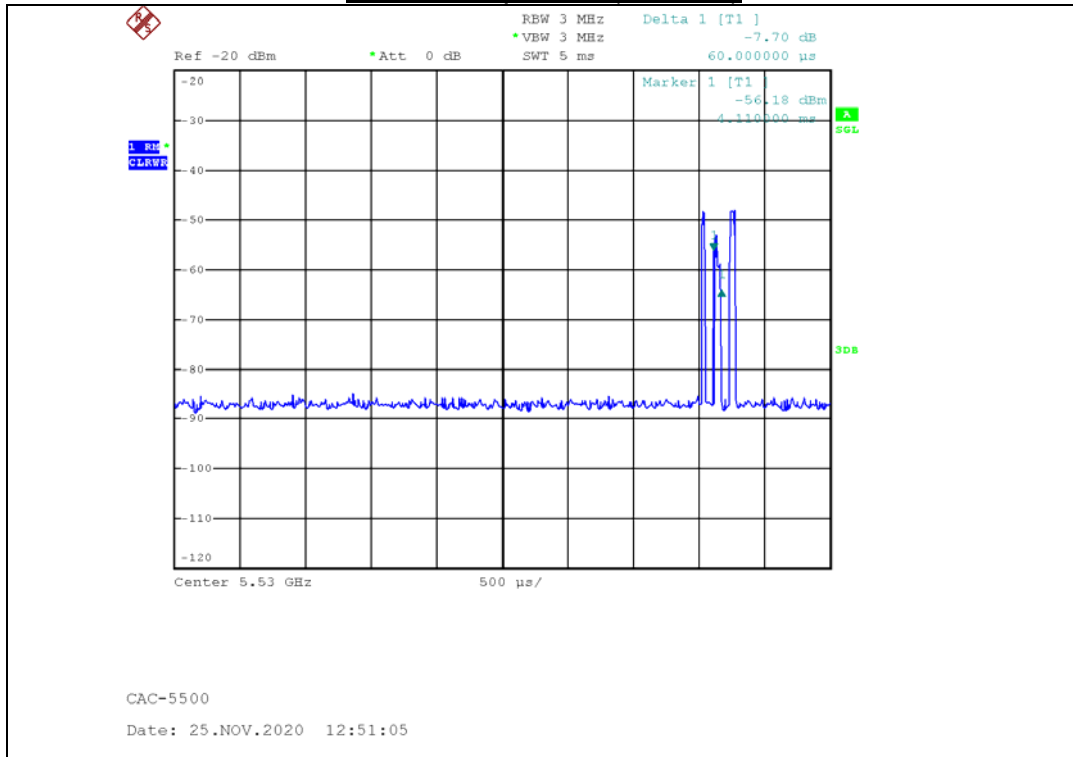

 <p>CTK Co., Ltd. The Prime Leader of Global Regulatory Certification</p>	<p>CTK Co., Ltd. (Ho-dong), 113, Yejik-ro, Cheoin-gu, Yongin-si, Gyeonggi-do, Korea Tel: +82-31-339-9970 Fax: +82-31-624-9501</p>	<p>Report No.: CTK-2020-04549 Page (20) / (26) Pages</p>	
-----------------------------------------------------------------------------------------------------------------------------------------------------------------------	----------------------------------------------------------------------------------------------------------------------------------------------------------	------------------------------------------------------------------	--

3.4.3 Channel move time and Channel closing Transmission time

REPORTING NOTES

The reference marker is set at the end of last radar pulse.
The delta marker is set at the end of the last WLAN transmission following the radar pulse.
This delta is the channel move time.

The aggregate channel closing transmission time is calculated as follows:

Aggregate Transmission Time =
(Number of analyzer bins showing transmission) * (dwell time per bin)

The observation period over which the aggregate time is calculated Begins at
(Reference Marker + 200 msec) and Ends no earlier than (Reference Marker + 10 sec).

Test Results

<Bandwidth 20 MHz Mode>

Channel Move Time (sec)	Limit (sec)
0.88	10
Channel Closing Transmission Time (msec)	Limit (msec)
3.12	260

Channel Move Time and Channel closing Transmission time(20 MHz BW)

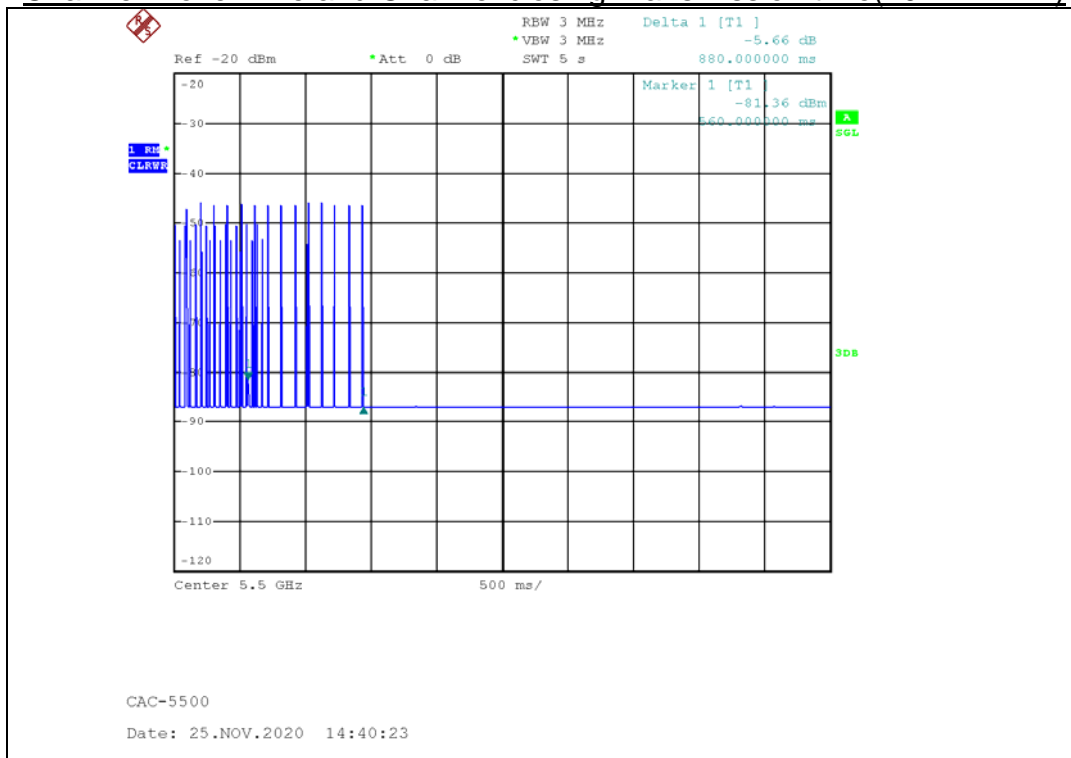

Channel Closing Transmission Time calculated	Test results
Sampling bins	13
Dwell time per bin (msec)	0.24
Closing Transmission Time (msec)	3.12



CTK Co., Ltd.
 (Ho-dong), 113, Yejik-ro, Cheoin-gu,
 Yongin-si, Gyeonggi-do, Korea
 Tel: +82-31-339-9970
 Fax: +82-31-624-9501

Report No.:
 CTK-2020-04549
 Page (22) / (26) Pages

<Bandwidth 40 MHz Mode>

Channel Move Time (sec)	Limit (sec)
0.60	10
Channel Closing Transmission Time (msec)	Limit (msec)
1.92	260

Channel Move Time and Channel closing Transmission time(40 MHz BW)

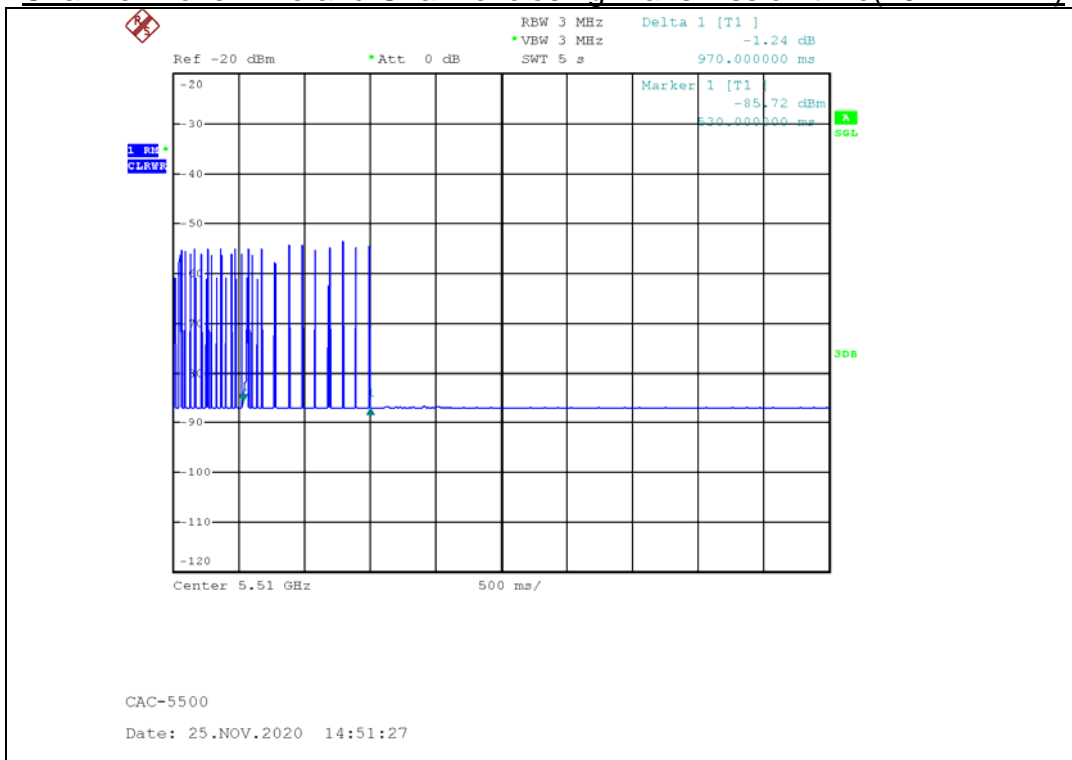

Channel Closing Transmission Time calculated	Test results
Sampling bins	12
Dwell time per bin (msec)	0.16
Closing Transmission Time (msec)	1.92



CTK Co., Ltd.
 (Ho-dong), 113, Yejik-ro, Cheoin-gu,
 Yongin-si, Gyeonggi-do, Korea
 Tel: +82-31-339-9970
 Fax: +82-31-624-9501

Report No.:
 CTK-2020-04549
 Page (23) / (26) Pages

<Bandwidth 80 MHz Mode>

Channel Move Time (sec)	Limit (sec)
0.88	10
Channel Closing Transmission Time (msec)	Limit (msec)
1.08	260

Channel Move Time and Channel closing Transmission time(80 MHz BW)

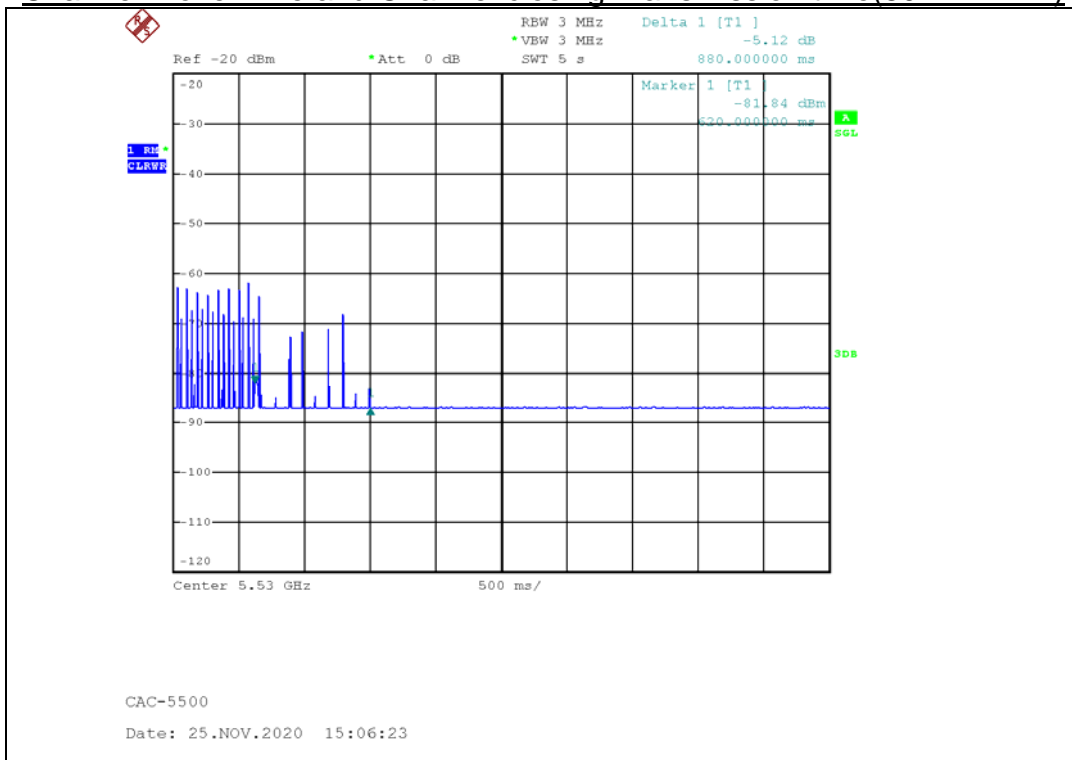

Channel Closing Transmission Time calculated	Test results
Sampling bins	9
Dwell time per bin (msec)	0.12
Closing Transmission Time (msec)	1.08



CTK Co., Ltd.
(Ho-dong), 113, Yejik-ro, Cheoin-gu,
Yongin-si, Gyeonggi-do, Korea
Tel: +82-31-339-9970
Fax: +82-31-624-9501

Report No.:
CTK-2020-04549
Page (24) / (26) Pages

3.4.4 Client beacon test

Monitoring live spectrum – Elapse time 10 minutes (20 MHz BW)

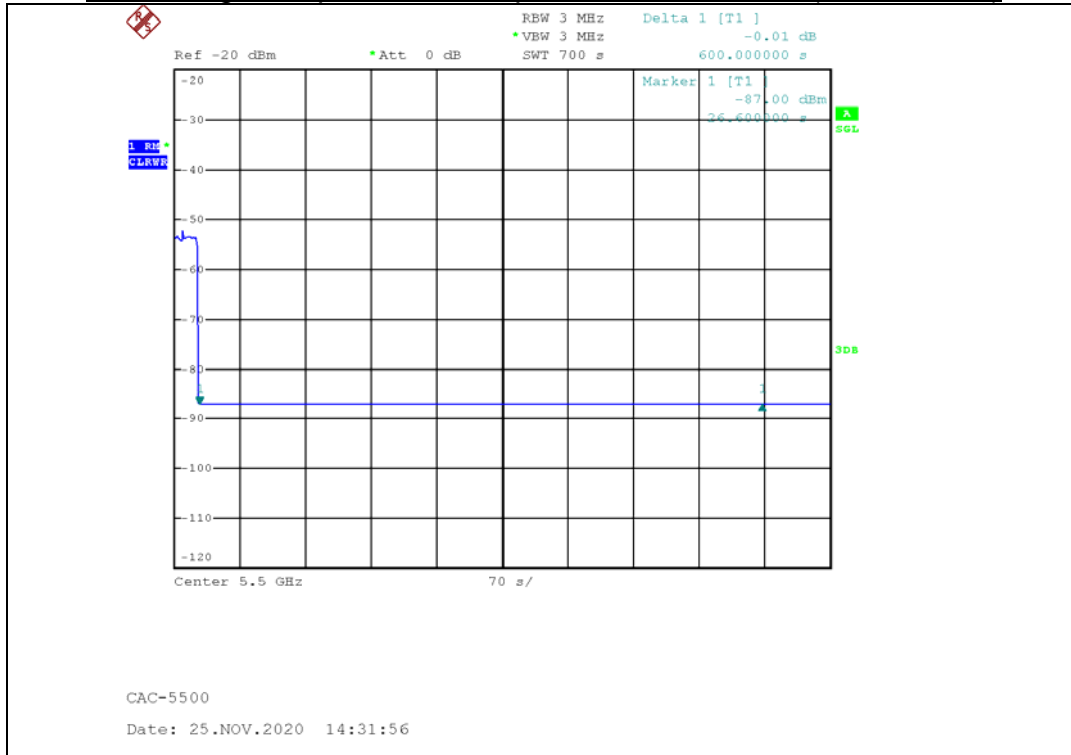

Monitoring live spectrum – Elapse time 10 minutes (40 MHz BW)

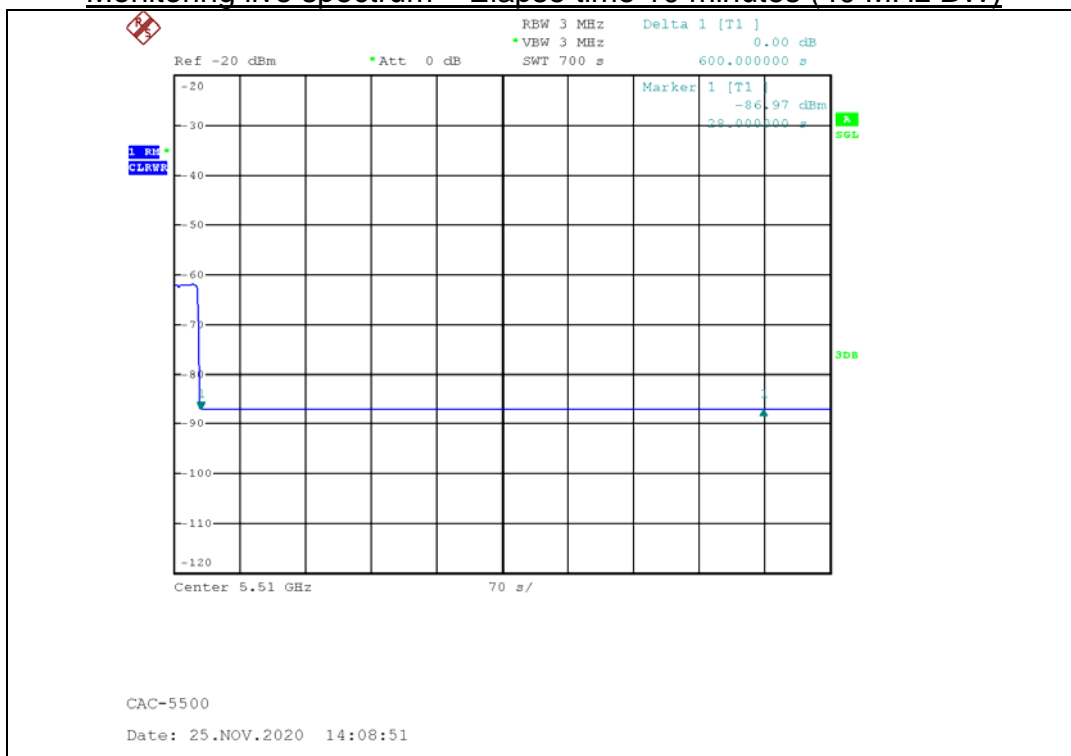



CTK Co., Ltd.
(Ho-dong), 113, Yejik-ro, Cheoin-gu,
Yongin-si, Gyeonggi-do, Korea
Tel: +82-31-339-9970
Fax: +82-31-624-9501

Report No.:
CTK-2020-04549
Page (25) / (26) Pages

Monitoring live spectrum – Elapse time 10 minutes (80 MHz BW)





CTK Co., Ltd.
(Ho-dong), 113, Yejik-ro, Cheoin-gu,
Yongin-si, Gyeonggi-do, Korea
Tel: +82-31-339-9970
Fax: +82-31-624-9501

Report No.:
CTK-2020-04549
Page (26) / (26) Pages

APPENDIX A – Test Equipment Used For Tests

	Name of Equipment	Manufacturer	Model No.	Serial No.	Date of Calibration	Due Date
1	Spectrum Analyzer	Rohde & Schwarz	FSP	100401	2020-01-17	2021-01-17
2	Signal Generator	Rohde & Schwarz	SMB100A	175528	2020-04-28	2021-04-28
3	Vector Signal Generator	Rohde & Schwarz	SMBV100A	258008	2020-01-17	2021-01-17
4	DUAL DIRECTIONAL COUPLER	HP	11692D	1212A03629	2020-10-14	2021-10-14

	Cable	Manufacturer	Model No.	Serial No.	Check Date
1	RF Cable	Junkosha Inc.	MWX221	1510S087	2020-11-24
2	RF Cable	Junkosha Inc.	MWX221	1510S085	2020-11-24
3	RF Cable	Junkosha Inc.	MWX221	J0970758	2020-11-24
4	RF Cable	Junkosha Inc.	MWX221	J0970753	2020-11-24