

FCC DFS Test Report

Equipment : Mobile Phone
Brand Name : Samsung
Model No. : SC-03E
FCC ID : A3LSWDSC03E
Standard : 47 CFR FCC Part 15.407
Applicant : SAMSUNG Electronics Co., LTD.
Manufacturer : IT center, 416, Maetan-3dong, Yeongtong-gu,
Suwon-city, Gyeonggi-do, Korea
Operate Mode : Client without radar detection

The product sample received on Oct. 24, 2012 and completely tested on Oct. 24, 2012. We, SPORTON, would like to declare that the tested sample has been evaluated in accordance with the procedures given in FCC 06-96 Appendix and shown compliance with the applicable technical standards.

The test results in this report apply exclusively to the tested model / sample. Without written approval of SPORTON INTERNATIONAL INC., the test report shall not be reproduced except in full.

Reviewed by:



Wayne Hsu Assistant Manager



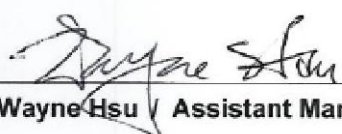

Table of Contents

1	GENERAL DESCRIPTION.....	5
1.1	Information.....	5
1.2	Support Equipment.....	7
1.3	Testing Applied Standards.....	7
1.4	Testing Location Information.....	7
1.5	Measurement Uncertainty.....	7
2	TEST CONFIGURATION OF EUT.....	8
2.1	DFS and TPC Information.....	8
2.2	The Worst Case Measurement Configuration.....	8
3	DYNAMIC FREQUENCY SELECTION (DFS) TEST RESULT.....	9
3.1	General DFS Information.....	9
3.2	Radar Test Waveform Calibration.....	11
3.3	In-service Monitoring.....	16
4	TEST EQUIPMENT AND CALIBRATION DATA.....	19
5	CERTIFICATION OF TAF ACCREDITATION.....	20
	APPENDIX A. TEST PHOTOS.....	A1



Summary of Test Result

Conformance Test Specifications (FCC 06-96 Appendix)					
Report Clause	Ref. Std. Clause	Description	Measured	Limit	Result
-	7.8.1	DFS: UNII Detection Bandwidth Measurement	N/A (Client w/o test)	80% of the 99% BW	N/A
-	7.8.2.1	DFS: Initial Channel Availability Check Time	N/A (Client w/o test)	CAC ≥ 60 sec	N/A
-	7.8.2.2	DFS: Radar Burst at the Beginning of the Channel Availability Check Time	N/A (Client w/o test)	Detection Threshold: -64 dBm	N/A
-	7.8.2.3	DFS: Radar Burst at the End of the Channel Availability Check Time	N/A (Client w/o test)	Detection Threshold: -64 dBm	N/A
3.3	7.8.3	DFS: In-Service Monitoring for Channel Move Time (CMT)	CMT < 10sec	CMT ≤ 10sec	Complied
3.3	7.8.3	DFS: In-Service Monitoring for Channel Closing Transmission Time (CCTT)	CCTT < 60 ms	CCTT ≤ 60 ms starting at CMT 200ms	Complied
3.3	7.8.3	DFS: In-Service Monitoring for Non-Occupancy Period (NOP)	NOP > 30 min	NOP ≥ 30 min	Complied
-	7.8.4	DFS: Statistical Performance Check	N/A (Client w/o test)	Table 5 - 7 (KDB 905462)	N/A
-	5.8.1	DFS: Uniform Spreading	N/A (Client w/o this function)	Uniform Spreading for DFS Band	N/A
3.1.4	8.1	User Access Restrictions	Manufacturer attestation NOT accessible to user	DFS controls	Complied



1 General Description

1.1 Information

1.1.1 RF General Information

RF General Information			
Frequency Range (MHz)	IEEE Std. 802.11 Protocol	Ch. Frequency (MHz)	Channel Number
5150-5250	a	5180-5240	36-48 [4]
5250-5350		5260-5320	52-64 [4]
5470-5725		5500-5700	100-140 [8]
5150-5250	n (HT20)	5180-5240	36-48 [4]
5250-5350		5260-5320	52-64 [4]
5470-5725		5500-5700	100-140 [8]
5150-5250	n (HT40)	5190-5230	38-46 [2]
5250-5350		5270-5310	54-62 [2]
5470-5725		5510-5670	102-134 [3]

Note 1: IEEE Std. 802.11n-2009 modulation consists of HT20 and HT40 (HT: High Throughput). Then EUT support HT20 and HT40.

Note 2: 20dB bandwidth not falls completely or partly within the 5600 MHz to 5650 MHz band. Following channel frequencies could not be used for 5600 MHz to 5650 MHz band:
20MHz mode [MHz]: 5600, 5620, 5640
40MHz mode [MHz]: 5590, 5630



1.1.2 Antenna Information

Antenna Category	
<input type="checkbox"/>	Equipment placed on the market without antennas
<input checked="" type="checkbox"/>	Integral antenna (antenna permanently attached)
<input type="checkbox"/>	Temporary RF connector provided
<input checked="" type="checkbox"/>	No temporary RF connector provided Transmit chains bypass antenna and soldered temporary RF connector provided for connected measurement. In case of conducted measurements the transmitter shall be connected to the measuring equipment via a suitable attenuator and correct for all losses in the RF path.
<input type="checkbox"/>	External antenna (dedicated antennas)
<input type="checkbox"/>	Single power level with corresponding antenna(s). Power Level (PL): 1
<input type="checkbox"/>	Multiple power level and corresponding antenna(s). Power Level (PL): 1~...

Antenna General Information									
Antenna Port (Total 1 Port)					1(TX/RX)				
Ant. No.	PL	Ant. Port [Ant No. X connect to Ant. Port Y]	Ant. Cat.	Ant. Type	Brand	Model	G _{ANT} (dBi)	DG (dBi) [correlated] N _{TX} = 1	DG (dBi) [uncorrelated] N _{TX} = 1
1	1	1	Integra	PIFA	EMW	HIL-01C15-0000AA	-6.58	N/A	N/A
<input checked="" type="checkbox"/> For radiated tests, the DFS test should be performed with lowest antenna gain (regardless of antenna type). Then Ant. No. <u>1</u> shall be performed the radiated DFS test.									

1.2 Support Equipment

Support Equipment				
No.	Equipment	Brand Name	Model Name	FCC ID
1	AP (Master)	3Com	WL-605	O9C-WL605
2	Notebook PC	Dell	Latitude E5510	DoC

1.3 Testing Applied Standards

According to the specifications of the manufacturer, the EUT must comply with the requirements of the following standards:

- ◆ FCC 06-96 Appendix
- ◆ FCC KDB 905462 5 GHz UNII DFS Compliance Procedures
- ◆ FCC KDB 443999 Approval of DFS UNII Devices

1.4 Testing Location Information

Testing Location				
<input checked="" type="checkbox"/>	HWA YA	ADD : No. 52, Hwa Ya 1st Rd., Hwa Ya Technology Park, Kwei-Shan Hsiang, Tao Yuan Hsien, Taiwan, R.O.C		
		TEL : 886-3-327-3456 FAX : 886-3-327-0973		
Test Condition	Test Site No.	Test Engineer	Test Environment	Test Date
DFS Site	DF01-HY	Bear Chen	24.8°C / 62%	24-Oct.-12

1.5 Measurement Uncertainty

ISO/IEC 17025 requires that an estimate of the measurement uncertainties associated with the emissions test results be included in the report. The measurement uncertainties given below are based on a 95% confidence level (based on a coverage factor (k=2))

Measurement Uncertainty		
Test Item	Uncertainty	Limit
Radio frequency	$\pm 8.7 \times 10^{-7}$	N/A
RF output power, conducted	± 0.63 dB	N/A
All emissions, conducted	± 0.83 dB	N/A
All emissions, radiated	± 2.87 dB	N/A
Temperature	± 0.8 °C	N/A
Humidity	± 3 %	N/A
DC and low frequency voltages	± 3 %	N/A
Time	± 1.42 %	N/A

2 Test Configuration of EUT

2.1 DFS and TPC Information

The DFS Related Operating Mode(s) of the Equipment					
<input type="checkbox"/> Master					
<input type="checkbox"/> Client with radar detection					
<input checked="" type="checkbox"/> Client without radar detection					
Software / Firmware Version		JRO03C,SC03EOMALJ2			
HW Version		REV0.1			
SW Version		SC03E.001			
Communication Mode		<input checked="" type="checkbox"/> IP Based (Load Based)		<input type="checkbox"/> Frame Based	
IEEE Std. 802.11 Protocol	Frequency Range (MHz)	TPC (Transmit Power Control)	Ad-hoc	Hotspot	Passive Scan
a n (HT20) n (HT40)	<input checked="" type="checkbox"/> 5150-5250	No	Yes	Yes	Yes
	<input checked="" type="checkbox"/> 5250-5350	No	No	No	Yes
	<input checked="" type="checkbox"/> 5470-5600	No	No	No	Yes
	<input type="checkbox"/> 5600-5650	N/A	N/A	N/A	N/A
	<input checked="" type="checkbox"/> 5650-5725	No	No	No	Yes

2.2 The Worst Case Measurement Configuration

The Worst Case Mode for Following Conformance Tests	
Tests Item	Dynamic Frequency Selection (DFS)
Test Condition	Radiated measurement (Vertical Polarization)
Worst Modulation Mode	
11N5.6G-20M	
11N5.6G-40M	

3 Dynamic Frequency Selection (DFS) Test Result

3.1 General DFS Information

3.1.1 DFS Parameters

Table D.1: DFS requirement values	
Parameter	Value
Non-occupancy period	Minimum 30 minutes
Channel Availability Check Time	60 seconds
Channel Move Time	10 seconds See Note 1.
Channel Closing Transmission Time	200 milliseconds + an aggregate of 60 milliseconds over remaining 10 second periods. See Notes 1 and 2.
U-NII Detection Bandwidth	Minimum 80% of the 99% power bandwidth See Note 3.

Note 1: The instant that the *Channel Move Time* and the *Channel Closing Transmission Time* begins is as follows:

- For the Short pulse radar Test Signals this instant is the end of the *Burst*.
- For the Frequency Hopping radar Test Signal, this instant is the end of the last radar *Burst* generated.
- For the Long Pulse radar Test Signal this instant is the end of the 12 second period defining the radar transmission.

Note 2: The *Channel Closing Transmission Time* is comprised of 200 milliseconds starting at the beginning of the *Channel Move Time* plus any additional intermittent control signals required to facilitate *Channel* changes (an aggregate of 60 milliseconds) during the remainder of the 10 second period. The aggregate duration of control signals will not count quiet periods in between transmissions.

Note 3: During the *U-NII Detection Bandwidth* detection test, radar type 1 is used and for each frequency step the minimum percentage of detection is 90%. Measurements are performed with no data traffic.

Table D.2: Interference threshold values	
Maximum Transmit Power	Value (see note)
≥ 200 milliwatt	-64 dBm
< 200 milliwatt	-62 dBm

Note 1: This is the level at the input of the receiver assuming a 0 dBi receive antenna.

Note 2: Throughout these test procedures an additional 1 dB has been added to the amplitude of the test transmission waveforms to account for variations in measurement equipment. This will ensure that the test signal is at or above the detection threshold level to trigger a DFS response.



3.1.2 Applicability of DFS Requirements Prior to Use of a Channel

Requirement	DFS Operational mode		
	Master	Client without radar detection	Client with radar detection
<i>Non-Occupancy Period</i>	Yes	Not required	Yes
<i>DFS Detection Threshold</i>	Yes	Not required	Yes
<i>Channel Availability Check Time</i>	Yes	Not required	Not required
<i>Uniform Spreading</i>	Yes	Not required	Not required
<i>U-NII Detection Bandwidth</i>	Yes	Not required	Yes

3.1.3 Applicability of DFS Requirements during Normal Operation

Requirement	DFS Operational mode		
	Master	Client without radar detection	Client with radar detection
<i>DFS Detection Threshold</i>	Yes	Not required	Yes
<i>Channel Closing Transmission Time</i>	Yes	Yes	Yes
<i>Channel Move Time</i>	Yes	Yes	Yes
<i>U-NII Detection Bandwidth</i>	Yes	Not required	Yes

3.1.4 User Access Restrictions

User Access Restrictions
<input checked="" type="checkbox"/> DFS controls (hardware or software) related to radar detection are NOT accessible to the user. Manufacturer statement confirming that information regarding the parameters of the detected Radar Waveforms is not available to the end user.

3.1.5 Channel Loading/Data Streaming

<input checked="" type="checkbox"/> IP Based (Load Based) - stream the test file from the Master to the Client.
<input type="checkbox"/> Performed NTIA approved WAV file. (EUT w/o video function application)
<input checked="" type="checkbox"/> Performed NTIA approved MPEG2 file. (EUT with video function application)
<input type="checkbox"/> Alternative streaming e.g., FTP with about 17 to 20% loading and submit proposal to FCC.
<input type="checkbox"/> Frame Based - stream the test file from the Master to the Client.
<input type="checkbox"/> fixed talk/listen ratio, set the ratio to 45%/55%



3.2 Radar Test Waveform Calibration

3.2.1 Short Pulse Radar Test Waveforms

Radar Type	Pulse Width (µsec)	PRI (µsec)	Number of Pulses	Minimum Percentage of Successful Detection	Minimum Trials
1	1	1428	18	60%	30
2	1-5	150-230	23-29	60%	30
3	6-10	200-500	16-18	60%	30
4	11-20	200-500	12-16	60%	30
Aggregate (Radar Types 1-4)				80%	120

A minimum of 30 unique waveforms are required for each of the short pulse radar types 2 through 4. For short pulse radar type 1, the same waveform is used a minimum of 30 times. If more than 30 waveforms are used for short pulse radar types 2 through 4, then each additional waveform must also be unique and not repeated from the previous waveforms. The aggregate is the average of the percentage of successful detections of short pulse radar types 1-4.

3.2.2 Long Pulse Radar Test Waveform

Radar Type	Pulse Width (µsec)	Chirp Width (MHz)	PRI (µsec)	Number of Pulses per Burst	Number of Bursts	Minimum Percentage of Successful Detection	Minimum Trials
5	50-100	5-20	1000-2000	1-3	8-20	80%	30

Each waveform is defined as follows:

- The transmission period for the Long Pulse Radar test signal is 12 seconds.
- There are a total of 8 to 20 Bursts in the 12 second period, with the number of Bursts being randomly chosen. This number is *Burst_Count*.
- Each Burst consists of 1 to 3 pulses, with the number of pulses being randomly chosen. Each Burst within the 12 second sequence may have a different number of pulses.
- The pulse width is between 50 and 100 microseconds, with the pulse width being randomly chosen. Each pulse within a Burst will have the same pulse width. Pulses in different Bursts may have different pulse widths.
- Each pulse has a linear FM chirp between 5 and 20 MHz, with the chirp width being randomly chosen. Each pulse within a Burst will have the same chirp width. Pulses in different Bursts may have different chirp widths. The chirp is centered on the pulse. For example, with a radar frequency of 5300 MHz and a 20 MHz chirped signal, the chirp starts at 5290 MHz and ends at 5310 MHz.
- If more than one pulse is present in a Burst, the time between the pulses will be between 1000 and 2000 microseconds, with the time being randomly chosen. If three pulses are present in a Burst, the time between the first and second pulses is chosen independently of the time between the second and third pulses.
- The 12 second transmission period is divided into even intervals. The number of intervals is equal to *Burst_Count*. Each interval is of length $(12,000,000 / \text{Burst_Count})$ microseconds. Each interval contains one Burst. The start time for the Burst, relative to the beginning of the interval, is between 1 and $[(12,000,000 / \text{Burst_Count}) - (\text{Total Burst Length}) + (\text{One Random PRI Interval})]$ microseconds, with the start time being randomly chosen. The step interval for the start time is 1 microsecond. The start time for each Burst is chosen independently.



3.2.3 Frequency Hopping Radar Test Waveform

Radar Type	Pulse Width (µsec)	PRI (µsec)	Pulses per Hop	Hopping Rate (kHz)	Hopping Sequence Length (ms)	Minimum Percentage of Successful Detection	Minimum Trials
6	1	333	9	0.333	300	70%	30

The FCC Type 6 waveform uses a static waveform with 100 bursts in the instruments ARB. In addition, the RF list mode is operated with a list containing 100 frequencies from a randomly generated list and it had be ensured that at least one of the random frequencies falls into the UNII Detection Bandwidth of the DUT. Each burst from the waveform file initiates a trigger pulse at the beginning that switches the RF list from one item to the next one.

3.2.4 Master DFS Threshold Level

Master DFS Threshold Level	
DFS Threshold level: -63 dBm	<input type="checkbox"/> at the antenna connector
	<input checked="" type="checkbox"/> in front of the antenna
The Interference Radar Detection Threshold Level is $(-64\text{dBm}) + \{1 \text{ dB}\} = -63 \text{ dBm}$. That had been taken into account the master output power range and antenna gain.	

3.2.5 Calibration Setup

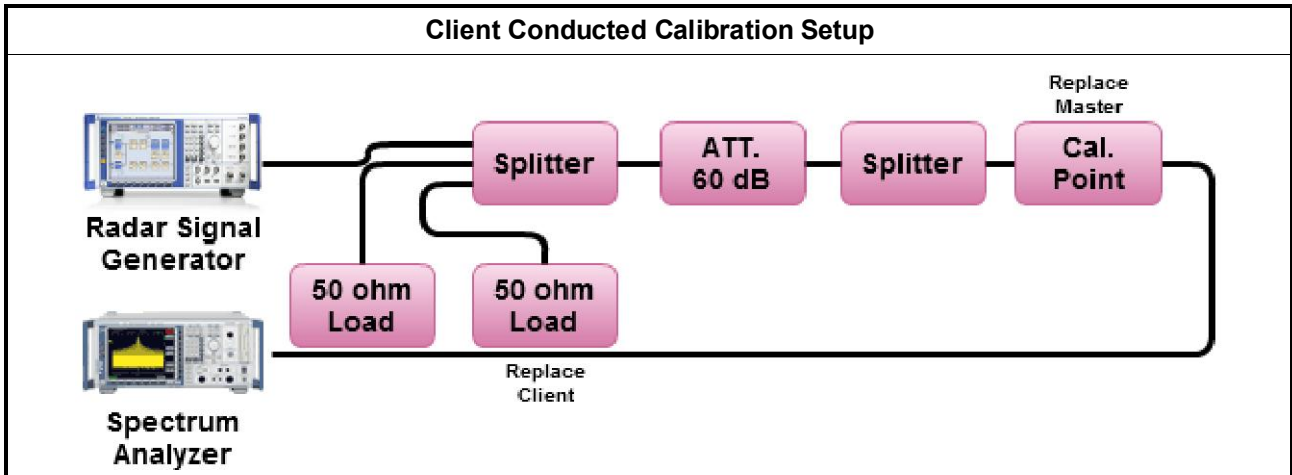

Calibration Plots

Radar #1 DFS detection threshold level

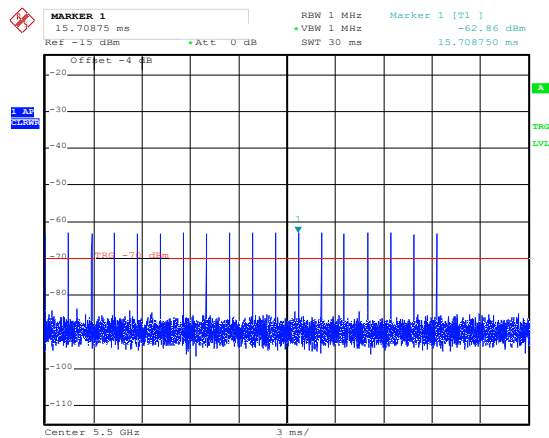

Date: 24.OCT.2012 11:40:09

3.2.6 Test Setup

A spectrum analyzer is used as a monitor to verify that the EUT has vacated the Channel within the (Channel Closing Transmission Time and Channel Move Time, and does not transmit on a Channel during the Non-Occupancy Period after the detection and Channel move.

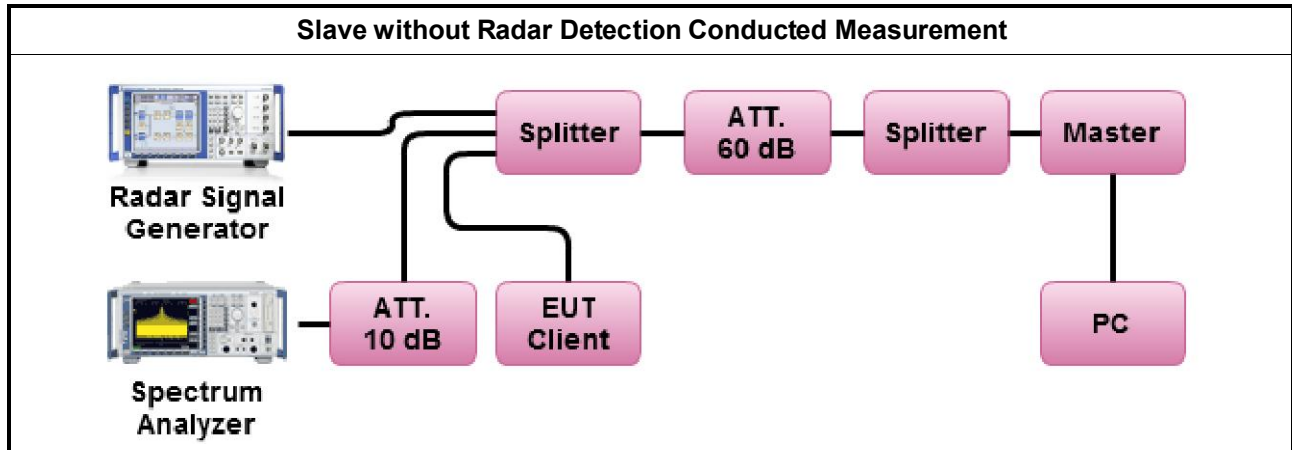



Verification that when the EUT is "off" that the RF energy emitted Plots

Without Data Traffic Plot (Noise Plot)

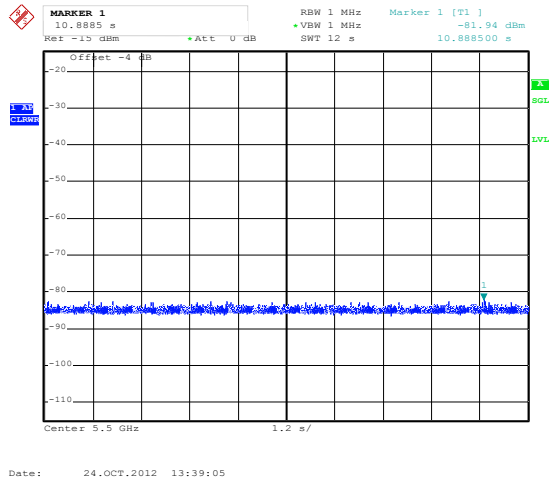

EUT Data Traffic Plot

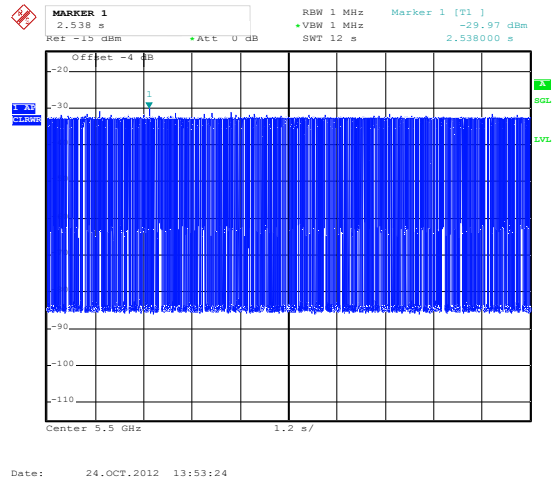

Master Data Traffic Plot

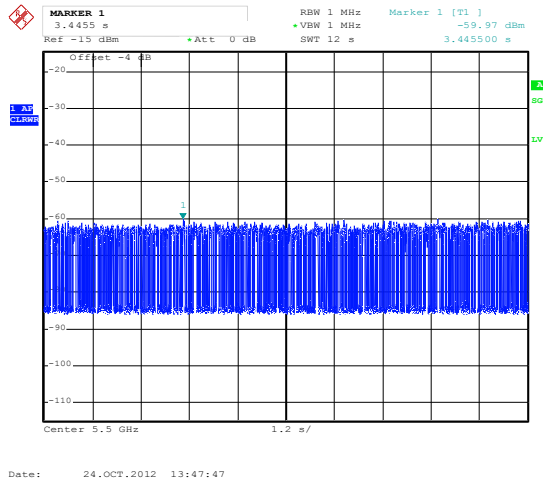



3.3 In-service Monitoring

3.3.1 In-service Monitoring Limit

In-service Monitoring Limit	
Channel Move Time	10 sec
Channel Closing Transmission Time	200 ms + an aggregate of 60 ms over remaining 10 sec periods.
Non-occupancy period	Minimum 30 minutes

3.3.2 Measuring Instruments

Refer a test equipment and calibration data table in this test report.

3.3.3 Test Procedures

Test Method
<input checked="" type="checkbox"/> Refer as FCC 06-96 Appendix, clause 7.8.3 verified during In-Service Monitoring; Channel Closing Transmission Time, Channel Move Time. Client Device will associate with the EUT. Observe the transmissions of the EUT at the end of the radar Burst on the Operating Channel for duration greater than 10 seconds. Measure and record the transmissions from the EUT during the observation time (Channel Move Time). Compare the Channel Move Time and Channel Closing Transmission Time limits.
<input checked="" type="checkbox"/> Refer as FCC 06-96 Appendix, clause 8.3 verified during In-Service Monitoring; Channel Closing Transmission Time, Channel Move Time. One 10 sec plot needs to be reported for the Short Pulse Radar Types 1-4 and one for the Long Pulse Radar Type in a 22 sec plot. And zoom-in a 600 ms plot verified channel closing time for the aggregate transmission time starting from 200ms after the end of the radar signal to the completion of the channel move.
<input checked="" type="checkbox"/> Refer as FCC 06-96 Appendix, clause 7.8.3 verified during In-Service Monitoring; Non-Occupancy Period. Client Device will associate with the EUT. Observe the transmissions of the EUT at the end of the radar Burst on the Operating Channel for duration greater than 10 seconds. Measure and record the transmissions from the EUT during the observation time (Non-Occupancy Period). Compare the Non-Occupancy Period limits.



3.3.4 Test Result of In-service Monitoring

Channel Closing Transmission Time and Channel Move Time Result							
Modulation Mode	Freq. (MHz)	Radar Type Signal	Channel Closing Transmission Time		Channel Move Time		
			Measured	Limit	Measured	Limit	
115.6G-20M	5500	1	0 ms	60 ms	0 s	10 s	
Result			Complied				
12 sec Timing Plot				Zoom-in 600 ms Timing Plot			
<p>Date: 24.OCT.2012 14:05:43</p> <p>Date: 24.OCT.2012 16:53:43</p>							
Channel Closing Transmission Time and Channel Move Time Result							
Modulation Mode	Freq. (MHz)	Radar Type Signal	Channel Closing Transmission Time		Channel Move Time		
			Measured	Limit	Measured	Limit	
11N5.6G-40M	5510	1	0 ms	60 ms	0 s	10 s	
Result			Complied				
12 sec Timing Plot				Zoom-in 600 ms Timing Plot			
<p>Date: 24.OCT.2012 19:12:23</p> <p>Date: 24.OCT.2012 19:17:12</p>							



Non-Occupancy Period Result

Modulation Mode	Freq. (MHz)	Non-Occupancy Period		
		Measured	Limit	Result
11a5.6G-20M	5500 (F3)	>30min	30 min	Complied

2000 sec Timing Plot

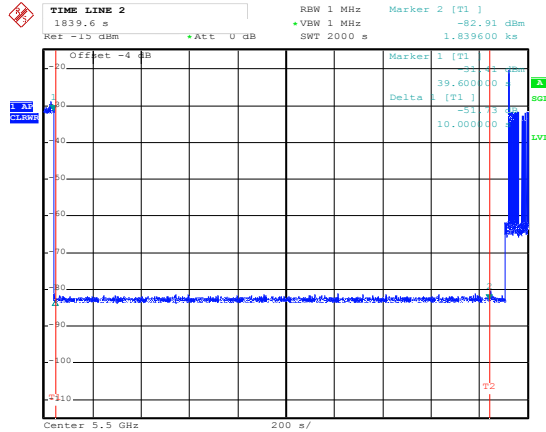

Date: 24.OCT.2012 18:13:10



4 Test Equipment and Calibration Data

Instrument	Manufacturer	Model No.	Serial No.	Spec.	Calibration Date	Remark
Spectrum Analyzer	R&S	FSP 7	100645	9kHz ~ 7GHz	Mar. 29, 2012	DFS01-HY
Vector Signal Generator	R&S	SMU200A	102098	100kHz ~ 6GHz	Oct. 03, 2012	DFS01-HY
RF Cable-3m	HUBER+SUHNER	SUCOFLEX_104	302338	1GHz ~ 26.5GHz	Jan. 02, 2012	DFS01-HY
RF Cable-10m	HUBER+SUHNER	SUCOFLEX_104	302345	1GHz ~ 26.5GHz	Jan. 02, 2012	DFS01-HY
Horn Antenna	COM-POWER	AH-118	10094	1GHz ~ 18GHz	Feb. 15, 2012	DFS01-HY
Horn Antenna	ETS	3115	6744	1GHz ~ 18GHz	Mar. 23, 2012	DFS01-HY

5 Certification of TAF Accreditation



Certificate No. : L1190-120405

財團法人全國認證基金會
Taiwan Accreditation Foundation

Certificate of Accreditation

This is to certify that

Sporton International Inc.
EMC & Wireless Communications Laboratory
No.52, Hwa Ya 1st Rd., Hwa Ya Technology Park, Kwei-Shan Hsiang, Tao Yuan Hsien,
Taiwan, R.O.C.

is accredited in respect of laboratory

Accreditation Criteria : ISO/IEC 17025:2005
Accreditation Number : 1190
Originally Accredited : December 15, 2003
Effective Period : January 10, 2010 to January 09, 2013
Accredited Scope : Testing Field, see described in the Appendix
Specific Accreditation Program : Accreditation Program for Designated Testing Laboratory for Commodities Inspection
Accreditation Program for Telecommunication Equipment Testing Laboratory
Accreditation Program for BSMI Mutual Recognition Arrangement with Foreign Authorities

Jay-san Chen
Jay-San Chen
President, Taiwan Accreditation Foundation
Date: April 05, 2012

P1, total 24 pages