



## SAR EVALUATION REPORT

**Applicant Name:**  
 Samsung Electronics, Co. Ltd.  
 129, Samsung-ro, Maetan dong,  
 Yeongtong-gu, Suwon-si  
 Gyeonggi-do 443-742, Korea

**Date of Testing:**  
 07/07/14 - 07/09/14  
**Test Site/Location:**  
 PCTEST Lab, Columbia, MD, USA  
**Document Serial No.:**  
 0Y1407011333.A3L

**FCC ID:** A3LSPHL520

**APPLICANT:** SAMSUNG ELECTRONICS, CO. LTD.

**DUT Type:** Portable Handset  
**Application Type:** Class II Permissive Change  
**FCC Rule Part(s):** CFR §2.1093  
**Model(s):** SPH-L520  
**Permissive Change(s):** Adding 1.4, 15, and 20MHz BW to LTE B25 and 5MHz BW to LTEB41  
**Date of Original Certification:** 09/04/13

Equipment Class	Band & Mode	Tx Frequency	SAR		
			1 gm Head (W/kg)	1 gm Body-Worn (W/kg)	1 gm Hotspot (W/kg)
PCE	LTE Band 25 (PCS)	1850.7 - 1914.3 MHz	0.44	0.47	0.47
<b>Simultaneous SAR per KDB 690783 D01v01r02:</b>			0.55	0.75	0.55



The table above shows Test Data evaluated for the current test report. Please refer to RF Exposure Technical Reports 0Y1306281121-R2.A3L for compliance evaluation.

This wireless portable device has been shown to be capable of compliance for localized specific absorption rate (SAR) for uncontrolled environment/general population exposure limits specified in ANSI/IEEE C95.1-1992 and has been tested in accordance with the measurement procedures specified in Section 1.8 of this report; for North American frequency bands only.

I attest to the accuracy of data. All measurements reported herein were performed by me or were made under my supervision and are correct to the best of my knowledge and belief. I assume full responsibility for the completeness of these measurements and vouch for the qualifications of all persons taking them. Test results reported herein relate only to the item(s) tested.



  
 Randy Ortanez  
 President



FCC ID A3LSPHL520	 SAR EVALUATION REPORT		Reviewed by: Quality Manager
Document S/N: 0Y1407011333.A3L	Test Dates: 07/07/14 - 07/09/14	DUT Type: Portable Handset	Page 1 of 41

# T A B L E O F C O N T E N T S

1	DEVICE UNDER TEST .....	3
2	LTE INFORMATION .....	8
3	INTRODUCTION .....	9
4	DOSIMETRIC ASSESSMENT .....	10
5	DEFINITION OF REFERENCE POINTS .....	11
6	TEST CONFIGURATION POSITIONS FOR HANDSETS .....	12
7	RF EXPOSURE LIMITS .....	16
8	FCC MEASUREMENT PROCEDURES.....	17
9	RF CONDUCTED POWERS.....	19
10	SYSTEM VERIFICATION.....	29
11	SAR DATA SUMMARY .....	30
12	FCC MULTI-TX AND ANTENNA SAR CONSIDERATIONS.....	32
13	SAR MEASUREMENT VARIABILITY .....	36
14	EQUIPMENT LIST.....	37
15	MEASUREMENT UNCERTAINTIES .....	38
16	CONCLUSION.....	39
17	REFERENCES .....	40
APPENDIX A: SAR TEST PLOTS		
APPENDIX B: SAR DIPOLE VERIFICATION PLOTS		
APPENDIX C: PROBE AND DIPOLE CALIBRATION CERTIFICATES		
APPENDIX D: SAR TISSUE SPECIFICATIONS		
APPENDIX E: SAR SYSTEM VALIDATION		
APPENDIX F: SAR TEST SETUP PHOTOGRAPHS		

<b>FCC ID</b> A3LSPHL520	 <small>PROFESSIONAL COMMUNICATIONS TEST ENGINEERING LABORATORY, INC.</small>	<b>SAR EVALUATION REPORT</b>		<b>Reviewed by:</b> Quality Manager
<b>Document S/N:</b> 0Y1407011333.A3L	<b>Test Dates:</b> 07/07/14 - 07/09/14	<b>DUT Type:</b> Portable Handset	Page 2 of 41	

# 1 DEVICE UNDER TEST



## 1.1 Device Overview

Band & Mode	Operating Modes	Tx Frequency
CDMA/EVDO BC10 (§90S)	Voice/Data	817.90 - 823.10 MHz
CDMA/EVDO BC0 (§22H)	Voice/Data	824.70 - 848.31 MHz
PCS CDMA/EVDO	Voice/Data	1851.25 - 1908.75 MHz
LTE Band 26	Data	814.7 - 848.3 MHz
LTE Band 25 (PCS)	Data	1850.7 - 1914.3 MHz
LTE Band 41	Data	2498.5 - 2687.5 MHz
2.4 GHz WLAN	Data	2412 - 2462 MHz
5.8 GHz WLAN	Data	5745 - 5825 MHz
5.2 GHz WLAN	Data	5180 - 5240 MHz
5.3 GHz WLAN	Data	5260 - 5320 MHz
5.5 GHz WLAN	Data	5500 - 5700 MHz
Bluetooth	Data	2402 - 2480 MHz
NFC	Data	13.56 MHz

## 1.2 Nominal and Maximum Output Power Specifications

This device operates using the following maximum and nominal output power specifications. SAR values were scaled to the maximum allowed power to determine compliance per KDB Publication 447498 D01v05.

Mode / Band		Modulated Average (dBm)
LTE Band 25 (PCS)	Maximum	<b>23.5</b>
	Nominal	<b>23.0</b>
LTE Band 41	Maximum	<b>23.5</b>
	Nominal	<b>23.0</b>

FCC ID A3LSPHL520	 <b>PCTEST</b> PROFESSIONAL COMMUNICATIONS TEST ENGINEERING, INC.	<b>SAR EVALUATION REPORT</b>		<b>Reviewed by:</b> Quality Manager
<b>Document S/N:</b> 0Y1407011333.A3L	<b>Test Dates:</b> 07/07/14 - 07/09/14	<b>DUT Type:</b> Portable Handset	Page 3 of 41	

### 1.3 DUT Antenna Locations

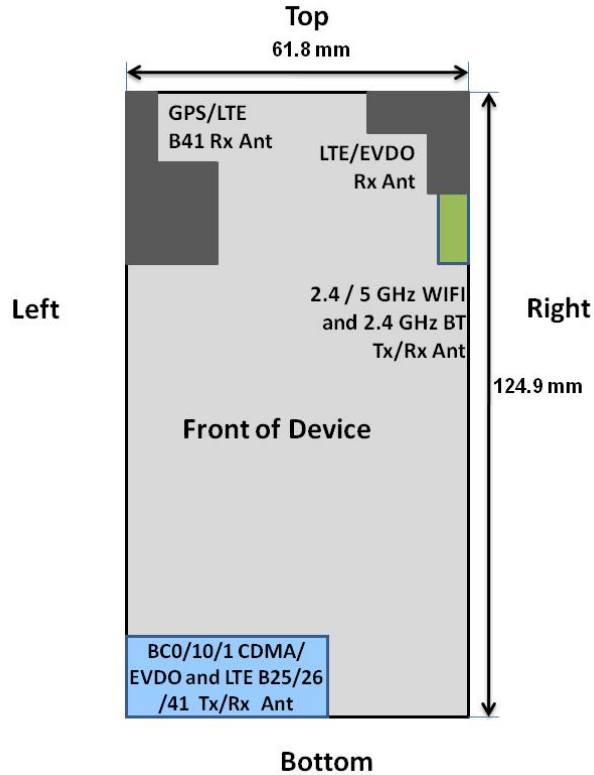



Note: Exact antenna dimensions and separation distances are shown in the Technical Descriptions in the FCC Filing.

**Figure 1-1**  
**DUT Antenna Locations**

**Table 1-1**  
**Mobile Hotspot Sides for SAR Testing**

Mode	Back	Front	Top	Bottom	Right	Left
LTE Band 25 (PCS)	Yes	Yes	No	Yes	No	Yes

Note: Particular DUT edges were not required to be evaluated for Wireless Router SAR if the edges were greater than 2.5 cm from the transmitting antenna according to FCC KDB Publication 941225 D06v01 guidance, page 2. The antenna document shows the distances between the transmit antennas and the edges of the device.

FCC ID A3LSPHL520		SAR EVALUATION REPORT		Reviewed by: Quality Manager
Document S/N: 0Y1407011333.A3L	Test Dates: 07/07/14 - 07/09/14	DUT Type: Portable Handset	Page 4 of 41	

### 1.4 Near Field Communications (NFC) Antenna

This DUT has NFC operations. The NFC antenna is integrated into the standard battery. The SAR tests were performed with the specialized battery (model: B500BU).

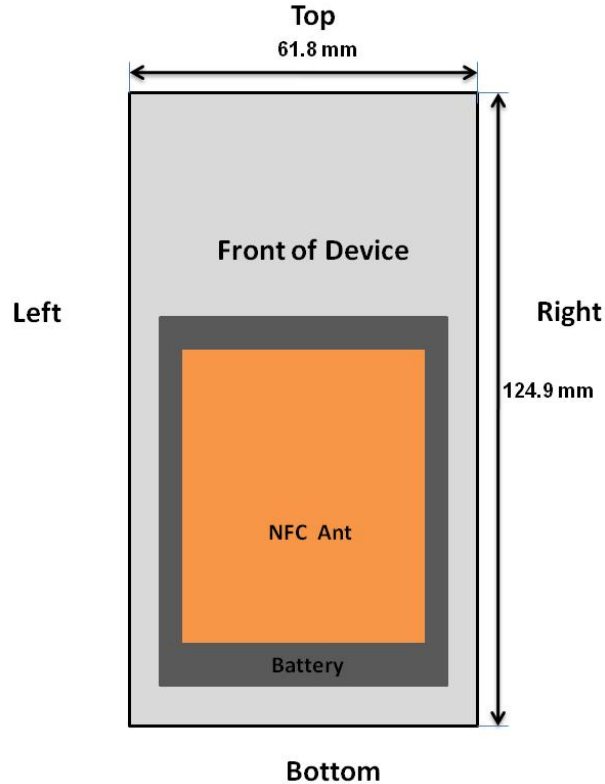



**Figure 1-2  
NFC Antenna Locations**

### 1.5 Simultaneous Transmission Capabilities

According to FCC KDB Publication 447498 D05v01, transmitters are considered to be transmitting simultaneously when there is overlapping transmission, with the exception of transmissions during network hand-offs with maximum hand-off duration less than 30 seconds. Possible transmission paths for the DUT are shown in Figure 1-3 and are color-coded to indicate communication modes which share the same path. Modes which share the same transmission path cannot transmit simultaneously with one another.



**Figure 1-3  
Simultaneous Transmission Paths**

FCC ID A3LSPHL520	 <b>PCTEST</b> PROFESSIONAL COMMUNICATIONS TEST ENGINEERING, INC.	<b>SAR EVALUATION REPORT</b>		<b>Reviewed by:</b> Quality Manager
<b>Document S/N:</b> 0Y1407011333.A3L	<b>Test Dates:</b> 07/07/14 - 07/09/14	<b>DUT Type:</b> Portable Handset	Page 5 of 41	

This device contains multiple transmitters that may operate simultaneously, and therefore requires a simultaneous transmission analysis according to FCC KDB Publication 447498 D01v05 3) procedures.

**Table 1-2  
Simultaneous Transmission Scenarios**

Ref.	Simultaneous Transmit Configurations	Head	Body-Worn Accessory	Hot Spot	Note
		IEEE 1528, Supp C	Supplement C	FCC KDB 941225 D06 edges/sides	
1	1X CDMA BC0 Voice + 2.4/5 GHz WIFI	Yes	10mm	N/A	1x Voice and WiFi Data
2	1X CDMA BC1 Voice + 2.4/5 GHz WIFI	Yes	10mm	N/A	1x Voice and WiFi Data
3	1X CDMA BC10 Voice + 2.4/5 GHz WIFI	Yes	10mm	N/A	1x Voice and WiFi Data
4	1X CDMA BC0 Voice + 2.4 GHz Bluetooth	N/A	10mm	N/A	
5	1X CDMA BC1 Voice + 2.4 GHz Bluetooth	N/A	10mm	N/A	
6	1X CDMA BC10 Voice + 2.4 GHz Bluetooth	N/A	10mm	N/A	
7	1X/EVDO BC0/BC1/BC10 Data + 2.4 GHz WIFI	Yes*	10mm	Yes	1X/EVDO Data + WiFi Hotspot
8	LTE B25 Data + 2.4 GHz WIFI	Yes*	10mm	Yes	LTE + WiFi Hotspot
9	LTE B26 Data + 2.4 GHz WIFI	Yes*	10mm	Yes	LTE + WiFi Hotspot
10	LTE B41 Data + 2.4 GHz WIFI	Yes*	10mm	Yes	LTE + WiFi Hotspot
11	LTE B25 Data + 2.4 GHz Bluetooth	N/A	10mm	N/A	
12	LTE B26 Data + 2.4 GHz Bluetooth	N/A	10mm	N/A	
13	LTE B41 Data + 2.4 GHz Bluetooth	N/A	10mm	N/A	
14	1X/EVDO BC0/BC1/BC10 Data + 5.8 GHz WIFI	Yes*	10mm	Yes	1X/EVDO Data + WiFi Hotspot
15	LTE B25 Data + 5.8 GHz WIFI	Yes*	10mm	Yes	LTE + WiFi Hotspot
16	LTE B26 Data + 5.8 GHz WIFI	Yes*	10mm	Yes	LTE + WiFi Hotspot
17	LTE B41 Data + 5.8 GHz WIFI	Yes*	10mm	Yes	LTE + WiFi Hotspot
18	1X CDMA BC0 Voice + EVDO BC0/BC1/BC10 Data + 2.4 GHz WIFI	N/A	N/A	N/A	Not Supported by HW (Non-SVDO)
19	1X CDMA BC1 Voice + EVDO BC0/BC1/BC10 Data + 2.4 GHz WIFI	N/A	N/A	N/A	Not Supported by HW (Non-SVDO)
20	1X CDMA BC10 Voice + EVDO BC0/BC1/BC10 Data + 2.4 GHz WIFI	N/A	N/A	N/A	Not Supported by HW (Non-SVDO)
21	1X CDMA BC0/BC1/BC10 Voice + LTE B25 Data + 5.2 - 5.7 GHz WIFI	N/A	N/A	N/A	5.2-5.7 WiFi Hotspot Not supported by SW
22	1X/EVDO BC0/BC1/BC10 Data + 5.2 - 5.7 GHz WIFI	N/A	N/A	N/A	5.2-5.7 WiFi Hotspot Not supported by SW
23	LTE B25 Data + 5.2 - 5.7 GHz WIFI	N/A	N/A	N/A	5.2-5.7 WiFi Hotspot Not supported by SW
24	LTE B26 Data + 5.2 - 5.7 GHz WIFI	N/A	N/A	N/A	5.2-5.7 WiFi Hotspot Not supported by SW
25	LTE B41 Data + 5.2 - 5.7 GHz WIFI	N/A	N/A	N/A	5.2-5.7 WiFi Hotspot Not supported by SW
26	EVDO BC0/BC1/BC10 Data + LTE B25 Data	N/A	N/A	N/A	Not supported by SW
27	EVDO BC0/BC1/BC10 Data + LTE B26 Data	N/A	N/A	N/A	Not supported by SW
28	EVDO BC0/BC1/BC10 Data + LTE B41 Data	N/A	N/A	N/A	Not supported by SW



Notes:

1. CDMA and EVDO share the same antenna path and cannot transmit simultaneously. (Non-SVDO)
2. Bluetooth and 2.4 GHz WLAN share the same antenna path and cannot transmit simultaneously.

(\*)=for VoIP 3rd party apps possibly installed and used by end-user

## 1.6 SAR Test Exclusions Applied

This report evaluates SAR compliance for LTE Band 25. LTE Band 41 5 MHz bandwidth was not required for SAR testing as the highest bandwidth was tested in RF Exposure Technical Report 0Y1306281121-R2.A3L Please refer to RF Exposure Technical Report 0Y1306281121-R2.A3L for original compliance report containing data for other main antenna and WLAN modes. No changes were made to any other modes or bands.

FCC ID A3LSPHL520	 PCTEST PROFESSIONAL CORPORATION, INC.	SAR EVALUATION REPORT		Reviewed by: Quality Manager
Document S/N: 0Y1407011333.A3L	Test Dates: 07/07/14 - 07/09/14	DUT Type: Portable Handset		Page 6 of 41

### (A) Licensed Transmitter(s)

LTE SAR for the higher modulations and lower bandwidths were not tested since the maximum average output power of all required channels and configurations was not more than 0.5 dB higher than the highest bandwidth; and the reported LTE SAR for the highest bandwidth was less than 1.45 W/kg for all configurations according to FCC KDB 941225 D05v02.

## 1.7 Power Reduction for SAR

There is no power reduction used for any band/mode implemented in this device for SAR purposes.



## 1.8 Guidance Applied

- IEEE 1528-2003
- FCC KDB Publication 941225 D05 v02r03 (4G)
- FCC KDB Publication 941225 D06 v01r01 (Hotspot)
- FCC KDB Publication 447498 D01 v05r02 (General SAR Guidance)
- FCC KDB Publication 865664 D01 v01r03 (SAR Measurements up to 6 GHz)
- FCC KDB Publication 865664 D02 v01r01 (RF Exposure Reporting)

## 1.9 Device Serial Numbers

The manufacturer has confirmed that the device tested has the same physical, mechanical and thermal characteristics and is within operational tolerances expected for production units.



	Head Serial Number	Body-Worn Serial Number	Hotspot Serial Number
LTE Band 25 (PCS)	051805af	051805af	051805af

FCC ID A3LSPHL520	 <b>PCTEST</b> PROFESSIONAL CORPORATION, INC.	<b>SAR EVALUATION REPORT</b>		<b>Reviewed by:</b> Quality Manager
<b>Document S/N:</b> 0Y1407011333.A3L	<b>Test Dates:</b> 07/07/14 - 07/09/14	<b>DUT Type:</b> Portable Handset		Page 7 of 41

## 2

## LTE INFORMATION

LTE Information					
FCC ID	A3LSPHL520				
Form Factor	Portable Handset				
Frequency Range of each LTE transmission band	LTE Band 25 (PCS) (1850.7 - 1914.3 MHz)				
	LTE Band 41 (2498.5 - 2687.5 MHz)				
Channel Bandwidths	LTE Band 25 (PCS): 1.4 MHz, 3 MHz, 5 MHz, 10 MHz, 15 MHz, 20 MHz				
	LTE Band 41: 5 MHz, 10 MHz, 15 MHz, 20 MHz				
Channel Numbers and Frequencies (MHz)	Low		Mid		High
LTE Band 25 (PCS): 1.4 MHz	1850.7 (26047)	N/A	1882.5 (26365)	N/A	1914.3 (26683)
LTE Band 25 (PCS): 3 MHz	1851.5 (26055)		1882.5 (26365)		1913.5 (26675)
LTE Band 25 (PCS): 5 MHz	1852.5 (26065)		1882.5 (26365)		1912.5 (26665)
LTE Band 25 (PCS): 10 MHz	1855 (26090)		1882.5 (26365)		1910 (26640)
LTE Band 25 (PCS): 15 MHz	1857.5 (26115)		1882.5 (26365)		1907.5 (26615)
LTE Band 25 (PCS): 20 MHz	1860 (26140)		1882.5 (26365)		1905 (26590)
LTE Band 41: 5 MHz	2498.5 (39675)	2545.75 (40148)	2593 (40620)	2640.25 (41093)	2687.5 (41565)
LTE Band 41: 10 MHz	2501 (39700)	2547 (40160)	2593 (40620)	2639 (41080)	2685 (41540)
LTE Band 41: 15 MHz	2503.5 (39725)	2548.3 (40173)	2593 (40620)	2637.8 (41068)	2682.5 (41515)
LTE Band 41: 20 MHz	2506 (39750)	2549.5 (40185)	2593 (40620)	2636.5 (41055)	2680 (41490)
UE Category	3				
Modulations Supported in UL	QPSK, 16QAM				
LTE MPR Permanently implemented per 3GPP TS 36.101 section 6.2.3~6.2.5? (manufacturer attestation to be provided)	YES				
A-MPR (Additional MPR) disabled for SAR Testing?	YES				

FCC ID A3LSPHL520		SAR EVALUATION REPORT		Reviewed by: Quality Manager
Document S/N: 0Y1407011333.A3L	Test Dates: 07/07/14 - 07/09/14	DUT Type: Portable Handset		Page 8 of 41



## 3 INTRODUCTION

The FCC and Industry Canada have adopted the guidelines for evaluating the environmental effects of radio frequency (RF) radiation in ET Docket 93-62 on Aug. 6, 1996 and Health Canada Safety Code 6 to protect the public and workers from the potential hazards of RF emissions due to FCC-regulated portable devices. [1]

The safety limits used for the environmental evaluation measurements are based on the criteria published by the American National Standards Institute (ANSI) for localized specific absorption rate (SAR) in IEEE/ANSI C95.1-1992 Standard for Safety Levels with Respect to Human Exposure to Radio Frequency Electromagnetic Fields, 3 kHz to 300 GHz [3] and Health Canada RF Exposure Guidelines Safety Code 6 [22]. The measurement procedure described in IEEE/ANSI C95.3-2002 Recommended Practice for the Measurement of Potentially Hazardous Electromagnetic Fields - RF and Microwave [4] is used for guidance in measuring the Specific Absorption Rate (SAR) due to the RF radiation exposure from the Equipment Under Test (EUT). These criteria for SAR evaluation are similar to those recommended by the International Committee for Non-Ionizing Radiation Protection (ICNIRP) in Biological Effects and Exposure Criteria for Radiofrequency Electromagnetic Fields,” Report No. Vol 74. SAR is a measure of the rate of energy absorption due to exposure to an RF transmitting source. SAR values have been related to threshold levels for potential biological hazards.

### 3.1 SAR Definition

Specific Absorption Rate is defined as the time derivative (rate) of the incremental energy (dU) absorbed by (dissipated in) an incremental mass (dm) contained in a volume element (dV) of a given density (ρ). It is also defined as the rate of RF energy absorption per unit mass at a point in an absorbing body (see Equation 3-1).

**Equation 3-1**  
**SAR Mathematical Equation**

$$SAR = \frac{d}{dt} \left( \frac{dU}{dm} \right) = \frac{d}{dt} \left( \frac{dU}{\rho dv} \right)$$



**SAR is expressed in units of Watts per Kilogram (W/kg).**

$$SAR = \frac{\sigma \cdot E^2}{\rho}$$

where:

- σ = conductivity of the tissue-simulating material (S/m)
- ρ = mass density of the tissue-simulating material (kg/m<sup>3</sup>)
- E = Total RMS electric field strength (V/m)

NOTE: The primary factors that control rate of energy absorption were found to be the wavelength of the incident field in relation to the dimensions and geometry of the irradiated organism, the orientation of the organism in relation to the polarity of field vectors, the presence of reflecting surfaces, and whether conductive contact is made by the organism with a ground plane.[6]

FCC ID A3LSPHL520		SAR EVALUATION REPORT		Reviewed by: Quality Manager
Document S/N: 0Y1407011333.A3L	Test Dates: 07/07/14 - 07/09/14	DUT Type: Portable Handset	Page 9 of 41	

## 4 DOSIMETRIC ASSESSMENT

### 4.1 Measurement Procedure

The evaluation was performed using the following procedure compliant to FCC KDB Publication 865664 D01v01 and IEEE 1528-2013:

1. The SAR distribution at the exposed side of the head or body was measured at a distance no greater than 5.0 mm from the inner surface of the shell. The area covered the entire dimension of the device-head and body interface and the horizontal grid resolution was determined per FCC KDB Publication 865664 D01v01 (See Table 4-1) and IEEE 1528-2013.
2. The point SAR measurement was taken at the maximum SAR region determined from Step 1 to enable the monitoring of SAR fluctuations/drifts during the 1g/10g cube evaluation. SAR at this fixed point was measured and used as a reference value.
3. Based on the area scan data, the peak of the region with maximum SAR was determined by spline interpolation. Around this point, a volume was assessed according to the measurement resolution and volume size requirements of FCC KDB Publication 865664 D01v01 (See Table 4-1) and IEEE 1528-2013. On the basis of this data set, the spatial peak SAR value was evaluated with the following procedure (see references or the DASYS manual online for more details):
  - a. SAR values at the inner surface of the phantom are extrapolated from the measured values along the line away from the surface with spacing no greater than that in Table 4-1. The extrapolation was based on a least-squares algorithm. A polynomial of the fourth order was calculated through the points in the z-axis (normal to the phantom shell).
  - b. After the maximum interpolated values were calculated between the points in the cube, the SAR was averaged over the spatial volume (1g or 10g) using a 3D-Spline interpolation algorithm. The 3D-spline is composed of three one-dimensional splines with the "Not a knot" condition (in x, y, and z directions). The volume was then integrated with the trapezoidal algorithm. One thousand points (10 x 10 x 10) were obtained through interpolation, in order to calculate the averaged SAR.
  - c. All neighboring volumes were evaluated until no neighboring volume with a higher average value was found.
4. The SAR reference value, at the same location as step 2, was re-measured after the zoom scan was complete to calculate the SAR drift. If the drift deviated by more than 5%, the SAR test and drift measurements were repeated.

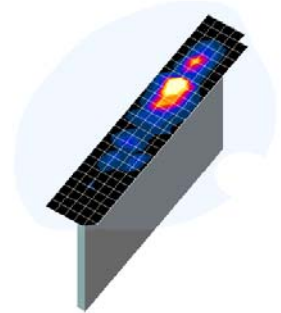



**Figure 4-1**  
Sample SAR Area Scan

**Table 4-1**  
Area and Zoom Scan Resolutions per FCC KDB Publication 865664 D01v01\*

Frequency	Maximum Area Scan Resolution (mm) ( $\Delta x_{area}$ , $\Delta y_{area}$ )	Maximum Zoom Scan Resolution (mm) ( $\Delta x_{zoom}$ , $\Delta y_{zoom}$ )	Maximum Zoom Scan Spatial Resolution (mm)			Minimum Zoom Scan Volume (mm) (x, y, z)
			Uniform Grid	Graded Grid		
			$\Delta z_{zoom}(n)$	$\Delta z_{zoom}(1)^*$	$\Delta z_{zoom}(n>1)^*$	
≤ 2 GHz	≤ 15	≤ 8	≤ 5	≤ 4	≤ 1.5* $\Delta z_{zoom}(n-1)$	≥ 30
2-3 GHz	≤ 12	≤ 5	≤ 5	≤ 4	≤ 1.5* $\Delta z_{zoom}(n-1)$	≥ 30
3-4 GHz	≤ 12	≤ 5	≤ 4	≤ 3	≤ 1.5* $\Delta z_{zoom}(n-1)$	≥ 28
4-5 GHz	≤ 10	≤ 4	≤ 3	≤ 2.5	≤ 1.5* $\Delta z_{zoom}(n-1)$	≥ 25
5-6 GHz	≤ 10	≤ 4	≤ 2	≤ 2	≤ 1.5* $\Delta z_{zoom}(n-1)$	≥ 22

\*Also compliant to IEEE 1528-2013 Table 6

FCC ID A3LSPHL520		SAR EVALUATION REPORT		Reviewed by: Quality Manager
Document S/N: 0Y1407011333.A3L	Test Dates: 07/07/14 - 07/09/14	DUT Type: Portable Handset		Page 10 of 41

# 5 DEFINITION OF REFERENCE POINTS

## 5.1 EAR REFERENCE POINT

Figure 5-2 shows the front, back and side views of the SAM Twin Phantom. The point “M” is the reference point for the center of the mouth, “LE” is the left ear reference point (ERP), and “RE” is the right ERP. The ERP is 15mm posterior to the entrance to the ear canal (EEC) along the B-M line (Back-Mouth), as shown in Figure 5-1. The plane passing through the two ear canals and M is defined as the Reference Plane. The line N-F (Neck-Front), also called the Reference Pivoting Line, is not perpendicular to the reference plane (see Figure 5-1). Line B-M is perpendicular to the N-F line. Both N-F and B-M lines are marked on the external phantom shell to facilitate handset positioning [5].

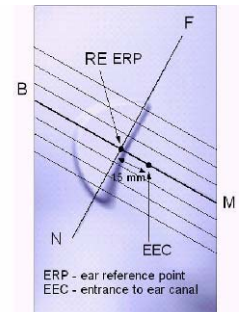

**Figure 5-1**  
Close-Up Side view of ERP

## 5.2 HANDSET REFERENCE POINTS

Two imaginary lines on the handset were established: the vertical centerline and the horizontal line. The test device was placed in a normal operating position with the acoustic output located along the “vertical centerline” on the front of the device aligned to the “ear reference point” (See Figure 5-3). The acoustic output was then located at the same level as the center of the ear reference point. The test device was positioned so that the “vertical centerline” was bisecting the front surface of the handset at its top and bottom edges, positioning the “ear reference point” on the outer surface of the both the left and right head phantoms on the ear reference point.



**Figure 5-2**  
Front, back and side view of SAM Twin Phantom

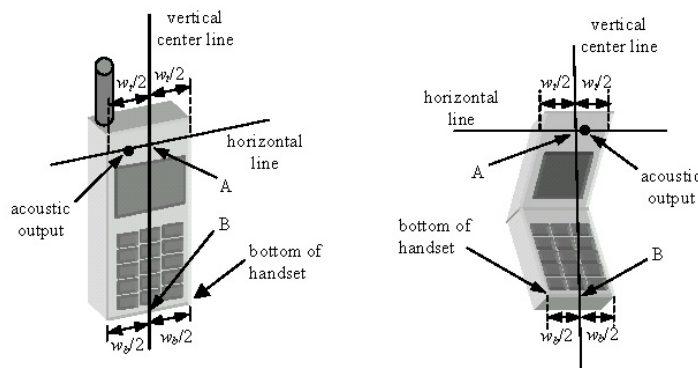

**Figure 5-3**  
Handset Vertical Center & Horizontal Line Reference Points

FCC ID A3LSPHL520	PCTEST PROFESSIONAL COMMUNICATIONS TEST, INC.	SAR EVALUATION REPORT	SAMSUNG	Reviewed by: Quality Manager
Document S/N: 0Y1407011333.A3L	Test Dates: 07/07/14 - 07/09/14	DUT Type: Portable Handset		Page 11 of 41

## 6 TEST CONFIGURATION POSITIONS FOR HANDSETS

### 6.1 Device Holder

The device holder is made out of low-loss POM material having the following dielectric parameters: relative permittivity  $\epsilon = 3$  and loss tangent  $\delta = 0.02$ .

### 6.2 Positioning for Cheek

1. The test device was positioned with the device close to the surface of the phantom such that point A is on the (virtual) extension of the line passing through points RE and LE on the phantom (see Figure 6-1), such that the plane defined by the vertical center line and the horizontal line of the phone is approximately parallel to the sagittal plane of the phantom.

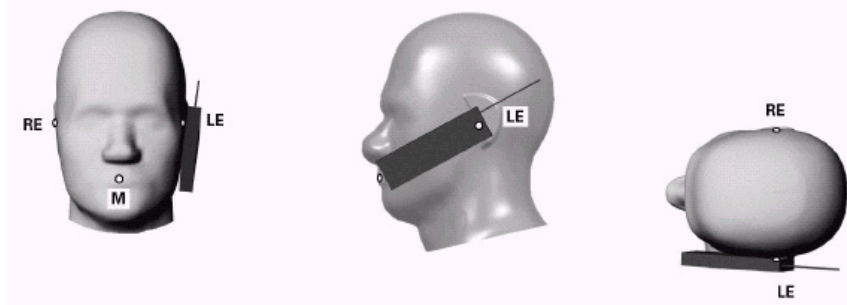



Figure 6-1 Front, Side and Top View of Cheek Position

2. The handset was translated towards the phantom along the line passing through RE & LE until the handset touches the pinna.
3. While maintaining the handset in this plane, the handset was rotated around the LE-RE line until the vertical centerline was in the reference plane.
4. The phone was then rotated around the vertical centerline until the phone (horizontal line) was symmetrical with respect to the line NF.
5. While maintaining the vertical centerline in the reference plane, keeping point A on the line passing through RE and LE, and maintaining the device contact with the ear, the device was rotated about the NF line until any point on the handset made contact with a phantom point below the ear (cheek) (See Figure 6-2).

### 6.3 Positioning for Ear / 15° Tilt

With the test device aligned in the “Cheek Position”:

1. While maintaining the orientation of the phone, the phone was retracted parallel to the reference plane far enough to enable a rotation of the phone by 15 degrees.
2. The phone was then rotated around the horizontal line by 15 degrees.
3. While maintaining the orientation of the phone, the phone was moved parallel to the reference plane until any part of the handset touched the head. (In this position, point A was located on the line RE-LE). The tilted position is obtained when the contact is on the pinna. If the contact was at any location other than the pinna, the angle of the phone would then be reduced. In this situation, the tilted position was obtained when any part of the phone was in contact of the ear as well as a second part of the phone was in contact with the head (see Figure 6-2).

FCC ID A3LSPHL520	 PCTEST PROFESSIONAL CORPORATION, INC.	SAR EVALUATION REPORT		Reviewed by: Quality Manager
Document S/N: 0Y1407011333.A3L	Test Dates: 07/07/14 - 07/09/14	DUT Type: Portable Handset		Page 12 of 41

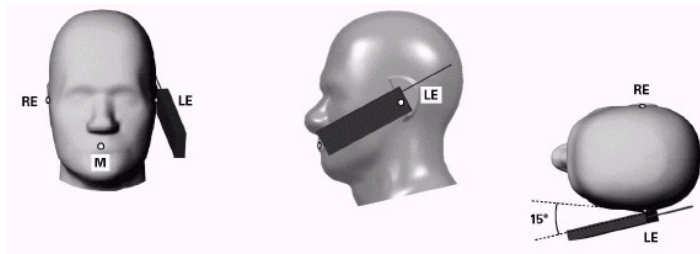

**Figure 6-2 Front, Side and Top View of Ear/15° Tilt Position**

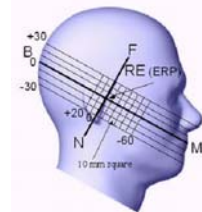
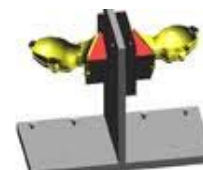

**Figure 6-3 Side view w/ relevant markings**



#### 6.4 SAR Evaluations near the Mouth/Jaw Regions of the SAM Phantom

Antennas located near the bottom of a phone may require SAR measurements around the mouth and jaw regions of the SAM head phantom. This typically applies to clam-shell style phones that are generally longer in the unfolded normal use positions or to certain older style long rectangular phones. Per IEEE 1528-2013, a rotated SAM phantom is necessary to allow probe access to such regions. Both SAM heads of the TwinSAM-Chin20 are rotated 20 degrees around the NF line. Each head can be removed from the table for emptying and cleaning.

Under these circumstances, the following procedures apply, adopted from the FCC guidance on SAR handsets document FCC KDB Publication 648474 D04\_v01. The SAR required in these regions of SAM should be measured using a flat phantom. The phone should be positioned with a separation distance of 4 mm between the ear reference point (ERP) and the outer surface of the flat phantom shell. While maintaining this distance at the ERP location, the low (bottom) edge of the phone should be lowered from the phantom to establish the same separation distance between the peak SAR location identified by the truncated partial SAR distribution measured with the SAM phantom. The distance from the peak SAR location to the phone is determined by the straight line passing perpendicularly through the phantom surface. When it is not feasible to maintain 4 mm separation at the ERP while also establishing the required separation at the peak SAR location, the top edge of the phone will be allowed to touch the phantom with a separation < 4 mm at the ERP. The phone should not be tilted to the left or right while placed in this inclined position to the flat phantom.

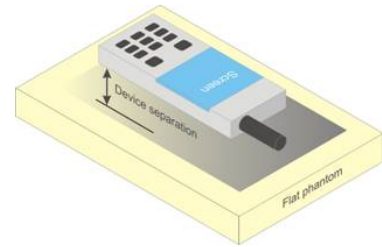

**Figure 6-4 Twin SAM Chin20**

FCC ID A3LSPHL520	 <b>PCTEST</b> PROFESSIONAL CORPORATION, INC.	<b>SAR EVALUATION REPORT</b>		<b>Reviewed by:</b> Quality Manager
<b>Document S/N:</b> 0Y1407011333.A3L	<b>Test Dates:</b> 07/07/14 - 07/09/14	<b>DUT Type:</b> Portable Handset	Page 13 of 41	

## 6.5 Body-Worn Accessory Configurations

Body-worn operating configurations are tested with the belt-clips and holsters attached to the device and positioned against a flat phantom in a normal use configuration (see Figure 6-5). Per FCC KDB Publication 648474 D04v01, Body-worn accessory exposure is typically related to voice mode operations when handsets are carried in body-worn accessories. The body-worn accessory procedures in FCC KDB Publication 447498 D01v05 should be used to test for body-worn accessory SAR compliance, without a headset connected to it. This enables the test results for such configuration to be compatible with that required for hotspot mode when the body-worn accessory test separation distance is greater than or equal to that required for hotspot mode, when applicable. When the reported SAR for a body-worn accessory, measured without a headset connected to the handset, is  $> 1.2 \text{ W/kg}$ , the highest reported SAR configuration for that wireless mode and frequency band should be repeated for that body-worn accessory with a headset attached to the handset.



**Figure 6-5**  
**Sample Body-Worn Diagram**



Accessories for Body-worn operation configurations are divided into two categories: those that do not contain metallic components and those that do contain metallic components. When multiple accessories that do not contain metallic components are supplied with the device, the device is tested with only the accessory that dictates the closest spacing to the body. Then multiple accessories that contain metallic components are tested with the device with each accessory. If multiple accessories share an identical metallic component (i.e. the same metallic belt-clip used with different holsters with no other metallic components) only the accessory that dictates the closest spacing to the body is tested.

Body-worn accessories may not always be supplied or available as options for some devices intended to be authorized for body-worn use. In this case, a test configuration with a separation distance between the back of the device and the flat phantom is used. Test position spacing was documented. Transmitters that are designed to operate in front of a person's face, as in push-to-talk configurations, are tested for SAR compliance with the front of the device positioned to face the flat phantom in head fluid. For devices that are carried next to the body such as a shoulder, waist or chest-worn transmitters, SAR compliance is tested with the accessories, including headsets and microphones, attached to the device and positioned against a flat phantom in a normal use configuration.

## 6.6 Extremity Exposure Configurations

Devices that are designed or intended for use on extremities or mainly operated in extremity only exposure conditions; i.e., hands, wrists, feet and ankles, may require extremity SAR evaluation. When the device also operates in close proximity to the user's body, SAR compliance for the body is also required. The 1-g body and 10-g extremity SAR Exclusion Thresholds found in KDB Publication 44798 D01v05 should be applied to determine SAR test requirements.

Per KDB Publication 447498 D01v05, Cell phones (handsets) are not normally designed to be used on extremities or operated in extremity only exposure conditions. The maximum output power levels of handsets generally do not require extremity SAR testing to show compliance. Therefore, extremity SAR was not evaluated for this device.



FCC ID A3LSPHL520	 PCTEST PROFESSIONAL COMMUNICATIONS TEST, INC.	SAR EVALUATION REPORT		Reviewed by: Quality Manager
Document S/N: 0Y1407011333.A3L	Test Dates: 07/07/14 - 07/09/14	DUT Type: Portable Handset		Page 14 of 41



## 6.7 Wireless Router Configurations

Some battery-operated handsets have the capability to transmit and receive user data through simultaneous transmission of WIFI simultaneously with a separate licensed transmitter. The FCC has provided guidance in FCC KDB Publication 941225 D06 v01 where SAR test considerations for handsets ( $L \times W \geq 9 \text{ cm} \times 5 \text{ cm}$ ) are based on a composite test separation distance of 10 mm from the front, back and edges of the device containing transmitting antennas within 2.5 cm of their edges, determined from general mixed use conditions for this type of devices. Since the hotspot SAR results may overlap with the body-worn accessory SAR requirements, the more conservative configurations can be considered, thus excluding some body-worn accessory SAR tests.

When the user enables the personal wireless router functions for the handset, actual operations include simultaneous transmission of both the WIFI transmitter and another licensed transmitter. Both transmitters often do not transmit at the same transmitting frequency and thus cannot be evaluated for SAR under actual use conditions due to the limitations of the SAR assessment probes. Therefore, SAR must be evaluated for each frequency transmission and mode separately and spatially summed with the WIFI transmitter according to FCC KDB Publication 447498 D01v05 publication procedures. The "Portable Hotspot" feature on the handset was NOT activated during SAR assessments, to ensure the SAR measurements were evaluated for a single transmission frequency RF signal at a time.

FCC ID A3LSPHL520		SAR EVALUATION REPORT		Reviewed by: Quality Manager
Document S/N: 0Y1407011333.A3L	Test Dates: 07/07/14 - 07/09/14	DUT Type: Portable Handset	Page 15 of 41	

# 7 RF EXPOSURE LIMITS

## 7.1 Uncontrolled Environment

UNCONTROLLED ENVIRONMENTS are defined as locations where there is the exposure of individuals who have no knowledge or control of their exposure. The general population/uncontrolled exposure limits are applicable to situations in which the general public may be exposed or in which persons who are exposed as a consequence of their employment may not be made fully aware of the potential for exposure or cannot exercise control over their exposure. Members of the general public would come under this category when exposure is not employment-related; for example, in the case of a wireless transmitter that exposes persons in its vicinity.



## 7.2 Controlled Environment

CONTROLLED ENVIRONMENTS are defined as locations where there is exposure that may be incurred by persons who are aware of the potential for exposure, (i.e. as a result of employment or occupation). In general, occupational/controlled exposure limits are applicable to situations in which persons are exposed as a consequence of their employment, who have been made fully aware of the potential for exposure and can exercise control over their exposure. This exposure category is also applicable when the exposure is of a transient nature due to incidental passage through a location where the exposure levels may be higher than the general population/uncontrolled limits, but the exposed person is fully aware of the potential for exposure and can exercise control over his or her exposure by leaving the area or by some other appropriate means.

**Table 7-1  
SAR Human Exposure Specified in ANSI/IEEE C95.1-1992 and Health Canada Safety Code 6**

HUMAN EXPOSURE LIMITS		
	UNCONTROLLED ENVIRONMENT <i>General Population</i> (W/kg) or (mW/g)	CONTROLLED ENVIRONMENT <i>Occupational</i> (W/kg) or (mW/g)
<b>Peak Spatial Average SAR</b> Head	1.6	8.0
<b>Whole Body SAR</b>	0.08	0.4
<b>Peak Spatial Average SAR</b> Hands, Feet, Ankle, Wrists, etc.	4.0	20

1. The Spatial Peak value of the SAR averaged over any 1 gram of tissue (defined as a tissue volume in the shape of a cube) and over the appropriate averaging time.
2. The Spatial Average value of the SAR averaged over the whole body.
3. The Spatial Peak value of the SAR averaged over any 10 grams of tissue (defined as a tissue volume in the shape of a cube) and over the appropriate averaging time.

FCC ID A3LSPHL520	 <b>PCTEST</b> PROFESSIONAL CORPORATION, INC.	<b>SAR EVALUATION REPORT</b>		<b>Reviewed by:</b> Quality Manager
<b>Document S/N:</b> 0Y1407011333.A3L	<b>Test Dates:</b> 07/07/14 - 07/09/14	<b>DUT Type:</b> Portable Handset	Page 16 of 41	



## 8 FCC MEASUREMENT PROCEDURES

Power measurements were performed using a base station simulator under digital average power.

### 8.1 Measured and Reported SAR

Per FCC KDB Publication 447498 D01v05, When SAR is not measured at the maximum power level allowed for production units, the results must be scaled to the maximum tune-up tolerance limit according to the power applied to the individual channels tested to determine compliance. For simultaneous transmission, the measured aggregate SAR must be scaled according to the sum of the differences between the maximum tune-up tolerance and actual power used to test each transmitter. When SAR is measured at or scaled to the maximum tune-up tolerance limit, the results are referred to as *reported* SAR. The highest *reported* SAR results are identified on the grant of equipment authorization according to procedures in KDB 690783 D01v01r02.

### 8.2 Procedures Used to Establish RF Signal for SAR

The following procedures are according to FCC KDB Publication 941225 D01 "SAR Measurement Procedures for 3G Devices" v02, October 2007.

The device was placed into a simulated call using a base station simulator in a RF shielded chamber. Establishing connections in this manner ensure a consistent means for testing SAR and are recommended for evaluating SAR [4]. Devices under test were evaluated prior to testing, with a fully charged battery and were configured to operate at maximum output power. In order to verify that the device was tested throughout the SAR test at maximum output power, the SAR measurement system measures a "point SAR" at an arbitrary reference point at the start and end of the 1 gram SAR evaluation, to assess for any power drifts during the evaluation. If the power drift deviated by more than 5%, the SAR test and drift measurements were repeated.

### 8.3 SAR Measurement Conditions for LTE

LTE modes were tested according to FCC KDB 941225 D05v02 publication. Please see notes after the tabulated SAR data for required test configurations. Establishing connections with base station simulators ensure a consistent means for testing SAR and are recommended for evaluating SAR [4]. The R&S CMW500 was used for LTE output power measurements and SAR testing. Closed loop power control was used so the UE transmits with maximum output power during SAR testing. SAR tests were performed with the same number of RB and RB offsets transmitting on all TTI frames (maximum TTI).

#### 8.3.1 Spectrum Plots for RB Configurations



A properly configured base station simulator was used for SAR tests and power measurements. Therefore, spectrum plots for RB configurations were not required to be included in this report.

#### 8.3.2 MPR

MPR is permanently implemented for this device by the manufacturer. The specific manufacturer target MPR is indicated alongside the SAR results. MPR is enabled for this device, according to 3GPP TS36.101 Section 6.2.3 – 6.2.5 under Table 6.2.3-1.

#### 8.3.3 A-MPR

A-MPR (Additional MPR) has been disabled for all SAR tests by setting NS=01 on the base station simulator.

FCC ID A3LSPHL520	 PCTEST PROFESSIONAL COMMUNICATIONS TEST EQUIPMENT, INC.	SAR EVALUATION REPORT		Reviewed by: Quality Manager
Document S/N: 0Y1407011333.A3L	Test Dates: 07/07/14 - 07/09/14	DUT Type: Portable Handset		Page 17 of 41



### 8.3.4 TDD

LTE TDD testing procedures were performed using guidance from FCC KDB 941225 D05v02r03 and the SAR test guidance provided in April 2013 TCB workshop notes. TDD was evaluated at the highest duty factor using UL-DL configuration 0 with special subframe configuration 6 and applying the FDD LTE procedures in KDB 941225. SAR evaluations performed using the extended cyclic prefix listed in 3GPP TS 36.211 Section 4.

### 8.3.5 Required RB Size and RB Offsets for SAR Testing

According to FCC KDB 941225 D05v02r01:

- a. Per Section 5.2.1, SAR is required for QPSK 1 RB Allocation for the largest bandwidth
  - i. The required channel and offset combination with the highest maximum output power is required for SAR.
  - ii. When the reported SAR is  $\leq 0.8$  W/kg, testing of the remaining RB offset configurations and required test channels is not required. Otherwise, SAR is required for the remaining required test channels using the RB offset configuration with highest output power for that channel.
  - iii. When the reported SAR for a required test channel is  $> 1.45$  W/kg, SAR is required for all RB offset configurations for that channel.
- b. Per Section 5.2.2, SAR is required for 50% RB allocation using the largest bandwidth following the same procedures outlined in Section 5.2.1.
- c. Per Section 5.2.3, QPSK SAR is not required for the 100% allocation when the highest maximum output power for the 100% allocation is less than the highest maximum output power of the 1 RB and 50% RB allocations and the reported SAR for the 1 RB and 50% RB allocations is  $< 0.8$  W/kg.
- d. Per Section 5.2.4 and 5.3, SAR tests for higher order modulations and lower bandwidths configurations are not required when the conducted power of the required test configurations determined by Sections 5.2.1 through 5.2.3 is less than or equal to  $\frac{1}{2}$  dB higher than the equivalent configuration using QPSK modulation and when the QPSK SAR for those configurations is  $< 1.45$  W/kg.

FCC ID A3LSPHL520	 PCTEST PROFESSIONAL CORPORATION, INC.	SAR EVALUATION REPORT		Reviewed by: Quality Manager
Document S/N: 0Y1407011333.A3L	Test Dates: 07/07/14 - 07/09/14	DUT Type: Portable Handset		Page 18 of 41



# 9 RF CONDUCTED POWERS

## 9.1 LTE Conducted Powers

### 9.1.1 LTE Band 25 (PCS)



Table 9-1  
LTE Band 25 (PCS) Conducted Powers - 20 MHz Bandwidth

	Frequency [MHz]	Channel	Bandwidth [MHz]	Modulation	RB Size	RB Offset	Conducted Power [dBm]	Target MPR [dB]	MPR Allowed per 3GPP [dB]
Low	1860	26140	20	QPSK	1	0	22.89	0	0
	1860	26140	20	QPSK	1	50	23.23	0	0
	1860	26140	20	QPSK	1	99	23.00	0	0
	1860	26140	20	QPSK	50	0	21.79	1	0-1
	1860	26140	20	QPSK	50	25	22.04	1	0-1
	1860	26140	20	QPSK	50	50	22.00	1	0-1
	1860	26140	20	QPSK	100	0	21.88	1	0-1
	1860	26140	20	16QAM	1	0	21.76	1	0-1
	1860	26140	20	16QAM	1	50	21.99	1	0-1
	1860	26140	20	16QAM	1	99	22.04	1	0-1
	1860	26140	20	16QAM	50	0	20.85	2	0-2
	1860	26140	20	16QAM	50	25	21.04	2	0-2
1860	26140	20	16QAM	50	50	21.00	2	0-2	
1860	26140	20	16QAM	100	0	20.94	2	0-2	
Mid	1882.5	26365	20	QPSK	1	0	23.20	0	0
	1882.5	26365	20	QPSK	1	50	23.22	0	0
	1882.5	26365	20	QPSK	1	99	<b>23.25</b>	0	0
	1882.5	26365	20	QPSK	50	0	22.02	1	0-1
	1882.5	26365	20	QPSK	50	25	22.08	1	0-1
	1882.5	26365	20	QPSK	50	50	<b>22.09</b>	1	0-1
	1882.5	26365	20	QPSK	100	0	22.01	1	0-1
	1882.5	26365	20	16QAM	1	0	22.17	1	0-1
	1882.5	26365	20	16QAM	1	50	22.05	1	0-1
	1882.5	26365	20	16QAM	1	99	22.13	1	0-1
	1882.5	26365	20	16QAM	50	0	21.17	2	0-2
	1882.5	26365	20	16QAM	50	25	21.09	2	0-2
1882.5	26365	20	16QAM	50	50	21.19	2	0-2	
1882.5	26365	20	16QAM	100	0	21.10	2	0-2	
High	1905	26590	20	QPSK	1	0	23.09	0	0
	1905	26590	20	QPSK	1	50	22.91	0	0
	1905	26590	20	QPSK	1	99	23.11	0	0
	1905	26590	20	QPSK	50	0	21.69	1	0-1
	1905	26590	20	QPSK	50	25	21.82	1	0-1
	1905	26590	20	QPSK	50	50	21.96	1	0-1
	1905	26590	20	QPSK	100	0	21.93	1	0-1
	1905	26590	20	16QAM	1	0	21.77	1	0-1
	1905	26590	20	16QAM	1	50	21.94	1	0-1
	1905	26590	20	16QAM	1	99	21.84	1	0-1
	1905	26590	20	16QAM	50	0	20.77	2	0-2
	1905	26590	20	16QAM	50	25	20.86	2	0-2
1905	26590	20	16QAM	50	50	20.98	2	0-2	
1905	26590	20	16QAM	100	0	20.91	2	0-2	

FCC ID A3LSPHL520	 <b>PCTEST</b> PROFESSIONAL CORPORATION, INC.	<b>SAR EVALUATION REPORT</b>		<b>Reviewed by:</b> Quality Manager
<b>Document S/N:</b> 0Y1407011333.A3L	<b>Test Dates:</b> 07/07/14 - 07/09/14	<b>DUT Type:</b> Portable Handset	Page 19 of 41	



**Table 9-2  
LTE Band 25 (PCS) Conducted Powers - 15 MHz Bandwidth**

	Frequency [MHz]	Channel	Bandwidth [MHz]	Modulation	RB Size	RB Offset	Conducted Power [dBm]	Target MPR [dB]	MPR Allowed per 3GPP [dB]
Low	1857.5	26115	15	QPSK	1	0	22.77	0	0
	1857.5	26115	15	QPSK	1	36	23.01	0	0
	1857.5	26115	15	QPSK	1	74	22.94	0	0
	1857.5	26115	15	QPSK	36	0	22.01	1	0-1
	1857.5	26115	15	QPSK	36	18	22.16	1	0-1
	1857.5	26115	15	QPSK	36	37	22.17	1	0-1
	1857.5	26115	15	QPSK	75	0	22.01	1	0-1
	1857.5	26115	15	16QAM	1	0	22.13	1	0-1
	1857.5	26115	15	16QAM	1	36	21.95	1	0-1
	1857.5	26115	15	16QAM	1	74	21.78	1	0-1
	1857.5	26115	15	16QAM	36	0	21.01	2	0-2
	1857.5	26115	15	16QAM	36	18	20.89	2	0-2
	1857.5	26115	15	16QAM	36	37	20.95	2	0-2
1857.5	26115	15	16QAM	75	0	20.92	2	0-2	
Mid	1882.5	26365	15	QPSK	1	0	23.17	0	0
	1882.5	26365	15	QPSK	1	36	23.03	0	0
	1882.5	26365	15	QPSK	1	74	23.11	0	0
	1882.5	26365	15	QPSK	36	0	21.89	1	0-1
	1882.5	26365	15	QPSK	36	18	21.94	1	0-1
	1882.5	26365	15	QPSK	36	37	21.99	1	0-1
	1882.5	26365	15	QPSK	75	0	21.84	1	0-1
	1882.5	26365	15	16QAM	1	0	22.04	1	0-1
	1882.5	26365	15	16QAM	1	36	22.00	1	0-1
	1882.5	26365	15	16QAM	1	74	22.00	1	0-1
	1882.5	26365	15	16QAM	36	0	21.05	2	0-2
	1882.5	26365	15	16QAM	36	18	21.06	2	0-2
	1882.5	26365	15	16QAM	36	37	21.00	2	0-2
1882.5	26365	15	16QAM	75	0	21.15	2	0-2	
High	1907.5	26615	15	QPSK	1	0	22.88	0	0
	1907.5	26615	15	QPSK	1	36	22.81	0	0
	1907.5	26615	15	QPSK	1	74	22.90	0	0
	1907.5	26615	15	QPSK	36	0	22.01	1	0-1
	1907.5	26615	15	QPSK	36	18	21.83	1	0-1
	1907.5	26615	15	QPSK	36	37	21.79	1	0-1
	1907.5	26615	15	QPSK	75	0	21.80	1	0-1
	1907.5	26615	15	16QAM	1	0	22.05	1	0-1
	1907.5	26615	15	16QAM	1	36	22.04	1	0-1
	1907.5	26615	15	16QAM	1	74	21.87	1	0-1
	1907.5	26615	15	16QAM	36	0	20.99	2	0-2
	1907.5	26615	15	16QAM	36	18	21.03	2	0-2
	1907.5	26615	15	16QAM	36	37	21.06	2	0-2
1907.5	26615	15	16QAM	75	0	21.01	2	0-2	

FCC ID A3LSPHL520	 <b>PCTEST</b> PROFESSIONAL CORPORATION, INC.	<b>SAR EVALUATION REPORT</b>		<b>Reviewed by:</b> Quality Manager
<b>Document S/N:</b> 0Y1407011333.A3L	<b>Test Dates:</b> 07/07/14 - 07/09/14	<b>DUT Type:</b> Portable Handset		Page 20 of 41



**Table 9-3  
LTE Band 25 (PCS) Conducted Powers - 10 MHz Bandwidth**

	Frequency [MHz]	Channel	Bandwidth [MHz]	Modulation	RB Size	RB Offset	Conducted Power [dBm]	Target MPR [dB]	MPR Allowed per 3GPP [dB]
Low	1855	26090	10	QPSK	1	0	23.13	0	0
	1855	26090	10	QPSK	1	25	22.84	0	0
	1855	26090	10	QPSK	1	49	22.62	0	0
	1855	26090	10	QPSK	25	0	21.93	1	0-1
	1855	26090	10	QPSK	25	12	21.74	1	0-1
	1855	26090	10	QPSK	25	25	21.50	1	0-1
	1855	26090	10	QPSK	50	0	21.55	1	0-1
	1855	26090	10	16QAM	1	0	21.92	1	0-1
	1855	26090	10	16QAM	1	25	21.76	1	0-1
	1855	26090	10	16QAM	1	49	21.58	1	0-1
	1855	26090	10	16QAM	25	0	20.91	2	0-2
	1855	26090	10	16QAM	25	12	20.79	2	0-2
1855	26090	10	16QAM	25	25	20.60	2	0-2	
1855	26090	10	16QAM	50	0	20.64	2	0-2	
Mid	1882.5	26365	10	QPSK	1	0	23.02	0	0
	1882.5	26365	10	QPSK	1	25	23.06	0	0
	1882.5	26365	10	QPSK	1	49	22.96	0	0
	1882.5	26365	10	QPSK	25	0	21.91	1	0-1
	1882.5	26365	10	QPSK	25	12	21.82	1	0-1
	1882.5	26365	10	QPSK	25	25	21.88	1	0-1
	1882.5	26365	10	QPSK	50	0	21.73	1	0-1
	1882.5	26365	10	16QAM	1	0	21.98	1	0-1
	1882.5	26365	10	16QAM	1	25	22.07	1	0-1
	1882.5	26365	10	16QAM	1	49	21.95	1	0-1
	1882.5	26365	10	16QAM	25	0	20.86	2	0-2
	1882.5	26365	10	16QAM	25	12	20.82	2	0-2
1882.5	26365	10	16QAM	25	25	20.88	2	0-2	
1882.5	26365	10	16QAM	50	0	20.76	2	0-2	
High	1910	26640	10	QPSK	1	0	22.84	0	0
	1910	26640	10	QPSK	1	25	22.85	0	0
	1910	26640	10	QPSK	1	49	22.77	0	0
	1910	26640	10	QPSK	25	0	21.86	1	0-1
	1910	26640	10	QPSK	25	12	21.92	1	0-1
	1910	26640	10	QPSK	25	25	21.90	1	0-1
	1910	26640	10	QPSK	50	0	21.70	1	0-1
	1910	26640	10	16QAM	1	0	21.84	1	0-1
	1910	26640	10	16QAM	1	25	21.94	1	0-1
	1910	26640	10	16QAM	1	49	21.83	1	0-1
	1910	26640	10	16QAM	25	0	20.94	2	0-2
	1910	26640	10	16QAM	25	12	20.95	2	0-2
1910	26640	10	16QAM	25	25	20.87	2	0-2	
1910	26640	10	16QAM	50	0	20.75	2	0-2	

FCC ID A3LSPHL520	 <b>PCTEST</b> PROFESSIONAL CORPORATION, INC.	<b>SAR EVALUATION REPORT</b>		<b>Reviewed by:</b> Quality Manager
<b>Document S/N:</b> 0Y1407011333.A3L	<b>Test Dates:</b> 07/07/14 - 07/09/14	<b>DUT Type:</b> Portable Handset		Page 21 of 41



**Table 9-4  
LTE Band 25 (PCS) Conducted Powers - 5 MHz Bandwidth**

	Frequency [MHz]	Channel	Bandwidth [MHz]	Modulation	RB Size	RB Offset	Conducted Power [dBm]	Target MPR [dB]	MPR Allowed per 3GPP [dB]
Low	1852.5	26065	5	QPSK	1	0	23.12	0	0
	1852.5	26065	5	QPSK	1	12	23.03	0	0
	1852.5	26065	5	QPSK	1	24	22.92	0	0
	1852.5	26065	5	QPSK	12	0	21.96	1	0-1
	1852.5	26065	5	QPSK	12	6	21.97	1	0-1
	1852.5	26065	5	QPSK	12	13	21.92	1	0-1
	1852.5	26065	5	QPSK	25	0	21.88	1	0-1
	1852.5	26065	5	16-QAM	1	0	22.02	1	0-1
	1852.5	26065	5	16-QAM	1	12	22.03	1	0-1
	1852.5	26065	5	16-QAM	1	24	21.87	1	0-1
	1852.5	26065	5	16-QAM	12	0	21.08	2	0-2
	1852.5	26065	5	16-QAM	12	6	21.10	2	0-2
	1852.5	26065	5	16-QAM	12	13	21.05	2	0-2
1852.5	26065	5	16-QAM	25	0	20.99	2	0-2	
Mid	1882.5	26365	5	QPSK	1	0	23.05	0	0
	1882.5	26365	5	QPSK	1	12	22.94	0	0
	1882.5	26365	5	QPSK	1	24	22.86	0	0
	1882.5	26365	5	QPSK	12	0	21.95	1	0-1
	1882.5	26365	5	QPSK	12	6	21.94	1	0-1
	1882.5	26365	5	QPSK	12	13	21.96	1	0-1
	1882.5	26365	5	QPSK	25	0	21.80	1	0-1
	1882.5	26365	5	16-QAM	1	0	21.89	1	0-1
	1882.5	26365	5	16-QAM	1	12	21.96	1	0-1
	1882.5	26365	5	16-QAM	1	24	21.87	1	0-1
	1882.5	26365	5	16-QAM	12	0	21.00	2	0-2
	1882.5	26365	5	16-QAM	12	6	21.01	2	0-2
	1882.5	26365	5	16-QAM	12	13	21.04	2	0-2
1882.5	26365	5	16-QAM	25	0	20.85	2	0-2	
High	1912.5	26665	5	QPSK	1	0	22.96	0	0
	1912.5	26665	5	QPSK	1	12	22.87	0	0
	1912.5	26665	5	QPSK	1	24	22.75	0	0
	1912.5	26665	5	QPSK	12	0	21.92	1	0-1
	1912.5	26665	5	QPSK	12	6	21.81	1	0-1
	1912.5	26665	5	QPSK	12	13	21.78	1	0-1
	1912.5	26665	5	QPSK	25	0	21.77	1	0-1
	1912.5	26665	5	16-QAM	1	0	21.96	1	0-1
	1912.5	26665	5	16-QAM	1	12	21.83	1	0-1
	1912.5	26665	5	16-QAM	1	24	21.64	1	0-1
	1912.5	26665	5	16-QAM	12	0	20.91	2	0-2
	1912.5	26665	5	16-QAM	12	6	20.95	2	0-2
	1912.5	26665	5	16-QAM	12	13	20.90	2	0-2
1912.5	26665	5	16-QAM	25	0	20.85	2	0-2	

FCC ID A3LSPHL520	 <b>PCTEST</b> PROFESSIONAL CORPORATION, INC.	<b>SAR EVALUATION REPORT</b>		<b>Reviewed by:</b> Quality Manager
<b>Document S/N:</b> 0Y1407011333.A3L	<b>Test Dates:</b> 07/07/14 - 07/09/14	<b>DUT Type:</b> Portable Handset		Page 22 of 41



**Table 9-5  
LTE Band 25 (PCS) Conducted Powers - 3 MHz Bandwidth**

	Frequency [MHz]	Channel	Bandwidth [MHz]	Modulation	RB Size	RB Offset	Conducted Power [dBm]	Target MPR [dB]	MPR Allowed per 3GPP [dB]
Low	1851.5	26055	3	QPSK	1	0	23.14	0	0
	1851.5	26055	3	QPSK	1	7	22.98	0	0
	1851.5	26055	3	QPSK	1	14	22.99	0	0
	1851.5	26055	3	QPSK	8	0	22.11	1	0-1
	1851.5	26055	3	QPSK	8	4	22.01	1	0-1
	1851.5	26055	3	QPSK	8	7	22.07	1	0-1
	1851.5	26055	3	QPSK	15	0	21.95	1	0-1
	1851.5	26055	3	16-QAM	1	0	22.08	1	0-1
	1851.5	26055	3	16-QAM	1	7	22.04	1	0-1
	1851.5	26055	3	16-QAM	1	14	22.06	1	0-1
	1851.5	26055	3	16-QAM	8	0	21.02	2	0-2
	1851.5	26055	3	16-QAM	8	4	21.03	2	0-2
	1851.5	26055	3	16-QAM	8	7	21.09	2	0-2
1851.5	26055	3	16-QAM	15	0	21.06	2	0-2	
Mid	1882.5	26365	3	QPSK	1	0	23.08	0	0
	1882.5	26365	3	QPSK	1	7	23.01	0	0
	1882.5	26365	3	QPSK	1	14	23.02	0	0
	1882.5	26365	3	QPSK	8	0	22.06	1	0-1
	1882.5	26365	3	QPSK	8	4	22.00	1	0-1
	1882.5	26365	3	QPSK	8	7	22.09	1	0-1
	1882.5	26365	3	QPSK	15	0	22.03	1	0-1
	1882.5	26365	3	16-QAM	1	0	22.12	1	0-1
	1882.5	26365	3	16-QAM	1	7	22.02	1	0-1
	1882.5	26365	3	16-QAM	1	14	21.99	1	0-1
	1882.5	26365	3	16-QAM	8	0	21.05	2	0-2
	1882.5	26365	3	16-QAM	8	4	21.03	2	0-2
	1882.5	26365	3	16-QAM	8	7	21.12	2	0-2
1882.5	26365	3	16-QAM	15	0	21.05	2	0-2	
High	1913.5	26675	3	QPSK	1	0	23.04	0	0
	1913.5	26675	3	QPSK	1	7	22.91	0	0
	1913.5	26675	3	QPSK	1	14	22.88	0	0
	1913.5	26675	3	QPSK	8	0	21.93	1	0-1
	1913.5	26675	3	QPSK	8	4	21.91	1	0-1
	1913.5	26675	3	QPSK	8	7	21.86	1	0-1
	1913.5	26675	3	QPSK	15	0	21.86	1	0-1
	1913.5	26675	3	16-QAM	1	0	22.04	1	0-1
	1913.5	26675	3	16-QAM	1	7	21.95	1	0-1
	1913.5	26675	3	16-QAM	1	14	21.80	1	0-1
	1913.5	26675	3	16-QAM	8	0	20.81	2	0-2
	1913.5	26675	3	16-QAM	8	4	20.74	2	0-2
	1913.5	26675	3	16-QAM	8	7	20.84	2	0-2
1913.5	26675	3	16-QAM	15	0	20.82	2	0-2	

FCC ID A3LSPHL520	 <b>SAR EVALUATION REPORT</b> 	Reviewed by: Quality Manager
Document S/N: 0Y1407011333.A3L	Test Dates: 07/07/14 - 07/09/14	DUT Type: Portable Handset
© 2014 PCTEST Engineering Laboratory, Inc.		Page 23 of 41

**Table 9-6  
LTE Band 25 (PCS) Conducted Powers -1.4 MHz Bandwidth**

	Frequency [MHz]	Channel	Bandwidth [MHz]	Modulation	RB Size	RB Offset	Conducted Power [dBm]	Target MPR [dB]	MPR Allowed per 3GPP [dB]
Low	1850.7	26047	1.4	QPSK	1	0	23.17	0	0
	1850.7	26047	1.4	QPSK	1	2	23.20	0	0
	1850.7	26047	1.4	QPSK	1	5	22.95	0	0
	1850.7	26047	1.4	QPSK	3	0	22.96	0	0
	1850.7	26047	1.4	QPSK	3	2	23.02	0	0
	1850.7	26047	1.4	QPSK	3	3	22.94	0	0
	1850.7	26047	1.4	QPSK	6	0	22.15	1	0-1
	1850.7	26047	1.4	16-QAM	1	0	21.83	1	0-1
	1850.7	26047	1.4	16-QAM	1	2	21.99	1	0-1
	1850.7	26047	1.4	16-QAM	1	5	21.94	1	0-1
	1850.7	26047	1.4	16-QAM	3	0	21.89	1	0-1
	1850.7	26047	1.4	16-QAM	3	2	22.10	1	0-1
	1850.7	26047	1.4	16-QAM	3	3	22.06	1	0-1
1850.7	26047	1.4	16-QAM	6	0	21.05	2	0-2	
Mid	1882.5	26365	1.4	QPSK	1	0	22.97	0	0
	1882.5	26365	1.4	QPSK	1	2	23.05	0	0
	1882.5	26365	1.4	QPSK	1	5	23.20	0	0
	1882.5	26365	1.4	QPSK	3	0	22.89	0	0
	1882.5	26365	1.4	QPSK	3	2	22.95	0	0
	1882.5	26365	1.4	QPSK	3	3	23.04	0	0
	1882.5	26365	1.4	QPSK	6	0	22.01	1	0-1
	1882.5	26365	1.4	16-QAM	1	0	22.01	1	0-1
	1882.5	26365	1.4	16-QAM	1	2	22.01	1	0-1
	1882.5	26365	1.4	16-QAM	1	5	22.15	1	0-1
	1882.5	26365	1.4	16-QAM	3	0	22.05	1	0-1
	1882.5	26365	1.4	16-QAM	3	2	21.98	1	0-1
	1882.5	26365	1.4	16-QAM	3	3	21.95	1	0-1
1882.5	26365	1.4	16-QAM	6	0	20.95	2	0-2	
High	1914.3	26683	1.4	QPSK	1	0	23.00	0	0
	1914.3	26683	1.4	QPSK	1	2	22.79	0	0
	1914.3	26683	1.4	QPSK	1	5	22.83	0	0
	1914.3	26683	1.4	QPSK	3	0	22.95	0	0
	1914.3	26683	1.4	QPSK	3	2	23.04	0	0
	1914.3	26683	1.4	QPSK	3	3	23.03	0	0
	1914.3	26683	1.4	QPSK	6	0	22.14	1	0-1
	1914.3	26683	1.4	16-QAM	1	0	21.89	1	0-1
	1914.3	26683	1.4	16-QAM	1	2	21.92	1	0-1
	1914.3	26683	1.4	16-QAM	1	5	21.88	1	0-1
	1914.3	26683	1.4	16-QAM	3	0	22.03	1	0-1
	1914.3	26683	1.4	16-QAM	3	2	22.07	1	0-1
	1914.3	26683	1.4	16-QAM	3	3	22.13	1	0-1
1914.3	26683	1.4	16-QAM	6	0	21.10	2	0-2	

FCC ID A3LSPHL520	 <b>PCTEST</b> PROFESSIONAL CORPORATION, INC.	<b>SAR EVALUATION REPORT</b>		<b>Reviewed by:</b> Quality Manager
<b>Document S/N:</b> 0Y1407011333.A3L	<b>Test Dates:</b> 07/07/14 - 07/09/14	<b>DUT Type:</b> Portable Handset		Page 24 of 41





9.1.2

LTE Band 41



Table 9-7  
LTE Band 41 Conducted Powers - 20 MHz Bandwidth

	Frequency [MHz]	Channel	Bandwidth [MHz]	Modulation	RB Size	RB Offset	Conducted Power [dBm]	Target MPR [dB]	MPR Allowed per 3GPP [dB]
Low	2506	39750	20	QPSK	1	0	23.08	0	0
	2506	39750	20	QPSK	1	50	23.25	0	0
	2506	39750	20	QPSK	1	99	23.13	0	0
	2506	39750	20	QPSK	50	0	22.15	1	0-1
	2506	39750	20	QPSK	50	25	22.04	1	0-1
	2506	39750	20	QPSK	50	50	22.05	1	0-1
	2506	39750	20	QPSK	100	0	22.13	1	0-1
	2506	39750	20	16QAM	1	0	21.99	1	0-1
	2506	39750	20	16QAM	1	50	22.16	1	0-1
	2506	39750	20	16QAM	1	99	22.03	1	0-1
	2506	39750	20	16QAM	50	0	21.38	2	0-2
	2506	39750	20	16QAM	50	25	21.31	2	0-2
	2506	39750	20	16QAM	50	50	21.12	2	0-2
	2506	39750	20	16QAM	100	0	21.21	2	0-2
Low Mid	2549.5	40185	20	QPSK	1	0	23.03	0	0
	2549.5	40185	20	QPSK	1	50	23.13	0	0
	2549.5	40185	20	QPSK	1	99	23.14	0	0
	2549.5	40185	20	QPSK	50	0	21.94	1	0-1
	2549.5	40185	20	QPSK	50	25	21.98	1	0-1
	2549.5	40185	20	QPSK	50	50	21.95	1	0-1
	2549.5	40185	20	QPSK	100	0	21.93	1	0-1
	2549.5	40185	20	16-QAM	1	0	22.02	1	0-1
	2549.5	40185	20	16-QAM	1	50	22.02	1	0-1
	2549.5	40185	20	16-QAM	1	99	22.04	1	0-1
	2549.5	40185	20	16-QAM	50	0	21.19	2	0-2
	2549.5	40185	20	16-QAM	50	25	21.15	2	0-2
	2549.5	40185	20	16-QAM	50	50	21.11	2	0-2
	2549.5	40185	20	16-QAM	100	0	21.13	2	0-2
Mid	2593	40620	20	QPSK	1	0	23.16	0	0
	2593	40620	20	QPSK	1	50	23.08	0	0
	2593	40620	20	QPSK	1	99	23.02	0	0
	2593	40620	20	QPSK	50	0	22.03	1	0-1
	2593	40620	20	QPSK	50	25	22.12	1	0-1
	2593	40620	20	QPSK	50	50	21.98	1	0-1
	2593	40620	20	QPSK	100	0	22.08	1	0-1
	2593	40620	20	16-QAM	1	0	22.10	1	0-1
	2593	40620	20	16-QAM	1	50	22.08	1	0-1
	2593	40620	20	16-QAM	1	99	21.99	1	0-1
	2593	40620	20	16-QAM	50	0	21.20	2	0-2
	2593	40620	20	16-QAM	50	25	21.18	2	0-2
	2593	40620	20	16-QAM	50	50	21.14	2	0-2
	2593	40620	20	16-QAM	100	0	21.18	2	0-2
Mid High	2636.5	41055	20	QPSK	1	0	23.22	0	0
	2636.5	41055	20	QPSK	1	50	23.03	0	0
	2636.5	41055	20	QPSK	1	99	22.84	0	0
	2636.5	41055	20	QPSK	50	0	21.83	1	0-1
	2636.5	41055	20	QPSK	50	25	21.85	1	0-1
	2636.5	41055	20	QPSK	50	50	21.75	1	0-1
	2636.5	41055	20	QPSK	100	0	21.76	1	0-1
	2636.5	41055	20	16-QAM	1	0	22.13	1	0-1
	2636.5	41055	20	16-QAM	1	50	21.85	1	0-1
	2636.5	41055	20	16-QAM	1	99	21.86	1	0-1
	2636.5	41055	20	16-QAM	50	0	21.05	2	0-2
	2636.5	41055	20	16-QAM	50	25	21.03	2	0-2
	2636.5	41055	20	16-QAM	50	50	20.90	2	0-2
	2636.5	41055	20	16-QAM	100	0	20.99	2	0-2
High	2680	41490	20	QPSK	1	0	22.62	0	0
	2680	41490	20	QPSK	1	50	23.42	0	0
	2680	41490	20	QPSK	1	99	22.50	0	0
	2680	41490	20	QPSK	50	0	22.06	1	0-1
	2680	41490	20	QPSK	50	25	22.19	1	0-1
	2680	41490	20	QPSK	50	50	21.86	1	0-1
	2680	41490	20	QPSK	100	0	22.01	1	0-1
	2680	41490	20	16-QAM	1	0	21.52	1	0-1
	2680	41490	20	16-QAM	1	50	22.25	1	0-1
	2680	41490	20	16-QAM	1	99	21.58	1	0-1
	2680	41490	20	16-QAM	50	0	21.35	2	0-2
	2680	41490	20	16-QAM	50	25	21.39	2	0-2
	2680	41490	20	16-QAM	50	50	21.22	2	0-2
	2680	41490	20	16-QAM	100	0	21.20	2	0-2

FCC ID A3LSPHL520	 PCTEST PROFESSIONAL CORPORATION, INC.	SAR EVALUATION REPORT		Reviewed by: Quality Manager
Document S/N: 0Y1407011333.A3L	Test Dates: 07/07/14 - 07/09/14	DUT Type: Portable Handset		Page 25 of 41



**Table 9-8  
LTE Band 41 Conducted Powers - 15 MHz Bandwidth**

	Frequency [MHz]	Channel	Bandwidth [MHz]	Modulation	RB Size	RB Offset	Conducted Power [dBm]	Target MPR [dB]	MPR Allowed per 3GPP [dB]
Low	2503.5	39725	15	QPSK	1	0	23.24	0	0
	2503.5	39725	15	QPSK	1	36	23.49	0	0
	2503.5	39725	15	QPSK	1	74	23.39	0	0
	2503.5	39725	15	QPSK	36	0	22.37	1	0-1
	2503.5	39725	15	QPSK	36	18	22.38	1	0-1
	2503.5	39725	15	QPSK	36	37	22.21	1	0-1
	2503.5	39725	15	QPSK	75	0	22.24	1	0-1
	2503.5	39725	15	16QAM	1	0	22.25	1	0-1
	2503.5	39725	15	16QAM	1	36	22.50	1	0-1
	2503.5	39725	15	16QAM	1	74	22.43	1	0-1
	2503.5	39725	15	16QAM	36	0	21.36	2	0-2
	2503.5	39725	15	16QAM	36	18	21.34	2	0-2
	2503.5	39725	15	16QAM	36	37	21.20	2	0-2
	2503.5	39725	15	16QAM	75	0	21.18	2	0-2
	2548.3	40173	15	QPSK	1	0	23.34	0	0
2548.3	40173	15	QPSK	1	36	23.32	0	0	
2548.3	40173	15	QPSK	1	74	23.27	0	0	
2548.3	40173	15	QPSK	36	0	22.27	1	0-1	
2548.3	40173	15	QPSK	36	18	22.21	1	0-1	
2548.3	40173	15	QPSK	36	37	22.17	1	0-1	
2548.3	40173	15	QPSK	75	0	22.16	1	0-1	
2548.3	40173	15	16-QAM	1	0	22.47	1	0-1	
2548.3	40173	15	16-QAM	1	36	22.45	1	0-1	
2548.3	40173	15	16-QAM	1	74	22.43	1	0-1	
2548.3	40173	15	16-QAM	36	0	21.41	2	0-2	
2548.3	40173	15	16-QAM	36	18	21.28	2	0-2	
2548.3	40173	15	16-QAM	36	37	21.24	2	0-2	
2548.3	40173	15	16-QAM	75	0	21.22	2	0-2	
Mid	2593	40620	15	QPSK	1	0	23.28	0	0
	2593	40620	15	QPSK	1	36	23.24	0	0
	2593	40620	15	QPSK	1	74	23.22	0	0
	2593	40620	15	QPSK	36	0	22.11	1	0-1
	2593	40620	15	QPSK	36	18	22.10	1	0-1
	2593	40620	15	QPSK	36	37	22.01	1	0-1
	2593	40620	15	QPSK	75	0	21.98	1	0-1
	2593	40620	15	16-QAM	1	0	22.39	1	0-1
	2593	40620	15	16-QAM	1	36	22.32	1	0-1
	2593	40620	15	16-QAM	1	74	22.38	1	0-1
	2593	40620	15	16-QAM	36	0	21.26	2	0-2
	2593	40620	15	16-QAM	36	18	21.25	2	0-2
	2593	40620	15	16-QAM	36	37	21.20	2	0-2
	2593	40620	15	16-QAM	75	0	21.05	2	0-2
	2637.8	41068	15	QPSK	1	0	23.23	0	0
2637.8	41068	15	QPSK	1	36	23.20	0	0	
2637.8	41068	15	QPSK	1	74	23.25	0	0	
2637.8	41068	15	QPSK	36	0	22.06	1	0-1	
2637.8	41068	15	QPSK	36	18	21.96	1	0-1	
2637.8	41068	15	QPSK	36	37	22.00	1	0-1	
2637.8	41068	15	QPSK	75	0	21.95	1	0-1	
2637.8	41068	15	16-QAM	1	0	22.43	1	0-1	
2637.8	41068	15	16-QAM	1	36	22.34	1	0-1	
2637.8	41068	15	16-QAM	1	74	22.42	1	0-1	
2637.8	41068	15	16-QAM	36	0	21.15	2	0-2	
2637.8	41068	15	16-QAM	36	18	21.11	2	0-2	
2637.8	41068	15	16-QAM	36	37	21.08	2	0-2	
2637.8	41068	15	16-QAM	75	0	20.87	2	0-2	
High	2682.5	41515	15	QPSK	1	0	23.50	0	0
	2682.5	41515	15	QPSK	1	36	23.48	0	0
	2682.5	41515	15	QPSK	1	74	22.74	0	0
	2682.5	41515	15	QPSK	36	0	22.40	1	0-1
	2682.5	41515	15	QPSK	36	18	22.27	1	0-1
	2682.5	41515	15	QPSK	36	37	22.00	1	0-1
	2682.5	41515	15	QPSK	75	0	22.15	1	0-1
	2682.5	41515	15	16-QAM	1	0	22.49	1	0-1
	2682.5	41515	15	16-QAM	1	36	22.50	1	0-1
	2682.5	41515	15	16-QAM	1	74	21.84	1	0-1
	2682.5	41515	15	16-QAM	36	0	21.49	2	0-2
	2682.5	41515	15	16-QAM	36	18	21.33	2	0-2
	2682.5	41515	15	16-QAM	36	37	21.16	2	0-2
	2682.5	41515	15	16-QAM	75	0	21.15	2	0-2

FCC ID A3LSPHL520	 PCTEST Engineering Laboratory, Inc.	<b>SAR EVALUATION REPORT</b>		Reviewed by: Quality Manager
Document S/N: 0Y1407011333.A3L	Test Dates: 07/07/14 - 07/09/14	DUT Type: Portable Handset		Page 26 of 41



**Table 9-9  
LTE Band 41 Conducted Powers - 10 MHz Bandwidth**

	Frequency [MHz]	Channel	Bandwidth [MHz]	Modulation	RB Size	RB Offset	Conducted Power [dBm]	Target MPR [dB]	MPR Allowed per 3GPP [dB]
Low	2501	39700	10	QPSK	1	0	23.24	0	0
	2501	39700	10	QPSK	1	25	23.48	0	0
	2501	39700	10	QPSK	1	49	23.46	0	0
	2501	39700	10	QPSK	25	0	22.36	1	0-1
	2501	39700	10	QPSK	25	12	22.42	1	0-1
	2501	39700	10	QPSK	25	25	22.48	1	0-1
	2501	39700	10	QPSK	50	0	22.40	1	0-1
	2501	39700	10	16QAM	1	0	22.46	1	0-1
	2501	39700	10	16QAM	1	25	22.50	1	0-1
	2501	39700	10	16QAM	1	49	22.49	1	0-1
	2501	39700	10	16QAM	25	0	21.37	2	0-2
	2501	39700	10	16QAM	25	12	21.47	2	0-2
	2501	39700	10	16QAM	25	25	21.46	2	0-2
	2501	39700	10	16QAM	50	0	21.32	2	0-2
Low Mid	2547	40160	10	QPSK	1	0	23.40	0	0
	2547	40160	10	QPSK	1	25	23.43	0	0
	2547	40160	10	QPSK	1	49	23.38	0	0
	2547	40160	10	QPSK	25	0	22.25	1	0-1
	2547	40160	10	QPSK	25	12	22.32	1	0-1
	2547	40160	10	QPSK	25	25	22.30	1	0-1
	2547	40160	10	QPSK	50	0	22.19	1	0-1
	2547	40160	10	16-QAM	1	0	22.44	1	0-1
	2547	40160	10	16-QAM	1	25	22.48	1	0-1
	2547	40160	10	16-QAM	1	49	22.34	1	0-1
	2547	40160	10	16-QAM	25	0	21.32	2	0-2
	2547	40160	10	16-QAM	25	12	21.36	2	0-2
	2547	40160	10	16-QAM	25	25	21.26	2	0-2
	2547	40160	10	16-QAM	50	0	21.17	2	0-2
Mid	2593	40620	10	QPSK	1	0	23.33	0	0
	2593	40620	10	QPSK	1	25	23.30	0	0
	2593	40620	10	QPSK	1	49	23.26	0	0
	2593	40620	10	QPSK	25	0	22.23	1	0-1
	2593	40620	10	QPSK	25	12	22.14	1	0-1
	2593	40620	10	QPSK	25	25	22.20	1	0-1
	2593	40620	10	QPSK	50	0	22.18	1	0-1
	2593	40620	10	16-QAM	1	0	22.48	1	0-1
	2593	40620	10	16-QAM	1	25	22.43	1	0-1
	2593	40620	10	16-QAM	1	49	22.45	1	0-1
	2593	40620	10	16-QAM	25	0	21.20	2	0-2
	2593	40620	10	16-QAM	25	12	21.17	2	0-2
	2593	40620	10	16-QAM	25	25	21.21	2	0-2
	2593	40620	10	16-QAM	50	0	21.15	2	0-2
Mid High	2639	41080	10	QPSK	1	0	23.26	0	0
	2639	41080	10	QPSK	1	25	23.13	0	0
	2639	41080	10	QPSK	1	49	23.23	0	0
	2639	41080	10	QPSK	25	0	22.09	1	0-1
	2639	41080	10	QPSK	25	12	22.05	1	0-1
	2639	41080	10	QPSK	25	25	22.02	1	0-1
	2639	41080	10	QPSK	50	0	21.98	1	0-1
	2639	41080	10	16-QAM	1	0	22.32	1	0-1
	2639	41080	10	16-QAM	1	25	22.30	1	0-1
	2639	41080	10	16-QAM	1	49	22.34	1	0-1
	2639	41080	10	16-QAM	25	0	21.09	2	0-2
	2639	41080	10	16-QAM	25	12	21.03	2	0-2
	2639	41080	10	16-QAM	25	25	21.08	2	0-2
	2639	41080	10	16-QAM	50	0	20.91	2	0-2
High	2685	41540	10	QPSK	1	0	23.45	0	0
	2685	41540	10	QPSK	1	25	23.41	0	0
	2685	41540	10	QPSK	1	49	22.95	0	0
	2685	41540	10	QPSK	25	0	22.50	1	0-1
	2685	41540	10	QPSK	25	12	22.43	1	0-1
	2685	41540	10	QPSK	25	25	22.20	1	0-1
	2685	41540	10	QPSK	50	0	22.32	1	0-1
	2685	41540	10	16-QAM	1	0	22.43	1	0-1
	2685	41540	10	16-QAM	1	25	22.48	1	0-1
	2685	41540	10	16-QAM	1	49	22.15	1	0-1
	2685	41540	10	16-QAM	25	0	21.49	2	0-2
	2685	41540	10	16-QAM	25	12	21.46	2	0-2
	2685	41540	10	16-QAM	25	25	21.24	2	0-2
	2685	41540	10	16-QAM	50	0	21.31	2	0-2

FCC ID A3LSPHL520	 PCTEST ENGINEERING LABORATORY, INC.	<b>SAR EVALUATION REPORT</b>		<b>Reviewed by:</b> Quality Manager
<b>Document S/N:</b> 0Y1407011333.A3L	<b>Test Dates:</b> 07/07/14 - 07/09/14	<b>DUT Type:</b> Portable Handset	Page 27 of 41	

**Table 9-10**  
**LTE Band 41 Conducted Powers - 5 MHz Bandwidth**

	Frequency [MHz]	Channel	Bandwidth [MHz]	Modulation	RB Size	RB Offset	Conducted Power [dBm]	Target MPR [dB]	MPR Allowed per 3GPP [dB]
Low	2498.5	39675	5	QPSK	1	0	23.06	0	0
	2498.5	39675	5	QPSK	1	12	23.14	0	0
	2498.5	39675	5	QPSK	1	24	23.30	0	0
	2498.5	39675	5	QPSK	12	0	22.19	1	0-1
	2498.5	39675	5	QPSK	12	6	22.19	1	0-1
	2498.5	39675	5	QPSK	12	13	22.34	1	0-1
	2498.5	39675	5	QPSK	25	0	22.23	1	0-1
	2498.5	39675	5	16-QAM	1	0	22.47	1	0-1
	2498.5	39675	5	16-QAM	1	12	22.50	1	0-1
	2498.5	39675	5	16-QAM	1	24	22.47	1	0-1
	2498.5	39675	5	16-QAM	12	0	21.34	2	0-2
	2498.5	39675	5	16-QAM	12	6	21.43	2	0-2
	2498.5	39675	5	16-QAM	12	13	21.45	2	0-2
	2498.5	39675	5	16-QAM	25	0	21.39	2	0-2
Low Mid	2545.75	40148	5	QPSK	1	0	23.19	0	0
	2545.75	40148	5	QPSK	1	12	23.20	0	0
	2545.75	40148	5	QPSK	1	24	23.02	0	0
	2545.75	40148	5	QPSK	12	0	22.28	1	0-1
	2545.75	40148	5	QPSK	12	6	22.21	1	0-1
	2545.75	40148	5	QPSK	12	13	22.22	1	0-1
	2545.75	40148	5	QPSK	25	0	22.12	1	0-1
	2545.75	40148	5	16-QAM	1	0	22.40	1	0-1
	2545.75	40148	5	16-QAM	1	12	22.32	1	0-1
	2545.75	40148	5	16-QAM	1	24	22.25	1	0-1
	2545.75	40148	5	16-QAM	12	0	21.35	2	0-2
	2545.75	40148	5	16-QAM	12	6	21.30	2	0-2
	2545.75	40148	5	16-QAM	12	13	21.31	2	0-2
	2545.75	40148	5	16-QAM	25	0	21.32	2	0-2
Mid	2593	40620	5	QPSK	1	0	23.13	0	0
	2593	40620	5	QPSK	1	12	23.18	0	0
	2593	40620	5	QPSK	1	24	23.18	0	0
	2593	40620	5	QPSK	12	0	22.27	1	0-1
	2593	40620	5	QPSK	12	6	22.27	1	0-1
	2593	40620	5	QPSK	12	13	22.25	1	0-1
	2593	40620	5	QPSK	25	0	22.19	1	0-1
	2593	40620	5	16-QAM	1	0	22.50	1	0-1
	2593	40620	5	16-QAM	1	12	22.49	1	0-1
	2593	40620	5	16-QAM	1	24	22.50	1	0-1
	2593	40620	5	16-QAM	12	0	21.46	2	0-2
	2593	40620	5	16-QAM	12	6	21.44	2	0-2
	2593	40620	5	16-QAM	12	13	21.41	2	0-2
	2593	40620	5	16-QAM	25	0	21.32	2	0-2
Mid High	2640.25	41093	5	QPSK	1	0	22.89	0	0
	2640.25	41093	5	QPSK	1	12	22.88	0	0
	2640.25	41093	5	QPSK	1	24	22.91	0	0
	2640.25	41093	5	QPSK	12	0	22.00	1	0-1
	2640.25	41093	5	QPSK	12	6	22.08	1	0-1
	2640.25	41093	5	QPSK	12	13	22.05	1	0-1
	2640.25	41093	5	QPSK	25	0	22.02	1	0-1
	2640.25	41093	5	16-QAM	1	0	22.03	1	0-1
	2640.25	41093	5	16-QAM	1	12	22.07	1	0-1
	2640.25	41093	5	16-QAM	1	24	22.07	1	0-1
	2640.25	41093	5	16-QAM	12	0	21.11	2	0-2
	2640.25	41093	5	16-QAM	12	6	21.11	2	0-2
	2640.25	41093	5	16-QAM	12	13	21.09	2	0-2
	2640.25	41093	5	16-QAM	25	0	21.05	2	0-2
High	2687.5	41565	5	QPSK	1	0	22.93	0	0
	2687.5	41565	5	QPSK	1	12	22.72	0	0
	2687.5	41565	5	QPSK	1	24	22.50	0	0
	2687.5	41565	5	QPSK	12	0	22.00	1	0-1
	2687.5	41565	5	QPSK	12	6	21.89	1	0-1
	2687.5	41565	5	QPSK	12	13	21.77	1	0-1
	2687.5	41565	5	QPSK	25	0	21.80	1	0-1
	2687.5	41565	5	16-QAM	1	0	22.23	1	0-1
	2687.5	41565	5	16-QAM	1	12	22.06	1	0-1
	2687.5	41565	5	16-QAM	1	24	21.62	1	0-1
	2687.5	41565	5	16-QAM	12	0	21.11	2	0-2
	2687.5	41565	5	16-QAM	12	6	21.05	2	0-2
	2687.5	41565	5	16-QAM	12	13	20.94	2	0-2
	2687.5	41565	5	16-QAM	25	0	20.98	2	0-2

FCC ID A3LSPHL520	 PCTEST PROFESSIONAL CORPORATION, INC.	<b>SAR EVALUATION REPORT</b>		Reviewed by: Quality Manager
Document S/N: 0Y1407011333.A3L	Test Dates: 07/07/14 - 07/09/14	DUT Type: Portable Handset		Page 28 of 41

# 10 SYSTEM VERIFICATION

## 10.1 Tissue Verification

**Table 10-1  
Measured Tissue Properties**

Calibrated for Tests Performed on:	Tissue Type	Tissue Temp During Calibration (C°)	Measured Frequency (MHz)	Measured Conductivity, $\sigma$ (S/m)	Measured Dielectric Constant, $\epsilon$	TARGET Conductivity, $\sigma$ (S/m)	TARGET Dielectric Constant, $\epsilon$	% dev $\sigma$	% dev $\epsilon$
07/09/2014	1900H	21.1	1850	1.384	39.583	1.40	40.00	-1.14%	-1.04%
			1880	1.413	39.474	1.40	40.00	0.93%	-1.32%
			1910	1.445	39.292	1.40	40.00	3.21%	-1.77%
07/07/2014	1900B	21.9	1850	1.482	52.864	1.52	53.30	-2.50%	-0.82%
			1880	1.517	52.721	1.52	53.30	-0.20%	-1.09%
			1910	1.555	52.618	1.52	53.30	2.30%	-1.28%

The above measured tissue parameters were used in the DASY software. The DASY software was used to perform interpolation to determine the dielectric parameters at the SAR test device frequencies (per KDB Publication 865664 and IEEE 1528-2013 6.6.1.2). The tissue parameters listed in the SAR test plots may slightly differ from the table above due to significant digit rounding in the software.

## 10.2 Test System Verification

Prior to SAR assessment, the system is verified to  $\pm 10\%$  of the SAR measurement on the reference dipole at the time of calibration by the calibration facility. Full system validation status and result summary can be found in Appendix E.

**Table 10-2  
System Verification Results**

System Verification TARGET & MEASURED												
SAR System #	Tissue Frequency (MHz)	Tissue Type	Date:	Amb. Temp (C°)	Liquid Temp (C°)	Input Power (W)	Dipole SN	Probe SN	Measured SAR <sub>1g</sub> (W/kg)	1 W Target SAR <sub>1g</sub> (W/kg)	1 W Normalized SAR <sub>1g</sub> (W/kg)	Deviation <sub>1g</sub> (%)
B	1900	HEAD	07/09/2014	22.0	21.6	0.100	5d148	3288	3.870	40.700	38.700	-4.91%
B	1900	BODY	07/07/2014	22.4	22.1	0.100	5d148	3288	3.990	39.300	39.900	1.53%

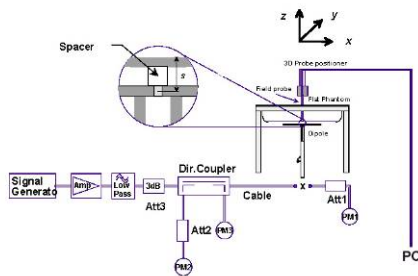

**Figure 10-1  
System Verification Setup Diagram**



**Figure 10-2  
System Verification Setup Photo**

FCC ID A3LSPHL520	PCTEST PROFESSIONAL CORPORATION, INC.	SAR EVALUATION REPORT		Reviewed by: Quality Manager
Document S/N: 0Y1407011333.A3L	Test Dates: 07/07/14 - 07/09/14	DUT Type: Portable Handset		Page 29 of 41

# 11 SAR DATA SUMMARY

## 11.1 Standalone Head SAR Data

**Table 11-1  
LTE Band 25 (PCS) Head SAR**

MEASUREMENT RESULTS																			
FREQUENCY		Mode	Bandwidth [MHz]	Maximum Allowed Power [dBm]	Conducted Power [dBm]	Power Drift [dB]	MPR [dB]	Side	Test Position	Modulation	RB Size	RB Offset	Device Serial Number	Duty Cycle	SAR (1g) (W/kg)	Scaling Factor	Scaled SAR (1g) (W/kg)	Plot #	
MHz	Ch.																		
1882.50	26365	Mid	LTE Band 25 (PCS)	20	23.5	23.25	0.17	0	Right	Cheek	QPSK	1	99	051805af	1:1	0.210	1.059	0.222	
1882.50	26365	Mid	LTE Band 25 (PCS)	20	22.5	22.09	0.15	1	Right	Cheek	QPSK	50	50	051805af	1:1	0.151	1.099	0.166	
1882.50	26365	Mid	LTE Band 25 (PCS)	20	23.5	23.25	0.01	0	Right	Tilt	QPSK	1	99	051805af	1:1	0.142	1.059	0.150	
1882.50	26365	Mid	LTE Band 25 (PCS)	20	22.5	22.09	-0.08	1	Right	Tilt	QPSK	50	50	051805af	1:1	0.111	1.099	0.122	
1882.50	26365	Mid	LTE Band 25 (PCS)	20	23.5	23.25	-0.08	0	Left	Cheek	QPSK	1	99	051805af	1:1	0.414	1.059	0.438	A1
1882.50	26365	Mid	LTE Band 25 (PCS)	20	22.5	22.09	-0.02	1	Left	Cheek	QPSK	50	50	051805af	1:1	0.343	1.099	0.377	
1882.50	26365	Mid	LTE Band 25 (PCS)	20	23.5	23.25	0.02	0	Left	Tilt	QPSK	1	99	051805af	1:1	0.124	1.059	0.131	
1882.50	26365	Mid	LTE Band 25 (PCS)	20	22.5	22.09	0.13	1	Left	Tilt	QPSK	50	50	051805af	1:1	0.103	1.099	0.113	
ANSI / IEEE C95.1 1992 - SAFETY LIMIT Spatial Peak Uncontrolled Exposure/General Population										Head 1.6 W/kg (mW/g) averaged over 1 gram									

## 11.2 Standalone Body-Worn SAR Data



**Table 11-2  
LTE Band 25 (PCS) Body-Worn SAR**

MEASUREMENT RESULTS																			
FREQUENCY		Mode	Bandwidth [MHz]	Maximum Allowed Power [dBm]	Conducted Power [dBm]	Power Drift [dB]	MPR [dB]	Device Serial Number	Modulation	RB Size	RB Offset	Spacing	Side	Duty Cycle	SAR (1g) (W/kg)	Scaling Factor	Scaled SAR (1g) (W/kg)	Plot #	
MHz	Ch.																		
1882.50	26365	Mid	LTE Band 25 (PCS)	20	23.5	23.25	-0.01	0	051805af	QPSK	1	99	10 mm	back	1:1	0.444	1.059	0.470	A2
1882.50	26365	Mid	LTE Band 25 (PCS)	20	22.5	22.09	0.04	1	051805af	QPSK	50	50	10 mm	back	1:1	0.365	1.099	0.401	
ANSI / IEEE C95.1 1992 - SAFETY LIMIT Spatial Peak Uncontrolled Exposure/General Population										Body 1.6 W/kg (mW/g) averaged over 1 gram									

## 11.3 Standalone Wireless Router SAR Data

**Table 11-3  
LTE Band 25 (PCS) Hotspot SAR**

MEASUREMENT RESULTS																			
FREQUENCY		Mode	Bandwidth [MHz]	Maximum Allowed Power [dBm]	Conducted Power [dBm]	Power Drift [dB]	MPR [dB]	Device Serial Number	Modulation	RB Size	RB Offset	Spacing	Side	Duty Cycle	SAR (1g) (W/kg)	Scaling Factor	Scaled SAR (1g) (W/kg)	Plot #	
MHz	Ch.																		
1882.50	26365	Mid	LTE Band 25 (PCS)	20	23.5	23.25	-0.01	0	051805af	QPSK	1	99	10 mm	back	1:1	0.444	1.059	0.470	A2
1882.50	26365	Mid	LTE Band 25 (PCS)	20	22.5	22.09	0.04	1	051805af	QPSK	50	50	10 mm	back	1:1	0.365	1.099	0.401	
1882.50	26365	Mid	LTE Band 25 (PCS)	20	23.5	23.25	-0.19	0	051805af	QPSK	1	99	10 mm	front	1:1	0.341	1.059	0.361	
1882.50	26365	Mid	LTE Band 25 (PCS)	20	22.5	22.09	0.02	1	051805af	QPSK	50	50	10 mm	front	1:1	0.291	1.099	0.320	
1882.50	26365	Mid	LTE Band 25 (PCS)	20	23.5	23.25	0.01	0	051805af	QPSK	1	99	10 mm	bottom	1:1	0.338	1.059	0.358	
1882.50	26365	Mid	LTE Band 25 (PCS)	20	22.5	22.09	0.09	1	051805af	QPSK	50	50	10 mm	bottom	1:1	0.296	1.099	0.325	
1882.50	26365	Mid	LTE Band 25 (PCS)	20	23.5	23.25	-0.12	0	051805af	QPSK	1	99	10 mm	left	1:1	0.230	1.059	0.244	
1882.50	26365	Mid	LTE Band 25 (PCS)	20	22.5	22.09	0.01	1	051805af	QPSK	50	50	10 mm	left	1:1	0.187	1.099	0.206	
ANSI / IEEE C95.1 1992 - SAFETY LIMIT Spatial Peak Uncontrolled Exposure/General Population										Body 1.6 W/kg (mW/g) averaged over 1 gram									

FCC ID A3LSPHL520		SAR EVALUATION REPORT		Reviewed by: Quality Manager
Document S/N: 0Y1407011333.A3L	Test Dates: 07/07/14 - 07/09/14	DUT Type: Portable Handset		Page 30 of 41



## 11.4 SAR Test Notes

### General Notes:

1. The test data reported are the worst-case SAR values according to test procedures specified in IEEE 1528-2003, and FCC KDB Publication 447498 D01v05.
2. Batteries are fully charged at the beginning of the SAR measurements. A specialized battery with NFC operations was used for all SAR measurements.
3. Liquid tissue depth was at least 15.0 cm for all frequencies.
4. The manufacturer has confirmed that the device(s) tested have the same physical, mechanical and thermal characteristics and are within operational tolerances expected for production units.
5. SAR results were scaled to the maximum allowed power to demonstrate compliance per FCC KDB Publication 447498 D01v05.
6. Device was tested using a fixed spacing for body-worn accessory testing. A separation distance of 10 mm was considered because the manufacturer has determined that there will be body-worn accessories available in the marketplace for users to support this separation distance.
7. Per FCC KDB Publication 648474 D04v01, SAR was evaluated without a headset connected to the device. Since the standalone reported SAR was  $\leq 1.2$  W/kg, no additional SAR evaluations using a headset cable were required.
8. Per FCC KDB 865664 D01 v01, variability SAR tests were not performed since the measured SAR results for a frequency band were less than 0.8 W/kg. Please see Section 13 for variability analysis.
9. During SAR Testing for the Wireless Router conditions per FCC KDB Publication 941225 D06v01, the actual Portable Hotspot operation (with actual simultaneous transmission of a transmitter with WIFI) was not activated (See Section 6.7 for more details).

### LTE Notes:

1. LTE Considerations: LTE test configurations are determined according to SAR Evaluation Considerations for LTE Devices in FCC KDB Publication 941225 D05v02r01. The general test procedures used for testing can be found in Section 8.3.5.
2. MPR is permanently implemented for this device by the manufacturer. The specific manufacturer target MPR is indicated alongside the SAR results. MPR is enabled for this device, according to 3GPP TS36.101 Section 6.2.3 – 6.2.5 under Table 6.2.3-1.
3. A-MPR was disabled for all SAR tests by setting NS=01 on the base station simulator. SAR tests were performed with the same number of RB and RB offsets transmitting on all TTI frames (maximum TTI).

FCC ID A3LSPHL520		SAR EVALUATION REPORT		Reviewed by: Quality Manager
Document S/N: 0Y1407011333.A3L	Test Dates: 07/07/14 - 07/09/14	DUT Type: Portable Handset	Page 31 of 41	

# 12 FCC MULTI-TX AND ANTENNA SAR CONSIDERATIONS

## 12.1 Introduction

The following procedures adopted from FCC KDB Publication 447498 D01v05 are applicable to handsets with built-in unlicensed transmitters such as 802.11a/b/g/n and Bluetooth devices which may simultaneously transmit with the licensed transmitter.

## 12.2 Simultaneous Transmission Procedures

This device contains transmitters that may operate simultaneously. Therefore simultaneous transmission analysis is required. Per FCC KDB 447498 D01v05 IV.C.1.iii and IEEE 1528-2013 Section 6.3.4.1.2, simultaneous transmission SAR test exclusion may be applied when the sum of the 1-g SAR for all the simultaneous transmitting antennas in a specific physical test configuration is  $\leq 1.6$  W/kg. When standalone SAR is not required to be measured, per FCC KDB 447498 D01v05 4.3.2 2), the following equation must be used to estimate the standalone 1g SAR for simultaneous transmission assessment involving that transmitter.



$$\text{Estimated SAR} = \frac{\sqrt{f(\text{GHz})}}{7.5} * \frac{(\text{Max Power of channel, mW})}{\text{Min. Separation Distance, mm}}$$

**Table 12-1  
Estimated SAR**

Mode	Frequency	Maximum Allowed Power	Separation Distance (Body)	Estimated SAR (Body)
	[MHz]	[dBm]	[mm]	[W/kg]
Bluetooth	2441	10.00	10	<b>0.208</b>

Note:

1. Held-to ear configurations are not applicable to Bluetooth operations and therefore were not considered for simultaneous transmission. Per KDB Publication 447498 D01v05, the maximum power of the channel was rounded to the nearest mW before calculation.
2. Please see RF Exposure Technical Reports S/N: 0Y1306281121-R2.A3L for simultaneous SAR assessments for the other combinations not referred to in these tables. This report only contains the combinations applicable to the permissive change.

FCC ID A3LSPHL520	 <b>PCTEST</b> PROFESSIONAL COMMUNICATIONS TECHNOLOGY, INC.	<b>SAR EVALUATION REPORT</b>		<b>Reviewed by:</b> Quality Manager
<b>Document S/N:</b> 0Y1407011333.A3L	<b>Test Dates:</b> 07/07/14 - 07/09/14	<b>DUT Type:</b> Portable Handset		Page 32 of 41



## 12.3 Head SAR Simultaneous Transmission Analysis

**Table 12-2**  
Simultaneous Transmission Scenario with 2.4 GHz WLAN (Held to Ear)

Simult Tx	Configuration	LTE Band 25 (PCS) SAR (W/kg)	2.4 GHz WLAN SAR (W/kg)	$\Sigma$ SAR (W/kg)
Head SAR	Right Cheek	0.222	0.033	0.255
	Right Tilt	0.150	0.031	0.181
	Left Cheek	0.438	0.092	<b>0.530</b>
	Left Tilt	0.131	0.033	0.164

**Table 12-3**  
Simultaneous Transmission Scenario with 5 GHz WLAN (Held to Ear)

Simult Tx	Configuration	LTE Band 25 (PCS) SAR (W/kg)	5 GHz WLAN SAR (W/kg)	$\Sigma$ SAR (W/kg)
Head SAR	Right Cheek	0.222	0.034	0.256
	Right Tilt	0.150	0.044	0.194
	Left Cheek	0.438	0.116	<b>0.554</b>
	Left Tilt	0.131	0.031	0.162

The worst case 5 GHz WLAN reported SAR for Head configuration was used for SAR summation, regardless of whether the WLAN channel has WIFI Hotspot capability. Therefore, the summations above represent the absolute worst cases for simultaneous transmission with 5 GHz WLAN

## 12.4 Body-Worn Simultaneous Transmission Analysis



**Table 12-4**  
Simultaneous Transmission Scenario with 2.4 GHz WLAN (Body-Worn at 1.0 cm)

Configuration	Mode	4G SAR (W/kg)	2.4 GHz WLAN SAR (W/kg)	$\Sigma$ SAR (W/kg)
Back Side	LTE Band 25 (PCS)	0.470	0.066	0.536

**Table 12-5**  
Simultaneous Transmission Scenario with 5 GHz WLAN (Body-Worn at 1.0 cm)

Configuration	Mode	4G SAR (W/kg)	5 GHz WLAN SAR (W/kg)	$\Sigma$ SAR (W/kg)
Back Side	LTE Band 25 (PCS)	0.470	0.275	<b>0.745</b>



The worst case 5 GHz WLAN reported SAR for Body worn configuration was used for SAR summation, regardless of whether the WLAN channel has WIFI Hotspot capability. Therefore, the summations above represent the absolute worst cases for simultaneous transmission with 5 GHz WLAN

FCC ID A3LSPHL520	 PCTEST Engineering Laboratory, Inc.	SAR EVALUATION REPORT			Reviewed by: Quality Manager
Document S/N: 0Y1407011333.A3L	Test Dates: 07/07/14 - 07/09/14	DUT Type: Portable Handset		Page 33 of 41	

**Table 12-6**  
**Simultaneous Transmission Scenario with Bluetooth (Body-Worn at 1.0 cm)**

Configuration	Mode	4G SAR (W/kg)	Bluetooth SAR (W/kg)	$\Sigma$ SAR (W/kg)
Back Side	LTE Band 25 (PCS)	0.470	0.208	0.678

Note: Bluetooth SAR was not required to be measured per FCC KDB 447498. Estimated SAR results were used in the above table to determine simultaneous transmission SAR test exclusion.

<b>FCC ID</b> A3LSPHL520	 <b>PCTEST</b> PROFESSIONAL CORPORATION, INC.	<b>SAR EVALUATION REPORT</b>		<b>Reviewed by:</b> Quality Manager
<b>Document S/N:</b> 0Y1407011333.A3L	<b>Test Dates:</b> 07/07/14 - 07/09/14	<b>DUT Type:</b> Portable Handset		Page 34 of 41

## 12.5 Hotspot SAR Simultaneous Transmission Analysis

Per FCC KDB Publication 941225 D06v01, the devices edges with antennas more than 2.5 cm from edge are not required to be evaluated for SAR (“-”).

**Table 12-7**  
**Simultaneous Transmission Scenario with 2.4 GHz (Hotspot at 1.0 cm)**



Simult Tx	Configuration	LTE Band 25 (PCS) SAR (W/kg)	2.4 GHz WLAN SAR (W/kg)	$\Sigma$ SAR (W/kg)
Body SAR	Back	0.470	0.066	<b>0.536</b>
	Front	0.361	0.019	0.380
	Top	-	0.022	0.022
	Bottom	0.358	-	0.358
	Right	-	0.063	0.063
	Left	0.244	-	0.244

**Table 12-8**  
**Simultaneous Transmission Scenario with 5 GHz (Hotspot at 1.0 cm)**

Simult Tx	Configuration	LTE Band 25 (PCS) SAR (W/kg)	5 GHz WLAN SAR (W/kg)	$\Sigma$ SAR (W/kg)
Body SAR	Back	0.470	0.075	<b>0.545</b>
	Front	0.361	0.004	0.365
	Top	-	0.012	0.012
	Bottom	0.358	-	0.358
	Right	-	0.082	0.082
	Left	0.244	-	0.244

## 12.6 Simultaneous Transmission Conclusion

The above numerical summed SAR results for all the worst-case simultaneous transmission conditions were below the SAR limit. Therefore, the above analysis is sufficient to determine that simultaneous transmission cases will not exceed the SAR limit and therefore no measured volumetric simultaneous SAR summation is required per FCC KDB Publication 447498 D01v05 and IEEE 1528-2013 Section 6.3.4.1.2.

FCC ID A3LSPHL520	 <b>PCTEST</b> PROFESSIONAL CORPORATION, INC.	<b>SAR EVALUATION REPORT</b>		<b>Reviewed by:</b> Quality Manager
<b>Document S/N:</b> 0Y1407011333.A3L	<b>Test Dates:</b> 07/07/14 - 07/09/14	<b>DUT Type:</b> Portable Handset	Page 35 of 41	



## 13 SAR MEASUREMENT VARIABILITY

### 13.1 Measurement Variability

Per FCC KDB Publication 865664 D01v01, all measured SAR values were  $<0.8$  W/kg. Therefore, no SAR measurement variability analysis was required.

### 13.2 Measurement Uncertainty



The measured SAR was  $<1.5$  W/kg for all frequency bands. Therefore, per KDB Publication 865664 D01v01, the extended measurement uncertainty analysis per IEEE 1528-2003 was not required.

FCC ID A3LSPHL520	 <b>PCTEST</b> PROFESSIONAL CORPORATION, INC.	SAR EVALUATION REPORT		Reviewed by: Quality Manager
Document S/N: 0Y1407011333.A3L	Test Dates: 07/07/14 - 07/09/14	DUT Type: Portable Handset		Page 36 of 41

# 14 EQUIPMENT LIST

Manufacturer	Model	Description	Cal Date	Cal Interval	Cal Due	Serial Number
Agilent	8753E	(30kHz-6GHz) Network Analyzer	7/23/2013	Annual	7/23/2014	US37390350
Agilent	8753ES	S-Parameter Network Analyzer	5/22/2014	Annual	5/22/2015	US39170118
Agilent	8753ES	S-Parameter Network Analyzer	10/29/2013	Annual	10/29/2014	US39170122
Agilent	E4438C	ESG Vector Signal Generator	4/25/2014	Annual	4/25/2015	MY42082385
Agilent	E4438C	ESG Vector Signal Generator	3/31/2014	Annual	3/31/2015	MY42082659
Agilent	E8257D	(250kHz-20GHz) Signal Generator	4/15/2014	Annual	4/15/2015	MY45470194
Agilent	N5182A	MXG Vector Signal Generator	4/15/2014	Annual	4/15/2015	MY47420651
Agilent	N5182A	MXG Vector Signal Generator	4/15/2014	Annual	4/15/2015	MY47420800
Agilent	N9020A	MXA Signal Analyzer	10/29/2013	Annual	10/29/2014	US46470561
Amplifier Research	15S1G6	Amplifier	CBT	N/A	CBT	433971
Amplifier Research	15S1G6	Amplifier	CBT	N/A	CBT	433972
Anritsu	MA24106A	USB Power Sensor	1/3/2014	Annual	1/3/2015	1344557
Anritsu	MA24106A	USB Power Sensor	1/3/2014	Annual	1/3/2015	1349509
Anritsu	MA24106A	USB Power Sensor	1/3/2014	Annual	1/3/2015	1349514
Anritsu	MA2411B	Pulse Power Sensor	11/14/2013	Annual	11/14/2014	1126066
Anritsu	MA2411B	Pulse Power Sensor	3/25/2014	Annual	3/25/2015	1207470
Anritsu	MA2411B	Pulse Power Sensor	2/3/2014	Annual	2/3/2015	1339018
Anritsu	MA2481A	Power Sensor	10/30/2013	Annual	10/30/2014	5605
Anritsu	ML2469A	Power Meter	3/14/2014	Annual	3/14/2015	1306009
Anritsu	ML2495A	Power Meter	10/31/2013	Annual	10/31/2014	1039008
Control Company	4052	Long Stem Thermometer	9/27/2013	Biennial	9/27/2015	130567447
Control Company	36934-158	Wall-Mounted Thermometer	4/29/2014	Biennial	4/29/2016	122014488
Control Company	61220-416	Long-Stem Thermometer	4/29/2014	Biennial	4/29/2016	111331323
Fisher Scientific	15-077-960	Digital Thermometer	11/6/2012	Biennial	11/6/2014	122640025
Fisher Scientific	15-078J	Long Stem Thermometer	10/30/2012	Biennial	10/30/2014	122626059
Fisher Scientific	S97611	Thermometer	4/12/2013	Biennial	4/12/2015	130219304
Gigatronics	80701A	(0.05-18GHz) Power Sensor	10/30/2013	Annual	10/30/2014	1833460
Gigatronics	8651A	Universal Power Meter	10/30/2013	Annual	10/30/2014	8650319
MCL	BW-N6W5+	6dB Attenuator	CBT	N/A	CBT	1139
MiniCircuits	SLP-2400+	Low Pass Filter	CBT	N/A	CBT	R8979500903
Mini-Circuits	BW-N20W5	Power Attenuator	CBT	N/A	CBT	1226
Mini-Circuits	BW-N20W5+	DC to 18 GHz Precision Fixed 20 dB Attenuator	CBT	N/A	CBT	N/A
Mini-Circuits	NLP-2950+	Low Pass Filter DC to 2700 MHz	CBT	N/A	CBT	N/A
Mitutoyo	CD-6"CSX	Digital Caliper	5/8/2014	Biennial	5/8/2016	13264162
Narda	4014C-6	4 - 8 GHz SMA 6 dB Directional Coupler	CBT	N/A	CBT	N/A
Narda	4772-3	Attenuator (3dB)	CBT	N/A	CBT	9406
Narda	BW-S3W2	Attenuator (3dB)	CBT	N/A	CBT	120
Pasternack	PE2208-6	Bidirectional Coupler	CBT	N/A	CBT	N/A
Pasternack	PE2209-10	Bidirectional Coupler	CBT	N/A	CBT	N/A
Rohde & Schwarz	CMW500	Radio Communication Tester	2/20/2014	Annual	2/20/2015	128633
Seekonk	NC-100	Torque Wrench	3/18/2014	Biennial	3/18/2016	22313
SPEAG	D1900V2	1900 MHz SAR Dipole	2/27/2014	Annual	2/27/2015	5d148
SPEAG	DAE4	Dasy Data Acquisition Electronics	9/17/2013	Annual	9/17/2014	1323
SPEAG	DAK-3.5	Dielectric Assessment Kit	5/6/2014	Annual	5/6/2015	1070
SPEAG	DAK-3.5	Dielectric Assessment Kit	11/13/2013	Annual	11/13/2014	1091
SPEAG	DAKS-3.5	Portable Dielectric Assessment Kit	8/18/2013	Annual	8/18/2014	1008
SPEAG	DAKS-3.5	Portable Dielectric Assessment Kit	8/18/2013	Annual	8/18/2014	1009
SPEAG	ES3DV3	SAR Probe	9/23/2013	Annual	9/23/2014	3288
Tektronix	RSA6114A	Real Time Spectrum Analyzer	4/16/2014	Annual	4/16/2015	B010177
VWR	23226-658	Long Stem Thermometer	7/11/2012	Biennial	7/11/2014	122389330
VWR	36934-158	Wall-Mounted Thermometer	4/29/2014	Biennial	4/29/2016	111859323

Note: CBT (Calibrated Before Testing). Prior to testing, the measurement paths containing a cable, amplifier, attenuator, coupler or filter were connected to a calibrated source (i.e. a signal generator) to determine the losses of the measurement path. The power meter offset was then adjusted to compensate for the measurement system losses. This level offset is stored within the power meter before measurements are made. This calibration verification procedure applies to the system verification and output power measurements. The calibrated reading is then taken directly from the power meter after compensation of the losses for all final power measurements.



FCC ID A3LSPHL520		<b>SAR EVALUATION REPORT</b>		<b>Reviewed by:</b> Quality Manager
<b>Document S/N:</b> 0Y1407011333.A3L	<b>Test Dates:</b> 07/07/14 - 07/09/14	<b>DUT Type:</b> Portable Handset	Page 37 of 41	

# 15 MEASUREMENT UNCERTAINTIES

Applicable for frequencies less than 3000 MHz.

a	b	c	d	e= f(d,k)	f	g	h = c x f/e	i = c x g/e	k
Uncertainty Component	IEEE 1528 Sec.	Tol. (± %)	Prob. Dist.	Div.	c <sub>i</sub> 1gm	c <sub>i</sub> 10gms	1gm u <sub>i</sub> (± %)	10gms u <sub>i</sub> (± %)	v <sub>i</sub>
<b>Measurement System</b>									
Probe Calibration	E.2.1	6.0	N	1	1.0	1.0	6.0	6.0	∞
Axial Isotropy	E.2.2	0.25	N	1	0.7	0.7	0.2	0.2	∞
Hemishperical Isotropy	E.2.2	1.3	N	1	1.0	1.0	1.3	1.3	∞
Boundary Effect	E.2.3	0.4	N	1	1.0	1.0	0.4	0.4	∞
Linearity	E.2.4	0.3	N	1	1.0	1.0	0.3	0.3	∞
System Detection Limits	E.2.5	5.1	N	1	1.0	1.0	5.1	5.1	∞
Readout Electronics	E.2.6	1.0	N	1	1.0	1.0	1.0	1.0	∞
Response Time	E.2.7	0.8	R	1.73	1.0	1.0	0.5	0.5	∞
Integration Time	E.2.8	2.6	R	1.73	1.0	1.0	1.5	1.5	∞
RF Ambient Conditions	E.6.1	3.0	R	1.73	1.0	1.0	1.7	1.7	∞
Probe Positioner Mechanical Tolerance	E.6.2	0.4	R	1.73	1.0	1.0	0.2	0.2	∞
Probe Positioning w/ respect to Phantom	E.6.3	2.9	R	1.73	1.0	1.0	1.7	1.7	∞
Extrapolation, Interpolation & Integration algorithms for Max. SAR Evaluation	E.5	1.0	R	1.73	1.0	1.0	0.6	0.6	∞
<b>Test Sample Related</b>									
Test Sample Positioning	E.4.2	6.0	N	1	1.0	1.0	6.0	6.0	287
Device Holder Uncertainty	E.4.1	3.32	R	1.73	1.0	1.0	1.9	1.9	∞
Output Power Variation - SAR drift measurement	6.6.2	5.0	R	1.73	1.0	1.0	2.9	2.9	∞
<b>Phantom &amp; Tissue Parameters</b>									
Phantom Uncertainty (Shape & Thickness tolerances)	E.3.1	4.0	R	1.73	1.0	1.0	2.3	2.3	∞
Liquid Conductivity - deviation from target values	E.3.2	5.0	R	1.73	0.64	0.43	1.8	1.2	∞
Liquid Conductivity - measurement uncertainty	E.3.3	3.8	N	1	0.64	0.43	2.4	1.6	6
Liquid Permittivity - deviation from target values	E.3.2	5.0	R	1.73	0.60	0.49	1.7	1.4	∞
Liquid Permittivity - measurement uncertainty	E.3.3	4.5	N	1	0.60	0.49	2.7	2.2	6
<b>Combined Standard Uncertainty (k=1)</b>				RSS			12.1	11.7	299
<b>Expanded Uncertainty</b> (95% CONFIDENCE LEVEL)				k=2			24.2	23.5	

The above measurement uncertainties are according to IEEE Std. 1528-2003



FCC ID A3LSPHL520	 <b>PCTEST</b> Engineering Laboratory, Inc.	<b>SAR EVALUATION REPORT</b>		<b>Reviewed by:</b> Quality Manager
<b>Document S/N:</b> 0Y1407011333.A3L	<b>Test Dates:</b> 07/07/14 - 07/09/14	<b>DUT Type:</b> Portable Handset		Page 38 of 41

## 16 CONCLUSION

### 16.1 Measurement Conclusion



The SAR evaluation indicates that the EUT complies with the RF radiation exposure limits of the FCC and Industry Canada, with respect to all parameters subject to this test. These measurements were taken to simulate the RF effects of RF exposure under worst-case conditions. Precise laboratory measures were taken to assure repeatability of the tests. The results and statements relate only to the item(s) tested.

Please note that the absorption and distribution of electromagnetic energy in the body are very complex phenomena that depend on the mass, shape, and size of the body, the orientation of the body with respect to the field vectors, and the electrical properties of both the body and the environment. Other variables that may play a substantial role in possible biological effects are those that characterize the environment (e.g. ambient temperature, air velocity, relative humidity, and body insulation) and those that characterize the individual (e.g. age, gender, activity level, debilitation, or disease). Because various factors may interact with one another to vary the specific biological outcome of an exposure to electromagnetic fields, any protection guide should consider maximal amplification of biological effects as a result of field-body interactions, environmental conditions, and physiological variables. [3]

FCC ID A3LSPHL520	 PCTEST PROFESSIONAL CORPORATION, INC.	SAR EVALUATION REPORT		Reviewed by: Quality Manager
Document S/N: 0Y1407011333.A3L	Test Dates: 07/07/14 - 07/09/14	DUT Type: Portable Handset		Page 39 of 41



## 17 REFERENCES

- [1] Federal Communications Commission, ET Docket 93-62, Guidelines for Evaluating the Environmental Effects of Radiofrequency Radiation, Aug. 1996.
- [2] ANSI/IEEE C95.1-2005, American National Standard safety levels with respect to human exposure to radio frequency electromagnetic fields, 3kHz to 300GHz, New York: IEEE, 2006.
- [3] ANSI/IEEE C95.1-1992, American National Standard safety levels with respect to human exposure to radio frequency electromagnetic fields, 3kHz to 300GHz, New York: IEEE, Sept. 1992.
- [4] ANSI/IEEE C95.3-2002, IEEE Recommended Practice for the Measurement of Potentially Hazardous Electromagnetic Fields - RF and Microwave, New York: IEEE, December 2002.
- [5] IEEE Standards Coordinating Committee 39 –Standards Coordinating Committee 34 – IEEE Std. 1528-2003, Recommended Practice for Determining the Peak Spatial-Average Specific Absorption Rate (SAR) in the Human Body Due to Wireless Communications Devices.
- [6] NCRP, National Council on Radiation Protection and Measurements, Biological Effects and Exposure Criteria for RadioFrequency Electromagnetic Fields, NCRP Report No. 86, 1986. Reprinted Feb. 1995.
- [7] T. Schmid, O. Egger, N. Kuster, Automated E-field scanning system for dosimetric assessments, IEEE Transaction on Microwave Theory and Techniques, vol. 44, Jan. 1996, pp. 105-113.
- [8] K. Pokovic, T. Schmid, N. Kuster, Robust setup for precise calibration of E-field probes in tissue simulating liquids at mobile communications frequencies, ICECOM97, Oct. 1997, pp. -124.
- [9] K. Pokovic, T. Schmid, and N. Kuster, E-field Probe with improved isotropy in brain simulating liquids, Proceedings of the ELMAR, Zadar, Croatia, June 23-25, 1996, pp. 172-175.
- [10] Schmid & Partner Engineering AG, Application Note: Data Storage and Evaluation, June 1998, p2.
- [11] V. Hombach, K. Meier, M. Burkhardt, E. Kuhn, N. Kuster, The Dependence of EM Energy Absorption upon Human Modeling at 900 MHz, IEEE Transaction on Microwave Theory and Techniques, vol. 44 no. 10, Oct. 1996, pp. 1865-1873.
- [12] N. Kuster and Q. Balzano, Energy absorption mechanism by biological bodies in the near field of dipole antennas above 300MHz, IEEE Transaction on Vehicular Technology, vol. 41, no. 1, Feb. 1992, pp. 17-23.
- [13] G. Hartsgrove, A. Kraszewski, A. Surowiec, Simulated Biological Materials for Electromagnetic Radiation Absorption Studies, University of Ottawa, Bioelectromagnetics, Canada: 1987, pp. 29-36.
- [14] Q. Balzano, O. Garay, T. Manning Jr., Electromagnetic Energy Exposure of Simulated Users of Portable Cellular Telephones, IEEE Transactions on Vehicular Technology, vol. 44, no.3, Aug. 1995.
- [15] W. Gander, Computermathematick, Birkhaeuser, Basel, 1992.
- [16] W.H. Press, S.A. Teukolsky, W.T. Vetterling, and B.P. Flannery, Numerical Recipes in C, The Art of Scientific Computing, Second edition, Cambridge University Press, 1992.
- [17] N. Kuster, R. Kastle, T. Schmid, Dosimetric evaluation of mobile communications equipment with known precision, IEEE Transaction on Communications, vol. E80-B, no. 5, May 1997, pp. 645-652.

<b>FCC ID</b> A3LSPHL520	 <b>PCTEST</b> PROFESSIONAL COMMUNICATIONS TEST EQUIPMENT, INC.	<b>SAR EVALUATION REPORT</b>		<b>Reviewed by:</b> Quality Manager
<b>Document S/N:</b> 0Y1407011333.A3L	<b>Test Dates:</b> 07/07/14 - 07/09/14	<b>DUT Type:</b> Portable Handset		Page 40 of 41



- [18] CENELEC CLC/SC111B, European Prestandard (prENV 50166-2), Human Exposure to Electromagnetic Fields High-frequency: 10kHz-300GHz, Jan. 1995.
- [19] Prof. Dr. Niels Kuster, ETH, Eidgenössische Technische Hochschule Zürich, Dosimetric Evaluation of the Cellular Phone.
- [20] IEC 62209-1, Human exposure to radio frequency fields from hand-held and body-mounted wireless communication devices - Human models, instrumentation, and procedures - Part 1: Procedure to determine the specific absorption rate (SAR) for hand-held devices used in close proximity to the ear (frequency range of 300 MHz to 3 GHz), Feb. 2005.
- [21] Industry Canada RSS-102 Radio Frequency Exposure Compliance of Radiocommunication Apparatus (All Frequency Bands) Issue 4, March 2010.
- [22] Health Canada Safety Code 6 Limits of Human Exposure to Radio Frequency Electromagnetic Fields in the Frequency Range from 3 kHz – 300 GHz, 2009
- [23] FCC SAR Test Procedures for 2G-3G Devices, Mobile Hotspot and UMPC Devices KDB Publications 941225, D01-D07
- [24] SAR Measurement procedures for IEEE 802.11a/b/g KDB Publication 248227 D01v01r02
- [25] FCC SAR Considerations for Handsets with Multiple Transmitters and Antennas, KDB Publications 648474 D02-D04
- [26] FCC SAR Evaluation Considerations for Laptop, Notebook, Netbook and Tablet Computers, FCC KDB Publication 616217 D04
- [27] FCC SAR Measurement and Reporting Requirements for 100MHz – 6 GHz, KDB Publications 865664 D01-D02
- [28] FCC General RF Exposure Guidance and SAR Procedures for Dongles, KDB Publication 447498, D01-D02
- [29] Anexo à Resolução No. 533, de 10 de Setembro de 2009.
- [30] IEC 62209-2, Human exposure to radio frequency fields from hand-held and body-mounted wireless communication devices - Human models, instrumentation, and procedures - Part 2: Procedure to determine the specific absorption rate (SAR) for wireless communication devices used in close proximity to the human body (frequency range of 30 MHz to 6 GHz), Mar. 2010.

FCC ID A3LSPHL520	 <b>SAR EVALUATION REPORT</b> 		<b>Reviewed by:</b> Quality Manager
Document S/N: 0Y1407011333.A3L	Test Dates: 07/07/14 - 07/09/14	DUT Type: Portable Handset	Page 41 of 41

## APPENDIX A: SAR TEST DATA

# PCTEST ENGINEERING LABORATORY, INC.

**DUT: A3LSPHL520; Type: Portable Handset; Serial: 051805af**

Communication System: UID 0, LTE B25; Frequency: 1882.5 MHz; Duty Cycle: 1:1

Medium: 1900 Head Medium parameters used (interpolated):

$f = 1882.5 \text{ MHz}$ ;  $\sigma = 1.416 \text{ S/m}$ ;  $\epsilon_r = 39.459$ ;  $\rho = 1000 \text{ kg/m}^3$

Phantom section: Left Section

Test Date: 07-09-2014; Ambient Temp: 22.0°C; Tissue Temp: 21.6°C

Probe: ES3DV3 - SN3288; ConvF(5.47, 5.47, 5.47); Calibrated: 9/23/2013;

Sensor-Surface: 3mm (Mechanical Surface Detection)

Electronics: DAE4 Sn1323; Calibrated: 9/17/2013

Phantom: SAM with CRP; Type: SAM; Serial: TP1375

Measurement SW: DASY4, Version 4.7 (80); SEMCAD X Version 14.6.10 (7331)

**Mode: LTE Band 25 (PCS), Left Head, Cheek, Mid.ch**  
**20 MHz Bandwidth, QPSK, 1 RB, 99 RB Offset**

**Area Scan (9x15x1):** Measurement grid: dx=15mm, dy=15mm

**Zoom Scan (5x5x7)/Cube 0:** Measurement grid: dx=8mm, dy=8mm, dz=5mm

Reference Value = 19.50 V/m; Power Drift = -0.08 dB

Peak SAR (extrapolated) = 0.625 W/kg

**SAR(1 g) = 0.414 W/kg**

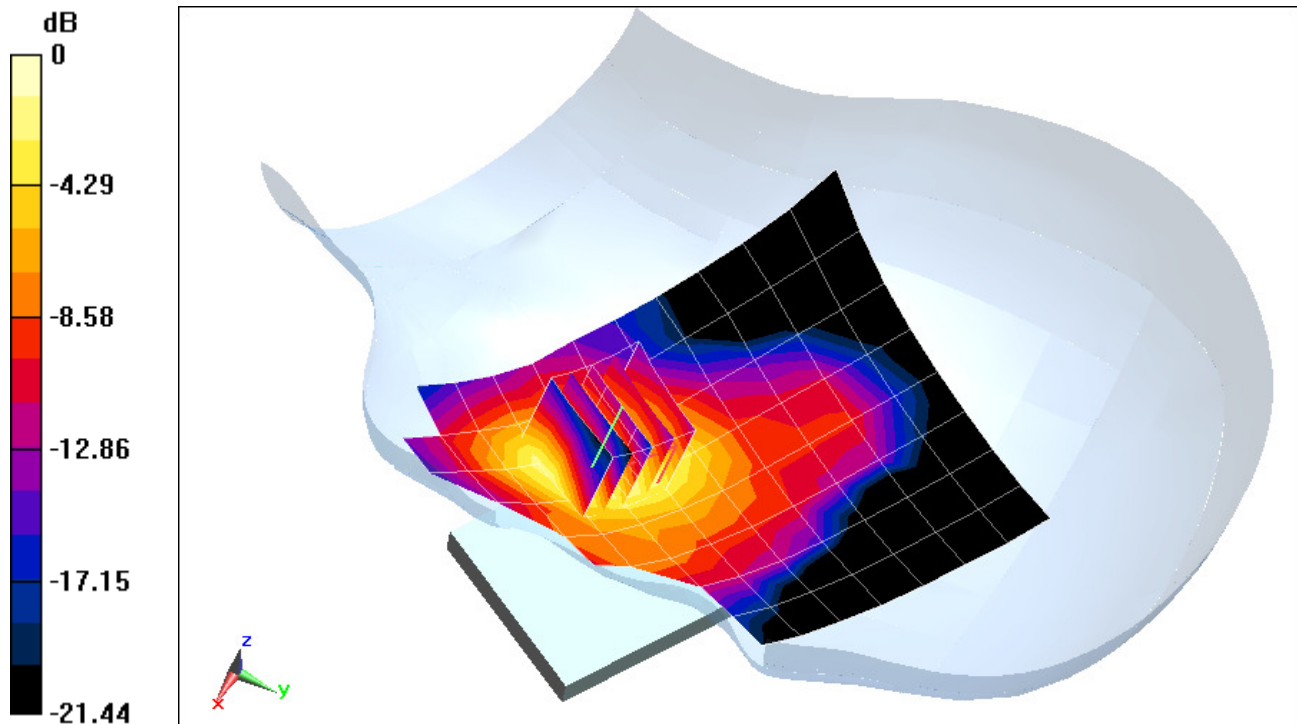

0 dB = 0.496 W/kg = -3.05 dBW/kg

# PCTEST ENGINEERING LABORATORY, INC.

**DUT: A3LSPHL520; Type: Portable Handset; Serial: 051805af**

Communication System: UID 0, LTE BAND 25; Frequency: 1882.5 MHz; Duty Cycle: 1:1

Medium: 1900 Body Medium parameters used (interpolated):

$f = 1882.5 \text{ MHz}$ ;  $\sigma = 1.52 \text{ S/m}$ ;  $\epsilon_r = 52.712$ ;  $\rho = 1000 \text{ kg/m}^3$

Phantom section: Flat Section; Space: 1.0 cm

Test Date: 07-07-2014; Ambient Temp: 22.4°C; Tissue Temp: 22.1°C

Probe: ES3DV3 - SN3288; ConvF(4.82, 4.82, 4.82); Calibrated: 9/23/2013;

Sensor-Surface: 3mm (Mechanical Surface Detection)

Electronics: DAE4 Sn1323; Calibrated: 9/17/2013

Phantom: SAM Sub Dasy B; Type: SAM 5.0; Serial: TP-1626

Measurement SW: DASY4, Version 4.7 (80); SEMCAD X Version 14.6.10 (7331)

**Mode: LTE Band 25 (PCS), Body SAR, Back side, Mid.ch**  
**20 MHz Bandwidth, QPSK, 1 RB, 99 RB Offset**

**Area Scan (9x15x1):** Measurement grid: dx=15mm, dy=15mm

**Zoom Scan (5x5x7)/Cube 0:** Measurement grid: dx=8mm, dy=8mm, dz=5mm

Reference Value = 18.07 V/m; Power Drift = -0.01 dB

Peak SAR (extrapolated) = 0.725 W/kg

**SAR(1 g) = 0.444 W/kg**

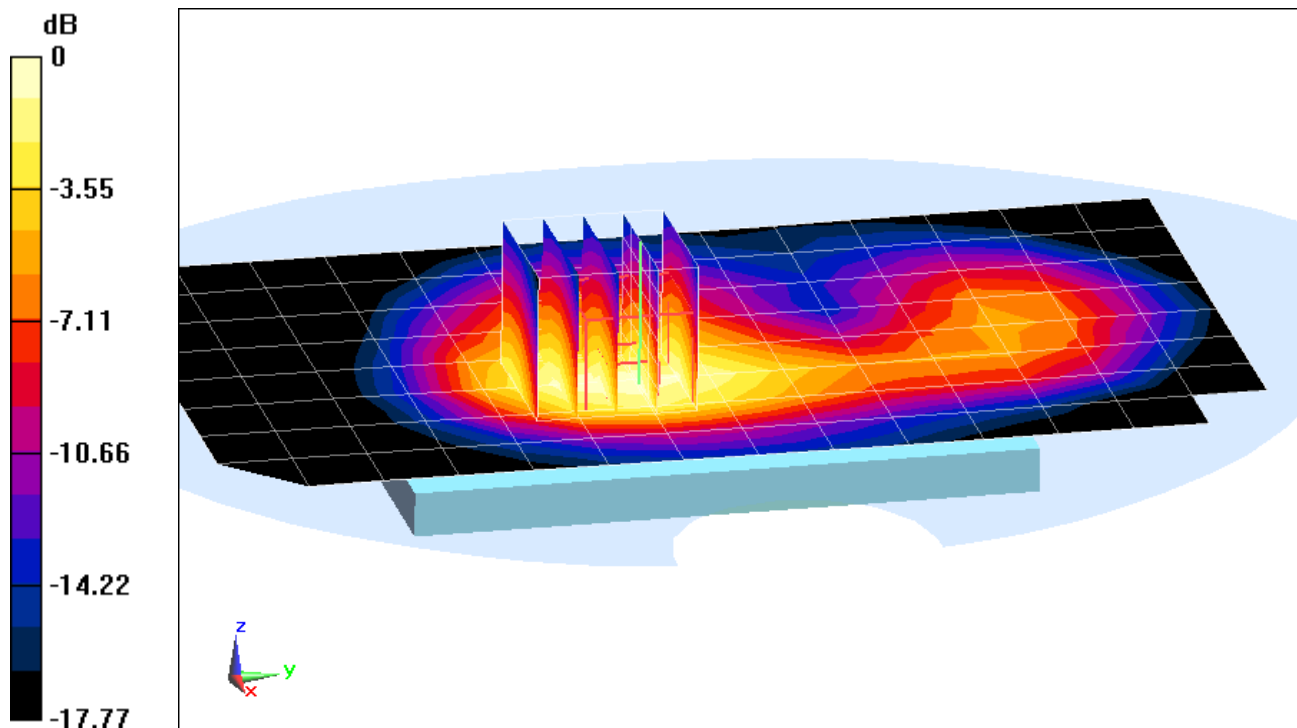

0 dB = 0.543 W/kg = -2.65 dBW/kg

## APPENDIX B: SYSTEM VERIFICATION

# PCTEST ENGINEERING LABORATORY, INC.

**DUT: SAR Dipole 1900 MHz; Type: D1900V2; Serial: 5d148**

Communication System: UID 0, CW; Frequency: 1900 MHz; Duty Cycle: 1:1

Medium: 1900 Head Medium parameters used (interpolated):

$f = 1900 \text{ MHz}$ ;  $\sigma = 1.434 \text{ S/m}$ ;  $\epsilon_r = 39.353$ ;  $\rho = 1000 \text{ kg/m}^3$

Phantom section: Flat Section; Space: 1.0 cm

Test Date: 07-09-2014; Ambient Temp: 22.0°C; Tissue Temp: 21.6°C

Probe: ES3DV3 - SN3288; ConvF(5.47, 5.47, 5.47); Calibrated: 9/23/2013;

Sensor-Surface: 3mm (Mechanical Surface Detection)

Electronics: DAE4 Sn1323; Calibrated: 9/17/2013

Phantom: SAM with CRP; Type: SAM; Serial: TP1375

Measurement SW: DASY4, Version 4.7 (80); SEMCAD X Version 14.6.10 (7331)

## 1900MHz System Verification

**Area Scan (5x7x1):** Measurement grid: dx=15mm, dy=15mm

**Zoom Scan (5x5x7)/Cube 0:** Measurement grid: dx=8mm, dy=8mm, dz=5mm

Input Power = 20 dBm (100 mW)

Peak SAR (extrapolated) = 6.89 W/kg

**SAR(1 g) = 3.87 W/kg**

Deviation = -4.91%

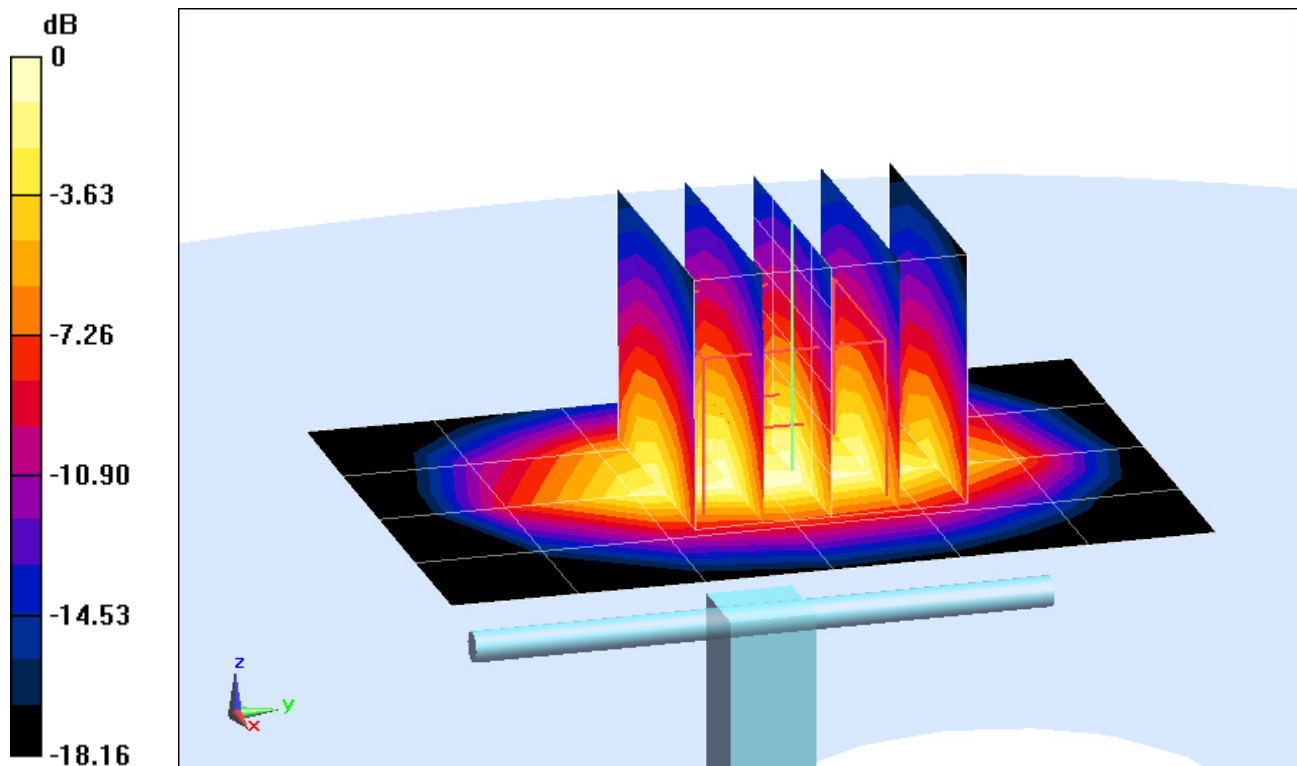

0 dB = 4.84 W/kg = 6.85 dBW/kg

# PCTEST ENGINEERING LABORATORY, INC.

**DUT: SAR Dipole 1900 MHz; Type: D1900V2; Serial: 5d148**

Communication System: UID 0, CW; Frequency: 1900 MHz; Duty Cycle: 1:1

Medium: 1900 Body Medium parameters used (interpolated):

$f = 1900 \text{ MHz}$ ;  $\sigma = 1.542 \text{ S/m}$ ;  $\epsilon_r = 52.652$ ;  $\rho = 1000 \text{ kg/m}^3$

Phantom section: Flat Section; Space: 1.0 cm

Test Date: 07-07-2014; Ambient Temp: 22.4°C; Tissue Temp: 22.1°C

Probe: ES3DV3 - SN3288; ConvF(4.82, 4.82, 4.82); Calibrated: 9/23/2013;

Sensor-Surface: 3mm (Mechanical Surface Detection)

Electronics: DAE4 Sn1323; Calibrated: 9/17/2013

Phantom: SAM Sub Dasy B; Type: SAM 5.0; Serial: TP-1626

Measurement SW: DASY4, Version 4.7 (80); SEMCAD X Version 14.6.10 (7331)

## 1900MHz System Verification

**Area Scan (5x7x1):** Measurement grid: dx=15mm, dy=15mm

**Zoom Scan (5x5x7)/Cube 0:** Measurement grid: dx=8mm, dy=8mm, dz=5mm

Input Power = 20 dBm (100 mW)

Peak SAR (extrapolated) = 6.98 W/kg

**SAR(1 g) = 3.99 W/kg**

Deviation = 1.53%

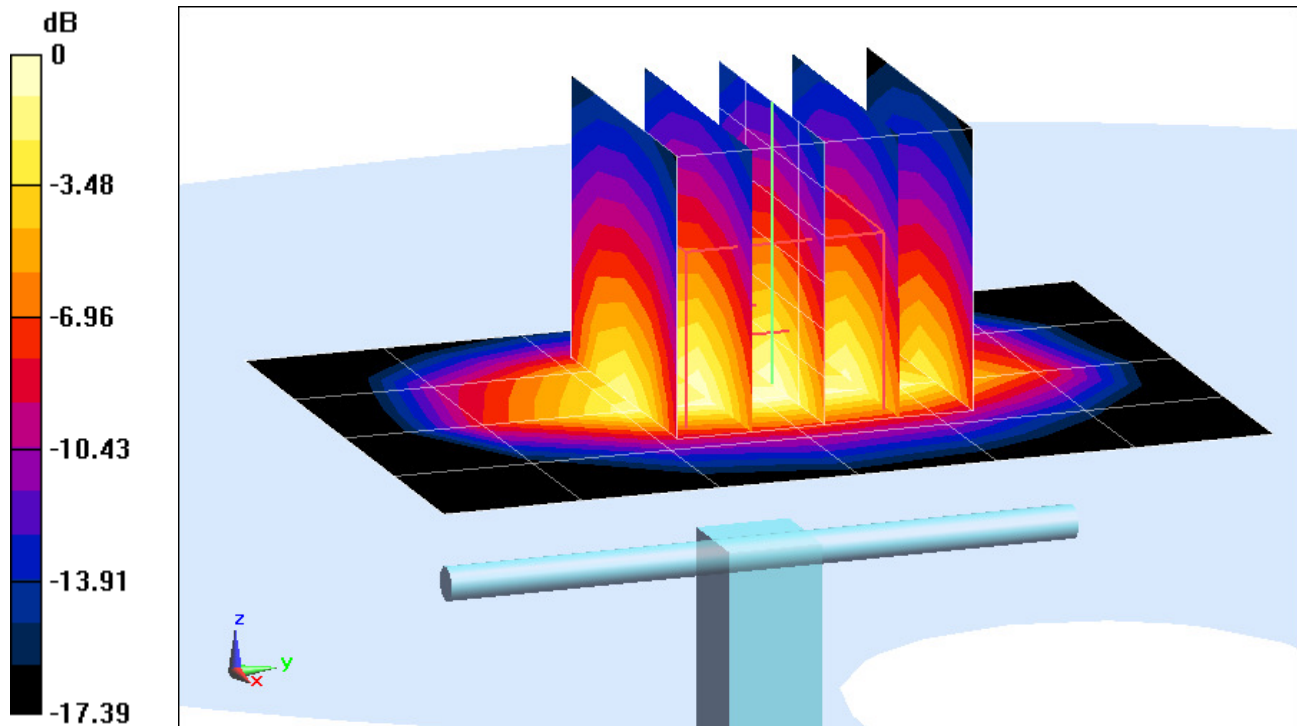

0 dB = 4.95 W/kg = 6.95 dBW/kg

## APPENDIX C: PROBE CALIBRATION





Accredited by the Swiss Accreditation Service (SAS)  
The Swiss Accreditation Service is one of the signatories to the EA  
Multilateral Agreement for the recognition of calibration certificates

Accreditation No.: **SCS 108**

Client **PC Test**

Certificate No: **ES3-3288\_Sep13/2**

**CALIBRATION CERTIFICATE (Replacement of No: ES3-3288\_Sep13)**

Object **ES3DV3 - SN:3288** CCV  
10/4/13

Calibration procedure(s) **QA CAL-01.v9, QA CAL-23.v5, QA CAL-25.v6  
Calibration procedure for dosimetric E-field probes**

Calibration date: **September 23, 2013**

This calibration certificate documents the traceability to national standards, which realize the physical units of measurements (SI).  
The measurements and the uncertainties with confidence probability are given on the following pages and are part of the certificate.

All calibrations have been conducted in the closed laboratory facility: environment temperature (22 ± 3)°C and humidity < 70%.

Calibration Equipment used (M&TE critical for calibration)

Primary Standards	ID	Cal Date (Certificate No.)	Scheduled Calibration
Power meter E4419B	GB41293874	04-Apr-13 (No. 217-01733)	Apr-14
Power sensor E4412A	MY41498087	04-Apr-13 (No. 217-01733)	Apr-14
Reference 3 dB Attenuator	SN: S5054 (3c)	04-Apr-13 (No. 217-01737)	Apr-14
Reference 20 dB Attenuator	SN: S5277 (20x)	04-Apr-13 (No. 217-01735)	Apr-14
Reference 30 dB Attenuator	SN: S5129 (30b)	04-Apr-13 (No. 217-01738)	Apr-14
Reference Probe ES3DV2	SN: 3013	28-Dec-12 (No. ES3-3013_Dec12)	Dec-13
DAE4	SN: 660	4-Sep-13 (No. DAE4-660_Sep13)	Apr-14
Secondary Standards	ID	Check Date (in house)	Scheduled Check
RF generator HP 8648C	US3642U01700	4-Aug-99 (in house check Apr-13)	In house check: Apr-15
Network Analyzer HP 8753E	US37390585	18-Oct-01 (in house check Oct-12)	In house check: Oct-13

	Name	Function	Signature
Calibrated by:	Jeton Kastrati	Laboratory Technician	
Approved by:	Katja Pokovic	Technical Manager	

Issued: October 4, 2013

This calibration certificate shall not be reproduced except in full without written approval of the laboratory.

PCT# 80828

# Probe ES3DV3

## SN:3288

Manufactured: July 6, 2010  
Calibrated: September 23, 2013

Calibrated for DASY/EASY Systems  
(Note: non-compatible with DASY2 system!)



Accredited by the Swiss Accreditation Service (SAS)

Accreditation No.: **SCS 108**

The Swiss Accreditation Service is one of the signatories to the EA  
Multilateral Agreement for the recognition of calibration certificates

### Glossary:

TSL	tissue simulating liquid
NORM <sub>x,y,z</sub>	sensitivity in free space
ConvF	sensitivity in TSL / NORM <sub>x,y,z</sub>
DCP	diode compression point
CF	crest factor (1/duty_cycle) of the RF signal
A, B, C, D	modulation dependent linearization parameters
Polarization $\varphi$	$\varphi$ rotation around probe axis
Polarization $\vartheta$	$\vartheta$ rotation around an axis that is in the plane normal to probe axis (at measurement center), i.e., $\vartheta = 0$ is normal to probe axis

### Calibration is Performed According to the Following Standards:

- IEEE Std 1528-2013, "IEEE Recommended Practice for Determining the Peak Spatial-Averaged Specific Absorption Rate (SAR) in the Human Head from Wireless Communications Devices: Measurement Techniques", June 2013
- IEC 62209-1, "Procedure to measure the Specific Absorption Rate (SAR) for hand-held devices used in close proximity to the ear (frequency range of 300 MHz to 3 GHz)", February 2005

### Methods Applied and Interpretation of Parameters:

- NORM<sub>x,y,z</sub>**: Assessed for E-field polarization  $\vartheta = 0$  ( $f \leq 900$  MHz in TEM-cell;  $f > 1800$  MHz: R22 waveguide). NORM<sub>x,y,z</sub> are only intermediate values, i.e., the uncertainties of NORM<sub>x,y,z</sub> does not affect the E<sup>2</sup>-field uncertainty inside TSL (see below ConvF).
- NORM(f)<sub>x,y,z</sub>** = NORM<sub>x,y,z</sub> \* frequency\_response (see Frequency Response Chart). This linearization is implemented in DASY4 software versions later than 4.2. The uncertainty of the frequency response is included in the stated uncertainty of ConvF.
- DCP<sub>x,y,z</sub>**: DCP are numerical linearization parameters assessed based on the data of power sweep with CW signal (no uncertainty required). DCP does not depend on frequency nor media.
- PAR**: PAR is the Peak to Average Ratio that is not calibrated but determined based on the signal characteristics
- A<sub>x,y,z</sub>; B<sub>x,y,z</sub>; C<sub>x,y,z</sub>; D<sub>x,y,z</sub>; VR<sub>x,y,z</sub>**: A, B, C, D are numerical linearization parameters assessed based on the data of power sweep for specific modulation signal. The parameters do not depend on frequency nor media. VR is the maximum calibration range expressed in RMS voltage across the diode.
- ConvF and Boundary Effect Parameters**: Assessed in flat phantom using E-field (or Temperature Transfer Standard for  $f \leq 800$  MHz) and inside waveguide using analytical field distributions based on power measurements for  $f > 800$  MHz. The same setups are used for assessment of the parameters applied for boundary compensation (alpha, depth) of which typical uncertainty values are given. These parameters are used in DASY4 software to improve probe accuracy close to the boundary. The sensitivity in TSL corresponds to NORM<sub>x,y,z</sub> \* ConvF whereby the uncertainty corresponds to that given for ConvF. A frequency dependent ConvF is used in DASY version 4.4 and higher which allows extending the validity from  $\pm 50$  MHz to  $\pm 100$  MHz.
- Spherical isotropy (3D deviation from isotropy)**: in a field of low gradients realized using a flat phantom exposed by a patch antenna.
- Sensor Offset**: The sensor offset corresponds to the offset of virtual measurement center from the probe tip (on probe axis). No tolerance required.

## DASY/EASY - Parameters of Probe: ES3DV3 - SN:3288

### Basic Calibration Parameters

	Sensor X	Sensor Y	Sensor Z	Unc (k=2)
Norm ( $\mu V/(V/m)^2$ ) <sup>A</sup>	0.87	0.97	0.75	± 10.1 %
DCP (mV) <sup>B</sup>	103.3	103.2	100.2	

### Modulation Calibration Parameters

UID	Communication System Name		A dB	B dB $\sqrt{\mu V}$	C	D dB	VR mV	Unc <sup>E</sup> (k=2)
0	CW	X	0.0	0.0	1.0	0.00	171.1	±3.5 %
		Y	0.0	0.0	1.0		135.0	
		Z	0.0	0.0	1.0		154.3	

The reported uncertainty of measurement is stated as the standard uncertainty of measurement multiplied by the coverage factor k=2, which for a normal distribution corresponds to a coverage probability of approximately 95%.

<sup>A</sup> The uncertainties of NormX,Y,Z do not affect the E<sup>2</sup>-field uncertainty inside TSL (see Pages 5 and 6).

<sup>B</sup> Numerical linearization parameter: uncertainty not required.

<sup>E</sup> Uncertainty is determined using the max. deviation from linear response applying rectangular distribution and is expressed for the square of the field value.

## DASY/EASY - Parameters of Probe: ES3DV3 - SN:3288

### Calibration Parameter Determined in Head Tissue Simulating Media

f (MHz) <sup>C</sup>	Relative Permittivity <sup>F</sup>	Conductivity (S/m) <sup>F</sup>	ConvF X	ConvF Y	ConvF Z	Alpha	Depth (mm)	Unct. (k=2)
750	41.9	0.89	6.56	6.56	6.56	0.32	1.89	± 12.0 %
835	41.5	0.90	6.37	6.37	6.37	0.34	1.82	± 12.0 %
1750	40.1	1.37	5.67	5.67	5.67	0.56	1.51	± 12.0 %
1900	40.0	1.40	5.47	5.47	5.47	0.80	1.29	± 12.0 %
2450	39.2	1.80	4.63	4.63	4.63	0.80	1.34	± 12.0 %
2600	39.0	1.96	4.55	4.55	4.55	0.80	1.41	± 12.0 %

<sup>C</sup> Frequency validity of ± 100 MHz only applies for DASY v4.4 and higher (see Page 2), else it is restricted to ± 50 MHz. The uncertainty is the RSS of the ConvF uncertainty at calibration frequency and the uncertainty for the indicated frequency band.

<sup>F</sup> At frequencies below 3 GHz, the validity of tissue parameters ( $\epsilon$  and  $\sigma$ ) can be relaxed to ± 10% if liquid compensation formula is applied to measured SAR values. At frequencies above 3 GHz, the validity of tissue parameters ( $\epsilon$  and  $\sigma$ ) is restricted to ± 5%. The uncertainty is the RSS of the ConvF uncertainty for indicated target tissue parameters.

## DASY/EASY - Parameters of Probe: ES3DV3 - SN:3288

### Calibration Parameter Determined in Body Tissue Simulating Media

f (MHz) <sup>C</sup>	Relative Permittivity <sup>F</sup>	Conductivity (S/m) <sup>F</sup>	ConvF X	ConvF Y	ConvF Z	Alpha	Depth (mm)	Unct. (k=2)
750	55.5	0.96	6.25	6.25	6.25	0.70	1.27	± 12.0 %
835	55.2	0.97	6.27	6.27	6.27	0.75	1.22	± 12.0 %
1750	53.4	1.49	5.10	5.10	5.10	0.59	1.46	± 12.0 %
1900	53.3	1.52	4.82	4.82	4.82	0.53	1.54	± 12.0 %
2450	52.7	1.95	4.37	4.37	4.37	0.80	1.02	± 12.0 %
2600	52.5	2.16	4.14	4.14	4.14	0.64	0.94	± 12.0 %

<sup>C</sup> Frequency validity of ± 100 MHz only applies for DASY v4.4 and higher (see Page 2), else it is restricted to ± 50 MHz. The uncertainty is the RSS of the ConvF uncertainty at calibration frequency and the uncertainty for the indicated frequency band.

<sup>F</sup> At frequencies below 3 GHz, the validity of tissue parameters ( $\epsilon$  and  $\sigma$ ) can be relaxed to ± 10% if liquid compensation formula is applied to measured SAR values. At frequencies above 3 GHz, the validity of tissue parameters ( $\epsilon$  and  $\sigma$ ) is restricted to ± 5%. The uncertainty is the RSS of the ConvF uncertainty for indicated target tissue parameters.

### Frequency Response of E-Field (TEM-Cell:ifi110 EXX, Waveguide: R22)

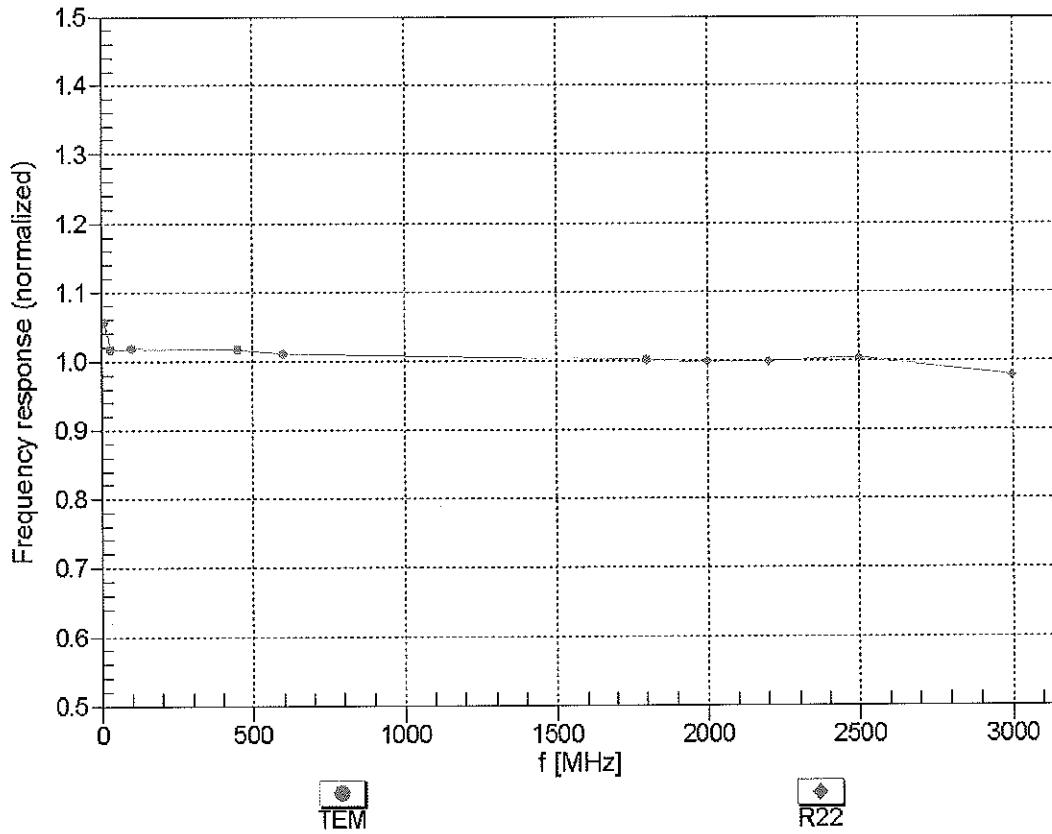

Uncertainty of Frequency Response of E-field:  $\pm 6.3\%$  (k=2)

### Receiving Pattern ( $\phi$ ), $\theta = 0^\circ$

f=600 MHz,TEM

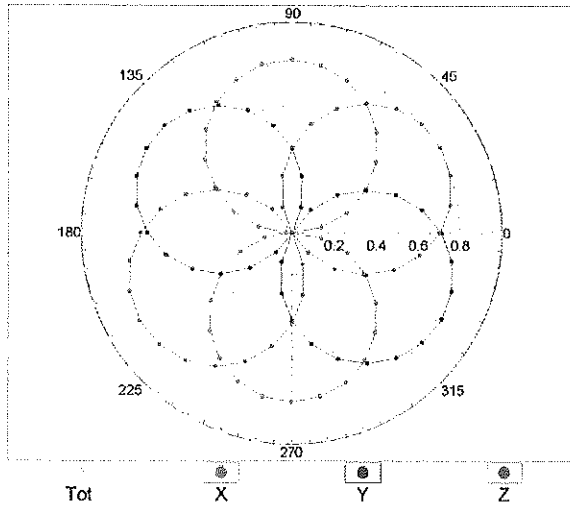

f=1800 MHz,R22

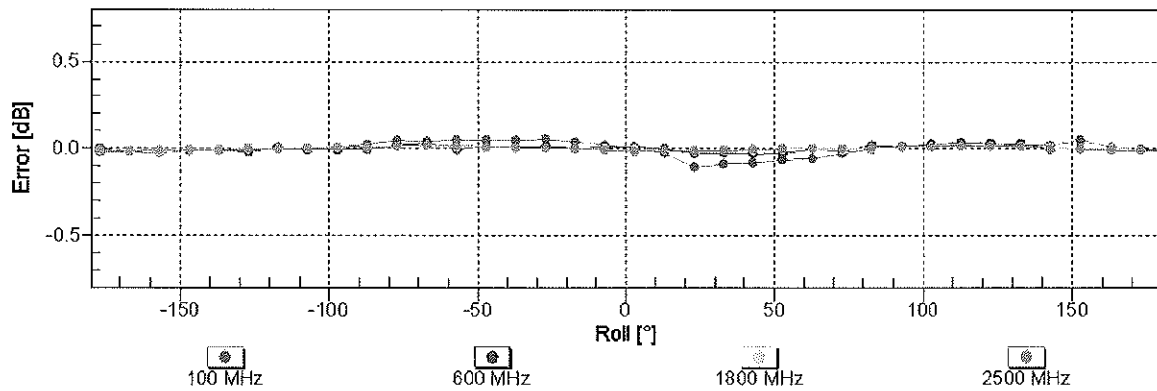
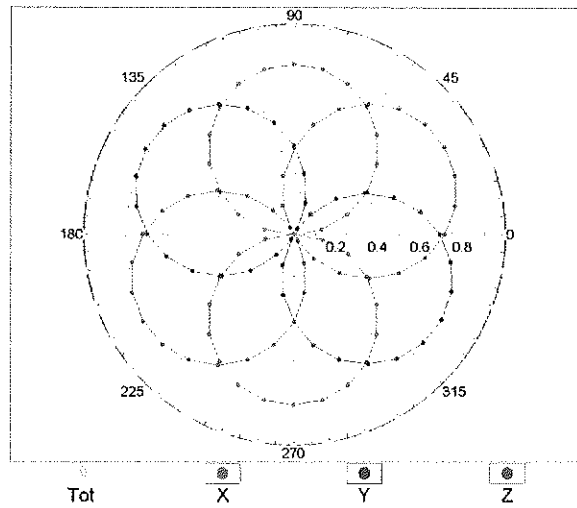

Uncertainty of Axial Isotropy Assessment:  $\pm 0.5\%$  (k=2)



### Dynamic Range $f(\text{SAR}_{\text{head}})$ (TEM cell , $f = 900 \text{ MHz}$ )

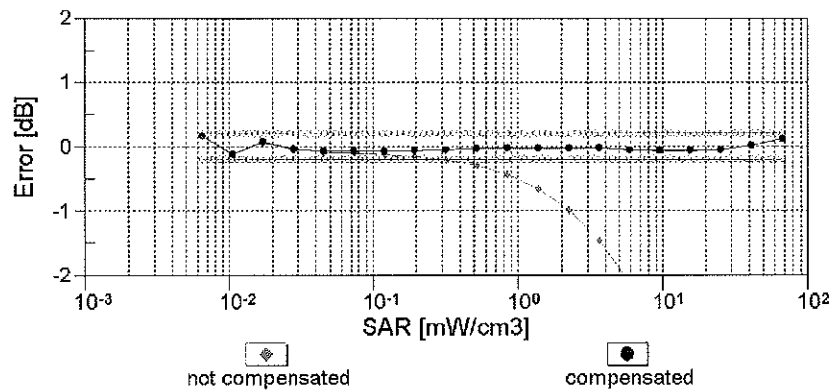
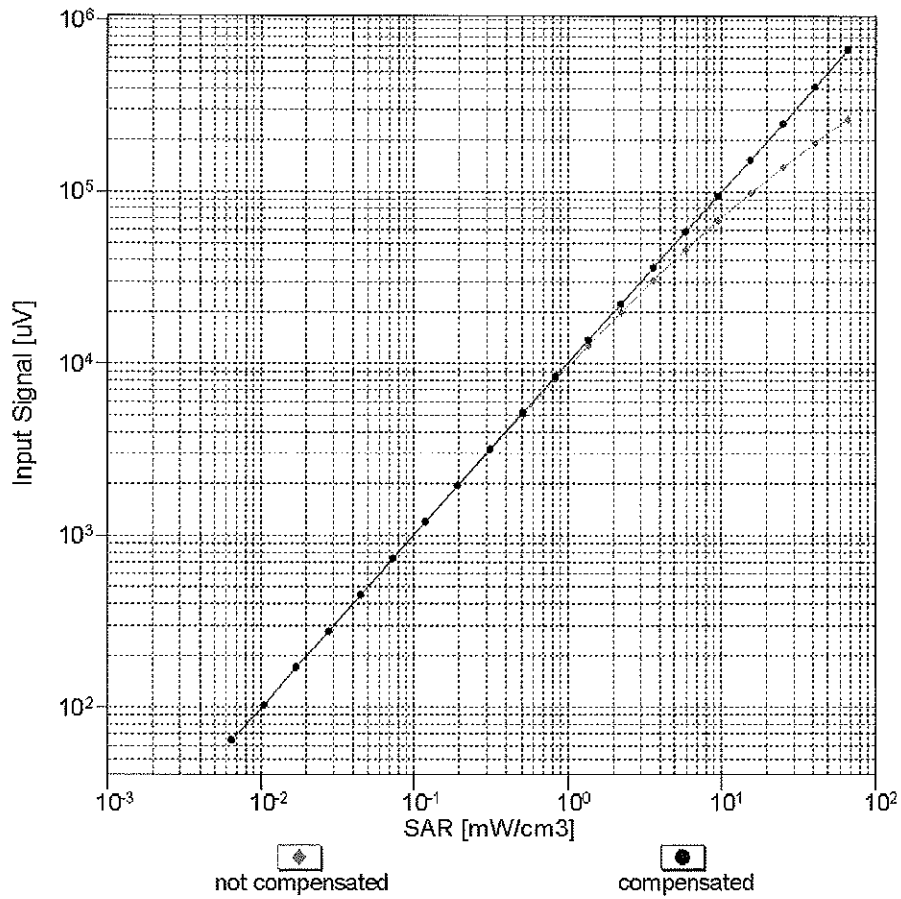

Uncertainty of Linearity Assessment:  $\pm 0.6\%$  ( $k=2$ )

## Conversion Factor Assessment

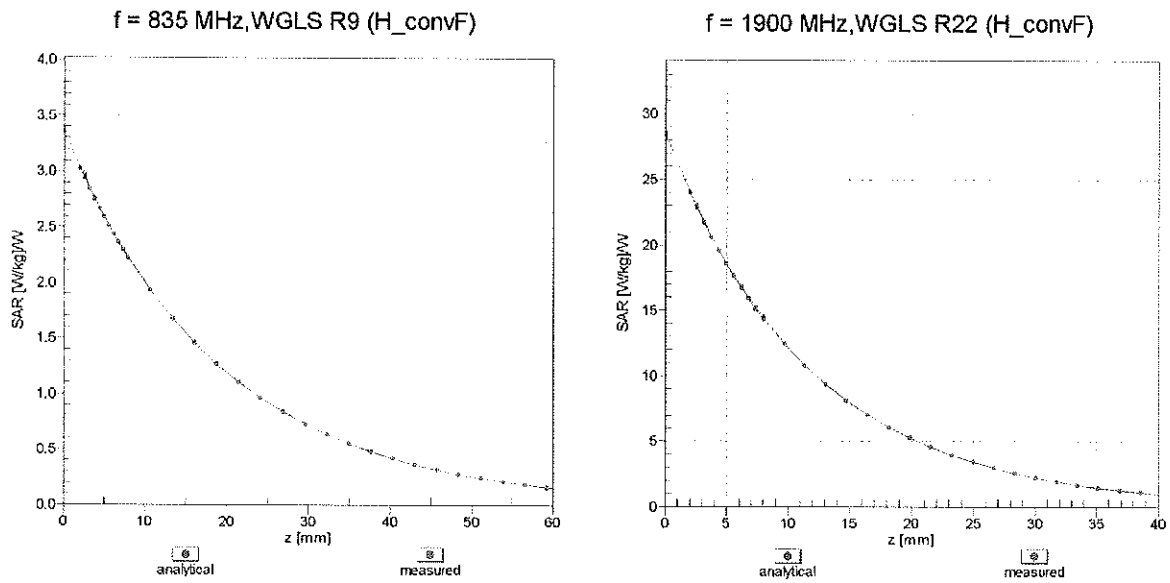

## Deviation from Isotropy in Liquid Error ( $\phi, \theta$ ), f = 900 MHz

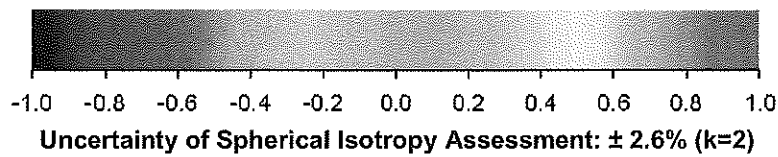
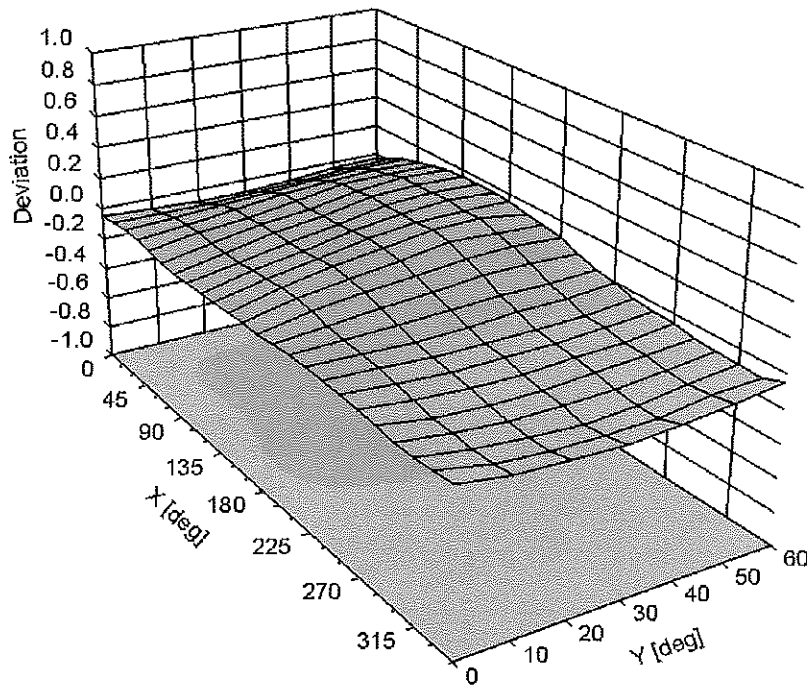

## DASY/EASY - Parameters of Probe: ES3DV3 - SN:3288

### Other Probe Parameters

Sensor Arrangement	Triangular
Connector Angle (°)	-127.1
Mechanical Surface Detection Mode	enabled
Optical Surface Detection Mode	disabled
Probe Overall Length	337 mm
Probe Body Diameter	10 mm
Tip Length	10 mm
Tip Diameter	4 mm
Probe Tip to Sensor X Calibration Point	2 mm
Probe Tip to Sensor Y Calibration Point	2 mm
Probe Tip to Sensor Z Calibration Point	2 mm
Recommended Measurement Distance from Surface	3 mm



Accredited by the Swiss Accreditation Service (SAS)  
The Swiss Accreditation Service is one of the signatories to the EA  
Multilateral Agreement for the recognition of calibration certificates

Accreditation No.: **SCS 108**

Client **PC Test**

Certificate No: **D1900V2-5d148\_Feb14**

## CALIBRATION CERTIFICATE

Object **D1900V2 - SN: 5d148**

Calibration procedure(s) **QA CAL-05.v9**  
**Calibration procedure for dipole validation kits above 700 MHz**

Calibration date: **February 27, 2014**

*CCV  
27/2/2014*

This calibration certificate documents the traceability to national standards, which realize the physical units of measurements (SI).  
The measurements and the uncertainties with confidence probability are given on the following pages and are part of the certificate.

All calibrations have been conducted in the closed laboratory facility: environment temperature ( $22 \pm 3$ )°C and humidity < 70%.

Calibration Equipment used (M&TE critical for calibration)

Primary Standards	ID #	Cal Date (Certificate No.)	Scheduled Calibration
Power meter EPM-442A	GB37480704	09-Oct-13 (No. 217-01827)	Oct-14
Power sensor HP 8481A	US37292783	09-Oct-13 (No. 217-01827)	Oct-14
Power sensor HP 8481A	MY41092317	09-Oct-13 (No. 217-01828)	Oct-14
Reference 20 dB Attenuator	SN: 5058 (20k)	04-Apr-13 (No. 217-01736)	Apr-14
Type-N mismatch combination	SN: 5047.3 / 06327	04-Apr-13 (No. 217-01739)	Apr-14
Reference Probe ES3DV3	SN: 3205	30-Dec-13 (No. ES3-3205_Dec13)	Dec-14
DAE4	SN: 601	25-Apr-13 (No. DAE4-601_Apr13)	Apr-14
Secondary Standards	ID #	Check Date (in house)	Scheduled Check
RF generator R&S SMT-06	100005	04-Aug-99 (in house check Oct-13)	In house check: Oct-16
Network Analyzer HP 8753E	US37390585 S4206	18-Oct-01 (in house check Oct-13)	In house check: Oct-14

Calibrated by: **Jeton Kastrati** (Name) / **Laboratory Technician** (Function) / *[Signature]* (Signature)

Approved by: **Katja Pokovic** (Name) / **Technical Manager** (Function) / *[Signature]* (Signature)

Issued: February 27, 2014

This calibration certificate shall not be reproduced except in full without written approval of the laboratory.



Accredited by the Swiss Accreditation Service (SAS)

The Swiss Accreditation Service is one of the signatories to the EA Multilateral Agreement for the recognition of calibration certificates

Accreditation No.: **SCS 108**

**Glossary:**

TSL	tissue simulating liquid
ConvF	sensitivity in TSL / NORM x,y,z
N/A	not applicable or not measured

**Calibration is Performed According to the Following Standards:**

- IEEE Std 1528-2013, "IEEE Recommended Practice for Determining the Peak Spatial-Averaged Specific Absorption Rate (SAR) in the Human Head from Wireless Communications Devices: Measurement Techniques", June 2013
- IEC 62209-1, "Procedure to measure the Specific Absorption Rate (SAR) for hand-held devices used in close proximity to the ear (frequency range of 300 MHz to 3 GHz)", February 2005
- KDB 865664, "SAR Measurement Requirements for 100 MHz to 6 GHz"

**Additional Documentation:**

- DASY4/5 System Handbook

**Methods Applied and Interpretation of Parameters:**

- Measurement Conditions:** Further details are available from the Validation Report at the end of the certificate. All figures stated in the certificate are valid at the frequency indicated.
- Antenna Parameters with TSL:** The dipole is mounted with the spacer to position its feed point exactly below the center marking of the flat phantom section, with the arms oriented parallel to the body axis.
- Feed Point Impedance and Return Loss:** These parameters are measured with the dipole positioned under the liquid filled phantom. The impedance stated is transformed from the measurement at the SMA connector to the feed point. The Return Loss ensures low reflected power. No uncertainty required.
- Electrical Delay:** One-way delay between the SMA connector and the antenna feed point. No uncertainty required.
- SAR measured:** SAR measured at the stated antenna input power.
- SAR normalized:** SAR as measured, normalized to an input power of 1 W at the antenna connector.
- SAR for nominal TSL parameters:** The measured TSL parameters are used to calculate the nominal SAR result.

The reported uncertainty of measurement is stated as the standard uncertainty of measurement multiplied by the coverage factor  $k=2$ , which for a normal distribution corresponds to a coverage probability of approximately 95%.

## Measurement Conditions

DASY system configuration, as far as not given on page 1.

<b>DASY Version</b>	DASY5	V52.8.7
<b>Extrapolation</b>	Advanced Extrapolation	
<b>Phantom</b>	Modular Flat Phantom	
<b>Distance Dipole Center - TSL</b>	10 mm	with Spacer
<b>Zoom Scan Resolution</b>	dx, dy, dz = 5 mm	
<b>Frequency</b>	1900 MHz $\pm$ 1 MHz	

## Head TSL parameters

The following parameters and calculations were applied.

	Temperature	Permittivity	Conductivity
<b>Nominal Head TSL parameters</b>	22.0 °C	40.0	1.40 mho/m
<b>Measured Head TSL parameters</b>	(22.0 $\pm$ 0.2) °C	38.9 $\pm$ 6 %	1.39 mho/m $\pm$ 6 %
<b>Head TSL temperature change during test</b>	< 0.5 °C	----	----

## SAR result with Head TSL

<b>SAR averaged over 1 cm<sup>3</sup> (1 g) of Head TSL</b>	Condition	
SAR measured	250 mW input power	10.2 W/kg
SAR for nominal Head TSL parameters	normalized to 1W	<b>40.7 W/kg <math>\pm</math> 17.0 % (k=2)</b>

<b>SAR averaged over 10 cm<sup>3</sup> (10 g) of Head TSL</b>	condition	
SAR measured	250 mW input power	5.31 W/kg
SAR for nominal Head TSL parameters	normalized to 1W	<b>21.2 W/kg <math>\pm</math> 16.5 % (k=2)</b>

## Body TSL parameters

The following parameters and calculations were applied.

	Temperature	Permittivity	Conductivity
<b>Nominal Body TSL parameters</b>	22.0 °C	53.3	1.52 mho/m
<b>Measured Body TSL parameters</b>	(22.0 $\pm$ 0.2) °C	52.8 $\pm$ 6 %	1.49 mho/m $\pm$ 6 %
<b>Body TSL temperature change during test</b>	< 0.5 °C	----	----

## SAR result with Body TSL

<b>SAR averaged over 1 cm<sup>3</sup> (1 g) of Body TSL</b>	Condition	
SAR measured	250 mW input power	9.73 W/kg
SAR for nominal Body TSL parameters	normalized to 1W	<b>39.3 W/kg <math>\pm</math> 17.0 % (k=2)</b>

<b>SAR averaged over 10 cm<sup>3</sup> (10 g) of Body TSL</b>	condition	
SAR measured	250 mW input power	5.15 W/kg
SAR for nominal Body TSL parameters	normalized to 1W	<b>20.7 W/kg <math>\pm</math> 16.5 % (k=2)</b>

## Appendix

### Antenna Parameters with Head TSL

Impedance, transformed to feed point	52.5 $\Omega$ + 5.5 j $\Omega$
Return Loss	- 24.6 dB

### Antenna Parameters with Body TSL

Impedance, transformed to feed point	48.0 $\Omega$ + 6.7 j $\Omega$
Return Loss	- 23.0 dB

### General Antenna Parameters and Design

Electrical Delay (one direction)	1.197 ns
----------------------------------	----------

After long term use with 100W radiated power, only a slight warming of the dipole near the feedpoint can be measured.

The dipole is made of standard semirigid coaxial cable. The center conductor of the feeding line is directly connected to the second arm of the dipole. The antenna is therefore short-circuited for DC-signals. On some of the dipoles, small end caps are added to the dipole arms in order to improve matching when loaded according to the position as explained in the "Measurement Conditions" paragraph. The SAR data are not affected by this change. The overall dipole length is still according to the Standard.

No excessive force must be applied to the dipole arms, because they might bend or the soldered connections near the feedpoint may be damaged.

### Additional EUT Data

Manufactured by	SPEAG
Manufactured on	March 11, 2011

## DASY5 Validation Report for Head TSL

Date: 27.02.2014

Test Laboratory: SPEAG, Zurich, Switzerland

**DUT: Dipole 1900 MHz; Type: D1900V2; Serial: D1900V2 - SN: 5d148**

Communication System: UID 0 - CW; Frequency: 1900 MHz

Medium parameters used:  $f = 1900$  MHz;  $\sigma = 1.39$  S/m;  $\epsilon_r = 38.9$ ;  $\rho = 1000$  kg/m<sup>3</sup>

Phantom section: Flat Section

Measurement Standard: DASY5 (IEEE/IEC/ANSI C63.19-2007)

DASY52 Configuration:

- Probe: ES3DV3 - SN3205; ConvF(5.06, 5.06, 5.06); Calibrated: 30.12.2013;
- Sensor-Surface: 3mm (Mechanical Surface Detection)
- Electronics: DAE4 Sn601; Calibrated: 25.04.2013
- Phantom: Flat Phantom 5.0 (front); Type: QD000P50AA; Serial: 1001
- DASY52 52.8.7(1137); SEMCAD X 14.6.10(7164)

### **Dipole Calibration for Head Tissue/Pin=250 mW, d=10mm/Zoom Scan (7x7x7)/Cube 0:**

Measurement grid: dx=5mm, dy=5mm, dz=5mm

Reference Value = 98.796 V/m; Power Drift = 0.02 dB

Peak SAR (extrapolated) = 18.9 W/kg

**SAR(1 g) = 10.2 W/kg; SAR(10 g) = 5.31 W/kg**

Maximum value of SAR (measured) = 12.8 W/kg

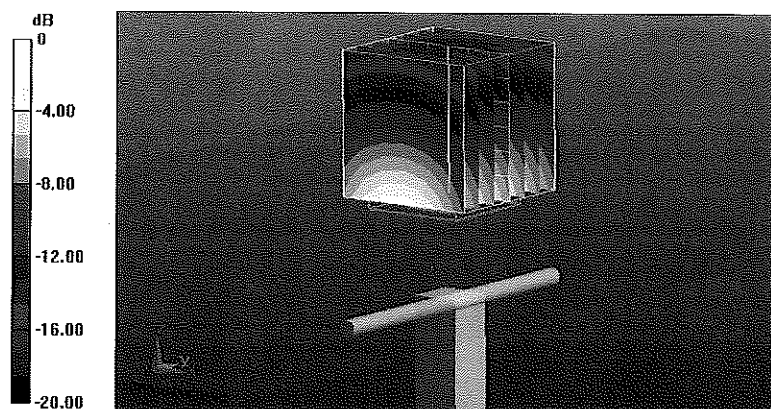

0 dB = 12.8 W/kg = 11.07 dBW/kg



# Impedance Measurement Plot for Head TSL

27 Feb 2014 09:42:31

CH1 S11 1 U FS 4: 52.533  $\Delta$  5.5234  $\Delta$  462.67  $\mu$ H 1 900.000 000 MHz

\*  
De1

CA

Avg  
16

H1d

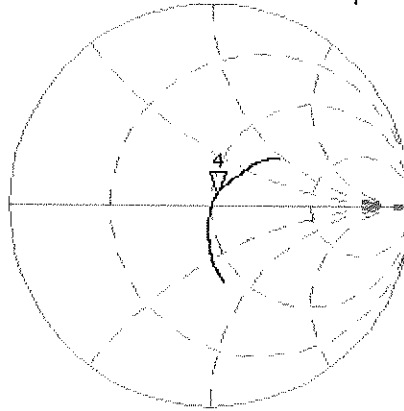

CH2 S11 LOG 5 dB/REF -20 dB 4: -24.552 dB 1 900.000 000 MHz

CA

Avg  
16

H1d

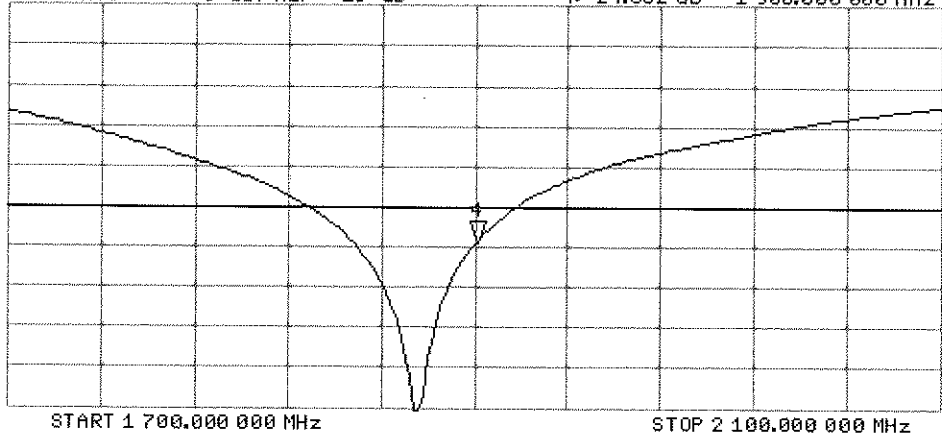

## DASY5 Validation Report for Body TSL

Date: 27.02.2014

Test Laboratory: SPEAG, Zurich, Switzerland

**DUT: Dipole 1900 MHz; Type: D1900V2; Serial: D1900V2 - SN: 5d148**

Communication System: UID 0 - CW; Frequency: 1900 MHz

Medium parameters used:  $f = 1900$  MHz;  $\sigma = 1.49$  S/m;  $\epsilon_r = 52.8$ ;  $\rho = 1000$  kg/m<sup>3</sup>

Phantom section: Flat Section

Measurement Standard: DASY5 (IEEE/IEC/ANSI C63.19-2007)

DASY52 Configuration:

- Probe: ES3DV3 - SN3205; ConvF(4.76, 4.76, 4.76); Calibrated: 30.12.2013;
- Sensor-Surface: 3mm (Mechanical Surface Detection)
- Electronics: DAE4 Sn601; Calibrated: 25.04.2013
- Phantom: Flat Phantom 5.0 (back); Type: QD000P50AA; Serial: 1002
- DASY52 52.8.7(1137); SEMCAD X 14.6.10(7164)

### Dipole Calibration for Body Tissue/Pin=250 mW, d=10mm/Zoom Scan (7x7x7)/Cube 0:

Measurement grid: dx=5mm, dy=5mm, dz=5mm

Reference Value = 94.520 V/m; Power Drift = -0.02 dB

Peak SAR (extrapolated) = 17.0 W/kg

**SAR(1 g) = 9.73 W/kg; SAR(10 g) = 5.15 W/kg**

Maximum value of SAR (measured) = 12.2 W/kg

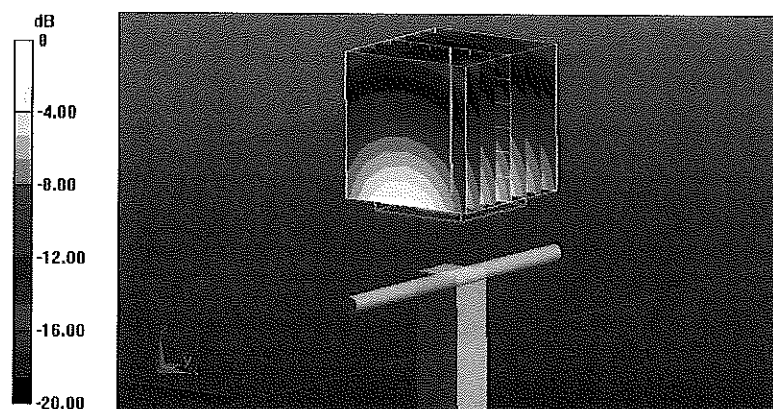

0 dB = 12.2 W/kg = 10.86 dBW/kg

# Impedance Measurement Plot for Body TSL

27 Feb 2014 09:42:04

CH1 S11 1 U FS

4: 47.971  $\Omega$  6.6777  $\Omega$  559.37 pF

1 900.000 000 MHz

\*  
De1

CA

Avg  
16

H1d

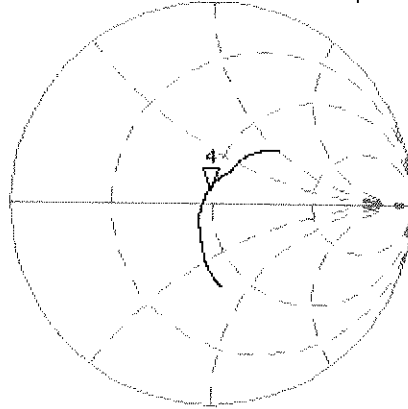

CH2 S11 LOG

5 dB/REF -20 dB

4:-22.970 dB 1 900.000 000 MHz

CA

Avg  
16

H1d

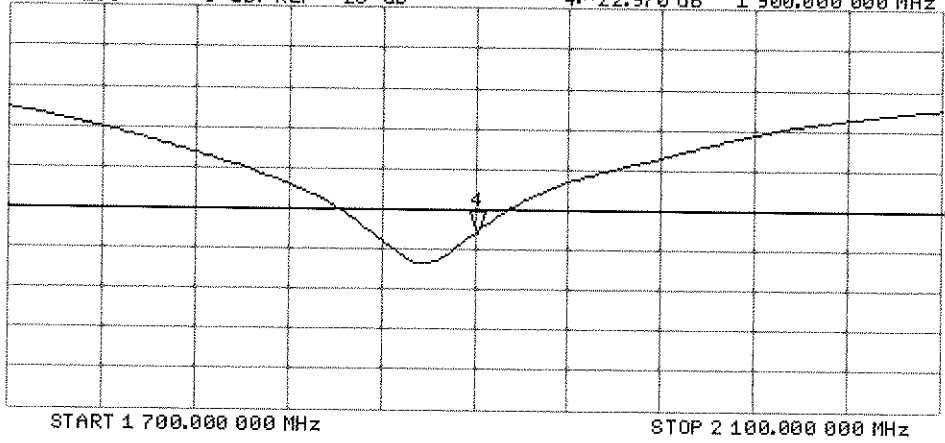

## APPENDIX D: SAR TISSUE SPECIFICATIONS

Measurement Procedure for Tissue verification:



- 1) The network analyzer and probe system was configured and calibrated.
- 2) The probe was immersed in the tissue. The tissue was placed in a nonmetallic container. Trapped air bubbles beneath the flange were minimized by placing the probe at a slight angle.
- 3) The complex admittance with respect to the probe aperture was measured
- 4) The complex relative permittivity  $\epsilon$  can be calculated from the below equation (Pournaropoulos and Misra):

$$Y = \frac{j2\omega\epsilon_r\epsilon_0}{[\ln(b/a)]^2} \int_a^b \int_a^b \int_0^\pi \cos\phi' \frac{\exp[-j\omega r(\mu_0\epsilon_r'\epsilon_0)^{1/2}]}{r} d\phi' d\rho' d\rho$$

where  $Y$  is the admittance of the probe in contact with the sample, the primed and unprimed coordinates refer to source and observation points, respectively,  $r^2 = \rho^2 + \rho'^2 - 2\rho\rho' \cos\phi'$ ,  $\omega$  is the angular frequency, and  $j = \sqrt{-1}$ .

**Table D-I  
Composition of the Tissue Equivalent Matter**

Frequency (MHz)	1900	1900
Tissue	Head	Body
Ingredients (% by weight)		
DGBE	44.92	29.44
NaCl	0.18	0.39
Water	54.9	70.17

FCC ID: A3LSPHL520		SAR EVALUATION REPORT		Reviewed by: Quality Manager
Test Dates: 07/07/14 - 07/09/14	DUT Type: Portable Handset			APPENDIX D: Page 1 of 1

## APPENDIX E: SAR SYSTEM VALIDATION



Per FCC KDB 865664 D02v01, SAR system validation status should be documented to confirm measurement accuracy. The SAR systems (including SAR probes, system components and software versions) used for this device were validated against its performance specifications prior to the SAR measurements. Reference dipoles were used with the required tissue- equivalent media for system validation, according to the procedures outlined in FCC KDB 865664 D01 v01 and IEEE 1528-2013. Since SAR probe calibrations are frequency dependent, each probe calibration point was validated at a frequency within the valid frequency range of the probe calibration point, using the system that normally operates with the probe for routine SAR measurements and according to the required tissue-equivalent media.

A tabulated summary of the system validation status including the validation date(s), measurement frequencies, SAR probes and tissue dielectric parameters has been included.

**Table E-I**  
**SAR System Validation Summary**

SAR SYSTEM #	FREQ. [MHz]	DATE	PROBE SN	PROBE TYPE	PROBE CAL. POINT		COND.	PERM.	CW VALIDATION			MOD. VALIDATION		
							( $\sigma$ )	( $\epsilon_r$ )	SENSI-TIVITY	PROBE LINEARITY	PROBE ISOTROPY	MOD. TYPE	DUTY FACTOR	PAR
B	1900	6/30/2014	3288	ES3DV3	1900	Head	1.434	40.35	PASS	PASS	PASS	GMSK	PASS	N/A
B	1900	6/28/2014	3288	ES3DV3	1900	Body	1.565	52.71	PASS	PASS	PASS	GMSK	PASS	N/A

NOTE: While the probes have been calibrated for both a CW and modulated signals, all measurements were performed using communication systems calibrated for CW signals only. Modulations in the table above represent test configurations for which the measurement system has been validated per FCC KDB Publication 865664 D01v01 for scenarios when CW probe calibrations are used with other signal types. SAR systems were validated for modulated signals with a periodic duty cycle, such as GMSK, according to KDB 865664.

FCC ID: A3LSPHL520	 <b>PCTEST</b> <small>ENGINEERING LABORATORY, INC.</small>	<b>SAR EVALUATION REPORT</b>		Reviewed by: Quality Manager
Test Dates: 07/07/14 - 07/09/14	DUT Type: Portable Handset	APPENDIX E: Page 1 of 1		