



SAR EVALUATION REPORT

Applicant Name:
 Samsung Electronics, Co. Ltd.
 129, Samsung-ro, Maetan dong,
 Yeongtong-gu, Suwon-si
 Gyeonggi-do 443-742, Korea

Date of Testing:
 07/01/13 - 07/19/13
Test Site/Location:
 PCTEST Lab, Columbia, MD, USA
Document Serial No.:
 0Y1306281121-R2.A3L

FCC ID: A3LSPHL520

APPLICANT: SAMSUNG ELECTRONICS, CO. LTD.

DUT Type: Portable Handset
Application Type: Certification
FCC Rule Part(s): CFR §2.1093
Model(s): SPH-L520

| Equipment Class | Band & Mode | Tx Frequency | Measured Conducted Power [dBm] | SAR | | |
|---|-----------------------|-----------------------|--------------------------------|------------------|-----------------------|-----------------------------|
| | | | | 1 gm Head (W/kg) | 1 gm Body-Worn (W/kg) | 1 gm Wireless Router (W/kg) |
| PCE | CDMA/EVDO BC10 (§90S) | 817.90 - 823.10 MHz | 25.00 | 0.59 | 1.03 | 1.08 |
| PCE | CDMA/EVDO BC0 (§22H) | 824.70 - 848.31 MHz | 24.93 | 0.65 | 1.01 | 0.97 |
| PCE | PCS CDMA/EVDO | 1851.25 - 1908.75 MHz | 24.92 | 0.97 | 1.06 | 0.95 |
| PCE | LTE Band 26 | 814.7 - 848.3 MHz | 23.04 | 0.42 | 0.53 | 0.65 |
| PCE | LTE Band 25 (PCS) | 1851.5 - 1913.5 MHz | 23.13 | 0.52 | 0.42 | 0.45 |
| PCE | LTE Band 41 | 2501 - 2685 MHz | 23.42 | 0.67 | 1.10 | 1.10 |
| DTS | 2.4 GHz WLAN | 2412 - 2462 MHz | 16.89 | < 0.1 | < 0.1 | < 0.1 |
| DTS | 5.8 GHz WLAN | 5745 - 5825 MHz | 11.99 | < 0.1 | < 0.1 | < 0.1 |
| NII | 5.2 GHz WLAN | 5180 - 5240 MHz | 11.81 | 0.10 | 0.21 | |
| NII | 5.3 GHz WLAN | 5260 - 5320 MHz | 11.93 | 0.12 | 0.28 | |
| NII | 5.5 GHz WLAN | 5500 - 5700 MHz | 11.92 | < 0.1 | 0.18 | |
| DSS/DTS | Bluetooth | 2402 - 2480 MHz | 9.60 | N/A | | |
| Simultaneous SAR per KDB 690783 D01v01r02: | | | | 1.08 | 1.37 | 1.17 |

Note: Powers in the above table represent output powers for the SAR test configurations and may not represent the highest output powers for all configurations for each mode.

This wireless portable device has been shown to be capable of compliance for localized specific absorption rate (SAR) for uncontrolled environment/general population exposure limits specified in ANSI/IEEE C95.1-1992 and has been tested in accordance with the measurement procedures specified in Section 1.8 of this report; for North American frequency bands only.

Note: This revised Test Report (S/N: 0Y1306281121-R2.A3L) supersedes and replaces the previously issued test report on the same subject device for the same type of testing as indicated. Please discard or destroy the previously issued test report(s) and dispose of it accordingly

I attest to the accuracy of data. All measurements reported herein were performed by me or were made under my supervision and are correct to the best of my knowledge and belief. I assume full responsibility for the completeness of these measurements and vouch for the qualifications of all persons taking them. Test results reported herein relate only to the item(s) tested.



Randy Ortanez
 President



| | | | | |
|---|---|--------------------------------------|--|--|
| FCC ID A3LSPHL520 | | SAR EVALUATION REPORT | | Reviewed by: Quality Manager |
| Document S/N: 0Y1306281121-R2.A3L | Test Dates: 07/01/13 - 07/19/13 | DUT Type: Portable Handset | | Page 1 of 60 |

T A B L E O F C O N T E N T S

| | | |
|---|--|----|
| 1 | DEVICE UNDER TEST | 3 |
| 2 | LTE INFORMATION | 9 |
| 3 | INTRODUCTION | 10 |
| 4 | DOSIMETRIC ASSESSMENT | 11 |
| 5 | DEFINITION OF REFERENCE POINTS | 12 |
| 6 | TEST CONFIGURATION POSITIONS FOR HANDSETS | 13 |
| 7 | RF EXPOSURE LIMITS | 17 |
| 8 | FCC MEASUREMENT PROCEDURES..... | 18 |
| 9 | RF CONDUCTED POWERS..... | 23 |
| 10 | SYSTEM VERIFICATION..... | 37 |
| 11 | SAR DATA SUMMARY | 40 |
| 12 | FCC MULTI-TX AND ANTENNA SAR CONSIDERATIONS..... | 49 |
| 13 | SAR MEASUREMENT VARIABILITY | 54 |
| 14 | EQUIPMENT LIST..... | 55 |
| 15 | MEASUREMENT UNCERTAINTIES | 56 |
| 16 | CONCLUSION..... | 58 |
| 17 | REFERENCES | 59 |
| APPENDIX A: SAR TEST PLOTS | | |
| APPENDIX B: SAR DIPOLE VERIFICATION PLOTS | | |
| APPENDIX C: PROBE AND DIPOLE CALIBRATION CERTIFICATES | | |
| APPENDIX D: SAR TISSUE SPECIFICATIONS | | |
| APPENDIX E: SAR SYSTEM VALIDATION | | |
| APPENDIX F: SAR TEST SETUP PHOTOGRAPHS | | |

| | | | | |
|---|---|--------------------------------------|---|--|
| FCC ID A3LSPHL520 |  | SAR EVALUATION REPORT |  | Reviewed by: Quality Manager |
| Document S/N: 0Y1306281121-R2.A3L | Test Dates: 07/01/13 - 07/19/13 | DUT Type: Portable Handset | Page 2 of 60 | |

1 DEVICE UNDER TEST

1.1 Device Overview



| Band & Mode | Operating Modes | Tx Frequency |
|-----------------------|-----------------|-----------------------|
| CDMA/EVDO BC10 (§90S) | Voice/Data | 817.90 - 823.10 MHz |
| CDMA/EVDO BC0 (§22H) | Voice/Data | 824.70 - 848.31 MHz |
| PCS CDMA/EVDO | Voice/Data | 1851.25 - 1908.75 MHz |
| LTE Band 26 | Data | 814.7 - 848.3 MHz |
| LTE Band 25 (PCS) | Data | 1851.5 - 1913.5 MHz |
| LTE Band 41 | Data | 2501 - 2685 MHz |
| 2.4 GHz WLAN | Data | 2412 - 2462 MHz |
| 5.8 GHz WLAN | Data | 5745 - 5825 MHz |
| 5.2 GHz WLAN | Data | 5180 - 5240 MHz |
| 5.3 GHz WLAN | Data | 5260 - 5320 MHz |
| 5.5 GHz WLAN | Data | 5500 - 5700 MHz |
| Bluetooth | Data | 2402 - 2480 MHz |
| NFC | Data | 13.56 MHz |

1.2 Nominal and Maximum Output Power Specifications

This device operates using the following maximum and nominal output power specifications. SAR values were scaled to the maximum allowed power to determine compliance per KDB Publication 447498 D01v05.

| Mode / Band | | Modulated Average (dBm) |
|-----------------------|---------|-------------------------|
| CDMA/EVDO BC10 (§90S) | Maximum | 25.0 |
| | Nominal | 24.5 |
| CDMA/EVDO BC0 (§22H) | Maximum | 25.0 |
| | Nominal | 24.5 |
| PCS CDMA/EVDO | Maximum | 25.0 |
| | Nominal | 24.5 |

| Mode / Band | | Modulated Average (dBm) |
|-------------------|---------|-------------------------|
| LTE Band 26 | Maximum | 23.5 |
| | Nominal | 23.0 |
| LTE Band 25 (PCS) | Maximum | 23.5 |
| | Nominal | 23.0 |
| LTE Band 41 | Maximum | 23.5 |
| | Nominal | 23.0 |

| | | | | |
|---|---|--------------------------------------|---|--|
| FCC ID A3LSPHL520 |  PCTEST ENGINEERING LABORATORY, INC. | SAR EVALUATION REPORT |  | Reviewed by: Quality Manager |
| Document S/N: 0Y1306281121-R2.A3L | Test Dates: 07/01/13 - 07/19/13 | DUT Type: Portable Handset | Page 3 of 60 | |

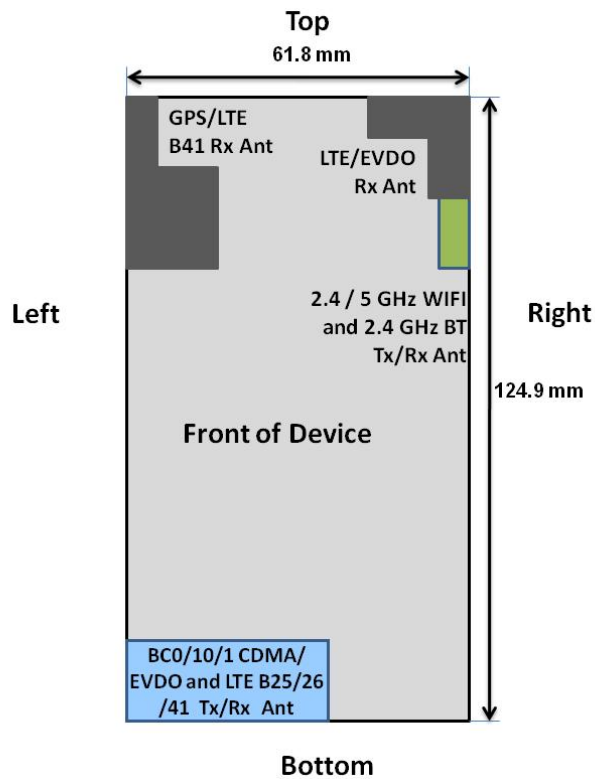

| Mode / Band | | Modulated Average (dBm) |
|-----------------------------|---------|-------------------------|
| IEEE 802.11b (2.4 GHz) | Maximum | 17.0 |
| | Nominal | 16.5 |
| IEEE 802.11g (2.4 GHz) | Maximum | 13.0 |
| | Nominal | 12.5 |
| IEEE 802.11n (2.4 GHz) | Maximum | 13.0 |
| | Nominal | 12.5 |
| IEEE 802.11a (5 GHz) | Maximum | 12.0 |
| | Nominal | 11.5 |
| IEEE 802.11n 20 MHz (5 GHz) | Maximum | 12.0 |
| | Nominal | 11.5 |
| IEEE 802.11n 40 MHz(5 GHz) | Maximum | 10.5 |
| | Nominal | 10.0 |
| Bluetooth | Maximum | 10.0 |
| | Nominal | 9.5 |
| Bluetooth LE | Maximum | 2.5 |
| | Nominal | 2.0 |

1.3 DUT Antenna Locations



Note: Exact antenna dimensions and separation distances are shown in the Technical Descriptions in the FCC Filing.

Figure 1-1
DUT Antenna Locations

| | | | | |
|---|---|--------------------------------------|---|--|
| FCC ID A3LSPHL520 |  PCTEST TECHNOLOGICAL LABORATORY, INC. | SAR EVALUATION REPORT |  | Reviewed by: Quality Manager |
| Document S/N: OY1306281121-R2.A3L | Test Dates: 07/01/13 - 07/19/13 | DUT Type: Portable Handset | Page 4 of 60 | |

**Table 1-1
Mobile Hotspot Sides for SAR Testing**

| Mobile Hotspot Sides for SAR Testing | | | | | | |
|--------------------------------------|------|-------|-----|--------|-------|------|
| Mode | Back | Front | Top | Bottom | Right | Left |
| EVDO BC10 (\$90S) | Yes | Yes | No | Yes | No | Yes |
| EVDO BC0 (\$22H) | Yes | Yes | No | Yes | No | Yes |
| PCS EVDO | Yes | Yes | No | Yes | No | Yes |
| LTE Band 26 | Yes | Yes | No | Yes | No | Yes |
| LTE Band 25 (PCS) | Yes | Yes | No | Yes | No | Yes |
| LTE Band 41 | Yes | Yes | No | Yes | No | Yes |
| 2.4 GHz WLAN | Yes | Yes | Yes | No | Yes | No |
| 5.8 GHz WLAN | Yes | Yes | Yes | No | Yes | No |



Note: Particular DUT edges were not required to be evaluated for Wireless Router SAR if the edges were greater than 2.5 cm from the transmitting antenna according to FCC KDB Publication 941225 D06v01 guidance, page 2. The antenna document shows the distances between the transmit antennas and the edges of the device. When the wireless router mode is enabled, all 5 GHz bands except 5.8 are disabled. Therefore only 5.8 GHz WLAN is considered in this section.

1.4 Near Field Communications (NFC) Antenna

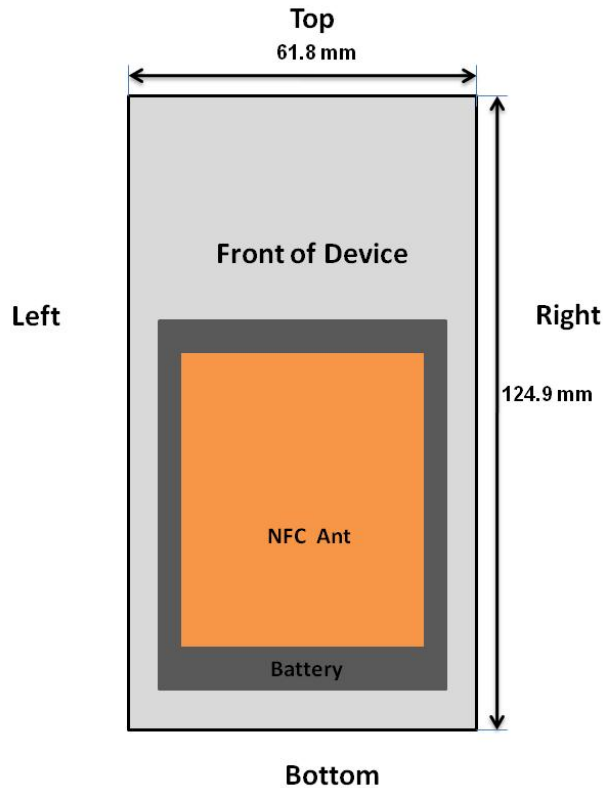
This DUT has NFC operations. The NFC antenna is integrated into the standard battery. The SAR tests were performed with the standard battery (model: B500BU).



**Figure 1-2
NFC Antenna Locations**

| | | | | |
|--------------------------------------|---|-------------------------------|---|---------------------------------|
| FCC ID A3LSPHL520 |  PCTEST <small>ENGINEERING LABORATORY, INC.</small> | SAR EVALUATION REPORT |  | Reviewed by: Quality Manager |
| Document S/N: 0Y1306281121-R2.A3L | Test Dates: 07/01/13 - 07/19/13 | DUT Type: Portable Handset | Page 5 of 60 | |

1.5 Simultaneous Transmission Capabilities

According to FCC KDB Publication 447498 D05v01, transmitters are considered to be transmitting simultaneously when there is overlapping transmission, with the exception of transmissions during network hand-offs with maximum hand-off duration less than 30 seconds. Possible transmission paths for the DUT are shown in Figure 1-3 and are color-coded to indicate communication modes which share the same path. Modes which share the same transmission path cannot transmit simultaneously with one another.



Figure 1-3
Simultaneous Transmission Paths

This device contains multiple transmitters that may operate simultaneously, and therefore requires a simultaneous transmission analysis according to FCC KDB Publication 447498 D01v05 3) procedures.

Table 1-2
Simultaneous Transmission Scenarios

| Ref. | Simultaneous Transmit Configurations | Head | Body-Worn Accessory | Hot Spot | Note |
|------|--|-------------------|---------------------|--------------------------------|--|
| | | IEEE 1528, Supp C | Supplement C | FCC KDB 941225 D06 edges/sides | |
| 1 | 1X CDMA BC0 Voice + 2.4/5 GHz WIFI | Yes | 10mm | N/A | 1x Voice and WiFi Data |
| 2 | 1X CDMA BC1 Voice + 2.4/5 GHz WIFI | Yes | 10mm | N/A | 1x Voice and WiFi Data |
| 3 | 1X CDMA BC10 Voice + 2.4/5 GHz WIFI | Yes | 10mm | N/A | 1x Voice and WiFi Data |
| 4 | 1X CDMA BC0 Voice + 2.4 GHz Bluetooth | N/A | 10mm | N/A | |
| 5 | 1X CDMA BC1 Voice + 2.4 GHz Bluetooth | N/A | 10mm | N/A | |
| 6 | 1X CDMA BC10 Voice + 2.4 GHz Bluetooth | N/A | 10mm | N/A | |
| 7 | 1X/EVDO BC0/BC1/BC10 Data + 2.4 GHz WIFI | Yes* | 10mm | Yes | 1X/EVDO Data + WiFi Hotspot |
| 8 | LTE B25 Data + 2.4 GHz WIFI | Yes* | 10mm | Yes | LTE + WiFi Hotspot |
| 9 | LTE B26 Data + 2.4 GHz WIFI | Yes* | 10mm | Yes | LTE + WiFi Hotspot |
| 10 | LTE B41 Data + 2.4 GHz WIFI | Yes* | 10mm | Yes | LTE + WiFi Hotspot |
| 11 | LTE B25 Data + 2.4 GHz Bluetooth | N/A | 10mm | N/A | |
| 12 | LTE B26 Data + 2.4 GHz Bluetooth | N/A | 10mm | N/A | |
| 13 | LTE B41 Data + 2.4 GHz Bluetooth | N/A | 10mm | N/A | |
| 14 | 1X/EVDO BC0/BC1/BC10 Data + 5.8 GHz WIFI | Yes* | 10mm | Yes | 1X/EVDO Data + WiFi Hotspot |
| 15 | LTE B25 Data + 5.8 GHz WIFI | Yes* | 10mm | Yes | LTE + WiFi Hotspot |
| 16 | LTE B26 Data + 5.8 GHz WIFI | Yes* | 10mm | Yes | LTE + WiFi Hotspot |
| 17 | LTE B41 Data + 5.8 GHz WIFI | Yes* | 10mm | Yes | LTE + WiFi Hotspot |
| 18 | 1X CDMA BC0 Voice + EVDO BC0/BC1/BC10 Data + 2.4 GHz WIFI | N/A | N/A | N/A | Not Supported by HW (Non-SVDO) |
| 19 | 1X CDMA BC1 Voice + EVDO BC0/BC1/BC10 Data + 2.4 GHz WIFI | N/A | N/A | N/A | Not Supported by HW (Non-SVDO) |
| 20 | 1X CDMA BC10 Voice + EVDO BC0/BC1/BC10 Data + 2.4 GHz WIFI | N/A | N/A | N/A | Not Supported by HW (Non-SVDO) |
| 21 | 1X CDMA BC0/BC1/BC10 Voice + LTE B25 Data + 5.2 - 5.7 GHz WIFI | N/A | N/A | N/A | 5.2-5.7 WiFi Hotspot Not supported by SW |
| 22 | 1X/EVDO BC0/BC1/BC10 Data + 5.2 - 5.7 GHz WIFI | N/A | N/A | N/A | 5.2-5.7 WiFi Hotspot Not supported by SW |
| 23 | LTE B25 Data + 5.2 - 5.7 GHz WIFI | N/A | N/A | N/A | 5.2-5.7 WiFi Hotspot Not supported by SW |
| 24 | LTE B26 Data + 5.2 - 5.7 GHz WIFI | N/A | N/A | N/A | 5.2-5.7 WiFi Hotspot Not supported by SW |
| 25 | LTE B41 Data + 5.2 - 5.7 GHz WIFI | N/A | N/A | N/A | 5.2-5.7 WiFi Hotspot Not supported by SW |
| 26 | EVDO BC0/BC1/BC10 Data + LTE B25 Data | N/A | N/A | N/A | Not supported by SW |
| 27 | EVDO BC0/BC1/BC10 Data + LTE B26 Data | N/A | N/A | N/A | Not supported by SW |
| 28 | EVDO BC0/BC1/BC10 Data + LTE B41 Data | N/A | N/A | N/A | Not supported by SW |

Notes:

1. CDMA and EVDO share the same antenna path and cannot transmit simultaneously. (Non-SVDO)
2. Bluetooth and 2.4 GHz WLAN share the same antenna path and cannot transmit simultaneously.

(*)=for VoIP 3rd party apps possibly installed and used by end-user

| | | | | |
|--------------------------------------|------------------------------------|-------------------------------|--|---------------------------------|
| FCC ID A3LSPHL520 | | SAR EVALUATION REPORT | | Reviewed by: Quality Manager |
| Document S/N: OY1306281121-R2.A3L | Test Dates: 07/01/13 - 07/19/13 | DUT Type: Portable Handset | | Page 6 of 60 |

1.6 SAR Test Exclusions Applied

(A) WIFI/BT

Since Wireless Router operations are not allowed by the chipset firmware using 5.2 - 5.7 GHz WIFI, only 2.4 and 5.8 GHz WIFI Hotspot SAR tests and combinations are considered for SAR with respect to Wireless Router configurations according to FCC KDB 941225 D06v01.

Per FCC KDB 447498 D01v05, the SAR exclusion threshold for distances <50mm is defined by the following equation:

$$\frac{\text{Max Power of Channel (mW)}}{\text{Test Separation Dist (mm)}} * \sqrt{\text{Frequency(GHz)}} \leq 3.0$$

Based on the maximum conducted power of Bluetooth (rounded to the nearest mW) and the antenna to user separation distance, Bluetooth SAR was not required; $[(10/10) * \sqrt{2.441}] = 1.6 < 3.0$. Per KDB Publication 447498 D01v05, the maximum power of the channel was rounded to the nearest mW before calculation.



Based on the maximum conducted power of Bluetooth LE (rounded to the nearest mW) and the antenna to user separation distance, Bluetooth LE SAR was not required; $[(1/10) * \sqrt{2.44}] = 0.3 < 3.0$. Per KDB Publication 447498 D01v05, the maximum power of the channel was rounded to the nearest mW before calculation.

This device supports 20 MHz and 40 MHz Bandwidths for IEEE 802.11n for 5 GHz WIFI only. IEEE 802.11n was not evaluated for SAR since the average output power of 20 MHz and 40 MHz bandwidths was not more than 0.25 dB higher than the average output power of IEEE 802.11a.

(B) Licensed Transmitter(s)

LTE SAR for the higher modulations and lower bandwidths were not tested since the maximum average output power of all required channels and configurations was not more than 0.5 dB higher than the highest bandwidth; and the reported LTE SAR for the highest bandwidth was less than 1.45 W/kg for all configurations according to FCC KDB 941225 D05v02.

CDMA 1X Advanced technology was not required for SAR since the maximum output powers for 1x Advanced was not more than 0.25 dB higher than the maximum measured powers for 1x and the measured SAR in any 1x mode exposure conditions was not greater than 1.2 W/kg.

| | | | | |
|--------------------------------------|---|-------------------------------|---|---------------------------------|
| FCC ID A3LSPHL520 |  | SAR EVALUATION REPORT |  | Reviewed by: Quality Manager |
| Document S/N: OY1306281121-R2.A3L | Test Dates: 07/01/13 - 07/19/13 | DUT Type: Portable Handset | | Page 7 of 60 |

1.7 Power Reduction for SAR

There is no power reduction used for any band/mode implemented in this device for SAR purposes.



1.8 Guidance Applied

- FCC OET Bulletin 65 Supplement C [June 2001]
- IEEE 1528-2003
- FCC KDB Publication 941225 D01-D06 (2G/3G/4G and Hotspot)
- FCC KDB Publication 248227 D01v01r02 (SAR Considerations for 802.11 Devices)
- FCC KDB Publication 447498 D01v05 (General SAR Guidance)
- FCC KDB Publication 865664 D01-D02 (SAR Measurements up to 6 GHz)

1.9 Device Serial Numbers

Several samples were used with identical hardware to support SAR testing. The manufacturer has confirmed that the device(s) tested have the same physical, mechanical and thermal characteristics and are within operational tolerances expected for production units.



| | Head Serial Number | Body-Worn Serial Number | Hotspot Serial Number |
|------------------------|--------------------|-------------------------|-----------------------|
| CDMA/EVDO BC10 (\$90S) | 051805a8 | 051805a8 | 051805a8 |
| CDMA/EVDO BC0 (\$22H) | 051805a8 | 051805a8 | 051805a8 |
| PCS CDMA/EVDO | 051804e0 | 051804e0 | 051804e0 |
| LTE Band 26 | 05180482 | 05180482 | 05180482 |
| LTE Band 25 (PCS) | 051805af | 051805af | 051805af |
| LTE Band 41 | 0518058e | 0518058e | 0518058e |
| 2.4 GHz WLAN | 051804e0 | 05180482 | 05180482 |
| 5 GHz WLAN | 051805a8 | 05180482 | 05180482 |

| | | | | |
|---|---|--------------------------------------|---|--|
| FCC ID A3LSPHL520 |  | SAR EVALUATION REPORT |  | Reviewed by: Quality Manager |
| Document S/N: 0Y1306281121-R2.A3L | Test Dates: 07/01/13 - 07/19/13 | DUT Type: Portable Handset | Page 8 of 60 | |

2

LTE INFORMATION

| LTE Information | | | | | |
|---|--|----------------|----------------|----------------|----------------|
| FCC ID | A3LSPHL520 | | | | |
| Form Factor | Portable Handset | | | | |
| Frequency Range of each LTE transmission band | LTE Band 26 (814.7 - 848.3 MHz) | | | | |
| | LTE Band 25 (PCS) (1851.5 - 1913.5 MHz) | | | | |
| | LTE Band 41 (2501 - 2685 MHz) | | | | |
| Channel Bandwidths | LTE Band 26: 1.4 MHz, 3 MHz, 5 MHz, 10 MHz | | | | |
| | LTE Band 25 (PCS): 3 MHz, 5 MHz, 10 MHz | | | | |
| | LTE Band 41: 10 MHz, 15 MHz, 20 MHz | | | | |
| Channel Numbers and Frequencies (MHz) | Low | Low-Mid | Mid | Mid-High | High |
| LTE Band 26: 1.4 MHz | 814.7 (26697) | | 831.5 (26865) | | 848.3 (27033) |
| LTE Band 26: 3 MHz | 815.5 (26705) | | 831.5 (26865) | | 847.5 (27025) |
| LTE Band 26: 5 MHz | 816.5 (26715) | | 831.5 (26865) | | 846.5 (27015) |
| LTE Band 26: 10 MHz | 819 (26740) | | 831.5 (26865) | | 844 (26990) |
| LTE Band 25 (PCS): 3 MHz | 1851.5 (26055) | | 1882.5 (26365) | | 1913.5 (26675) |
| LTE Band 25 (PCS): 5 MHz | 1852.5 (26065) | | 1882.5 (26365) | | 1912.5 (26665) |
| LTE Band 25 (PCS): 10 MHz | 1855 (26090) | | 1882.5 (26365) | | 1910 (26640) |
| LTE Band 41: 10 MHz | 2501 (39700) | 2547 (40160) | 2593 (40620) | 2639 (41080) | 2685 (41540) |
| LTE Band 41: 15 MHz | 2503.5 (39725) | 2548.3 (40173) | 2593 (40620) | 2637.8 (41068) | 2682.5 (41515) |
| LTE Band 41: 20 MHz | 2506 (39750) | 2549.5 (40185) | 2593 (40620) | 2636.5 (41055) | 2680 (41490) |
| UE Category | 3 | | | | |
| Modulations Supported in UL | QPSK, 16QAM | | | | |
| LTE MPR Permanently implemented per 3GPP TS 36.101 section 6.2.3~6.2.5? (manufacturer attestation to be provided) | YES | | | | |
| A-MPR (Additional MPR) disabled for SAR | YES | | | | |

| | | | | |
|---|---|--------------------------------------|---|--|
| FCC ID A3LSPHL520 |  | SAR EVALUATION REPORT |  | Reviewed by: Quality Manager |
| Document S/N: OY1306281121-R2.A3L | Test Dates: 07/01/13 - 07/19/13 | DUT Type: Portable Handset | Page 9 of 60 | |

3 INTRODUCTION

The FCC and Industry Canada have adopted the guidelines for evaluating the environmental effects of radio frequency (RF) radiation in ET Docket 93-62 on Aug. 6, 1996 and Health Canada Safety Code 6 to protect the public and workers from the potential hazards of RF emissions due to FCC-regulated portable devices. [1]

The safety limits used for the environmental evaluation measurements are based on the criteria published by the American National Standards Institute (ANSI) for localized specific absorption rate (SAR) in IEEE/ANSI C95.1-1992 Standard for Safety Levels with Respect to Human Exposure to Radio Frequency Electromagnetic Fields, 3 kHz to 300 GHz [3] and Health Canada RF Exposure Guidelines Safety Code 6 [24]. The measurement procedure described in IEEE/ANSI C95.3-2002 Recommended Practice for the Measurement of Potentially Hazardous Electromagnetic Fields - RF and Microwave [4] is used for guidance in measuring the Specific Absorption Rate (SAR) due to the RF radiation exposure from the Equipment Under Test (EUT). These criteria for SAR evaluation are similar to those recommended by the International Committee for Non-Ionizing Radiation Protection (ICNIRP) in Biological Effects and Exposure Criteria for Radiofrequency Electromagnetic Fields,” Report No. Vol 74. SAR is a measure of the rate of energy absorption due to exposure to an RF transmitting source. SAR values have been related to threshold levels for potential biological hazards.

3.1 SAR Definition

Specific Absorption Rate is defined as the time derivative (rate) of the incremental energy (dU) absorbed by (dissipated in) an incremental mass (dm) contained in a volume element (dV) of a given density (ρ). It is also defined as the rate of RF energy absorption per unit mass at a point in an absorbing body (see Equation 3-1).

**Equation 3-1
SAR Mathematical Equation**

$$SAR = \frac{d}{dt} \left(\frac{dU}{dm} \right) = \frac{d}{dt} \left(\frac{dU}{\rho dv} \right)$$



SAR is expressed in units of Watts per Kilogram (W/kg).

$$SAR = \frac{\sigma \cdot E^2}{\rho}$$

where:

- σ = conductivity of the tissue-simulating material (S/m)
- ρ = mass density of the tissue-simulating material (kg/m³)
- E = Total RMS electric field strength (V/m)

NOTE: The primary factors that control rate of energy absorption were found to be the wavelength of the incident field in relation to the dimensions and geometry of the irradiated organism, the orientation of the organism in relation to the polarity of field vectors, the presence of reflecting surfaces, and whether conductive contact is made by the organism with a ground plane.[6]

| | | | | |
|---|---|--------------------------------------|---|--|
| FCC ID A3LSPHL520 |  PCTEST ENGINEERING LABORATORY, INC. | SAR EVALUATION REPORT |  | Reviewed by: Quality Manager |
| Document S/N: 0Y1306281121-R2.A3L | Test Dates: 07/01/13 - 07/19/13 | DUT Type: Portable Handset | Page 10 of 60 | |

4 DOSIMETRIC ASSESSMENT

4.1 Measurement Procedure

The evaluation was performed using the following procedure:

1. The SAR distribution at the exposed side of the head or body was measured at a distance no greater than 5.0 mm from the inner surface of the shell. The area covered the entire dimension of the device-head and body interface and the horizontal grid resolution was determined per FCC KDB Publication 865664 D01v01 (See Table 4-1).
2. The point SAR measurement was taken at the maximum SAR region determined from Step 1 to enable the monitoring of SAR fluctuations/drifts during the 1g/10g cube evaluation. SAR at this fixed point was measured and used as a reference value.
3. Based on the area scan data, the peak of the region with maximum SAR was determined by spline interpolation. Around this point, a volume was assessed according to the measurement resolution and volume size requirements of FCC KDB Publication 865664 D01v01 (See Table 4-1). On the basis of this data set, the spatial peak SAR value was evaluated with the following procedure (see references or the DASy manual online for more details):
 - a. The data was extrapolated to the surface of the outer-shell of the phantom. The combined distance extrapolated was the combined distance from the center of the dipoles 2.7mm away from the tip of the probe housing plus the 1.2 mm distance between the surface and the lowest measuring point. The extrapolation was based on a least-squares algorithm. A polynomial of the fourth order was calculated through the points in the z-axis (normal to the phantom shell).
 - b. After the maximum interpolated values were calculated between the points in the cube, the SAR was averaged over the spatial volume (1g or 10g) using a 3D-Spline interpolation algorithm. The 3D-spline is composed of three one-dimensional splines with the “Not a knot” condition (in x, y, and z directions). The volume was then integrated with the trapezoidal algorithm. One thousand points (10 x 10 x 10) were obtained through interpolation, in order to calculate the averaged SAR.
 - c. All neighboring volumes were evaluated until no neighboring volume with a higher average value was found.
4. The SAR reference value, at the same location as step 2, was re-measured after the zoom scan was complete to calculate the SAR drift. If the drift deviated by more than 5%, the SAR test and drift measurements were repeated.

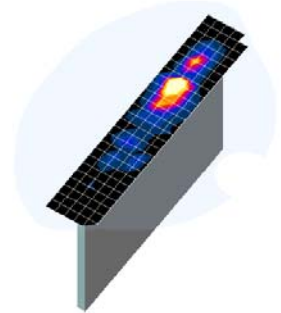



Figure 4-1
Sample SAR Area Scan

Table 4-1
Area and Zoom Scan Resolutions per FCC KDB Publication 865664 D01v01

| Frequency | Maximum Area Scan Resolution (mm) ($\Delta x_{area}, \Delta y_{area}$) | Maximum Zoom Scan Resolution (mm) ($\Delta x_{zoom}, \Delta y_{zoom}$) | Maximum Zoom Scan Spatial Resolution (mm) | | | Minimum Zoom Scan Volume (mm) (x,y,z) |
|-----------|---|---|---|------------------------|-------------------------------|--|
| | | | Uniform Grid | Graded Grid | | |
| | | | $\Delta z_{zoom}(n)$ | $\Delta z_{zoom}(1)^*$ | $\Delta z_{zoom}(n>1)^*$ | |
| ≤ 2 GHz | ≤ 15 | ≤ 8 | ≤ 5 | ≤ 4 | ≤ 1.5* $\Delta z_{zoom}(n-1)$ | ≥ 30 |
| 2-3 GHz | ≤ 12 | ≤ 5 | ≤ 5 | ≤ 4 | ≤ 1.5* $\Delta z_{zoom}(n-1)$ | ≥ 30 |
| 3-4 GHz | ≤ 12 | ≤ 5 | ≤ 4 | ≤ 3 | ≤ 1.5* $\Delta z_{zoom}(n-1)$ | ≥ 28 |
| 4-5 GHz | ≤ 10 | ≤ 4 | ≤ 3 | ≤ 2.5 | ≤ 1.5* $\Delta z_{zoom}(n-1)$ | ≥ 25 |
| 5-6 GHz | ≤ 10 | ≤ 4 | ≤ 2 | ≤ 2 | ≤ 1.5* $\Delta z_{zoom}(n-1)$ | ≥ 22 |

| | | | | |
|---|---|--------------------------------------|---|--|
| FCC ID A3LSPHL520 |  | SAR EVALUATION REPORT |  | Reviewed by: Quality Manager |
| Document S/N: OY1306281121-R2.A3L | Test Dates: 07/01/13 - 07/19/13 | DUT Type: Portable Handset | Page 11 of 60 | |

5

DEFINITION OF REFERENCE POINTS

5.1 EAR REFERENCE POINT

Figure 5-2 shows the front, back and side views of the SAM Twin Phantom. The point “M” is the reference point for the center of the mouth, “LE” is the left ear reference point (ERP), and “RE” is the right ERP. The ERP is 15mm posterior to the entrance to the ear canal (EEC) along the B-M line (Back-Mouth), as shown in Figure 5-1. The plane passing through the two ear canals and M is defined as the Reference Plane. The line N-F (Neck-Front) is perpendicular to the reference plane and passing through the RE (or LE) is called the Reference Pivoting Line (see Figure 5-1). Line B-M is perpendicular to the N-F line. Both N-F and B-M lines are marked on the external phantom shell to facilitate handset positioning [5].

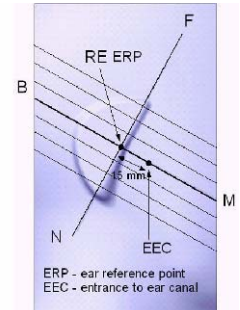

Figure 5-1
Close-Up Side view of ERP

5.2 HANDSET REFERENCE POINTS

Two imaginary lines on the handset were established: the vertical centerline and the horizontal line. The test device was placed in a normal operating position with the “test device reference point” located along the “vertical centerline” on the front of the device aligned to the “ear reference point” (See Figure 5-3). The “test device reference point” was then located at the same level as the center of the ear reference point. The test device was positioned so that the “vertical centerline” was bisecting the front surface of the handset at its top and bottom edges, positioning the “ear reference point” on the outer surface of the both the left and right head phantoms on the ear reference point.



Figure 5-2
Front, back and side view of SAM Twin Phantom

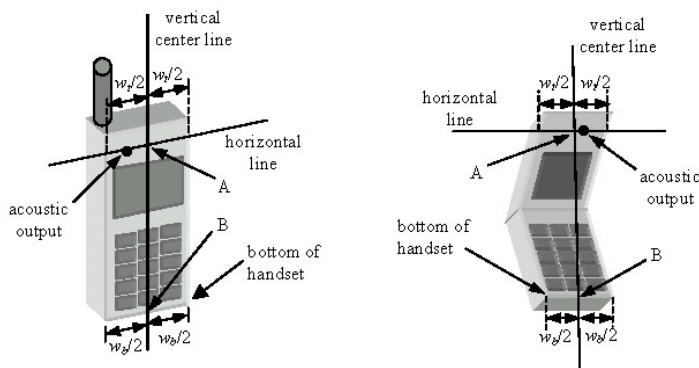



Figure 5-3
Handset Vertical Center & Horizontal Line Reference Points

| | | | | |
|--------------------------------------|--|-------------------------------|---|---------------------------------|
| FCC ID A3LSPHL520 |  PCTEST ENGINEERING LABORATORY, INC. | SAR EVALUATION REPORT |  SAMSUNG | Reviewed by: Quality Manager |
| Document S/N: OY1306281121-R2.A3L | Test Dates: 07/01/13 - 07/19/13 | DUT Type: Portable Handset | | Page 12 of 60 |

6 TEST CONFIGURATION POSITIONS FOR HANDSETS

6.1 Device Holder

The device holder is made out of low-loss POM material having the following dielectric parameters: relative permittivity $\epsilon = 3$ and loss tangent $\delta = 0.02$.

6.2 Positioning for Cheek

1. The test device was positioned with the device close to the surface of the phantom such that point A is on the (virtual) extension of the line passing through points RE and LE on the phantom (see Figure 6-1), such that the plane defined by the vertical center line and the horizontal line of the phone is approximately parallel to the sagittal plane of the phantom.

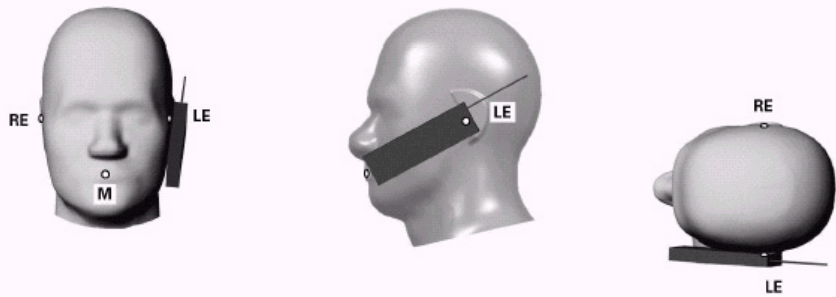



Figure 6-1 Front, Side and Top View of Cheek Position

2. The handset was translated towards the phantom along the line passing through RE & LE until the handset touches the ear.
3. While maintaining the handset in this plane, the handset was rotated around the LE-RE line until the vertical centerline was in the plane normal to MB-NF including the line MB (reference plane).
4. The phone was then rotated around the vertical centerline until the phone (horizontal line) was symmetrical with respect to the line NF.
5. While maintaining the vertical centerline in the reference plane, keeping point A on the line passing through RE and LE, and maintaining the device contact with the ear, the device was rotated about the NF line until any point on the handset made contact with a phantom point below the ear (cheek) (See Figure 6-2).

6.3 Positioning for Ear / 15° Tilt

With the test device aligned in the “Cheek Position”:

1. While maintaining the orientation of the phone, the phone was retracted parallel to the reference plane far enough to enable a rotation of the phone by 15 degrees.
2. The phone was then rotated around the horizontal line by 15 degrees.
3. While maintaining the orientation of the phone, the phone was moved parallel to the reference plane until any part of the handset touched the head. (In this position, point A was located on the line RE-LE). The tilted position is obtained when the contact is on the pinna. If the contact was at any location other than the pinna, the angle of the phone would then be reduced. The tilted position was obtained when any part of the phone was in contact of the ear as well as a second part of the phone was in contact with the head (see Figure 6-2).

| | | | | |
|--------------------------------------|--|-------------------------------|---|---------------------------------|
| FCC ID A3LSPHL520 |  PCTEST ENGINEERING LABORATORY, INC. | SAR EVALUATION REPORT |  | Reviewed by: Quality Manager |
| Document S/N: OY1306281121-R2.A3L | Test Dates: 07/01/13 - 07/19/13 | DUT Type: Portable Handset | | Page 13 of 60 |

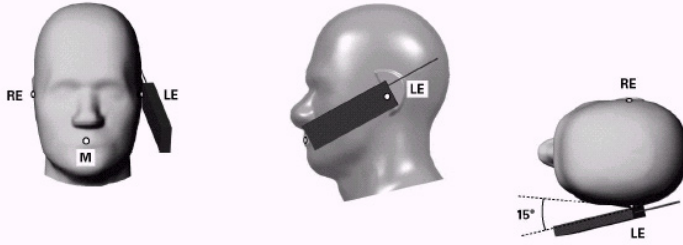

Figure 6-2 Front, Side and Top View of Ear/15° Tilt Position

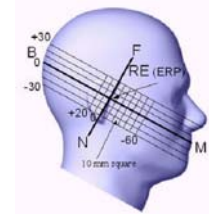

Figure 6-3 Side view w/ relevant markings

6.4 SAR Evaluations near the Mouth/Jaw Regions of the SAM Phantom

Antennas located near the bottom of a phone may require SAR measurements around the mouth and jaw regions of the SAM head phantom. This typically applies to clam-shell style phones that are generally longer in the unfolded normal use positions or to certain older style long rectangular phones.

Under these circumstances, the following procedures apply, adopted from the FCC guidance on SAR handsets document FCC KDB Publication 648474 D04_v01. The SAR required in these regions of SAM should be measured using a flat phantom. The phone should be positioned with a separation distance of 4 mm between the ear reference point (ERP) and the outer surface of the flat phantom shell. While maintaining this distance at the ERP location, the low (bottom) edge of the phone should be lowered from the phantom to establish the same separation distance between the peak SAR location identified by the truncated partial SAR distribution measured with the SAM phantom. The distance from the peak SAR location to the phone is determined by the straight line passing perpendicularly through the phantom surface. When it is not feasible to maintain 4 mm separation at the ERP while also establishing the required separation at the peak SAR location, the top edge of the phone will be allowed to touch the phantom with a separation < 4 mm at the ERP. The phone should not be tilted to the left or right while placed in this inclined position to the flat phantom.

The latest IEEE 1528 committee developments propose the usage of a tilted phantom when the antenna of the phone is mounted at the bottom or in all cases the peak absorption is in the chin region. Both SAM heads of the TwinSAM-Chin20 are rotated 20 degrees around the NF line. Each head can be removed individually from the table for emptying and cleaning.

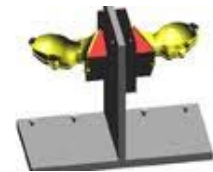



Figure 6-4 Twin SAM Chin20

| | | | | |
|---|---|--------------------------------------|---|--|
| FCC ID A3LSPHL520 |  PCTEST ENGINEERING LABORATORY, INC. | SAR EVALUATION REPORT |  | Reviewed by: Quality Manager |
| Document S/N: OY1306281121-R2.A3L | Test Dates: 07/01/13 - 07/19/13 | DUT Type: Portable Handset | Page 14 of 60 | |

6.5 Body-Worn Accessory Configurations

Body-worn operating configurations are tested with the belt-clips and holsters attached to the device and positioned against a flat phantom in a normal use configuration (see Figure 6-5). Per FCC KDB Publication 648474 D04v01, Body-worn accessory exposure is typically related to voice mode operations when handsets are carried in body-worn accessories. The body-worn accessory procedures in FCC KDB Publication 447498 D01v05 should be used to test for body-worn accessory SAR compliance, without a headset connected to it. This enables the test results for such configuration to be compatible with that required for hotspot mode when the body-worn accessory test separation distance is greater than or equal to that required for hotspot mode, when applicable. When the reported SAR for a body-worn accessory, measured without a headset connected to the handset, is $> 1.2 \text{ W/kg}$, the highest reported SAR configuration for that wireless mode and frequency band should be repeated for that body-worn accessory with a headset attached to the handset.

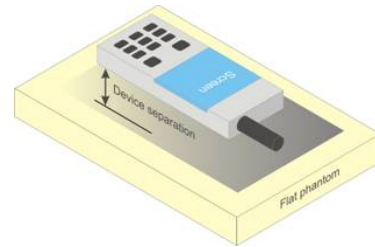

Figure 6-5
Sample Body-Worn Diagram



Accessories for Body-worn operation configurations are divided into two categories: those that do not contain metallic components and those that do contain metallic components. When multiple accessories that do not contain metallic components are supplied with the device, the device is tested with only the accessory that dictates the closest spacing to the body. Then multiple accessories that contain metallic components are tested with the device with each accessory. If multiple accessories share an identical metallic component (i.e. the same metallic belt-clip used with different holsters with no other metallic components) only the accessory that dictates the closest spacing to the body is tested.

Body-worn accessories may not always be supplied or available as options for some devices intended to be authorized for body-worn use. In this case, a test configuration with a separation distance between the back of the device and the flat phantom is used. Test position spacing was documented. Transmitters that are designed to operate in front of a person's face, as in push-to-talk configurations, are tested for SAR compliance with the front of the device positioned to face the flat phantom in head fluid. For devices that are carried next to the body such as a shoulder, waist or chest-worn transmitters, SAR compliance is tested with the accessories, including headsets and microphones, attached to the device and positioned against a flat phantom in a normal use configuration.

6.6 Extremity Exposure Configurations

Devices that are designed or intended for use on extremities or mainly operated in extremity only exposure conditions; i.e., hands, wrists, feet and ankles, may require extremity SAR evaluation. When the device also operates in close proximity to the user's body, SAR compliance for the body is also required. The 1-g body and 10-g extremity SAR Exclusion Thresholds found in KDB Publication 44798 D01v05 should be applied to determine SAR test requirements.



Per KDB Publication 44798 D01v05, Cell phones (handsets) are not normally designed to be used on extremities or operated in extremity only exposure conditions. The maximum output power levels of handsets generally do not require extremity SAR testing to show compliance. Therefore, extremity SAR was not evaluated for this device.

| | | | | |
|---|---|--------------------------------------|---|--|
| FCC ID A3LSPHL520 |  | SAR EVALUATION REPORT |  | Reviewed by: Quality Manager |
| Document S/N: OY1306281121-R2.A3L | Test Dates: 07/01/13 - 07/19/13 | DUT Type: Portable Handset | Page 15 of 60 | |

6.7 Wireless Router Configurations

Some battery-operated handsets have the capability to transmit and receive user data through simultaneous transmission of WIFI simultaneously with a separate licensed transmitter. The FCC has provided guidance in FCC KDB Publication 941225 D06 v01 where SAR test considerations for handsets ($L \times W \geq 9 \text{ cm} \times 5 \text{ cm}$) are based on a composite test separation distance of 10 mm from the front, back and edges of the device containing transmitting antennas within 2.5 cm of their edges, determined from general mixed use conditions for this type of devices. Since the hotspot SAR results may overlap with the body-worn accessory SAR requirements, the more conservative configurations can be considered, thus excluding some body-worn accessory SAR tests.

When the user enables the personal wireless router functions for the handset, actual operations include simultaneous transmission of both the WIFI transmitter and another licensed transmitter. Both transmitters often do not transmit at the same transmitting frequency and thus cannot be evaluated for SAR under actual use conditions due to the limitations of the SAR assessment probes. Therefore, SAR must be evaluated for each frequency transmission and mode separately and spatially summed with the WIFI transmitter according to FCC KDB Publication 447498 D01v05 publication procedures. The "Portable Hotspot" feature on the handset was NOT activated during SAR assessments, to ensure the SAR measurements were evaluated for a single transmission frequency RF signal at a time.

| | | | |
|---|---|--|--|
| FCC ID A3LSPHL520 |  | SAR EVALUATION REPORT  | Reviewed by: Quality Manager |
| Document S/N: 0Y1306281121-R2.A3L | Test Dates: 07/01/13 - 07/19/13 | DUT Type: Portable Handset | Page 16 of 60 |

7 RF EXPOSURE LIMITS

7.1 Uncontrolled Environment

UNCONTROLLED ENVIRONMENTS are defined as locations where there is the exposure of individuals who have no knowledge or control of their exposure. The general population/uncontrolled exposure limits are applicable to situations in which the general public may be exposed or in which persons who are exposed as a consequence of their employment may not be made fully aware of the potential for exposure or cannot exercise control over their exposure. Members of the general public would come under this category when exposure is not employment-related; for example, in the case of a wireless transmitter that exposes persons in its vicinity.



7.2 Controlled Environment

CONTROLLED ENVIRONMENTS are defined as locations where there is exposure that may be incurred by persons who are aware of the potential for exposure, (i.e. as a result of employment or occupation). In general, occupational/controlled exposure limits are applicable to situations in which persons are exposed as a consequence of their employment, who have been made fully aware of the potential for exposure and can exercise control over their exposure. This exposure category is also applicable when the exposure is of a transient nature due to incidental passage through a location where the exposure levels may be higher than the general population/uncontrolled limits, but the exposed person is fully aware of the potential for exposure and can exercise control over his or her exposure by leaving the area or by some other appropriate means.

**Table 7-1
SAR Human Exposure Specified in ANSI/IEEE C95.1-1992 and Health Canada Safety Code 6**

| HUMAN EXPOSURE LIMITS | | |
|---|---|---|
| | UNCONTROLLED ENVIRONMENT <i>General Population</i> (W/kg) or (mW/g) | CONTROLLED ENVIRONMENT <i>Occupational</i> (W/kg) or (mW/g) |
| Peak Spatial Average SAR Head | 1.6 | 8.0 |
| Whole Body SAR | 0.08 | 0.4 |
| Peak Spatial Average SAR Hands, Feet, Ankle, Wrists, etc. | 4.0 | 20 |

1. The Spatial Peak value of the SAR averaged over any 1 gram of tissue (defined as a tissue volume in the shape of a cube) and over the appropriate averaging time.
2. The Spatial Average value of the SAR averaged over the whole body.
3. The Spatial Peak value of the SAR averaged over any 10 grams of tissue (defined as a tissue volume in the shape of a cube) and over the appropriate averaging time.

| | | | | |
|---|---|--------------------------------------|---|--|
| FCC ID A3LSPHL520 |  | SAR EVALUATION REPORT |  | Reviewed by: Quality Manager |
| Document S/N: OY1306281121-R2.A3L | Test Dates: 07/01/13 - 07/19/13 | DUT Type: Portable Handset | Page 17 of 60 | |

8 FCC MEASUREMENT PROCEDURES

Power measurements were performed using a base station simulator under digital average power.

8.1 Measured and Reported SAR

Per FCC KDB Publication 447498 D01v05, When SAR is not measured at the maximum power level allowed for production units, the results must be scaled to the maximum tune-up tolerance limit according to the power applied to the individual channels tested to determine compliance. For simultaneous transmission, the measured aggregate SAR must be scaled according to the sum of the differences between the maximum tune-up tolerance and actual power used to test each transmitter. When SAR is measured at or scaled to the maximum tune-up tolerance limit, the results are referred to as *reported* SAR. The highest *reported* SAR results are identified on the grant of equipment authorization according to procedures in KDB 690783 D01v01r02.

8.2 Procedures Used to Establish RF Signal for SAR

The following procedures are according to FCC KDB Publication 941225 D01 "SAR Measurement Procedures for 3G Devices" v02, October 2007.

The device was placed into a simulated call using a base station simulator in a RF shielded chamber. Establishing connections in this manner ensure a consistent means for testing SAR and are recommended for evaluating SAR [4]. Devices under test were evaluated prior to testing, with a fully charged battery and were configured to operate at maximum output power. In order to verify that the device was tested throughout the SAR test at maximum output power, the SAR measurement system measures a "point SAR" at an arbitrary reference point at the start and end of the 1 gram SAR evaluation, to assess for any power drifts during the evaluation. If the power drift deviated by more than 5%, the SAR test and drift measurements were repeated.



8.3 SAR Measurement Conditions for CDMA2000

The following procedures were performed according to FCC KDB Publication 941225 D01 "SAR Measurement Procedures for 3G Devices" v02, October 2007.

8.3.1 Output Power Verification

See 3GPP2 C.S0011/TIA-98-E as recommended by "SAR Measurement Procedures for 3G Devices" v02, October 2007. Maximum output power is verified on the High, Middle and Low channels according to procedures in section 4.4.5.2 of 3GPP2 C.S0011/TIA-98-E. SO55 tests were measured with power control bits in the "All Up" condition.

1. If the mobile station (MS) supports Reverse TCH RC 1 and Forward TCH RC 1, set up a call using Fundamental Channel Test Mode 1 (RC=1/1) with 9600 bps data rate only.
2. Under RC1, C.S0011 Table 4.4.5.2-1, Table 8-1 parameters were applied.
3. If the MS supports the RC 3 Reverse FCH, RC3 Reverse SCH₀ and demodulation of RC 3,4, or 5, set up a call using Supplemental Channel Test Mode 3 (RC 3/3) with 9600 bps Fundamental Channel and 9600 bps SCH₀ data rate.
4. Under RC3, C.S0011 Table 4.4.5.2-2, Table 8-2 was applied.

| | | | | |
|--------------------------------------|---|-------------------------------|---|---------------------------------|
| FCC ID A3LSPHL520 |  | SAR EVALUATION REPORT |  | Reviewed by: Quality Manager |
| Document S/N: OY1306281121-R2.A3L | Test Dates: 07/01/13 - 07/19/13 | DUT Type: Portable Handset | | Page 18 of 60 |

**Table 8-1
Parameters for Max. Power for RC1**

| Parameter | Units | Value |
|------------------------------|--------------|-------|
| I_{or} | dBm/1.23 MHz | -104 |
| $\frac{Pilot E_c}{I_{or}}$ | dB | -7 |
| $\frac{Traffic E_c}{I_{or}}$ | dB | -7.4 |

**Table 8-2
Parameters for Max. Power for RC3**

| Parameter | Units | Value |
|------------------------------|--------------|-------|
| I_{or} | dBm/1.23 MHz | -86 |
| $\frac{Pilot E_c}{I_{or}}$ | dB | -7 |
| $\frac{Traffic E_c}{I_{or}}$ | dB | -7.4 |

5. FCHs were configured at full rate for maximum SAR with “All Up” power control bits.

8.3.2 Head SAR Measurements

SAR for head exposure configurations is measured in RC3 with the DUT configured to transmit at full rate using Loopback Service Option SO55. SAR for RC1 is not required when the maximum average output of each channel is less than ¼ dB higher than that measured in RC3. Otherwise, SAR is measured on the maximum output channel in RC1 using the exposure configuration that results in the highest SAR for that channel in RC3.

Head SAR was additionally evaluated using EVDO Rev. A to support compliance for VoIP operations. See Section 8.3.5 for EVDO Rev. A configuration parameters.

8.3.3 CDMA2000 1x Advanced



This device additionally supports 1x Advanced. Conducted powers were measured using SO75 with RC8 on the uplink and RC11 on the downlink per FCC KDB Publication 941225 D02 v02. Smart blanking was disabled for all measurements. The EUT was configured with forward power control Mode 000 and reverse power control at 400 bps. Conducted powers were measured on an Agilent 8960 Series 10 Wireless Communications Test Set, Model E5515C using the CDMA2000 1x Advanced application, Option E1962B-410.

Based on the maximum output power measured for 1x Advanced, SAR is required for 1x advanced when if the maximum output for 1x Advanced is more than 0.25 dB higher than the maximum measured for 1x. Also, if the measured SAR in any 1x mode exposure conditions (head, body etc.) is larger than 1.2 W/kg, the highest of those configurations above 1.2 W/kg for each exposure condition in 1x Advanced has to be repeated. All measured SAR in 1x mode higher than 1.5 W/kg must be repeated for 1x Advanced.

8.3.4 Body SAR Measurements

SAR for body exposure configurations is measured in RC3 with the DUT configured to transmit at full rate on FCH with all other code channels disabled using TDSO / SO32. SAR for multiple code channels (FCH + SCH_n) is not required when the maximum average output of each RF channel is less than ¼ dB higher than that measured with FCH only. Otherwise, SAR is measured on the maximum output channel (FCH + SCH_n) with FCH at full rate and SCH₀ enabled at 9600 bps using the exposure configuration that results in the highest SAR for that channel with FCH only. When multiple code channels are enabled, the DUT output may shift by more than 0.5 dB and lead to higher SAR drifts and SCH dropouts. Body SAR was measured using TDSO / SO32 with power control bits in the “All Up”

Body SAR in RC1 is not required when the maximum average output of each channel is less than ¼ dB higher than that measured in RC3. Otherwise, SAR is measured on the maximum output channel in RC1; with Loopback Service Option SO55, at full rate, using the body exposure configuration that results in the highest SAR for that channel in RC3.

| | | | | |
|---|---|--------------------------------------|---|--|
| FCC ID A3LSPHL520 |  PCTEST ENGINEERING LABORATORY, INC. | SAR EVALUATION REPORT |  | Reviewed by: Quality Manager |
| Document S/N: OY1306281121-R2.A3L | Test Dates: 07/01/13 - 07/19/13 | DUT Type: Portable Handset | Page 19 of 60 | |

8.3.5 Handsets with EVDO

For handsets with Ev-Do capabilities, when the maximum average output of each channel in Rev. 0 is less than ¼ dB higher than that measured in RC3 (1x RTT), body SAR for EV-DO is not required. Otherwise, SAR for Rev. 0 is measured on the maximum output channel at 153.6 kbps using the body exposure configuration that results in the highest SAR for that channel in RC3. SAR for Rev. A is not required when the maximum average output of each channel is less than that measured in Rev. 0 or less than ¼ dB higher than that measured in RC3. Otherwise, SAR is measured on the maximum output channel for Rev. A using a Reverse Data Channel payload size of 4096 bits and a Termination Target of 16 slots defined for Subtype 2 Physical Layer configurations. A Forward Traffic Channel data rate corresponding to the 2-slot version of 307.2 kbps with the ACK Channel transmitting in all slots would be configured in the downlink for both Rev. 0 and Rev. A.

8.3.6 Body SAR Measurements for EVDO Hotspot

Hotspot Body SAR is measured using Subtype 0/1 Physical Layer configurations for Rev. 0 per KDB Publication 941225 D01 procedures for “1x Ev-Do data Devices”. SAR for Subtype 2 Physical layer configurations is not required for Rev. A when the maximum average output of each RF channels is less than that measured in Subtype 0/1 Physical layer configurations. Otherwise, SAR is measured on the maximum output channel for Rev. A using the exposure configuration that results in the highest SAR for the RF channels in Rev. 0. The AT is tested with a Reverse Data Channel rate of 153.6 kbps in Subtype 0/1 Physical Layer configurations; and a Reverse Data Channel payload size of 4096 bits and Termination Target of 16 slots in Subtype 2 Physical Layer configurations.

SAR is not required for 1x RTT for Ev-Do devices that also support 1x RTT voice and/or data operations, when the maximum average output of each channel is less than 1/4 dB higher than that measured in Subtype 0/1 Physical Layer configurations for Rev. 0. Otherwise, CDMA “Body-SAR Measurement” procedures for “CDMA 2000 1x Handsets” were applied.

8.4 SAR Measurement Conditions for LTE



LTE modes were tested according to FCC KDB 941225 D05v02 publication. Please see notes after the tabulated SAR data for required test configurations. Establishing connections with base station simulators ensure a consistent means for testing SAR and are recommended for evaluating SAR [4]. The R&S CMW500 was used for LTE output power measurements and SAR testing. Closed loop power control was used so the UE transmits with maximum output power during SAR testing.

8.4.1 Spectrum Plots for RB Configurations

A properly configured base station simulator was used for SAR tests and power measurements. Therefore, spectrum plots for RB configurations were not required to be included in this report.

8.4.2 MPR

MPR is permanently implemented for this device by the manufacturer. The specific manufacturer target MPR is indicated alongside the SAR results. MPR is enabled for this device, according to 3GPP TS36.101 Section 6.2.3 – 6.2.5 under Table 6.2.3-1.

| | | | | |
|--------------------------------------|---|-------------------------------|---|---------------------------------|
| FCC ID A3LSPHL520 |  | SAR EVALUATION REPORT |  | Reviewed by: Quality Manager |
| Document S/N: OY1306281121-R2.A3L | Test Dates: 07/01/13 - 07/19/13 | DUT Type: Portable Handset | | Page 20 of 60 |

8.4.3 A-MPR

A-MPR (Additional MPR) has been disabled for all SAR tests by setting NS=01 on the base station simulator.



8.4.4 Required RB Size and RB Offsets for SAR Testing

According to FCC KDB 941225 D05v02r01:

- a. Per Section 5.2.1, SAR is required for QPSK 1 RB Allocation for the largest bandwidth
 - i. The required channel and offset combination with the highest maximum output power is required for SAR.
 - ii. When the reported SAR is ≤ 0.8 W/kg, testing of the remaining RB offset configurations and required test channels is not required. Otherwise, SAR is required for the remaining required test channels using the RB offset configuration with highest output power for that channel.
 - iii. When the reported SAR for a required test channel is > 1.45 W/kg, SAR is required for all RB offset configurations for that channel.
- b. Per Section 5.2.2, SAR is required for 50% RB allocation using the largest bandwidth following the same procedures outlined in Section 5.2.1.
- c. Per Section 5.2.3, QPSK SAR is not required for the 100% allocation when the highest maximum output power for the 100% allocation is less than the highest maximum output power of the 1 RB and 50% RB allocations and the reported SAR for the 1 RB and 50% RB allocations is < 0.8 W/kg.
- d. Per Section 5.2.4 and 5.3, SAR tests for higher order modulations and lower bandwidths configurations are not required when the conducted power of the required test configurations determined by Sections 5.2.1 through 5.2.3 is less than or equal to $\frac{1}{2}$ dB higher than the equivalent configuration using QPSK modulation and when the QPSK SAR for those configurations is < 1.45 W/kg.

8.4.5 TDD

LTE TDD is tested at the highest duty factor using UL-DL configuration 0 with special subframe configuration 6 and applying the FDD LTE procedures in KDB 941225. SAR testing was performed using the extended cyclic prefix listed in 3GPP TS 36.211 Section 4.

| | | | | |
|---|---|--------------------------------------|---|--|
| FCC ID A3LSPHL520 |  PCTEST ENGINEERING LABORATORY, INC. | SAR EVALUATION REPORT |  | Reviewed by: Quality Manager |
| Document S/N: OY1306281121-R2.A3L | Test Dates: 07/01/13 - 07/19/13 | DUT Type: Portable Handset | | Page 21 of 60 |

8.5 SAR Testing with 802.11 Transmitters

Normal network operating configurations are not suitable for measuring the SAR of 802.11 a/b/g/n transmitters. Unpredictable fluctuations in network traffic and antenna diversity conditions can introduce undesirable variations in SAR results. The SAR for these devices should be measured using chipset based test mode software to ensure the results are consistent and reliable. See KDB Publication 248227 D01v01r02 for more details.

8.5.1 General Device Setup



Chipset based test mode software is hardware dependent and generally varies among manufacturers. The device operating parameters established in test mode for SAR measurements must be identical to those programmed in production units, including output power levels, amplifier gain settings and other RF performance tuning parameters. The test frequencies should correspond to actual channel frequencies defined for domestic use. SAR for devices with switched diversity should be measured with only one antenna transmitting at a time during each SAR measurement, according to a fixed modulation and data rate. The same data pattern should be used for all measurements.

8.5.2 Frequency Channel Configurations [27]

For 2.4 GHz, the highest average RF output power channel between the low, mid and high channel at the lowest data rate was selected for SAR evaluation in 802.11b mode. 802.11g/n modes and higher data rates for 802.11b were additionally evaluated for SAR if the output power of the respective mode was 0.25 dB or higher than the powers of the SAR configurations tested in the 802.11b mode.

For 5 GHz, the highest average RF output power channel across the default test channels at the lowest data rate was selected for SAR evaluation in 802.11a. When the adjacent channels are higher in power than the default channels, these "required channels" were considered instead of the default channels for SAR testing. 802.11n modes and higher data rates for 802.11a/n were evaluated only if the respective mode was 0.25 dB or higher than the 802.11a mode.

If the maximum extrapolated peak SAR of the zoom scan for the highest output channel was less than 1.6 W/kg and if the 1g averaged SAR was less than 0.8 W/kg, SAR testing was not required for the other test channels in the band.

| | | | | |
|---|---|--------------------------------------|---|--|
| FCC ID A3LSPHL520 |  PCTEST ENGINEERING LABORATORY, INC. | SAR EVALUATION REPORT |  | Reviewed by: Quality Manager |
| Document S/N: OY1306281121-R2.A3L | Test Dates: 07/01/13 - 07/19/13 | DUT Type: Portable Handset | Page 22 of 60 | |

9 RF CONDUCTED POWERS

9.1 CDMA Conducted Powers

| Band | Channel | Rule Part | Frequency | SO55 [dBm] | SO55 [dBm] | SO75 [dBm] | TDSO SO32 [dBm] | TDSO SO32 [dBm] | 1x EvDO Rev. 0 [dBm] | 1x EvDO Rev. A [dBm] |
|----------|---------|-----------|-----------|------------|------------|------------|-----------------|-----------------|----------------------|----------------------|
| | F-RC | | MHz | RC1 | RC3 | RC11 | FCH+SCH | FCH | (RTAP) | (RETAP) |
| Cellular | 564 | 90S | 820.1 | 24.98 | 24.91 | 24.82 | 24.89 | 25.00 | 24.81 | 24.63 |
| Cellular | 1013 | 22H | 824.7 | 24.80 | 24.72 | 24.60 | 24.81 | 24.75 | 24.81 | 24.78 |
| | 384 | 22H | 836.52 | 24.61 | 24.75 | 24.79 | 24.77 | 24.72 | 24.90 | 24.73 |
| | 777 | 22H | 848.31 | 24.78 | 24.82 | 24.82 | 24.75 | 24.78 | 24.93 | 24.88 |
| PCS | 25 | 24E | 1851.25 | 24.87 | 24.90 | 24.87 | 24.90 | 24.83 | 24.92 | 24.84 |
| | 600 | 24E | 1880 | 24.68 | 24.72 | 24.73 | 24.77 | 24.80 | 24.91 | 24.75 |
| | 1175 | 24E | 1908.75 | 24.51 | 24.76 | 24.60 | 24.67 | 24.72 | 24.76 | 24.70 |

General Notes:

1. RC1 is only applicable for IS-95 compatibility.
2. For FCC Rule Part 90S, Per FCC KDB Publication 447498 D01v05 4.1.6, only one channel is required since the device operates within the transmission range of 817.90 – 823.10 MHz.

Per KDB Publication 941225 D01v02:

1. Head SAR was tested with SO55 RC3. SO55 RC1 was not required since the average output power was not more than 0.25 dB than the SO55 RC3 powers.
2. Body-Worn SAR was tested with 1x RTT with TDSO / SO32 FCH Only. Ev-Do and TDSO / SO32 FCH+SCH SAR tests were not required since the average output power was not more than 0.25 dB higher than the TDSO / SO32 FCH only powers.
3. Hotspot SAR is measured using Subtype 0/1 Physical Layer configurations for Rev. 0. If the average output power of Subtype 2 for Rev. A is less than the Rev. 0 power levels, then Rev. A SAR is not required. Otherwise, SAR is measured on the maximum output channel for Rev. A using the exposure configuration that results in the highest SAR for that RF channel in Rev. 0. SAR is not required for 1x RTT for Ev-Do hotspot devices when the maximum average output of each channel is less than 1/4 dB higher than that measured in Subtype 0/1 Physical Layer configurations for Rev. 0
4. Head SAR was additionally evaluated with EVDO Rev. A to determine compliance for held-to-ear VoIP operations.

1x Advanced Considerations per FCC KDB publication 941225 D02 v02r02:

1. CDMA 1X Advanced technology was not required for SAR since the maximum output powers for 1x Advanced was not more than 0.25 dB higher than the maximum measured powers for 1x and the measured SAR in any 1x mode exposure conditions was not greater than 1.2 W/kg. See Section 8.3.2 for 1x Advanced test set up.

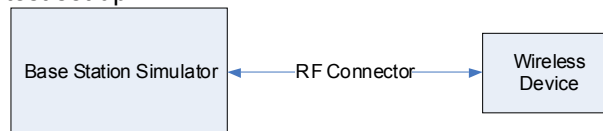

**Figure 9-1
Power Measurement Setup**

| | | | | |
|--------------------------------------|--|-------------------------------|---------------|---------------------------------|
| FCC ID A3LSPHL520 | PCTEST ENGINEERING LABORATORY, INC. | SAR EVALUATION REPORT | | Reviewed by: Quality Manager |
| Document S/N: OY1306281121-R2.A3L | Test Dates: 07/01/13 - 07/19/13 | DUT Type: Portable Handset | Page 23 of 60 | |

9.2 LTE Conducted Powers

9.2.1 LTE Band 26

Table 9-1
LTE Band 26 Conducted Powers - 10 MHz Bandwidth

| Frequency [MHz] | Channel | Bandwidth [MHz] | Modulation | RB Size | RB Offset | Maximum Allowed Power [dBm] | Conducted Power [dBm] | Target MPR [dB] | MPR Allowed per 3GPP [dB] |
|-----------------|---------|-----------------|------------|---------|-----------|-----------------------------|-----------------------|-----------------|---------------------------|
| 819 | 26740 | 10 | QPSK | 1 | 0 | 23.5 | 22.89 | 0 | 0 |
| 819 | 26740 | 10 | QPSK | 1 | 25 | 23.5 | 22.98 | 0 | 0 |
| 819 | 26740 | 10 | QPSK | 1 | 49 | 23.5 | 23.04 | 0 | 0 |
| 819 | 26740 | 10 | QPSK | 25 | 0 | 22.5 | 21.75 | 1 | 0-1 |
| 819 | 26740 | 10 | QPSK | 25 | 12 | 22.5 | 21.74 | 1 | 0-1 |
| 819 | 26740 | 10 | QPSK | 25 | 25 | 22.5 | 21.79 | 1 | 0-1 |
| 819 | 26740 | 10 | QPSK | 50 | 0 | 22.5 | 21.64 | 1 | 0-1 |
| 819 | 26740 | 10 | 16QAM | 1 | 0 | 22.5 | 21.72 | 1 | 0-1 |
| 819 | 26740 | 10 | 16QAM | 1 | 25 | 22.5 | 21.86 | 1 | 0-1 |
| 819 | 26740 | 10 | 16QAM | 1 | 49 | 22.5 | 21.83 | 1 | 0-1 |
| 819 | 26740 | 10 | 16QAM | 25 | 0 | 21.5 | 20.74 | 2 | 0-2 |
| 819 | 26740 | 10 | 16QAM | 25 | 12 | 21.5 | 20.80 | 2 | 0-2 |
| 819 | 26740 | 10 | 16QAM | 25 | 25 | 21.5 | 20.77 | 2 | 0-2 |
| 819 | 26740 | 10 | 16QAM | 50 | 0 | 21.5 | 20.65 | 2 | 0-2 |
| 831.5 | 26865 | 10 | QPSK | 1 | 0 | 23.5 | 22.94 | 0 | 0 |
| 831.5 | 26865 | 10 | QPSK | 1 | 25 | 23.5 | 22.88 | 0 | 0 |
| 831.5 | 26865 | 10 | QPSK | 1 | 49 | 23.5 | 22.87 | 0 | 0 |
| 831.5 | 26865 | 10 | QPSK | 25 | 0 | 22.5 | 21.76 | 1 | 0-1 |
| 831.5 | 26865 | 10 | QPSK | 25 | 12 | 22.5 | 21.75 | 1 | 0-1 |
| 831.5 | 26865 | 10 | QPSK | 25 | 25 | 22.5 | 21.71 | 1 | 0-1 |
| 831.5 | 26865 | 10 | QPSK | 50 | 0 | 22.5 | 21.66 | 1 | 0-1 |
| 831.5 | 26865 | 10 | 16QAM | 1 | 0 | 22.5 | 21.75 | 1 | 0-1 |
| 831.5 | 26865 | 10 | 16QAM | 1 | 25 | 22.5 | 21.89 | 1 | 0-1 |
| 831.5 | 26865 | 10 | 16QAM | 1 | 49 | 22.5 | 21.86 | 1 | 0-1 |
| 831.5 | 26865 | 10 | 16QAM | 25 | 0 | 21.5 | 20.81 | 2 | 0-2 |
| 831.5 | 26865 | 10 | 16QAM | 25 | 12 | 21.5 | 20.73 | 2 | 0-2 |
| 831.5 | 26865 | 10 | 16QAM | 25 | 25 | 21.5 | 20.72 | 2 | 0-2 |
| 831.5 | 26865 | 10 | 16QAM | 50 | 0 | 21.5 | 20.66 | 2 | 0-2 |
| 844 | 26990 | 10 | QPSK | 1 | 0 | 23.5 | 22.78 | 0 | 0 |
| 844 | 26990 | 10 | QPSK | 1 | 25 | 23.5 | 22.84 | 0 | 0 |
| 844 | 26990 | 10 | QPSK | 1 | 49 | 23.5 | 22.51 | 0 | 0 |
| 844 | 26990 | 10 | QPSK | 25 | 0 | 22.5 | 21.63 | 1 | 0-1 |
| 844 | 26990 | 10 | QPSK | 25 | 12 | 22.5 | 21.69 | 1 | 0-1 |
| 844 | 26990 | 10 | QPSK | 25 | 25 | 22.5 | 21.56 | 1 | 0-1 |
| 844 | 26990 | 10 | QPSK | 50 | 0 | 22.5 | 21.48 | 1 | 0-1 |
| 844 | 26990 | 10 | 16QAM | 1 | 0 | 22.5 | 21.74 | 1 | 0-1 |
| 844 | 26990 | 10 | 16QAM | 1 | 25 | 22.5 | 21.79 | 1 | 0-1 |
| 844 | 26990 | 10 | 16QAM | 1 | 49 | 22.5 | 21.52 | 1 | 0-1 |
| 844 | 26990 | 10 | 16QAM | 25 | 0 | 21.5 | 20.71 | 2 | 0-2 |
| 844 | 26990 | 10 | 16QAM | 25 | 12 | 21.5 | 20.70 | 2 | 0-2 |
| 844 | 26990 | 10 | 16QAM | 25 | 25 | 21.5 | 20.72 | 2 | 0-2 |
| 844 | 26990 | 10 | 16QAM | 50 | 0 | 21.5 | 20.53 | 2 | 0-2 |





| | | | | |
|--------------------------------------|--|-------------------------------|---|---------------------------------|
| FCC ID A3LSPHL520 |  PCTEST ENGINEERING LABORATORY, INC. | SAR EVALUATION REPORT |  | Reviewed by: Quality Manager |
| Document S/N: OY1306281121-R2.A3L | Test Dates: 07/01/13 - 07/19/13 | DUT Type: Portable Handset | | Page 24 of 60 |



Table 9-2
LTE Band 26 Conducted Powers - 5 MHz Bandwidth

| Frequency [MHz] | Channel | Bandwidth [MHz] | Modulation | RB Size | RB Offset | Maximum Allowed Power [dBm] | Conducted Power [dBm] | Target MPR [dB] | MPR Allowed per 3GPP [dB] |
|-----------------|---------|-----------------|------------|---------|-----------|-----------------------------|-----------------------|-----------------|---------------------------|
| 816.5 | 26715 | 5 | QPSK | 1 | 0 | 23.5 | 23.05 | 0 | 0 |
| 816.5 | 26715 | 5 | QPSK | 1 | 12 | 23.5 | 22.84 | 0 | 0 |
| 816.5 | 26715 | 5 | QPSK | 1 | 24 | 23.5 | 23.10 | 0 | 0 |
| 816.5 | 26715 | 5 | QPSK | 12 | 0 | 22.5 | 21.62 | 1 | 0-1 |
| 816.5 | 26715 | 5 | QPSK | 12 | 6 | 22.5 | 21.72 | 1 | 0-1 |
| 816.5 | 26715 | 5 | QPSK | 12 | 13 | 22.5 | 22.02 | 1 | 0-1 |
| 816.5 | 26715 | 5 | QPSK | 25 | 0 | 22.5 | 21.78 | 1 | 0-1 |
| 816.5 | 26715 | 5 | 16-QAM | 1 | 0 | 22.5 | 21.86 | 1 | 0-1 |
| 816.5 | 26715 | 5 | 16-QAM | 1 | 12 | 22.5 | 21.85 | 1 | 0-1 |
| 816.5 | 26715 | 5 | 16-QAM | 1 | 24 | 22.5 | 22.05 | 1 | 0-1 |
| 816.5 | 26715 | 5 | 16-QAM | 12 | 0 | 21.5 | 20.89 | 2 | 0-2 |
| 816.5 | 26715 | 5 | 16-QAM | 12 | 6 | 21.5 | 20.95 | 2 | 0-2 |
| 816.5 | 26715 | 5 | 16-QAM | 12 | 13 | 21.5 | 21.04 | 2 | 0-2 |
| 816.5 | 26715 | 5 | 16-QAM | 25 | 0 | 21.5 | 20.78 | 2 | 0-2 |
| 831.5 | 26865 | 5 | QPSK | 1 | 0 | 23.5 | 22.60 | 0 | 0 |
| 831.5 | 26865 | 5 | QPSK | 1 | 12 | 23.5 | 22.83 | 0 | 0 |
| 831.5 | 26865 | 5 | QPSK | 1 | 24 | 23.5 | 22.86 | 0 | 0 |
| 831.5 | 26865 | 5 | QPSK | 12 | 0 | 22.5 | 21.89 | 1 | 0-1 |
| 831.5 | 26865 | 5 | QPSK | 12 | 6 | 22.5 | 21.84 | 1 | 0-1 |
| 831.5 | 26865 | 5 | QPSK | 12 | 13 | 22.5 | 21.88 | 1 | 0-1 |
| 831.5 | 26865 | 5 | QPSK | 25 | 0 | 22.5 | 21.77 | 1 | 0-1 |
| 831.5 | 26865 | 5 | 16-QAM | 1 | 0 | 22.5 | 21.68 | 1 | 0-1 |
| 831.5 | 26865 | 5 | 16-QAM | 1 | 12 | 22.5 | 21.78 | 1 | 0-1 |
| 831.5 | 26865 | 5 | 16-QAM | 1 | 24 | 22.5 | 21.83 | 1 | 0-1 |
| 831.5 | 26865 | 5 | 16-QAM | 12 | 0 | 21.5 | 20.88 | 2 | 0-2 |
| 831.5 | 26865 | 5 | 16-QAM | 12 | 6 | 21.5 | 20.91 | 2 | 0-2 |
| 831.5 | 26865 | 5 | 16-QAM | 12 | 13 | 21.5 | 20.89 | 2 | 0-2 |
| 831.5 | 26865 | 5 | 16-QAM | 25 | 0 | 21.5 | 20.73 | 2 | 0-2 |
| 846.5 | 27015 | 5 | QPSK | 1 | 0 | 23.5 | 22.83 | 0 | 0 |
| 846.5 | 27015 | 5 | QPSK | 1 | 12 | 23.5 | 22.89 | 0 | 0 |
| 846.5 | 27015 | 5 | QPSK | 1 | 24 | 23.5 | 22.57 | 0 | 0 |
| 846.5 | 27015 | 5 | QPSK | 12 | 0 | 22.5 | 21.95 | 1 | 0-1 |
| 846.5 | 27015 | 5 | QPSK | 12 | 6 | 22.5 | 21.84 | 1 | 0-1 |
| 846.5 | 27015 | 5 | QPSK | 12 | 13 | 22.5 | 21.60 | 1 | 0-1 |
| 846.5 | 27015 | 5 | QPSK | 25 | 0 | 22.5 | 21.68 | 1 | 0-1 |
| 846.5 | 27015 | 5 | 16-QAM | 1 | 0 | 22.5 | 21.90 | 1 | 0-1 |
| 846.5 | 27015 | 5 | 16-QAM | 1 | 12 | 22.5 | 21.81 | 1 | 0-1 |
| 846.5 | 27015 | 5 | 16-QAM | 1 | 24 | 22.5 | 21.51 | 1 | 0-1 |
| 846.5 | 27015 | 5 | 16-QAM | 12 | 0 | 21.5 | 21.06 | 2 | 0-2 |
| 846.5 | 27015 | 5 | 16-QAM | 12 | 6 | 21.5 | 20.99 | 2 | 0-2 |
| 846.5 | 27015 | 5 | 16-QAM | 12 | 13 | 21.5 | 20.74 | 2 | 0-2 |
| 846.5 | 27015 | 5 | 16-QAM | 25 | 0 | 21.5 | 20.70 | 2 | 0-2 |

| | | | | |
|---|--|--------------------------------------|---|--|
| FCC ID A3LSPHL520 |  PCTEST <small>TECHNOLOGICAL LABORATORY, INC.</small> | SAR EVALUATION REPORT |  | Reviewed by: Quality Manager |
| Document S/N: OY1306281121-R2.A3L | Test Dates: 07/01/13 - 07/19/13 | DUT Type: Portable Handset | Page 25 of 60 | |



**Table 9-3
LTE Band 26 Conducted Powers - 3 MHz Bandwidth**

| Frequency [MHz] | Channel | Bandwidth [MHz] | Modulation | RB Size | RB Offset | Maximum Allowed Power [dBm] | Conducted Power [dBm] | Target MPR [dB] | MPR Allowed per 3GPP [dB] |
|-----------------|---------|-----------------|------------|---------|-----------|-----------------------------|-----------------------|-----------------|---------------------------|
| 815.5 | 26705 | 3 | QPSK | 1 | 0 | 23.5 | 22.92 | 0 | 0 |
| 815.5 | 26705 | 3 | QPSK | 1 | 7 | 23.5 | 22.89 | 0 | 0 |
| 815.5 | 26705 | 3 | QPSK | 1 | 14 | 23.5 | 22.88 | 0 | 0 |
| 815.5 | 26705 | 3 | QPSK | 8 | 0 | 22.5 | 21.80 | 1 | 0-1 |
| 815.5 | 26705 | 3 | QPSK | 8 | 4 | 22.5 | 21.83 | 1 | 0-1 |
| 815.5 | 26705 | 3 | QPSK | 8 | 7 | 22.5 | 21.85 | 1 | 0-1 |
| 815.5 | 26705 | 3 | QPSK | 15 | 0 | 22.5 | 21.75 | 1 | 0-1 |
| 815.5 | 26705 | 3 | 16-QAM | 1 | 0 | 22.5 | 21.84 | 1 | 0-1 |
| 815.5 | 26705 | 3 | 16-QAM | 1 | 7 | 22.5 | 21.93 | 1 | 0-1 |
| 815.5 | 26705 | 3 | 16-QAM | 1 | 14 | 22.5 | 21.83 | 1 | 0-1 |
| 815.5 | 26705 | 3 | 16-QAM | 8 | 0 | 21.5 | 20.76 | 2 | 0-2 |
| 815.5 | 26705 | 3 | 16-QAM | 8 | 4 | 21.5 | 20.71 | 2 | 0-2 |
| 815.5 | 26705 | 3 | 16-QAM | 8 | 7 | 21.5 | 20.73 | 2 | 0-2 |
| 815.5 | 26705 | 3 | 16-QAM | 15 | 0 | 21.5 | 20.74 | 2 | 0-2 |
| 831.5 | 26865 | 3 | QPSK | 1 | 0 | 23.5 | 22.92 | 0 | 0 |
| 831.5 | 26865 | 3 | QPSK | 1 | 7 | 23.5 | 22.82 | 0 | 0 |
| 831.5 | 26865 | 3 | QPSK | 1 | 14 | 23.5 | 22.77 | 0 | 0 |
| 831.5 | 26865 | 3 | QPSK | 8 | 0 | 22.5 | 21.79 | 1 | 0-1 |
| 831.5 | 26865 | 3 | QPSK | 8 | 4 | 22.5 | 21.81 | 1 | 0-1 |
| 831.5 | 26865 | 3 | QPSK | 8 | 7 | 22.5 | 21.88 | 1 | 0-1 |
| 831.5 | 26865 | 3 | QPSK | 15 | 0 | 22.5 | 21.80 | 1 | 0-1 |
| 831.5 | 26865 | 3 | 16-QAM | 1 | 0 | 22.5 | 21.73 | 1 | 0-1 |
| 831.5 | 26865 | 3 | 16-QAM | 1 | 7 | 22.5 | 21.72 | 1 | 0-1 |
| 831.5 | 26865 | 3 | 16-QAM | 1 | 14 | 22.5 | 21.86 | 1 | 0-1 |
| 831.5 | 26865 | 3 | 16-QAM | 8 | 0 | 21.5 | 20.81 | 2 | 0-2 |
| 831.5 | 26865 | 3 | 16-QAM | 8 | 4 | 21.5 | 20.74 | 2 | 0-2 |
| 831.5 | 26865 | 3 | 16-QAM | 8 | 7 | 21.5 | 20.81 | 2 | 0-2 |
| 831.5 | 26865 | 3 | 16-QAM | 15 | 0 | 21.5 | 20.80 | 2 | 0-2 |
| 847.5 | 27025 | 3 | QPSK | 1 | 0 | 23.5 | 22.90 | 0 | 0 |
| 847.5 | 27025 | 3 | QPSK | 1 | 7 | 23.5 | 22.66 | 0 | 0 |
| 847.5 | 27025 | 3 | QPSK | 1 | 14 | 23.5 | 22.53 | 0 | 0 |
| 847.5 | 27025 | 3 | QPSK | 8 | 0 | 22.5 | 21.81 | 1 | 0-1 |
| 847.5 | 27025 | 3 | QPSK | 8 | 4 | 22.5 | 21.67 | 1 | 0-1 |
| 847.5 | 27025 | 3 | QPSK | 8 | 7 | 22.5 | 21.59 | 1 | 0-1 |
| 847.5 | 27025 | 3 | QPSK | 15 | 0 | 22.5 | 21.58 | 1 | 0-1 |
| 847.5 | 27025 | 3 | 16-QAM | 1 | 0 | 22.5 | 21.80 | 1 | 0-1 |
| 847.5 | 27025 | 3 | 16-QAM | 1 | 7 | 22.5 | 21.55 | 1 | 0-1 |
| 847.5 | 27025 | 3 | 16-QAM | 1 | 14 | 22.5 | 21.45 | 1 | 0-1 |
| 847.5 | 27025 | 3 | 16-QAM | 8 | 0 | 21.5 | 20.69 | 2 | 0-2 |
| 847.5 | 27025 | 3 | 16-QAM | 8 | 4 | 21.5 | 20.65 | 2 | 0-2 |
| 847.5 | 27025 | 3 | 16-QAM | 8 | 7 | 21.5 | 20.54 | 2 | 0-2 |
| 847.5 | 27025 | 3 | 16-QAM | 15 | 0 | 21.5 | 20.73 | 2 | 0-2 |

| | | | | |
|---|---|--------------------------------------|---|--|
| FCC ID A3LSPHL520 |  | SAR EVALUATION REPORT |  | Reviewed by: Quality Manager |
| Document S/N: OY1306281121-R2.A3L | Test Dates: 07/01/13 - 07/19/13 | DUT Type: Portable Handset | Page 26 of 60 | |

**Table 9-4
LTE Band 26 Conducted Powers -1.4 MHz Bandwidth**

| Frequency [MHz] | Channel | Bandwidth [MHz] | Modulation | RB Size | RB Offset | Maximum Allowed Power [dBm] | Conducted Power [dBm] | Target MPR [dB] | MPR Allowed per 3GPP [dB] |
|-----------------|---------|-----------------|------------|---------|-----------|-----------------------------|-----------------------|-----------------|---------------------------|
| 814.7 | 26697 | 1.4 | QPSK | 1 | 0 | 23.5 | 22.86 | 0 | 0 |
| 814.7 | 26697 | 1.4 | QPSK | 1 | 2 | 23.5 | 22.72 | 0 | 0 |
| 814.7 | 26697 | 1.4 | QPSK | 1 | 5 | 23.5 | 22.87 | 0 | 0 |
| 814.7 | 26697 | 1.4 | QPSK | 3 | 0 | 23.5 | 22.88 | 0 | 0 |
| 814.7 | 26697 | 1.4 | QPSK | 3 | 2 | 23.5 | 22.84 | 0 | 0 |
| 814.7 | 26697 | 1.4 | QPSK | 3 | 3 | 23.5 | 22.79 | 0 | 0 |
| 814.7 | 26697 | 1.4 | QPSK | 6 | 0 | 22.5 | 21.91 | 1 | 0-1 |
| 814.7 | 26697 | 1.4 | 16-QAM | 1 | 0 | 22.5 | 21.90 | 1 | 0-1 |
| 814.7 | 26697 | 1.4 | 16-QAM | 1 | 2 | 22.5 | 21.85 | 1 | 0-1 |
| 814.7 | 26697 | 1.4 | 16-QAM | 1 | 5 | 22.5 | 21.91 | 1 | 0-1 |
| 814.7 | 26697 | 1.4 | 16-QAM | 3 | 0 | 22.5 | 21.93 | 1 | 0-1 |
| 814.7 | 26697 | 1.4 | 16-QAM | 3 | 2 | 22.5 | 21.89 | 1 | 0-1 |
| 814.7 | 26697 | 1.4 | 16-QAM | 3 | 3 | 22.5 | 21.86 | 1 | 0-1 |
| 814.7 | 26697 | 1.4 | 16-QAM | 6 | 0 | 21.5 | 20.78 | 2 | 0-2 |
| 831.5 | 26865 | 1.4 | QPSK | 1 | 0 | 23.5 | 22.85 | 0 | 0 |
| 831.5 | 26865 | 1.4 | QPSK | 1 | 2 | 23.5 | 22.87 | 0 | 0 |
| 831.5 | 26865 | 1.4 | QPSK | 1 | 5 | 23.5 | 22.82 | 0 | 0 |
| 831.5 | 26865 | 1.4 | QPSK | 3 | 0 | 23.5 | 22.84 | 0 | 0 |
| 831.5 | 26865 | 1.4 | QPSK | 3 | 2 | 23.5 | 22.78 | 0 | 0 |
| 831.5 | 26865 | 1.4 | QPSK | 3 | 3 | 23.5 | 22.76 | 0 | 0 |
| 831.5 | 26865 | 1.4 | QPSK | 6 | 0 | 22.5 | 21.87 | 1 | 0-1 |
| 831.5 | 26865 | 1.4 | 16-QAM | 1 | 0 | 22.5 | 21.67 | 1 | 0-1 |
| 831.5 | 26865 | 1.4 | 16-QAM | 1 | 2 | 22.5 | 21.75 | 1 | 0-1 |
| 831.5 | 26865 | 1.4 | 16-QAM | 1 | 5 | 22.5 | 21.78 | 1 | 0-1 |
| 831.5 | 26865 | 1.4 | 16-QAM | 3 | 0 | 22.5 | 21.75 | 1 | 0-1 |
| 831.5 | 26865 | 1.4 | 16-QAM | 3 | 2 | 22.5 | 21.74 | 1 | 0-1 |
| 831.5 | 26865 | 1.4 | 16-QAM | 3 | 3 | 22.5 | 21.82 | 1 | 0-1 |
| 831.5 | 26865 | 1.4 | 16-QAM | 6 | 0 | 21.5 | 20.75 | 2 | 0-2 |
| 848.3 | 27033 | 1.4 | QPSK | 1 | 0 | 23.5 | 22.69 | 0 | 0 |
| 848.3 | 27033 | 1.4 | QPSK | 1 | 2 | 23.5 | 22.62 | 0 | 0 |
| 848.3 | 27033 | 1.4 | QPSK | 1 | 5 | 23.5 | 22.52 | 0 | 0 |
| 848.3 | 27033 | 1.4 | QPSK | 3 | 0 | 23.5 | 22.59 | 0 | 0 |
| 848.3 | 27033 | 1.4 | QPSK | 3 | 2 | 23.5 | 22.58 | 0 | 0 |
| 848.3 | 27033 | 1.4 | QPSK | 3 | 3 | 23.5 | 22.55 | 0 | 0 |
| 848.3 | 27033 | 1.4 | QPSK | 6 | 0 | 22.5 | 21.59 | 1 | 0-1 |
| 848.3 | 27033 | 1.4 | 16-QAM | 1 | 0 | 22.5 | 21.48 | 1 | 0-1 |
| 848.3 | 27033 | 1.4 | 16-QAM | 1 | 2 | 22.5 | 21.51 | 1 | 0-1 |
| 848.3 | 27033 | 1.4 | 16-QAM | 1 | 5 | 22.5 | 21.45 | 1 | 0-1 |
| 848.3 | 27033 | 1.4 | 16-QAM | 3 | 0 | 22.5 | 21.49 | 1 | 0-1 |
| 848.3 | 27033 | 1.4 | 16-QAM | 3 | 2 | 22.5 | 21.51 | 1 | 0-1 |
| 848.3 | 27033 | 1.4 | 16-QAM | 3 | 3 | 22.5 | 21.48 | 1 | 0-1 |
| 848.3 | 27033 | 1.4 | 16-QAM | 6 | 0 | 21.5 | 20.55 | 2 | 0-2 |



| | | | | |
|---|---|--------------------------------------|---|--|
| FCC ID A3LSPHL520 |  | SAR EVALUATION REPORT |  | Reviewed by: Quality Manager |
| Document S/N: OY1306281121-R2.A3L | Test Dates: 07/01/13 - 07/19/13 | DUT Type: Portable Handset | Page 27 of 60 | |

9.2.2

LTE Band 25 (PCS)

Table 9-5
LTE Band 25 (PCS) Conducted Powers - 10 MHz Bandwidth

| Frequency [MHz] | Channel | Bandwidth [MHz] | Modulation | RB Size | RB Offset | Maximum Allowed Power [dBm] | Conducted Power [dBm] | Target MPR [dB] | MPR Allowed per 3GPP [dB] |
|-----------------|---------|-----------------|------------|---------|-----------|-----------------------------|-----------------------|-----------------|---------------------------|
| 1855 | 26090 | 10 | QPSK | 1 | 0 | 23.5 | 23.13 | 0 | 0 |
| 1855 | 26090 | 10 | QPSK | 1 | 25 | 23.5 | 22.84 | 0 | 0 |
| 1855 | 26090 | 10 | QPSK | 1 | 49 | 23.5 | 22.62 | 0 | 0 |
| 1855 | 26090 | 10 | QPSK | 25 | 0 | 22.5 | 21.93 | 1 | 0-1 |
| 1855 | 26090 | 10 | QPSK | 25 | 12 | 22.5 | 21.74 | 1 | 0-1 |
| 1855 | 26090 | 10 | QPSK | 25 | 25 | 22.5 | 21.50 | 1 | 0-1 |
| 1855 | 26090 | 10 | QPSK | 50 | 0 | 22.5 | 21.55 | 1 | 0-1 |
| 1855 | 26090 | 10 | 16QAM | 1 | 0 | 22.5 | 21.92 | 1 | 0-1 |
| 1855 | 26090 | 10 | 16QAM | 1 | 25 | 22.5 | 21.76 | 1 | 0-1 |
| 1855 | 26090 | 10 | 16QAM | 1 | 49 | 22.5 | 21.58 | 1 | 0-1 |
| 1855 | 26090 | 10 | 16QAM | 25 | 0 | 21.5 | 20.91 | 2 | 0-2 |
| 1855 | 26090 | 10 | 16QAM | 25 | 12 | 21.5 | 20.79 | 2 | 0-2 |
| 1855 | 26090 | 10 | 16QAM | 25 | 25 | 21.5 | 20.60 | 2 | 0-2 |
| 1855 | 26090 | 10 | 16QAM | 50 | 0 | 21.5 | 20.64 | 2 | 0-2 |
| 1882.5 | 26365 | 10 | QPSK | 1 | 0 | 23.5 | 23.02 | 0 | 0 |
| 1882.5 | 26365 | 10 | QPSK | 1 | 25 | 23.5 | 23.06 | 0 | 0 |
| 1882.5 | 26365 | 10 | QPSK | 1 | 49 | 23.5 | 22.96 | 0 | 0 |
| 1882.5 | 26365 | 10 | QPSK | 25 | 0 | 22.5 | 21.91 | 1 | 0-1 |
| 1882.5 | 26365 | 10 | QPSK | 25 | 12 | 22.5 | 21.82 | 1 | 0-1 |
| 1882.5 | 26365 | 10 | QPSK | 25 | 25 | 22.5 | 21.88 | 1 | 0-1 |
| 1882.5 | 26365 | 10 | QPSK | 50 | 0 | 22.5 | 21.73 | 1 | 0-1 |
| 1882.5 | 26365 | 10 | 16QAM | 1 | 0 | 22.5 | 21.98 | 1 | 0-1 |
| 1882.5 | 26365 | 10 | 16QAM | 1 | 25 | 22.5 | 22.07 | 1 | 0-1 |
| 1882.5 | 26365 | 10 | 16QAM | 1 | 49 | 22.5 | 21.95 | 1 | 0-1 |
| 1882.5 | 26365 | 10 | 16QAM | 25 | 0 | 21.5 | 20.86 | 2 | 0-2 |
| 1882.5 | 26365 | 10 | 16QAM | 25 | 12 | 21.5 | 20.82 | 2 | 0-2 |
| 1882.5 | 26365 | 10 | 16QAM | 25 | 25 | 21.5 | 20.88 | 2 | 0-2 |
| 1882.5 | 26365 | 10 | 16QAM | 50 | 0 | 21.5 | 20.76 | 2 | 0-2 |
| 1910 | 26640 | 10 | QPSK | 1 | 0 | 23.5 | 22.84 | 0 | 0 |
| 1910 | 26640 | 10 | QPSK | 1 | 25 | 23.5 | 22.85 | 0 | 0 |
| 1910 | 26640 | 10 | QPSK | 1 | 49 | 23.5 | 22.77 | 0 | 0 |
| 1910 | 26640 | 10 | QPSK | 25 | 0 | 22.5 | 21.86 | 1 | 0-1 |
| 1910 | 26640 | 10 | QPSK | 25 | 12 | 22.5 | 21.92 | 1 | 0-1 |
| 1910 | 26640 | 10 | QPSK | 25 | 25 | 22.5 | 21.90 | 1 | 0-1 |
| 1910 | 26640 | 10 | QPSK | 50 | 0 | 22.5 | 21.70 | 1 | 0-1 |
| 1910 | 26640 | 10 | 16QAM | 1 | 0 | 22.5 | 21.84 | 1 | 0-1 |
| 1910 | 26640 | 10 | 16QAM | 1 | 25 | 22.5 | 21.94 | 1 | 0-1 |
| 1910 | 26640 | 10 | 16QAM | 1 | 49 | 22.5 | 21.83 | 1 | 0-1 |
| 1910 | 26640 | 10 | 16QAM | 25 | 0 | 21.5 | 20.94 | 2 | 0-2 |
| 1910 | 26640 | 10 | 16QAM | 25 | 12 | 21.5 | 20.95 | 2 | 0-2 |
| 1910 | 26640 | 10 | 16QAM | 25 | 25 | 21.5 | 20.87 | 2 | 0-2 |
| 1910 | 26640 | 10 | 16QAM | 50 | 0 | 21.5 | 20.75 | 2 | 0-2 |

| | | | | |
|---|---|--------------------------------------|---|--|
| FCC ID A3LSPHL520 |  PCTEST ENGINEERING LABORATORY, INC. | SAR EVALUATION REPORT |  | Reviewed by: Quality Manager |
| Document S/N: OY1306281121-R2.A3L | Test Dates: 07/01/13 - 07/19/13 | DUT Type: Portable Handset | Page 28 of 60 | |

**Table 9-6
LTE Band 25 (PCS) Conducted Powers - 5 MHz Bandwidth**

| Frequency [MHz] | Channel | Bandwidth [MHz] | Modulation | RB Size | RB Offset | Maximum Allowed Power [dBm] | Conducted Power [dBm] | Target MPR [dB] | MPR Allowed per 3GPP [dB] |
|-----------------|---------|-----------------|------------|---------|-----------|-----------------------------|-----------------------|-----------------|---------------------------|
| 1852.5 | 26065 | 5 | QPSK | 1 | 0 | 23.5 | 23.12 | 0 | 0 |
| 1852.5 | 26065 | 5 | QPSK | 1 | 12 | 23.5 | 23.03 | 0 | 0 |
| 1852.5 | 26065 | 5 | QPSK | 1 | 24 | 23.5 | 22.92 | 0 | 0 |
| 1852.5 | 26065 | 5 | QPSK | 12 | 0 | 22.5 | 21.96 | 1 | 0-1 |
| 1852.5 | 26065 | 5 | QPSK | 12 | 6 | 22.5 | 21.97 | 1 | 0-1 |
| 1852.5 | 26065 | 5 | QPSK | 12 | 13 | 22.5 | 21.92 | 1 | 0-1 |
| 1852.5 | 26065 | 5 | QPSK | 25 | 0 | 22.5 | 21.88 | 1 | 0-1 |
| 1852.5 | 26065 | 5 | 16-QAM | 1 | 0 | 22.5 | 22.02 | 1 | 0-1 |
| 1852.5 | 26065 | 5 | 16-QAM | 1 | 12 | 22.5 | 22.03 | 1 | 0-1 |
| 1852.5 | 26065 | 5 | 16-QAM | 1 | 24 | 22.5 | 21.87 | 1 | 0-1 |
| 1852.5 | 26065 | 5 | 16-QAM | 12 | 0 | 21.5 | 21.08 | 2 | 0-2 |
| 1852.5 | 26065 | 5 | 16-QAM | 12 | 6 | 21.5 | 21.10 | 2 | 0-2 |
| 1852.5 | 26065 | 5 | 16-QAM | 12 | 13 | 21.5 | 21.05 | 2 | 0-2 |
| 1852.5 | 26065 | 5 | 16-QAM | 25 | 0 | 21.5 | 20.99 | 2 | 0-2 |
| 1882.5 | 26365 | 5 | QPSK | 1 | 0 | 23.5 | 23.05 | 0 | 0 |
| 1882.5 | 26365 | 5 | QPSK | 1 | 12 | 23.5 | 22.94 | 0 | 0 |
| 1882.5 | 26365 | 5 | QPSK | 1 | 24 | 23.5 | 22.86 | 0 | 0 |
| 1882.5 | 26365 | 5 | QPSK | 12 | 0 | 22.5 | 21.95 | 1 | 0-1 |
| 1882.5 | 26365 | 5 | QPSK | 12 | 6 | 22.5 | 21.94 | 1 | 0-1 |
| 1882.5 | 26365 | 5 | QPSK | 12 | 13 | 22.5 | 21.96 | 1 | 0-1 |
| 1882.5 | 26365 | 5 | QPSK | 25 | 0 | 22.5 | 21.80 | 1 | 0-1 |
| 1882.5 | 26365 | 5 | 16-QAM | 1 | 0 | 22.5 | 21.89 | 1 | 0-1 |
| 1882.5 | 26365 | 5 | 16-QAM | 1 | 12 | 22.5 | 21.96 | 1 | 0-1 |
| 1882.5 | 26365 | 5 | 16-QAM | 1 | 24 | 22.5 | 21.87 | 1 | 0-1 |
| 1882.5 | 26365 | 5 | 16-QAM | 12 | 0 | 21.5 | 21.00 | 2 | 0-2 |
| 1882.5 | 26365 | 5 | 16-QAM | 12 | 6 | 21.5 | 21.01 | 2 | 0-2 |
| 1882.5 | 26365 | 5 | 16-QAM | 12 | 13 | 21.5 | 21.04 | 2 | 0-2 |
| 1882.5 | 26365 | 5 | 16-QAM | 25 | 0 | 21.5 | 20.85 | 2 | 0-2 |
| 1912.5 | 26665 | 5 | QPSK | 1 | 0 | 23.5 | 22.96 | 0 | 0 |
| 1912.5 | 26665 | 5 | QPSK | 1 | 12 | 23.5 | 22.87 | 0 | 0 |
| 1912.5 | 26665 | 5 | QPSK | 1 | 24 | 23.5 | 22.75 | 0 | 0 |
| 1912.5 | 26665 | 5 | QPSK | 12 | 0 | 22.5 | 21.92 | 1 | 0-1 |
| 1912.5 | 26665 | 5 | QPSK | 12 | 6 | 22.5 | 21.81 | 1 | 0-1 |
| 1912.5 | 26665 | 5 | QPSK | 12 | 13 | 22.5 | 21.78 | 1 | 0-1 |
| 1912.5 | 26665 | 5 | QPSK | 25 | 0 | 22.5 | 21.77 | 1 | 0-1 |
| 1912.5 | 26665 | 5 | 16-QAM | 1 | 0 | 22.5 | 21.96 | 1 | 0-1 |
| 1912.5 | 26665 | 5 | 16-QAM | 1 | 12 | 22.5 | 21.83 | 1 | 0-1 |
| 1912.5 | 26665 | 5 | 16-QAM | 1 | 24 | 22.5 | 21.64 | 1 | 0-1 |
| 1912.5 | 26665 | 5 | 16-QAM | 12 | 0 | 21.5 | 20.91 | 2 | 0-2 |
| 1912.5 | 26665 | 5 | 16-QAM | 12 | 6 | 21.5 | 20.95 | 2 | 0-2 |
| 1912.5 | 26665 | 5 | 16-QAM | 12 | 13 | 21.5 | 20.90 | 2 | 0-2 |
| 1912.5 | 26665 | 5 | 16-QAM | 25 | 0 | 21.5 | 20.85 | 2 | 0-2 |





| | | | | |
|---|---|--------------------------------------|---|--|
| FCC ID A3LSPHL520 |  PCTEST ENGINEERING LABORATORY, INC. | SAR EVALUATION REPORT |  | Reviewed by: Quality Manager |
| Document S/N: OY1306281121-R2.A3L | Test Dates: 07/01/13 - 07/19/13 | DUT Type: Portable Handset | Page 29 of 60 | |

Table 9-7
LTE Band 25 (PCS) Conducted Powers - 3 MHz Bandwidth

| Frequency [MHz] | Channel | Bandwidth [MHz] | Modulation | RB Size | RB Offset | Maximum Allowed Power [dBm] | Conducted Power [dBm] | Target MPR [dB] | MPR Allowed per 3GPP [dB] |
|-----------------|---------|-----------------|------------|---------|-----------|-----------------------------|-----------------------|-----------------|---------------------------|
| 1851.5 | 26055 | 3 | QPSK | 1 | 0 | 23.5 | 23.14 | 0 | 0 |
| 1851.5 | 26055 | 3 | QPSK | 1 | 7 | 23.5 | 22.98 | 0 | 0 |
| 1851.5 | 26055 | 3 | QPSK | 1 | 14 | 23.5 | 22.99 | 0 | 0 |
| 1851.5 | 26055 | 3 | QPSK | 8 | 0 | 22.5 | 22.11 | 1 | 0-1 |
| 1851.5 | 26055 | 3 | QPSK | 8 | 4 | 22.5 | 22.01 | 1 | 0-1 |
| 1851.5 | 26055 | 3 | QPSK | 8 | 7 | 22.5 | 22.07 | 1 | 0-1 |
| 1851.5 | 26055 | 3 | QPSK | 15 | 0 | 22.5 | 21.95 | 1 | 0-1 |
| 1851.5 | 26055 | 3 | 16-QAM | 1 | 0 | 22.5 | 22.08 | 1 | 0-1 |
| 1851.5 | 26055 | 3 | 16-QAM | 1 | 7 | 22.5 | 22.04 | 1 | 0-1 |
| 1851.5 | 26055 | 3 | 16-QAM | 1 | 14 | 22.5 | 22.06 | 1 | 0-1 |
| 1851.5 | 26055 | 3 | 16-QAM | 8 | 0 | 21.5 | 21.02 | 2 | 0-2 |
| 1851.5 | 26055 | 3 | 16-QAM | 8 | 4 | 21.5 | 21.03 | 2 | 0-2 |
| 1851.5 | 26055 | 3 | 16-QAM | 8 | 7 | 21.5 | 21.09 | 2 | 0-2 |
| 1851.5 | 26055 | 3 | 16-QAM | 15 | 0 | 21.5 | 21.06 | 2 | 0-2 |
| 1882.5 | 26365 | 3 | QPSK | 1 | 0 | 23.5 | 23.08 | 0 | 0 |
| 1882.5 | 26365 | 3 | QPSK | 1 | 7 | 23.5 | 23.01 | 0 | 0 |
| 1882.5 | 26365 | 3 | QPSK | 1 | 14 | 23.5 | 23.02 | 0 | 0 |
| 1882.5 | 26365 | 3 | QPSK | 8 | 0 | 22.5 | 22.06 | 1 | 0-1 |
| 1882.5 | 26365 | 3 | QPSK | 8 | 4 | 22.5 | 22.00 | 1 | 0-1 |
| 1882.5 | 26365 | 3 | QPSK | 8 | 7 | 22.5 | 22.09 | 1 | 0-1 |
| 1882.5 | 26365 | 3 | QPSK | 15 | 0 | 22.5 | 22.03 | 1 | 0-1 |
| 1882.5 | 26365 | 3 | 16-QAM | 1 | 0 | 22.5 | 22.12 | 1 | 0-1 |
| 1882.5 | 26365 | 3 | 16-QAM | 1 | 7 | 22.5 | 22.02 | 1 | 0-1 |
| 1882.5 | 26365 | 3 | 16-QAM | 1 | 14 | 22.5 | 21.99 | 1 | 0-1 |
| 1882.5 | 26365 | 3 | 16-QAM | 8 | 0 | 21.5 | 21.05 | 2 | 0-2 |
| 1882.5 | 26365 | 3 | 16-QAM | 8 | 4 | 21.5 | 21.03 | 2 | 0-2 |
| 1882.5 | 26365 | 3 | 16-QAM | 8 | 7 | 21.5 | 21.12 | 2 | 0-2 |
| 1882.5 | 26365 | 3 | 16-QAM | 15 | 0 | 21.5 | 21.05 | 2 | 0-2 |
| 1913.5 | 26675 | 3 | QPSK | 1 | 0 | 23.5 | 23.04 | 0 | 0 |
| 1913.5 | 26675 | 3 | QPSK | 1 | 7 | 23.5 | 22.91 | 0 | 0 |
| 1913.5 | 26675 | 3 | QPSK | 1 | 14 | 23.5 | 22.88 | 0 | 0 |
| 1913.5 | 26675 | 3 | QPSK | 8 | 0 | 22.5 | 21.93 | 1 | 0-1 |
| 1913.5 | 26675 | 3 | QPSK | 8 | 4 | 22.5 | 21.91 | 1 | 0-1 |
| 1913.5 | 26675 | 3 | QPSK | 8 | 7 | 22.5 | 21.86 | 1 | 0-1 |
| 1913.5 | 26675 | 3 | QPSK | 15 | 0 | 22.5 | 21.86 | 1 | 0-1 |
| 1913.5 | 26675 | 3 | 16-QAM | 1 | 0 | 22.5 | 22.04 | 1 | 0-1 |
| 1913.5 | 26675 | 3 | 16-QAM | 1 | 7 | 22.5 | 21.95 | 1 | 0-1 |
| 1913.5 | 26675 | 3 | 16-QAM | 1 | 14 | 22.5 | 21.80 | 1 | 0-1 |
| 1913.5 | 26675 | 3 | 16-QAM | 8 | 0 | 21.5 | 20.81 | 2 | 0-2 |
| 1913.5 | 26675 | 3 | 16-QAM | 8 | 4 | 21.5 | 20.74 | 2 | 0-2 |
| 1913.5 | 26675 | 3 | 16-QAM | 8 | 7 | 21.5 | 20.84 | 2 | 0-2 |
| 1913.5 | 26675 | 3 | 16-QAM | 15 | 0 | 21.5 | 20.82 | 2 | 0-2 |

| | | | | |
|--------------------------------------|---|-------------------------------|---|---------------------------------|
| FCC ID A3LSPHL520 |  | SAR EVALUATION REPORT |  | Reviewed by: Quality Manager |
| Document S/N: OY1306281121-R2.A3L | Test Dates: 07/01/13 - 07/19/13 | DUT Type: Portable Handset | Page 30 of 60 | |



9.2.3

LTE Band 41

Table 9-8
LTE Band 41 Conducted Powers - 20 MHz Bandwidth

| Frequency [MHz] | Channel | Bandwidth [MHz] | Modulation | RB Size | RB Offset | Maximum Allowed Power [dBm] | Conducted Power [dBm] | Target MPR [dB] | MPR Allowed per 3GPP [dB] |
|-----------------|---------|-----------------|------------|---------|-----------|-----------------------------|-----------------------|-----------------|---------------------------|
| 2506 | 39750 | 20 | QPSK | 1 | 0 | 23.5 | 23.08 | 0 | 0 |
| 2506 | 39750 | 20 | QPSK | 1 | 50 | 23.5 | 23.25 | 0 | 0 |
| 2506 | 39750 | 20 | QPSK | 1 | 99 | 23.5 | 23.13 | 0 | 0 |
| 2506 | 39750 | 20 | QPSK | 50 | 0 | 22.5 | 22.15 | 1 | 0-1 |
| 2506 | 39750 | 20 | QPSK | 50 | 25 | 22.5 | 22.04 | 1 | 0-1 |
| 2506 | 39750 | 20 | QPSK | 50 | 50 | 22.5 | 22.05 | 1 | 0-1 |
| 2506 | 39750 | 20 | QPSK | 100 | 0 | 22.5 | 22.13 | 1 | 0-1 |
| 2506 | 39750 | 20 | 16QAM | 1 | 0 | 22.5 | 21.99 | 1 | 0-1 |
| 2506 | 39750 | 20 | 16QAM | 1 | 50 | 22.5 | 22.16 | 1 | 0-1 |
| 2506 | 39750 | 20 | 16QAM | 1 | 99 | 22.5 | 22.03 | 1 | 0-1 |
| 2506 | 39750 | 20 | 16QAM | 50 | 0 | 21.5 | 21.38 | 2 | 0-2 |
| 2506 | 39750 | 20 | 16QAM | 50 | 25 | 21.5 | 21.31 | 2 | 0-2 |
| 2506 | 39750 | 20 | 16QAM | 50 | 50 | 21.5 | 21.12 | 2 | 0-2 |
| 2506 | 39750 | 20 | 16QAM | 100 | 0 | 21.5 | 21.21 | 2 | 0-2 |
| 2549.5 | 40185 | 20 | QPSK | 1 | 0 | 23.5 | 23.03 | 0 | 0 |
| 2549.5 | 40185 | 20 | QPSK | 1 | 50 | 23.5 | 23.13 | 0 | 0 |
| 2549.5 | 40185 | 20 | QPSK | 1 | 99 | 23.5 | 23.14 | 0 | 0 |
| 2549.5 | 40185 | 20 | QPSK | 50 | 0 | 22.5 | 21.94 | 1 | 0-1 |
| 2549.5 | 40185 | 20 | QPSK | 50 | 25 | 22.5 | 21.98 | 1 | 0-1 |
| 2549.5 | 40185 | 20 | QPSK | 50 | 50 | 22.5 | 21.95 | 1 | 0-1 |
| 2549.5 | 40185 | 20 | QPSK | 100 | 0 | 22.5 | 21.93 | 1 | 0-1 |
| 2549.5 | 40185 | 20 | 16-QAM | 1 | 0 | 22.5 | 22.02 | 1 | 0-1 |
| 2549.5 | 40185 | 20 | 16-QAM | 1 | 50 | 22.5 | 22.02 | 1 | 0-1 |
| 2549.5 | 40185 | 20 | 16-QAM | 1 | 99 | 22.5 | 22.04 | 1 | 0-1 |
| 2549.5 | 40185 | 20 | 16-QAM | 50 | 0 | 21.5 | 21.19 | 2 | 0-2 |
| 2549.5 | 40185 | 20 | 16-QAM | 50 | 25 | 21.5 | 21.15 | 2 | 0-2 |
| 2549.5 | 40185 | 20 | 16-QAM | 50 | 50 | 21.5 | 21.11 | 2 | 0-2 |
| 2549.5 | 40185 | 20 | 16-QAM | 100 | 0 | 21.5 | 21.13 | 2 | 0-2 |
| 2593 | 40620 | 20 | QPSK | 1 | 0 | 23.5 | 23.16 | 0 | 0 |
| 2593 | 40620 | 20 | QPSK | 1 | 50 | 23.5 | 23.08 | 0 | 0 |
| 2593 | 40620 | 20 | QPSK | 1 | 99 | 23.5 | 23.02 | 0 | 0 |
| 2593 | 40620 | 20 | QPSK | 50 | 0 | 22.5 | 22.03 | 1 | 0-1 |
| 2593 | 40620 | 20 | QPSK | 50 | 25 | 22.5 | 22.12 | 1 | 0-1 |
| 2593 | 40620 | 20 | QPSK | 50 | 50 | 22.5 | 21.98 | 1 | 0-1 |
| 2593 | 40620 | 20 | QPSK | 100 | 0 | 22.5 | 22.08 | 1 | 0-1 |
| 2593 | 40620 | 20 | 16-QAM | 1 | 0 | 22.5 | 22.10 | 1 | 0-1 |
| 2593 | 40620 | 20 | 16-QAM | 1 | 50 | 22.5 | 22.08 | 1 | 0-1 |
| 2593 | 40620 | 20 | 16-QAM | 1 | 99 | 22.5 | 21.99 | 1 | 0-1 |
| 2593 | 40620 | 20 | 16-QAM | 50 | 0 | 21.5 | 21.20 | 2 | 0-2 |
| 2593 | 40620 | 20 | 16-QAM | 50 | 25 | 21.5 | 21.18 | 2 | 0-2 |
| 2593 | 40620 | 20 | 16-QAM | 50 | 50 | 21.5 | 21.14 | 2 | 0-2 |
| 2593 | 40620 | 20 | 16-QAM | 100 | 0 | 21.5 | 21.18 | 2 | 0-2 |
| 2636.5 | 41055 | 20 | QPSK | 1 | 0 | 23.5 | 23.22 | 0 | 0 |
| 2636.5 | 41055 | 20 | QPSK | 1 | 50 | 23.5 | 23.03 | 0 | 0 |
| 2636.5 | 41055 | 20 | QPSK | 1 | 99 | 23.5 | 22.84 | 0 | 0 |
| 2636.5 | 41055 | 20 | QPSK | 50 | 0 | 22.5 | 21.83 | 1 | 0-1 |
| 2636.5 | 41055 | 20 | QPSK | 50 | 25 | 22.5 | 21.85 | 1 | 0-1 |
| 2636.5 | 41055 | 20 | QPSK | 50 | 50 | 22.5 | 21.75 | 1 | 0-1 |
| 2636.5 | 41055 | 20 | QPSK | 100 | 0 | 22.5 | 21.76 | 1 | 0-1 |
| 2636.5 | 41055 | 20 | 16-QAM | 1 | 0 | 22.5 | 22.13 | 1 | 0-1 |
| 2636.5 | 41055 | 20 | 16-QAM | 1 | 50 | 22.5 | 21.85 | 1 | 0-1 |
| 2636.5 | 41055 | 20 | 16-QAM | 1 | 99 | 22.5 | 21.86 | 1 | 0-1 |
| 2636.5 | 41055 | 20 | 16-QAM | 50 | 0 | 21.5 | 21.05 | 2 | 0-2 |
| 2636.5 | 41055 | 20 | 16-QAM | 50 | 25 | 21.5 | 21.03 | 2 | 0-2 |
| 2636.5 | 41055 | 20 | 16-QAM | 50 | 50 | 21.5 | 20.90 | 2 | 0-2 |
| 2636.5 | 41055 | 20 | 16-QAM | 100 | 0 | 21.5 | 20.99 | 2 | 0-2 |
| 2680 | 41490 | 20 | QPSK | 1 | 0 | 23.5 | 22.62 | 0 | 0 |
| 2680 | 41490 | 20 | QPSK | 1 | 50 | 23.5 | 23.42 | 0 | 0 |
| 2680 | 41490 | 20 | QPSK | 1 | 99 | 23.5 | 22.50 | 0 | 0 |
| 2680 | 41490 | 20 | QPSK | 50 | 0 | 22.5 | 22.06 | 1 | 0-1 |
| 2680 | 41490 | 20 | QPSK | 50 | 25 | 22.5 | 22.19 | 1 | 0-1 |
| 2680 | 41490 | 20 | QPSK | 50 | 50 | 22.5 | 21.86 | 1 | 0-1 |
| 2680 | 41490 | 20 | QPSK | 100 | 0 | 22.5 | 22.01 | 1 | 0-1 |
| 2680 | 41490 | 20 | 16-QAM | 1 | 0 | 22.5 | 21.52 | 1 | 0-1 |
| 2680 | 41490 | 20 | 16-QAM | 1 | 50 | 22.5 | 22.25 | 1 | 0-1 |
| 2680 | 41490 | 20 | 16-QAM | 1 | 99 | 22.5 | 21.58 | 1 | 0-1 |
| 2680 | 41490 | 20 | 16-QAM | 50 | 0 | 21.5 | 21.35 | 2 | 0-2 |
| 2680 | 41490 | 20 | 16-QAM | 50 | 25 | 21.5 | 21.39 | 2 | 0-2 |
| 2680 | 41490 | 20 | 16-QAM | 50 | 50 | 21.5 | 21.22 | 2 | 0-2 |
| 2680 | 41490 | 20 | 16-QAM | 100 | 0 | 21.5 | 21.20 | 2 | 0-2 |

Note: LTE Band 41 has 5 required test channels per FCC KDB Publication 447498 D01.

| | | | | |
|--------------------------------------|--|-------------------------------|---|---------------------------------|
| FCC ID A3LSPHL520 |  PCTEST Engineering Laboratory, Inc. | SAR EVALUATION REPORT |  | Reviewed by: Quality Manager |
| Document S/N: OY1306281121-R2.A3L | Test Dates: 07/01/13 - 07/19/13 | DUT Type: Portable Handset | | Page 31 of 60 |

**Table 9-9
LTE Band 41 Conducted Powers - 15 MHz Bandwidth**

| Frequency [MHz] | Channel | Bandwidth [MHz] | Modulation | RB Size | RB Offset | Maximum Allowed Power [dBm] | Conducted Power [dBm] | Target MPR [dB] | MPR Allowed per 3GPP [dB] |
|-----------------|---------|-----------------|------------|---------|-----------|-----------------------------|-----------------------|-----------------|---------------------------|
| 2503.5 | 39725 | 15 | QPSK | 1 | 0 | 23.5 | 23.24 | 0 | 0 |
| 2503.5 | 39725 | 15 | QPSK | 1 | 36 | 23.5 | 23.49 | 0 | 0 |
| 2503.5 | 39725 | 15 | QPSK | 1 | 74 | 23.5 | 23.39 | 0 | 0 |
| 2503.5 | 39725 | 15 | QPSK | 36 | 0 | 22.5 | 22.37 | 1 | 0-1 |
| 2503.5 | 39725 | 15 | QPSK | 36 | 18 | 22.5 | 22.38 | 1 | 0-1 |
| 2503.5 | 39725 | 15 | QPSK | 36 | 37 | 22.5 | 22.21 | 1 | 0-1 |
| 2503.5 | 39725 | 15 | QPSK | 75 | 0 | 22.5 | 22.24 | 1 | 0-1 |
| 2503.5 | 39725 | 15 | 16QAM | 1 | 0 | 22.5 | 22.25 | 1 | 0-1 |
| 2503.5 | 39725 | 15 | 16QAM | 1 | 36 | 22.5 | 22.50 | 1 | 0-1 |
| 2503.5 | 39725 | 15 | 16QAM | 1 | 74 | 22.5 | 22.43 | 1 | 0-1 |
| 2503.5 | 39725 | 15 | 16QAM | 36 | 0 | 21.5 | 21.36 | 2 | 0-2 |
| 2503.5 | 39725 | 15 | 16QAM | 36 | 18 | 21.5 | 21.34 | 2 | 0-2 |
| 2503.5 | 39725 | 15 | 16QAM | 36 | 37 | 21.5 | 21.20 | 2 | 0-2 |
| 2503.5 | 39725 | 15 | 16QAM | 75 | 0 | 21.5 | 21.18 | 2 | 0-2 |
| 2548.3 | 40173 | 15 | QPSK | 1 | 0 | 23.5 | 23.34 | 0 | 0 |
| 2548.3 | 40173 | 15 | QPSK | 1 | 36 | 23.5 | 23.32 | 0 | 0 |
| 2548.3 | 40173 | 15 | QPSK | 1 | 74 | 23.5 | 23.27 | 0 | 0 |
| 2548.3 | 40173 | 15 | QPSK | 36 | 0 | 22.5 | 22.27 | 1 | 0-1 |
| 2548.3 | 40173 | 15 | QPSK | 36 | 18 | 22.5 | 22.21 | 1 | 0-1 |
| 2548.3 | 40173 | 15 | QPSK | 36 | 37 | 22.5 | 22.17 | 1 | 0-1 |
| 2548.3 | 40173 | 15 | QPSK | 75 | 0 | 22.5 | 22.16 | 1 | 0-1 |
| 2548.3 | 40173 | 15 | 16-QAM | 1 | 0 | 22.5 | 22.47 | 1 | 0-1 |
| 2548.3 | 40173 | 15 | 16-QAM | 1 | 36 | 22.5 | 22.45 | 1 | 0-1 |
| 2548.3 | 40173 | 15 | 16-QAM | 1 | 74 | 22.5 | 22.43 | 1 | 0-1 |
| 2548.3 | 40173 | 15 | 16-QAM | 36 | 0 | 21.5 | 21.41 | 2 | 0-2 |
| 2548.3 | 40173 | 15 | 16-QAM | 36 | 18 | 21.5 | 21.28 | 2 | 0-2 |
| 2548.3 | 40173 | 15 | 16-QAM | 36 | 37 | 21.5 | 21.24 | 2 | 0-2 |
| 2548.3 | 40173 | 15 | 16-QAM | 75 | 0 | 21.5 | 21.22 | 2 | 0-2 |
| 2593 | 40620 | 15 | QPSK | 1 | 0 | 23.5 | 23.28 | 0 | 0 |
| 2593 | 40620 | 15 | QPSK | 1 | 36 | 23.5 | 23.24 | 0 | 0 |
| 2593 | 40620 | 15 | QPSK | 1 | 74 | 23.5 | 23.22 | 0 | 0 |
| 2593 | 40620 | 15 | QPSK | 36 | 0 | 22.5 | 22.11 | 1 | 0-1 |
| 2593 | 40620 | 15 | QPSK | 36 | 18 | 22.5 | 22.10 | 1 | 0-1 |
| 2593 | 40620 | 15 | QPSK | 36 | 37 | 22.5 | 22.01 | 1 | 0-1 |
| 2593 | 40620 | 15 | QPSK | 75 | 0 | 22.5 | 21.98 | 1 | 0-1 |
| 2593 | 40620 | 15 | 16-QAM | 1 | 0 | 22.5 | 22.39 | 1 | 0-1 |
| 2593 | 40620 | 15 | 16-QAM | 1 | 36 | 22.5 | 22.32 | 1 | 0-1 |
| 2593 | 40620 | 15 | 16-QAM | 1 | 74 | 22.5 | 22.38 | 1 | 0-1 |
| 2593 | 40620 | 15 | 16-QAM | 36 | 0 | 21.5 | 21.26 | 2 | 0-2 |
| 2593 | 40620 | 15 | 16-QAM | 36 | 18 | 21.5 | 21.25 | 2 | 0-2 |
| 2593 | 40620 | 15 | 16-QAM | 36 | 37 | 21.5 | 21.20 | 2 | 0-2 |
| 2593 | 40620 | 15 | 16-QAM | 75 | 0 | 21.5 | 21.05 | 2 | 0-2 |
| 2637.8 | 41068 | 15 | QPSK | 1 | 0 | 23.5 | 23.23 | 0 | 0 |
| 2637.8 | 41068 | 15 | QPSK | 1 | 36 | 23.5 | 23.20 | 0 | 0 |
| 2637.8 | 41068 | 15 | QPSK | 1 | 74 | 23.5 | 23.25 | 0 | 0 |
| 2637.8 | 41068 | 15 | QPSK | 36 | 0 | 22.5 | 22.06 | 1 | 0-1 |
| 2637.8 | 41068 | 15 | QPSK | 36 | 18 | 22.5 | 21.96 | 1 | 0-1 |
| 2637.8 | 41068 | 15 | QPSK | 36 | 37 | 22.5 | 22.00 | 1 | 0-1 |
| 2637.8 | 41068 | 15 | QPSK | 75 | 0 | 22.5 | 21.95 | 1 | 0-1 |
| 2637.8 | 41068 | 15 | 16-QAM | 1 | 0 | 22.5 | 22.43 | 1 | 0-1 |
| 2637.8 | 41068 | 15 | 16-QAM | 1 | 36 | 22.5 | 22.34 | 1 | 0-1 |
| 2637.8 | 41068 | 15 | 16-QAM | 1 | 74 | 22.5 | 22.42 | 1 | 0-1 |
| 2637.8 | 41068 | 15 | 16-QAM | 36 | 0 | 21.5 | 21.15 | 2 | 0-2 |
| 2637.8 | 41068 | 15 | 16-QAM | 36 | 18 | 21.5 | 21.11 | 2 | 0-2 |
| 2637.8 | 41068 | 15 | 16-QAM | 36 | 37 | 21.5 | 21.08 | 2 | 0-2 |
| 2637.8 | 41068 | 15 | 16-QAM | 75 | 0 | 21.5 | 20.87 | 2 | 0-2 |
| 2682.5 | 41515 | 15 | QPSK | 1 | 0 | 23.5 | 23.50 | 0 | 0 |
| 2682.5 | 41515 | 15 | QPSK | 1 | 36 | 23.5 | 23.48 | 0 | 0 |
| 2682.5 | 41515 | 15 | QPSK | 1 | 74 | 23.5 | 22.74 | 0 | 0 |
| 2682.5 | 41515 | 15 | QPSK | 36 | 0 | 22.5 | 22.40 | 1 | 0-1 |
| 2682.5 | 41515 | 15 | QPSK | 36 | 18 | 22.5 | 22.27 | 1 | 0-1 |
| 2682.5 | 41515 | 15 | QPSK | 36 | 37 | 22.5 | 22.00 | 1 | 0-1 |
| 2682.5 | 41515 | 15 | QPSK | 75 | 0 | 22.5 | 22.15 | 1 | 0-1 |
| 2682.5 | 41515 | 15 | 16-QAM | 1 | 0 | 22.5 | 22.49 | 1 | 0-1 |
| 2682.5 | 41515 | 15 | 16-QAM | 1 | 36 | 22.5 | 22.50 | 1 | 0-1 |
| 2682.5 | 41515 | 15 | 16-QAM | 1 | 74 | 22.5 | 21.84 | 1 | 0-1 |
| 2682.5 | 41515 | 15 | 16-QAM | 36 | 0 | 21.5 | 21.49 | 2 | 0-2 |
| 2682.5 | 41515 | 15 | 16-QAM | 36 | 18 | 21.5 | 21.33 | 2 | 0-2 |
| 2682.5 | 41515 | 15 | 16-QAM | 36 | 37 | 21.5 | 21.16 | 2 | 0-2 |
| 2682.5 | 41515 | 15 | 16-QAM | 75 | 0 | 21.5 | 21.15 | 2 | 0-2 |

Note: LTE Band 41 has 5 required test channels per FCC KDB Publication 447498 D01.





| | | | | |
|--------------------------------------|---|-------------------------------|---|---------------------------------|
| FCC ID A3LSPHL520 |  | SAR EVALUATION REPORT |  | Reviewed by: Quality Manager |
| Document S/N: OY1306281121-R2.A3L | Test Dates: 07/01/13 - 07/19/13 | DUT Type: Portable Handset | Page 32 of 60 | |

Table 9-10
LTE Band 41 Conducted Powers - 10 MHz Bandwidth

| Frequency [MHz] | Channel | Bandwidth [MHz] | Modulation | RB Size | RB Offset | Maximum Allowed Power [dBm] | Conducted Power [dBm] | Target MPR [dB] | MPR Allowed per 3GPP [dB] |
|-----------------|---------|-----------------|------------|---------|-----------|-----------------------------|-----------------------|-----------------|---------------------------|
| 2501 | 39700 | 10 | QPSK | 1 | 0 | 23.5 | 23.24 | 0 | 0 |
| 2501 | 39700 | 10 | QPSK | 1 | 25 | 23.5 | 23.48 | 0 | 0 |
| 2501 | 39700 | 10 | QPSK | 1 | 49 | 23.5 | 23.46 | 0 | 0 |
| 2501 | 39700 | 10 | QPSK | 25 | 0 | 22.5 | 22.36 | 1 | 0-1 |
| 2501 | 39700 | 10 | QPSK | 25 | 12 | 22.5 | 22.42 | 1 | 0-1 |
| 2501 | 39700 | 10 | QPSK | 25 | 25 | 22.5 | 22.48 | 1 | 0-1 |
| 2501 | 39700 | 10 | QPSK | 50 | 0 | 22.5 | 22.40 | 1 | 0-1 |
| 2501 | 39700 | 10 | 16QAM | 1 | 0 | 22.5 | 22.46 | 1 | 0-1 |
| 2501 | 39700 | 10 | 16QAM | 1 | 25 | 22.5 | 22.50 | 1 | 0-1 |
| 2501 | 39700 | 10 | 16QAM | 1 | 49 | 22.5 | 22.49 | 1 | 0-1 |
| 2501 | 39700 | 10 | 16QAM | 25 | 0 | 21.5 | 21.37 | 2 | 0-2 |
| 2501 | 39700 | 10 | 16QAM | 25 | 12 | 21.5 | 21.47 | 2 | 0-2 |
| 2501 | 39700 | 10 | 16QAM | 25 | 25 | 21.5 | 21.46 | 2 | 0-2 |
| 2501 | 39700 | 10 | 16QAM | 50 | 0 | 21.5 | 21.32 | 2 | 0-2 |
| 2547 | 40160 | 10 | QPSK | 1 | 0 | 23.5 | 23.40 | 0 | 0 |
| 2547 | 40160 | 10 | QPSK | 1 | 25 | 23.5 | 23.43 | 0 | 0 |
| 2547 | 40160 | 10 | QPSK | 1 | 49 | 23.5 | 23.38 | 0 | 0 |
| 2547 | 40160 | 10 | QPSK | 25 | 0 | 22.5 | 22.25 | 1 | 0-1 |
| 2547 | 40160 | 10 | QPSK | 25 | 12 | 22.5 | 22.32 | 1 | 0-1 |
| 2547 | 40160 | 10 | QPSK | 25 | 25 | 22.5 | 22.30 | 1 | 0-1 |
| 2547 | 40160 | 10 | QPSK | 50 | 0 | 22.5 | 22.19 | 1 | 0-1 |
| 2547 | 40160 | 10 | 16-QAM | 1 | 0 | 22.5 | 22.44 | 1 | 0-1 |
| 2547 | 40160 | 10 | 16-QAM | 1 | 25 | 22.5 | 22.48 | 1 | 0-1 |
| 2547 | 40160 | 10 | 16-QAM | 1 | 49 | 22.5 | 22.34 | 1 | 0-1 |
| 2547 | 40160 | 10 | 16-QAM | 25 | 0 | 21.5 | 21.32 | 2 | 0-2 |
| 2547 | 40160 | 10 | 16-QAM | 25 | 12 | 21.5 | 21.36 | 2 | 0-2 |
| 2547 | 40160 | 10 | 16-QAM | 25 | 25 | 21.5 | 21.26 | 2 | 0-2 |
| 2547 | 40160 | 10 | 16-QAM | 50 | 0 | 21.5 | 21.17 | 2 | 0-2 |
| 2593 | 40620 | 10 | QPSK | 1 | 0 | 23.5 | 23.33 | 0 | 0 |
| 2593 | 40620 | 10 | QPSK | 1 | 25 | 23.5 | 23.30 | 0 | 0 |
| 2593 | 40620 | 10 | QPSK | 1 | 49 | 23.5 | 23.26 | 0 | 0 |
| 2593 | 40620 | 10 | QPSK | 25 | 0 | 22.5 | 22.23 | 1 | 0-1 |
| 2593 | 40620 | 10 | QPSK | 25 | 12 | 22.5 | 22.14 | 1 | 0-1 |
| 2593 | 40620 | 10 | QPSK | 25 | 25 | 22.5 | 22.20 | 1 | 0-1 |
| 2593 | 40620 | 10 | QPSK | 50 | 0 | 22.5 | 22.18 | 1 | 0-1 |
| 2593 | 40620 | 10 | 16-QAM | 1 | 0 | 22.5 | 22.48 | 1 | 0-1 |
| 2593 | 40620 | 10 | 16-QAM | 1 | 25 | 22.5 | 22.43 | 1 | 0-1 |
| 2593 | 40620 | 10 | 16-QAM | 1 | 49 | 22.5 | 22.45 | 1 | 0-1 |
| 2593 | 40620 | 10 | 16-QAM | 25 | 0 | 21.5 | 21.20 | 2 | 0-2 |
| 2593 | 40620 | 10 | 16-QAM | 25 | 12 | 21.5 | 21.17 | 2 | 0-2 |
| 2593 | 40620 | 10 | 16-QAM | 25 | 25 | 21.5 | 21.21 | 2 | 0-2 |
| 2593 | 40620 | 10 | 16-QAM | 50 | 0 | 21.5 | 21.15 | 2 | 0-2 |
| 2639 | 41080 | 10 | QPSK | 1 | 0 | 23.5 | 23.26 | 0 | 0 |
| 2639 | 41080 | 10 | QPSK | 1 | 25 | 23.5 | 23.13 | 0 | 0 |
| 2639 | 41080 | 10 | QPSK | 1 | 49 | 23.5 | 23.23 | 0 | 0 |
| 2639 | 41080 | 10 | QPSK | 25 | 0 | 22.5 | 22.09 | 1 | 0-1 |
| 2639 | 41080 | 10 | QPSK | 25 | 12 | 22.5 | 22.05 | 1 | 0-1 |
| 2639 | 41080 | 10 | QPSK | 25 | 25 | 22.5 | 22.02 | 1 | 0-1 |
| 2639 | 41080 | 10 | QPSK | 50 | 0 | 22.5 | 21.98 | 1 | 0-1 |
| 2639 | 41080 | 10 | 16-QAM | 1 | 0 | 22.5 | 22.32 | 1 | 0-1 |
| 2639 | 41080 | 10 | 16-QAM | 1 | 25 | 22.5 | 22.30 | 1 | 0-1 |
| 2639 | 41080 | 10 | 16-QAM | 1 | 49 | 22.5 | 22.34 | 1 | 0-1 |
| 2639 | 41080 | 10 | 16-QAM | 25 | 0 | 21.5 | 21.09 | 2 | 0-2 |
| 2639 | 41080 | 10 | 16-QAM | 25 | 12 | 21.5 | 21.03 | 2 | 0-2 |
| 2639 | 41080 | 10 | 16-QAM | 25 | 25 | 21.5 | 21.08 | 2 | 0-2 |
| 2639 | 41080 | 10 | 16-QAM | 50 | 0 | 21.5 | 20.91 | 2 | 0-2 |
| 2685 | 41540 | 10 | QPSK | 1 | 0 | 23.5 | 23.45 | 0 | 0 |
| 2685 | 41540 | 10 | QPSK | 1 | 25 | 23.5 | 23.41 | 0 | 0 |
| 2685 | 41540 | 10 | QPSK | 1 | 49 | 23.5 | 22.95 | 0 | 0 |
| 2685 | 41540 | 10 | QPSK | 25 | 0 | 22.5 | 22.50 | 1 | 0-1 |
| 2685 | 41540 | 10 | QPSK | 25 | 12 | 22.5 | 22.43 | 1 | 0-1 |
| 2685 | 41540 | 10 | QPSK | 25 | 25 | 22.5 | 22.20 | 1 | 0-1 |
| 2685 | 41540 | 10 | QPSK | 50 | 0 | 22.5 | 22.32 | 1 | 0-1 |
| 2685 | 41540 | 10 | 16-QAM | 1 | 0 | 22.5 | 22.43 | 1 | 0-1 |
| 2685 | 41540 | 10 | 16-QAM | 1 | 25 | 22.5 | 22.48 | 1 | 0-1 |
| 2685 | 41540 | 10 | 16-QAM | 1 | 49 | 22.5 | 22.15 | 1 | 0-1 |
| 2685 | 41540 | 10 | 16-QAM | 25 | 0 | 21.5 | 21.49 | 2 | 0-2 |
| 2685 | 41540 | 10 | 16-QAM | 25 | 12 | 21.5 | 21.46 | 2 | 0-2 |
| 2685 | 41540 | 10 | 16-QAM | 25 | 25 | 21.5 | 21.24 | 2 | 0-2 |
| 2685 | 41540 | 10 | 16-QAM | 50 | 0 | 21.5 | 21.31 | 2 | 0-2 |

Note: LTE Band 41 has 5 required test channels per FCC KDB Publication 447498 D01.

| | | | | |
|--------------------------------------|---|-------------------------------|---|---------------------------------|
| FCC ID A3LSPHL520 |  | SAR EVALUATION REPORT |  | Reviewed by: Quality Manager |
| Document S/N: OY1306281121-R2.A3L | Test Dates: 07/01/13 - 07/19/13 | DUT Type: Portable Handset | Page 33 of 60 | |

9.3 WLAN Conducted Powers

Table 9-11
IEEE 802.11b Average RF Power

| Mode | Freq [MHz] | Channel | 802.11b (2.4 GHz) Conducted Power [dBm] | | | |
|---------|---------------|---------|---|-------|-------|-------|
| | | | Data Rate [Mbps] | | | |
| | 1 | 2 | 5.5 | 11 | | |
| 802.11b | 2412 | 1* | 16.64 | 16.63 | 16.79 | 16.74 |
| 802.11b | 2437 | 6* | 16.89 | 16.95 | 16.98 | 16.97 |
| 802.11b | 2462 | 11* | 16.24 | 16.33 | 16.41 | 16.40 |

Table 9-12
IEEE 802.11g Average RF Power

| Mode | Freq [MHz] | Channel | 802.11g (2.4 GHz) Conducted Power [dBm] | | | | | | | |
|---------|---------------|---------|---|-------|-------|-------|-------|-------|-------|-------|
| | | | Data Rate [Mbps] | | | | | | | |
| | 6 | 9 | 12 | 18 | 24 | 36 | 48 | 54 | | |
| 802.11g | 2412 | 1 | 12.53 | 12.51 | 12.55 | 12.52 | 12.51 | 12.43 | 12.54 | 12.56 |
| 802.11g | 2437 | 6 | 12.35 | 12.34 | 12.41 | 12.37 | 12.34 | 12.42 | 12.41 | 12.44 |
| 802.11g | 2462 | 11 | 12.27 | 12.24 | 12.19 | 12.24 | 12.25 | 12.19 | 12.26 | 12.27 |



Table 9-13
IEEE 802.11n Average RF Power

| Mode | Freq [MHz] | Channel | 802.11n (2.4 GHz) Conducted Power [dBm] | | | | | | | |
|---------|---------------|---------|---|-------|-------|-------|-------|-------|-------|-------|
| | | | Data Rate [Mbps] | | | | | | | |
| | 6.5 | 13 | 20 | 26 | 39 | 52 | 58 | 65 | | |
| 802.11n | 2412 | 1 | 12.75 | 12.81 | 12.80 | 12.79 | 12.82 | 12.72 | 12.81 | 12.93 |
| 802.11n | 2437 | 6 | 12.64 | 12.73 | 12.72 | 12.71 | 12.73 | 12.68 | 12.72 | 12.67 |
| 802.11n | 2462 | 11 | 12.64 | 12.67 | 12.73 | 12.66 | 12.65 | 12.69 | 12.74 | 12.62 |

Table 9-14
IEEE 802.11a Average RF Power

| Mode | Freq [MHz] | Channel | 802.11a (5GHz) Conducted Power [dBm] | | | | | | | |
|---------|---------------|---------|--------------------------------------|-------|-------|-------|-------|-------|-------|-------|
| | | | Data Rate [Mbps] | | | | | | | |
| | 6 | 9 | 12 | 18 | 24 | 36 | 48 | 54 | | |
| 802.11a | 5180 | 36* | 11.78 | 11.89 | 11.84 | 11.89 | 11.78 | 11.89 | 11.96 | 11.94 |
| 802.11a | 5200 | 40 | 11.74 | 11.82 | 11.84 | 11.85 | 11.81 | 11.84 | 11.91 | 11.93 |
| 802.11a | 5220 | 44 | 11.81 | 11.82 | 11.84 | 11.80 | 11.83 | 11.87 | 11.89 | 11.91 |
| 802.11a | 5240 | 48* | 11.41 | 11.51 | 11.63 | 11.51 | 11.50 | 11.61 | 11.54 | 11.60 |
| 802.11a | 5260 | 52* | 11.93 | 11.96 | 11.70 | 11.76 | 11.96 | 11.98 | 11.74 | 11.86 |
| 802.11a | 5280 | 56 | 11.18 | 11.24 | 11.30 | 11.24 | 11.31 | 11.31 | 11.33 | 11.35 |
| 802.11a | 5300 | 60 | 11.77 | 11.44 | 11.37 | 11.33 | 11.29 | 11.36 | 11.54 | 11.46 |
| 802.11a | 5320 | 64* | 11.32 | 11.42 | 11.32 | 11.24 | 11.41 | 11.42 | 11.46 | 11.45 |
| 802.11a | 5500 | 100 | 11.24 | 11.29 | 11.31 | 11.32 | 11.24 | 11.30 | 11.37 | 11.29 |
| 802.11a | 5520 | 104* | 11.92 | 11.65 | 11.45 | 11.98 | 11.96 | 11.95 | 11.97 | 11.55 |
| 802.11a | 5540 | 108 | 11.60 | 11.66 | 11.68 | 11.93 | 11.83 | 11.56 | 11.65 | 11.55 |
| 802.11a | 5560 | 112 | 11.40 | 11.44 | 11.36 | 11.41 | 11.40 | 11.41 | 11.47 | 11.40 |
| 802.11a | 5580 | 116* | 11.80 | 11.73 | 11.43 | 11.85 | 11.79 | 11.82 | 11.86 | 11.90 |
| 802.11a | 5600 | 120 | N/A | N/A | N/A | N/A | N/A | N/A | N/A | N/A |
| 802.11a | 5620 | 124* | N/A | N/A | N/A | N/A | N/A | N/A | N/A | N/A |
| 802.11a | 5640 | 128 | N/A | N/A | N/A | N/A | N/A | N/A | N/A | N/A |
| 802.11a | 5660 | 132 | 11.38 | 11.36 | 11.48 | 11.49 | 11.42 | 11.48 | 11.50 | 11.46 |
| 802.11a | 5680 | 136* | 11.72 | 11.69 | 11.61 | 11.64 | 11.59 | 11.71 | 11.72 | 11.68 |
| 802.11a | 5700 | 140 | 11.61 | 11.63 | 11.62 | 11.70 | 11.68 | 11.66 | 11.62 | 11.66 |
| 802.11a | 5745 | 149* | 11.99 | 11.97 | 11.94 | 11.93 | 11.95 | 11.98 | 11.99 | 11.97 |
| 802.11a | 5765 | 153 | 11.68 | 11.68 | 11.65 | 11.72 | 11.69 | 11.76 | 11.74 | 11.68 |
| 802.11a | 5785 | 157* | 11.38 | 11.36 | 11.32 | 11.35 | 11.40 | 11.41 | 11.39 | 11.45 |
| 802.11a | 5805 | 161* | 11.42 | 11.44 | 11.50 | 11.47 | 11.45 | 11.58 | 11.55 | 11.48 |
| 802.11a | 5825 | 165 | 11.63 | 11.61 | 11.65 | 11.61 | 11.63 | 11.53 | 11.63 | 11.62 |

Per FCC KDB Publication 443999 and RSS-210 A9.2(3), transmission on channels which overlap the 5600-5650 MHz is prohibited as a client. This device does not transmit any beacons or initiate any transmissions in 5.3 and 5.5 GHz Band.

| | | | | |
|--------------------------------------|--|-------------------------------|---|---------------------------------|
| FCC ID A3LSPHL520 |  PCTEST TECHNOLOGICAL LABORATORY, INC. | SAR EVALUATION REPORT |  | Reviewed by: Quality Manager |
| Document S/N: OY1306281121-R2.A3L | Test Dates: 07/01/13 - 07/19/13 | DUT Type: Portable Handset | | Page 34 of 60 |

(*) – indicates default channels per KDB Publication 248227 D01v01r02. When the adjacent channels are higher in power than the default channels, these “required channels” are considered for SAR testing instead of the default channels.

Table 9-15
IEEE 802.11n (20 MHz) Average RF Power – 20 MHz Bandwidth

| Mode | Freq [MHz] | Channel | 20MHz BW 802.11n (5GHz) Conducted Power [dBm] | | | | | | | |
|---------|---------------|---------|---|-------|-------|-------|-------|-------|-------|-------|
| | | | Data Rate [Mbps] | | | | | | | |
| | | | 6.5 | 13 | 19.5 | 26 | 39 | 52 | 58.5 | 65 |
| 802.11n | 5180 | 36 | 11.89 | 11.96 | 11.99 | 11.94 | 11.91 | 11.98 | 11.97 | 11.99 |
| 802.11n | 5200 | 40 | 11.12 | 11.17 | 11.18 | 11.14 | 11.20 | 11.19 | 11.17 | 11.23 |
| 802.11n | 5220 | 44 | 11.16 | 11.18 | 11.19 | 11.12 | 11.20 | 11.19 | 11.23 | 11.20 |
| 802.11n | 5240 | 48 | 11.66 | 11.68 | 11.64 | 11.65 | 11.62 | 11.70 | 11.75 | 11.71 |
| 802.11n | 5260 | 52 | 11.26 | 11.31 | 11.37 | 11.24 | 11.30 | 11.37 | 11.30 | 11.34 |
| 802.11n | 5280 | 56 | 11.36 | 11.38 | 11.40 | 11.34 | 11.40 | 11.46 | 11.38 | 11.44 |
| 802.11n | 5300 | 60 | 10.99 | 10.96 | 11.03 | 11.04 | 10.96 | 11.03 | 10.98 | 11.02 |
| 802.11n | 5320 | 64 | 11.46 | 11.41 | 11.26 | 11.43 | 11.51 | 11.48 | 11.56 | 11.48 |
| 802.11n | 5500 | 100 | 11.36 | 11.38 | 11.39 | 11.34 | 11.29 | 11.36 | 11.43 | 11.44 |
| 802.11n | 5520 | 104 | 11.94 | 11.98 | 11.97 | 11.99 | 11.96 | 11.95 | 11.94 | 11.98 |
| 802.11n | 5540 | 108 | 11.20 | 11.19 | 11.24 | 11.19 | 11.24 | 11.21 | 11.24 | 11.26 |
| 802.11n | 5560 | 112 | 11.32 | 11.39 | 11.48 | 11.42 | 11.46 | 11.48 | 11.49 | 11.46 |
| 802.11n | 5580 | 116 | 11.83 | 11.87 | 11.84 | 11.95 | 11.90 | 11.96 | 11.94 | 11.97 |
| 802.11n | 5600 | 120 | N/A | N/A | N/A | N/A | N/A | N/A | N/A | N/A |
| 802.11n | 5620 | 124 | N/A | N/A | N/A | N/A | N/A | N/A | N/A | N/A |
| 802.11n | 5640 | 128 | N/A | N/A | N/A | N/A | N/A | N/A | N/A | N/A |
| 802.11n | 5660 | 132 | 11.51 | 11.55 | 11.53 | 11.56 | 11.58 | 11.57 | 11.56 | 11.58 |
| 802.11n | 5680 | 136 | 11.66 | 11.63 | 11.72 | 11.68 | 11.67 | 11.70 | 11.74 | 11.75 |
| 802.11n | 5700 | 140 | 11.73 | 11.70 | 11.74 | 11.71 | 11.67 | 11.75 | 11.71 | 11.73 |
| 802.11n | 5745 | 149 | 11.15 | 11.21 | 11.20 | 11.22 | 11.27 | 11.30 | 11.29 | 11.26 |
| 802.11n | 5765 | 153 | 11.69 | 11.70 | 11.72 | 11.75 | 11.80 | 11.79 | 11.81 | 11.73 |
| 802.11n | 5785 | 157 | 11.36 | 11.39 | 11.42 | 11.39 | 11.44 | 11.41 | 11.47 | 11.44 |
| 802.11n | 5805 | 161 | 11.46 | 11.47 | 11.64 | 11.59 | 11.55 | 11.57 | 11.68 | 11.69 |
| 802.11n | 5825 | 165 | 11.61 | 11.66 | 11.70 | 11.78 | 11.65 | 11.65 | 11.73 | 11.72 |

Table 9-16
IEEE 802.11n (40 MHz) Average RF Power – 40 MHz Bandwidth

| Mode | Freq [MHz] | Channel | 40MHz BW 802.11n (5GHz) Conducted Power [dBm] | | | | | | | |
|---------|---------------|---------|---|------|------|------|-------|-------|-------|-------|
| | | | Data Rate [Mbps] | | | | | | | |
| | | | 13.5 | 27 | 40.5 | 54 | 81 | 108 | 121.5 | 135 |
| 802.11n | 5190 | 38 | 9.50 | 9.51 | 9.48 | 9.39 | 9.29 | 9.22 | 9.47 | 9.43 |
| 802.11n | 5230 | 46 | 9.49 | 9.65 | 9.66 | 9.59 | 9.68 | 9.61 | 9.66 | 9.68 |
| 802.11n | 5270 | 54 | 9.73 | 9.67 | 9.76 | 9.79 | 9.76 | 9.73 | 9.75 | 9.74 |
| 802.11n | 5310 | 62 | 9.85 | 9.94 | 9.69 | 9.87 | 9.88 | 9.93 | 9.96 | 9.90 |
| 802.11n | 5510 | 102 | 9.82 | 9.81 | 9.86 | 9.77 | 9.72 | 9.96 | 9.84 | 9.87 |
| 802.11n | 5550 | 110 | 9.54 | 9.57 | 9.58 | 9.53 | 9.55 | 9.59 | 9.60 | 9.61 |
| 802.11n | 5590 | 118 | N/A | N/A | N/A | N/A | N/A | N/A | N/A | N/A |
| 802.11n | 5630 | 126 | N/A | N/A | N/A | N/A | N/A | N/A | N/A | N/A |
| 802.11n | 5670 | 134 | 9.86 | 9.96 | 9.95 | 9.94 | 9.93 | 9.97 | 9.95 | 9.96 |
| 802.11n | 5755 | 151 | 9.87 | 9.90 | 9.88 | 9.97 | 10.00 | 10.01 | 9.94 | 10.00 |
| 802.11n | 5795 | 159 | 9.19 | 9.20 | 9.19 | 9.15 | 9.01 | 9.05 | 9.29 | 9.30 |

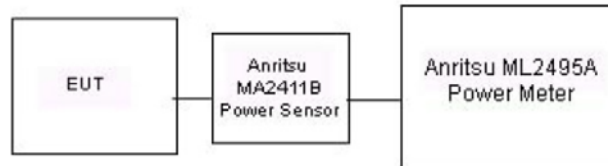





Figure 9-2
Power Measurement Setup

| | | | | |
|--------------------------------------|---|-------------------------------|---|---------------------------------|
| FCC ID A3LSPHL520 |  | SAR EVALUATION REPORT |  | Reviewed by: Quality Manager |
| Document S/N: OY1306281121-R2.A3L | Test Dates: 07/01/13 - 07/19/13 | DUT Type: Portable Handset | Page 35 of 60 | |

Justification for reduced test configurations for WIFI channels per KDB Publication 248227 D01v01r02 and October 2012/April 2013 FCC/TCB Meeting Notes:

- For 2.4 GHz, highest average RF output power channel for the lowest data rate for IEEE 802.11b were selected for SAR evaluation. Other IEEE 802.11 modes (including 802.11g/n) were not investigated since the average output powers over all channels and data rates were not more than 0.25 dB higher than the tested channel in the lowest data rate of IEEE 802.11b mode.
- For 5 GHz, highest average RF output power channel for the lowest data rate for IEEE 802.11a were selected for SAR evaluation. Other IEEE 802.11 modes (including 802.11n) were not investigated since the average output powers over all channels and data rates were not more than 0.25 dB higher than the tested channel in the lowest data rate of IEEE 802.11a mode.
- When the maximum extrapolated peak SAR of the zoom scan for the maximum output channel is <1.6 W/kg and the reported 1g averaged SAR is <0.8 W/kg, SAR testing on other channels is not required. Otherwise, the other default (or corresponding required) test channels were additionally tested using the lowest data rate.
- The bolded data rate and channel above were tested for SAR.



| | | | |
|---|---|--|--|
| FCC ID A3LSPHL520 |  | SAR EVALUATION REPORT  | Reviewed by: Quality Manager |
| Document S/N: 0Y1306281121-R2.A3L | Test Dates: 07/01/13 - 07/19/13 | DUT Type: Portable Handset | Page 36 of 60 |

10 SYSTEM VERIFICATION

10.1 Tissue Verification

**Table 10-1
Measured Head Tissue Properties**



| Calibrated for Tests Performed on: | Tissue Type | Tissue Temp During Calibration (C°) | Measured Frequency (MHz) | Measured Conductivity, σ (S/m) | Measured Dielectric Constant, ϵ | TARGET Conductivity, σ (S/m) | TARGET Dielectric Constant, ϵ | % dev σ | % dev ϵ |
|------------------------------------|-------------|-------------------------------------|--------------------------|---------------------------------------|--|-------------------------------------|--|----------------|------------------|
| 07/01/2013 | 835H | 23.1 | 820 | 0.914 | 41.200 | 0.898 | 41.571 | 1.78% | -0.89% |
| | | | 835 | 0.929 | 41.058 | 0.900 | 41.500 | 3.22% | -1.07% |
| | | | 850 | 0.943 | 40.914 | 0.916 | 41.500 | 2.95% | -1.41% |
| 07/15/2013 | 835H | 23.4 | 819 | 0.906 | 40.965 | 0.899 | 41.583 | 0.78% | -1.49% |
| | | | 823 | 0.909 | 40.916 | 0.899 | 41.562 | 1.11% | -1.55% |
| | | | 835 | 0.911 | 40.322 | 0.900 | 41.500 | 1.22% | -2.84% |
| 07/05/2013 | 1900H | 22.7 | 850 | 0.926 | 40.134 | 0.916 | 41.500 | 1.09% | -3.29% |
| | | | 1850 | 1.395 | 39.236 | 1.400 | 40.000 | -0.36% | -1.91% |
| | | | 1880 | 1.425 | 39.104 | 1.400 | 40.000 | 1.79% | -2.24% |
| 07/01/2013 | 2450H | 23.7 | 1910 | 1.456 | 38.966 | 1.400 | 40.000 | 4.00% | -2.59% |
| | | | 2401 | 1.820 | 40.110 | 1.758 | 39.298 | 3.53% | 2.07% |
| | | | 2450 | 1.876 | 39.890 | 1.800 | 39.200 | 4.22% | 1.76% |
| 07/18/2013 | 2450H | 24.0 | 2499 | 1.935 | 39.683 | 1.852 | 39.135 | 4.48% | 1.40% |
| | | | 2450 | 1.846 | 38.495 | 1.800 | 39.200 | 2.56% | -1.80% |
| | | | 2500 | 1.903 | 38.276 | 1.853 | 39.133 | 2.70% | -2.19% |
| | | | 2550 | 1.962 | 38.070 | 1.907 | 39.067 | 2.88% | -2.55% |
| | | | 2600 | 2.018 | 37.879 | 1.960 | 39.000 | 2.96% | -2.87% |
| | | | 2650 | 2.079 | 37.684 | 2.015 | 38.938 | 3.18% | -3.22% |
| 07/08/2013 | 5200H-5800H | 23.1 | 2700 | 2.137 | 37.478 | 2.070 | 38.875 | 3.24% | -3.59% |
| | | | 5200 | 4.468 | 35.069 | 4.660 | 36.000 | -4.12% | -2.59% |
| | | | 5220 | 4.485 | 35.044 | 4.680 | 35.980 | -4.17% | -2.60% |
| | | | 5260 | 4.525 | 34.989 | 4.720 | 35.940 | -4.13% | -2.65% |
| | | | 5300 | 4.565 | 34.928 | 4.760 | 35.900 | -4.10% | -2.71% |
| | | | 5500 | 4.760 | 34.630 | 4.965 | 35.650 | -4.13% | -2.86% |
| | | | 5520 | 4.783 | 34.606 | 4.986 | 35.620 | -4.07% | -2.85% |
| 5745 | 5.019 | 34.293 | 5.215 | 35.355 | -3.76% | -3.00% | | | |
| 5800 | 5.075 | 34.216 | 5.270 | 35.300 | -3.70% | -3.07% | | | |

| | | | | |
|--------------------------------------|---|-------------------------------|---|---------------------------------|
| FCC ID A3LSPHL520 |  | SAR EVALUATION REPORT |  | Reviewed by: Quality Manager |
| Document S/N: OY1306281121-R2.A3L | Test Dates: 07/01/13 - 07/19/13 | DUT Type: Portable Handset | Page 37 of 60 | |

**Table 10-2
Measured Body Tissue Properties**

| Calibrated for Tests Performed on: | Tissue Type | Tissue Temp During Calibration (C°) | Measured Frequency (MHz) | Measured Conductivity, σ (S/m) | Measured Dielectric Constant, ϵ | TARGET Conductivity, σ (S/m) | TARGET Dielectric Constant, ϵ | % dev σ | % dev ϵ |
|------------------------------------|-------------|-------------------------------------|--------------------------|---------------------------------------|--|-------------------------------------|--|----------------|------------------|
| 07/02/2013 | 835B | 22.8 | 815 | 0.944 | 57.238 | 0.968 | 55.278 | -2.48% | 3.55% |
| | | | 820 | 0.949 | 57.138 | 0.969 | 55.258 | -2.06% | 3.40% |
| | | | 835 | 0.955 | 56.964 | 0.970 | 55.200 | -1.55% | 3.20% |
| | | | 850 | 0.966 | 56.994 | 0.988 | 55.154 | -2.23% | 3.34% |
| 07/08/2013 | 835B | 23.5 | 820 | 0.996 | 55.968 | 0.969 | 55.258 | 2.79% | 1.28% |
| | | | 835 | 1.011 | 55.799 | 0.970 | 55.200 | 4.23% | 1.09% |
| | | | 850 | 1.027 | 55.659 | 0.988 | 55.154 | 3.95% | 0.92% |
| 07/15/2013 | 835B | 22.2 | 820 | 0.990 | 55.237 | 0.969 | 55.258 | 2.17% | -0.04% |
| | | | 835 | 1.006 | 55.079 | 0.970 | 55.200 | 3.71% | -0.22% |
| | | | 850 | 1.021 | 54.921 | 0.988 | 55.154 | 3.34% | -0.42% |
| 07/01/2013 | 1900B | 23.7 | 1850 | 1.468 | 52.002 | 1.520 | 53.300 | -3.42% | -2.44% |
| | | | 1880 | 1.497 | 51.920 | 1.520 | 53.300 | -1.51% | -2.59% |
| | | | 1910 | 1.539 | 51.762 | 1.520 | 53.300 | 1.25% | -2.89% |
| 07/08/2013 | 1900B | 22.6 | 1850 | 1.482 | 54.208 | 1.520 | 53.300 | -2.50% | 1.70% |
| | | | 1880 | 1.511 | 54.125 | 1.520 | 53.300 | -0.59% | 1.55% |
| | | | 1910 | 1.553 | 54.032 | 1.520 | 53.300 | 2.17% | 1.37% |
| 07/08/2013 | 2450B | 23.2 | 2401 | 1.941 | 53.298 | 1.903 | 52.765 | 2.00% | 1.01% |
| | | | 2450 | 2.015 | 53.219 | 1.950 | 52.700 | 3.33% | 0.98% |
| | | | 2499 | 2.081 | 52.924 | 2.019 | 52.638 | 3.07% | 0.54% |
| 07/19/2013 | 2450B | 23.8 | 2450 | 1.998 | 51.321 | 1.950 | 52.700 | 2.46% | -2.62% |
| | | | 2500 | 2.066 | 51.152 | 2.021 | 52.636 | 2.23% | -2.82% |
| | | | 2550 | 2.139 | 50.953 | 2.092 | 52.573 | 2.25% | -3.08% |
| | | | 2600 | 2.211 | 50.761 | 2.163 | 52.509 | 2.22% | -3.33% |
| | | | 2650 | 2.280 | 50.546 | 2.234 | 52.445 | 2.06% | -3.62% |
| | | | 2700 | 2.352 | 50.336 | 2.304 | 52.381 | 2.08% | -3.90% |
| 07/08/2013 | 5200B-5800B | 22.3 | 5200 | 5.215 | 46.814 | 5.299 | 49.014 | -1.59% | -4.49% |
| | | | 5220 | 5.257 | 46.901 | 5.323 | 48.987 | -1.24% | -4.26% |
| | | | 5240 | 5.320 | 46.766 | 5.346 | 48.933 | -0.49% | -4.43% |
| | | | 5260 | 5.331 | 46.752 | 5.369 | 48.906 | -0.71% | -4.40% |
| | | | 5300 | 5.366 | 46.619 | 5.416 | 48.851 | -0.92% | -4.57% |
| | | | 5500 | 5.721 | 46.329 | 5.650 | 48.580 | 1.26% | -4.63% |
| | | | 5520 | 5.763 | 46.291 | 5.673 | 48.553 | 1.59% | -4.66% |
| | | | 5580 | 5.868 | 46.221 | 5.743 | 48.471 | 2.18% | -4.64% |
| | | | 5600 | 5.899 | 46.249 | 5.766 | 48.444 | 2.31% | -4.53% |
| | | | 5680 | 6.016 | 46.163 | 5.860 | 48.336 | 2.66% | -4.50% |
| | | | 5745 | 6.139 | 46.170 | 5.936 | 48.248 | 3.42% | -4.31% |
| 5800 | 6.218 | 46.037 | 6.000 | 48.200 | 3.63% | -4.49% | | | |

The above measured tissue parameters were used in the DASYS software. The DASYS software was used to perform interpolation to determine the dielectric parameters at the SAR test device frequencies (per IEEE 1528 6.6.1.2). The tissue parameters listed in the SAR test plots may slightly differ from the table above due to significant digit rounding in the software.

| | | | | |
|--------------------------------------|---|-------------------------------|---|---------------------------------|
| FCC ID A3LSPHL520 |  | SAR EVALUATION REPORT |  | Reviewed by: Quality Manager |
| Document S/N: OY1306281121-R2.A3L | Test Dates: 07/01/13 - 07/19/13 | DUT Type: Portable Handset | Page 38 of 60 | |

10.2 Test System Verification

Prior to SAR assessment, the system is verified to $\pm 10\%$ of the SAR measurement on the reference dipole at the time of calibration by the calibration facility. Full system validation status and result summary can be found in Appendix E.

Table 10-3
System Verification Results

| System Verification TARGET & MEASURED | | | | | | | | | | | | |
|--|------------------------|-------------|------------|----------------|------------------|-----------------|-----------|----------|-----------------------------------|-------------------------------------|---|-----------------------------|
| SAR System # | Tissue Frequency (MHz) | Tissue Type | Date: | Amb. Temp (°C) | Liquid Temp (°C) | Input Power (W) | Dipole SN | Probe SN | Measured SAR _{1g} (W/kg) | 1 W Target SAR _{1g} (W/kg) | 1 W Normalized SAR _{1g} (W/kg) | Deviation _{1g} (%) |
| D | 835 | HEAD | 07/01/2013 | 23.9 | 23.2 | 0.100 | 4d132 | 3288 | 0.998 | 9.660 | 9.980 | 3.31% |
| E | 835 | HEAD | 07/15/2013 | 24.3 | 23.5 | 0.100 | 4d132 | 3920 | 0.975 | 9.660 | 9.750 | 0.93% |
| E | 1900 | HEAD | 07/05/2013 | 23.6 | 23.0 | 0.100 | 5d148 | 3920 | 4.060 | 39.700 | 40.600 | 2.27% |
| C | 2450 | HEAD | 07/01/2013 | 24.0 | 23.0 | 0.100 | 719 | 3022 | 5.480 | 52.700 | 54.800 | 3.98% |
| C | 2450 | HEAD | 07/18/2013 | 23.0 | 23.5 | 0.100 | 719 | 3022 | 5.620 | 52.700 | 56.200 | 6.64% |
| C | 2600 | HEAD | 07/18/2013 | 23.0 | 23.5 | 0.100 | 1004 | 3022 | 6.220 | 58.200 | 62.200 | 6.87% |
| E | 5200 | HEAD | 07/08/2013 | 24.4 | 23.1 | 0.040 | 1120 | 3920 | 3.030 | 76.000 | 75.750 | -0.33% |
| E | 5300 | HEAD | 07/08/2013 | 24.5 | 23.1 | 0.040 | 1120 | 3920 | 2.970 | 78.700 | 74.250 | -5.65% |
| E | 5500 | HEAD | 07/08/2013 | 24.5 | 23.2 | 0.040 | 1120 | 3920 | 2.980 | 80.100 | 74.500 | -6.99% |
| E | 5800 | HEAD | 07/08/2013 | 24.5 | 23.2 | 0.040 | 1120 | 3920 | 2.980 | 74.900 | 74.500 | -0.53% |
| B | 835 | BODY | 07/02/2013 | 23.5 | 22.2 | 0.100 | 4d026 | 3287 | 0.995 | 9.580 | 9.950 | 3.86% |
| G | 835 | BODY | 07/08/2013 | 24.5 | 23.5 | 0.100 | 4d132 | 3209 | 0.975 | 9.360 | 9.750 | 4.17% |
| G | 835 | BODY | 07/15/2013 | 24.4 | 23.0 | 0.100 | 4d132 | 3209 | 0.940 | 9.360 | 9.400 | 0.43% |
| C | 1900 | BODY | 07/01/2013 | 23.5 | 23.7 | 0.100 | 5d080 | 3022 | 4.020 | 40.300 | 40.200 | -0.25% |
| B | 1900 | BODY | 07/08/2013 | 23.2 | 22.8 | 0.100 | 5d080 | 3287 | 4.250 | 40.300 | 42.500 | 5.46% |
| C | 2450 | BODY | 07/08/2013 | 22.8 | 22.2 | 0.100 | 719 | 3022 | 5.170 | 51.600 | 51.700 | 0.19% |
| E | 2450 | BODY | 07/19/2013 | 24.4 | 23.9 | 0.100 | 797 | 3920 | 5.140 | 49.600 | 51.400 | 3.63% |
| E | 2600 | BODY | 07/19/2013 | 24.3 | 23.9 | 0.100 | 1004 | 3920 | 5.740 | 57.500 | 57.400 | -0.17% |
| A | 5200 | BODY | 07/08/2013 | 24.4 | 23.2 | 0.100 | 1057 | 3589 | 7.160 | 75.500 | 71.600 | -5.17% |
| A | 5300 | BODY | 07/08/2013 | 24.4 | 23.2 | 0.100 | 1057 | 3589 | 7.870 | 75.300 | 78.700 | 4.52% |
| A | 5500 | BODY | 07/08/2013 | 24.4 | 23.2 | 0.100 | 1057 | 3589 | 8.080 | 80.800 | 80.800 | 0.00% |
| A | 5600 | BODY | 07/08/2013 | 24.5 | 23.4 | 0.100 | 1057 | 3589 | 7.890 | 80.300 | 78.900 | -1.74% |
| A | 5800 | BODY | 07/08/2013 | 24.5 | 23.4 | 0.100 | 1057 | 3589 | 7.330 | 75.100 | 73.300 | -2.40% |

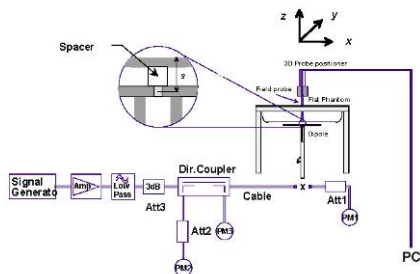

Figure 10-1
System Verification Setup Diagram



Figure 10-2
System Verification Setup Photo

| | | | | |
|--------------------------------------|--|-------------------------------|---------|---------------------------------|
| FCC ID A3LSPHL520 | PCTEST ENGINEERING LABORATORY, INC. | SAR EVALUATION REPORT | SAMSUNG | Reviewed by: Quality Manager |
| Document S/N: OY1306281121-R2.A3L | Test Dates: 07/01/13 - 07/19/13 | DUT Type: Portable Handset | | Page 39 of 60 |

11 SAR DATA SUMMARY



11.1 Standalone Head SAR Data

**Table 11-1
CDMA BC10 (§90S) Head SAR**

| MEASUREMENT RESULTS | | | | | | | | | | | | | | |
|---|-----|------------------|-------------|-----------------------------|-----------------------|------------------|---|---------------|----------------------|------------|----------|----------------|-----------------|--------|
| FREQUENCY | | Mode/Band | Service | Maximum Allowed Power [dBm] | Conducted Power [dBm] | Power Drift [dB] | Side | Test Position | Device Serial Number | Duty Cycle | SAR (1g) | Scaling Factor | Scaled SAR (1g) | Plot # |
| MHz | Ch. | | | | | | | | | | (W/kg) | | (W/kg) | |
| 820.10 | 564 | CDMA BC10 (§90S) | RC3 / SO55 | 25.0 | 24.91 | 0.03 | Right | Cheek | 051805a8 | 1:1 | 0.512 | 1.021 | 0.523 | |
| 820.10 | 564 | CDMA BC10 (§90S) | RC3 / SO55 | 25.0 | 24.91 | 0.09 | Right | Tilt | 051805a8 | 1:1 | 0.399 | 1.021 | 0.407 | |
| 820.10 | 564 | CDMA BC10 (§90S) | RC3 / SO55 | 25.0 | 24.91 | -0.01 | Left | Cheek | 051805a8 | 1:1 | 0.581 | 1.021 | 0.593 | A1 |
| 820.10 | 564 | CDMA BC10 (§90S) | RC3 / SO55 | 25.0 | 24.91 | -0.05 | Left | Tilt | 051805a8 | 1:1 | 0.429 | 1.021 | 0.438 | |
| 820.10 | 564 | CDMA BC10 (§90S) | EVDO Rev. A | 25.0 | 24.63 | 0.06 | Right | Cheek | 051805a8 | 1:1 | 0.343 | 1.089 | 0.374 | |
| 820.10 | 564 | CDMA BC10 (§90S) | EVDO Rev. A | 25.0 | 24.63 | 0.07 | Right | Tilt | 051805a8 | 1:1 | 0.308 | 1.089 | 0.335 | |
| 820.10 | 564 | CDMA BC10 (§90S) | EVDO Rev. A | 25.0 | 24.63 | 0.06 | Left | Cheek | 051805a8 | 1:1 | 0.464 | 1.089 | 0.505 | |
| 820.10 | 564 | CDMA BC10 (§90S) | EVDO Rev. A | 25.0 | 24.63 | -0.04 | Left | Tilt | 051805a8 | 1:1 | 0.392 | 1.089 | 0.427 | |
| ANSI / IEEE C95.1 1992 - SAFETY LIMIT Spatial Peak Uncontrolled Exposure/General Population | | | | | | | Head 1.6 W/kg (mW/g) averaged over 1 gram | | | | | | | |

**Table 11-2
CDMA BC0 (§22H) Head SAR**

| MEASUREMENT RESULTS | | | | | | | | | | | | | | |
|---|-----|-----------------|-------------|-----------------------------|-----------------------|------------------|---|---------------|----------------------|------------|----------|----------------|-----------------|--------|
| FREQUENCY | | Mode/Band | Service | Maximum Allowed Power [dBm] | Conducted Power [dBm] | Power Drift [dB] | Side | Test Position | Device Serial Number | Duty Cycle | SAR (1g) | Scaling Factor | Scaled SAR (1g) | Plot # |
| MHz | Ch. | | | | | | | | | | (W/kg) | | (W/kg) | |
| 836.52 | 384 | CDMA BC0 (§22H) | RC3 / SO55 | 25.0 | 24.75 | 0.15 | Right | Cheek | 051805a8 | 1:1 | 0.509 | 1.059 | 0.539 | |
| 836.52 | 384 | CDMA BC0 (§22H) | RC3 / SO55 | 25.0 | 24.75 | -0.12 | Right | Tilt | 051805a8 | 1:1 | 0.416 | 1.059 | 0.441 | |
| 836.52 | 384 | CDMA BC0 (§22H) | RC3 / SO55 | 25.0 | 24.75 | -0.10 | Left | Cheek | 051805a8 | 1:1 | 0.615 | 1.059 | 0.651 | A2 |
| 836.52 | 384 | CDMA BC0 (§22H) | RC3 / SO55 | 25.0 | 24.75 | -0.07 | Left | Tilt | 051805a8 | 1:1 | 0.450 | 1.059 | 0.477 | |
| 836.52 | 384 | CDMA BC0 (§22H) | EVDO Rev. A | 25.0 | 24.73 | -0.07 | Right | Cheek | 051805a8 | 1:1 | 0.475 | 1.064 | 0.505 | |
| 836.52 | 384 | CDMA BC0 (§22H) | EVDO Rev. A | 25.0 | 24.73 | -0.16 | Right | Tilt | 051805a8 | 1:1 | 0.377 | 1.064 | 0.401 | |
| 836.52 | 384 | CDMA BC0 (§22H) | EVDO Rev. A | 25.0 | 24.73 | 0.10 | Left | Cheek | 051805a8 | 1:1 | 0.577 | 1.064 | 0.614 | |
| 836.52 | 384 | CDMA BC0 (§22H) | EVDO Rev. A | 25.0 | 24.73 | -0.02 | Left | Tilt | 051805a8 | 1:1 | 0.448 | 1.064 | 0.477 | |
| ANSI / IEEE C95.1 1992 - SAFETY LIMIT Spatial Peak Uncontrolled Exposure/General Population | | | | | | | Head 1.6 W/kg (mW/g) averaged over 1 gram | | | | | | | |

| | | | | |
|--------------------------------------|---|-------------------------------|---|---------------------------------|
| FCC ID A3LSPHL520 |  | SAR EVALUATION REPORT |  | Reviewed by: Quality Manager |
| Document S/N: OY1306281121-R2.A3L | Test Dates: 07/01/13 - 07/19/13 | DUT Type: Portable Handset | | Page 40 of 60 |

**Table 11-3
PCS CDMA Head SAR**

| MEASUREMENT RESULTS | | | | | | | | | | | | | | |
|---|------|-----------|-------------|-----------------------------|-----------------------|------------------|---|---------------|----------------------|------------|----------|----------------|-----------------|--------|
| FREQUENCY | | Mode/Band | Service | Maximum Allowed Power [dBm] | Conducted Power [dBm] | Power Drift [dB] | Side | Test Position | Device Serial Number | Duty Cycle | SAR (1g) | Scaling Factor | Scaled SAR (1g) | Plot # |
| MHz | Ch. | | | | | | | | | | (W/kg) | | (W/kg) | |
| 1880.00 | 600 | PCS CDMA | RC3 / SO55 | 25.0 | 24.72 | 0.04 | Right | Cheek | 051804e0 | 1:1 | 0.457 | 1.067 | 0.488 | |
| 1880.00 | 600 | PCS CDMA | RC3 / SO55 | 25.0 | 24.72 | 0.06 | Right | Tilt | 051804e0 | 1:1 | 0.238 | 1.067 | 0.254 | |
| 1851.25 | 25 | PCS CDMA | RC3 / SO55 | 25.0 | 24.90 | 0.04 | Left | Cheek | 051804e0 | 1:1 | 0.582 | 1.023 | 0.595 | |
| 1880.00 | 600 | PCS CDMA | RC3 / SO55 | 25.0 | 24.72 | 0.04 | Left | Cheek | 051804e0 | 1:1 | 0.845 | 1.067 | 0.902 | |
| 1908.75 | 1175 | PCS CDMA | RC3 / SO55 | 25.0 | 24.76 | 0.05 | Left | Cheek | 051804e0 | 1:1 | 0.893 | 1.057 | 0.944 | |
| 1880.00 | 600 | PCS CDMA | RC3 / SO55 | 25.0 | 24.72 | 0.04 | Left | Tilt | 051804e0 | 1:1 | 0.215 | 1.067 | 0.229 | |
| 1880.00 | 600 | PCS CDMA | EVDO Rev. A | 25.0 | 24.75 | 0.06 | Right | Cheek | 051804e0 | 1:1 | 0.452 | 1.059 | 0.479 | |
| 1880.00 | 600 | PCS CDMA | EVDO Rev. A | 25.0 | 24.75 | -0.01 | Right | Tilt | 051804e0 | 1:1 | 0.263 | 1.059 | 0.279 | |
| 1851.25 | 25 | PCS CDMA | EVDO Rev. A | 25.0 | 24.84 | -0.01 | Left | Cheek | 051804e0 | 1:1 | 0.613 | 1.038 | 0.636 | |
| 1880.00 | 600 | PCS CDMA | EVDO Rev. A | 25.0 | 24.75 | -0.06 | Left | Cheek | 051804e0 | 1:1 | 0.865 | 1.059 | 0.916 | |
| 1908.75 | 1175 | PCS CDMA | EVDO Rev. A | 25.0 | 24.70 | 0.03 | Left | Cheek | 051804e0 | 1:1 | 0.900 | 1.072 | 0.965 | A3 |
| 1880.00 | 600 | PCS CDMA | EVDO Rev. A | 25.0 | 24.75 | 0.02 | Left | Tilt | 051804e0 | 1:1 | 0.239 | 1.059 | 0.253 | |
| ANSI / IEEE C95.1 1992 - SAFETY LIMIT Spatial Peak Uncontrolled Exposure/General Population | | | | | | | Head 1.6 W/kg (mW/g) averaged over 1 gram | | | | | | | |

**Table 11-4
LTE Band 26 Head SAR**

| MEASUREMENT RESULTS | | | | | | | | | | | | | | | | | | | |
|---|-------|------|-----------------|-----------------------------|-----------------------|------------------|---|------|---------------|------------|---------|-----------|----------------------|------------|----------|----------------|-----------------|--------|----|
| FREQUENCY | | Mode | Bandwidth [MHz] | Maximum Allowed Power [dBm] | Conducted Power [dBm] | Power Drift [dB] | MPR [dB] | Side | Test Position | Modulation | RB Size | RB Offset | Device Serial Number | Duty Cycle | SAR (1g) | Scaling Factor | Scaled SAR (1g) | Plot # | |
| MHz | Ch. | | | | | | | | | | | | | | (W/kg) | | (W/kg) | | |
| 819.00 | 26740 | Low | LTE Band 26 | 10 | 23.5 | 23.04 | 0.06 | 0 | Right | Cheek | QPSK | 1 | 49 | 05180482 | 1:1 | 0.327 | 1.112 | 0.364 | |
| 819.00 | 26740 | Low | LTE Band 26 | 10 | 22.5 | 21.79 | 0.07 | 1 | Right | Cheek | QPSK | 25 | 25 | 05180482 | 1:1 | 0.243 | 1.178 | 0.286 | |
| 819.00 | 26740 | Low | LTE Band 26 | 10 | 23.5 | 23.04 | 0.11 | 0 | Right | Tilt | QPSK | 1 | 49 | 05180482 | 1:1 | 0.277 | 1.112 | 0.308 | |
| 819.00 | 26740 | Low | LTE Band 26 | 10 | 22.5 | 21.79 | 0.03 | 1 | Right | Tilt | QPSK | 25 | 25 | 05180482 | 1:1 | 0.203 | 1.178 | 0.239 | |
| 819.00 | 26740 | Low | LTE Band 26 | 10 | 23.5 | 23.04 | 0.09 | 0 | Left | Cheek | QPSK | 1 | 49 | 05180482 | 1:1 | 0.373 | 1.112 | 0.415 | A4 |
| 819.00 | 26740 | Low | LTE Band 26 | 10 | 22.5 | 21.79 | 0.08 | 1 | Left | Cheek | QPSK | 25 | 25 | 05180482 | 1:1 | 0.286 | 1.178 | 0.337 | |
| 819.00 | 26740 | Low | LTE Band 26 | 10 | 23.5 | 23.04 | 0.07 | 0 | Left | Tilt | QPSK | 1 | 49 | 05180482 | 1:1 | 0.267 | 1.112 | 0.297 | |
| 819.00 | 26740 | Low | LTE Band 26 | 10 | 22.5 | 21.79 | 0.06 | 1 | Left | Tilt | QPSK | 25 | 25 | 05180482 | 1:1 | 0.213 | 1.178 | 0.251 | |
| ANSI / IEEE C95.1 1992 - SAFETY LIMIT Spatial Peak Uncontrolled Exposure/General Population | | | | | | | Head 1.6 W/kg (mW/g) averaged over 1 gram | | | | | | | | | | | | |

**Table 11-5
LTE Band 25 (PCS) Head SAR**

| MEASUREMENT RESULTS | | | | | | | | | | | | | | | | | | | |
|---|-------|------|-------------------|-----------------------------|-----------------------|------------------|---|------|---------------|------------|---------|-----------|----------------------|------------|----------|----------------|-----------------|--------|----|
| FREQUENCY | | Mode | Bandwidth [MHz] | Maximum Allowed Power [dBm] | Conducted Power [dBm] | Power Drift [dB] | MPR [dB] | Side | Test Position | Modulation | RB Size | RB Offset | Device Serial Number | Duty Cycle | SAR (1g) | Scaling Factor | Scaled SAR (1g) | Plot # | |
| MHz | Ch. | | | | | | | | | | | | | | (W/kg) | | (W/kg) | | |
| 1855.00 | 26090 | Low | LTE Band 25 (PCS) | 10 | 23.5 | 23.13 | 0.01 | 0 | Right | Cheek | QPSK | 1 | 0 | 051805af | 1:1 | 0.264 | 1.089 | 0.287 | |
| 1855.00 | 26090 | Low | LTE Band 25 (PCS) | 10 | 22.5 | 21.93 | -0.02 | 1 | Right | Cheek | QPSK | 25 | 0 | 051805af | 1:1 | 0.193 | 1.140 | 0.220 | |
| 1855.00 | 26090 | Low | LTE Band 25 (PCS) | 10 | 23.5 | 23.13 | 0.02 | 0 | Right | Tilt | QPSK | 1 | 0 | 051805af | 1:1 | 0.157 | 1.089 | 0.171 | |
| 1855.00 | 26090 | Low | LTE Band 25 (PCS) | 10 | 22.5 | 21.93 | 0.07 | 1 | Right | Tilt | QPSK | 25 | 0 | 051805af | 1:1 | 0.116 | 1.140 | 0.132 | |
| 1855.00 | 26090 | Low | LTE Band 25 (PCS) | 10 | 23.5 | 23.13 | 0.06 | 0 | Left | Cheek | QPSK | 1 | 0 | 051805af | 1:1 | 0.474 | 1.089 | 0.516 | A5 |
| 1855.00 | 26090 | Low | LTE Band 25 (PCS) | 10 | 22.5 | 21.93 | 0.07 | 1 | Left | Cheek | QPSK | 25 | 0 | 051805af | 1:1 | 0.344 | 1.140 | 0.392 | |
| 1855.00 | 26090 | Low | LTE Band 25 (PCS) | 10 | 23.5 | 23.13 | 0.13 | 0 | Left | Tilt | QPSK | 1 | 0 | 051805af | 1:1 | 0.132 | 1.089 | 0.144 | |
| 1855.00 | 26090 | Low | LTE Band 25 (PCS) | 10 | 22.5 | 21.93 | 0.07 | 1 | Left | Tilt | QPSK | 25 | 0 | 051805af | 1:1 | 0.095 | 1.140 | 0.108 | |
| ANSI / IEEE C95.1 1992 - SAFETY LIMIT Spatial Peak Uncontrolled Exposure/General Population | | | | | | | Head 1.6 W/kg (mW/g) averaged over 1 gram | | | | | | | | | | | | |



| | | | | |
|--------------------------------------|---|-------------------------------|---|---------------------------------|
| FCC ID A3LSPHL520 |  | SAR EVALUATION REPORT |  | Reviewed by: Quality Manager |
| Document S/N: OY1306281121-R2.A3L | Test Dates: 07/01/13 - 07/19/13 | DUT Type: Portable Handset | | Page 41 of 60 |

Table 11-6
LTE Band 41 Head SAR



| MEASUREMENT RESULTS | | | | | | | | | | | | | | | | | | | |
|---|-------|----------|-----------------|-----------------------------|-----------------------|------------------|----------|------|---------------|---|---------|-----------|----------------------|------------|----------|----------------|-----------------|--------|----|
| FREQUENCY | | Mode | Bandwidth [MHz] | Maximum Allowed Power [dBm] | Conducted Power [dBm] | Power Drift [dB] | MPR [dB] | Side | Test Position | Modulation | RB Size | RB Offset | Device Serial Number | Duty Cycle | SAR (1g) | Scaling Factor | Scaled SAR (1g) | Plot # | |
| MHz | Ch. | | | | | | | | | | | | | | (W/kg) | | (W/kg) | | |
| 2680.00 | 41490 | High | LTE Band 41 | 20 | 23.5 | 23.42 | 0.09 | 0 | Right | Cheek | QPSK | 1 | 50 | 0518058e | 1:1.58 | 0.256 | 1.019 | 0.261 | |
| 2680.00 | 41490 | High | LTE Band 41 | 20 | 22.5 | 22.19 | 0.00 | 1 | Right | Cheek | QPSK | 50 | 25 | 0518058e | 1:1.58 | 0.239 | 1.074 | 0.257 | |
| 2680.00 | 41490 | High | LTE Band 41 | 20 | 23.5 | 23.42 | 0.03 | 0 | Right | Tilt | QPSK | 1 | 50 | 0518058e | 1:1.58 | 0.173 | 1.019 | 0.176 | |
| 2680.00 | 41490 | High | LTE Band 41 | 20 | 22.5 | 22.19 | -0.05 | 1 | Right | Tilt | QPSK | 50 | 25 | 0518058e | 1:1.58 | 0.156 | 1.074 | 0.168 | |
| 2506.00 | 39750 | Low | LTE Band 41 | 20 | 23.5 | 23.25 | 0.03 | 0 | Left | Cheek | QPSK | 1 | 50 | 0518058e | 1:1.58 | 0.567 | 1.059 | 0.600 | |
| 2549.50 | 40185 | Low-Mid | LTE Band 41 | 20 | 23.5 | 23.14 | 0.01 | 0 | Left | Cheek | QPSK | 1 | 99 | 0518058e | 1:1.58 | 0.531 | 1.086 | 0.577 | |
| 2593.00 | 40620 | Mid | LTE Band 41 | 20 | 23.5 | 23.16 | -0.21 | 0 | Left | Cheek | QPSK | 1 | 0 | 0518058e | 1:1.58 | 0.520 | 1.081 | 0.562 | |
| 2636.50 | 41055 | Mid-High | LTE Band 41 | 20 | 23.5 | 23.22 | -0.01 | 0 | Left | Cheek | QPSK | 1 | 0 | 0518058e | 1:1.58 | 0.623 | 1.067 | 0.665 | A6 |
| 2680.00 | 41490 | High | LTE Band 41 | 20 | 23.5 | 23.42 | -0.03 | 0 | Left | Cheek | QPSK | 1 | 50 | 0518058e | 1:1.58 | 0.595 | 1.019 | 0.606 | |
| 2680.00 | 41490 | High | LTE Band 41 | 20 | 22.5 | 22.19 | -0.04 | 1 | Left | Cheek | QPSK | 50 | 25 | 0518058e | 1:1.58 | 0.555 | 1.074 | 0.596 | |
| 2506.00 | 39750 | Low | LTE Band 41 | 20 | 22.5 | 22.13 | -0.05 | 1 | Left | Cheek | QPSK | 100 | 0 | 0518058e | 1:1.58 | 0.364 | 1.089 | 0.396 | |
| 2680.00 | 41490 | High | LTE Band 41 | 20 | 23.5 | 23.42 | -0.19 | 0 | Left | Tilt | QPSK | 1 | 50 | 0518058e | 1:1.58 | 0.128 | 1.019 | 0.130 | |
| 2680.00 | 41490 | High | LTE Band 41 | 20 | 22.5 | 22.19 | 0.08 | 1 | Left | Tilt | QPSK | 50 | 25 | 0518058e | 1:1.58 | 0.117 | 1.074 | 0.126 | |
| ANSI / IEEE C95.1 1992 - SAFETY LIMIT Spatial Peak Uncontrolled Exposure/General Population | | | | | | | | | | Head 1.6 W/kg (mW/g) averaged over 1 gram | | | | | | | | | |

Table 11-7
DTSS Head SAR

| MEASUREMENT RESULTS | | | | | | | | | | | | | | | | | |
|---|-----|--------------|---------|-----------------------------|-----------------------|------------------|-------|---------------|----------------------|---|------------|----------|----------------|-----------------|--------|--|--|
| FREQUENCY | | Mode | Service | Maximum Allowed Power [dBm] | Conducted Power [dBm] | Power Drift [dB] | Side | Test Position | Device Serial Number | Data Rate (Mbps) | Duty Cycle | SAR (1g) | Scaling Factor | Scaled SAR (1g) | Plot # | | |
| MHz | Ch. | | | | | | | | | | | (W/kg) | | (W/kg) | | | |
| 2437 | 6 | IEEE 802.11b | DSSS | 17.0 | 16.89 | 0.05 | Right | Cheek | 051804e0 | 1 | 1:1 | 0.032 | 1.026 | 0.033 | | | |
| 2437 | 6 | IEEE 802.11b | DSSS | 17.0 | 16.89 | 0.15 | Right | Tilt | 051804e0 | 1 | 1:1 | 0.030 | 1.026 | 0.031 | | | |
| 2437 | 6 | IEEE 802.11b | DSSS | 17.0 | 16.89 | 0.07 | Left | Cheek | 051804e0 | 1 | 1:1 | 0.090 | 1.026 | 0.092 | A7 | | |
| 2437 | 6 | IEEE 802.11b | DSSS | 17.0 | 16.89 | -0.17 | Left | Tilt | 051804e0 | 1 | 1:1 | 0.032 | 1.026 | 0.033 | | | |
| 5745 | 149 | IEEE 802.11a | OFDM | 12.0 | 11.99 | 0.19 | Right | Cheek | 051805a8 | 6 | 1:1 | 0.018 | 1.002 | 0.018 | | | |
| 5745 | 149 | IEEE 802.11a | OFDM | 12.0 | 11.99 | 0.17 | Right | Tilt | 051805a8 | 6 | 1:1 | 0.013 | 1.002 | 0.013 | | | |
| 5745 | 149 | IEEE 802.11a | OFDM | 12.0 | 11.99 | 0.14 | Left | Cheek | 051805a8 | 6 | 1:1 | 0.065 | 1.002 | 0.065 | A8 | | |
| 5745 | 149 | IEEE 802.11a | OFDM | 12.0 | 11.99 | 0.16 | Left | Tilt | 051805a8 | 6 | 1:1 | 0.016 | 1.002 | 0.016 | | | |
| ANSI / IEEE C95.1 1992 - SAFETY LIMIT Spatial Peak Uncontrolled Exposure/General Population | | | | | | | | | | Head 1.6 W/kg (mW/g) averaged over 1 gram | | | | | | | |

Table 11-8
NII Head SAR

| MEASUREMENT RESULTS | | | | | | | | | | | | | | | | | |
|---|-----|--------------|---------|-----------------------------|-----------------------|------------------|-------|---------------|----------------------|---|------------|----------|----------------|-----------------|--------|--|--|
| FREQUENCY | | Mode | Service | Maximum Allowed Power [dBm] | Conducted Power [dBm] | Power Drift [dB] | Side | Test Position | Device Serial Number | Data Rate (Mbps) | Duty Cycle | SAR (1g) | Scaling Factor | Scaled SAR (1g) | Plot # | | |
| MHz | Ch. | | | | | | | | | | | (W/kg) | | (W/kg) | | | |
| 5220 | 44 | IEEE 802.11a | OFDM | 12.0 | 11.81 | -0.17 | Right | Cheek | 051805a8 | 6 | 1:1 | 0.023 | 1.045 | 0.024 | | | |
| 5220 | 44 | IEEE 802.11a | OFDM | 12.0 | 11.81 | 0.17 | Right | Tilt | 051805a8 | 6 | 1:1 | 0.022 | 1.045 | 0.023 | | | |
| 5220 | 44 | IEEE 802.11a | OFDM | 12.0 | 11.81 | 0.16 | Left | Cheek | 051805a8 | 6 | 1:1 | 0.095 | 1.045 | 0.099 | | | |
| 5220 | 44 | IEEE 802.11a | OFDM | 12.0 | 11.81 | 0.19 | Left | Tilt | 051805a8 | 6 | 1:1 | 0.014 | 1.045 | 0.015 | | | |
| 5260 | 52 | IEEE 802.11a | OFDM | 12.0 | 11.93 | 0.16 | Right | Cheek | 051805a8 | 6 | 1:1 | 0.020 | 1.016 | 0.020 | | | |
| 5260 | 52 | IEEE 802.11a | OFDM | 12.0 | 11.93 | 0.13 | Right | Tilt | 051805a8 | 6 | 1:1 | 0.031 | 1.016 | 0.031 | | | |
| 5260 | 52 | IEEE 802.11a | OFDM | 12.0 | 11.93 | 0.21 | Left | Cheek | 051805a8 | 6 | 1:1 | 0.114 | 1.016 | 0.116 | A9 | | |
| 5260 | 52 | IEEE 802.11a | OFDM | 12.0 | 11.93 | 0.10 | Left | Tilt | 051805a8 | 6 | 1:1 | 0.022 | 1.016 | 0.022 | | | |
| 5520 | 104 | IEEE 802.11a | OFDM | 12.0 | 11.92 | 0.18 | Right | Cheek | 051805a8 | 6 | 1:1 | 0.033 | 1.019 | 0.034 | | | |
| 5520 | 104 | IEEE 802.11a | OFDM | 12.0 | 11.92 | 0.14 | Right | Tilt | 051805a8 | 6 | 1:1 | 0.043 | 1.019 | 0.044 | | | |
| 5520 | 104 | IEEE 802.11a | OFDM | 12.0 | 11.92 | -0.05 | Left | Cheek | 051805a8 | 6 | 1:1 | 0.088 | 1.019 | 0.090 | | | |
| 5520 | 104 | IEEE 802.11a | OFDM | 12.0 | 11.92 | 0.13 | Left | Tilt | 051805a8 | 6 | 1:1 | 0.030 | 1.019 | 0.031 | | | |
| ANSI / IEEE C95.1 1992 - SAFETY LIMIT Spatial Peak Uncontrolled Exposure/General Population | | | | | | | | | | Head 1.6 W/kg (mW/g) averaged over 1 gram | | | | | | | |

| | | | | |
|--------------------------------------|---|-------------------------------|---|---------------------------------|
| FCC ID A3LSPHL520 |  | SAR EVALUATION REPORT |  | Reviewed by: Quality Manager |
| Document S/N: OY1306281121-R2.A3L | Test Dates: 07/01/13 - 07/19/13 | DUT Type: Portable Handset | Page 42 of 60 | |

11.2 Standalone Body-Worn SAR Data

**Table 11-9
Body-Worn SAR Data**

| MEASUREMENT RESULTS | | | | | | | | | | | | | | |
|---|------|------------------|-------------|-----------------------------|-----------------------|------------------|---|----------------------|------------|------|----------|----------------|-----------------|--------|
| FREQUENCY | | Mode | Service | Maximum Allowed Power [dBm] | Conducted Power [dBm] | Power Drift [dB] | Spacing | Device Serial Number | Duty Cycle | Side | SAR (1g) | Scaling Factor | Scaled SAR (1g) | Plot # |
| MHz | Ch. | | | | | | | | | | (W/kg) | | (W/kg) | |
| 820.10 | 564 | CDMA BC10 (§90S) | TDSO / SO32 | 25.0 | 25.00 | 0.00 | 10 mm | 051805a8 | 1:1 | back | 1.030 | 1.000 | 1.030 | A10 |
| 824.70 | 1013 | CDMABC0 (§22H) | TDSO / SO32 | 25.0 | 24.75 | -0.05 | 10 mm | 051805a8 | 1:1 | back | 0.925 | 1.059 | 0.980 | |
| 836.52 | 384 | CDMABC0 (§22H) | TDSO / SO32 | 25.0 | 24.72 | -0.02 | 10 mm | 051805a8 | 1:1 | back | 0.947 | 1.067 | 1.010 | A12 |
| 848.31 | 777 | CDMABC0 (§22H) | TDSO / SO32 | 25.0 | 24.78 | 0.00 | 10 mm | 051805a8 | 1:1 | back | 0.817 | 1.052 | 0.859 | |
| 1851.25 | 25 | PCS CDMA | TDSO / SO32 | 25.0 | 24.83 | 0.00 | 10 mm | 051804e0 | 1:1 | back | 0.784 | 1.040 | 0.815 | |
| 1880.00 | 600 | PCS CDMA | TDSO / SO32 | 25.0 | 24.80 | 0.12 | 10 mm | 051804e0 | 1:1 | back | 1.010 | 1.047 | 1.057 | A14 |
| 1908.75 | 1175 | PCS CDMA | TDSO / SO32 | 25.0 | 24.72 | -0.01 | 10 mm | 051804e0 | 1:1 | back | 0.947 | 1.067 | 1.010 | |
| 1880.00 | 600 | PCS CDMA | TDSO / SO32 | 25.0 | 24.80 | -0.08 | 10 mm | 051804e0 | 1:1 | back | 0.954 | 1.047 | 0.999 | |
| ANSI / IEEE C95.1 1992 - SAFETY LIMIT Spatial Peak Uncontrolled Exposure/General Population | | | | | | | Body 1.6 W/kg (mW/g) averaged over 1 gram | | | | | | | |

Note: Blue entries represent variability measurements.



**Table 11-10
LTE Body-Worn SAR**

| MEASUREMENT RESULTS | | | | | | | | | | | | | | | | | | | |
|---|-------|----------|-------------------|-----------------------------|-----------------------|------------------|---|----------------------|------------|---------|-----------|---------|-------|------------|----------|----------------|-----------------|--------|-----|
| FREQUENCY | | Mode | Bandwidth [MHz] | Maximum Allowed Power [dBm] | Conducted Power [dBm] | Power Drift [dB] | MPR [dB] | Device Serial Number | Modulation | RB Size | RB Offset | Spacing | Side | Duty Cycle | SAR (1g) | Scaling Factor | Scaled SAR (1g) | Plot # | |
| MHz | Ch. | | | | | | | | | | | | | | (W/kg) | | (W/kg) | | |
| 819.00 | 26740 | Low | LTE Band 26 | 10 | 23.5 | 23.04 | -0.01 | 0 | 05180482 | QPSK | 1 | 49 | 10 mm | back | 1:1 | 0.478 | 1.112 | 0.532 | A16 |
| 819.00 | 26740 | Low | LTE Band 26 | 10 | 22.5 | 21.79 | 0.00 | 1 | 05180482 | QPSK | 25 | 25 | 10 mm | back | 1:1 | 0.363 | 1.178 | 0.428 | |
| 1855.00 | 26090 | Low | LTE Band 25 (PCS) | 10 | 23.5 | 23.13 | -0.01 | 0 | 051805af | QPSK | 1 | 0 | 10 mm | back | 1:1 | 0.384 | 1.089 | 0.418 | A18 |
| 1855.00 | 26090 | Low | LTE Band 25 (PCS) | 10 | 22.5 | 21.93 | 0.04 | 1 | 051805af | QPSK | 25 | 0 | 10 mm | back | 1:1 | 0.370 | 1.140 | 0.422 | |
| 2506.00 | 39750 | Low | LTE Band 41 | 20 | 23.5 | 23.25 | -0.06 | 0 | 0518058e | QPSK | 1 | 50 | 10 mm | back | 1:1.58 | 0.666 | 1.059 | 0.705 | |
| 2506.00 | 39750 | Low | LTE Band 41 | 20 | 22.5 | 22.15 | 0.07 | 1 | 0518058e | QPSK | 50 | 0 | 10 mm | back | 1:1.58 | 0.614 | 1.084 | 0.666 | |
| 2506.00 | 39750 | Low | LTE Band 41 | 20 | 22.5 | 22.13 | -0.02 | 1 | 0518058e | QPSK | 100 | 0 | 10 mm | back | 1:1.58 | 0.650 | 1.089 | 0.708 | |
| 2549.50 | 40185 | Low-Mid | LTE Band 41 | 20 | 23.5 | 23.14 | 0.01 | 0 | 0518058e | QPSK | 1 | 99 | 10 mm | back | 1:1.58 | 0.783 | 1.086 | 0.850 | |
| 2549.50 | 40185 | Low-Mid | LTE Band 41 | 20 | 22.5 | 21.98 | 0.08 | 1 | 0518058e | QPSK | 50 | 25 | 10 mm | back | 1:1.58 | 0.749 | 1.127 | 0.844 | |
| 2593.00 | 40620 | Mid | LTE Band 41 | 20 | 23.5 | 23.16 | 0.03 | 0 | 0518058e | QPSK | 1 | 0 | 10 mm | back | 1:1.58 | 0.890 | 1.081 | 0.962 | |
| 2593.00 | 40620 | Mid | LTE Band 41 | 20 | 22.5 | 22.12 | 0.04 | 1 | 0518058e | QPSK | 50 | 25 | 10 mm | back | 1:1.58 | 0.896 | 1.091 | 0.978 | |
| 2636.50 | 41055 | Mid-High | LTE Band 41 | 20 | 23.5 | 23.22 | 0.16 | 0 | 0518058e | QPSK | 1 | 0 | 10 mm | back | 1:1.58 | 1.030 | 1.067 | 1.099 | |
| 2636.50 | 41055 | Mid-High | LTE Band 41 | 20 | 22.5 | 21.85 | -0.01 | 1 | 0518058e | QPSK | 50 | 25 | 10 mm | back | 1:1.58 | 0.908 | 1.161 | 1.054 | |
| 2680.00 | 41490 | High | LTE Band 41 | 20 | 23.5 | 23.42 | 0.06 | 0 | 0518058e | QPSK | 1 | 50 | 10 mm | back | 1:1.58 | 0.711 | 1.019 | 0.725 | |
| 2680.00 | 41490 | High | LTE Band 41 | 20 | 22.5 | 22.19 | 0.04 | 1 | 0518058e | QPSK | 50 | 25 | 10 mm | back | 1:1.58 | 0.666 | 1.074 | 0.715 | |
| 2636.50 | 41055 | Mid-High | LTE Band 41 | 20 | 23.5 | 23.22 | -0.07 | 0 | 0518058e | QPSK | 1 | 0 | 10 mm | back | 1:1.58 | 1.030 | 1.067 | 1.099 | A20 |
| ANSI / IEEE C95.1 1992 - SAFETY LIMIT Spatial Peak Uncontrolled Exposure/General Population | | | | | | | Body 1.6 W/kg (mW/g) averaged over 1 gram | | | | | | | | | | | | |

Note: Blue entries represent variability measurements.

**Table 11-11
DTS Body-Worn SAR**

| MEASUREMENT RESULTS | | | | | | | | | | | | | | | |
|---|-----|--------------|---------|-----------------------------|-----------------------|------------------|---|----------------------|------------------|------|------------|----------|----------------|-----------------|--------|
| FREQUENCY | | Mode | Service | Maximum Allowed Power [dBm] | Conducted Power [dBm] | Power Drift [dB] | Spacing | Device Serial Number | Data Rate (Mbps) | Side | Duty Cycle | SAR (1g) | Scaling Factor | Scaled SAR (1g) | Plot # |
| MHz | Ch. | | | | | | | | | | | (W/kg) | | (W/kg) | |
| 2437 | 6 | IEEE 802.11b | DSSS | 17.0 | 16.89 | 0.02 | 10 mm | 05180482 | 1 | back | 1:1 | 0.064 | 1.026 | 0.066 | A21 |
| 5745 | 149 | IEEE 802.11a | OFDM | 12.0 | 11.99 | -0.15 | 10 mm | 05180482 | 6 | back | 1:1 | 0.075 | 1.002 | 0.075 | A22 |
| ANSI / IEEE C95.1 1992 - SAFETY LIMIT Spatial Peak Uncontrolled Exposure/General Population | | | | | | | Body 1.6 W/kg (mW/g) averaged over 1 gram | | | | | | | | |

| | | | | |
|--------------------------------------|---|-------------------------------|---|---------------------------------|
| FCC ID A3LSPHL520 |  | SAR EVALUATION REPORT |  | Reviewed by: Quality Manager |
| Document S/N: OY1306281121-R2.A3L | Test Dates: 07/01/13 - 07/19/13 | DUT Type: Portable Handset | | Page 43 of 60 |

**Table 11-12
NII Body-Worn SAR**



| MEASUREMENT RESULTS | | | | | | | | | | | | | | | |
|---|-----|--------------|---------|-----------------------------|-----------------------|------------------|---|----------------------|------------------|------|------------|----------|----------------|-----------------|--------|
| FREQUENCY | | Mode | Service | Maximum Allowed Power [dBm] | Conducted Power [dBm] | Power Drift [dB] | Spacing | Device Serial Number | Data Rate (Mbps) | Side | Duty Cycle | SAR (1g) | Scaling Factor | Scaled SAR (1g) | Plot # |
| MHz | Ch. | | | | | | | | | | | (W/kg) | | (W/kg) | |
| 5220 | 44 | IEEE 802.11a | OFDM | 12.0 | 11.81 | -0.18 | 10 mm | 05180482 | 6 | back | 1:1 | 0.203 | 1.045 | 0.212 | |
| 5260 | 52 | IEEE 802.11a | OFDM | 12.0 | 11.93 | -0.18 | 10 mm | 05180482 | 6 | back | 1:1 | 0.271 | 1.016 | 0.275 | A23 |
| 5520 | 104 | IEEE 802.11a | OFDM | 12.0 | 11.92 | -0.16 | 10 mm | 05180482 | 6 | back | 1:1 | 0.173 | 1.019 | 0.176 | |
| 5580 | 116 | IEEE 802.11a | OFDM | 12.0 | 11.80 | -0.18 | 10 mm | 05180482 | 6 | back | 1:1 | 0.107 | 1.047 | 0.112 | |
| 5680 | 136 | IEEE 802.11a | OFDM | 12.0 | 11.72 | -0.17 | 10 mm | 05180482 | 6 | back | 1:1 | 0.075 | 1.067 | 0.080 | |
| ANSI / IEEE C95.1 1992 - SAFETY LIMIT Spatial Peak Uncontrolled Exposure/General Population | | | | | | | Body 1.6 W/kg (mW/g) averaged over 1 gram | | | | | | | | |

11.3 Standalone Wireless Router SAR Data

**Table 11-13
CDMA Hotspot SAR Data**

| MEASUREMENT RESULTS | | | | | | | | | | | | | | |
|---|------|------------------|-------------|-----------------------------|-----------------------|------------------|---|----------------------|------------|--------|----------|----------------|-----------------|--------|
| FREQUENCY | | Mode | Service | Maximum Allowed Power [dBm] | Conducted Power [dBm] | Power Drift [dB] | Spacing | Device Serial Number | Duty Cycle | Side | SAR (1g) | Scaling Factor | Scaled SAR (1g) | Plot # |
| MHz | Ch. | | | | | | | | | | (W/kg) | | (W/kg) | |
| 820.10 | 564 | CDMA BC10 (§90S) | EVDO Rev. 0 | 25.0 | 24.81 | 0.03 | 10 mm | 051805a8 | 1:1 | back | 1.030 | 1.045 | 1.076 | A11 |
| 820.10 | 564 | CDMA BC10 (§90S) | EVDO Rev. 0 | 25.0 | 24.81 | 0.04 | 10 mm | 051805a8 | 1:1 | front | 0.570 | 1.045 | 0.596 | |
| 820.10 | 564 | CDMA BC10 (§90S) | EVDO Rev. 0 | 25.0 | 24.81 | -0.01 | 10 mm | 051805a8 | 1:1 | bottom | 0.221 | 1.045 | 0.231 | |
| 820.10 | 564 | CDMA BC10 (§90S) | EVDO Rev. 0 | 25.0 | 24.81 | -0.05 | 10 mm | 051805a8 | 1:1 | left | 0.819 | 1.045 | 0.856 | |
| 820.10 | 564 | CDMA BC10 (§90S) | EVDO Rev. 0 | 25.0 | 24.81 | 0.01 | 10 mm | 051805a8 | 1:1 | back | 1.030 | 1.045 | 1.076 | |
| 824.70 | 1013 | CDMA BC0 (§22H) | EVDO Rev. 0 | 25.0 | 24.81 | -0.06 | 10 mm | 051805a8 | 1:1 | back | 0.931 | 1.045 | 0.973 | |
| 836.52 | 384 | CDMA BC0 (§22H) | EVDO Rev. 0 | 25.0 | 24.90 | -0.03 | 10 mm | 051805a8 | 1:1 | back | 0.934 | 1.023 | 0.955 | A13 |
| 848.31 | 777 | CDMA BC0 (§22H) | EVDO Rev. 0 | 25.0 | 24.93 | -0.02 | 10 mm | 051805a8 | 1:1 | back | 0.834 | 1.016 | 0.847 | |
| 836.52 | 384 | CDMA BC0 (§22H) | EVDO Rev. 0 | 25.0 | 24.90 | 0.04 | 10 mm | 051805a8 | 1:1 | front | 0.657 | 1.023 | 0.672 | |
| 836.52 | 384 | CDMA BC0 (§22H) | EVDO Rev. 0 | 25.0 | 24.90 | -0.11 | 10 mm | 051805a8 | 1:1 | bottom | 0.300 | 1.023 | 0.307 | |
| 824.70 | 1013 | CDMA BC0 (§22H) | EVDO Rev. 0 | 25.0 | 24.81 | -0.16 | 10 mm | 051805a8 | 1:1 | left | 0.783 | 1.045 | 0.818 | |
| 836.52 | 384 | CDMA BC0 (§22H) | EVDO Rev. 0 | 25.0 | 24.90 | 0.00 | 10 mm | 051805a8 | 1:1 | left | 0.831 | 1.023 | 0.850 | |
| 848.31 | 777 | CDMA BC0 (§22H) | EVDO Rev. 0 | 25.0 | 24.93 | -0.01 | 10 mm | 051805a8 | 1:1 | left | 0.741 | 1.016 | 0.753 | |
| 1851.25 | 25 | PCS CDMA | EVDO Rev. 0 | 25.0 | 24.92 | -0.11 | 10 mm | 051804e0 | 1:1 | back | 0.617 | 1.019 | 0.629 | |
| 1880.00 | 600 | PCS CDMA | EVDO Rev. 0 | 25.0 | 24.91 | 0.03 | 10 mm | 051804e0 | 1:1 | back | 0.858 | 1.021 | 0.876 | |
| 1908.75 | 1175 | PCS CDMA | EVDO Rev. 0 | 25.0 | 24.76 | -0.06 | 10 mm | 051804e0 | 1:1 | back | 0.898 | 1.057 | 0.949 | A15 |
| 1880.00 | 600 | PCS CDMA | EVDO Rev. 0 | 25.0 | 24.91 | 0.01 | 10 mm | 051804e0 | 1:1 | front | 0.600 | 1.021 | 0.613 | |
| 1851.25 | 25 | PCS CDMA | EVDO Rev. 0 | 25.0 | 24.92 | -0.12 | 10 mm | 051804e0 | 1:1 | bottom | 0.594 | 1.019 | 0.605 | |
| 1880.00 | 600 | PCS CDMA | EVDO Rev. 0 | 25.0 | 24.91 | -0.01 | 10 mm | 051804e0 | 1:1 | bottom | 0.813 | 1.021 | 0.830 | |
| 1908.75 | 1175 | PCS CDMA | EVDO Rev. 0 | 25.0 | 24.76 | 0.01 | 10 mm | 051804e0 | 1:1 | bottom | 0.764 | 1.057 | 0.808 | |
| 1880.00 | 600 | PCS CDMA | EVDO Rev. 0 | 25.0 | 24.91 | 0.02 | 10 mm | 051804e0 | 1:1 | left | 0.408 | 1.021 | 0.417 | |
| ANSI / IEEE C95.1 1992 - SAFETY LIMIT Spatial Peak Uncontrolled Exposure/General Population | | | | | | | Body 1.6 W/kg (mW/g) averaged over 1 gram | | | | | | | |

Note: Blue entries represent variability measurements.

| | | | | |
|--------------------------------------|---|-------------------------------|---|---------------------------------|
| FCC ID A3LSPHL520 |  | SAR EVALUATION REPORT |  | Reviewed by: Quality Manager |
| Document S/N: OY1306281121-R2.A3L | Test Dates: 07/01/13 - 07/19/13 | DUT Type: Portable Handset | Page 44 of 60 | |

**Table 11-14
LTE Band 26 Hotspot SAR**

| MEASUREMENT RESULTS | | | | | | | | | | | | | | | | | | | |
|---|-------|------|-----------------|-----------------------------|-----------------------|------------------|----------|----------------------|---|---------|-----------|---------|-------|------------|-----------------|----------------|------------------------|--------|-----|
| FREQUENCY | | Mode | Bandwidth [MHz] | Maximum Allowed Power [dBm] | Conducted Power [dBm] | Power Drift [dB] | MPR [dB] | Device Serial Number | Modulation | RB Size | RB Offset | Spacing | Side | Duty Cycle | SAR (1g) (W/kg) | Scaling Factor | Scaled SAR (1g) (W/kg) | Plot # | |
| MHz | Ch. | | | | | | | | | | | | | | | | | | |
| 819.00 | 26740 | Low | LTE Band 26 | 10 | 23.5 | 23.04 | -0.01 | 0 | 05180482 | QPSK | 1 | 49 | 10 mm | back | 1:1 | 0.478 | 1.112 | 0.532 | |
| 819.00 | 26740 | Low | LTE Band 26 | 10 | 22.5 | 21.79 | 0.00 | 1 | 05180482 | QPSK | 25 | 25 | 10 mm | back | 1:1 | 0.363 | 1.178 | 0.428 | |
| 819.00 | 26740 | Low | LTE Band 26 | 10 | 23.5 | 23.04 | 0.09 | 0 | 05180482 | QPSK | 1 | 49 | 10 mm | front | 1:1 | 0.397 | 1.112 | 0.441 | |
| 819.00 | 26740 | Low | LTE Band 26 | 10 | 22.5 | 21.79 | 0.05 | 1 | 05180482 | QPSK | 25 | 25 | 10 mm | front | 1:1 | 0.302 | 1.178 | 0.356 | |
| 819.00 | 26740 | Low | LTE Band 26 | 10 | 23.5 | 23.04 | -0.06 | 0 | 05180482 | QPSK | 1 | 49 | 10 mm | bottom | 1:1 | 0.149 | 1.112 | 0.166 | |
| 819.00 | 26740 | Low | LTE Band 26 | 10 | 22.5 | 21.79 | 0.04 | 1 | 05180482 | QPSK | 25 | 25 | 10 mm | bottom | 1:1 | 0.110 | 1.178 | 0.130 | |
| 819.00 | 26740 | Low | LTE Band 26 | 10 | 23.5 | 23.04 | -0.07 | 0 | 05180482 | QPSK | 1 | 49 | 10 mm | left | 1:1 | 0.581 | 1.112 | 0.646 | A17 |
| 819.00 | 26740 | Low | LTE Band 26 | 10 | 22.5 | 21.79 | -0.05 | 1 | 05180482 | QPSK | 25 | 25 | 10 mm | left | 1:1 | 0.431 | 1.178 | 0.508 | |
| ANSI / IEEE C95.1 1992 - SAFETY LIMIT Spatial Peak Uncontrolled Exposure/General Population | | | | | | | | | Body 1.6 W/kg (mW/g) averaged over 1 gram | | | | | | | | | | |



**Table 11-15
LTE Band 25 (PCS) Hotspot SAR**

| MEASUREMENT RESULTS | | | | | | | | | | | | | | | | | | | |
|---|-------|------|-------------------|-----------------------------|-----------------------|------------------|----------|----------------------|---|---------|-----------|---------|-------|------------|-----------------|----------------|------------------------|--------|-----|
| FREQUENCY | | Mode | Bandwidth [MHz] | Maximum Allowed Power [dBm] | Conducted Power [dBm] | Power Drift [dB] | MPR [dB] | Device Serial Number | Modulation | RB Size | RB Offset | Spacing | Side | Duty Cycle | SAR (1g) (W/kg) | Scaling Factor | Scaled SAR (1g) (W/kg) | Plot # | |
| MHz | Ch. | | | | | | | | | | | | | | | | | | |
| 1855.00 | 26090 | Low | LTE Band 25 (PCS) | 10 | 23.5 | 23.13 | -0.01 | 0 | 051805af | QPSK | 1 | 0 | 10 mm | back | 1:1 | 0.384 | 1.089 | 0.418 | |
| 1855.00 | 26090 | Low | LTE Band 25 (PCS) | 10 | 22.5 | 21.93 | 0.04 | 1 | 051805af | QPSK | 25 | 0 | 10 mm | back | 1:1 | 0.370 | 1.140 | 0.422 | |
| 1855.00 | 26090 | Low | LTE Band 25 (PCS) | 10 | 23.5 | 23.13 | 0.03 | 0 | 051805af | QPSK | 1 | 0 | 10 mm | front | 1:1 | 0.416 | 1.089 | 0.453 | |
| 1855.00 | 26090 | Low | LTE Band 25 (PCS) | 10 | 22.5 | 21.93 | 0.00 | 1 | 051805af | QPSK | 25 | 0 | 10 mm | front | 1:1 | 0.289 | 1.140 | 0.329 | |
| 1855.00 | 26090 | Low | LTE Band 25 (PCS) | 10 | 23.5 | 23.13 | 0.11 | 0 | 051805af | QPSK | 1 | 0 | 10 mm | bottom | 1:1 | 0.417 | 1.089 | 0.454 | A19 |
| 1855.00 | 26090 | Low | LTE Band 25 (PCS) | 10 | 22.5 | 21.93 | -0.01 | 1 | 051805af | QPSK | 25 | 0 | 10 mm | bottom | 1:1 | 0.288 | 1.140 | 0.328 | |
| 1855.00 | 26090 | Low | LTE Band 25 (PCS) | 10 | 23.5 | 23.13 | -0.06 | 0 | 051805af | QPSK | 1 | 0 | 10 mm | left | 1:1 | 0.207 | 1.089 | 0.225 | |
| 1855.00 | 26090 | Low | LTE Band 25 (PCS) | 10 | 22.5 | 21.93 | -0.08 | 1 | 051805af | QPSK | 25 | 0 | 10 mm | left | 1:1 | 0.150 | 1.140 | 0.171 | |
| ANSI / IEEE C95.1 1992 - SAFETY LIMIT Spatial Peak Uncontrolled Exposure/General Population | | | | | | | | | Body 1.6 W/kg (mW/g) averaged over 1 gram | | | | | | | | | | |

**Table 11-16
LTE Band 41 Hotspot SAR**

| MEASUREMENT RESULTS | | | | | | | | | | | | | | | | | | | |
|---|-------|----------|-----------------|-----------------------------|-----------------------|------------------|----------|----------------------|---|---------|-----------|---------|-------|------------|-----------------|----------------|------------------------|--------|-----|
| FREQUENCY | | Mode | Bandwidth [MHz] | Maximum Allowed Power [dBm] | Conducted Power [dBm] | Power Drift [dB] | MPR [dB] | Device Serial Number | Modulation | RB Size | RB Offset | Spacing | Side | Duty Cycle | SAR (1g) (W/kg) | Scaling Factor | Scaled SAR (1g) (W/kg) | Plot # | |
| MHz | Ch. | | | | | | | | | | | | | | | | | | |
| 2506.00 | 39750 | Low | LTE Band 41 | 20 | 23.5 | 23.25 | -0.06 | 0 | 0518058e | QPSK | 1 | 50 | 10 mm | back | 1:1.58 | 0.666 | 1.059 | 0.705 | |
| 2506.00 | 39750 | Low | LTE Band 41 | 20 | 22.5 | 22.15 | 0.07 | 1 | 0518058e | QPSK | 50 | 0 | 10 mm | back | 1:1.58 | 0.614 | 1.084 | 0.666 | |
| 2506.00 | 39750 | Low | LTE Band 41 | 20 | 22.5 | 22.13 | -0.02 | 1 | 0518058e | QPSK | 100 | 0 | 10 mm | back | 1:1.58 | 0.650 | 1.089 | 0.708 | |
| 2549.50 | 40185 | Low-Mid | LTE Band 41 | 20 | 23.5 | 23.14 | 0.01 | 0 | 0518058e | QPSK | 1 | 99 | 10 mm | back | 1:1.58 | 0.783 | 1.086 | 0.850 | |
| 2549.50 | 40185 | Low-Mid | LTE Band 41 | 20 | 22.5 | 21.98 | 0.08 | 1 | 0518058e | QPSK | 50 | 25 | 10 mm | back | 1:1.58 | 0.749 | 1.127 | 0.844 | |
| 2593.00 | 40620 | Mid | LTE Band 41 | 20 | 23.5 | 23.16 | 0.03 | 0 | 0518058e | QPSK | 1 | 0 | 10 mm | back | 1:1.58 | 0.890 | 1.081 | 0.962 | |
| 2593.00 | 40620 | Mid | LTE Band 41 | 20 | 22.5 | 22.12 | 0.04 | 1 | 0518058e | QPSK | 50 | 25 | 10 mm | back | 1:1.58 | 0.896 | 1.091 | 0.978 | |
| 2636.50 | 41055 | Mid-High | LTE Band 41 | 20 | 23.5 | 23.22 | 0.16 | 0 | 0518058e | QPSK | 1 | 0 | 10 mm | back | 1:1.58 | 1.030 | 1.067 | 1.099 | |
| 2636.50 | 41055 | Mid-High | LTE Band 41 | 20 | 22.5 | 21.85 | -0.01 | 1 | 0518058e | QPSK | 50 | 25 | 10 mm | back | 1:1.58 | 0.908 | 1.161 | 1.054 | |
| 2680.00 | 41490 | High | LTE Band 41 | 20 | 23.5 | 23.42 | 0.06 | 0 | 0518058e | QPSK | 1 | 50 | 10 mm | back | 1:1.58 | 0.711 | 1.019 | 0.725 | |
| 2680.00 | 41490 | High | LTE Band 41 | 20 | 22.5 | 22.19 | 0.04 | 1 | 0518058e | QPSK | 50 | 25 | 10 mm | back | 1:1.58 | 0.666 | 1.074 | 0.715 | |
| 2680.00 | 41490 | High | LTE Band 41 | 20 | 23.5 | 23.42 | -0.21 | 0 | 0518058e | QPSK | 1 | 50 | 10 mm | front | 1:1.58 | 0.234 | 1.019 | 0.238 | |
| 2680.00 | 41490 | High | LTE Band 41 | 20 | 22.5 | 22.19 | 0.02 | 1 | 0518058e | QPSK | 50 | 25 | 10 mm | front | 1:1.58 | 0.214 | 1.074 | 0.230 | |
| 2680.00 | 41490 | High | LTE Band 41 | 20 | 23.5 | 23.42 | -0.06 | 0 | 0518058e | QPSK | 1 | 50 | 10 mm | bottom | 1:1.58 | 0.367 | 1.019 | 0.374 | |
| 2680.00 | 41490 | High | LTE Band 41 | 20 | 22.5 | 22.19 | 0.05 | 1 | 0518058e | QPSK | 50 | 25 | 10 mm | bottom | 1:1.58 | 0.336 | 1.074 | 0.361 | |
| 2680.00 | 41490 | High | LTE Band 41 | 20 | 23.5 | 23.42 | -0.09 | 0 | 0518058e | QPSK | 1 | 50 | 10 mm | left | 1:1.58 | 0.401 | 1.019 | 0.409 | |
| 2680.00 | 41490 | High | LTE Band 41 | 20 | 22.5 | 22.19 | 0.03 | 1 | 0518058e | QPSK | 50 | 25 | 10 mm | left | 1:1.58 | 0.375 | 1.074 | 0.403 | |
| 2636.50 | 41055 | Mid-High | LTE Band 41 | 20 | 23.5 | 23.22 | -0.07 | 0 | 0518058e | QPSK | 1 | 0 | 10 mm | back | 1:1.58 | 1.030 | 1.067 | 1.099 | A20 |
| ANSI / IEEE C95.1 1992 - SAFETY LIMIT Spatial Peak Uncontrolled Exposure/General Population | | | | | | | | | Body 1.6 W/kg (mW/g) averaged over 1 gram | | | | | | | | | | |

Note: Blue entries represent variability measurements.

| | | | | |
|--------------------------------------|---|-------------------------------|---|---------------------------------|
| FCC ID A3LSPHL520 |  | SAR EVALUATION REPORT |  | Reviewed by: Quality Manager |
| Document S/N: OY1306281121-R2.A3L | Test Dates: 07/01/13 - 07/19/13 | DUT Type: Portable Handset | Page 45 of 60 | |



**Table 11-17
WLAN Hotspot SAR**

| MEASUREMENT RESULTS | | | | | | | | | | | | | | | |
|---|-----|--------------|---------|-----------------------------|-----------------------|------------------|---|----------------------|------------------|-------|------------|----------|----------------|-----------------|--------|
| FREQUENCY | | Mode | Service | Maximum Allowed Power [dBm] | Conducted Power [dBm] | Power Drift [dB] | Spacing | Device Serial Number | Data Rate (Mbps) | Side | Duty Cycle | SAR (1g) | Scaling Factor | Scaled SAR (1g) | Plot # |
| MHz | Ch. | | | | | | | | | | | (W/kg) | | (W/kg) | |
| 2437 | 6 | IEEE 802.11b | DSSS | 17.0 | 16.89 | 0.02 | 10 mm | 05180482 | 1 | back | 1:1 | 0.064 | 1.026 | 0.066 | A21 |
| 2437 | 6 | IEEE 802.11b | DSSS | 17.0 | 16.89 | 0.22 | 10 mm | 05180482 | 1 | front | 1:1 | 0.019 | 1.026 | 0.019 | |
| 2437 | 6 | IEEE 802.11b | DSSS | 17.0 | 16.89 | 0.04 | 10 mm | 05180482 | 1 | top | 1:1 | 0.021 | 1.026 | 0.022 | |
| 2437 | 6 | IEEE 802.11b | DSSS | 17.0 | 16.89 | -0.01 | 10 mm | 05180482 | 1 | right | 1:1 | 0.061 | 1.026 | 0.063 | |
| 5745 | 149 | IEEE 802.11a | OFDM | 12.0 | 11.99 | -0.15 | 10 mm | 05180482 | 6 | back | 1:1 | 0.075 | 1.002 | 0.075 | |
| 5745 | 149 | IEEE 802.11a | OFDM | 12.0 | 11.99 | 0.20 | 10 mm | 05180482 | 6 | front | 1:1 | 0.004 | 1.002 | 0.004 | |
| 5745 | 149 | IEEE 802.11a | OFDM | 12.0 | 11.99 | -0.20 | 10 mm | 05180482 | 6 | top | 1:1 | 0.012 | 1.002 | 0.012 | |
| 5745 | 149 | IEEE 802.11a | OFDM | 12.0 | 11.99 | -0.20 | 10 mm | 05180482 | 6 | right | 1:1 | 0.082 | 1.002 | 0.082 | A24 |
| ANSI / IEEE C95.1 1992 - SAFETY LIMIT Spatial Peak Uncontrolled Exposure/General Population | | | | | | | Body 1.6 W/kg (mW/g) averaged over 1 gram | | | | | | | | |

11.4 SAR Test Notes

General Notes:

1. The test data reported are the worst-case SAR values according to test procedures specified in IEEE 1528-2003, FCC/OET Bulletin 65, Supplement C [June 2001] and FCC KDB Publication 447498 D01v05.
2. Batteries are fully charged at the beginning of the SAR measurements. A standard battery, including NFC antenna, was used for all SAR measurements.
3. Liquid tissue depth was at least 15.0 cm for all frequencies.
4. The manufacturer has confirmed that the device(s) tested have the same physical, mechanical and thermal characteristics and are within operational tolerances expected for production units.
5. SAR results were scaled to the maximum allowed power to demonstrate compliance per FCC KDB Publication 447498 D01v05.
6. Device was tested using a fixed spacing for body-worn accessory testing. A separation distance of 10 mm was considered because the manufacturer has determined that there will be body-worn accessories available in the marketplace for users to support this separation distance.
7. Per FCC KDB Publication 648474 D04v01, SAR was evaluated without a headset connected to the device. Since the standalone reported SAR was ≤ 1.2 W/kg, no additional SAR evaluations using a headset cable were required.
8. Per FCC KDB 865664 D01 v01, variability SAR tests were performed when the measured SAR results for a frequency band were greater than 0.8 W/kg. Repeated SAR measurements are highlighted in the tables above for clarity. Please see Section 13 for variability analysis.
9. During SAR Testing for the Wireless Router conditions per FCC KDB Publication 941225 D06v01, the actual Portable Hotspot operation (with actual simultaneous transmission of a transmitter with WIFI) was not activated (See Section 6.7 for more details).

| | | | | |
|--------------------------------------|---|-------------------------------|---|---------------------------------|
| FCC ID A3LSPHL520 |  | SAR EVALUATION REPORT |  | Reviewed by: Quality Manager |
| Document S/N: OY1306281121-R2.A3L | Test Dates: 07/01/13 - 07/19/13 | DUT Type: Portable Handset | Page 46 of 60 | |

CDMA Notes:



1. Head SAR for CDMA2000 mode was tested under RC3/SO55 per FCC KDB Publication 941225 D01v02.
2. Body-Worn SAR was tested with 1x RTT with TDSO / SO32 FCH Only. EVDO and TDSO / SO32 FCH+SCH SAR tests were not required since the average output power was not more than 0.25 dB higher than the TDSO / SO32 FCH only powers, per FCC KDB Publication 941225 D01v02.
3. CDMA Wireless Router SAR is measured using Subtype 0/1 Physical Layer configurations for Rev. 0 according to KDB 941225 D01 procedures for data devices. Since the average output power of Subtype 2 for Rev. A is less than the Rev. 0 power levels, then EVDO Rev. A SAR is not required. SAR is not required for 1x RTT for Ev-Do hotspot devices when the maximum average output of each channel is less than 1/4 dB higher than that measured in Subtype 0/1 Physical Layer configurations for Rev. 0.
4. Head SAR was additionally evaluated using EVDO Rev. A to determine compliance for VoIP operations.
5. Per FCC KDB Publication 447498 D01v05, if the reported (scaled) SAR measured at the middle channel or highest output power channel for each test configuration is ≤ 0.8 W/kg then testing at the other channels is not required for such test configuration(s). When the maximum output power variation across the required test channels is $> \frac{1}{2}$ dB, instead of the middle channel, the highest output power channel was used.

LTE Notes:

1. LTE Considerations: LTE test configurations are determined according to SAR Evaluation Considerations for LTE Devices in FCC KDB Publication 941225 D05v02r01. The general test procedures used for testing can be found in Section 8.4.4.
2. MPR is permanently implemented for this device by the manufacturer. The specific manufacturer target MPR is indicated alongside the SAR results. MPR is enabled for this device, according to 3GPP TS36.101 Section 6.2.3 – 6.2.5 under Table 6.2.3-1.
3. A-MPR was disabled for all SAR tests by setting NS=01 on the base station simulator.
4. TDD LTE was tested using UL-DL configuration 0 with 6 UL subframes and 2 S subframes using extended cyclic prefix only and special subframe configuration 6. SAR tests were performed at maximum output power and worst-case transmission duty factor in extended cyclic prefix. Per 3GPP 36.211 Section 4, the duty factor for special subframe configuration 6 using extended cyclic prefix is 0.633.
5. Per FCC KDB Publication 447498 D01v05, if the reported (scaled) LTE Band 41 SAR measured at the highest output power channel for each test configuration is ≤ 0.6 W/kg then testing at the other channels is not required for such test configuration(s). If the reported (scaled) LTE Band 25 or LTE Band 26 SAR measured at the highest output power channel for each test configuration is ≤ 0.8 W/kg then testing at the other channels is not required for such test configuration(s).
6. LTE B41 high channel SAR was evaluated using probe s/n 3022 and 3920 and DASY software measurement version 4.7 and 52.8. Per KDB Publication 865664 D01 Section 2.6, at 300 MHz to 6 GHz, measurements must be within +/- 100 MHz of the probe calibration point frequency or the valid frequency range supported by the probe calibration, whichever is less. Footnote C on page 5 and page 6 of the calibration certificate for probe s/n 3022 and 3920 states that a frequency validity of +/- 100 MHz applies when using DASY measurement software version 4.4 and higher. Therefore, there are no additional requirements for SAR measurements at LTE B41 high channel.



WLAN Notes:

1. Justification for reduced test configurations for WIFI channels per KDB Publication 248227 D01v01r02 and October 2012 FCC/TCB Meeting Notes for 2.4 GHz WIFI: Highest average RF output power channel for the lowest data rate was selected for SAR evaluation in 802.11b. Other

| | | | |
|---|---|--|--|
| FCC ID A3LSPHL520 |  | <p align="center">SAR EVALUATION REPORT</p>  | <p>Reviewed by: Quality Manager</p> |
| <p>Document S/N: OY1306281121-R2.A3L</p> | <p>Test Dates: 07/01/13 - 07/19/13</p> | <p>DUT Type: Portable Handset</p> | <p>Page 47 of 60</p> |

IEEE 802.11 modes (including 802.11g/n) were not investigated since the average output powers over all channels and data rates were not more than 0.25 dB higher than the tested channel in the lowest data rate of IEEE 802.11b mode.

2. Justification for reduced test configurations for WIFI channels per KDB Publication 248227 D01v01r02 and October 2012 FCC/TCB Meeting Notes for 5 GHz WIFI: Highest average RF output power channel for the lowest data rate was selected for SAR evaluation in 802.11a. Other IEEE 802.11 modes (including 802.11n) were not investigated since the average output powers over all channels and data rates were not more than 0.25 dB higher than the tested channel in the lowest data rate of IEEE 802.11a mode.
3. When Hotspot is enabled, 5.2 - 5.7 GHz WLAN bands are disabled. Therefore only 5.8 GHz WIFI Wireless Router SAR Data was required.
4. WIFI transmission was verified using an uncalibrated spectrum analyzer.
5. When the maximum extrapolated peak SAR of the zoom scan for the maximum output channel is <1.6 W/kg and the reported 1g averaged SAR is <0.8 W/kg, SAR testing on other channels is not required. Otherwise, the other default (or corresponding required) test channels were additionally tested using the lowest data rate..

| | | | | |
|---|---|--------------------------------------|---|--|
| FCC ID A3LSPHL520 |  | SAR EVALUATION REPORT |  | Reviewed by: Quality Manager |
| Document S/N: 0Y1306281121-R2.A3L | Test Dates: 07/01/13 - 07/19/13 | DUT Type: Portable Handset | Page 48 of 60 | |

12 FCC MULTI-TX AND ANTENNA SAR CONSIDERATIONS

12.1 Introduction

The following procedures adopted from FCC KDB Publication 447498 D01v05 are applicable to handsets with built-in unlicensed transmitters such as 802.11a/b/g/n and Bluetooth devices which may simultaneously transmit with the licensed transmitter.

12.2 Simultaneous Transmission Procedures

This device contains transmitters that may operate simultaneously. Therefore simultaneous transmission analysis is required. Per FCC KDB 447498 D01v05 IV.C.1.iii, simultaneous transmission SAR test exclusion may be applied when the sum of the 1-g SAR for all the simultaneous transmitting antennas in a specific a physical test configuration is ≤ 1.6 W/kg. When standalone SAR is not required to be measured, per FCC KDB 447498 D01v05 4.3.2 2), the following equation must be used to estimate the standalone 1g SAR for simultaneous transmission assessment involving that transmitter.

$$\text{Estimated SAR} = \frac{\sqrt{f(\text{GHz})}}{7.5} * \frac{(\text{Max Power of channel, mW})}{\text{Min. Separation Distance, mm}}$$

**Table 12-1
Estimated SAR**



| Mode | Frequency | Maximum Allowed Power | Estimated SAR (Held-to-Ear) | Separation Distance (Body) | Estimated SAR (Body) |
|-----------|-----------|-----------------------|-----------------------------|----------------------------|----------------------|
| | [MHz] | [dBm] | [W/kg] | [mm] | [W/kg] |
| Bluetooth | 2441 | 10.00 | N/A | 10 | 0.208 |

Note: Held-to ear configurations are not applicable to Bluetooth operations and therefore were not considered for simultaneous transmission. Per KDB Publication 447498 D01v05, the maximum power of the channel was rounded to the nearest mW before calculation.

12.3 Head SAR Simultaneous Transmission Analysis

**Table 12-2
Simultaneous Transmission Scenario with 2.4 GHz WLAN (Held to Ear)**



| Simult Tx | Configuration | CDMA BC10 (\$90S) SAR (W/kg) | 2.4 GHz WLAN SAR (W/kg) | Σ SAR (W/kg) | Simult Tx | Configuration | CDMA BC0 (\$22H) SAR (W/kg) | 2.4 GHz WLAN SAR (W/kg) | Σ SAR (W/kg) |
|-----------|---------------|------------------------------|-------------------------|---------------------|-----------|---------------|-----------------------------|-------------------------|---------------------|
| Head SAR | Right Cheek | 0.523 | 0.033 | 0.556 | Head SAR | Right Cheek | 0.539 | 0.033 | 0.572 |
| | Right Tilt | 0.407 | 0.031 | 0.438 | | Right Tilt | 0.441 | 0.031 | 0.472 |
| | Left Cheek | 0.593 | 0.092 | 0.685 | | Left Cheek | 0.651 | 0.092 | 0.743 |
| | Left Tilt | 0.438 | 0.033 | 0.471 | | Left Tilt | 0.477 | 0.033 | 0.510 |
| Simult Tx | Configuration | PCS CDMA SAR (W/kg) | 2.4 GHz WLAN SAR (W/kg) | Σ SAR (W/kg) | Simult Tx | Configuration | LTE Band 26 SAR (W/kg) | 2.4 GHz WLAN SAR (W/kg) | Σ SAR (W/kg) |
| Head SAR | Right Cheek | 0.488 | 0.033 | 0.521 | Head SAR | Right Cheek | 0.364 | 0.033 | 0.397 |
| | Right Tilt | 0.254 | 0.031 | 0.285 | | Right Tilt | 0.308 | 0.031 | 0.339 |
| | Left Cheek | 0.944 | 0.092 | 1.036 | | Left Cheek | 0.415 | 0.092 | 0.507 |
| | Left Tilt | 0.229 | 0.033 | 0.262 | | Left Tilt | 0.297 | 0.033 | 0.330 |

| | | | | |
|---|---|--------------------------------------|---|--|
| FCC ID A3LSPHL520 |  PCTEST ENGINEERING LABORATORY, INC. | SAR EVALUATION REPORT |  | Reviewed by: Quality Manager |
| Document S/N: OY1306281121-R2.A3L | Test Dates: 07/01/13 - 07/19/13 | DUT Type: Portable Handset | Page 49 of 60 | |

| Simult Tx | Configuration | LTE Band 25 (PCS) SAR (W/kg) | 2.4 GHz WLAN SAR (W/kg) | Σ SAR (W/kg) | Simult Tx | Configuration | LTE Band 41 SAR (W/kg) | 2.4 GHz WLAN SAR (W/kg) | Σ SAR (W/kg) |
|-----------|---------------|------------------------------|-------------------------|--------------|-----------|---------------|-----------------------------|-------------------------|--------------|
| Head SAR | Right Cheek | 0.287 | 0.033 | 0.320 | Head SAR | Right Cheek | 0.261 | 0.033 | 0.294 |
| | Right Tilt | 0.171 | 0.031 | 0.202 | | Right Tilt | 0.176 | 0.031 | 0.207 |
| | Left Cheek | 0.516 | 0.092 | 0.608 | | Left Cheek | 0.665 | 0.092 | 0.757 |
| | Left Tilt | 0.144 | 0.033 | 0.177 | | Left Tilt | 0.130 | 0.033 | 0.163 |
| Simult Tx | Configuration | EVDO BC10 (\$90S) SAR (W/kg) | 2.4 GHz WLAN SAR (W/kg) | Σ SAR (W/kg) | Simult Tx | Configuration | EVDO BC0 (\$22H) SAR (W/kg) | 2.4 GHz WLAN SAR (W/kg) | Σ SAR (W/kg) |
| Head SAR | Right Cheek | 0.374 | 0.033 | 0.407 | Head SAR | Right Cheek | 0.505 | 0.033 | 0.538 |
| | Right Tilt | 0.335 | 0.031 | 0.366 | | Right Tilt | 0.401 | 0.031 | 0.432 |
| | Left Cheek | 0.505 | 0.092 | 0.597 | | Left Cheek | 0.614 | 0.092 | 0.706 |
| | Left Tilt | 0.427 | 0.033 | 0.460 | | Left Tilt | 0.477 | 0.033 | 0.510 |
| Simult Tx | Configuration | PCS EVDO SAR (W/kg) | 2.4 GHz WLAN SAR (W/kg) | Σ SAR (W/kg) | | | | | |
| Head SAR | Right Cheek | 0.479 | 0.033 | 0.512 | | | | | |
| | Right Tilt | 0.279 | 0.031 | 0.310 | | | | | |
| | Left Cheek | 0.965 | 0.092 | 1.057 | | | | | |
| | Left Tilt | 0.253 | 0.033 | 0.286 | | | | | |

**Table 12-3
Simultaneous Transmission Scenario with 5 GHz WLAN (Held to Ear)**

| Simult Tx | Configuration | CDMA BC10 (\$90S) SAR (W/kg) | 5 GHz WLAN SAR (W/kg) | Σ SAR (W/kg) | Simult Tx | Configuration | CDMA BC0 (\$22H) SAR (W/kg) | 5 GHz WLAN SAR (W/kg) | Σ SAR (W/kg) |
|-----------|---------------|------------------------------|-----------------------|--------------|-----------|---------------|-----------------------------|-----------------------|--------------|
| Head SAR | Right Cheek | 0.523 | 0.034 | 0.557 | Head SAR | Right Cheek | 0.539 | 0.034 | 0.573 |
| | Right Tilt | 0.407 | 0.044 | 0.451 | | Right Tilt | 0.441 | 0.044 | 0.485 |
| | Left Cheek | 0.593 | 0.116 | 0.709 | | Left Cheek | 0.651 | 0.116 | 0.767 |
| | Left Tilt | 0.438 | 0.031 | 0.469 | | Left Tilt | 0.477 | 0.031 | 0.508 |
| Simult Tx | Configuration | PCS CDMA SAR (W/kg) | 5 GHz WLAN SAR (W/kg) | Σ SAR (W/kg) | Simult Tx | Configuration | LTE Band 26 SAR (W/kg) | 5 GHz WLAN SAR (W/kg) | Σ SAR (W/kg) |
| Head SAR | Right Cheek | 0.488 | 0.034 | 0.522 | Head SAR | Right Cheek | 0.364 | 0.034 | 0.398 |
| | Right Tilt | 0.254 | 0.044 | 0.298 | | Right Tilt | 0.308 | 0.044 | 0.352 |
| | Left Cheek | 0.944 | 0.116 | 1.060 | | Left Cheek | 0.415 | 0.116 | 0.531 |
| | Left Tilt | 0.229 | 0.031 | 0.260 | | Left Tilt | 0.297 | 0.031 | 0.328 |
| Simult Tx | Configuration | LTE Band 25 (PCS) SAR (W/kg) | 5 GHz WLAN SAR (W/kg) | Σ SAR (W/kg) | Simult Tx | Configuration | LTE Band 41 SAR (W/kg) | 5 GHz WLAN SAR (W/kg) | Σ SAR (W/kg) |
| Head SAR | Right Cheek | 0.287 | 0.034 | 0.321 | Head SAR | Right Cheek | 0.261 | 0.034 | 0.295 |
| | Right Tilt | 0.171 | 0.044 | 0.215 | | Right Tilt | 0.176 | 0.044 | 0.220 |
| | Left Cheek | 0.516 | 0.116 | 0.632 | | Left Cheek | 0.665 | 0.116 | 0.781 |
| | Left Tilt | 0.144 | 0.031 | 0.175 | | Left Tilt | 0.130 | 0.031 | 0.161 |

| | | | | |
|--------------------------------------|---|-------------------------------|---|---------------------------------|
| FCC ID A3LSPHL520 |  | SAR EVALUATION REPORT |  | Reviewed by: Quality Manager |
| Document S/N: OY1306281121-R2.A3L | Test Dates: 07/01/13 - 07/19/13 | DUT Type: Portable Handset | Page 50 of 60 | |

| Simult Tx | Configuration | EVDO BC10 (§90S) SAR (W/kg) | 5 GHz WLAN SAR (W/kg) | Σ SAR (W/kg) | Simult Tx | Configuration | EVDO BC0 (§22H) SAR (W/kg) | 5 GHz WLAN SAR (W/kg) | Σ SAR (W/kg) |
|-----------|---------------|-----------------------------|-----------------------|--------------|-----------|---------------|----------------------------|-----------------------|--------------|
| Head SAR | Right Cheek | 0.374 | 0.034 | 0.408 | Head SAR | Right Cheek | 0.505 | 0.034 | 0.539 |
| | Right Tilt | 0.335 | 0.044 | 0.379 | | Right Tilt | 0.401 | 0.044 | 0.445 |
| | Left Cheek | 0.505 | 0.116 | 0.621 | | Left Cheek | 0.614 | 0.116 | 0.730 |
| | Left Tilt | 0.427 | 0.031 | 0.458 | | Left Tilt | 0.477 | 0.031 | 0.508 |

| Simult Tx | Configuration | PCS EVDO SAR (W/kg) | 5 GHz WLAN SAR (W/kg) | Σ SAR (W/kg) |
|-----------|---------------|---------------------|-----------------------|--------------|
| Head SAR | Right Cheek | 0.479 | 0.034 | 0.513 |
| | Right Tilt | 0.279 | 0.044 | 0.323 |
| | Left Cheek | 0.965 | 0.116 | 1.081 |
| | Left Tilt | 0.253 | 0.031 | 0.284 |

The worst case 5 GHz WLAN reported SAR for each head configuration was used for SAR summation, regardless of whether the WLAN channel has WIFI Hotspot capability. Therefore, the summations above represent the absolute worst cases for simultaneous transmission with 5 GHz WLAN

12.4 Body-Worn Simultaneous Transmission Analysis

Table 12-4
Simultaneous Transmission Scenario with 2.4 GHz WLAN (Body-Worn at 10 mm)

| Configuration | Mode | 2G/3G/4G SAR (W/kg) | 2.4 GHz WLAN SAR (W/kg) | Σ SAR (W/kg) |
|---------------|-------------------|---------------------|-------------------------|--------------|
| Back Side | CDMA BC10 (§90S) | 1.030 | 0.066 | 1.096 |
| Back Side | CDMA BC0 (§22H) | 1.010 | 0.066 | 1.076 |
| Back Side | PCS CDMA | 1.057 | 0.066 | 1.123 |
| Back Side | LTE Band 26 | 0.532 | 0.066 | 0.598 |
| Back Side | LTE Band 25 (PCS) | 0.422 | 0.066 | 0.488 |
| Back Side | LTE Band 41 | 1.099 | 0.066 | 1.165 |

Table 12-5
Simultaneous Transmission Scenario with 5 GHz WLAN (Body-Worn at 10 mm)

| Configuration | Mode | 2G/3G/4G SAR (W/kg) | 5 GHz WLAN SAR (W/kg) | Σ SAR (W/kg) |
|---------------|-------------------|---------------------|-----------------------|--------------|
| Back Side | CDMA BC10 (§90S) | 1.030 | 0.275 | 1.305 |
| Back Side | CDMA BC0 (§22H) | 1.010 | 0.275 | 1.285 |
| Back Side | PCS CDMA | 1.057 | 0.275 | 1.332 |
| Back Side | LTE Band 26 | 0.532 | 0.275 | 0.807 |
| Back Side | LTE Band 25 (PCS) | 0.422 | 0.275 | 0.697 |
| Back Side | LTE Band 41 | 1.099 | 0.275 | 1.374 |

The worst case 5 GHz WLAN reported SAR for each body-worn configuration was used for SAR summation, regardless of whether the WLAN channel has WIFI Hotspot capability. Therefore, the summations above represent the absolute worst cases for simultaneous transmission with 5 GHz WLAN



| | | | | |
|--------------------------------------|---|-------------------------------|---|---------------------------------|
| FCC ID A3LSPHL520 |  PCTEST ENGINEERING LABORATORY, INC. | SAR EVALUATION REPORT |  | Reviewed by: Quality Manager |
| Document S/N: OY1306281121-R2.A3L | Test Dates: 07/01/13 - 07/19/13 | DUT Type: Portable Handset | | Page 51 of 60 |

Table 12-6
Simultaneous Transmission Scenario with Bluetooth (Body-Worn at 10 mm)

| Configuration | Mode | 2G/3G/4G SAR (W/kg) | Bluetooth SAR (W/kg) | Σ SAR (W/kg) |
|---------------|-------------------|---------------------|----------------------|--------------|
| Back Side | CDMA BC10 (§90S) | 1.030 | 0.208 | 1.238 |
| Back Side | CDMA BC0 (§22H) | 1.010 | 0.208 | 1.218 |
| Back Side | PCS CDMA | 1.057 | 0.208 | 1.265 |
| Back Side | LTE Band 26 | 0.532 | 0.208 | 0.740 |
| Back Side | LTE Band 25 (PCS) | 0.422 | 0.208 | 0.630 |
| Back Side | LTE Band 41 | 1.099 | 0.208 | 1.307 |



Note: Bluetooth SAR was not required to be measured per FCC KDB 447498. Estimated SAR results were used in the above table to determine simultaneous transmission SAR test exclusion.

12.5 Hotspot SAR Simultaneous Transmission Analysis

Per FCC KDB Publication 941225 D06v01, the devices edges with antennas more than 2.5 cm from edge are not required to be evaluated for SAR (“-”).

Table 12-7
Simultaneous Transmission Scenario (2.4 GHz Hotspot at 1.0 cm)

| Simult Tx | Configuration | EVDO BC10 (§90S) SAR (W/kg) | 2.4 GHz WLAN SAR (W/kg) | Σ SAR (W/kg) | Simult Tx | Configuration | EVDO BC0 (§22H) SAR (W/kg) | 2.4 GHz WLAN SAR (W/kg) | Σ SAR (W/kg) |
|-----------|---------------|-----------------------------|-------------------------|--------------|-----------|---------------|----------------------------|-------------------------|--------------|
| Body SAR | Back | 1.076 | 0.066 | 1.142 | Body SAR | Back | 0.973 | 0.066 | 1.039 |
| | Front | 0.596 | 0.019 | 0.615 | | Front | 0.672 | 0.019 | 0.691 |
| | Top | - | 0.022 | 0.022 | | Top | - | 0.022 | 0.022 |
| | Bottom | 0.231 | - | 0.231 | | Bottom | 0.307 | - | 0.307 |
| | Right | - | 0.063 | 0.063 | | Right | - | 0.063 | 0.063 |
| | Left | 0.856 | - | 0.856 | | Left | 0.850 | - | 0.850 |
| Body SAR | Back | 0.949 | 0.066 | 1.015 | Body SAR | Back | 0.532 | 0.066 | 0.598 |
| | Front | 0.613 | 0.019 | 0.632 | | Front | 0.441 | 0.019 | 0.460 |
| | Top | - | 0.022 | 0.022 | | Top | - | 0.022 | 0.022 |
| | Bottom | 0.830 | - | 0.830 | | Bottom | 0.166 | - | 0.166 |
| | Right | - | 0.063 | 0.063 | | Right | - | 0.063 | 0.063 |
| | Left | 0.417 | - | 0.417 | | Left | 0.646 | - | 0.646 |
| Body SAR | Back | 0.422 | 0.066 | 0.488 | Body SAR | Back | 1.099 | 0.066 | 1.165 |
| | Front | 0.453 | 0.019 | 0.472 | | Front | 0.238 | 0.019 | 0.257 |
| | Top | - | 0.022 | 0.022 | | Top | - | 0.022 | 0.022 |
| | Bottom | 0.454 | - | 0.454 | | Bottom | 0.374 | - | 0.374 |
| | Right | - | 0.063 | 0.063 | | Right | - | 0.063 | 0.063 |
| | Left | 0.225 | - | 0.225 | | Left | 0.409 | - | 0.409 |



| | | | | |
|---|--|--------------------------------------|---|--|
| FCC ID A3LSPHL520 |  PCTEST <small>TECHNOLOGICAL LABORATORY, INC.</small> | SAR EVALUATION REPORT |  | Reviewed by: Quality Manager |
| Document S/N: OY1306281121-R2.A3L | Test Dates: 07/01/13 - 07/19/13 | DUT Type: Portable Handset | Page 52 of 60 | |

**Table 12-8
Simultaneous Transmission Scenario (5 GHz Hotspot at 1.0 cm)**

| Simult Tx | Configuration | EVDO BC10 (§90S) SAR (W/kg) | 5 GHz WLAN SAR (W/kg) | Σ SAR (W/kg) | Simult Tx | Configuration | EVDO BC0 (§22H) SAR (W/kg) | 5 GHz WLAN SAR (W/kg) | Σ SAR (W/kg) |
|-----------|---------------|------------------------------|-----------------------|--------------|-----------|---------------|----------------------------|-----------------------|--------------|
| Body SAR | Back | 1.076 | 0.075 | 1.151 | Body SAR | Back | 0.973 | 0.075 | 1.048 |
| | Front | 0.596 | 0.004 | 0.600 | | Front | 0.672 | 0.004 | 0.676 |
| | Top | - | 0.012 | 0.012 | | Top | - | 0.012 | 0.012 |
| | Bottom | 0.231 | - | 0.231 | | Bottom | 0.307 | - | 0.307 |
| | Right | - | 0.082 | 0.082 | | Right | - | 0.082 | 0.082 |
| | Left | 0.856 | - | 0.856 | | Left | 0.850 | - | 0.850 |
| Simult Tx | Configuration | PCS EVDO SAR (W/kg) | 5 GHz WLAN SAR (W/kg) | Σ SAR (W/kg) | Simult Tx | Configuration | LTE Band 26 SAR (W/kg) | 5 GHz WLAN SAR (W/kg) | Σ SAR (W/kg) |
| Body SAR | Back | 0.949 | 0.075 | 1.024 | Body SAR | Back | 0.532 | 0.075 | 0.607 |
| | Front | 0.613 | 0.004 | 0.617 | | Front | 0.441 | 0.004 | 0.445 |
| | Top | - | 0.012 | 0.012 | | Top | - | 0.012 | 0.012 |
| | Bottom | 0.830 | - | 0.830 | | Bottom | 0.166 | - | 0.166 |
| | Right | - | 0.082 | 0.082 | | Right | - | 0.082 | 0.082 |
| | Left | 0.417 | - | 0.417 | | Left | 0.646 | - | 0.646 |
| Simult Tx | Configuration | LTE Band 25 (PCS) SAR (W/kg) | 5 GHz WLAN SAR (W/kg) | Σ SAR (W/kg) | Simult Tx | Configuration | LTE Band 41 SAR (W/kg) | 5 GHz WLAN SAR (W/kg) | Σ SAR (W/kg) |
| Body SAR | Back | 0.422 | 0.075 | 0.497 | Body SAR | Back | 1.099 | 0.075 | 1.174 |
| | Front | 0.453 | 0.004 | 0.457 | | Front | 0.238 | 0.004 | 0.242 |
| | Top | - | 0.012 | 0.012 | | Top | - | 0.012 | 0.012 |
| | Bottom | 0.454 | - | 0.454 | | Bottom | 0.374 | - | 0.374 |
| | Right | - | 0.082 | 0.082 | | Right | - | 0.082 | 0.082 |
| | Left | 0.225 | - | 0.225 | | Left | 0.409 | - | 0.409 |

12.6 Simultaneous Transmission Conclusion

The above numerical summed SAR results for all the worst-case simultaneous transmission conditions were below the SAR limit. Therefore, the above analysis is sufficient to determine that simultaneous transmission cases will not exceed the SAR limit and therefore no measured volumetric simultaneous SAR summation is required per FCC KDB Publication 447498 D01v05.

| | | | | |
|--------------------------------------|---|-------------------------------|---|---------------------------------|
| FCC ID A3LSPHL520 |  | SAR EVALUATION REPORT |  | Reviewed by: Quality Manager |
| Document S/N: 0Y1306281121-R2.A3L | Test Dates: 07/01/13 - 07/19/13 | DUT Type: Portable Handset | Page 53 of 60 | |

13 SAR MEASUREMENT VARIABILITY

13.1 Measurement Variability

Per FCC KDB Publication 865664 D01v01, SAR measurement variability was assessed for each frequency band, which was determined by the SAR probe calibration point and tissue-equivalent medium used for the device measurements. When both head and body tissue-equivalent media were required for SAR measurements in a frequency band, the variability measurement procedures were applied to the tissue medium with the highest measured SAR, using the highest measured SAR configuration for that tissue-equivalent medium. These additional measurements were repeated after the completion of all measurements requiring the same head or body tissue-equivalent medium in a frequency band. The test device was returned to ambient conditions (normal room temperature) with the battery fully charged before it was re-mounted on the device holder for the repeated measurement(s) to minimize any unexpected variations in the repeated results.

SAR Measurement Variability was assessed using the following procedures for each frequency band:



- 1) When the original highest measured SAR is ≥ 0.80 W/kg, the measurement was repeated once.
- 2) A second repeated measurement was performed only if the ratio of largest to smallest SAR for the original and first repeated measurements was > 1.20 or when the original or repeated measurement was ≥ 1.45 W/kg (~ 10% from the 1-g SAR limit).
- 3) A third repeated measurement was performed only if the original, first or second repeated measurement was ≥ 1.5 W/kg and the ratio of largest to smallest SAR for the original, first and second repeated measurements is > 1.20 .
- 4) Repeated measurements are not required when the original highest measured SAR is < 0.80 W/kg

**Table 13-1
Body SAR Measurement Variability Results**

| BODY VARIABILITY RESULTS | | | | | | | | | | | | | |
|---|-----------|-------|-------------------|-------------------------|------|---------|---|-----------------------|-------|-----------------------|-------|-----------------------|-------|
| Band | FREQUENCY | | Mode | Service | Side | Spacing | Measured SAR (1g) | 1st Repeated SAR (1g) | Ratio | 2nd Repeated SAR (1g) | Ratio | 3rd Repeated SAR (1g) | Ratio |
| | MHz | Ch. | | | | | (W/kg) | (W/kg) | | (W/kg) | | (W/kg) | |
| 835 | 820.10 | 564 | CDMA BC10 (\$90S) | EVDO Rev. 0 | back | 10 mm | 1.030 | 1.030 | 1.00 | N/A | N/A | N/A | N/A |
| 1900 | 1880.00 | 600 | PCS CDMA | TDSO / SO32 | back | 10 mm | 1.010 | 0.954 | 1.06 | N/A | N/A | N/A | N/A |
| 2600 | 2636.50 | 41055 | LTE Band 41 | QPSK, 1 RB, 0 RB Offset | back | 10 mm | 1.030 | 1.030 | 1.00 | N/A | N/A | N/A | N/A |
| ANSI / IEEE C95.1 1992 - SAFETY LIMIT Spatial Peak Uncontrolled Exposure/General Population | | | | | | | Body 1.6 W/kg (mW/g) averaged over 1 gram | | | | | | |

13.2 Measurement Uncertainty



The measured SAR was < 1.5 W/kg for all frequency bands. Therefore, per KDB Publication 865664 D01v01, the standard measurement uncertainty analysis per IEEE 1528-2003 was not required.

| | | | | |
|--------------------------------------|---|-------------------------------|---|---------------------------------|
| FCC ID A3LSPHL520 |  PCTEST ENGINEERING LABORATORY, INC. | SAR EVALUATION REPORT |  | Reviewed by: Quality Manager |
| Document S/N: OY1306281121-R2.A3L | Test Dates: 07/01/13 - 07/19/13 | DUT Type: Portable Handset | Page 54 of 60 | |

14 EQUIPMENT LIST

| Manufacturer | Model | Description | Cal Date | Cal Interval | Cal Due | Serial Number |
|--------------------|-----------------|---|------------|--------------|------------|---------------|
| Agilent | 85047A | S-Parameter Test Set | N/A | N/A | N/A | 2904A00579 |
| Agilent | 85070C | Dielectric Probe Kit | 2/14/2013 | Annual | 2/14/2014 | MY44300633 |
| Agilent | 8594A | (9kHz-2.9GHz) Spectrum Analyzer | N/A | N/A | N/A | 3051A00187 |
| Agilent | 8648D | (9kHz-4GHz) Signal Generator | 4/17/2013 | Annual | 4/17/2014 | 3629U00687 |
| Agilent | 8753E | (30kHz-6GHz) Network Analyzer | 4/16/2013 | Annual | 4/16/2014 | JP38020182 |
| Agilent | E5515C | Wireless Communications Test Set | 9/24/2012 | Annual | 9/24/2013 | GB43163447 |
| Agilent | E8257D | (250kHz-20GHz) Signal Generator | 4/16/2013 | Annual | 4/16/2014 | MY45470194 |
| Amplifier Research | 5S1G4 | 5W, 800MHz-4.2GHz | CBT | N/A | CBT | 21910 |
| Anritsu | MA24106A | USB Power Sensor | 8/22/2012 | Annual | 8/22/2013 | 1231535 |
| Anritsu | MA24106A | USB Power Sensor | 8/22/2012 | Annual | 8/22/2013 | 1231538 |
| Anritsu | MA2411B | Pulse Power Sensor | 12/5/2012 | Annual | 12/5/2013 | 1126066 |
| Anritsu | MA2411B | Pulse Power Sensor | 12/4/2012 | Annual | 12/4/2013 | 1207364 |
| Anritsu | MA2481A | Power Sensor | 2/14/2013 | Annual | 2/14/2014 | 2400 |
| Anritsu | MA2481A | Power Sensor | 2/14/2013 | Annual | 2/14/2014 | 5318 |
| Anritsu | MA2481D | Universal Sensor | 12/17/2012 | Annual | 12/17/2013 | 1204343 |
| Anritsu | MA2481D | Universal Sensor | 12/17/2012 | Annual | 12/17/2013 | 1204419 |
| Anritsu | ML2438A | Power Meter | 12/4/2012 | Annual | 12/4/2013 | 1070030 |
| Anritsu | ML2496A | Power Meter | 11/28/2012 | Annual | 11/28/2013 | 1138001 |
| Anritsu | MT8820C | Radio Communication Tester | 11/6/2012 | Annual | 11/6/2013 | 6200901190 |
| Anritsu | MT8820C | Radio Communication Analyzer | 6/28/2013 | Annual | 6/28/2014 | 6201240328 |
| COMTECH | AR85729-5 | Solid State Amplifier | CBT | N/A | CBT | M355A00-009 |
| COMTECH | AR85729-5/5759B | Solid State Amplifier | CBT | N/A | CBT | M3W1A00-1002 |
| Control Company | 4353 | Long Stem Thermometer | 9/25/2012 | Biennial | 9/25/2014 | 122539615 |
| Control Company | 36934-158 | Wall-Mounted Thermometer | 1/4/2012 | Biennial | 1/4/2014 | 122014488 |
| Fisher Scientific | 15-077-960 | Thermometer | 11/6/2012 | Biennial | 11/6/2014 | 122640025 |
| Fisher Scientific | 15-078J | Long Stem Thermometer | 10/30/2012 | Biennial | 10/30/2014 | 122626059 |
| MCL | BW-N6W5+ | 6dB Attenuator | CBT | N/A | CBT | 1139 |
| MiniCircuits | SLP-2400+ | Low Pass Filter | CBT | N/A | CBT | R897950903 |
| MiniCircuits | VLF-6000+ | Low Pass Filter | CBT | N/A | CBT | N/A |
| MiniCircuits | VLF-6000+ | Low Pass Filter | CBT | N/A | CBT | N/A |
| Mini-Circuits | BW-N20W5+ | Power Attenuator | CBT | N/A | CBT | 1226 |
| Mini-Circuits | BW-N20W5+ | DC to 18 GHz Precision Fixed 20 dB Attenuator | CBT | N/A | CBT | N/A |
| Mini-Circuits | NLP-1200+ | Low Pass Filter DC to 1000 MHz | CBT | N/A | CBT | N/A |
| Mini-Circuits | NLP-2950+ | Low Pass Filter DC to 2700 MHz | CBT | N/A | CBT | N/A |
| Narda | 4014C-6 | 4 - 8 GHz SMA 6 dB Directional Coupler | CBT | N/A | CBT | N/A |
| Narda | 4772-3 | Attenuator (3dB) | CBT | N/A | CBT | 9406 |
| Narda | BW-S3W2 | Attenuator (3dB) | CBT | N/A | CBT | 120 |
| Pasternack | PE2208-6 | Bidirectional Coupler | CBT | N/A | CBT | N/A |
| Pasternack | PE2209-10 | Bidirectional Coupler | CBT | N/A | CBT | N/A |
| Rohde & Schwarz | CMW500 | LTE Radio Communication Tester | 2/8/2013 | Annual | 2/8/2014 | 101699 |
| Rohde & Schwarz | CMW500 | LTE Radio Communication Tester | 10/7/2011 | Biennial | 10/7/2013 | 103962 |
| Rohde & Schwarz | CMW500 | LTE Radio Communication Tester | 9/26/2012 | Annual | 9/26/2013 | 108798 |
| Rohde & Schwarz | SME06 | Signal Generator | 10/11/2012 | Annual | 10/11/2013 | 832026 |
| Rohde & Schwarz | SMIQ03B | Signal Generator | 4/17/2013 | Annual | 4/17/2014 | DE27259 |
| Seekonk | NC-100 | Torque Wrench (8" lb) | 11/29/2011 | Triennial | 11/29/2014 | 21053 |
| SPEAG | D1900V2 | 1900 MHz SAR Dipole | 7/20/2012 | Annual | 7/20/2013 | 54080 |
| SPEAG | D1900V2 | 1900 MHz SAR Dipole | 2/6/2013 | Annual | 2/6/2014 | 5d148 |
| SPEAG | D2450V2 | 2450 MHz SAR Dipole | 8/23/2012 | Annual | 8/23/2013 | 719 |
| SPEAG | D2450V2 | 2450 MHz SAR Dipole | 1/8/2013 | Annual | 1/8/2014 | 797 |
| SPEAG | D2600V2 | 2600 MHz SAR Dipole | 5/2/2013 | Annual | 5/2/2014 | 1004 |
| SPEAG | D5GHzv2 | 5 GHz SAR Dipole | 1/11/2013 | Annual | 1/11/2014 | 1057 |
| SPEAG | D5GHzv2 | 5 GHz SAR Dipole | 2/14/2013 | Annual | 2/14/2014 | 1120 |
| SPEAG | D835V2 | 835 MHz SAR Dipole | 8/23/2012 | Annual | 8/23/2013 | 44026 |
| SPEAG | D835V2 | 835 MHz SAR Dipole | 1/7/2013 | Annual | 1/7/2014 | 4d132 |
| SPEAG | DAE4 | Dasy Data Acquisition Electronics | 2/6/2013 | Annual | 2/6/2014 | 649 |
| SPEAG | DAE4 | Dasy Data Acquisition Electronics | 1/17/2013 | Annual | 1/17/2014 | 1272 |
| SPEAG | DAE4 | Dasy Data Acquisition Electronics | 8/24/2012 | Annual | 8/24/2013 | 1322 |
| SPEAG | DAE4 | Dasy Data Acquisition Electronics | 9/19/2012 | Annual | 9/19/2013 | 1323 |
| SPEAG | DAE4 | Dasy Data Acquisition Electronics | 11/13/2012 | Annual | 11/13/2013 | 1333 |
| SPEAG | DAE4 | Dasy Data Acquisition Electronics | 3/8/2013 | Annual | 3/8/2014 | 1334 |
| SPEAG | DAK-3.5 | Dielectric Assessment Kit | 5/14/2013 | Annual | 5/14/2014 | 1070 |
| SPEAG | DAK-3.5 | Dielectric Assessment Kit | 12/11/2012 | Annual | 12/11/2013 | 1091 |
| SPEAG | ES30V2 | SAR Probe | 8/28/2012 | Annual | 8/28/2013 | 3022 |
| SPEAG | ES30V3 | SAR Probe | 3/15/2013 | Annual | 3/15/2014 | 3209 |
| SPEAG | ES30V3 | SAR Probe | 11/15/2012 | Annual | 11/15/2013 | 3287 |
| SPEAG | ES30V3 | SAR Probe | 9/20/2012 | Annual | 9/20/2013 | 3288 |
| SPEAG | EX30V4 | SAR Probe | 1/17/2013 | Annual | 1/17/2014 | 3589 |
| SPEAG | EX30V4 | SAR Probe | 2/27/2013 | Annual | 2/27/2014 | 3920 |
| Tektronix | RSA6114A | Real Time Spectrum Analyzer | 4/17/2013 | Annual | 4/17/2014 | 8010177 |
| VWR | 23226-658 | Long Stem Thermometer | 3/30/2012 | Biennial | 3/30/2014 | 122179874 |
| VWR | 36934-158 | Wall-Mounted Thermometer | 9/30/2011 | Biennial | 9/30/2013 | 111859323 |
| VWR | 62344-925 | Mini-Thermometer | 10/24/2011 | Biennial | 10/24/2013 | 111886414 |

Note: CBT (Calibrated Before Testing). Prior to testing, the measurement paths containing a cable, amplifier, attenuator, coupler or filter were connected to a calibrated source (i.e. a signal generator) to determine the losses of the measurement path. The power meter offset was then adjusted to compensate for the measurement system losses. This level offset is stored within the power meter before measurements are made. This calibration verification procedure applies to the system verification and output power measurements. The calibrated reading is then taken directly from the power meter after compensation of the losses for all final power measurements.



| | | | | |
|---|---|--------------------------------------|---|--|
| FCC ID A3LSPHL520 |  | SAR EVALUATION REPORT |  | Reviewed by: Quality Manager |
| Document S/N: OY1306281121-R2.A3L | Test Dates: 07/01/13 - 07/19/13 | DUT Type: Portable Handset | Page 55 of 60 | |

15 MEASUREMENT UNCERTAINTIES

Applicable for frequencies less than 3000 MHz.

| a | b | c | d | e= f(d,k) | f | g | h = c x f/e | i = c x g/e | k |
|---|----------------------|---------------|----------------|--------------|-----------------------|--------------------------|--------------------------------|----------------------------------|----------------|
| Uncertainty Component | IEEE 1528 Sec. | Tol. (± %) | Prob. Dist. | Div. | c _i 1gm | c _i 10 gms | 1gm u _i (± %) | 10gms u _i (± %) | v _i |
| Measurement System | | | | | | | | | |
| Probe Calibration | E.2.1 | 6.0 | N | 1 | 1.0 | 1.0 | 6.0 | 6.0 | ∞ |
| Axial Isotropy | E.2.2 | 0.25 | N | 1 | 0.7 | 0.7 | 0.2 | 0.2 | ∞ |
| Hemishperical Isotropy | E.2.2 | 1.3 | N | 1 | 1.0 | 1.0 | 1.3 | 1.3 | ∞ |
| Boundary Effect | E.2.3 | 0.4 | N | 1 | 1.0 | 1.0 | 0.4 | 0.4 | ∞ |
| Linearity | E.2.4 | 0.3 | N | 1 | 1.0 | 1.0 | 0.3 | 0.3 | ∞ |
| System Detection Limits | E.2.5 | 5.1 | N | 1 | 1.0 | 1.0 | 5.1 | 5.1 | ∞ |
| Readout Electronics | E.2.6 | 1.0 | N | 1 | 1.0 | 1.0 | 1.0 | 1.0 | ∞ |
| Response Time | E.2.7 | 0.8 | R | 1.73 | 1.0 | 1.0 | 0.5 | 0.5 | ∞ |
| Integration Time | E.2.8 | 2.6 | R | 1.73 | 1.0 | 1.0 | 1.5 | 1.5 | ∞ |
| RF Ambient Conditions | E.6.1 | 3.0 | R | 1.73 | 1.0 | 1.0 | 1.7 | 1.7 | ∞ |
| Probe Positioner Mechanical Tolerance | E.6.2 | 0.4 | R | 1.73 | 1.0 | 1.0 | 0.2 | 0.2 | ∞ |
| Probe Positioning w/ respect to Phantom | E.6.3 | 2.9 | R | 1.73 | 1.0 | 1.0 | 1.7 | 1.7 | ∞ |
| Extrapolation, Interpolation & Integration algorithms for Max. SAR Evaluation | E.5 | 1.0 | R | 1.73 | 1.0 | 1.0 | 0.6 | 0.6 | ∞ |
| Test Sample Related | | | | | | | | | |
| Test Sample Positioning | E.4.2 | 6.0 | N | 1 | 1.0 | 1.0 | 6.0 | 6.0 | 287 |
| Device Holder Uncertainty | E.4.1 | 3.32 | R | 1.73 | 1.0 | 1.0 | 1.9 | 1.9 | ∞ |
| Output Power Variation - SAR drift measurement | 6.6.2 | 5.0 | R | 1.73 | 1.0 | 1.0 | 2.9 | 2.9 | ∞ |
| Phantom & Tissue Parameters | | | | | | | | | |
| Phantom Uncertainty (Shape & Thickness tolerances) | E.3.1 | 4.0 | R | 1.73 | 1.0 | 1.0 | 2.3 | 2.3 | ∞ |
| Liquid Conductivity - deviation from target values | E.3.2 | 5.0 | R | 1.73 | 0.64 | 0.43 | 1.8 | 1.2 | ∞ |
| Liquid Conductivity - measurement uncertainty | E.3.3 | 3.8 | N | 1 | 0.64 | 0.43 | 2.4 | 1.6 | 6 |
| Liquid Permittivity - deviation from target values | E.3.2 | 5.0 | R | 1.73 | 0.60 | 0.49 | 1.7 | 1.4 | ∞ |
| Liquid Permittivity - measurement uncertainty | E.3.3 | 4.5 | N | 1 | 0.60 | 0.49 | 2.7 | 2.2 | 6 |
| Combined Standard Uncertainty (k=1) | | | | RSS | | | 12.1 | 11.7 | 299 |
| Expanded Uncertainty (95% CONFIDENCE LEVEL) | | | | k=2 | | | 24.2 | 23.5 | |



The above measurement uncertainties are according to IEEE Std. 1528-2003

| | | | | |
|---|---|--------------------------------------|---|--|
| FCC ID A3LSPHL520 |  PCTEST ENGINEERING LABORATORY, INC. | SAR EVALUATION REPORT |  | Reviewed by: Quality Manager |
| Document S/N: OY1306281121-R2.A3L | Test Dates: 07/01/13 - 07/19/13 | DUT Type: Portable Handset | Page 56 of 60 | |

Applicable for frequencies up to 6 GHz.

| a | b | c | d | e= f(d,k) | f | g | h = c x f/e | i = c x g/e | k | |
|---|----------------------|---------------|----------------|--------------|-----------------------|--------------------------|--------------------------------|----------------------------------|----------------|-----|
| Uncertainty Component | IEEE 1528 Sec. | Tol. (± %) | Prob. Dist. | Div. | c _i 1gm | c _i 10 gms | 1gm u _i (± %) | 10gms u _i (± %) | v _i | |
| Measurement System | | | | | | | | | | |
| Probe Calibration | E.2.1 | 6.55 | N | 1 | 1.0 | 1.0 | 6.6 | 6.6 | ∞ | |
| Axial Isotropy | E.2.2 | 0.25 | N | 1 | 0.7 | 0.7 | 0.2 | 0.2 | ∞ | |
| Hemishperical Isotropy | E.2.2 | 1.3 | N | 1 | 1.0 | 1.0 | 1.3 | 1.3 | ∞ | |
| Boundary Effect | E.2.3 | 0.4 | N | 1 | 1.0 | 1.0 | 0.4 | 0.4 | ∞ | |
| Linearity | E.2.4 | 0.3 | N | 1 | 1.0 | 1.0 | 0.3 | 0.3 | ∞ | |
| System Detection Limits | E.2.5 | 5.1 | N | 1 | 1.0 | 1.0 | 5.1 | 5.1 | ∞ | |
| Readout Electronics | E.2.6 | 1.0 | N | 1 | 1.0 | 1.0 | 1.0 | 1.0 | ∞ | |
| Response Time | E.2.7 | 0.8 | R | 1.73 | 1.0 | 1.0 | 0.5 | 0.5 | ∞ | |
| Integration Time | E.2.8 | 2.6 | R | 1.73 | 1.0 | 1.0 | 1.5 | 1.5 | ∞ | |
| RF Ambient Conditions | E.6.1 | 3.0 | R | 1.73 | 1.0 | 1.0 | 1.7 | 1.7 | ∞ | |
| Probe Positioner Mechanical Tolerance | E.6.2 | 0.4 | R | 1.73 | 1.0 | 1.0 | 0.2 | 0.2 | ∞ | |
| Probe Positioning w/ respect to Phantom | E.6.3 | 2.9 | R | 1.73 | 1.0 | 1.0 | 1.7 | 1.7 | ∞ | |
| Extrapolation, Interpolation & Integration algorithms for Max. SAR Evaluation | E.5 | 1.0 | R | 1.73 | 1.0 | 1.0 | 0.6 | 0.6 | ∞ | |
| Test Sample Related | | | | | | | | | | |
| Test Sample Positioning | E.4.2 | 6.0 | N | 1 | 1.0 | 1.0 | 6.0 | 6.0 | 287 | |
| Device Holder Uncertainty | E.4.1 | 3.32 | R | 1.73 | 1.0 | 1.0 | 1.9 | 1.9 | ∞ | |
| Output Power Variation - SAR drift measurement | 6.6.2 | 5.0 | R | 1.73 | 1.0 | 1.0 | 2.9 | 2.9 | ∞ | |
| Phantom & Tissue Parameters | | | | | | | | | | |
| Phantom Uncertainty (Shape & Thickness tolerances) | E.3.1 | 4.0 | R | 1.73 | 1.0 | 1.0 | 2.3 | 2.3 | ∞ | |
| Liquid Conductivity - deviation from target values | E.3.2 | 5.0 | R | 1.73 | 0.64 | 0.43 | 1.8 | 1.2 | ∞ | |
| Liquid Conductivity - measurement uncertainty | E.3.3 | 3.8 | N | 1 | 0.64 | 0.43 | 2.4 | 1.6 | 6 | |
| Liquid Permittivity - deviation from target values | E.3.2 | 5.0 | R | 1.73 | 0.60 | 0.49 | 1.7 | 1.4 | ∞ | |
| Liquid Permittivity - measurement uncertainty | E.3.3 | 4.5 | N | 1 | 0.60 | 0.49 | 2.7 | 2.2 | 6 | |
| Combined Standard Uncertainty (k=1) | | | | | | | RSS | 12.4 | 12.0 | 299 |
| Expanded Uncertainty (95% CONFIDENCE LEVEL) | | | | | | | k=2 | 24.7 | 24.0 | |

The above measurement uncertainties are according to IEEE Std. 1528-2003



| | | | | |
|---|---|--------------------------------------|---|--|
| FCC ID A3LSPHL520 |  PCTEST ENGINEERING LABORATORY, INC. | SAR EVALUATION REPORT |  | Reviewed by: Quality Manager |
| Document S/N: OY1306281121-R2.A3L | Test Dates: 07/01/13 - 07/19/13 | DUT Type: Portable Handset | Page 57 of 60 | |

16 CONCLUSION

16.1 Measurement Conclusion



The SAR evaluation indicates that the EUT complies with the RF radiation exposure limits of the FCC and Industry Canada, with respect to all parameters subject to this test. These measurements were taken to simulate the RF effects of RF exposure under worst-case conditions. Precise laboratory measures were taken to assure repeatability of the tests. The results and statements relate only to the item(s) tested.

Please note that the absorption and distribution of electromagnetic energy in the body are very complex phenomena that depend on the mass, shape, and size of the body, the orientation of the body with respect to the field vectors, and the electrical properties of both the body and the environment. Other variables that may play a substantial role in possible biological effects are those that characterize the environment (e.g. ambient temperature, air velocity, relative humidity, and body insulation) and those that characterize the individual (e.g. age, gender, activity level, debilitation, or disease). Because various factors may interact with one another to vary the specific biological outcome of an exposure to electromagnetic fields, any protection guide should consider maximal amplification of biological effects as a result of field-body interactions, environmental conditions, and physiological variables. [3]



| | | | | |
|---|---|--------------------------------------|---|--|
| FCC ID A3LSPHL520 |  PCTEST ENGINEERING LABORATORY, INC. | SAR EVALUATION REPORT |  | Reviewed by: Quality Manager |
| Document S/N: 0Y1306281121-R2.A3L | Test Dates: 07/01/13 - 07/19/13 | DUT Type: Portable Handset | Page 58 of 60 | |

17 REFERENCES

- [1] Federal Communications Commission, ET Docket 93-62, Guidelines for Evaluating the Environmental Effects of Radiofrequency Radiation, Aug. 1996.
- [2] ANSI/IEEE C95.1-2005, American National Standard safety levels with respect to human exposure to radio frequency electromagnetic fields, 3kHz to 300GHz, New York: IEEE, 2006.
- [3] ANSI/IEEE C95.1-1992, American National Standard safety levels with respect to human exposure to radio frequency electromagnetic fields, 3kHz to 300GHz, New York: IEEE, Sept. 1992.
- [4] ANSI/IEEE C95.3-2002, IEEE Recommended Practice for the Measurement of Potentially Hazardous Electromagnetic Fields - RF and Microwave, New York: IEEE, December 2002.
- [5] Federal Communications Commission, OET Bulletin 65 (Edition 97-01), Supplement C (Edition 01-01), Evaluating Compliance with FCC Guidelines for Human Exposure to Radiofrequency Electromagnetic Fields, June 2001.
- [6] IEEE Standards Coordinating Committee 34 – IEEE Std. 1528-2003, Recommended Practice for Determining the Peak Spatial-Average Specific Absorption Rate (SAR) in the Human Body Due to Wireless Communications Devices.
- [7] NCRP, National Council on Radiation Protection and Measurements, Biological Effects and Exposure Criteria for RadioFrequency Electromagnetic Fields, NCRP Report No. 86, 1986. Reprinted Feb. 1995.
- [8] T. Schmid, O. Egger, N. Kuster, Automated E-field scanning system for dosimetric assessments, IEEE Transaction on Microwave Theory and Techniques, vol. 44, Jan. 1996, pp. 105-113.
- [9] K. Pokovic, T. Schmid, N. Kuster, Robust setup for precise calibration of E-field probes in tissue simulating liquids at mobile communications frequencies, ICECOM97, Oct. 1997, pp. -124.
- [10] K. Pokovic, T. Schmid, and N. Kuster, E-field Probe with improved isotropy in brain simulating liquids, Proceedings of the ELMAR, Zadar, Croatia, June 23-25, 1996, pp. 172-175.
- [11] Schmid & Partner Engineering AG, Application Note: Data Storage and Evaluation, June 1998, p2.
- [12] V. Hombach, K. Meier, M. Burkhardt, E. Kuhn, N. Kuster, The Dependence of EM Energy Absorption upon Human Modeling at 900 MHz, IEEE Transaction on Microwave Theory and Techniques, vol. 44 no. 10, Oct. 1996, pp. 1865-1873.
- [13] N. Kuster and Q. Balzano, Energy absorption mechanism by biological bodies in the near field of dipole antennas above 300MHz, IEEE Transaction on Vehicular Technology, vol. 41, no. 1, Feb. 1992, pp. 17-23.
- [14] G. Hartsgrrove, A. Kraszewski, A. Surowiec, Simulated Biological Materials for Electromagnetic Radiation Absorption Studies, University of Ottawa, Bioelectromagnetics, Canada: 1987, pp. 29-36.
- [15] Q. Balzano, O. Garay, T. Manning Jr., Electromagnetic Energy Exposure of Simulated Users of Portable Cellular Telephones, IEEE Transactions on Vehicular Technology, vol. 44, no.3, Aug. 1995.
- [16] W. Gander, Computermathematik, Birkhaeuser, Basel, 1992.
- [17] W.H. Press, S.A. Teukolsky, W.T. Vetterling, and B.P. Flannery, Numerical Recipes in C, The Art of Scientific Computing, Second edition, Cambridge University Press, 1992.

| | | | | |
|---|---|--------------------------------------|---|--|
| FCC ID A3LSPHL520 |  PCTEST ENGINEERING LABORATORY, INC. | SAR EVALUATION REPORT |  | Reviewed by: Quality Manager |
| Document S/N: OY1306281121-R2.A3L | Test Dates: 07/01/13 - 07/19/13 | DUT Type: Portable Handset | Page 59 of 60 | |

- [18] Federal Communications Commission, OET Bulletin 65, Evaluating Compliance with FCC Guidelines for Human Exposure to Radiofrequency Electromagnetic Fields. Supplement C, Dec. 1997.
- [19] N. Kuster, R. Kastle, T. Schmid, Dosimetric evaluation of mobile communications equipment with known precision, IEEE Transaction on Communications, vol. E80-B, no. 5, May 1997, pp. 645-652.
- [20] CENELEC CLC/SC111B, European Prestandard (prENV 50166-2), Human Exposure to Electromagnetic Fields High-frequency: 10kHz-300GHz, Jan. 1995.
- [21] Prof. Dr. Niels Kuster, ETH, Eidgenössische Technische Hochschule Zürich, Dosimetric Evaluation of the Cellular Phone.
- [22] IEC 62209-1, Human exposure to radio frequency fields from hand-held and body-mounted wireless communication devices - Human models, instrumentation, and procedures - Part 1: Procedure to determine the specific absorption rate (SAR) for hand-held devices used in close proximity to the ear (frequency range of 300 MHz to 3 GHz), Feb. 2005.
- [23] Industry Canada RSS-102 Radio Frequency Exposure Compliance of Radiocommunication Apparatus (All Frequency Bands) Issue 4, March 2010.
- [24] Health Canada Safety Code 6 Limits of Human Exposure to Radio Frequency Electromagnetic Fields in the Frequency Range from 3 kHz – 300 GHz, 2009
- [25] FCC Public Notice DA-02-1438. Office of Engineering and Technology Announces a Transition Period for the Phantom Requirements of Supplement C to OET Bulletin 65, June 19, 2002
- [26] FCC SAR Test Procedures for 2G-3G Devices, Mobile Hotspot and UMPC Devices KDB Publications 941225, D01-D07
- [27] SAR Measurement procedures for IEEE 802.11a/b/g KDB Publication 248227 D01v01r02
- [28] FCC SAR Considerations for Handsets with Multiple Transmitters and Antennas, KDB Publications 648474 D02-D04
- [29] FCC SAR Evaluation Considerations for Laptop, Notebook, Netbook and Tablet Computers, FCC KDB Publication 616217 D04
- [30] FCC SAR Measurement and Reporting Requirements for 100MHz – 6 GHz, KDB Publications 865664 D01-D02
- [31] FCC General RF Exposure Guidance and SAR Procedures for Dongles, KDB Publication 447498, D01-D02
- [32] Anexo à Resolução No. 533, de 10 de Setembro de 2009.
- [33] IEC 62209-2, Human exposure to radio frequency fields from hand-held and body-mounted wireless communication devices - Human models, instrumentation, and procedures - Part 2: Procedure to determine the specific absorption rate (SAR) for wireless communication devices used in close proximity to the human body (frequency range of 30 MHz to 6 GHz), Mar. 2010.

| | | | |
|--------------------------------------|---|-------------------------------|--|
| FCC ID A3LSPHL520 |  | SAR EVALUATION REPORT |  Reviewed by: Quality Manager |
| Document S/N: OY1306281121-R2.A3L | Test Dates: 07/01/13 - 07/19/13 | DUT Type: Portable Handset | Page 60 of 60 |

APPENDIX A: SAR TEST DATA

PCTEST ENGINEERING LABORATORY, INC.

DUT: A3LSPHL520; Type: Portable Handset; Serial: 051805a8

Communication System: CDMA; Frequency: 820.1 MHz; Duty Cycle: 1:1

Medium: 835 Head Medium parameters used (interpolated):

$f = 820.1 \text{ MHz}$; $\sigma = 0.914 \text{ S/m}$; $\epsilon_r = 41.199$; $\rho = 1000 \text{ kg/m}^3$

Phantom section: Left Section

Test Date: 07-01-2013; Ambient Temp: 23.9°C; Tissue Temp: 23.2°C

Probe: ES3DV3 - SN3288; ConvF(6.41, 6.41, 6.41); Calibrated: 9/20/2012;

Sensor-Surface: 4mm (Mechanical Surface Detection)

Electronics: DAE4 Sn1323; Calibrated: 9/19/2012

Phantom: SAM v5.0 front; Type: QD000P40CD; Serial: TP-1646

Measurement SW: DASY52, Version 52.8 (7); SEMCAD X Version 14.6.10 (7164)

Mode: Cell. CDMA BC10, Left Head, Cheek, Mid.ch

Area Scan (7x12x1): Measurement grid: dx=15mm, dy=15mm

Zoom Scan (5x5x7)/Cube 0: Measurement grid: dx=8mm, dy=8mm, dz=5mm

Reference Value = 25.792 V/m; Power Drift = -0.01 dB

Peak SAR (extrapolated) = 0.735 W/kg

SAR(1 g) = 0.581 W/kg

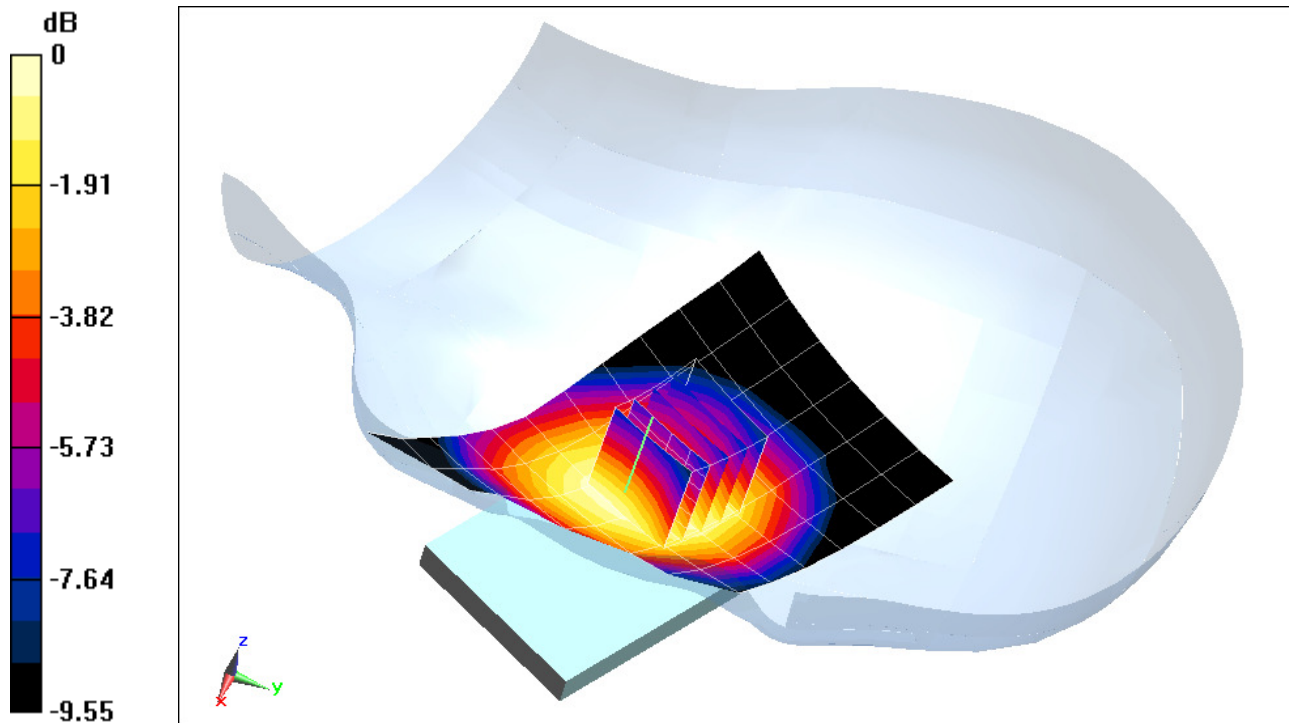

0 dB = 0.604 W/kg = -2.19 dBW/kg

PCTEST ENGINEERING LABORATORY, INC.

DUT: A3LSPHL520; Type: Portable Handset; Serial: 051805a8

Communication System: CDMA; Frequency: 836.52 MHz; Duty Cycle: 1:1

Medium: 835 Head Medium parameters used (interpolated):

$f = 836.52 \text{ MHz}$; $\sigma = 0.93 \text{ S/m}$; $\epsilon_r = 41.043$; $\rho = 1000 \text{ kg/m}^3$

Phantom section: Left Section

Test Date: 07-01-2013; Ambient Temp: 23.9°C; Tissue Temp: 23.2°C

Probe: ES3DV3 - SN3288; ConvF(6.41, 6.41, 6.41); Calibrated: 9/20/2012;

Sensor-Surface: 4mm (Mechanical Surface Detection)

Electronics: DAE4 Sn1323; Calibrated: 9/19/2012

Phantom: SAM v5.0 front; Type: QD000P40CD; Serial: TP-1646

Measurement SW: DASY52, Version 52.8 (7); SEMCAD X Version 14.6.10 (7164)

Mode: Cell. CDMA BC0, Left Head, Cheek, Mid.ch

Area Scan (7x12x1): Measurement grid: dx=15mm, dy=15mm

Zoom Scan (5x5x7)/Cube 0: Measurement grid: dx=8mm, dy=8mm, dz=5mm

Reference Value = 26.774 V/m; Power Drift = -0.10 dB

Peak SAR (extrapolated) = 0.771 W/kg

SAR(1 g) = 0.615 W/kg

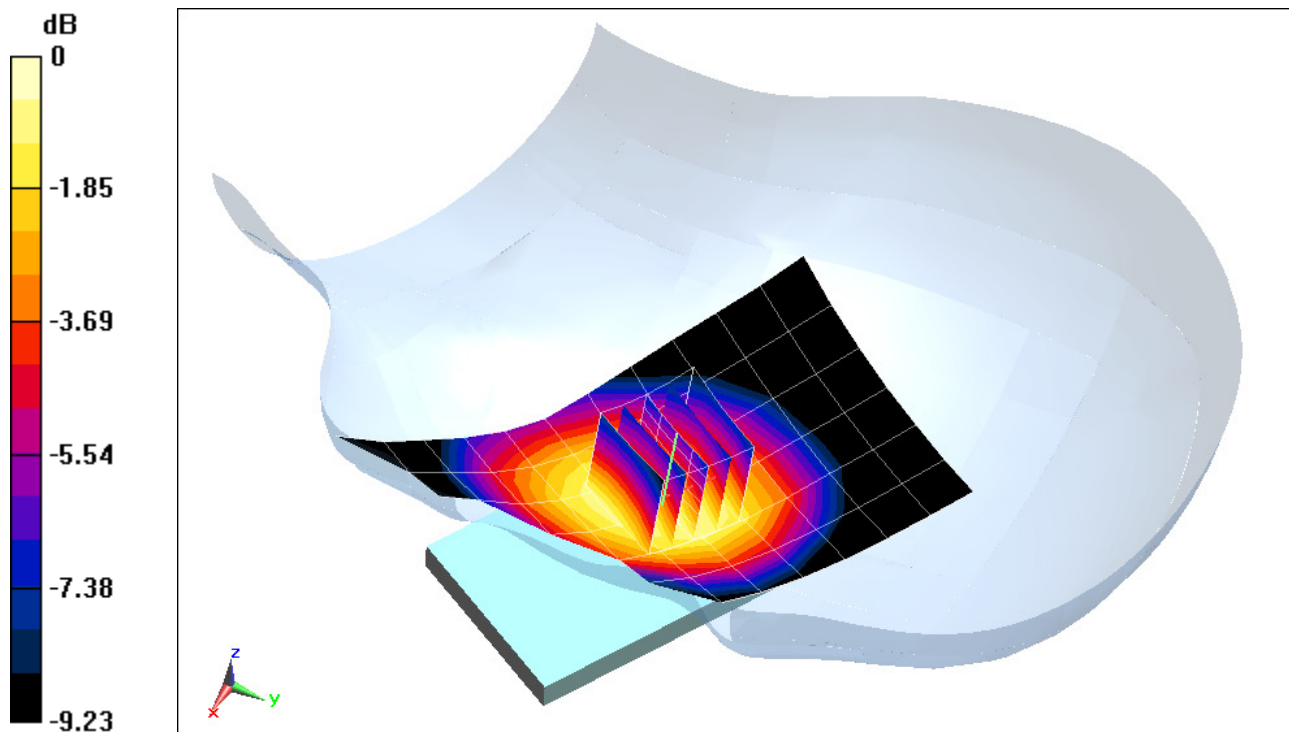

0 dB = 0.654 W/kg = -1.84 dBW/kg

PCTEST ENGINEERING LABORATORY, INC.

DUT: A3LSPHL520; Type: Portable Handset; Serial: 051804e0

Communication System: CDMA; Frequency: 1908.75 MHz; Duty Cycle: 1:1

Medium: 1900 Head Medium parameters used (interpolated):

$f = 1908.75 \text{ MHz}$; $\sigma = 1.455 \text{ S/m}$; $\epsilon_r = 38.972$; $\rho = 1000 \text{ kg/m}^3$

Phantom section: Left Section

Test Date: 07-05-2013; Ambient Temp: 23.6°C; Tissue Temp: 23.0°C

Probe: EX3DV4 - SN3920; ConvF(7.73, 7.73, 7.73); Calibrated: 2/27/2013;

Sensor-Surface: 4mm (Mechanical Surface Detection)

Electronics: DAE4 Sn649; Calibrated: 2/6/2013

Phantom: SAM V5.0 Right; Type: QD000P40CD; Serial: 1647

Measurement SW: DASY52, Version 52.8 (7); SEMCAD X Version 14.6.10 (7164)

Mode: PCS EVDO RevA, Left Head, Cheek, High.ch

Area Scan (7x14x1): Measurement grid: dx=15mm, dy=15mm

Zoom Scan (5x5x7)/Cube 0: Measurement grid: dx=8mm, dy=8mm, dz=5mm

Reference Value = 26.102 V/m; Power Drift = 0.03 dB

Peak SAR (extrapolated) = 1.40 W/kg

SAR(1 g) = 0.900 W/kg

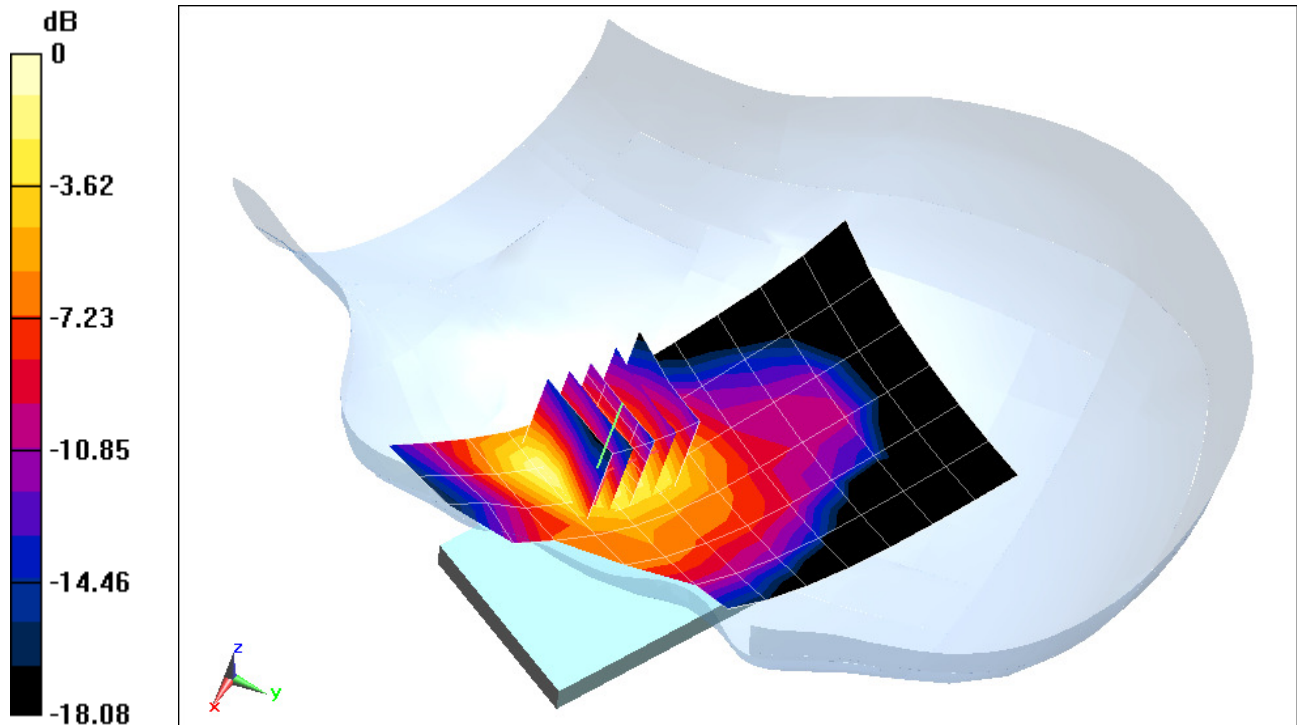

0 dB = 0.993 W/kg = -0.03 dBW/kg

PCTEST ENGINEERING LABORATORY, INC.

DUT: A3LSPHL520; Type: Portable Handset; Serial: 05180482

Communication System: LTE Band 26; Frequency: 819 MHz; Duty Cycle: 1:1

Medium: 835 Head Medium parameters used:

$f = 819 \text{ MHz}$; $\sigma = 0.906 \text{ S/m}$; $\epsilon_r = 40.965$; $\rho = 1000 \text{ kg/m}^3$

Phantom section: Left Section

Test Date: 07-15-2013; Ambient Temp: 24.3°C; Tissue Temp: 23.5°C

Probe: EX3DV4 - SN3920; ConvF(9.58, 9.58, 9.58); Calibrated: 2/27/2013;

Sensor-Surface: 4mm (Mechanical Surface Detection)

Electronics: DAE4 Sn649; Calibrated: 2/6/2013

Phantom: SAM V5.0 Right; Type: QD000P40CD; Serial: 1647

Measurement SW: DASY52, Version 52.8 (7); SEMCAD X Version 14.6.10 (7164)

**Mode: LTE Band 26, Left Head, Cheek, Low.ch, QPSK
10 MHz Bandwidth, 1 RB, 49 RB Offset**

Area Scan (8x14x1): Measurement grid: dx=15mm, dy=15mm

Zoom Scan (5x5x7)/Cube 0: Measurement grid: dx=8mm, dy=8mm, dz=5mm

Reference Value = 21.144 V/m; Power Drift = 0.09 dB

Peak SAR (extrapolated) = 0.476 W/kg

SAR(1 g) = 0.373 W/kg

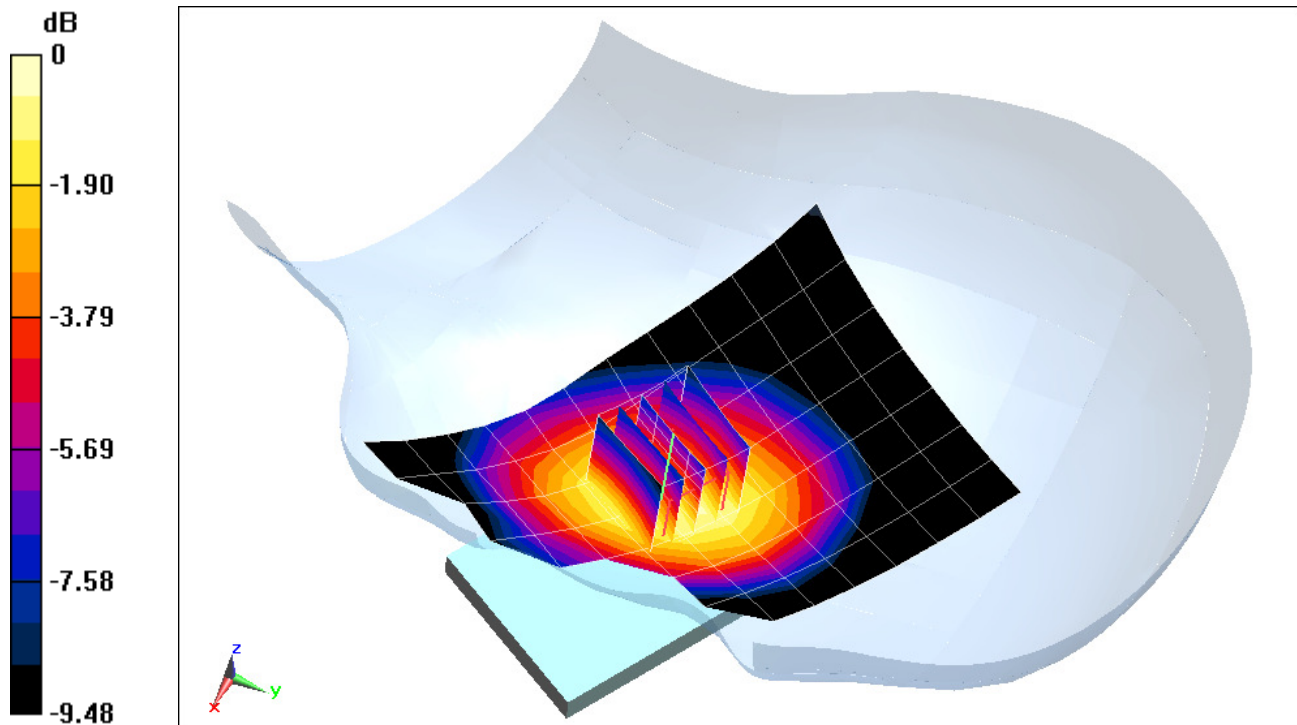

0 dB = 0.399 W/kg = -3.99 dBW/kg

PCTEST ENGINEERING LABORATORY, INC.

DUT: A3LSPHL520; Type: Portable Handset; Serial: 051805af

Communication System: LTE Band 25 (PCS); Frequency: 1855 MHz; Duty Cycle: 1:1

Medium: 1900 Head Medium parameters used (interpolated):

$f = 1855 \text{ MHz}$; $\sigma = 1.4 \text{ S/m}$; $\epsilon_r = 39.214$; $\rho = 1000 \text{ kg/m}^3$

Phantom section: Left Section

Test Date: 07-05-2013; Ambient Temp: 23.6°C; Tissue Temp: 23.0°C

Probe: EX3DV4 - SN3920; ConvF(7.73, 7.73, 7.73); Calibrated: 2/27/2013;

Sensor-Surface: 4mm (Mechanical Surface Detection)

Electronics: DAE4 Sn649; Calibrated: 2/6/2013

Phantom: SAM V5.0 Right; Type: QD000P40CD; Serial: 1647

Measurement SW: DASY52, Version 52.8 (7); SEMCAD X Version 14.6.10 (7164)

**Mode: LTE Band 25 (PCS), Left Head, Cheek, Low.ch,
10 MHz Bandwidth, QPSK, 1 RB, 0 RB Offset**

Area Scan (7x12x1): Measurement grid: dx=15mm, dy=15mm

Zoom Scan (5x5x7)/Cube 0: Measurement grid: dx=8mm, dy=8mm, dz=5mm

Reference Value = 18.222 V/m; Power Drift = 0.06 dB

Peak SAR (extrapolated) = 0.715 W/kg

SAR(1 g) = 0.474 W/kg

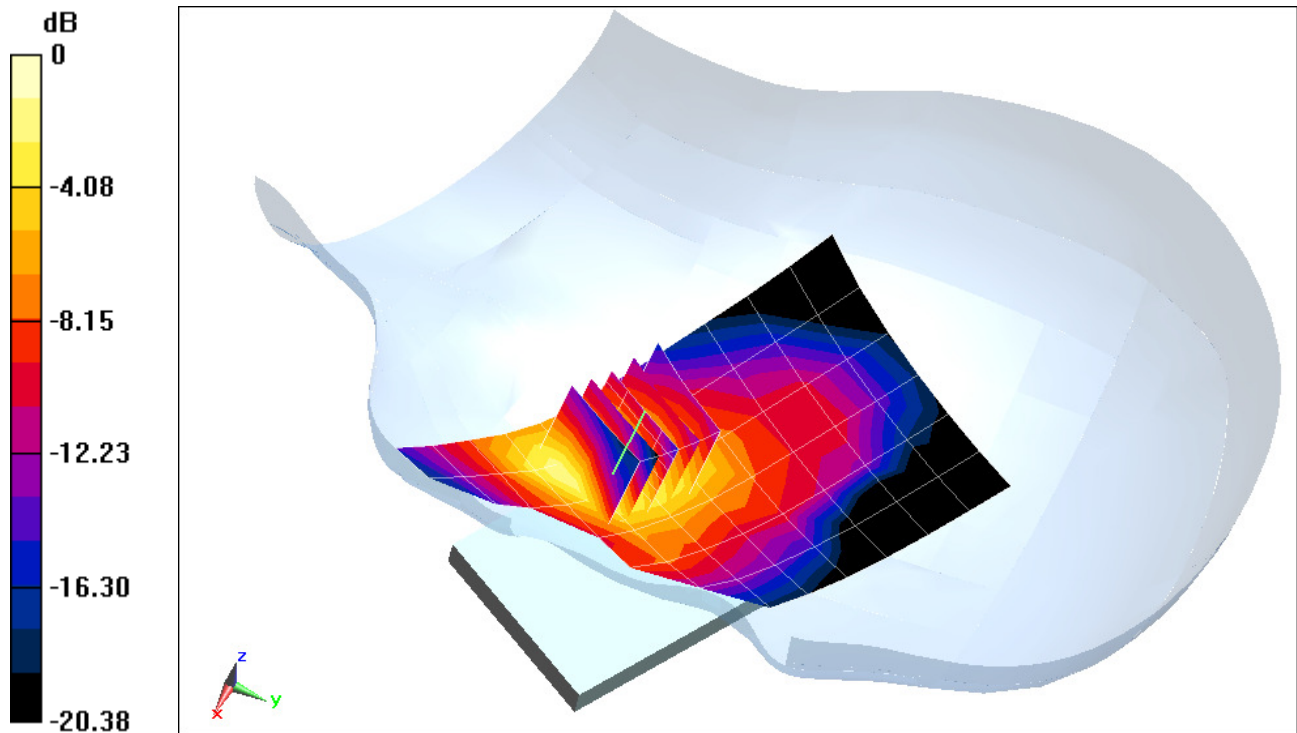

0 dB = 0.521 W/kg = -2.83 dBW/kg

PCTEST ENGINEERING LABORATORY, INC.

DUT: A3LSPHL520; Type: Portable Handset; Serial: 0518058e

Communication System: LTE TDD41; Frequency: 2636.5 MHz; Duty Cycle: 1:1.58

Medium: 2450 Head Medium parameters used (interpolated):

$f = 2636.5 \text{ MHz}$; $\sigma = 2.063 \text{ S/m}$; $\epsilon_r = 37.737$; $\rho = 1000 \text{ kg/m}^3$

Phantom section: Left Section

Test Date: 07-18-2013; Ambient Temp: 23.0°C; Tissue Temp: 23.5°C

Probe: ES3DV2 - SN3022; ConvF(4.1, 4.1, 4.1); Calibrated: 8/28/2012;

Sensor-Surface: 3mm (Mechanical Surface Detection)

Electronics: DAE4 Sn1322; Calibrated: 8/24/2012

Phantom: SAM Sub; Type: SAM 4.0; Serial: TP-1403

Measurement SW: DASY4, Version 4.7 (80); SEMCAD X Version 14.6.10 (7164)

Mode: LTE TDD41, Left Head, Cheek, Mid-High.ch
20 MHz Bandwidth, QPSK, 1 RB, 0 RB Offset

Area Scan (9x15x1): Measurement grid: dx=12mm, dy=12mm

Zoom Scan (7x7x7)/Cube 0: Measurement grid: dx=5mm, dy=5mm, dz=5mm

Reference Value = 20.689 V/m; Power Drift = -0.01 dB

Peak SAR (extrapolated) = 1.23 W/kg

SAR(1 g) = 0.623 W/kg

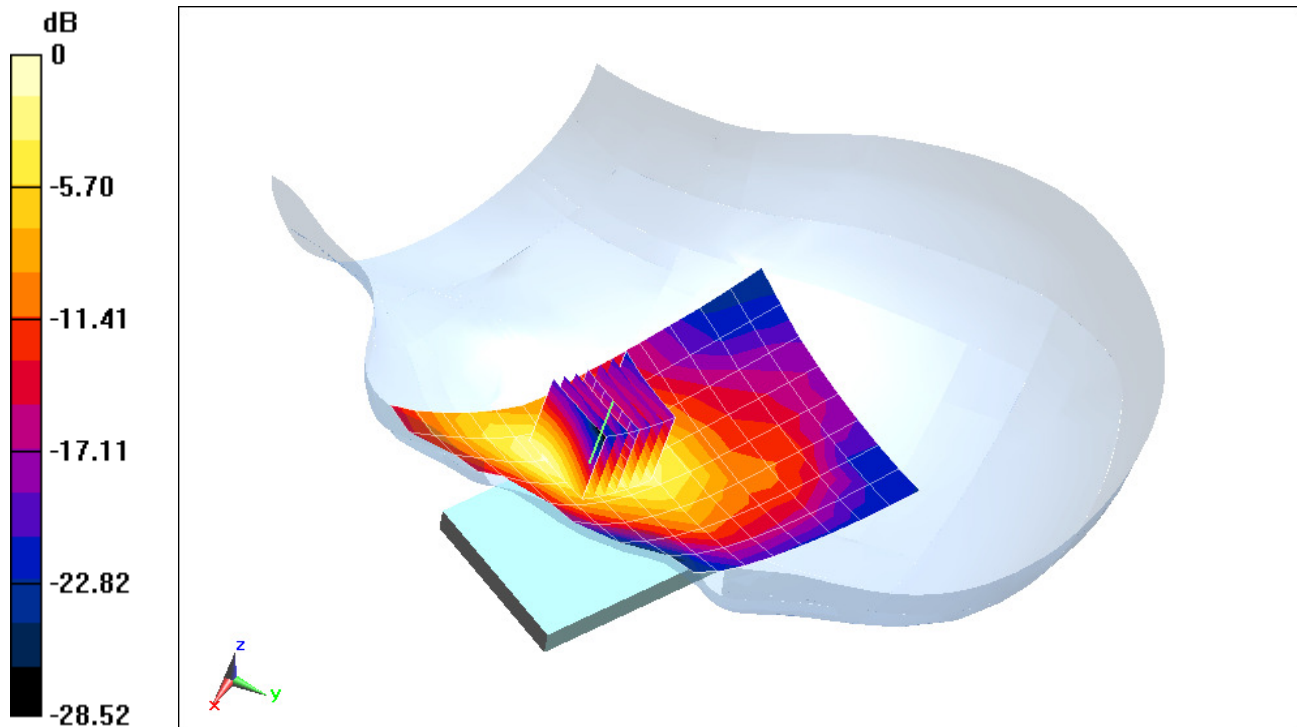

0 dB = 0.792 W/kg = -1.01 dBW/kg

PCTEST ENGINEERING LABORATORY, INC.

DUT: A3LSPHL520; Type: Portable Handset; Serial: 051804e0

Communication System: IEEE 802.11b; Frequency: 2437 MHz; Duty Cycle: 1:1

Medium: 2450 Head Medium parameters used (interpolated):

$f = 2437 \text{ MHz}$; $\sigma = 1.861 \text{ S/m}$; $\epsilon_r = 39.948$; $\rho = 1000 \text{ kg/m}^3$

Phantom section: Left Section

Test Date: 07-01-2013; Ambient Temp: 24.0°C; Tissue Temp: 23.0°C

Probe: ES3DV2 - SN3022; ConvF(4.23, 4.23, 4.23); Calibrated: 8/28/2012;

Sensor-Surface: 3mm (Mechanical Surface Detection)

Electronics: DAE4 Sn1322; Calibrated: 8/24/2012

Phantom: SAM Main; Type: SAM 4.0; Serial: TP-1406

Measurement SW: DASY4, Version 4.7 (80); SEMCAD X Version 14.6.10 (7164)

Mode: IEEE 802.11b, Left Head, Cheek, Ch 06, 1 Mbps

Area Scan (8x15x1): Measurement grid: dx=12mm, dy=12mm

Zoom Scan (7x7x7)/Cube 0: Measurement grid: dx=5mm, dy=5mm, dz=5mm

Reference Value = 7.445 V/m; Power Drift = 0.07 dB

Peak SAR (extrapolated) = 0.213 W/kg

SAR(1 g) = 0.090 W/kg

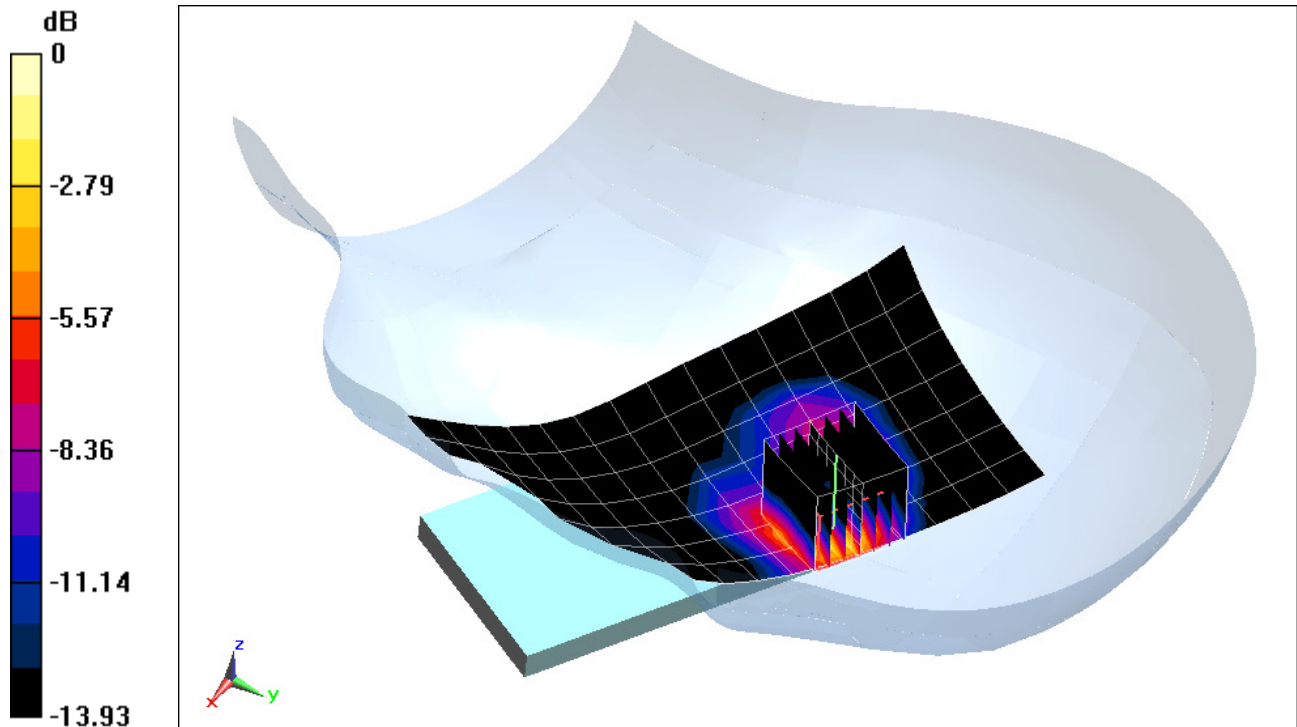

0 dB = 0.124 W/kg = -9.07 dBW/kg

PCTEST ENGINEERING LABORATORY, INC.

DUT: A3LSPHL520; Type: Portable Handset; Serial: 051805a8

Communication System: IEEE 802.11a; Frequency: 5745 MHz; Duty Cycle: 1:1

Medium: 5 GHz Head Medium parameters used:

$f = 5745 \text{ MHz}$; $\sigma = 5.019 \text{ S/m}$; $\epsilon_r = 34.293$; $\rho = 1000 \text{ kg/m}^3$

Phantom section: Left Section

Test Date: 07-08-2013; Ambient Temp: 24.5°C; Tissue Temp: 23.2°C

Probe: EX3DV4 - SN3920; ConvF(4.02, 4.02, 4.02); Calibrated: 2/27/2013;

Sensor-Surface: 1.4mm (Mechanical Surface Detection)

Electronics: DAE4 Sn649; Calibrated: 2/6/2013

Phantom: SAM 5.0 front; Type: QD000P40CD; Serial: TP:-1648

Measurement SW: DASY52, Version 52.8 (7); SEMCAD X Version 14.6.10 (7164)

Mode: IEEE 802.11a, 5.8 GHz, Left Head, Cheek, Ch 149, 6 Mbps

Area Scan (11x16x1): Measurement grid: dx=10mm, dy=10mm

Zoom Scan (7x7x7)/Cube 0: Measurement grid: dx=4mm, dy=4mm, dz=1.4mm; Graded Ratio: 1.4

Reference Value = 3.599 V/m; Power Drift = 0.14 dB

Peak SAR (extrapolated) = 0.244 W/kg

SAR(1 g) = 0.067 W/kg

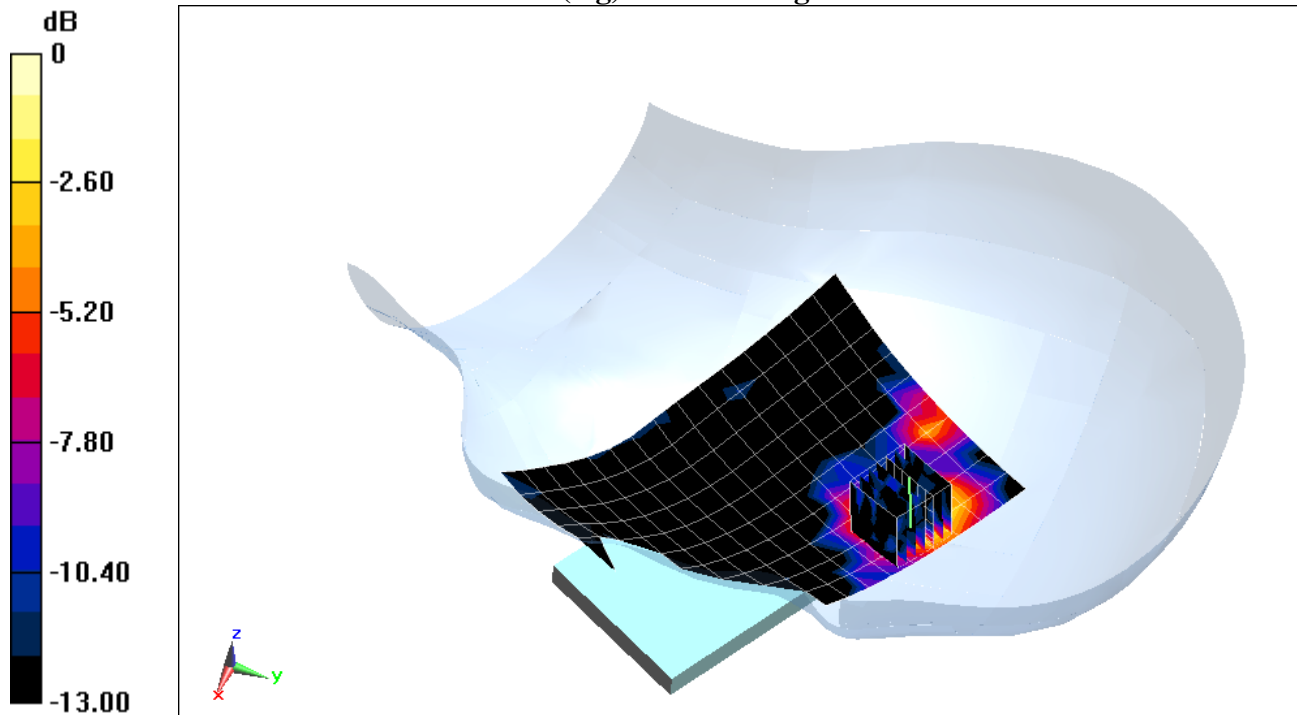

0 dB = 0.150 W/kg = -8.24 dBW/kg

PCTEST ENGINEERING LABORATORY, INC.

DUT: A3LSPHL520; Type: Portable Handset; Serial: 051805a8

Communication System: IEEE 802.11a; Frequency: 5260 MHz; Duty Cycle: 1:1

Medium: 5 GHz Head Medium parameters used:

$f = 5260 \text{ MHz}$; $\sigma = 4.525 \text{ S/m}$; $\epsilon_r = 34.989$; $\rho = 1000 \text{ kg/m}^3$

Phantom section: Left Section

Test Date: 07-08-2013; Ambient Temp: 24.5°C; Tissue Temp: 23.1°C

Probe: EX3DV4 - SN3920; ConvF(4.73, 4.73, 4.73); Calibrated: 2/27/2013;

Sensor-Surface: 1.4mm (Mechanical Surface Detection)

Electronics: DAE4 Sn649; Calibrated: 2/6/2013

Phantom: SAM 5.0 front; Type: QD000P40CD; Serial: TP:-1648

Measurement SW: DASY52, Version 52.8 (7); SEMCAD X Version 14.6.10 (7164)

Mode: IEEE 802.11a, 5.3 GHz, Left Head, Cheek, Ch 52, 6 Mbps

Area Scan (11x16x1): Measurement grid: dx=10mm, dy=10mm

Zoom Scan (7x7x7)/Cube 0: Measurement grid: dx=4mm, dy=4mm, dz=1.4mm; Graded Ratio: 1.4

Reference Value = 5.324 V/m; Power Drift = 0.21 dB

Peak SAR (extrapolated) = 0.475 W/kg

SAR(1 g) = 0.114 W/kg

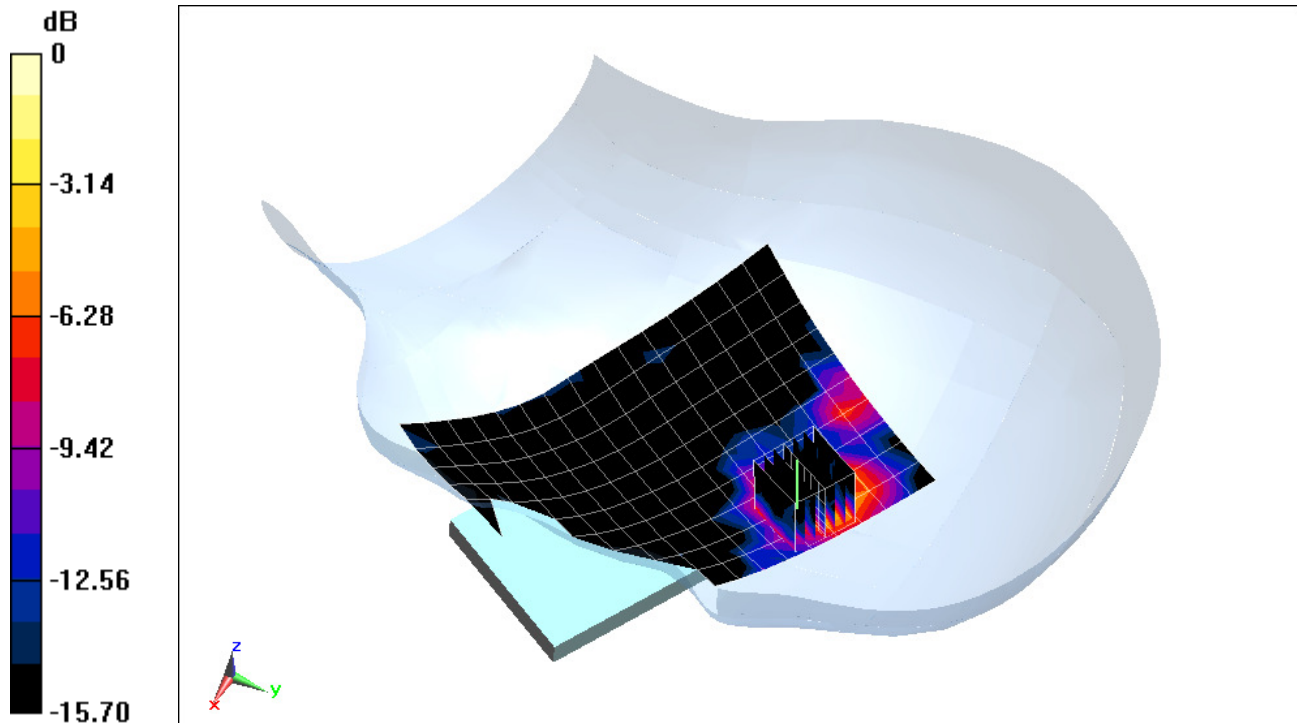

0 dB = 0.274 W/kg = -5.62 dBW/kg

PCTEST ENGINEERING LABORATORY, INC.

DUT: A3LSPHL520; Type: Portable Handset; Serial: 051805a8

Communication System: CDMA; Frequency: 820.1 MHz; Duty Cycle: 1:1

Medium: 835 Body Medium parameters used (interpolated):

$f = 820.1 \text{ MHz}$; $\sigma = 0.996 \text{ S/m}$; $\epsilon_r = 55.967$; $\rho = 1000 \text{ kg/m}^3$

Phantom section: Flat Section; Space: 1.0 cm

Test Date: 07-08-2013; Ambient Temp: 24.5°C; Tissue Temp: 23.5°C

Probe: ES3DV3 - SN3209; ConvF(6.28, 6.28, 6.28); Calibrated: 3/15/2013;

Sensor-Surface: 4mm (Mechanical Surface Detection)

Electronics: DAE4 Sn1334; Calibrated: 3/8/2013

Phantom: ELI v5.0; Type: QDOVA002AA; Serial: TP-1158

Measurement SW: DASY52, Version 52.8 (7); SEMCAD X Version 14.6.10 (7164)

Mode: BC10 TDSO32, Body SAR, Back side, Mid.ch

Area Scan (7x12x1): Measurement grid: dx=15mm, dy=15mm

Zoom Scan (5x5x7)/Cube 0: Measurement grid: dx=8mm, dy=8mm, dz=5mm

Reference Value = 33.117 V/m; Power Drift = 0.00 dB

Peak SAR (extrapolated) = 1.29 W/kg

SAR(1 g) = 1.03 W/kg

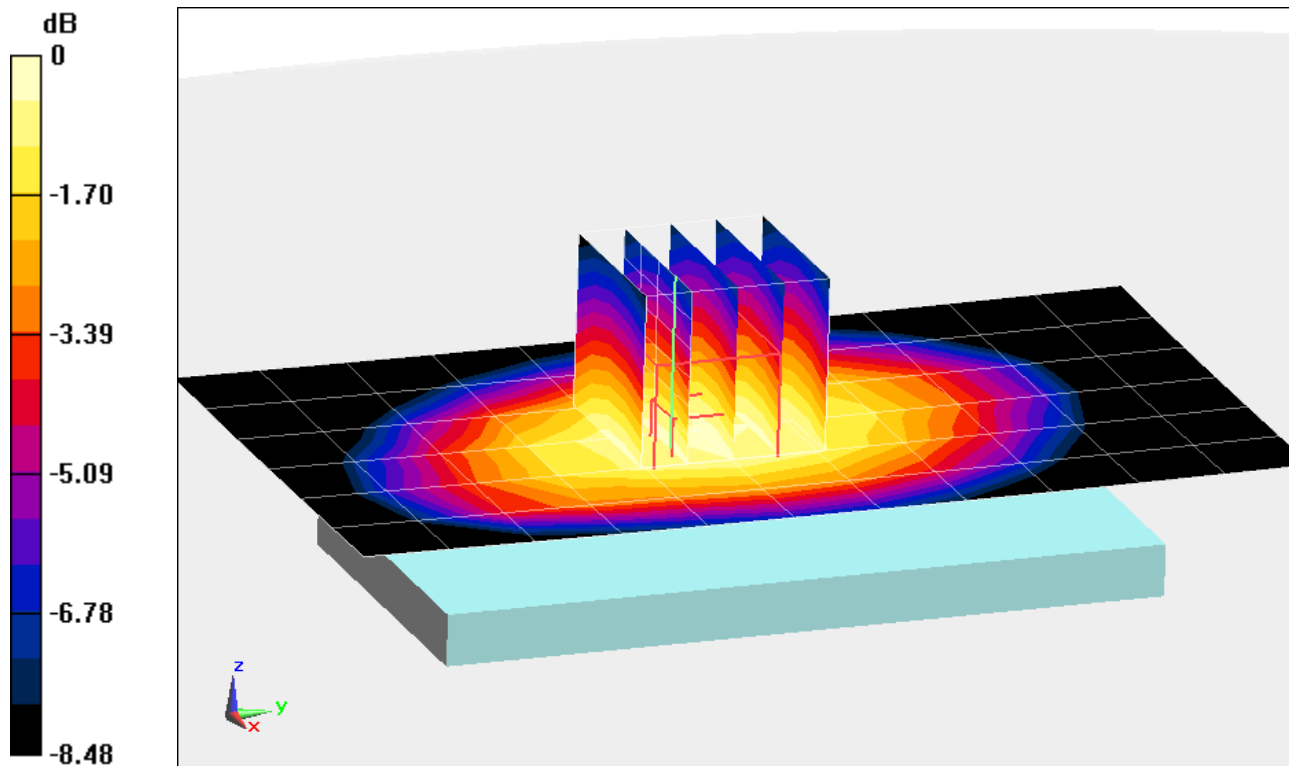

0 dB = 1.08 W/kg = 0.33 dBW/kg

PCTEST ENGINEERING LABORATORY, INC.

DUT: A3LSPHL520; Type: Portable Handset; Serial: 051805a8

Communication System: CDMA; Frequency: 820.1 MHz; Duty Cycle: 1:1

Medium: 835 Body Medium parameters used (interpolated):

$f = 820.1 \text{ MHz}$; $\sigma = 0.996 \text{ S/m}$; $\epsilon_r = 55.967$; $\rho = 1000 \text{ kg/m}^3$

Phantom section: Flat Section; Space: 1.0 cm

Test Date: 07-08-2013; Ambient Temp: 24.5°C; Tissue Temp: 23.5°C

Probe: ES3DV3 - SN3209; ConvF(6.28, 6.28, 6.28); Calibrated: 3/15/2013;

Sensor-Surface: 4mm (Mechanical Surface Detection)

Electronics: DAE4 Sn1334; Calibrated: 3/8/2013

Phantom: ELI v5.0; Type: QDOVA002AA; Serial: TP-1158

Measurement SW: DASY52, Version 52.8 (7); SEMCAD X Version 14.6.10 (7164)

Mode: BC10 EVDO, Body SAR, Back side, Mid.ch

Area Scan (7x12x1): Measurement grid: dx=15mm, dy=15mm

Zoom Scan (5x5x7)/Cube 0: Measurement grid: dx=8mm, dy=8mm, dz=5mm

Reference Value = 33.102 V/m; Power Drift = 0.03 dB

Peak SAR (extrapolated) = 1.29 W/kg

SAR(1 g) = 1.03 W/kg

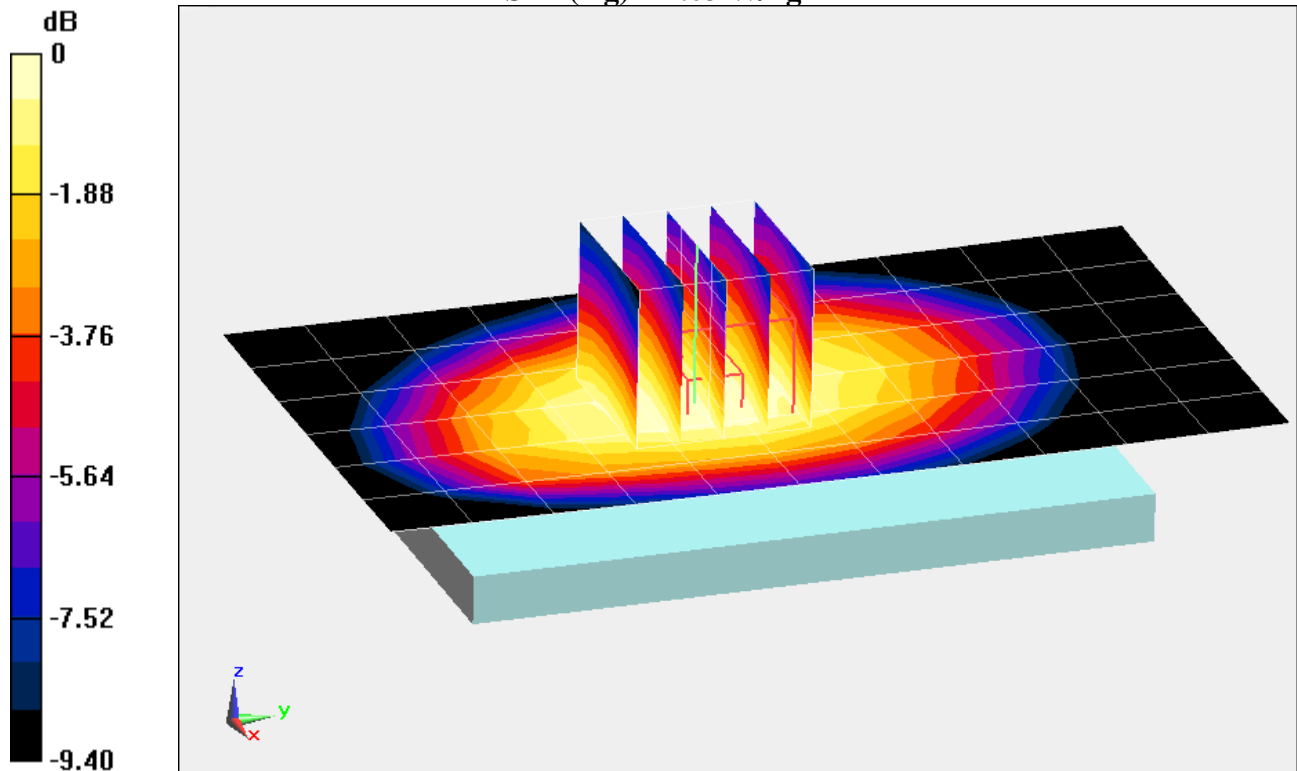

0 dB = 1.08 W/kg = 0.33 dBW/kg

PCTEST ENGINEERING LABORATORY, INC.

DUT: A3LSPHL520; Type: Portable Handset; Serial: 051805a8

Communication System: CDMA; Frequency: 836.52 MHz; Duty Cycle: 1:1

Medium: 835 Body Medium parameters used (interpolated):

$f = 836.52$ MHz; $\sigma = 1.013$ S/m; $\epsilon_r = 55.785$; $\rho = 1000$ kg/m³

Phantom section: Flat Section; Space: 1.0 cm

Test Date: 07-08-2013; Ambient Temp: 24.5°C; Tissue Temp: 23.5°C

Probe: ES3DV3 - SN3209; ConvF(6.28, 6.28, 6.28); Calibrated: 3/15/2013;

Sensor-Surface: 4mm (Mechanical Surface Detection)

Electronics: DAE4 Sn1334; Calibrated: 3/8/2013

Phantom: ELI v5.0; Type: QDOVA002AA; Serial: TP-1158

Measurement SW: DASY52, Version 52.8 (7); SEMCAD X Version 14.6.10 (7164)

Mode: BC0 TDSO32, Body SAR, Back side, Mid.ch

Area Scan (7x12x1): Measurement grid: dx=15mm, dy=15mm

Zoom Scan (5x5x7)/Cube 0: Measurement grid: dx=8mm, dy=8mm, dz=5mm

Reference Value = 31.690 V/m; Power Drift = -0.02 dB

Peak SAR (extrapolated) = 1.18 W/kg

SAR(1 g) = 0.947 W/kg

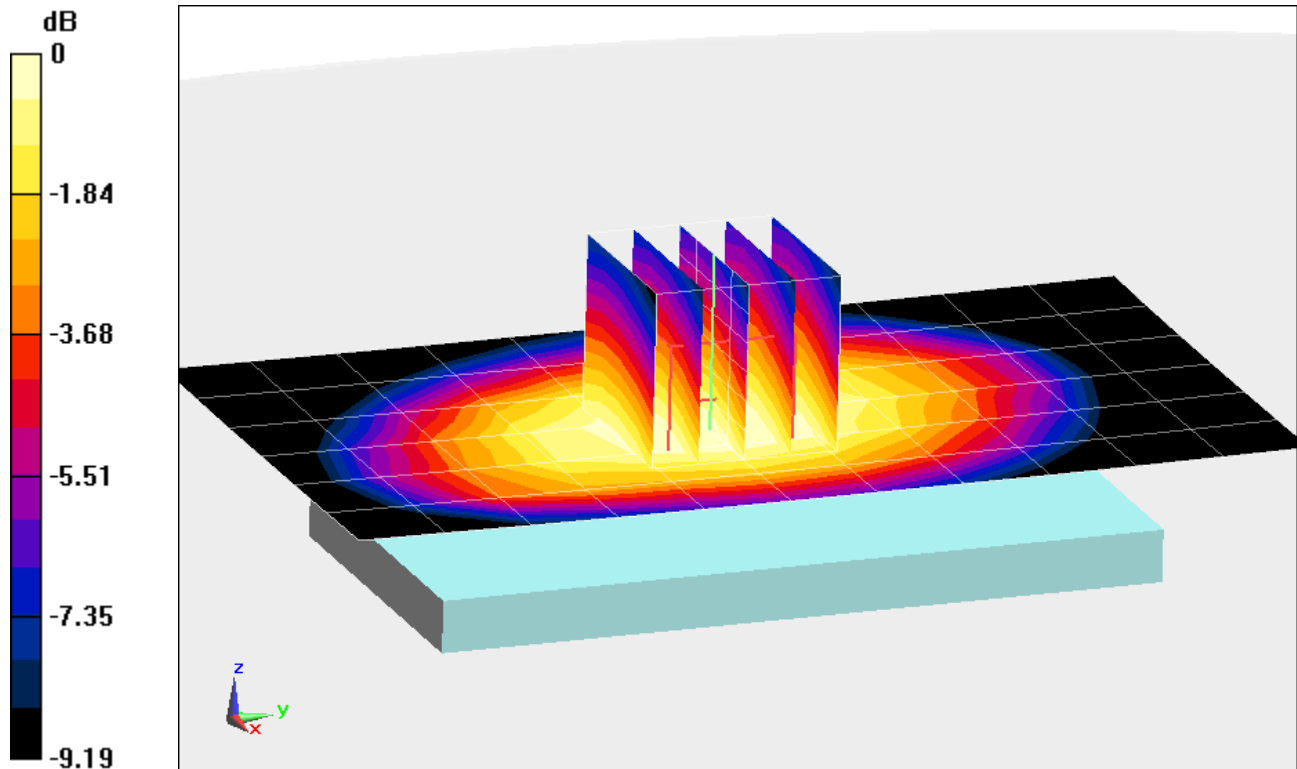

0 dB = 0.988 W/kg = -0.05 dBW/kg

PCTEST ENGINEERING LABORATORY, INC.

DUT: A3LSPHL520; Type: Portable Handset; Serial: 051805a8

Communication System: CDMA; Frequency: 836.52 MHz; Duty Cycle: 1:1

Medium: 835 Body Medium parameters used (interpolated):

$f = 836.52 \text{ MHz}$; $\sigma = 1.013 \text{ S/m}$; $\epsilon_r = 55.785$; $\rho = 1000 \text{ kg/m}^3$

Phantom section: Flat Section; Space: 1.0 cm

Test Date: 07-08-2013; Ambient Temp: 24.5°C; Tissue Temp: 23.5°C

Probe: ES3DV3 - SN3209; ConvF(6.28, 6.28, 6.28); Calibrated: 3/15/2013;

Sensor-Surface: 4mm (Mechanical Surface Detection)

Electronics: DAE4 Sn1334; Calibrated: 3/8/2013

Phantom: ELI v5.0; Type: QDOVA002AA; Serial: TP-1158

Measurement SW: DASY52, Version 52.8 (7); SEMCAD X Version 14.6.10 (7164)

Mode: BC0 EVDO, Body SAR, Back side, Mid.ch

Area Scan (7x12x1): Measurement grid: dx=15mm, dy=15mm

Zoom Scan (5x5x7)/Cube 0: Measurement grid: dx=8mm, dy=8mm, dz=5mm

Reference Value = 31.348 V/m; Power Drift = -0.03 dB

Peak SAR (extrapolated) = 1.16 W/kg

SAR(1 g) = 0.934 W/kg

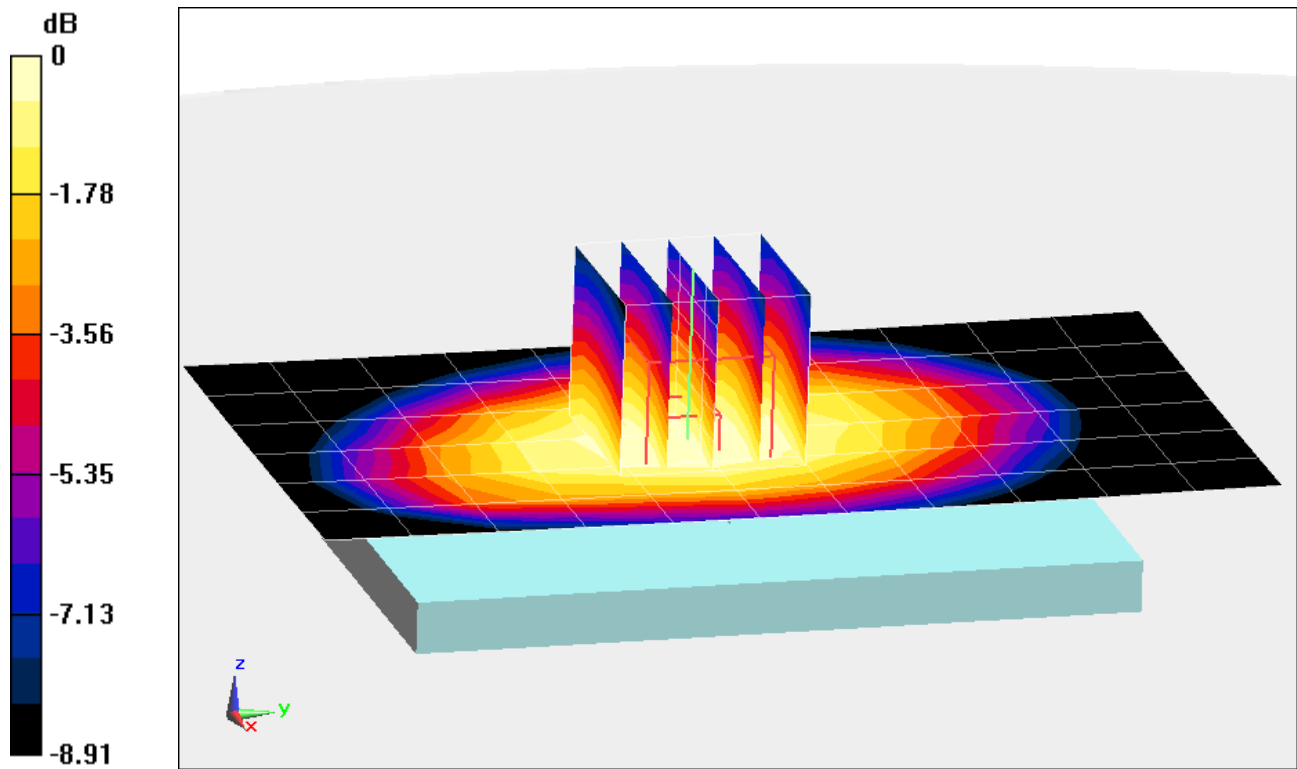

0 dB = 0.979 W/kg = -0.09 dBW/kg

PCTEST ENGINEERING LABORATORY, INC.

DUT: A3LSPHL520; Type: Portable Handset; Serial: 051804e0

Communication System: PCS CDMA; Frequency: 1880 MHz; Duty Cycle: 1:1

Medium: 1900 Body Medium parameters used:

$f = 1880 \text{ MHz}$; $\sigma = 1.497 \text{ S/m}$; $\epsilon_r = 51.92$; $\rho = 1000 \text{ kg/m}^3$

Phantom section: Flat Section; Space: 1.0 cm

Test Date: 07-01-2013; Ambient Temp: 23.5°C; Tissue Temp: 23.7°C

Probe: ES3DV2 - SN3022; ConvF(4.43, 4.43, 4.43); Calibrated: 8/28/2012;

Sensor-Surface: 4mm (Mechanical Surface Detection)

Electronics: DAE4 Sn1322; Calibrated: 8/24/2012

Phantom: SAM Sub; Type: SAM 4.0; Serial: TP-1403

Measurement SW: DASY4, Version 4.7 (80); SEMCAD X Version 14.6.10 (7164)

Mode: PCS TDSO32, Body SAR, Back side, Mid.ch

Area Scan (7x12x1): Measurement grid: dx=15mm, dy=15mm

Zoom Scan (5x5x7)/Cube 0: Measurement grid: dx=8mm, dy=8mm, dz=5mm

Reference Value = 28.362 V/m; Power Drift = 0.12 dB

Peak SAR (extrapolated) = 1.71 W/kg

SAR(1 g) = 1.01 W/kg

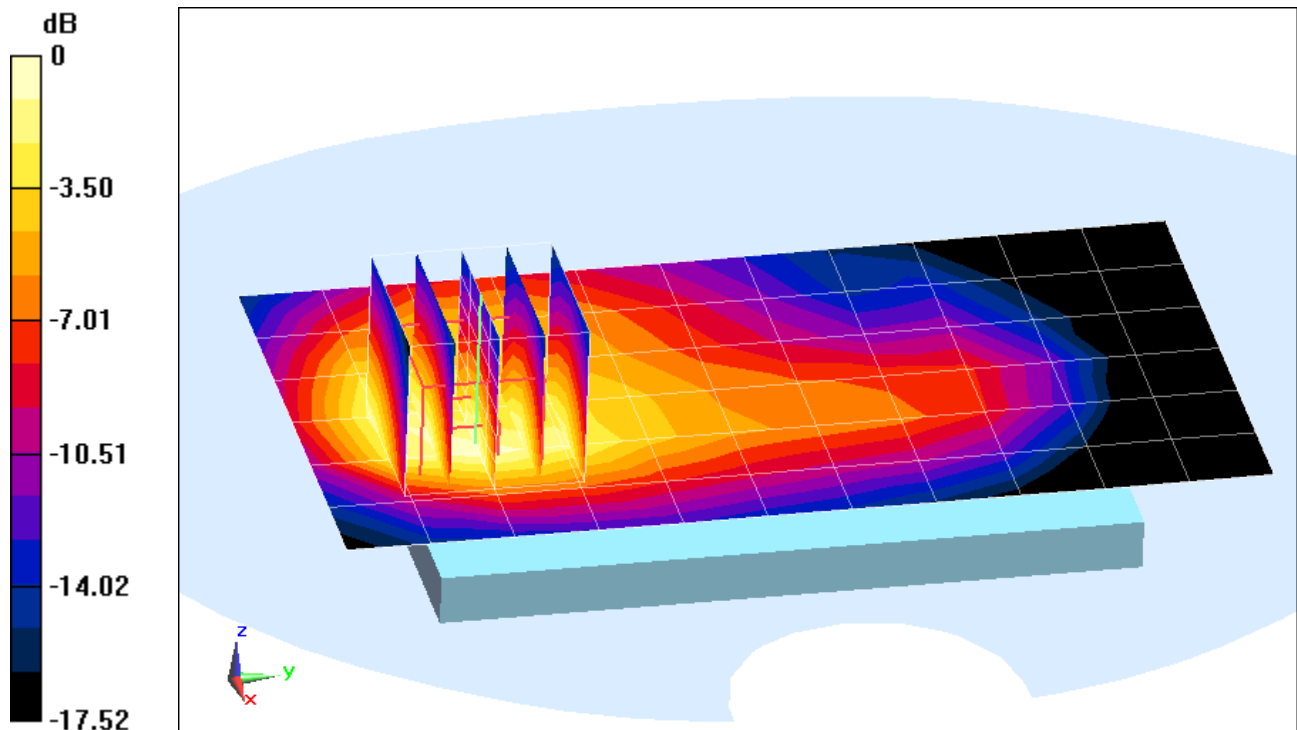

0 dB = 1.13 W/kg = 0.53 dBW/kg

PCTEST ENGINEERING LABORATORY, INC.

DUT: A3LSPHL520; Type: Portable Handset; Serial: 051804e0

Communication System: PCS CDMA; Frequency: 1908.75 MHz; Duty Cycle: 1:1

Medium: 1900 Body Medium parameters used (interpolated):

$f = 1908.75 \text{ MHz}$; $\sigma = 1.537 \text{ S/m}$; $\epsilon_r = 51.769$; $\rho = 1000 \text{ kg/m}^3$

Phantom section: Flat Section; Space: 1.0 cm

Test Date: 07-01-2013; Ambient Temp: 23.5°C; Tissue Temp: 23.7°C

Probe: ES3DV2 - SN3022; ConvF(4.43, 4.43, 4.43); Calibrated: 8/28/2012;

Sensor-Surface: 4mm (Mechanical Surface Detection)

Electronics: DAE4 Sn1322; Calibrated: 8/24/2012

Phantom: SAM Sub; Type: SAM 4.0; Serial: TP-1403

Measurement SW: DASY4, Version 4.7 (80); SEMCAD X Version 14.6.10 (7164)

Mode: PCS EVDO, Body SAR, Back side, High.ch

Area Scan (7x12x1): Measurement grid: dx=15mm, dy=15mm

Zoom Scan (5x5x7)/Cube 0: Measurement grid: dx=8mm, dy=8mm, dz=5mm

Reference Value = 26.721 V/m; Power Drift = -0.06 dB

Peak SAR (extrapolated) = 1.48 W/kg

SAR(1 g) = 0.898 W/kg

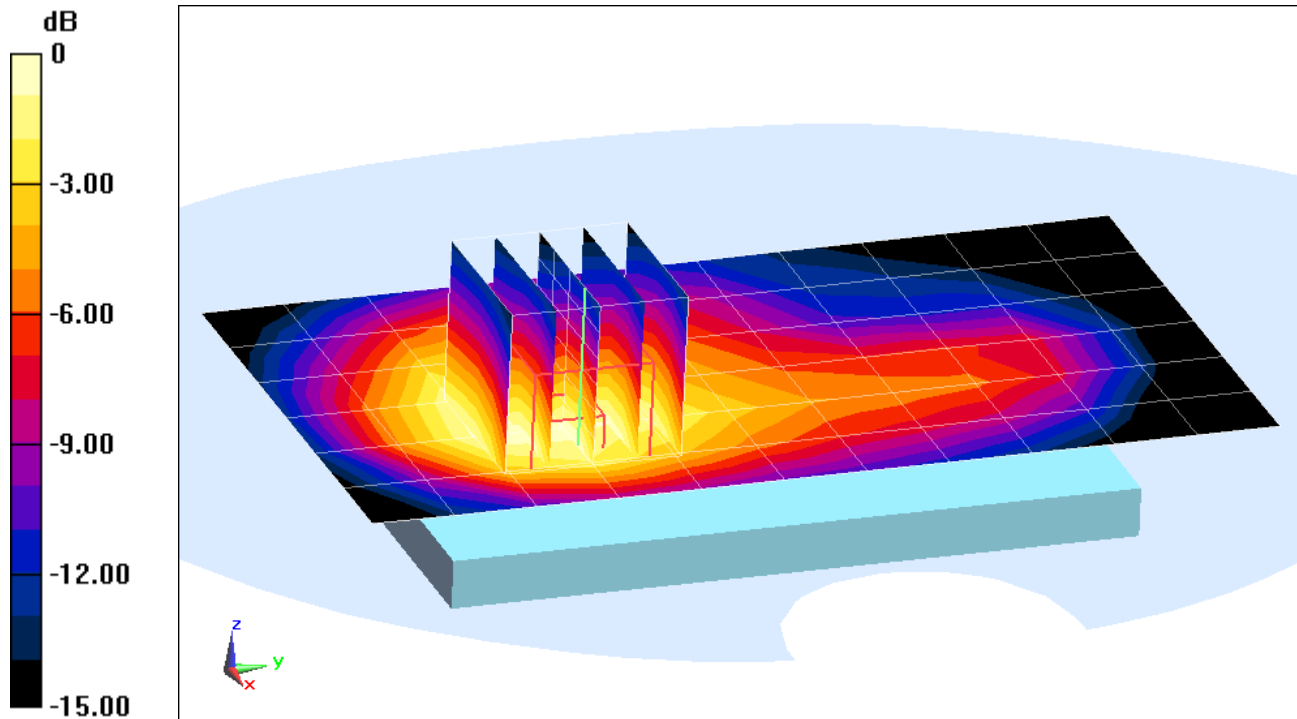

0 dB = 0.946 W/kg = -0.24 dBW/kg

PCTEST ENGINEERING LABORATORY, INC.

DUT: A3LSPHL520; Type: Portable Handset; Serial: 05180482

Communication System: LTE BAND 26; Frequency: 819 MHz; Duty Cycle: 1:1

Medium: 835 Body Medium parameters used (interpolated):

$f = 819 \text{ MHz}$; $\sigma = 0.948 \text{ S/m}$; $\epsilon_r = 57.158$; $\rho = 1000 \text{ kg/m}^3$

Phantom section: Flat Section; Space: 1.0 cm

Test Date: 07-02-2013; Ambient Temp: 23.5°C; Tissue Temp: 22.2°C

Probe: ES3DV3 - SN3287; ConvF(6.06, 6.06, 6.06); Calibrated: 11/15/2012;

Sensor-Surface: 4mm (Mechanical Surface Detection)

Electronics: DAE4 Sn1333; Calibrated: 11/13/2012

Phantom: SAM with CRP; Type: SAM 4.0; Serial: TP1375

Measurement SW: DASY4, Version 4.7 (80); SEMCAD X Version 14.6.10 (7164)

Mode: LTE Band 26, Body SAR, Back side, Low.ch
10 MHz Bandwidth, QPSK, 1 RB, 49 RB Offset

Area Scan (8x10x1): Measurement grid: dx=15mm, dy=15mm

Zoom Scan (5x5x7)/Cube 0: Measurement grid: dx=8mm, dy=8mm, dz=5mm

Reference Value = 22.980 V/m; Power Drift = -0.01 dB

Peak SAR (extrapolated) = 0.585 W/kg

SAR(1 g) = 0.478 W/kg

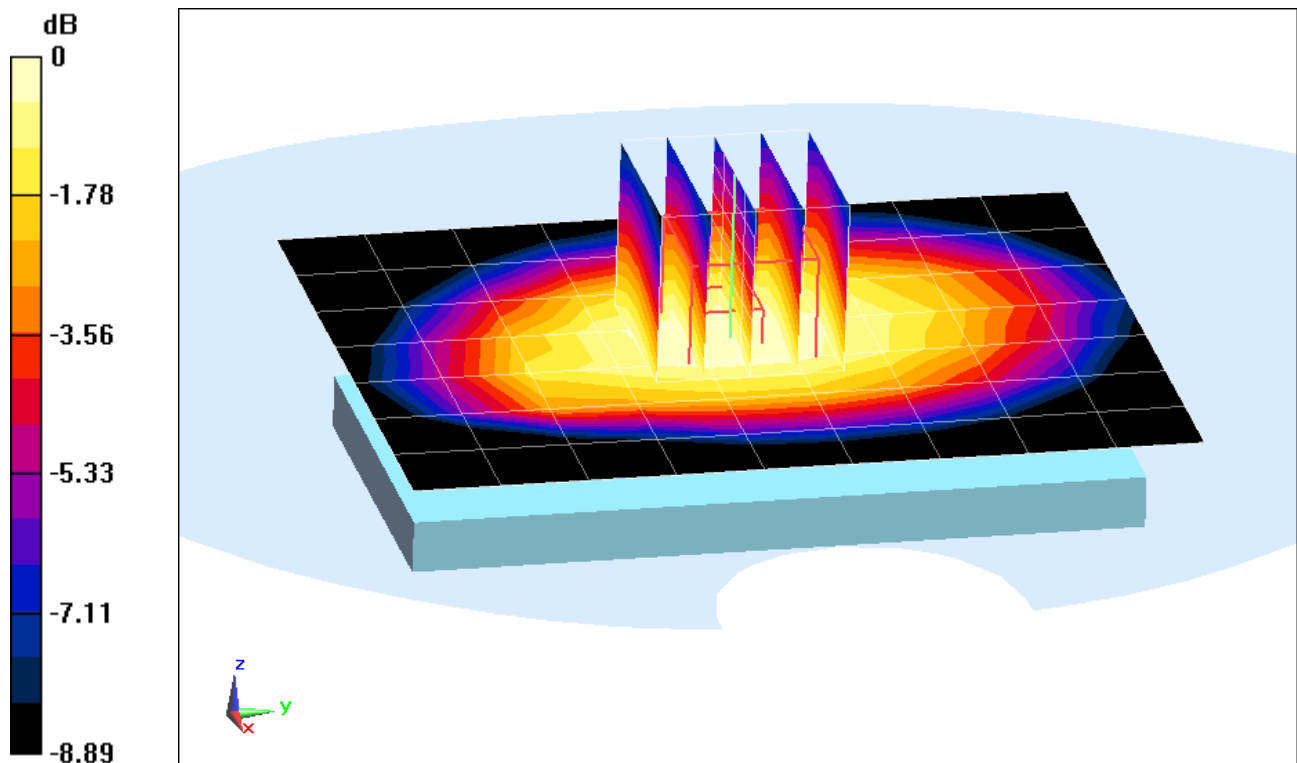

0 dB = 0.499 W/kg = -3.02 dBW/kg

PCTEST ENGINEERING LABORATORY, INC.

DUT: A3LSPHL520; Type: Portable Handset; Serial: 05180482

Communication System: LTE BAND 26; Frequency: 819 MHz; Duty Cycle: 1:1

Medium: 835 Body Medium parameters used (interpolated):

$f = 819 \text{ MHz}$; $\sigma = 0.948 \text{ S/m}$; $\epsilon_r = 57.158$; $\rho = 1000 \text{ kg/m}^3$

Phantom section: Flat Section; Space: 1.0 cm

Test Date: 07-02-2013; Ambient Temp: 23.5°C; Tissue Temp: 22.2°C

Probe: ES3DV3 - SN3287; ConvF(6.06, 6.06, 6.06); Calibrated: 11/15/2012;

Sensor-Surface: 4mm (Mechanical Surface Detection)

Electronics: DAE4 Sn1333; Calibrated: 11/13/2012

Phantom: SAM with CRP; Type: SAM 4.0; Serial: TP1375

Measurement SW: DASY4, Version 4.7 (80); SEMCAD X Version 14.6.10 (7164)

Mode: LTE Band 26, Body SAR, Left Edge, Low.ch
10 MHz Bandwidth, QPSK, 1 RB, 49 RB Offset

Area Scan (11x13x1): Measurement grid: dx=5mm, dy=15mm

Zoom Scan (5x5x7)/Cube 0: Measurement grid: dx=8mm, dy=8mm, dz=5mm

Reference Value = 25.895 V/m; Power Drift = -0.07 dB

Peak SAR (extrapolated) = 0.800 W/kg

SAR(1 g) = 0.581 W/kg

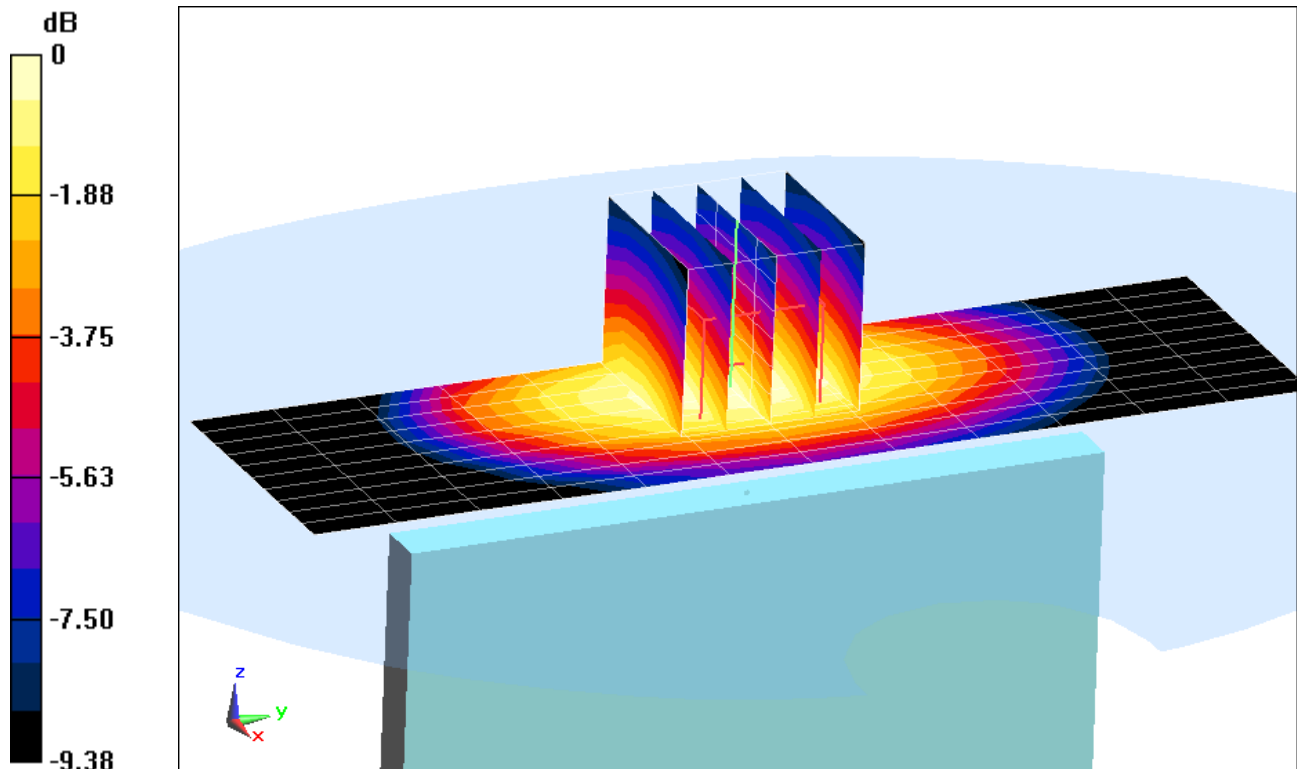

0 dB = 0.619 W/kg = -2.08 dBW/kg

PCTEST ENGINEERING LABORATORY, INC.

DUT: A3LSPHL520; Type: Portable Handset; Serial: 051805af

Communication System: LTE BAND 25; Frequency: 1855 MHz; Duty Cycle: 1:1

Medium: 1900 Body Medium parameters used (interpolated):

$f = 1855 \text{ MHz}$; $\sigma = 1.487 \text{ S/m}$; $\epsilon_r = 54.194$; $\rho = 1000 \text{ kg/m}^3$

Phantom section: Flat Section; Space: 1.0 cm

Test Date: 07-08-2013; Ambient Temp: 23.2°C; Tissue Temp: 22.8°C

Probe: ES3DV3 - SN3287; ConvF(4.69, 4.69, 4.69); Calibrated: 11/15/2012;

Sensor-Surface: 4mm (Mechanical Surface Detection)

Electronics: DAE4 Sn1333; Calibrated: 11/13/2012

Phantom: SAM Sub Dasy B; Type: SAM 5.0; Serial: TP-1626

Measurement SW: DASY4, Version 4.7 (80); SEMCAD X Version 14.6.10 (7164)

Mode: LTE Band 25 (PCS), Body SAR, Back side, Low.ch
10 MHz Bandwidth, QPSK, 1 RB, 0 RB Offset

Area Scan (7x12x1): Measurement grid: dx=15mm, dy=15mm

Zoom Scan (5x5x7)/Cube 0: Measurement grid: dx=8mm, dy=8mm, dz=5mm

Reference Value = 15.526 V/m; Power Drift = -0.01 dB

Peak SAR (extrapolated) = 0.684 W/kg

SAR(1 g) = 0.384 W/kg

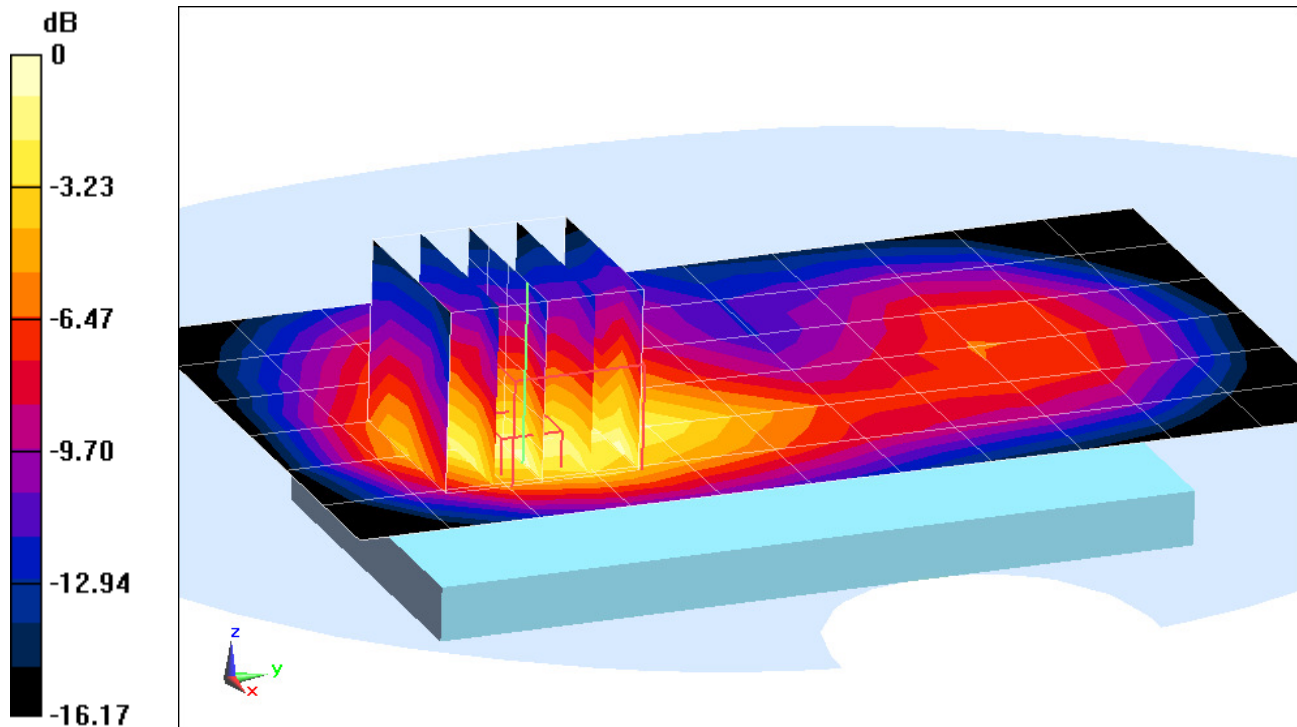

0 dB = 0.459 W/kg = -3.38 dBW/kg

PCTEST ENGINEERING LABORATORY, INC.

DUT: A3LSPHL520; Type: Portable Handset; Serial: 051805af

Communication System: LTE BAND 25; Frequency: 1855 MHz; Duty Cycle: 1:1

Medium: 1900 Body Medium parameters used (interpolated):

$f = 1855 \text{ MHz}$; $\sigma = 1.487 \text{ S/m}$; $\epsilon_r = 54.194$; $\rho = 1000 \text{ kg/m}^3$

Phantom section: Flat Section; Space: 1.0 cm

Test Date: 07-08-2013; Ambient Temp: 23.2°C; Tissue Temp: 22.8°C

Probe: ES3DV3 - SN3287; ConvF(4.69, 4.69, 4.69); Calibrated: 11/15/2012;

Sensor-Surface: 4mm (Mechanical Surface Detection)

Electronics: DAE4 Sn1333; Calibrated: 11/13/2012

Phantom: SAM Sub Dasy B; Type: SAM 5.0; Serial: TP-1626

Measurement SW: DASY4, Version 4.7 (80); SEMCAD X Version 14.6.10 (7164)

Mode: LTE Band 25 (PCS), Body SAR, Bottom Edge, Low.ch
10 MHz Bandwidth, QPSK, 1 RB, 0 RB Offset

Area Scan (11x7x1): Measurement grid: dx=5mm, dy=15mm

Zoom Scan (5x5x7)/Cube 0: Measurement grid: dx=8mm, dy=8mm, dz=5mm

Reference Value = 17.435 V/m; Power Drift = 0.11 dB

Peak SAR (extrapolated) = 0.666 W/kg

SAR(1 g) = 0.417 W/kg

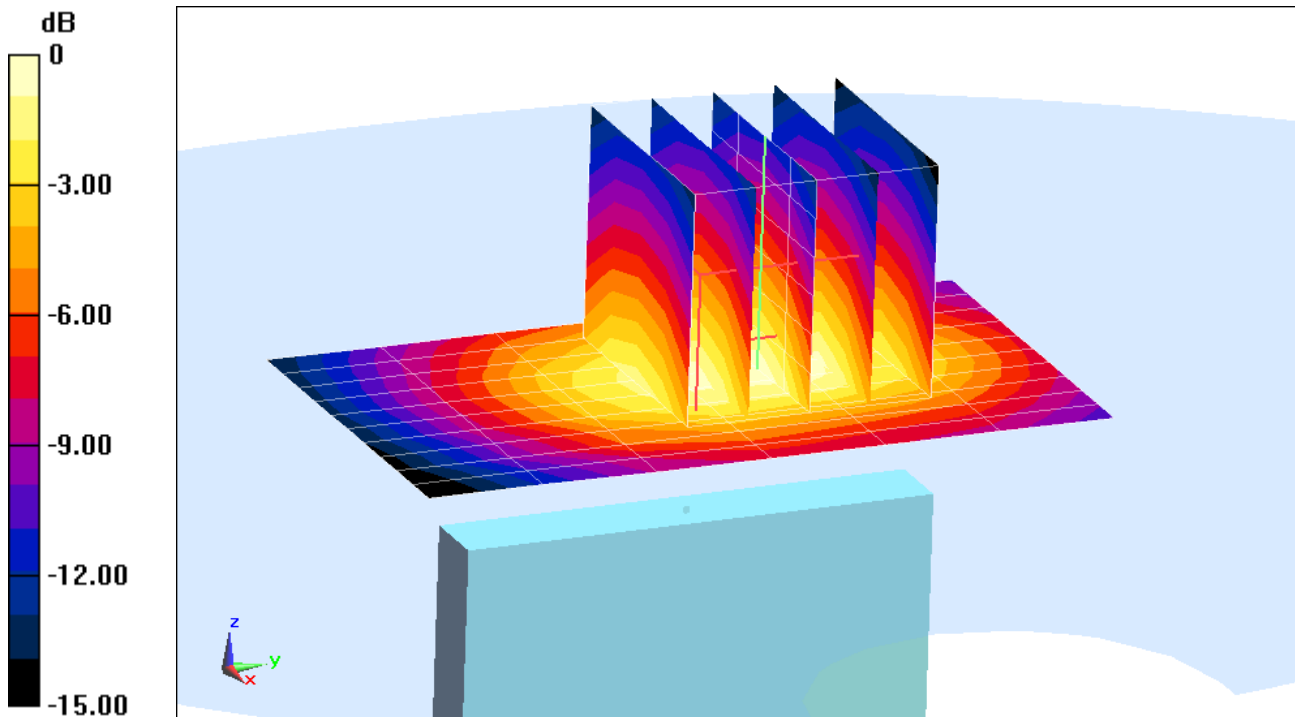

PCTEST ENGINEERING LABORATORY, INC.

DUT: A3LSPHL520; Type: Portable Handset; Serial: 0518058e

Communication System: LTE Band 41; Frequency: 2636.5 MHz; Duty Cycle: 1:1.58

Medium: 2450 Body Medium parameters used (interpolated):

$f = 2636.5 \text{ MHz}$; $\sigma = 2.261 \text{ S/m}$; $\epsilon_r = 50.604$; $\rho = 1000 \text{ kg/m}^3$

Phantom section: Flat Section; Space: 1.0 cm

Test Date: 07-19-2013; Ambient Temp: 24.3°C; Tissue Temp: 23.9°C

Probe: EX3DV4 - SN3920; ConvF(6.73, 6.73, 6.73); Calibrated: 2/27/2013;

Sensor-Surface: 3mm (Mechanical Surface Detection)

Electronics: DAE4 Sn649; Calibrated: 2/6/2013

Phantom: SAM 5.0 front; Type: QD000P40CD; Serial: TP:-1648

Measurement SW: DASY52, Version 52.8 (7); SEMCAD X Version 14.6.10 (7164)

Mode: LTE Band 41, Body SAR, Back side, Mid-High.ch
20 MHz Bandwidth, QPSK, 1 RB, 0 RB Offset

Area Scan (8x14x1): Measurement grid: dx=12mm, dy=12mm

Zoom Scan (7x7x7)/Cube 0: Measurement grid: dx=5mm, dy=5mm, dz=5mm

Reference Value = 22.611 V/m; Power Drift = -0.07 dB

Peak SAR (extrapolated) = 2.03 W/kg

SAR(1 g) = 1.03 W/kg

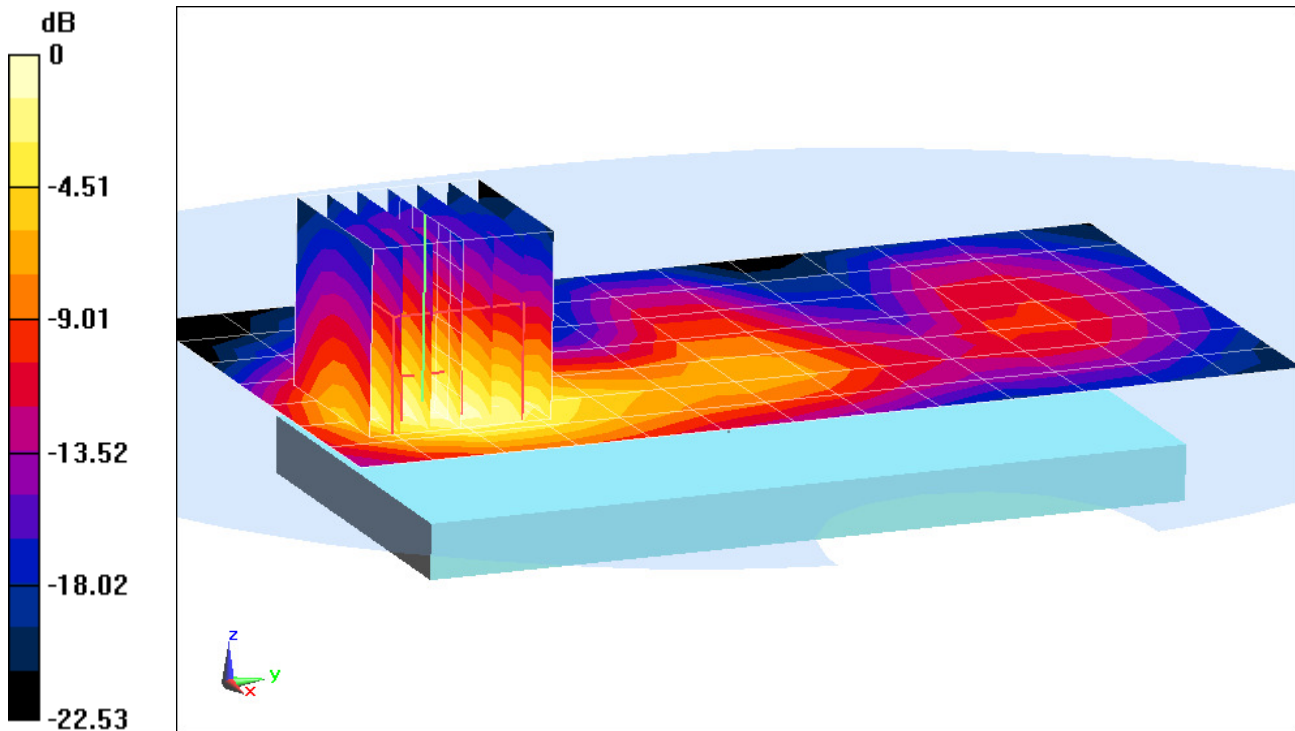

0 dB = 1.31 W/kg = 1.17 dBW/kg

PCTEST ENGINEERING LABORATORY, INC.

DUT: A3LSPHL520; Type: Portable Handset; Serial: 05180482

Communication System: IEEE 802.11b; Frequency: 2437 MHz; Duty Cycle: 1:1

Medium: 2450 Body Medium parameters used (interpolated):

$f = 2437 \text{ MHz}$; $\sigma = 1.995 \text{ S/m}$; $\epsilon_r = 53.24$; $\rho = 1000 \text{ kg/m}^3$

Phantom section: Flat Section; Space: 1.0 cm

Test Date: 07-08-2013; Ambient Temp: 22.8°C; Tissue Temp: 22.2°C

Probe: ES3DV2 - SN3022; ConvF(3.97, 3.97, 3.97); Calibrated: 8/28/2012;

Sensor-Surface: 3mm (Mechanical Surface Detection)

Electronics: DAE4 Sn1322; Calibrated: 8/24/2012

Phantom: SAM Sub; Type: SAM 4.0; Serial: TP-1403

Measurement SW: DASY4, Version 4.7 (80); SEMCAD X Version 14.6.10 (7164)

Mode: IEEE 802.11b, Body SAR, Ch 06, 1 Mbps, Back Side

Area Scan (9x14x1): Measurement grid: dx=12mm, dy=12mm

Zoom Scan (7x7x7)/Cube 0: Measurement grid: dx=5mm, dy=5mm, dz=5mm

Reference Value = 5.501 V/m; Power Drift = 0.02 dB

Peak SAR (extrapolated) = 0.130 W/kg

SAR(1 g) = 0.064 W/kg

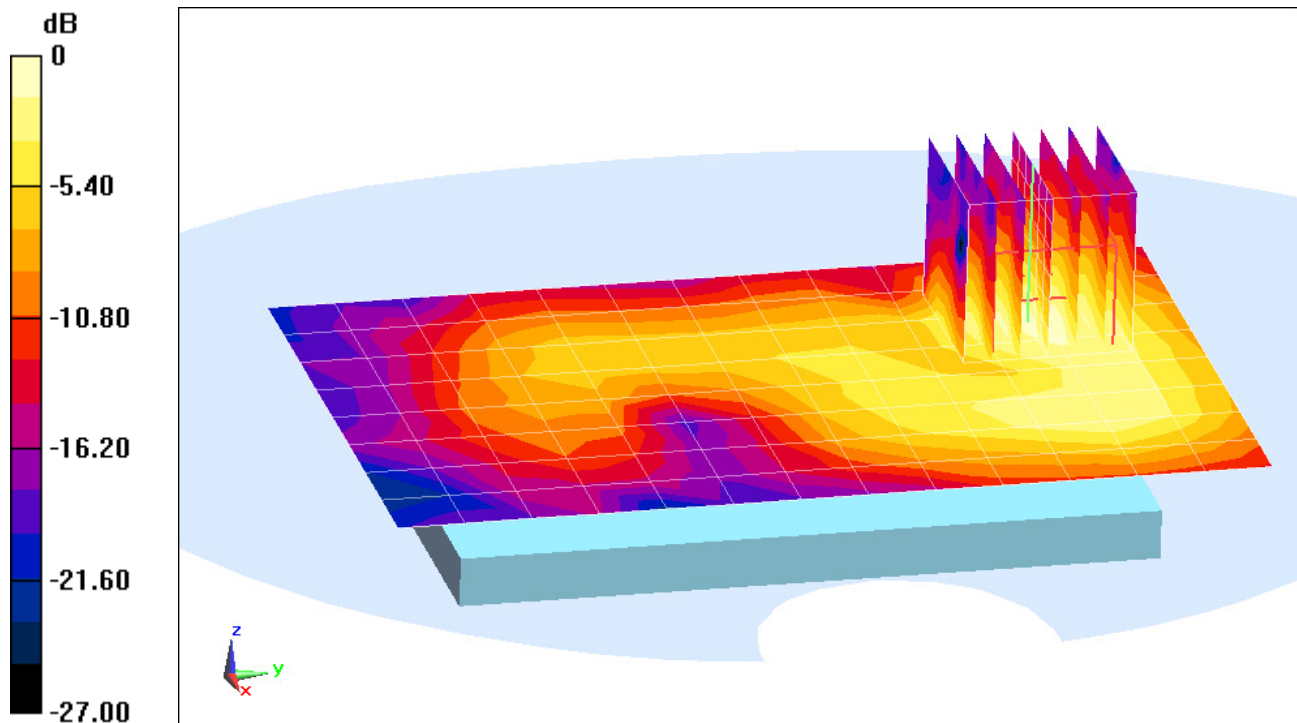

0 dB = 0.0817 W/kg = -10.88 dBW/kg

PCTEST ENGINEERING LABORATORY, INC.

DUT: A3LSPHL520; Type: Portable Handset; Serial: 05180482

Communication System: IEEE 802.11a 5.2-5.8 GHz Band; Frequency: 5745 MHz; Duty Cycle: 1:1

Medium: 5 GHz Body Medium parameters used:

$$f = 5745 \text{ MHz}; \sigma = 6.139 \text{ S/m}; \epsilon_r = 46.17; \rho = 1000 \text{ kg/m}^3$$

Phantom section: Flat Section; Space: 1.0 cm

Test Date: 07-08-2013; Ambient Temp: 24.5°C; Tissue Temp: 23.4°C

Probe: EX3DV4 - SN3589; ConvF(3.66, 3.66, 3.66); Calibrated: 1/17/2013;

Sensor-Surface: 1.4mm (Mechanical Surface Detection)

Electronics: DAE4 Sn1272; Calibrated: 1/17/2013

Phantom: SAM Sub; Type: SAM 4.0; Serial: TP-1357

Measurement SW: DASY4, Version 4.7 (80); SEMCAD X Version 14.6.10 (7164)

Mode: IEEE 802.11a, 5.8 GHz, Body SAR, Ch 149, 6 Mbps, Back Side

Area Scan (11x17x1): Measurement grid: dx=10mm, dy=10mm

Zoom Scan (7x7x7)/Cube 0: Measurement grid: dx=4mm, dy=4mm, dz=1.4mm; Graded Ratio:1.4

Reference Value = 3.899 V/m; Power Drift = -0.15 dB

Peak SAR (extrapolated) = 0.453 W/kg

SAR(1 g) = 0.075 W/kg

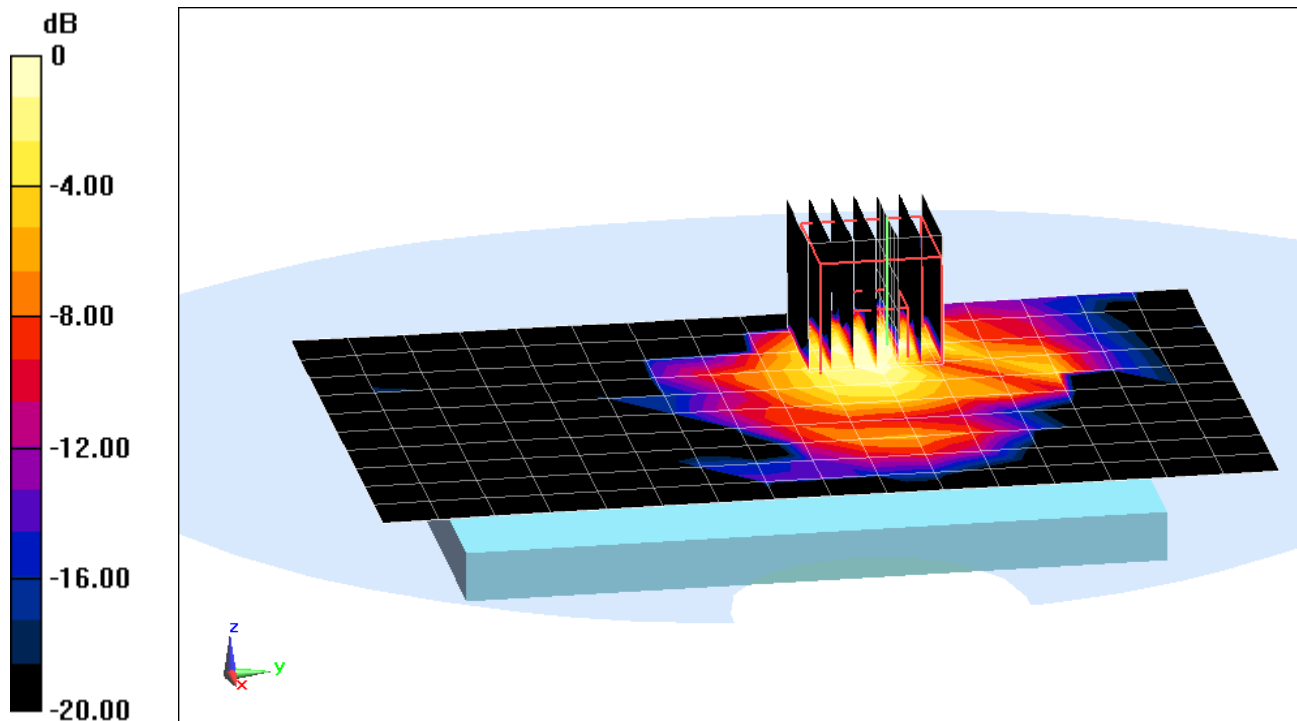

0 dB = 0.234 W/kg = -6.31 dBW/kg

PCTEST ENGINEERING LABORATORY, INC.

DUT: A3LSPHL520; Type: Portable Handset; Serial: 05180482

Communication System: IEEE 802.11a 5.2-5.8 GHz Band; Frequency: 5260 MHz; Duty Cycle: 1:1

Medium: 5 GHz Body Medium parameters used:

$f = 5260 \text{ MHz}$; $\sigma = 5.331 \text{ S/m}$; $\epsilon_r = 46.752$; $\rho = 1000 \text{ kg/m}^3$

Phantom section: Flat Section; Space: 1.0 cm

Test Date: 07-08-2013; Ambient Temp: 24.4°C; Tissue Temp: 23.2°C

Probe: EX3DV4 - SN3589; ConvF(3.81, 3.81, 3.81); Calibrated: 1/17/2013;

Sensor-Surface: 1.4mm (Mechanical Surface Detection)

Electronics: DAE4 Sn1272; Calibrated: 1/17/2013

Phantom: SAM Sub; Type: SAM 4.0; Serial: TP-1357

Measurement SW: DASY4, Version 4.7 (80); SEMCAD X Version 14.6.10 (7164)

Mode: IEEE 802.11a, 5.3 GHz, Body SAR, Ch 52, 6 Mbps, Back Side

Area Scan (11x17x1): Measurement grid: dx=10mm, dy=10mm

Zoom Scan (7x7x7)/Cube 0: Measurement grid: dx=4mm, dy=4mm, dz=1.4mm; Graded Ratio: 1.4

Reference Value = 7.213 V/m; Power Drift = -0.18 dB

Peak SAR (extrapolated) = 1.14 W/kg

SAR(1 g) = 0.271 W/kg

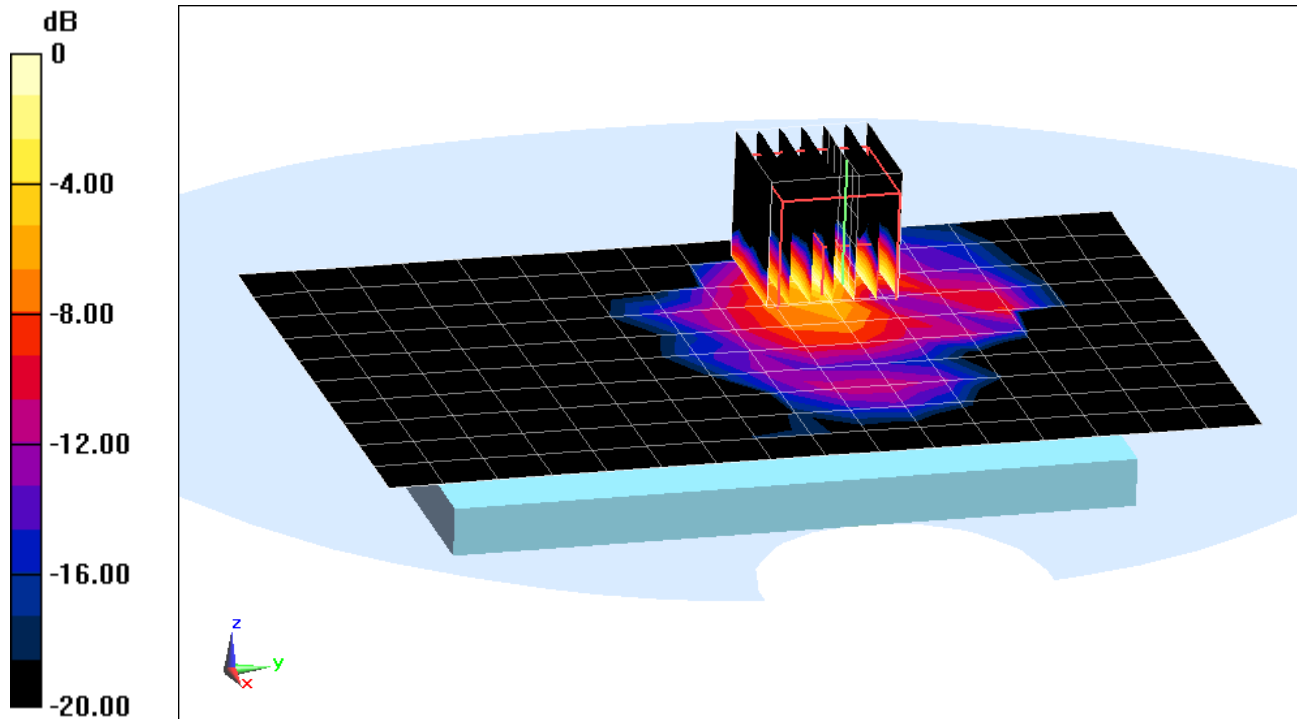

0 dB = 0.678 W/kg = -1.69 dBW/kg

PCTEST ENGINEERING LABORATORY, INC.

DUT: A3LSPHL520; Type: Portable Handset; Serial: 05180482

Communication System: IEEE 802.11a 5.2-5.8 GHz Band; Frequency: 5745 MHz; Duty Cycle: 1:1

Medium: 5 GHz Body Medium parameters used:

$f = 5745 \text{ MHz}$; $\sigma = 6.139 \text{ S/m}$; $\epsilon_r = 46.17$; $\rho = 1000 \text{ kg/m}^3$

Phantom section: Flat Section; Space: 1.0 cm

Test Date: 07-08-2013; Ambient Temp: 24.5°C; Tissue Temp: 23.4°C

Probe: EX3DV4 - SN3589; ConvF(3.66, 3.66, 3.66); Calibrated: 1/17/2013;

Sensor-Surface: 1.4mm (Mechanical Surface Detection)

Electronics: DAE4 Sn1272; Calibrated: 1/17/2013

Phantom: SAM Sub; Type: SAM 4.0; Serial: TP-1357

Measurement SW: DASY4, Version 4.7 (80); SEMCAD X Version 14.6.10 (7164)

Mode: IEEE 802.11a, 5.8 GHz, Body SAR, Ch 149, 6 Mbps, Right Edge

Area Scan (13x17x1): Measurement grid: dx=5mm, dy=10mm

Zoom Scan (7x7x7)/Cube 0: Measurement grid: dx=4mm, dy=4mm, dz=1.4mm; Graded Ratio: 1.4

Reference Value = 0.231 V/m; Power Drift = -0.199 dB

Peak SAR (extrapolated) = 0.533 W/kg

SAR(1 g) = 0.082 W/kg

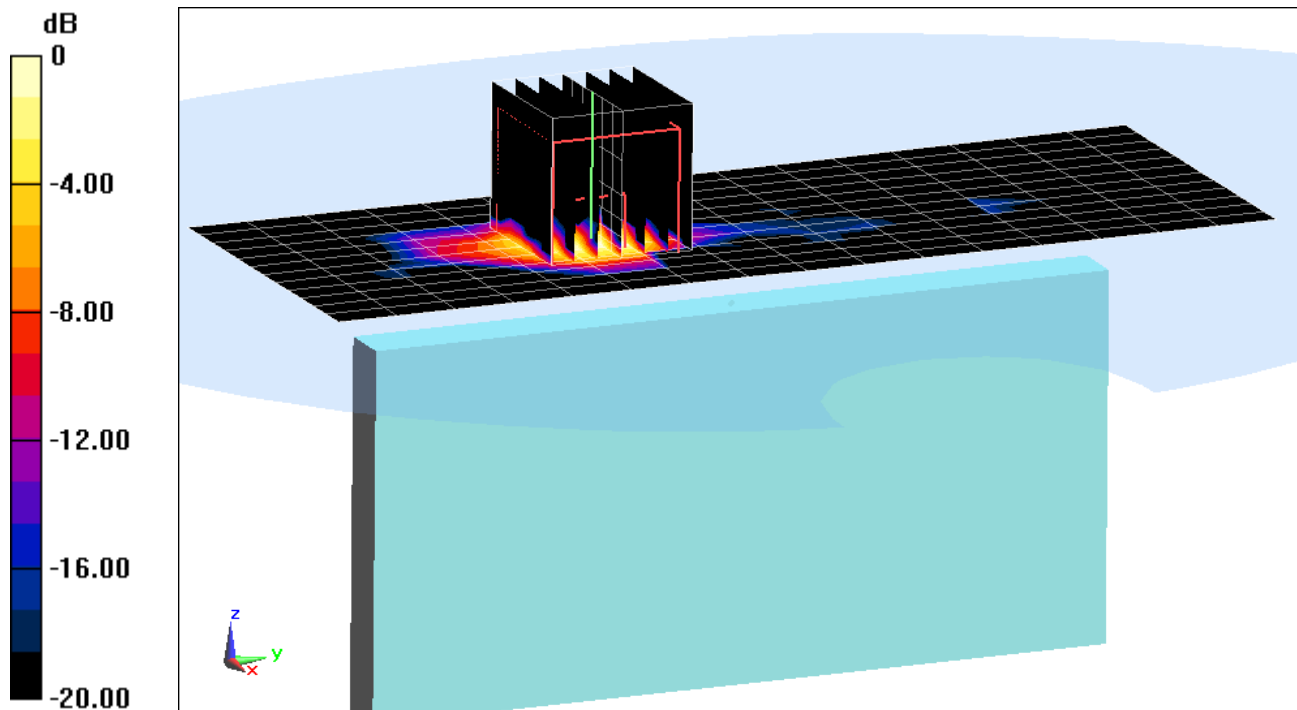

0 dB = 0.267 W/kg = -5.73 dBW/kg

APPENDIX B: SYSTEM VERIFICATION

PCTEST ENGINEERING LABORATORY, INC.

DUT: Dipole 835 MHz; Type: D835V2; Serial: 4d132

Communication System: CW; Frequency: 835 MHz; Duty Cycle: 1:1

Medium: 835 Head Medium parameters used:

$f = 835 \text{ MHz}$; $\sigma = 0.929 \text{ S/m}$; $\epsilon_r = 41.058$; $\rho = 1000 \text{ kg/m}^3$

Phantom section: Flat Section ; Space: 1.5 cm

Test Date: 07-01-2013; Ambient Temp: 23.9°C; Tissue Temp: 23.2°C

Probe: ES3DV3 - SN3288; ConvF(6.41, 6.41, 6.41); Calibrated: 9/20/2012;

Sensor-Surface: 4mm (Mechanical Surface Detection)

Electronics: DAE4 Sn1323; Calibrated: 9/19/2012

Phantom: SAM v5.0 front; Type: QD000P40CD; Serial: TP-1646

Measurement SW: DASY52, Version 52.8 (7); SEMCAD X Version 14.6.10 (7164)

835 MHz System Verification

Area Scan (7x14x1): Measurement grid: dx=15mm, dy=15mm

Zoom Scan (5x5x7)/Cube 0: Measurement grid: dx=8mm, dy=8mm, dz=5mm

Input Power: 20.0 dBm (100 mW)

Peak SAR (extrapolated) = 1.48 W/kg

SAR(1 g) = 0.998 W/kg

Deviation: 3.31%

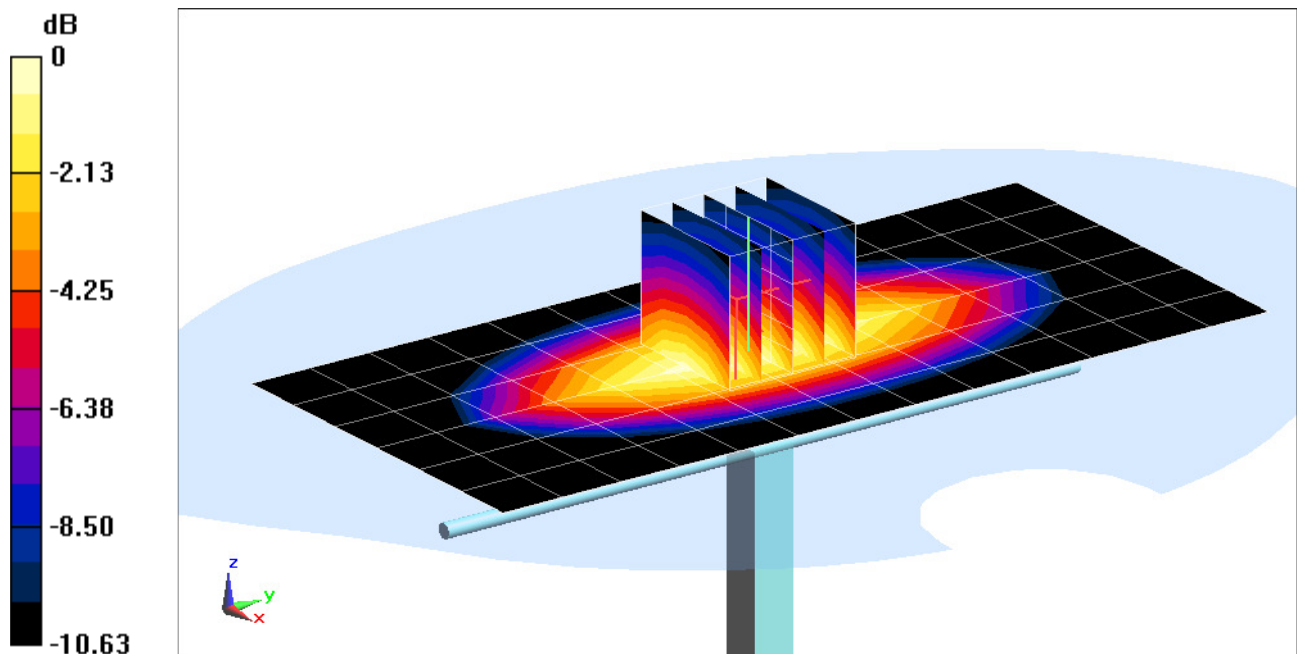

0 dB = 1.08 W/kg = 0.33 dBW/kg

PCTEST ENGINEERING LABORATORY, INC.

DUT: Dipole 835 MHz; Type: D835V2; Serial: 4d132

Communication System: CW; Frequency: 835 MHz; Duty Cycle: 1:1

Medium: 835 Head Medium parameters used:

$f = 835 \text{ MHz}$; $\sigma = 0.911 \text{ S/m}$; $\epsilon_r = 40.322$; $\rho = 1000 \text{ kg/m}^3$

Phantom section: Flat Section; Space: 1.5 cm

Test Date: 07-15-2013; Ambient Temp: 24.3°C; Tissue Temp: 23.5°C

Probe: EX3DV4 - SN3920; ConvF(9.58, 9.58, 9.58); Calibrated: 2/27/2013;

Sensor-Surface: 4mm (Mechanical Surface Detection)

Electronics: DAE4 Sn649; Calibrated: 2/6/2013

Phantom: SAM V5.0 Right; Type: QD000P40CD; Serial: 1647

Measurement SW: DASY52, Version 52.8 (7); SEMCAD X Version 14.6.10 (7164)

835 MHz System Verification

Area Scan (7x14x1): Measurement grid: dx=15mm, dy=15mm

Zoom Scan (5x5x7)/Cube 0: Measurement grid: dx=8mm, dy=8mm, dz=5mm

Input Power = 20 dBm (100 mW)

Peak SAR (extrapolated) = 1.48 W/kg

SAR(1 g) = 0.975 W/kg

Deviation = 0.93%

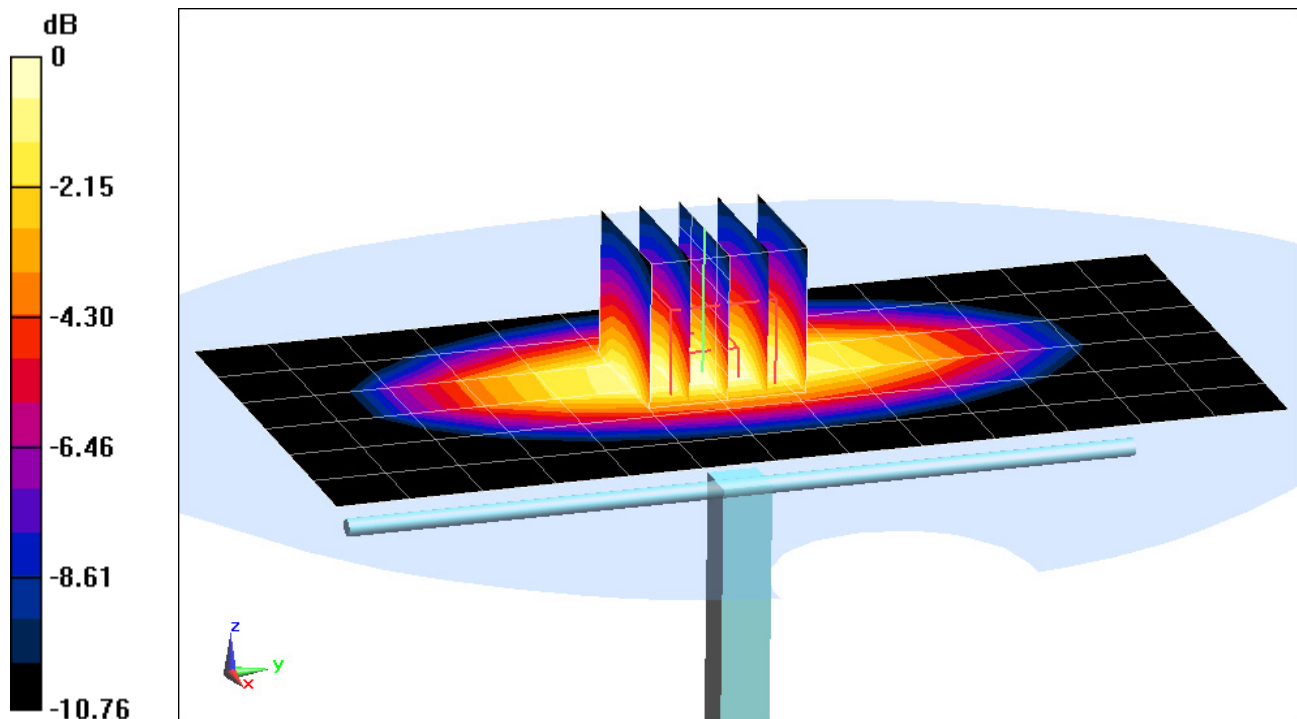

0 dB = 1.05 W/kg = 0.21 dBW/kg

PCTEST ENGINEERING LABORATORY, INC.

DUT: Dipole 1900 MHz; Type: D1900V2; Serial: 5d148

Communication System: CW; Frequency: 1900 MHz; Duty Cycle: 1:1

Medium: 1900 Head Medium parameters used (interpolated):

$f = 1900 \text{ MHz}$; $\sigma = 1.446 \text{ S/m}$; $\epsilon_r = 39.012$; $\rho = 1000 \text{ kg/m}^3$

Phantom section: Flat Section; Space: 1.0 cm

Test Date: 07-05-2013; Ambient Temp: 23.6°C; Tissue Temp: 23.0°C

Probe: EX3DV4 - SN3920; ConvF(7.73, 7.73, 7.73); Calibrated: 2/27/2013;

Sensor-Surface: 4mm (Mechanical Surface Detection)

Electronics: DAE4 Sn649; Calibrated: 2/6/2013

Phantom: SAM V5.0 Right; Type: QD000P40CD; Serial: 1647

Measurement SW: DASY52, Version 52.8 (7); SEMCAD X Version 14.6.10 (7164)

1900 MHz System Verification

Area Scan (7x10x1): Measurement grid: dx=15mm, dy=15mm

Zoom Scan (5x5x7)/Cube 0: Measurement grid: dx=8mm, dy=8mm, dz=5mm

Input Power = 20 dBm (100 mW)

Peak SAR (extrapolated) = 7.48 W/kg

SAR(1 g) = 4.06 W/kg

Deviation = 2.27%

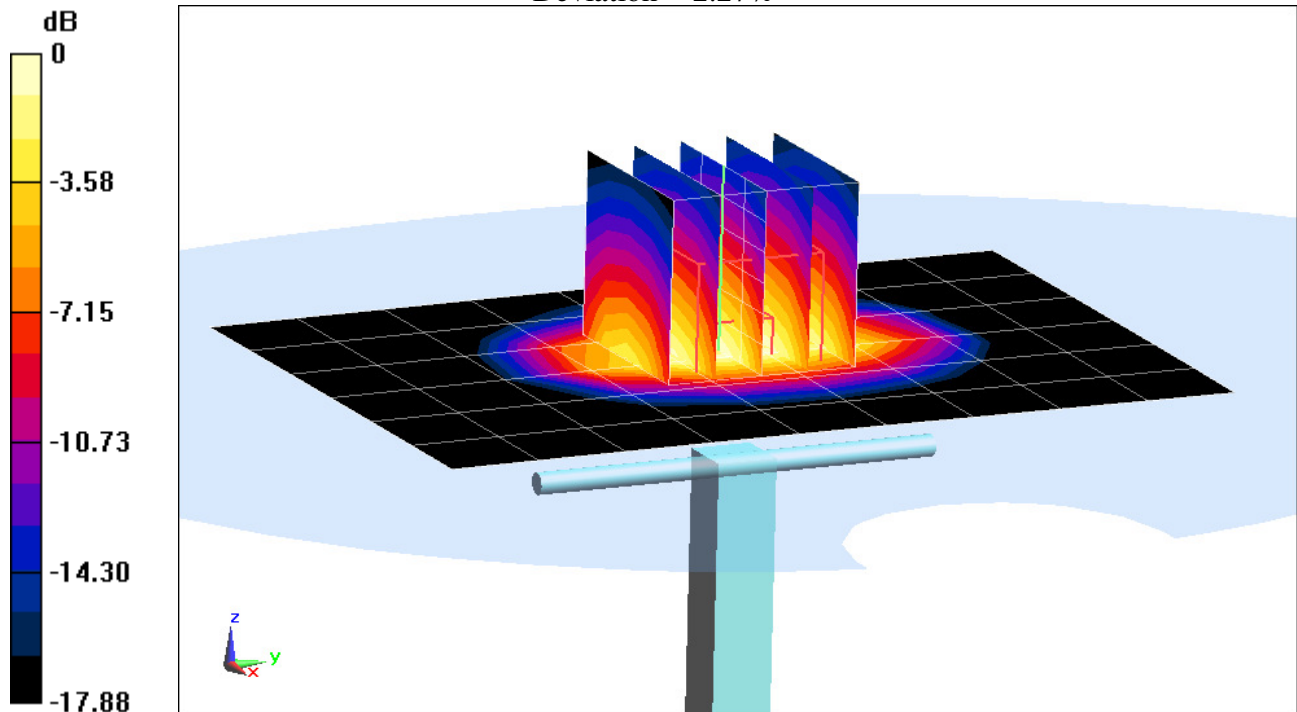

0 dB = 4.53 W/kg = 6.56 dBW/kg

PCTEST ENGINEERING LABORATORY, INC.

DUT: Dipole 2450 MHz; Type: D2450V2; Serial: 719

Communication System: CW; Frequency: 2450 MHz; Duty Cycle: 1:1

Medium: 2450 Head Medium parameters used:

$f = 2450 \text{ MHz}$; $\sigma = 1.846 \text{ S/m}$; $\epsilon_r = 38.495$; $\rho = 1000 \text{ kg/m}^3$

Phantom section: Flat Section; Space: 1.0 cm

Test Date: 07-18-2013; Ambient Temp: 23.0°C; Tissue Temp: 23.5°C

Probe: ES3DV2 - SN3022; ConvF(4.23, 4.23, 4.23); Calibrated: 8/28/2012;

Sensor-Surface: 3mm (Mechanical Surface Detection)

Electronics: DAE4 Sn1322; Calibrated: 8/24/2012

Phantom: SAM Sub; Type: SAM 4.0; Serial: TP-1403

Measurement SW: DASY4, Version 4.7 (80); SEMCAD X Version 14.6.10 (7164)

2450MHz System Verification

Area Scan (6x9x1): Measurement grid: dx=12mm, dy=12mm

Zoom Scan (7x7x7)/Cube 0: Measurement grid: dx=5mm, dy=5mm, dz=5mm

Input Power = 20 dBm (100 mW)

Peak SAR (extrapolated) = 12.1 W/kg

SAR(1 g) = 5.62 W/kg

Deviation = 6.64%

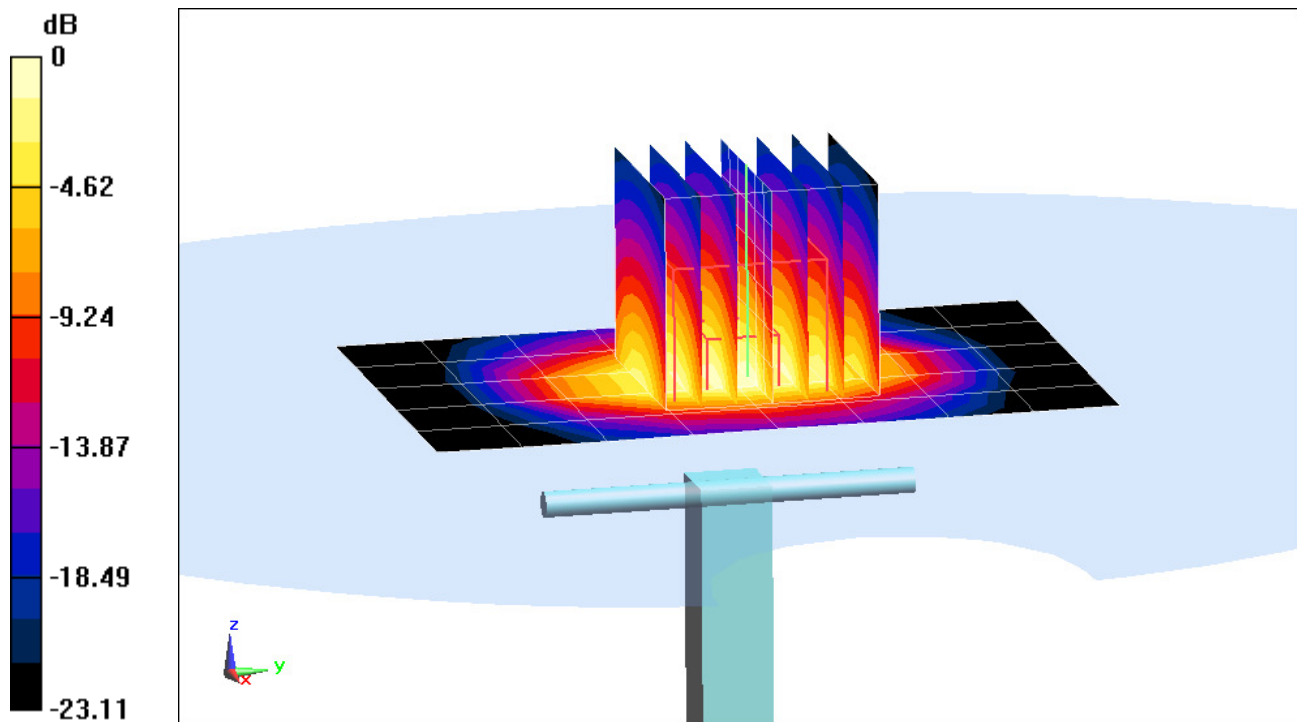

0 dB = 7.31 W/kg = 8.64 dBW/kg

PCTEST ENGINEERING LABORATORY, INC.

DUT: Dipole 2600 MHz; Type: D2600V2; Serial: 1004

Communication System: CW; Frequency: 2600 MHz; Duty Cycle: 1:1

Medium: 2450 Head Medium parameters used:

$f = 2600 \text{ MHz}$; $\sigma = 2.018 \text{ S/m}$; $\epsilon_r = 37.879$; $\rho = 1000 \text{ kg/m}^3$

Phantom section: Flat Section; Space: 1.0 cm

Test Date: 07-18-2013; Ambient Temp: 23.0°C; Tissue Temp: 23.5°C

Probe: ES3DV2 - SN3022; ConvF(4.1, 4.1, 4.1); Calibrated: 8/28/2012;

Sensor-Surface: 3mm (Mechanical Surface Detection)

Electronics: DAE4 Sn1322; Calibrated: 8/24/2012

Phantom: SAM Sub; Type: SAM 4.0; Serial: TP-1403

Measurement SW: DASY4, Version 4.7 (80); SEMCAD X Version 14.6.10 (7164)

2600MHz System Verification

Area Scan (6x8x1): Measurement grid: dx=12mm, dy=12mm

Zoom Scan (7x7x7)/Cube 0: Measurement grid: dx=5mm, dy=5mm, dz=5mm

Input Power = 20 dBm (100 mW)

Peak SAR (extrapolated) = 14.3 W/kg

SAR(1 g) = 6.22 W/kg

Deviation = 6.87%

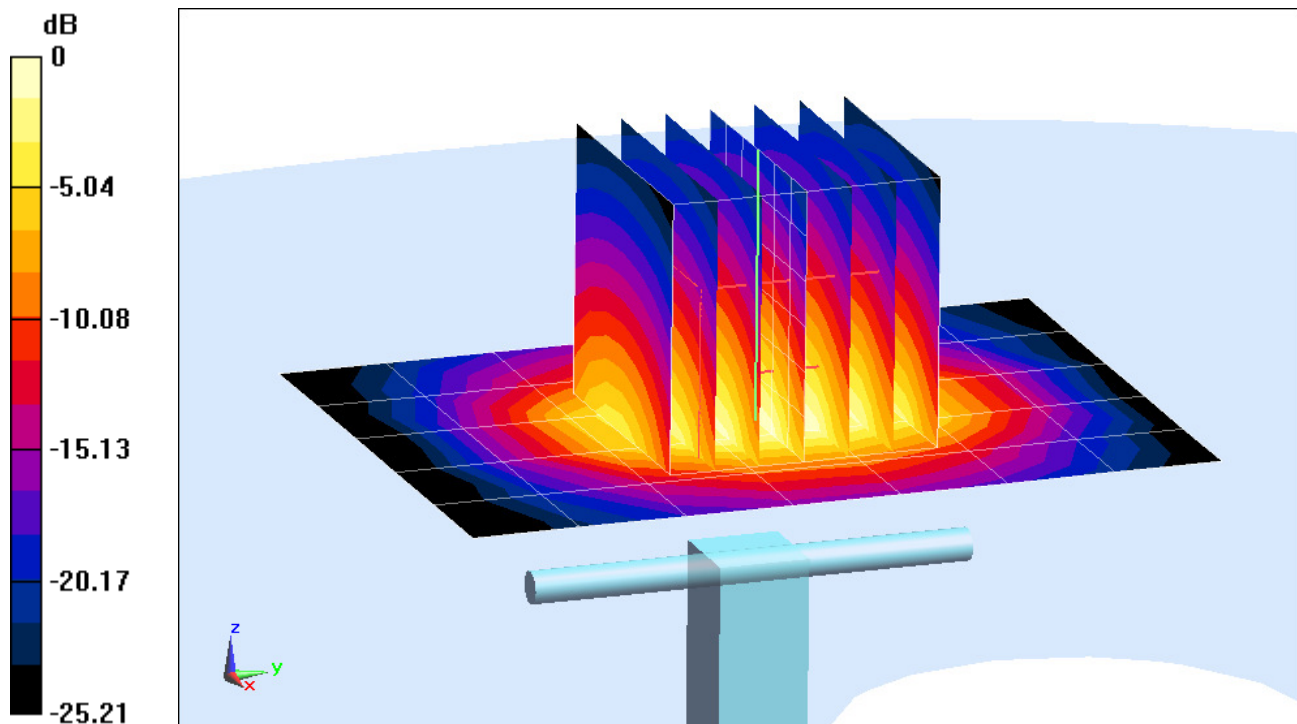

0 dB = 8.26 W/kg = 9.17 dBW/kg

PCTEST ENGINEERING LABORATORY, INC.

DUT: Dipole 5200 MHz; Type: D5GHzV2; Serial: 1120

Communication System: CW; Frequency: 5200 MHz; Duty Cycle: 1:1

Medium: 5 GHz Head Medium parameters used:

$f = 5200$ MHz; $\sigma = 4.468$ S/m; $\epsilon_r = 35.069$; $\rho = 1000$ kg/m³

Phantom section: Flat Section; Space; 1.0 cm

Test Date: 07-08-2013; Ambient Temp: 24.4°C; Tissue Temp: 23.1°C

Probe: EX3DV4 - SN3920; ConvF(4.87, 4.87, 4.87); Calibrated: 2/27/2013;

Sensor-Surface: 1.4mm (Mechanical Surface Detection)

Electronics: DAE4 Sn649; Calibrated: 2/6/2013

Phantom: SAM 5.0 front; Type: QD000P40CD; Serial: TP:-1648

Measurement SW: DASY52, Version 52.8 (7); SEMCAD X Version 14.6.10 (7164)

5200 MHz System Verification

Area Scan (7x8x1): Measurement grid: dx=10mm, dy=10mm

Zoom Scan (9x9x7)/Cube 0: Measurement grid: dx=4mm, dy=4mm, dz=1.4mm; Graded Ratio: 1.4

Input Power = 16 dBm (40 mW)

Peak SAR (extrapolated) = 12.1 W/kg

SAR(1 g) = 3.03 W/kg

Deviation = -0.33%

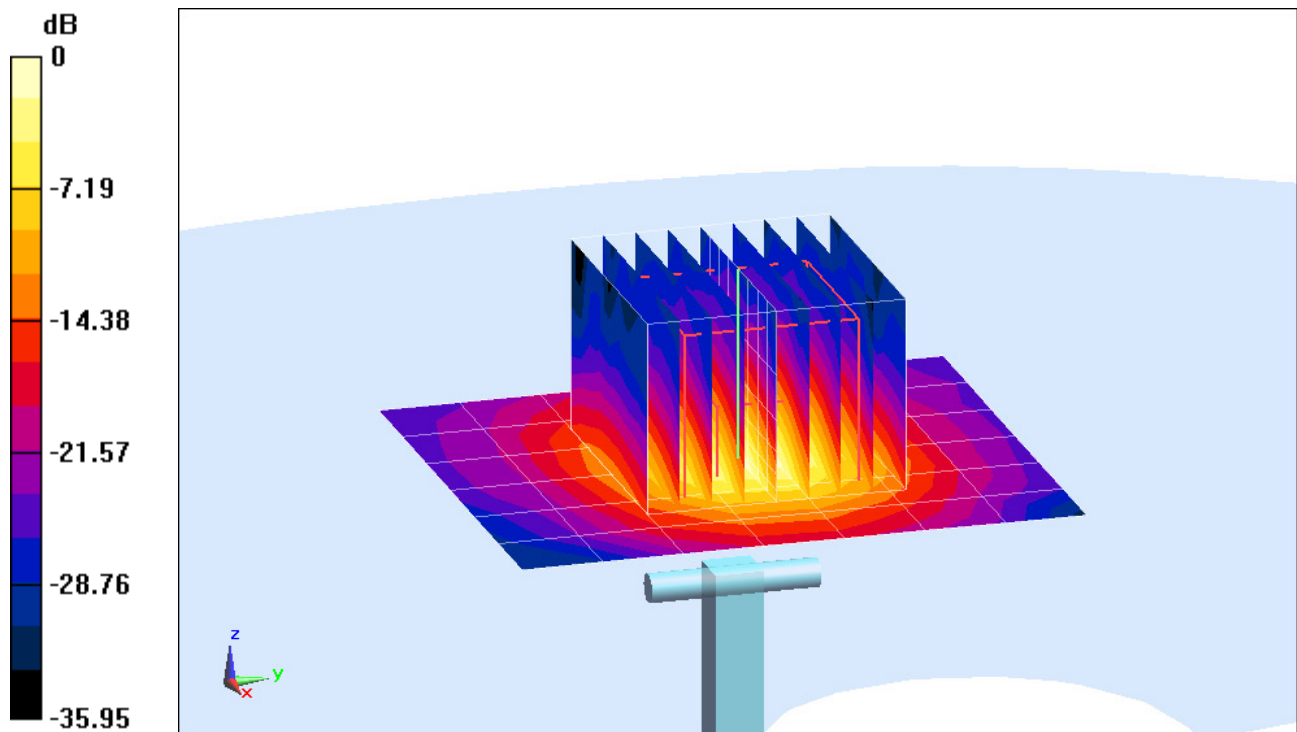

0 dB = 7.55 W/kg = 8.78 dBW/kg

PCTEST ENGINEERING LABORATORY, INC.

DUT: Dipole 5300 MHz; Type: D5GHzV2; Serial: 1120

Communication System: CW; Frequency: 5300 MHz; Duty Cycle: 1:1

Medium: 5 GHz Head Medium parameters used:

$f = 5300 \text{ MHz}$; $\sigma = 4.565 \text{ S/m}$; $\epsilon_r = 34.928$; $\rho = 1000 \text{ kg/m}^3$

Phantom section: Flat Section; Space: 1.0 cm

Test Date: 07-08-2013; Ambient Temp: 24.5°C; Tissue Temp: 23.1°C

Probe: EX3DV4 - SN3920; ConvF(4.73, 4.73, 4.73); Calibrated: 2/27/2013;

Sensor-Surface: 1.4mm (Mechanical Surface Detection)

Electronics: DAE4 Sn649; Calibrated: 2/6/2013

Phantom: SAM 5.0 front; Type: QD000P40CD; Serial: TP:-1648

Measurement SW: DASY52, Version 52.8 (7); SEMCAD X Version 14.6.10 (7164)

5300 MHz System Verification

Area Scan (7x8x1): Measurement grid: dx=10mm, dy=10mm

Zoom Scan (8x8x7)/Cube 0: Measurement grid: dx=4mm, dy=4mm, dz=1.4mm; Graded Ratio: 1.4

Input Power = 16 dBm (40 mW)

Peak SAR (extrapolated) = 12.2 W/kg

SAR(1 g) = 2.97 W/kg

Deviation = -5.65%

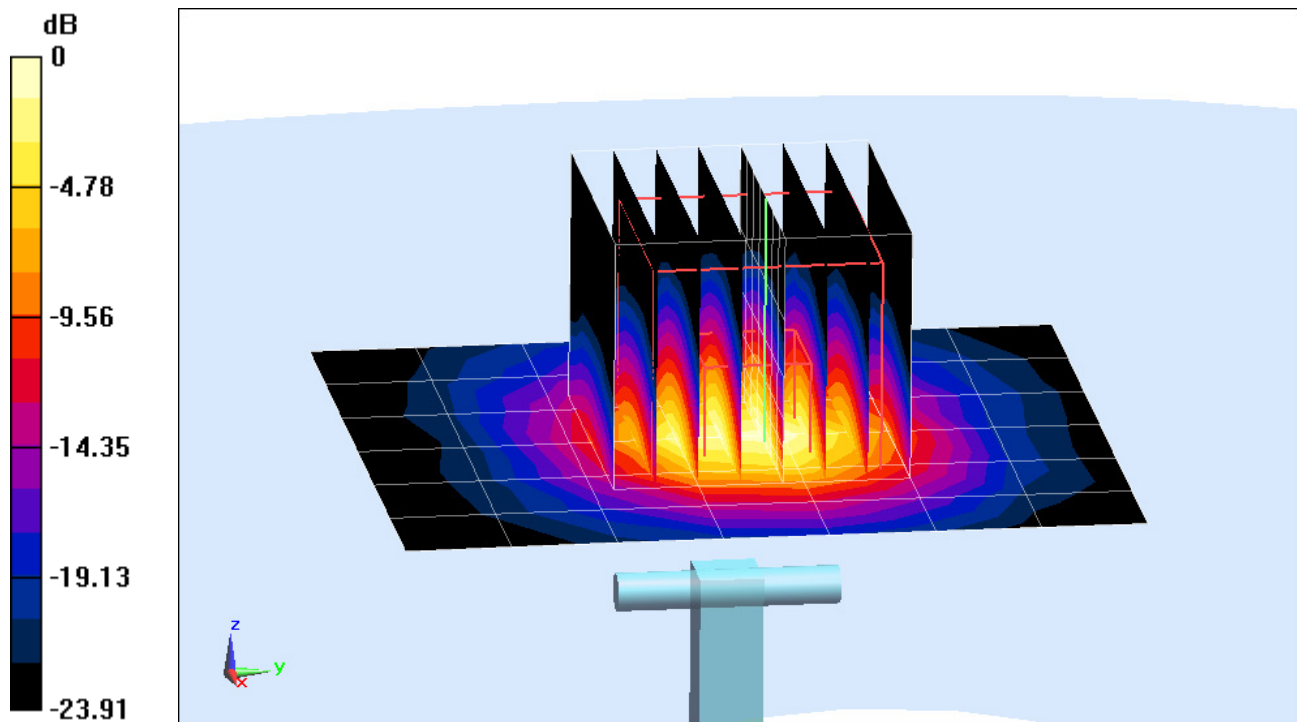

0 dB = 7.08 W/kg = 8.50 dBW/kg

PCTEST ENGINEERING LABORATORY, INC.

DUT: Dipole 5500 MHz; Type: D5GHzV2; Serial: 1120

Communication System: CW; Frequency: 5500 MHz; Duty Cycle: 1:1

Medium: 5 GHz Head Medium parameters used:

$f = 5500 \text{ MHz}$; $\sigma = 4.76 \text{ S/m}$; $\epsilon_r = 34.63$; $\rho = 1000 \text{ kg/m}^3$

Phantom section: Flat Section; Space: 1.0 cm

Test Date: 07-08-2013; Ambient Temp: 24.5°C; Tissue Temp: 23.2°C

Probe: EX3DV4 - SN3920; ConvF(4.52, 4.52, 4.52); Calibrated: 2/27/2013;

Sensor-Surface: 1.4mm (Mechanical Surface Detection)

Electronics: DAE4 Sn649; Calibrated: 2/6/2013

Phantom: SAM 5.0 front; Type: QD000P40CD; Serial: TP:-1648

Measurement SW: DASY52, Version 52.8 (7); SEMCAD X Version 14.6.10 (7164)

5500 MHz System Verification

Area Scan (7x8x1): Measurement grid: $dx=10\text{mm}$, $dy=10\text{mm}$

Zoom Scan (9x9x7)/Cube 0: Measurement grid: $dx=4\text{mm}$, $dy=4\text{mm}$, $dz=1.4\text{mm}$; Graded Ratio: 1.4

Input Power = 16 dBm (40 mW)

Peak SAR (extrapolated) = 12.2 W/kg

SAR(1 g) = 2.98 W/kg

Deviation = -6.99%

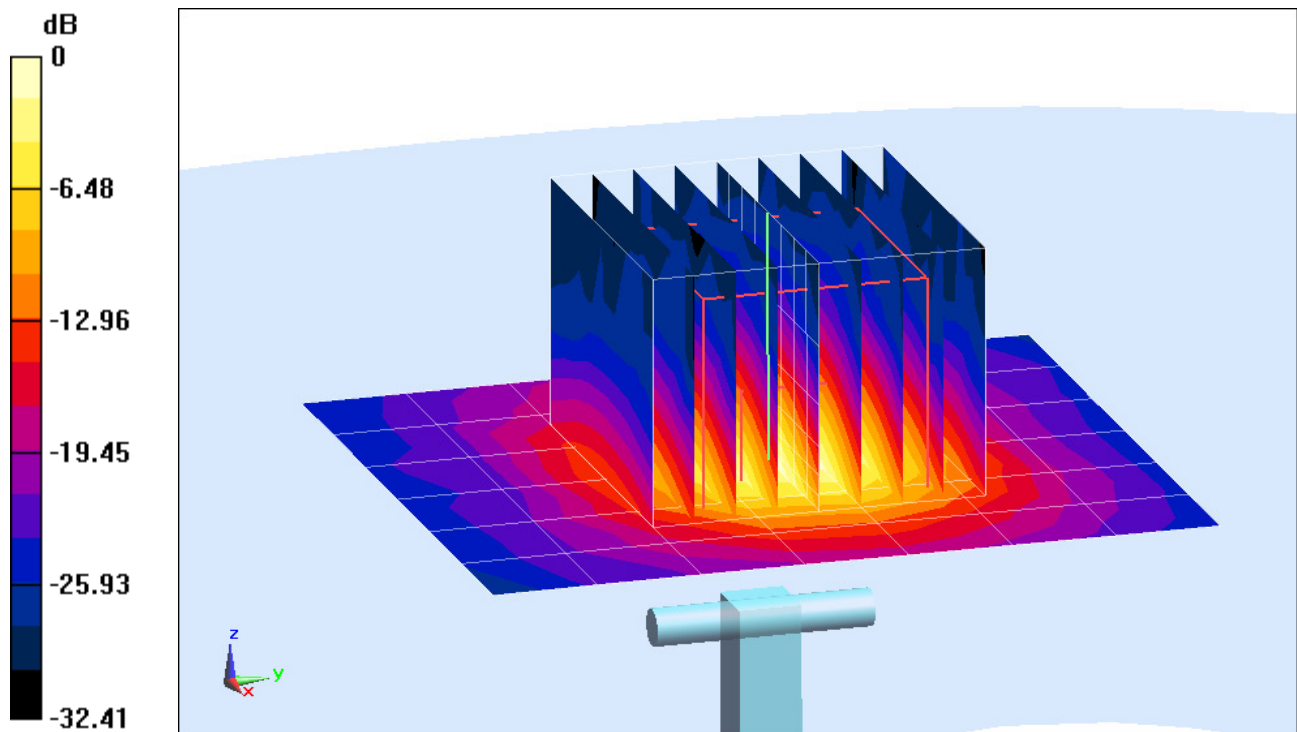

PCTEST ENGINEERING LABORATORY, INC.

DUT: Dipole 5800 MHz; Type: D5GHzV2; Serial: 1120

Communication System: CW; Frequency: 5800 MHz; Duty Cycle: 1:1

Medium: 5 GHz Head Medium parameters used:

$f = 5800 \text{ MHz}$; $\sigma = 5.075 \text{ S/m}$; $\epsilon_r = 34.216$; $\rho = 1000 \text{ kg/m}^3$

Phantom section: Flat Section; Space: 1.0 cm

Test Date: 07-08-2013; Ambient Temp: 24.5°C; Tissue Temp: 23.2°C

Probe: EX3DV4 - SN3920; ConvF(4.02, 4.02, 4.02); Calibrated: 2/27/2013;

Sensor-Surface: 1.4mm (Mechanical Surface Detection)

Electronics: DAE4 Sn649; Calibrated: 2/6/2013

Phantom: SAM 5.0 front; Type: QD000P40CD; Serial: TP:-1648

Measurement SW: DASY52, Version 52.8 (7); SEMCAD X Version 14.6.10 (7164)

5800 MHz System Verification

Area Scan (7x8x1): Measurement grid: $dx=10\text{mm}$, $dy=10\text{mm}$

Zoom Scan (9x9x7)/Cube 0: Measurement grid: $dx=4\text{mm}$, $dy=4\text{mm}$, $dz=1.4\text{mm}$; Graded Ratio: 1.4

Input Power = 16 dBm (40 mW)

Peak SAR (extrapolated) = 12.5 W/kg

*****SAR(1 g) = 2.98 W/kg

Deviation = -0.53%

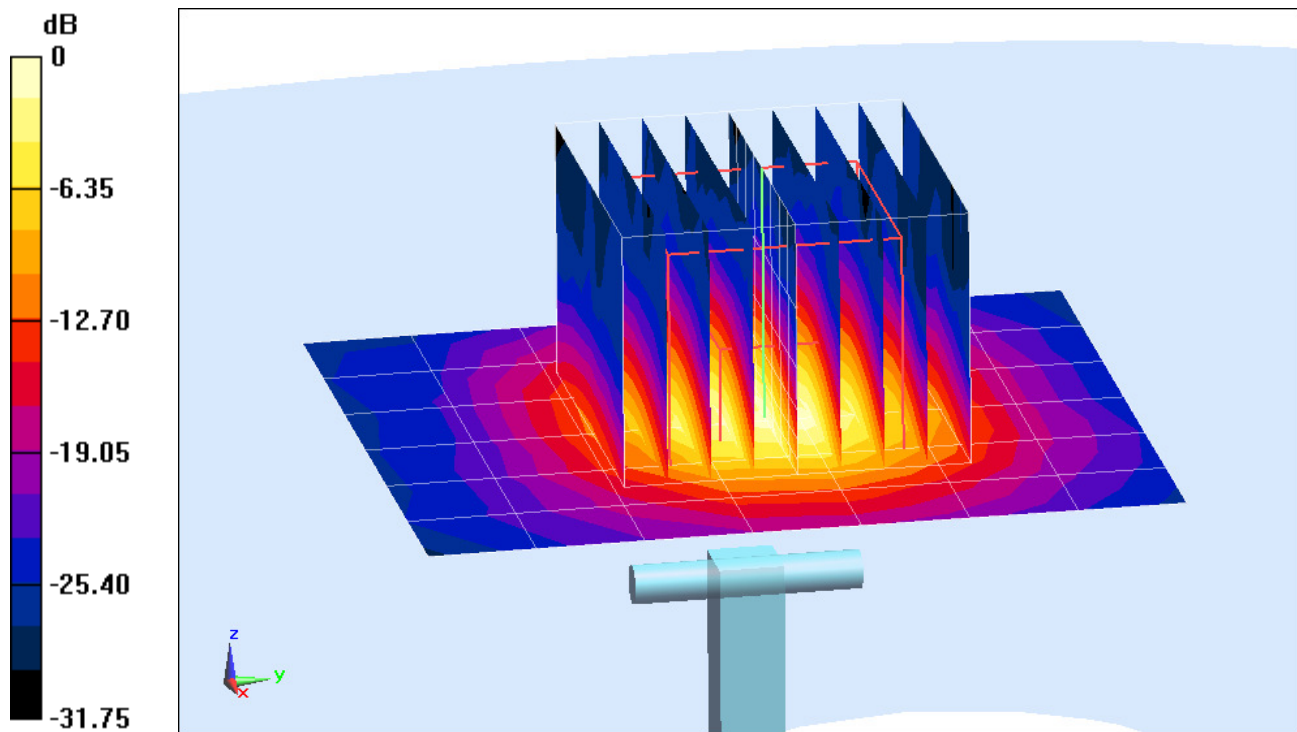

0 dB = 7.63 W/kg = 8.83 dBW/kg

PCTEST ENGINEERING LABORATORY, INC.

DUT: Dipole 835 MHz; Type: D835V2; Serial: 4d026

Communication System: CW; Frequency: 835 MHz; Duty Cycle: 1:1

Medium: 835 Body Medium parameters used:

$f = 835 \text{ MHz}$; $\sigma = 0.955 \text{ S/m}$; $\epsilon_r = 56.964$; $\rho = 1000 \text{ kg/m}^3$

Phantom section: Flat Section; Space: 1.5 cm

Test Date: 07-02-2013; Ambient Temp: 23.5°C; Tissue Temp: 22.2°C

Probe: ES3DV3 - SN3287; ConvF(6.06, 6.06, 6.06); Calibrated: 11/15/2012;

Sensor-Surface: 4mm (Mechanical Surface Detection)

Electronics: DAE4 Sn1333; Calibrated: 11/13/2012

Phantom: SAM with CRP; Type: SAM 4.0; Serial: TP1375

Measurement SW: DASY4, Version 4.7 (80); SEMCAD X Version 14.6.10 (7164)

835MHz System Verification

Area Scan (7x13x1): Measurement grid: dx=15mm, dy=15mm

Zoom Scan (5x5x7)/Cube 0: Measurement grid: dx=8mm, dy=8mm, dz=5mm

Input Power = 20 dBm (100 mW)

Peak SAR (extrapolated) = 1.43 W/kg

SAR(1 g) = 0.995 W/kg

Deviation = 3.86%

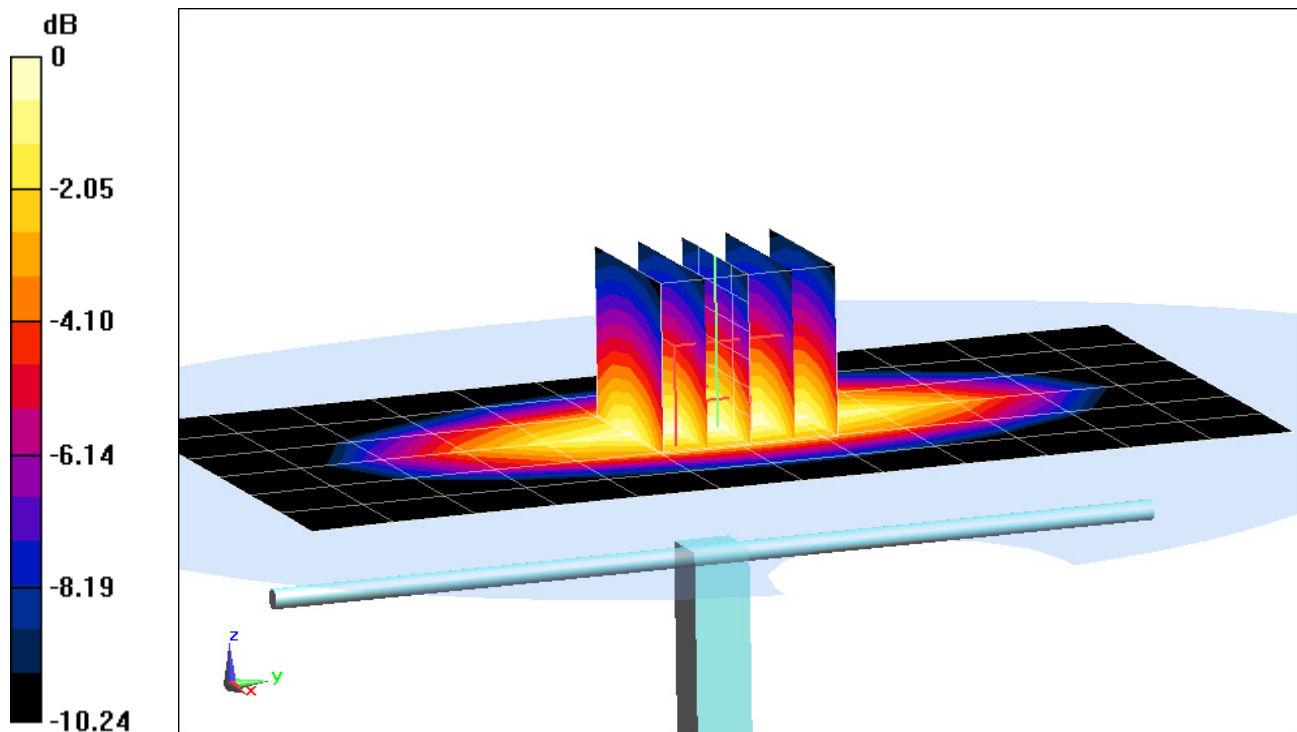

0 dB = 1.08 W/kg = 0.33 dBW/kg

PCTEST ENGINEERING LABORATORY, INC.

DUT: Dipole 835 MHz; Type: D835V2; Serial: 4d132

Communication System: CW; Frequency: 835 MHz; Duty Cycle: 1:1

Medium: 835 Body Medium parameters used:

$f = 835 \text{ MHz}$; $\sigma = 1.011 \text{ S/m}$; $\epsilon_r = 55.799$; $\rho = 1000 \text{ kg/m}^3$

Phantom section: Flat Section; Space: 1.0 cm

Test Date: 07-08-2013; Ambient Temp: 24.5°C; Tissue Temp: 23.5°C

Probe: ES3DV3 - SN3209; ConvF(6.28, 6.28, 6.28); Calibrated: 3/15/2013;

Sensor-Surface: 4mm (Mechanical Surface Detection)

Electronics: DAE4 Sn1334; Calibrated: 3/8/2013

Phantom: ELI v5.0; Type: QDOVA002AA; Serial: TP-1158

Measurement SW: DASY52, Version 52.8 (7); SEMCAD X Version 14.6.10 (7164)

835 MHz System Verification

Area Scan (7x14x1): Measurement grid: dx=15mm, dy=15mm

Zoom Scan (5x5x7)/Cube 0: Measurement grid: dx=8mm, dy=8mm, dz=5mm

Input Power = 20 dBm (100 mW)

Peak SAR (extrapolated) = 1.41 W/kg

SAR(1 g) = 0.975 W/kg

Deviation = 4.17%

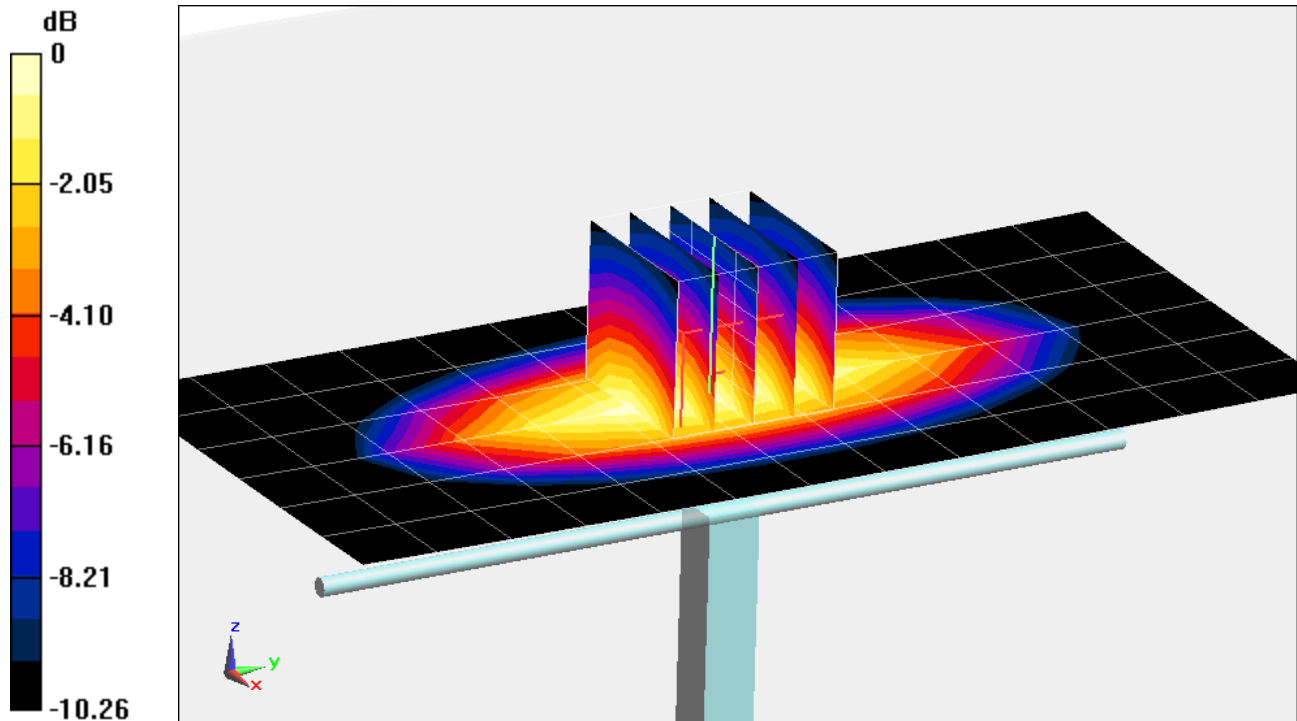

0 dB = 1.05 W/kg = 0.21 dBW/kg

PCTEST ENGINEERING LABORATORY, INC.

DUT: Dipole 1900 MHz; Type: D1900V2; Serial: 5d080

Communication System: CW; Frequency: 1900 MHz; Duty Cycle: 1:1

Medium: 1900 Body Medium parameters used (interpolated):

$f = 1900 \text{ MHz}$; $\sigma = 1.525 \text{ S/m}$; $\epsilon_r = 51.815$; $\rho = 1000 \text{ kg/m}^3$

Phantom section: Flat Section; Space: 1.0 cm

Test Date: 07-01-2013; Ambient Temp: 23.5°C; Tissue Temp: 23.7°C

Probe: ES3DV2 - SN3022; ConvF(4.43, 4.43, 4.43); Calibrated: 8/28/2012;

Sensor-Surface: 4mm (Mechanical Surface Detection)

Electronics: DAE4 Sn1322; Calibrated: 8/24/2012

Phantom: SAM Sub; Type: SAM 4.0; Serial: TP-1357

Measurement SW: DASY4, Version 4.7 (80); SEMCAD X Version 14.6.10 (7164)

1900MHz System Verification

Area Scan (5x7x1): Measurement grid: dx=15mm, dy=15mm

Zoom Scan (5x5x7)/Cube 0: Measurement grid: dx=8mm, dy=8mm, dz=5mm

Input Power = 20 dBm (100 mW)

Peak SAR (extrapolated) = 6.99 W/kg

SAR(1 g) = 4.02 W/kg

Deviation = -0.25%

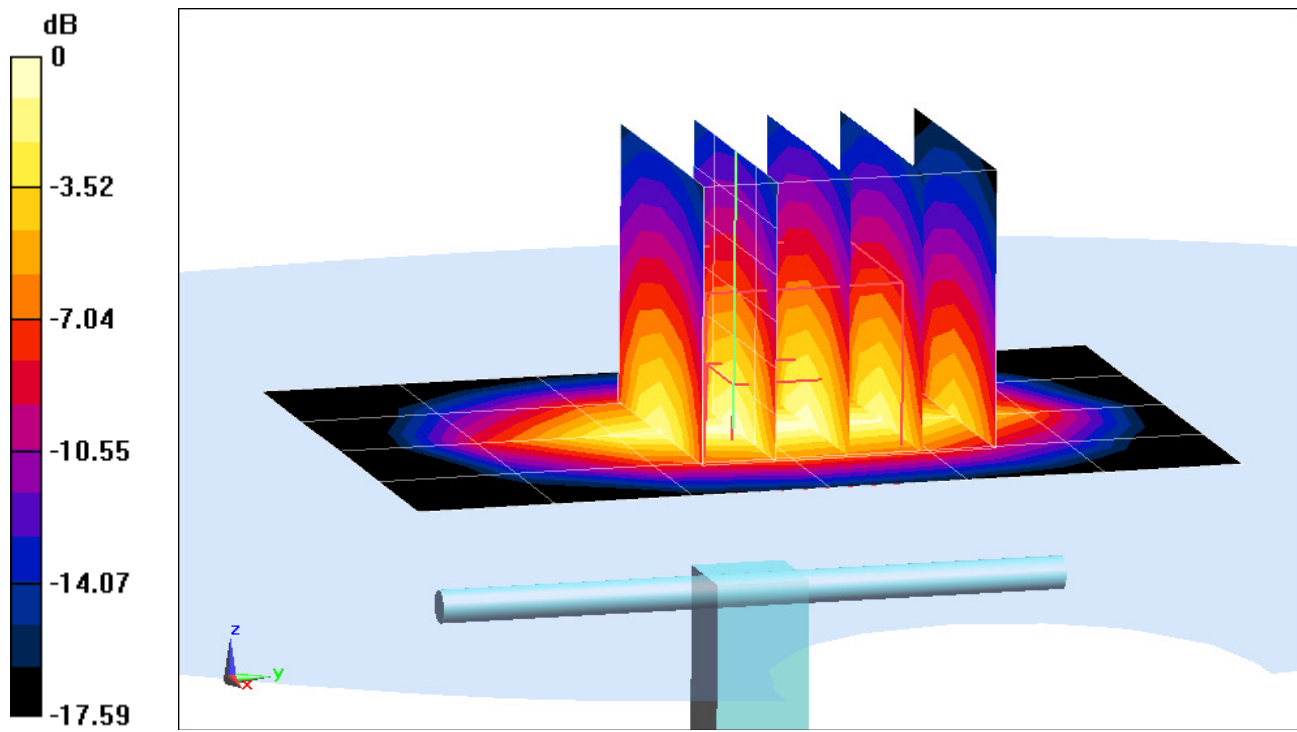

0 dB = 4.48 W/kg = 6.51 dBW/kg

PCTEST ENGINEERING LABORATORY, INC.

DUT: Dipole 1900 MHz; Type: D1900V2; Serial: 5d080

Communication System: CW; Frequency: 1900 MHz; Duty Cycle: 1:1

Medium: 1900 Body Medium parameters used (interpolated):

$f = 1900 \text{ MHz}$; $\sigma = 1.539 \text{ S/m}$; $\epsilon_r = 54.063$; $\rho = 1000 \text{ kg/m}^3$

Phantom section: Flat Section; Space: 1.0 cm

Test Date: 07-08-2013; Ambient Temp: 23.2°C; Tissue Temp: 22.8°C

Probe: ES3DV3 - SN3287; ConvF(4.69, 4.69, 4.69); Calibrated: 11/15/2012;

Sensor-Surface: 4mm (Mechanical Surface Detection)

Electronics: DAE4 Sn1333; Calibrated: 11/13/2012

Phantom: SAM Sub Dasy B; Type: SAM 5.0; Serial: TP-1626

Measurement SW: DASY4, Version 4.7 (80); SEMCAD X Version 14.6.10 (7164)

1900MHz System Verification

Area Scan (5x7x1): Measurement grid: dx=15mm, dy=15mm

Zoom Scan (5x5x7)/Cube 0: Measurement grid: dx=8mm, dy=8mm, dz=5mm

Input Power = 20 dBm (100 mW)

Peak SAR (extrapolated) = 7.53 W/kg

SAR(1 g) = 4.25 W/kg

Deviation = 5.46%

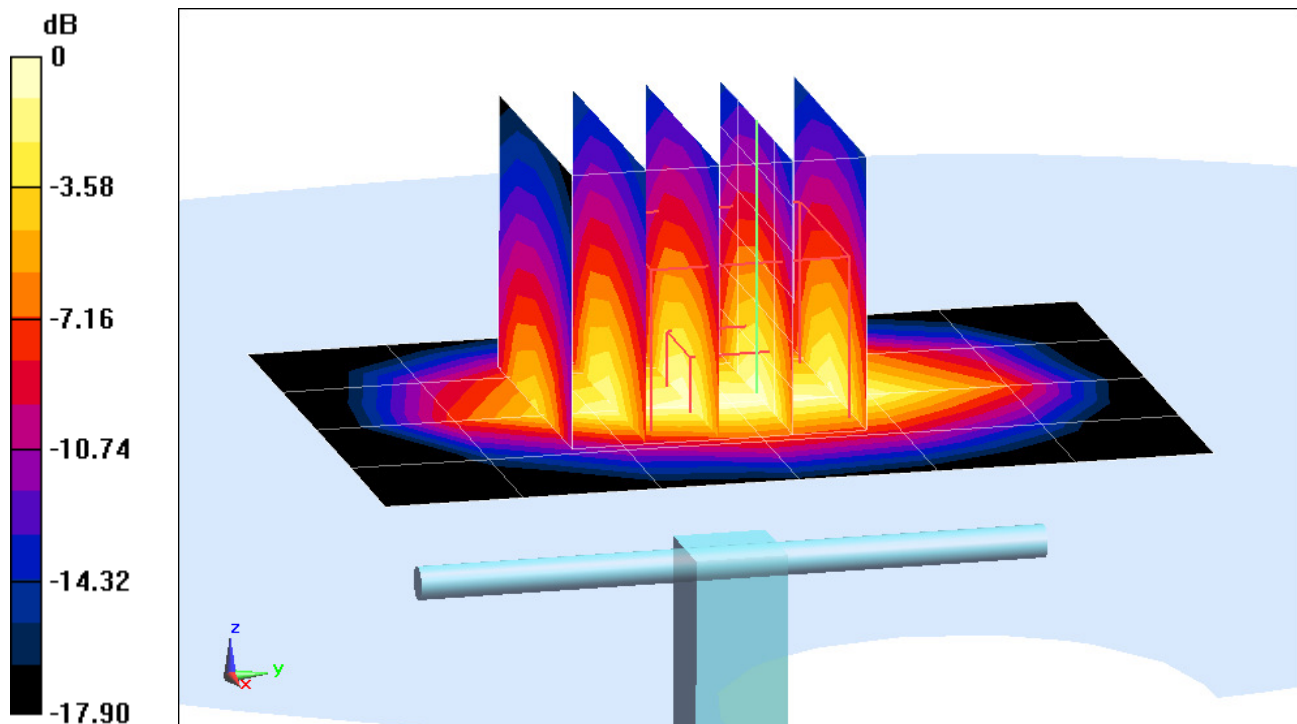

0 dB = 4.66 W/kg = 6.68 dBW/kg

PCTEST ENGINEERING LABORATORY, INC.

DUT: Dipole 2450 MHz; Type: D2450V2; Serial: 719

Communication System: CW; Frequency: 2450 MHz; Duty Cycle: 1:1

Medium: 2450 Body Medium parameters used:

$f = 2450 \text{ MHz}$; $\sigma = 2.015 \text{ S/m}$; $\epsilon_r = 53.219$; $\rho = 1000 \text{ kg/m}^3$

Phantom section: Flat Section; Space: 1.0 cm

Test Date: 07-08-2013; Ambient Temp: 22.8°C; Tissue Temp: 22.2°C

Probe: ES3DV2 - SN3022; ConvF(3.97, 3.97, 3.97); Calibrated: 8/28/2012;

Sensor-Surface: 3mm (Mechanical Surface Detection)

Electronics: DAE4 Sn1322; Calibrated: 8/24/2012

Phantom: SAM Sub; Type: SAM 4.0; Serial: TP-1403

Measurement SW: DASY4, Version 4.7 (80); SEMCAD X Version 14.6.10 (7164)

2450MHz System Verification

Area Scan (6x9x1): Measurement grid: dx=12mm, dy=12mm

Zoom Scan (7x7x7)/Cube 0: Measurement grid: dx=5mm, dy=5mm, dz=5mm

Input Power = 20 dBm (100 mW)

Peak SAR (extrapolated) = 11.1 W/kg

SAR(1 g) = 5.17 W/kg

Deviation = 0.19%

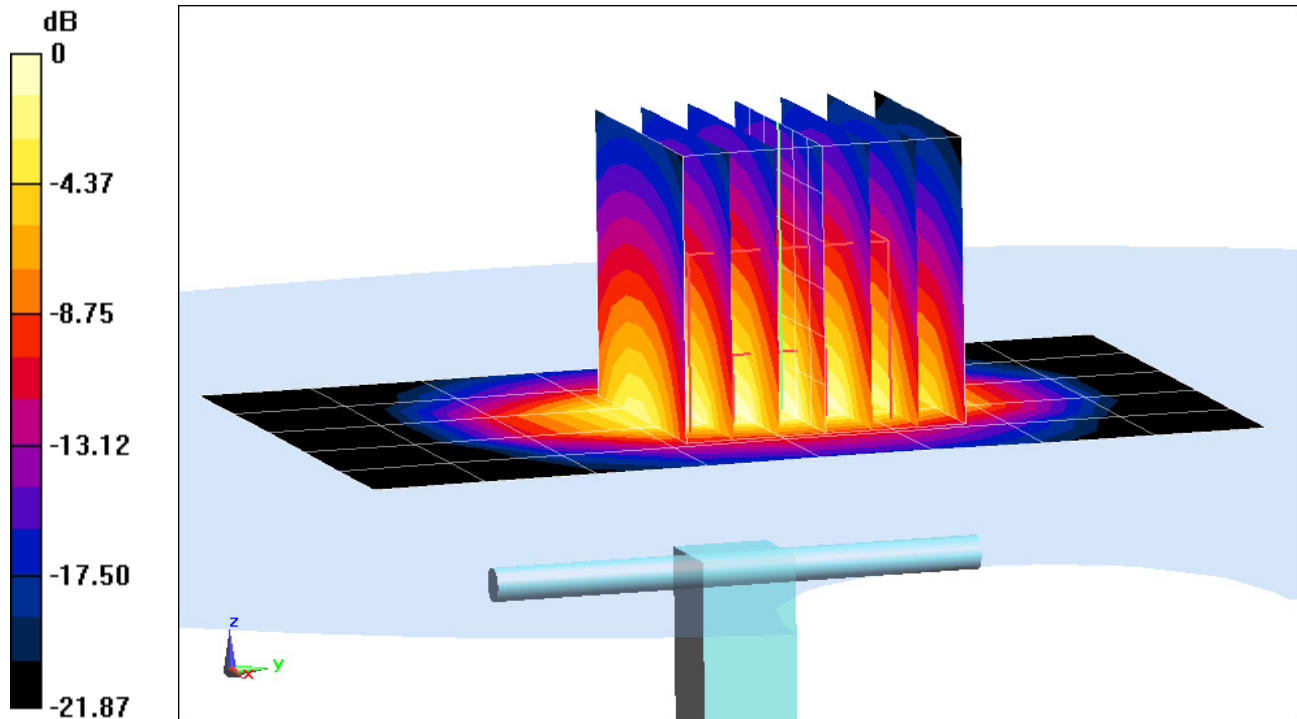

0 dB = 6.65 W/kg = 8.23 dBW/kg

PCTEST ENGINEERING LABORATORY, INC.

DUT: Dipole 2450 MHz; Type: D2450V2; Serial: 797

Communication System: CW; Frequency: 2450 MHz; Duty Cycle: 1:1

Medium: 2450 Body Medium parameters used:

$f = 2450$ MHz; $\sigma = 1.998$ S/m; $\epsilon_r = 51.321$; $\rho = 1000$ kg/m³

Phantom section: Flat Section; Space: 1.0 cm

Test Date: 07-19-2013; Ambient Temp: 24.4°C; Tissue Temp: 23.9°C

Probe: EX3DV4 - SN3920; ConvF(7.07, 7.07, 7.07); Calibrated: 2/27/2013;

Sensor-Surface: 3mm (Mechanical Surface Detection)

Electronics: DAE4 Sn649; Calibrated: 2/6/2013

Phantom: SAM 5.0 front; Type: QD000P40CD; Serial: TP:-1648

Measurement SW: DASY52, Version 52.8 (7); SEMCAD X Version 14.6.10 (7164)

2450 MHz System Verification

Area Scan (8x9x1): Measurement grid: dx=12mm, dy=12mm

Zoom Scan (7x7x7)/Cube 0: Measurement grid: dx=5mm, dy=5mm, dz=5mm

Input Power = 20 dBm (100 mW)

Peak SAR (extrapolated) = 10.3 W/kg

SAR(1 g) = 5.14 W/kg

Deviation = 3.63%

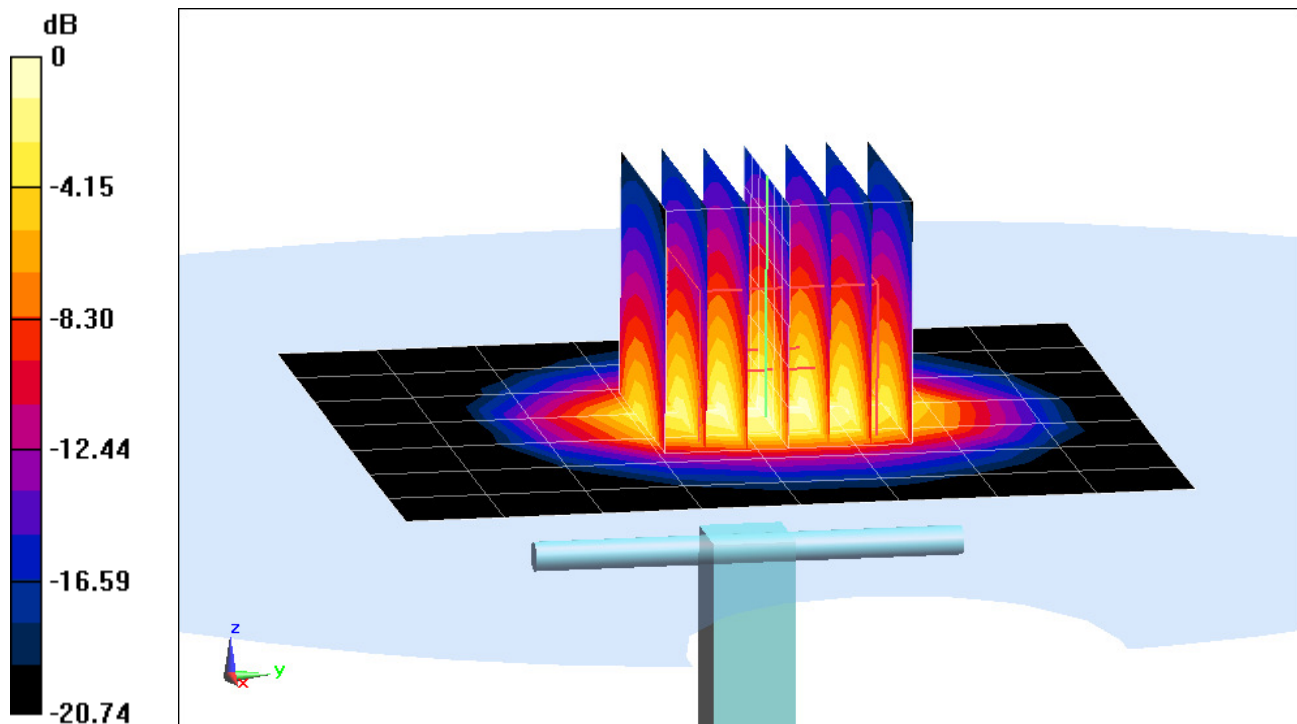

0 dB = 6.67 W/kg = 8.24 dBW/kg

PCTEST ENGINEERING LABORATORY, INC.

DUT: Dipole 2600 MHz; Type: D2600V2; Serial: 1004

Communication System: CW; Frequency: 2600 MHz; Duty Cycle: 1:1

Medium: 2450 Body Medium parameters used:

$f = 2600$ MHz; $\sigma = 2.211$ S/m; $\epsilon_r = 50.761$; $\rho = 1000$ kg/m³

Phantom section: Flat Section; Space: 1.0 cm

Test Date: 07-19-2013; Ambient Temp: 24.3°C; Tissue Temp: 23.9°C

Probe: EX3DV4 - SN3920; ConvF(6.73, 6.73, 6.73); Calibrated: 2/27/2013;

Sensor-Surface: 3mm (Mechanical Surface Detection)

Electronics: DAE4 Sn649; Calibrated: 2/6/2013

Phantom: SAM 5.0 front; Type: QD000P40CD; Serial: TP:-1648

Measurement SW: DASY52, Version 52.8 (7); SEMCAD X Version 14.6.10 (7164)

2600 MHz System Verification

Area Scan (8x9x1): Measurement grid: dx=12mm, dy=12mm

Zoom Scan (7x7x7)/Cube 0: Measurement grid: dx=5mm, dy=5mm, dz=5mm

Input Power = 20 dBm (100 mW)

Peak SAR (extrapolated) = 11.9 W/kg

SAR(1 g) = 5.74 W/kg

Deviation = -0.17%

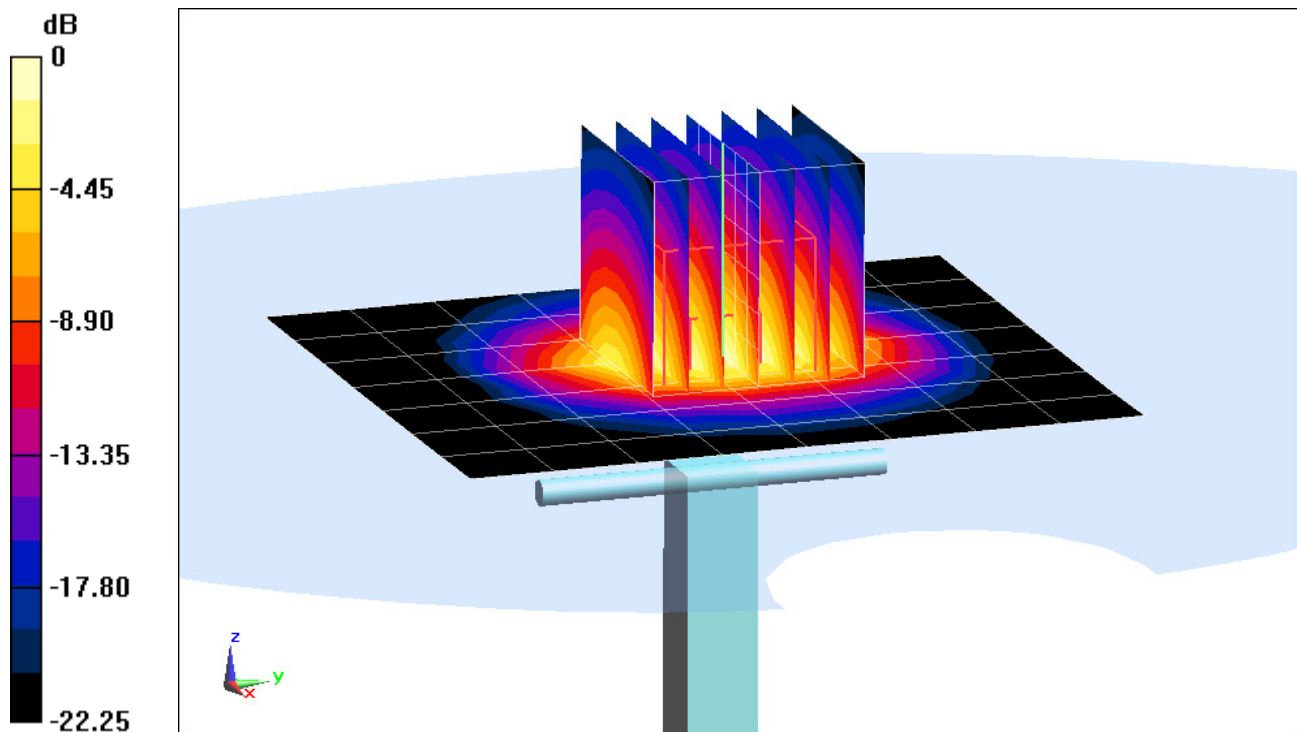

0 dB = 7.56 W/kg = 8.79 dBW/kg

PCTEST ENGINEERING LABORATORY, INC.

DUT: Dipole 5200 MHz; Type: D5GHzV2; Serial: 1057

Communication System: CW; Frequency: 5200 MHz; Duty Cycle: 1:1

Medium: 5 GHz Body Medium parameters used:

$f = 5200 \text{ MHz}$; $\sigma = 5.215 \text{ S/m}$; $\epsilon_r = 46.814$; $\rho = 1000 \text{ kg/m}^3$

Phantom section: Flat Section; Space: 1.0 cm

Test Date: 07-08-2013; Ambient Temp: 24.4°C; Tissue Temp: 23.2°C

Probe: EX3DV4 - SN3589; ConvF(3.99, 3.99, 3.99); Calibrated: 1/17/2013;

Sensor-Surface: 1.4mm (Mechanical Surface Detection)

Electronics: DAE4 Sn1272; Calibrated: 1/17/2013

Phantom: SAM Sub; Type: SAM 4.0; Serial: TP-1357

Measurement SW: DASY4, Version 4.7 (80); SEMCAD X Version 14.6.10 (7164)

5200MHz System Verification

Area Scan (7x9x1): Measurement grid: dx=10mm, dy=10mm

Zoom Scan (9x9x7)/Cube 0: Measurement grid: dx=4mm, dy=4mm, dz=1.4mm; Graded Ratio: 1.4

Input Power = 20 dBm (100 mW)

Peak SAR (extrapolated) = 28.5 W/kg

SAR(1 g) = 7.16 W/kg

Deviation = -5.17%

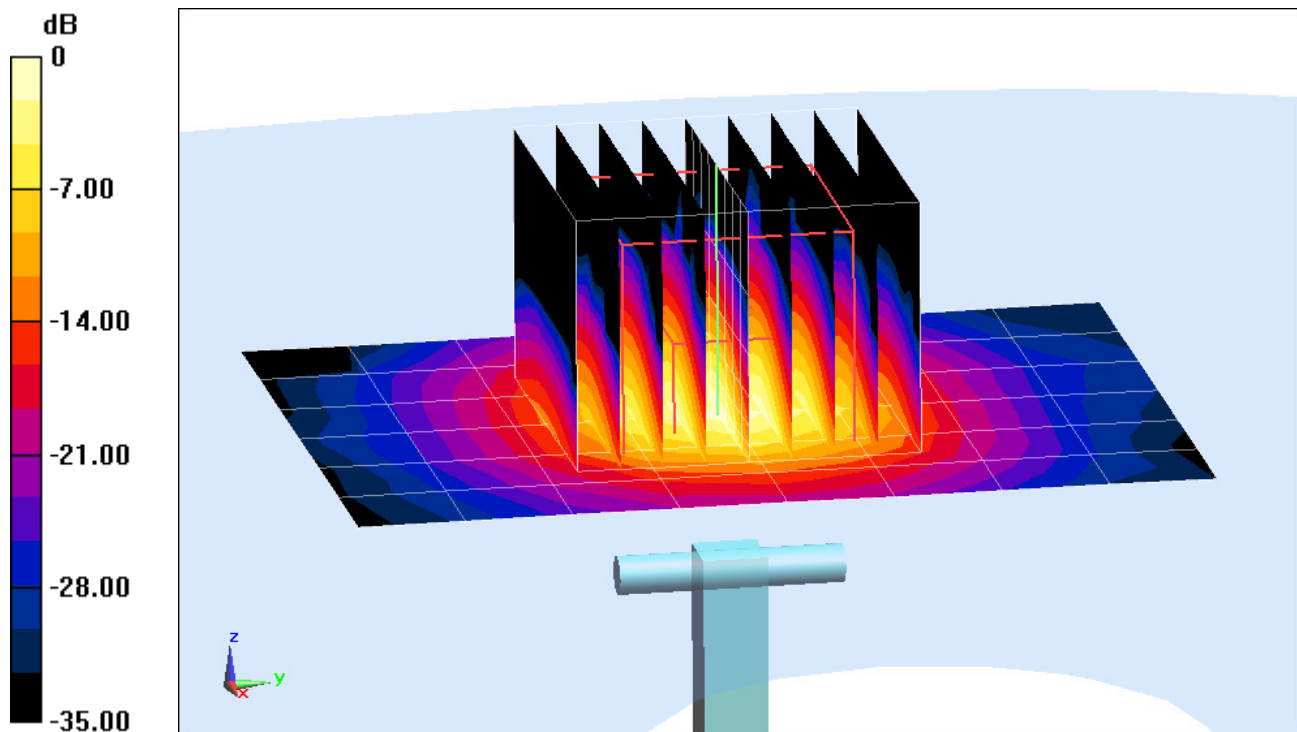

0 dB = 17.5 W/kg = 12.43 dBW/kg

PCTEST ENGINEERING LABORATORY, INC.

DUT: Dipole 5300 MHz; Type: D5GHzV2; Serial: 1057

Communication System: CW; Frequency: 5300 MHz; Duty Cycle: 1:1

Medium: 5 GHz Body Medium parameters used:

$f = 5300 \text{ MHz}$; $\sigma = 5.366 \text{ S/m}$; $\epsilon_r = 46.619$; $\rho = 1000 \text{ kg/m}^3$

Phantom section: Flat Section; Space: 1.0 cm

Test Date: 07-08-2013; Ambient Temp: 24.4°C; Tissue Temp: 23.2°C

Probe: EX3DV4 - SN3589; ConvF(3.81, 3.81, 3.81); Calibrated: 1/17/2013;

Sensor-Surface: 1.4mm (Mechanical Surface Detection)

Electronics: DAE4 Sn1272; Calibrated: 1/17/2013

Phantom: SAM Sub; Type: SAM 4.0; Serial: TP-1357

Measurement SW: DASY4, Version 4.7 (80); SEMCAD X Version 14.6.10 (7164)

5300MHz System Verification

Area Scan (7x9x1): Measurement grid: dx=10mm, dy=10mm

Zoom Scan (9x9x7)/Cube 0: Measurement grid: dx=4mm, dy=4mm, dz=1.4mm; Graded Ratio: 1.4

Input Power = 20 dBm (100 mW)

Peak SAR (extrapolated) = 32.6 W/kg

SAR(1 g) = 7.87 W/kg

Deviation = 4.52%

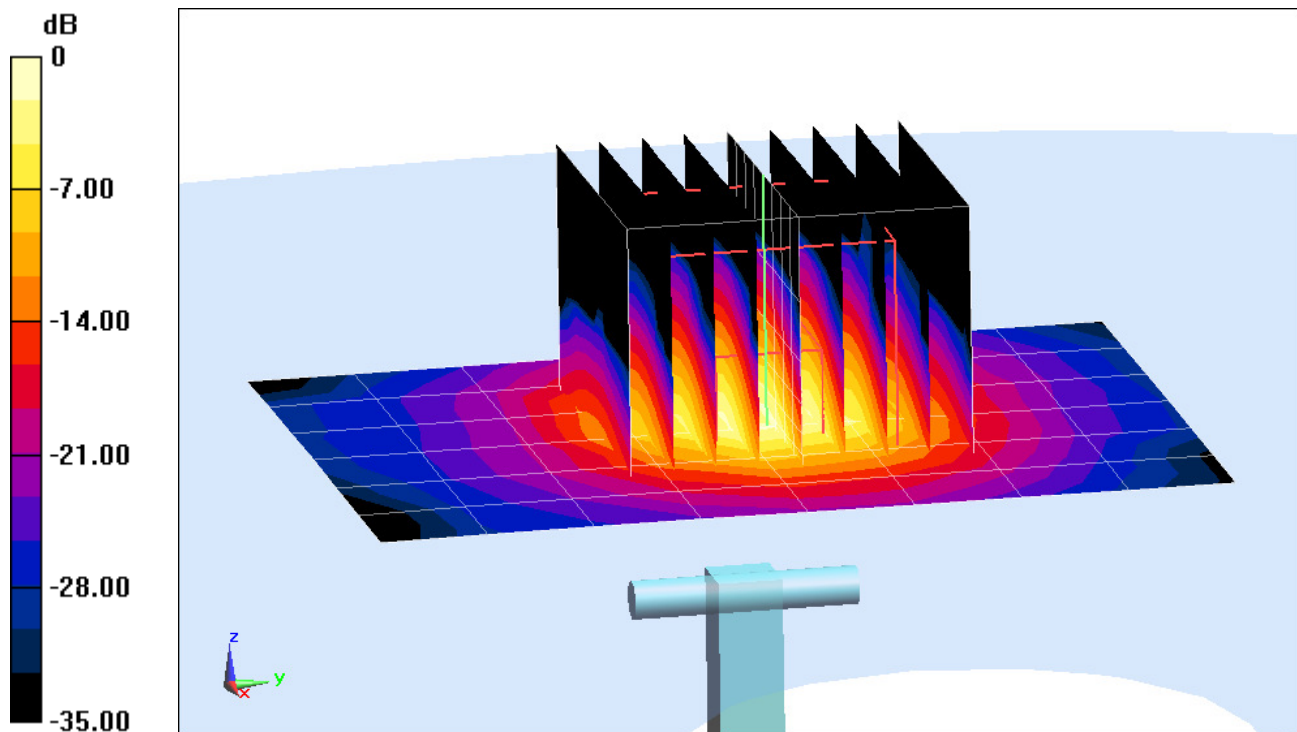

0 dB = 18.8 W/kg = 12.74 dBW/kg

PCTEST ENGINEERING LABORATORY, INC.

DUT: Dipole 5500 MHz; Type: D5GHzV2; Serial: 1057

Communication System: CW; Frequency: 5500 MHz; Duty Cycle: 1:1

Medium: 5 GHz Body Medium parameters used:

$f = 5500$ MHz; $\sigma = 5.721$ S/m; $\epsilon_r = 46.329$; $\rho = 1000$ kg/m³

Phantom section: Flat Section; Space: 1.0 cm

Test Date: 07-08-2013; Ambient Temp: 24.4°C; Tissue Temp: 23.2°C

Probe: EX3DV4 - SN3589; ConvF(3.52, 3.52, 3.52); Calibrated: 1/17/2013;

Sensor-Surface: 1.4mm (Mechanical Surface Detection)

Electronics: DAE4 Sn1272; Calibrated: 1/17/2013

Phantom: SAM Sub; Type: SAM 4.0; Serial: TP-1357

Measurement SW: DASY4, Version 4.7 (80); SEMCAD X Version 14.6.10 (7164)

5500MHz System Verification

Area Scan (7x9x1): Measurement grid: dx=10mm, dy=10mm

Zoom Scan (9x9x7)/Cube 0: Measurement grid: dx=4mm, dy=4mm, dz=1.4mm; Graded Ratio: 1.4

Input Power = 20 dBm (100 mW)

Peak SAR (extrapolated) = 39.0 W/kg

SAR(1 g) = 8.08 W/kg

Deviation = 0.00%

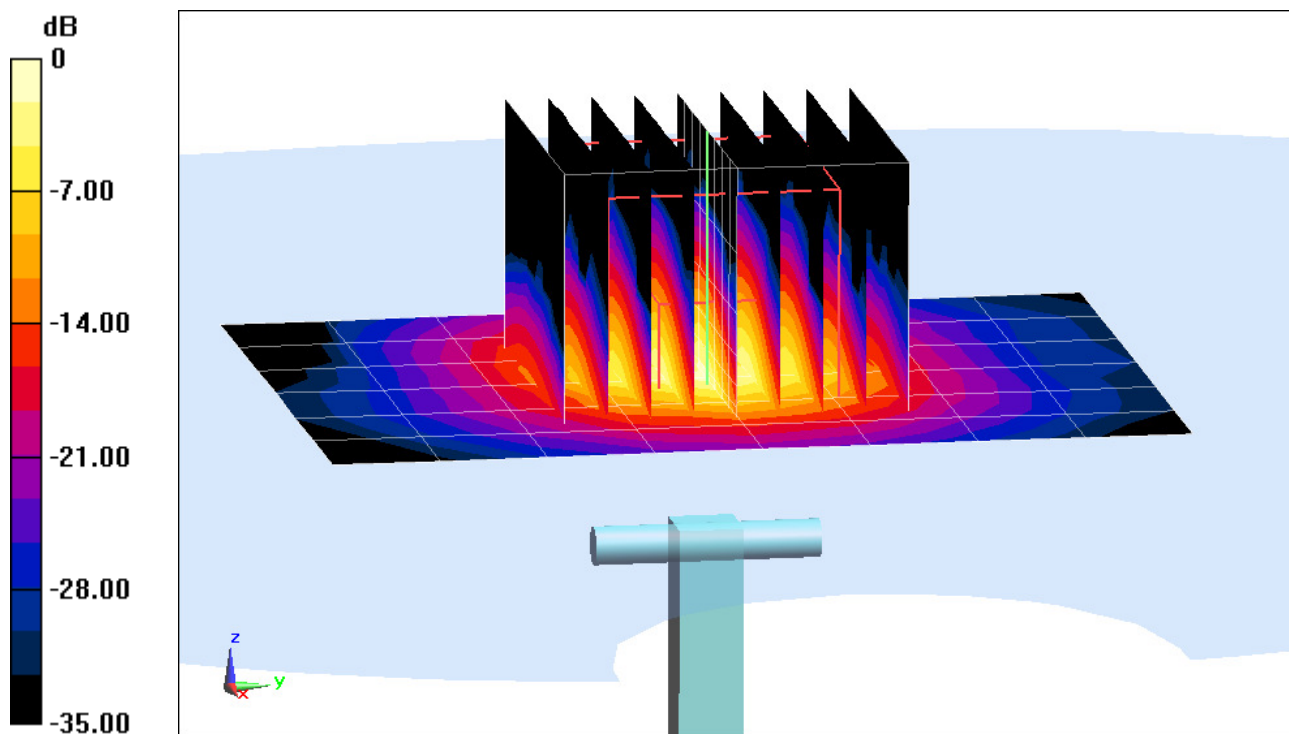

0 dB = 21.4 W/kg = 13.30 dBW/kg

PCTEST ENGINEERING LABORATORY, INC.

DUT: Dipole 5600 MHz; Type: D5GHzV2; Serial: 1057

Communication System: CW; Frequency: 5600 MHz; Duty Cycle: 1:1

Medium: 5 GHz Body Medium parameters used:

$f = 5600$ MHz; $\sigma = 5.899$ S/m; $\epsilon_r = 46.249$; $\rho = 1000$ kg/m³

Phantom section: Flat Section; Space: 1.0 cm

Test Date: 07-08-2013; Ambient Temp: 24.5°C; Tissue Temp: 23.4°C

Probe: EX3DV4 - SN3589; ConvF(3.32, 3.32, 3.32); Calibrated: 1/17/2013;

Sensor-Surface: 1.4mm (Mechanical Surface Detection)

Electronics: DAE4 Sn1272; Calibrated: 1/17/2013

Phantom: SAM Sub; Type: SAM 4.0; Serial: TP-1357

Measurement SW: DASY4, Version 4.7 (80); SEMCAD X Version 14.6.10 (7164)

5600MHz System Verification

Area Scan (7x9x1): Measurement grid: dx=10mm, dy=10mm

Zoom Scan (9x9x7)/Cube 0: Measurement grid: dx=4mm, dy=4mm, dz=1.4mm; Graded Ratio: 1.4

Input Power = 20 dBm (100 mW)

Peak SAR (extrapolated) = 31.5 W/kg

SAR(1 g) = 7.89 W/kg

Deviation = -1.74%

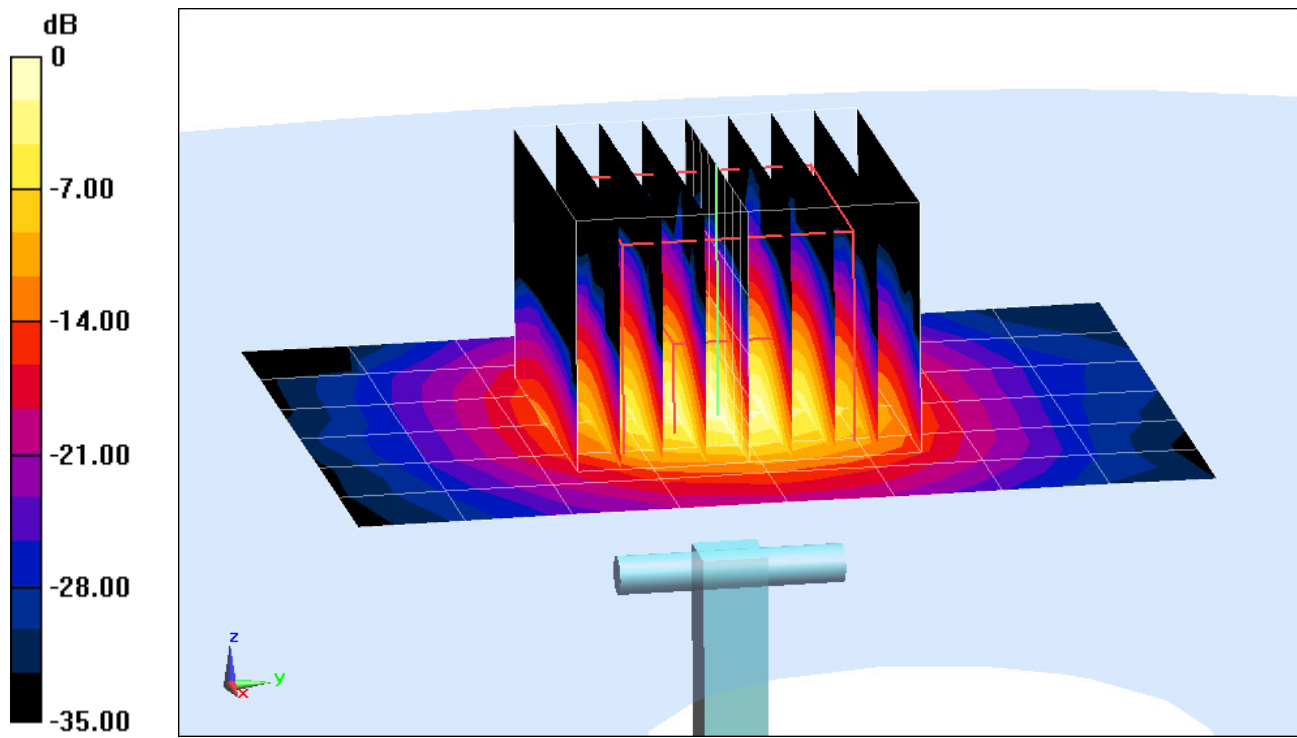

0 dB = 19.9 W/kg = 12.99 dBW/kg

PCTEST ENGINEERING LABORATORY, INC.

DUT: Dipole 5800 MHz; Type: D5GHzV2; Serial: 1057

Communication System: CW; Frequency: 5800 MHz; Duty Cycle: 1:1

Medium: 5 GHz Body Medium parameters used:

$f = 5800 \text{ MHz}$; $\sigma = 6.218 \text{ S/m}$; $\epsilon_r = 46.037$; $\rho = 1000 \text{ kg/m}^3$

Phantom section: Flat Section; Space: 1.0 cm

Test Date: 07-08-2013; Ambient Temp: 24.5°C; Tissue Temp: 23.4°C

Probe: EX3DV4 - SN3589; ConvF(3.66, 3.66, 3.66); Calibrated: 1/17/2013;

Sensor-Surface: 1.4mm (Mechanical Surface Detection)

Electronics: DAE4 Sn1272; Calibrated: 1/17/2013

Phantom: SAM Sub; Type: SAM 4.0; Serial: TP-1357

Measurement SW: DASY52, Version 52.8 (7); SEMCAD X Version 14.6.10 (7164)

5800MHz System Verification

Area Scan (7x9x1): Measurement grid: dx=10mm, dy=10mm

Zoom Scan (9x9x7)/Cube 0: Measurement grid: dx=4mm, dy=4mm, dz=1.4mm; Graded Ratio: 1.4

Input Power = 20 dBm (100 mW)

Peak SAR (extrapolated) = 31.7 W/kg

SAR(1 g) = 7.33 W/kg

Deviation = -2.40%

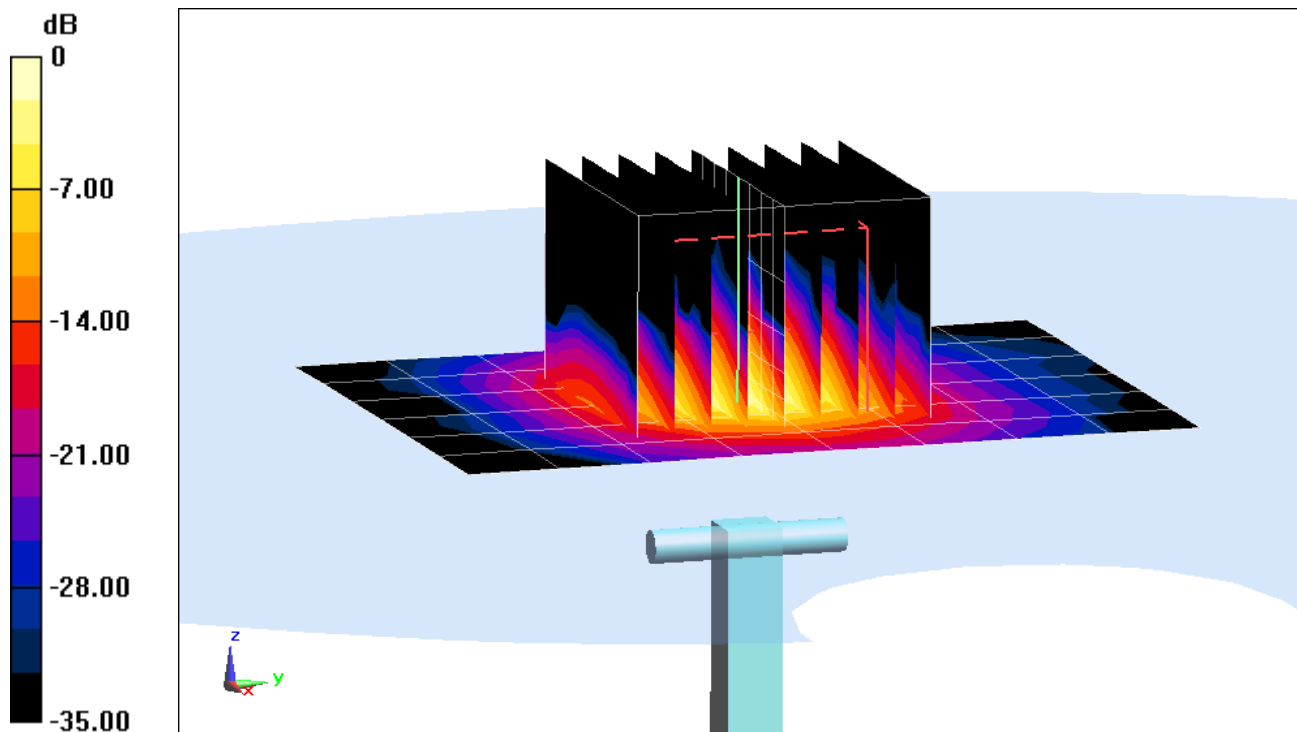

0 dB = 18.7 W/kg = 12.72 dBW/kg

APPENDIX C: PROBE CALIBRATION



Accredited by the Swiss Accreditation Service (SAS)
The Swiss Accreditation Service is one of the signatories to the EA
Multilateral Agreement for the recognition of calibration certificates

Accreditation No.: **SCS 108**

Client **PC Test**

Certificate No: **ES3-3022_Aug12**

CALIBRATION CERTIFICATE

Object **ES3DV2 - SN:3022**

Calibration procedure(s) **QA CAL-01.v8, QA CAL-23.v4, QA CAL-25.v4
Calibration procedure for dosimetric E-field probes**

Calibration date: **August 28, 2012**

This calibration certificate documents the traceability to national standards, which realize the physical units of measurements (SI).
The measurements and the uncertainties with confidence probability are given on the following pages and are part of the certificate.

All calibrations have been conducted in the closed laboratory facility: environment temperature (22 ± 3)°C and humidity < 70%.

Calibration Equipment used (M&TE critical for calibration)

*✓
Kok
7/10*

| Primary Standards | ID | Cal Date (Certificate No.) | Scheduled Calibration |
|----------------------------|-----------------|-----------------------------------|------------------------|
| Power meter E4419B | GB41293874 | 29-Mar-12 (No. 217-01508) | Apr-13 |
| Power sensor E4412A | MY41498087 | 29-Mar-12 (No. 217-01508) | Apr-13 |
| Reference 3 dB Attenuator | SN: S5054 (3c) | 27-Mar-12 (No. 217-01531) | Apr-13 |
| Reference 20 dB Attenuator | SN: S5086 (20b) | 27-Mar-12 (No. 217-01529) | Apr-13 |
| Reference 30 dB Attenuator | SN: S5129 (30b) | 27-Mar-12 (No. 217-01532) | Apr-13 |
| Reference Probe ES3DV2 | SN: 3013 | 29-Dec-11 (No. ES3-3013_Dec11) | Dec-12 |
| DAE4 | SN: 660 | 20-Jun-12 (No. DAE4-660_Jun12) | Jun-13 |
| Secondary Standards | ID | Check Date (in house) | Scheduled Check |
| RF generator HP 8648C | US3642U01700 | 4-Aug-99 (in house check Apr-11) | In house check: Apr-13 |
| Network Analyzer HP 8753E | US37390585 | 18-Oct-01 (in house check Oct-11) | In house check: Oct-12 |

| | | | |
|----------------|-------------------------------|--|---------------|
| Calibrated by: | Name Jeton Kastrati | Function Laboratory Technician | Signature |
| Approved by: | Name Katja Pokovic | Function Technical Manager | Signature |

Issued: August 28, 2012

This calibration certificate shall not be reproduced except in full without written approval of the laboratory.



Accredited by the Swiss Accreditation Service (SAS)

Accreditation No.: **SCS 108**

The Swiss Accreditation Service is one of the signatories to the EA
Multilateral Agreement for the recognition of calibration certificates

Glossary:

| | |
|--------------------------|---|
| TSL | tissue simulating liquid |
| NORM _{x,y,z} | sensitivity in free space |
| ConvF | sensitivity in TSL / NORM _{x,y,z} |
| DCP | diode compression point |
| CF | crest factor (1/duty_cycle) of the RF signal |
| A, B, C | modulation dependent linearization parameters |
| Polarization ϕ | ϕ rotation around probe axis |
| Polarization ϑ | ϑ rotation around an axis that is in the plane normal to probe axis (at measurement center), i.e., $\vartheta = 0$ is normal to probe axis |

Calibration is Performed According to the Following Standards:

- IEEE Std 1528-2003, "IEEE Recommended Practice for Determining the Peak Spatial-Averaged Specific Absorption Rate (SAR) in the Human Head from Wireless Communications Devices: Measurement Techniques", December 2003
- IEC 62209-1, "Procedure to measure the Specific Absorption Rate (SAR) for hand-held devices used in close proximity to the ear (frequency range of 300 MHz to 3 GHz)", February 2005

Methods Applied and Interpretation of Parameters:

- NORM_{x,y,z}**: Assessed for E-field polarization $\vartheta = 0$ ($f \leq 900$ MHz in TEM-cell; $f > 1800$ MHz: R22 waveguide). NORM_{x,y,z} are only intermediate values, i.e., the uncertainties of NORM_{x,y,z} does not affect the E²-field uncertainty inside TSL (see below ConvF).
- NORM(f)_{x,y,z}** = NORM_{x,y,z} * frequency_response (see Frequency Response Chart). This linearization is implemented in DASY4 software versions later than 4.2. The uncertainty of the frequency response is included in the stated uncertainty of ConvF.
- DCP_{x,y,z}**: DCP are numerical linearization parameters assessed based on the data of power sweep with CW signal (no uncertainty required). DCP does not depend on frequency nor media.
- PAR**: PAR is the Peak to Average Ratio that is not calibrated but determined based on the signal characteristics
- A_{x,y,z}; B_{x,y,z}; C_{x,y,z}; VR_{x,y,z}**: A, B, C are numerical linearization parameters assessed based on the data of power sweep for specific modulation signal. The parameters do not depend on frequency nor media. VR is the maximum calibration range expressed in RMS voltage across the diode.
- ConvF and Boundary Effect Parameters**: Assessed in flat phantom using E-field (or Temperature Transfer Standard for $f \leq 800$ MHz) and inside waveguide using analytical field distributions based on power measurements for $f > 800$ MHz. The same setups are used for assessment of the parameters applied for boundary compensation (alpha, depth) of which typical uncertainty values are given. These parameters are used in DASY4 software to improve probe accuracy close to the boundary. The sensitivity in TSL corresponds to NORM_{x,y,z} * ConvF whereby the uncertainty corresponds to that given for ConvF. A frequency dependent ConvF is used in DASY version 4.4 and higher which allows extending the validity from ± 50 MHz to ± 100 MHz.
- Spherical isotropy (3D deviation from isotropy)**: in a field of low gradients realized using a flat phantom exposed by a patch antenna.
- Sensor Offset**: The sensor offset corresponds to the offset of virtual measurement center from the probe tip (on probe axis). No tolerance required.

Probe ES3DV2

SN:3022

Manufactured: April 15, 2003
Calibrated: August 28, 2012

Calibrated for DASY/EASY Systems
(Note: non-compatible with DASY2 system!)

DASY/EASY - Parameters of Probe: ES3DV2 - SN:3022

Basic Calibration Parameters

| | Sensor X | Sensor Y | Sensor Z | Unc (k=2) |
|---|----------|----------|----------|---------------|
| Norm ($\mu\text{V}/(\text{V}/\text{m})^2$) ^A | 1.00 | 1.04 | 0.99 | $\pm 10.1 \%$ |
| DCP (mV) ^B | 98.3 | 99.5 | 101.3 | |

Modulation Calibration Parameters

| UID | Communication System Name | PAR | | A dB | B dB | C dB | VR mV | Unc ^E (k=2) |
|-----|---------------------------|------|---|---------|---------|---------|----------|---------------------------|
| 0 | CW | 0.00 | X | 0.00 | 0.00 | 1.00 | 133.3 | $\pm 2.7 \%$ |
| | | | Y | 0.00 | 0.00 | 1.00 | 140.3 | |
| | | | Z | 0.00 | 0.00 | 1.00 | 178.9 | |

The reported uncertainty of measurement is stated as the standard uncertainty of measurement multiplied by the coverage factor k=2, which for a normal distribution corresponds to a coverage probability of approximately 95%.

^A The uncertainties of NormX,Y,Z do not affect the E²-field uncertainty inside TSL (see Pages 5 and 6).

^B Numerical linearization parameter: uncertainty not required.

^E Uncertainty is determined using the max. deviation from linear response applying rectangular distribution and is expressed for the square of the field value.

DASY/EASY - Parameters of Probe: ES3DV2 - SN:3022

Calibration Parameter Determined in Head Tissue Simulating Media

| f (MHz) ^C | Relative Permittivity ^F | Conductivity (S/m) ^F | ConvF X | ConvF Y | ConvF Z | Alpha | Depth (mm) | Unct. (k=2) |
|----------------------|------------------------------------|---------------------------------|---------|---------|---------|-------|------------|-------------|
| 750 | 41.9 | 0.89 | 6.30 | 6.30 | 6.30 | 0.30 | 1.72 | ± 12.0 % |
| 835 | 41.5 | 0.90 | 6.03 | 6.03 | 6.03 | 0.35 | 1.63 | ± 12.0 % |
| 1750 | 40.1 | 1.37 | 5.07 | 5.07 | 5.07 | 0.32 | 1.89 | ± 12.0 % |
| 1900 | 40.0 | 1.40 | 4.86 | 4.86 | 4.86 | 0.40 | 1.57 | ± 12.0 % |
| 2450 | 39.2 | 1.80 | 4.23 | 4.23 | 4.23 | 0.59 | 1.44 | ± 12.0 % |
| 2600 | 39.0 | 1.96 | 4.10 | 4.10 | 4.10 | 0.67 | 1.37 | ± 12.0 % |

^C Frequency validity of ± 100 MHz only applies for DASY v4.4 and higher (see Page 2), else it is restricted to ± 50 MHz. The uncertainty is the RSS of the ConvF uncertainty at calibration frequency and the uncertainty for the indicated frequency band.

^F At frequencies below 3 GHz, the validity of tissue parameters (ϵ and σ) can be relaxed to ± 10% if liquid compensation formula is applied to measured SAR values. At frequencies above 3 GHz, the validity of tissue parameters (ϵ and σ) is restricted to ± 5%. The uncertainty is the RSS of the ConvF uncertainty for indicated target tissue parameters.

DASY/EASY - Parameters of Probe: ES3DV2 - SN:3022

Calibration Parameter Determined in Body Tissue Simulating Media

| f (MHz) ^C | Relative Permittivity ^F | Conductivity (S/m) ^F | ConvF X | ConvF Y | ConvF Z | Alpha | Depth (mm) | Unct. (k=2) |
|----------------------|------------------------------------|---------------------------------|---------|---------|---------|-------|------------|-------------|
| 750 | 55.5 | 0.96 | 6.07 | 6.07 | 6.07 | 0.23 | 2.09 | ± 12.0 % |
| 835 | 55.2 | 0.97 | 6.02 | 6.02 | 6.02 | 0.47 | 1.44 | ± 12.0 % |
| 1750 | 53.4 | 1.49 | 4.70 | 4.70 | 4.70 | 0.46 | 1.55 | ± 12.0 % |
| 1900 | 53.3 | 1.52 | 4.43 | 4.43 | 4.43 | 0.36 | 1.87 | ± 12.0 % |
| 2450 | 52.7 | 1.95 | 3.97 | 3.97 | 3.97 | 0.65 | 1.06 | ± 12.0 % |
| 2600 | 52.5 | 2.16 | 3.80 | 3.80 | 3.80 | 0.54 | 0.75 | ± 12.0 % |

^C Frequency validity of ± 100 MHz only applies for DASY v4.4 and higher (see Page 2), else it is restricted to ± 50 MHz. The uncertainty is the RSS of the ConvF uncertainty at calibration frequency and the uncertainty for the indicated frequency band.

^F At frequencies below 3 GHz, the validity of tissue parameters (ϵ and σ) can be relaxed to ± 10% if liquid compensation formula is applied to measured SAR values. At frequencies above 3 GHz, the validity of tissue parameters (ϵ and σ) is restricted to ± 5%. The uncertainty is the RSS of the ConvF uncertainty for indicated target tissue parameters.

Frequency Response of E-Field (TEM-Cell:ifi110 EXX, Waveguide: R22)

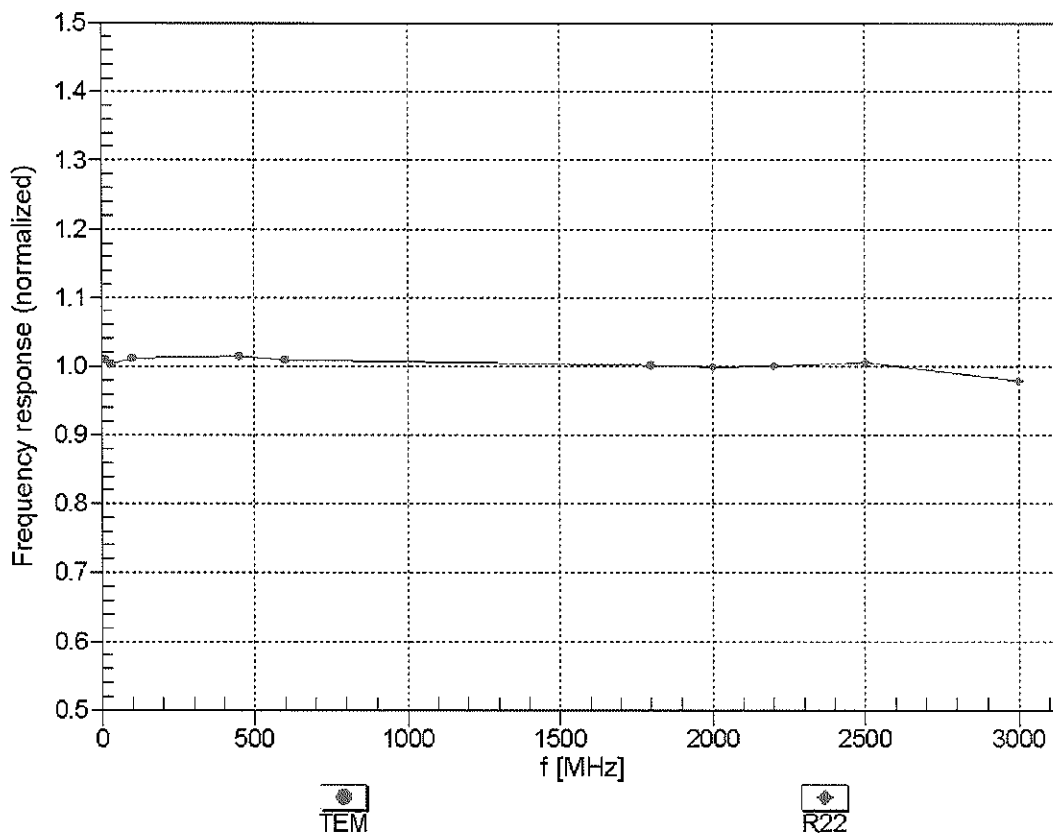

Uncertainty of Frequency Response of E-field: $\pm 6.3\%$ (k=2)

Receiving Pattern (ϕ), $\theta = 0^\circ$

f=600 MHz,TEM

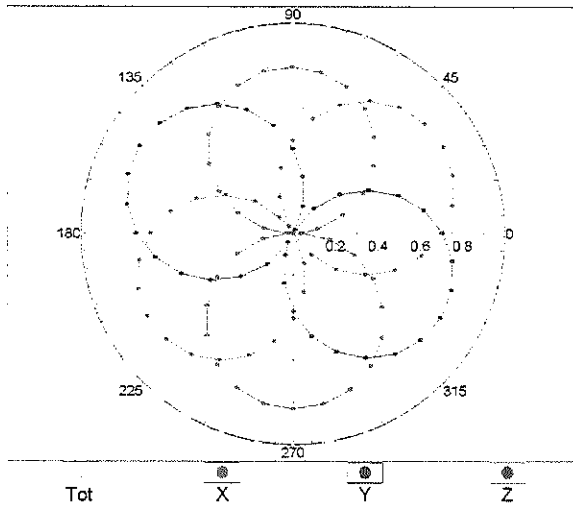

f=1800 MHz,R22

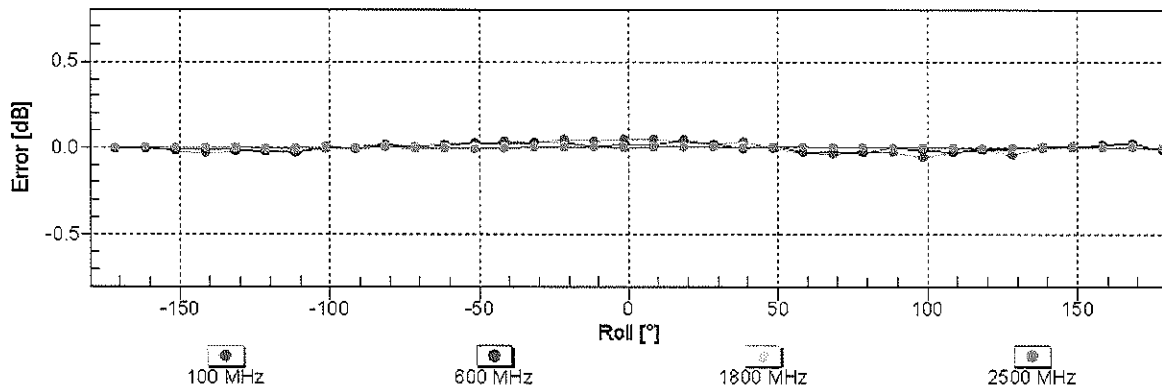
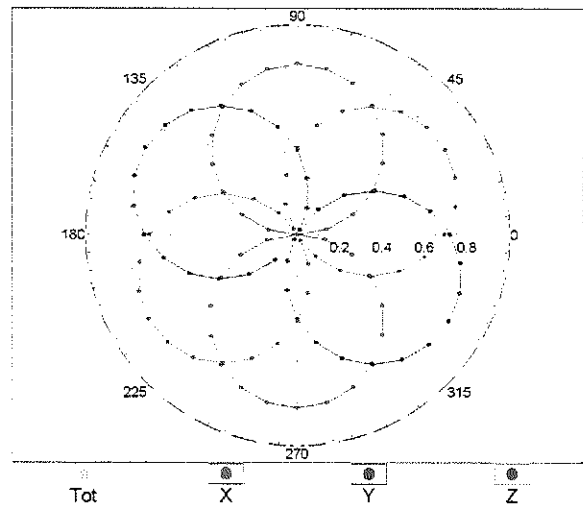

Uncertainty of Axial Isotropy Assessment: $\pm 0.5\%$ (k=2)

Dynamic Range $f(\text{SAR}_{\text{head}})$ (TEM cell , $f = 900 \text{ MHz}$)

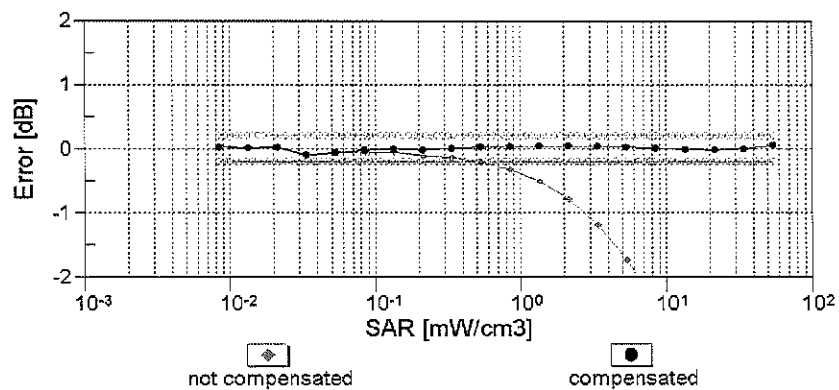
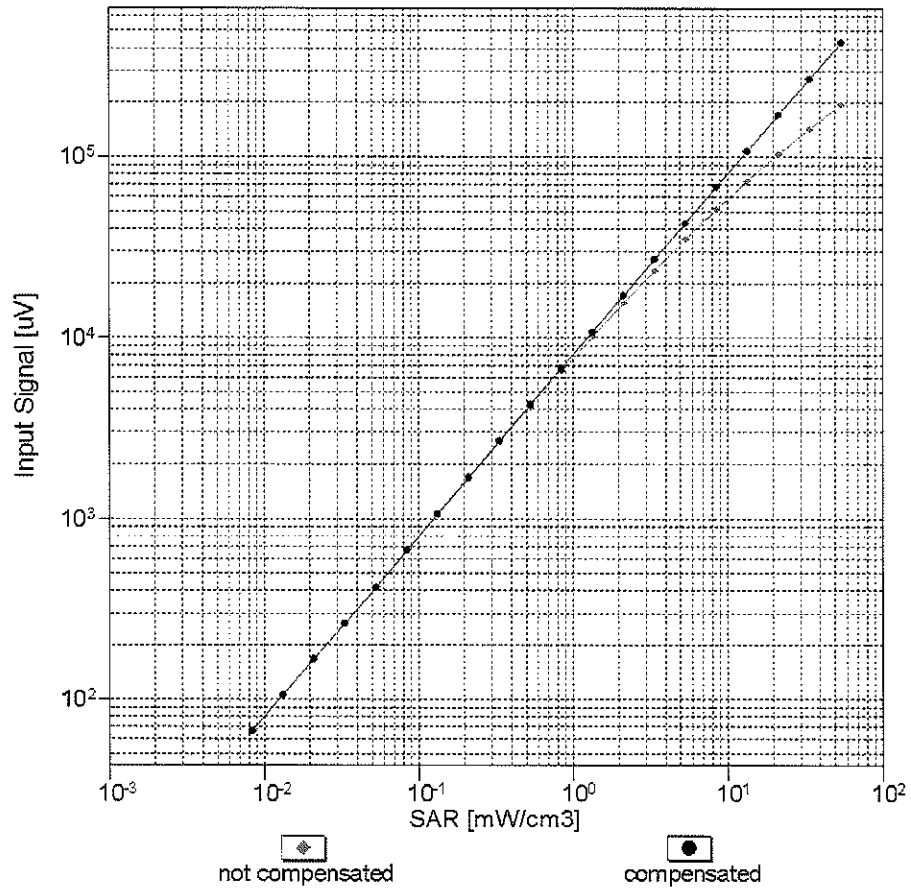

Uncertainty of Linearity Assessment: $\pm 0.6\%$ ($k=2$)

Conversion Factor Assessment

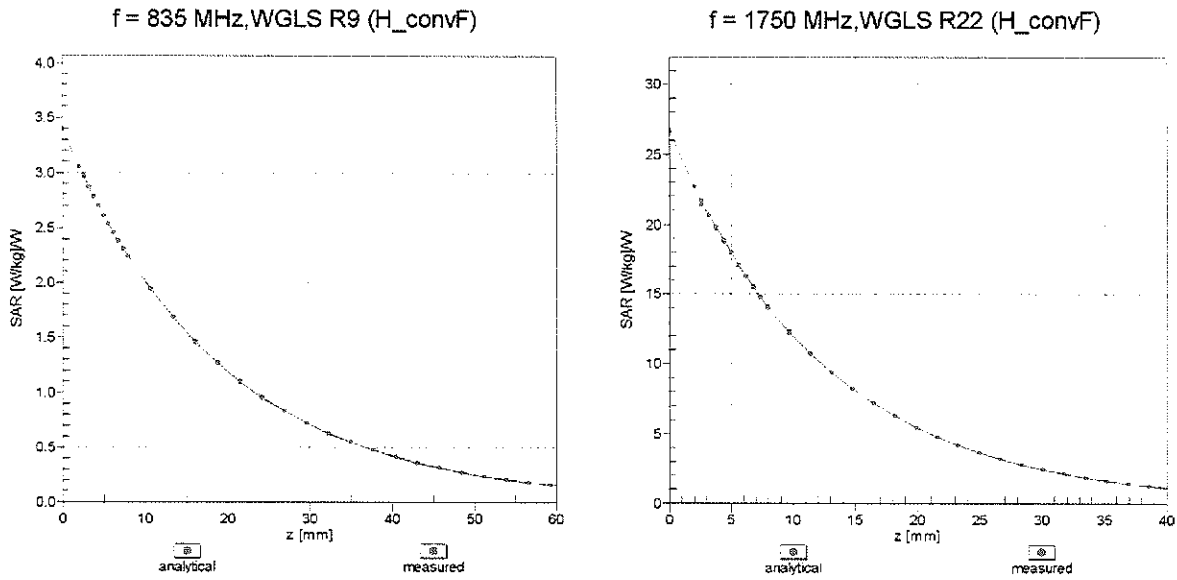

Deviation from Isotropy in Liquid Error (ϕ, θ), f = 900 MHz

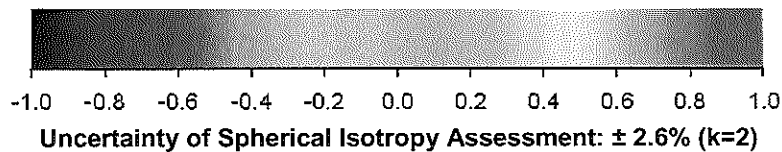
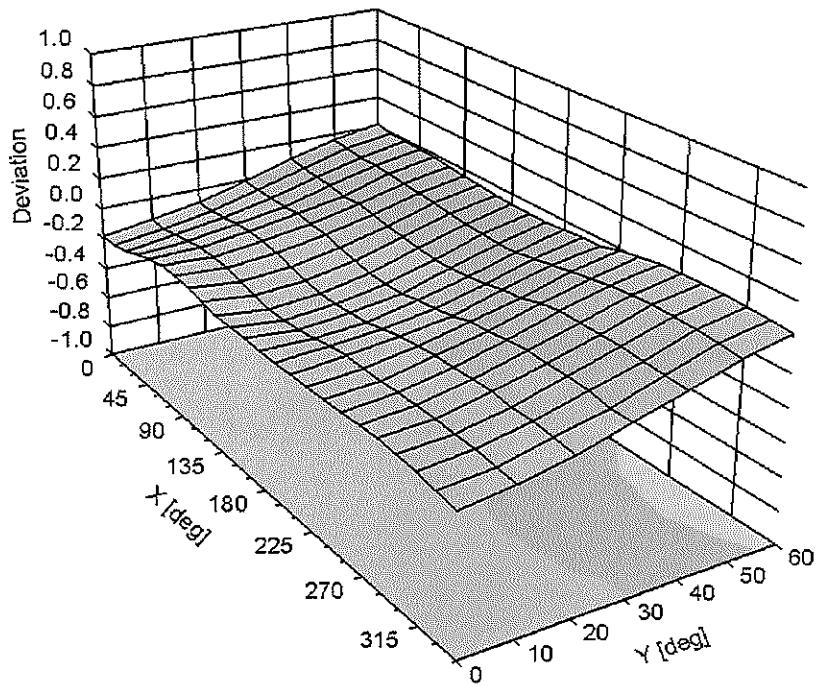

DASY/EASY - Parameters of Probe: ES3DV2 - SN:3022

Other Probe Parameters

| | |
|---|------------|
| Sensor Arrangement | Triangular |
| Connector Angle (°) | 98.5 |
| Mechanical Surface Detection Mode | enabled |
| Optical Surface Detection Mode | disabled |
| Probe Overall Length | 337 mm |
| Probe Body Diameter | 10 mm |
| Tip Length | 10 mm |
| Tip Diameter | 4 mm |
| Probe Tip to Sensor X Calibration Point | 2 mm |
| Probe Tip to Sensor Y Calibration Point | 2 mm |
| Probe Tip to Sensor Z Calibration Point | 2 mm |
| Recommended Measurement Distance from Surface | 3 mm |