



**FCC CFR47 PART 22 SUBPART H**

**WWAN**

**CERTIFICATION TEST REPORT**

**FOR**

**LTE Phone + Bluetooth/BLE and DTS b/g/n**

**MODEL NUMBER : SM-Z400F/DS**

**FCC ID: A3LSMZ400F**

**REPORT NUMBER: 4787852400-E4V1**

**ISSUE DATE: MAR 07, 2017**

*Prepared for*  
**SAMSUNG ELECTRONICS CO., LTD.**  
**129 SAMSUNG-RO, YEONGTONG-GU, SUWON-SI,**  
**GYEONGGI-DO, 16677, KOREA**

*Prepared by*  
**UL Korea, Ltd. Suwon Laboratory**  
**218 Maeyeong-ro, Yeongtong-gu,**  
**Suwon-si, Gyeonggi-do, 16675, Korea**  
**TEL: (031) 337-9902**  
**FAX: (031) 213-5433**



Revision History

<u>Rev.</u>	<u>Issue Date</u>	<u>Revisions</u>	<u>Revised By</u>
V1	03/07/17	Initial issue	Junwhan Lee

## TABLE OF CONTENTS

<b>1. ATTESTATION OF TEST RESULTS</b> .....	<b>5</b>
<b>2. TEST METHODOLOGY</b> .....	<b>6</b>
<b>3. FACILITIES AND ACCREDITATION</b> .....	<b>6</b>
<b>4. CALIBRATION AND UNCERTAINTY</b> .....	<b>6</b>
4.1. <i>MEASURING INSTRUMENT CALIBRATION</i> .....	6
4.2. <i>SAMPLE CALCULATION</i> .....	6
4.3. <i>MEASUREMENT UNCERTAINTY</i> .....	7
<b>5. EQUIPMENT UNDER TEST</b> .....	<b>8</b>
5.1. <i>DESCRIPTION OF EUT</i> .....	8
5.2. <i>MAXIMUM OUTPUT POWER (LTE)</i> .....	8
5.3. <i>DESCRIPTION OF TEST SETUP</i> .....	10
<b>6. TEST AND MEASUREMENT EQUIPMENT</b> .....	<b>12</b>
<b>7. Summary Table</b> .....	<b>13</b>
<b>8. RF POWER OUTPUT VERIFICATION</b> .....	<b>14</b>
8.1. <i>LTE OUTPUT VERIFICATION</i> .....	14
8.1.1. <i>LTE OUTPUT POWER RESULT</i> .....	15
<b>9. PEAK TO AVERAGE RATIO</b> .....	<b>16</b>
9.1. <i>CONDUCTED PEAK TO AVERAGE RESULT</i> .....	16
9.2. <i>CONDUCTED PEAK TO AVERAGE PLOTS</i> .....	17
<b>10. LIMITS AND CONDUCTED RESULTS</b> .....	<b>18</b>
10.1. <i>OCCUPIED BANDWIDTH</i> .....	18
10.1.1. <i>OCCUPIED BANDWIDTH RESULTS</i> .....	19
10.1.2. <i>OCCUPIED BANDWIDTH PLOTS</i> .....	20
10.2. <i>BAND EDGE EMISSIONS</i> .....	24
10.2.1. <i>BAND EDGE PLOTS</i> .....	26
10.3. <i>OUT OF BAND EMISSIONS</i> .....	30
10.3.1. <i>OUT OF BAND EMISSIONS RESULT</i> .....	31
10.3.2. <i>OUT OF BAND EMISSIONS PLOTS</i> .....	32
10.4. <i>FREQUENCY STABILITY</i> .....	36
10.4.1. <i>FREQUENCY STABILITY RESULTS</i> .....	37
<b>11. RADIATED TEST RESULTS</b> .....	<b>38</b>
11.1. <i>RADIATED POWER (ERP &amp; EIRP)</i> .....	38
11.1.1. <i>ERP/EIRP Results</i> .....	39

---

11.1.2.	ERP/EIRP DATA .....	40
11.2.	<i>FIELD STRENGTH OF SPURIOUS RADIATION</i> .....	44
11.2.1.	SPURIOUS RADIATION PLOTS.....	45
12.	<b>SETUP PHOTOS</b> .....	<b>49</b>

# 1. ATTESTATION OF TEST RESULTS

**COMPANY NAME:** SAMSUNG ELECTRONICS CO., LTD.  
**EUT DESCRIPTION:** LTE Phone + Bluetooth/BLE and DTS b/g/n  
**MODEL NUMBER:** SM-Z400F/DS  
**SERIAL NUMBER:** R38J10147LK (RADIATED);  
R38HC06XXSD (CONDUCTED)  
**DATE TESTED:** FEB 09, 2017 - MAR 07, 2017

APPLICABLE STANDARDS	
STANDARD	TEST RESULTS
FCC PART 22H	Pass

UL Korea, Ltd. tested the above equipment in accordance with the requirements set forth in the above standards. All indications of Pass/Fail in this report are opinions expressed by UL Korea, Ltd. based on interpretations and/or observations of test results. Measurement Uncertainties were not taken into account and are published for informational purposes only. The test results show that the equipment tested is capable of demonstrating compliance with the requirements as documented in this report.

**Note:** The results documented in this report apply only to the tested sample, under the conditions and modes of operation as described herein. This document may not be altered or revised in any way unless done so by UL Korea, Ltd. and all revisions are duly noted in the revisions section. Any alteration of this document not carried out by UL Korea, Ltd. will constitute fraud and shall nullify the document. This report must not be used by the client to claim product certification, approval, or endorsement by IAS, any agency of the Federal Government, or any agency of any government.

Approved & Released For  
UL Korea, Ltd. By:

Tested By:



SungGil Park  
Suwon Lab Engineer  
UL Korea, Ltd.

Junwhan Lee  
Suwon Lab Engineer  
UL Korea, Ltd.

## 2. TEST METHODOLOGY

The tests documented in this report were performed in accordance with following methods.

1. FCC CFR 47 Part 2.
2. FCC CFR 47 Part 22.
3. ANSI TIA-603-D
4. KDB 971168 D01 Power Meas License Digital Systems v02r02

## 3. FACILITIES AND ACCREDITATION

The test sites and measurement facilities used to collect data are located at 218 Maeyeong-ro, Yeongtong-gu, Suwon-si, Gyeonggi-do, 16675, Korea. Line conducted emissions are measured only at the 218 address. The following table identifies which facilities were utilized for radiated emission measurements documented in this report. Specific facilities are also identified in the test results sections.

218 Maeyeong-ro	
<input type="checkbox"/>	Chamber 1
<input checked="" type="checkbox"/>	Chamber 2

UL Korea, Ltd. is accredited by IAS, Laboratory Code TL-637. The full scope of accreditation can be viewed at <http://www.iasonline.org/PDF/TL/TL-637.pdf>.

## 4. CALIBRATION AND UNCERTAINTY

### 4.1. MEASURING INSTRUMENT CALIBRATION

The measuring equipment utilized to perform the tests documented in this report has been calibrated in accordance with the manufacturer's recommendations, and is traceable to recognized national standards.

### 4.2. SAMPLE CALCULATION

Where relevant, the following sample calculation is provided:

$EIRP = \text{PSA reading with EUT worst orientation (dBm)} + \text{Path loss (dB)} - \text{cable loss (between the SG and substitution antenna)} + \text{Substitution Antenna Factor (dBi)}$

$ERP = \text{PSA reading with EUT worst orientation (dBm)} + \text{Path loss (dB)} - \text{cable loss (between the SG and substitution antenna)}$

(Path loss = Signal generator output – PSA reading with substitution antenna)

### 4.3. MEASUREMENT UNCERTAINTY

Where relevant, the following measurement uncertainty levels have been estimated for tests performed on the apparatus:

PARAMETER	UNCERTAINTY
Conducted Disturbance, 0.15 to 30 MHz	2.32 dB
Radiated Disturbance, Below 1GHz	4.14 dB
Radiated Disturbance, Above 1 GHz	5.97 dB

Uncertainty figures are valid to a confidence level of 95%.

## 5. EQUIPMENT UNDER TEST

### 5.1. DESCRIPTION OF EUT

The EUT is a LTE Phone + Bluetooth/BLE and DTS b/g/n.

### 5.2. MAXIMUM OUTPUT POWER (LTE)

The transmitter has a maximum peak conducted and radiated ERP / EIRP output powers as follows:

#### LTE Band 5

FCC Part 22							
Band	Frequency Range [MHz]	BandWidth [MHz]	Modulation Peak	Conducted		Radiated	
				Avg [dBm]	Avg [mW]	Avg [dBm]	Avg [mW]
Band 5	824 ~ 849	10	QPSK	23.12	205.12	16.50	44.67
			16QAM	21.65	146.22	15.85	38.46
		5	QPSK	23.28	212.81	16.94	49.43
			16QAM	21.62	145.21	16.16	41.30
		3	QPSK	23.26	211.84	16.81	47.97
			16QAM	21.30	134.90	16.05	40.27
		1.4	QPSK	23.15	206.54	14.52	28.31
			16QAM	21.90	154.88	14.08	25.59

**DESCRIPTION OF AVAILABLE ANTENNAS**

The radio utilizes internal antenna for the [List the bands supported with a maximum peak gain as follow:

Frequency (MHz)	Peak Gain (dBi)
LTE Band 5 824 ~ 849 MHz	1.3

### 5.3. DESCRIPTION OF TEST SETUP

#### SUPPORT EQUIPMENT

Support Equipment List				
Description	Manufacturer	Model	Serial Number	FCC ID
Adapter	SAMSUNG	EP-TA60EBE	R37H81V 01Y2HM3	N/A
Earphone	SAMSUNG	EHS61ASFWE	N/A	N/A

#### I/O CABLES

I/O Cable List						
Cable No	Port	# of identical ports	Connector Type	Cable Type	Cable Length (m)	Remarks
1	DC Power	1	Mini USB	Shielded	1.0m	N/A
2	Audio	2	Mini-Jack	Unshielded	1.5m	N/A

#### TEST SETUP

The EUT is continuously communicated to the call box during the tests.

**SETUP DIAGRAM FOR TESTS (CONDUCTED TEST SETUP)**

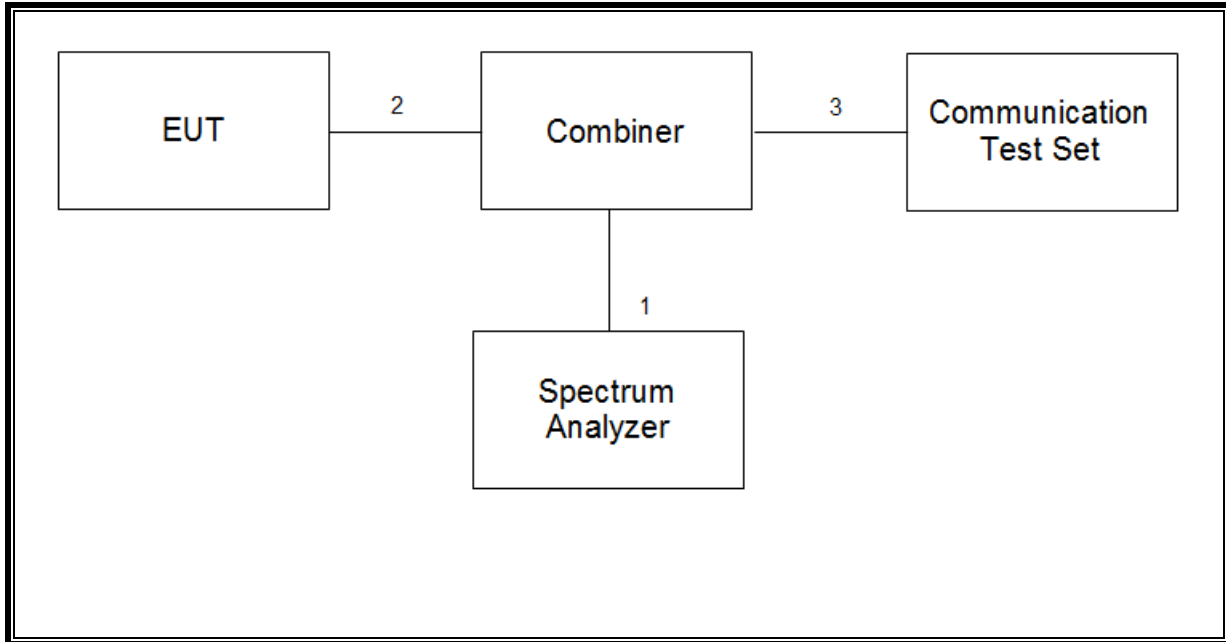

**SETUP DIAGRAM FOR TESTS (RADIATED TEST SETUP)**

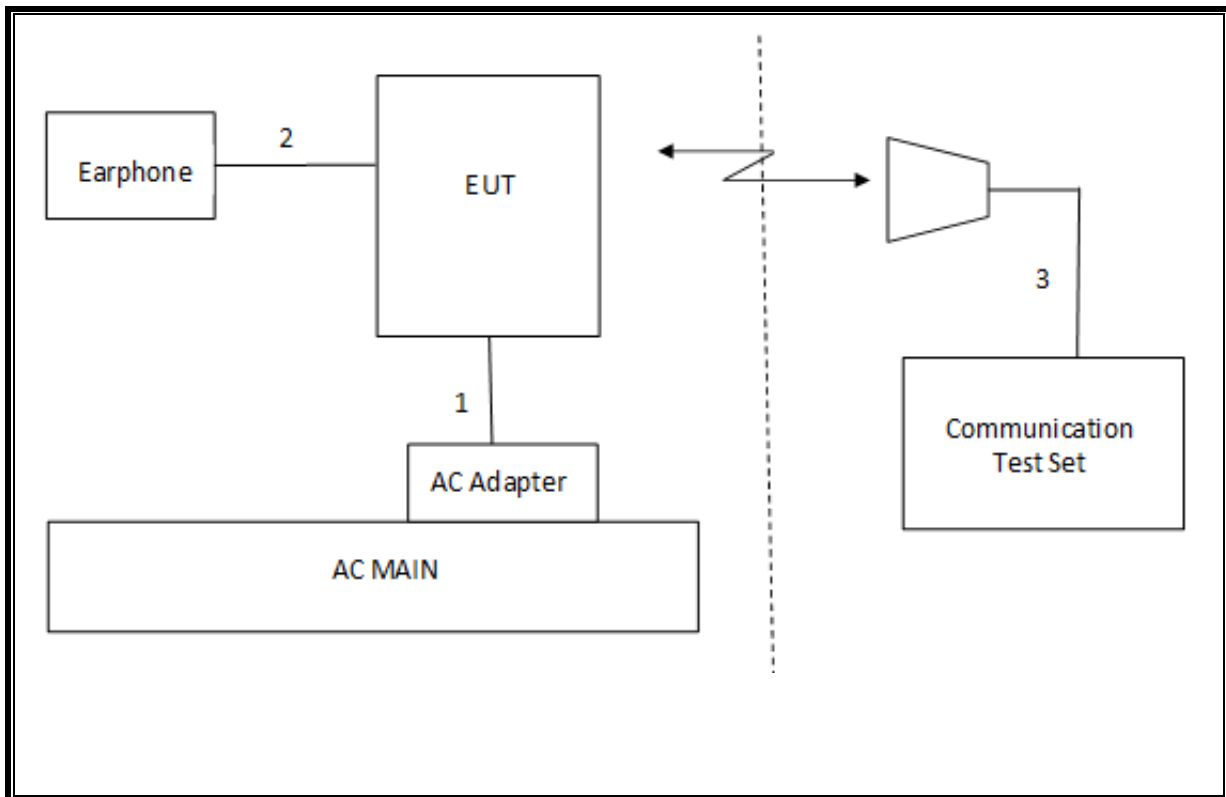

## 6. TEST AND MEASUREMENT EQUIPMENT

The following test and measurement equipment was utilized for the tests documented in this report:

Test Equipment List				
Description	Manufacturer	Model	S/N	Cal Due
Antenna, Tuned Dipole 400~1000 MHz	ETS	3121D DB4	00164753	07-28-17
Antenna, Horn, 40 GHz	ETS	3116C	00166155	11-30-17
Antenna, Horn, 40 GHz	ETS	3116C-PA	00168841	12-15-17
Antenna, Bilog, 30MHz-1GHz	SCHWARZBECK	VULB9163	750	10-14-18
Antenna, Bilog, 30MHz-1GHz	SCHWARZBECK	VULB9163	749	04-25-17
Antenna, Horn, 18 GHz	ETS	3115	00167211	10-14-18
Antenna, Horn, 18 GHz	ETS	3117	00168724	06-17-17
Antenna, Horn, 18 GHz	ETS	3117	00168717	06-17-17
Combiner	WEINSCHEL	1575	2154	08-17-17
Communications Test Set	R&S	CMW500	150312	08-17-17
Communications Test Set	R&S	CMW500	115331	08-17-17
DC Power Supply	Agilent / HP	E3640A	MY54226395	08-16-17
Preamplifier, 1000 MHz	Sonoma	310N	341282	08-17-17
Preamplifier, 1000 MHz	Sonoma	310N	351741	08-16-17
Preamplifier	ETS	3115-PA	00167475	08-17-17
Preamplifier, 18 GHz	Miteq	AFS42-00101800-25-S-42	1896138	08-16-17
Spectrum Analyzer, 44 GHz	Agilent / HP	N9030A	MY54170614	08-17-17
EMI Test Receive, 40 GHz	R&S	ESU40	100439	08-17-17
EMI Test Receive, 40 GHz	R&S	ESU40	100457	08-16-17
EMI Test Receive, 3 GHz	R&S	ESR3	101832	08-16-17
High Pass Filter 1.2GHz	Micro-Tronics	HPM50108-02	G005	08-17-17
High Pass Filter 1.2GHz	Micro-Tronics	HPM50108-02	G006	08-17-17
High Pass Filter 2.8GHz	Micro-Tronics	HPM50111-02	010	08-17-17
High Pass Filter 2.8GHz	Micro-Tronics	HPM50111-02	011	08-17-17
High Pass Filter 4GHz	Micro-Tronics	HPM50118-02	G001	08-17-17
High Pass Filter 4GHz	Micro-Tronics	HPM50118-02	G002	08-17-17
Attenuator	PASTERNAK	PE7087-10	A009	08-16-17
Temperature Chamber	ESPEC	SH-642	93001109	08-17-17
UL Software				
Description	Manufacturer	Model	Version	
Antenna port test software	UL	CLT	Ver 1.6	

## 7. Summary Table

FCC Part Section	Test Description	Test Limit	Test Condition	Test Result	Note
2.1049	Occupied Band width (99%)	N/A	Conducted	Pass	8.9861 MHz
22.917(a)	Band Edge / Conducted Spurious Emission	-13dBm		Pass	-14.11dBm
2.1046	Conducted output power	N/A		Pass	23.28 dBm
22.355	Frequency Stability	2.5PPM		Pass	0.004PPM
22.913(a)(2)	Effective Radiated Power	38 dBm	Radiated	Pass	16.94 dBm
22.917(a)	Radiated Spurious Emission	-13dBm		Pass	-31.7 dBm

FCC Rule Part	Frequency Range [MHz]	Output Power [W]	Frequency Tolerance	Emission Designator	Emission Bandwidth	Communication Type
LTE Band 5						
22H	829.0 - 844.0	0.0447	2.5 ppm	8M99G7W	10	QPSK
22H	829.0 - 844.0	0.0385	2.5 ppm	8M98D7W	10	16QAM
22H	826.5 - 846.5	0.0494	2.5 ppm	4M50G7W	5	QPSK
22H	826.5 - 846.5	0.0413	2.5 ppm	4M50D7W	5	16QAM

## 8. RF POWER OUTPUT VERIFICATION

### 8.1. LTE OUTPUT VERIFICATION

The following tests were conducted according to the test requirements outlined in section 6.2 of the 3GPP TS36.101 specification.

UE Power Class: 3 (23 +/- 2dBm). The allowed Maximum Power Reduction (MPR) for the maximum output power due to higher order modulation and transmit bandwidth configuration (resource blocks) is specified in Table 6.2.3-1 of the 3GPP TS36.101.

**Table 6.2.3-1: Maximum Power Reduction (MPR) for Power Class 3**

Modulation	Channel bandwidth / Transmission bandwidth (RB)						MPR (dB)
	1.4 MHz	3.0 MHz	5 MHz	10 MHz	15 MHz	20 MHz	
QPSK	> 5	> 4	> 8	> 12	> 16	> 18	≤ 1
16 QAM	≤ 5	≤ 4	≤ 8	≤ 12	≤ 16	≤ 18	≤ 1
16 QAM	> 5	> 4	> 8	> 12	> 16	> 18	≤ 2

The allowed A-MPR values specified below in Table 6.2.4.-1 of 3GPP TS36.101 are in addition to the allowed MPR requirements. All the measurements below were performed with A-MPR disabled, by using Network Signalling Value of "NS\_01".

**Table 6.2.4-1: Additional Maximum Power Reduction (A-MPR)**

Network Signalling value	Requirements (sub-clause)	E-UTRA Band	Channel bandwidth (MHz)	Resources Blocks ( $N_{RB}$ )	A-MPR (dB)
NS_01	6.6.2.1.1	Table 5.5-1	1.4, 3, 5, 10, 15, 20	Table 5.6-1	NA
NS_03	6.6.2.2.1	2, 4, 10, 23, 25, 35, 36	3	>5	≤ 1
			5	>6	≤ 1
			10	>6	≤ 1
			15	>8	≤ 1
			20	>10	≤ 1
NS_04	6.6.2.2.2	41	5	>6	≤ 1
			10, 15, 20	See Table 6.2.4-4	
NS_05	6.6.3.3.1	1	10,15,20	≥ 50	≤ 1
NS_06	6.6.2.2.3	12, 13, 14, 17	1.4, 3, 5, 10	Table 5.6-1	n/a
NS_07	6.6.2.2.3	13	10	Table 6.2.4-2	Table 6.2.4-2
	6.6.3.3.2				
NS_08	6.6.3.3.3	19	10, 15	> 44	≤ 3
				> 40	≤ 1
				> 55	≤ 2
NS_10		20	15, 20	Table 6.2.4-3	Table 6.2.4-3
NS_11	6.6.2.2.1	23 <sup>1</sup>	1.4, 3, 5, 10	Table 6.2.4-5	Table 6.2.4-5
..					
NS_32	-	-	-	-	-

Note 1: Applies to the lower block of Band 23, i.e. a carrier placed in the 2000-2010 MHz region.

### 8.1.1. LTE OUTPUT POWER RESULT

#### LTE Band 5 Measured Results

Band	BW (MHz)	Mode	RB Allocation	RB offset	Target MPR	Avg Pwr [dBm]		
						Max. Power		
						829 MHz	836.5 MHz	844 MHz
LTE Band 5	10	QPSK	1	0	0	23.05	22.95	22.74
			1	25	0	23.09	22.72	23.12
			1	49	0	23.10	23.01	22.93
			25	0	1	21.10	20.82	21.20
			25	12	1	21.11	20.81	21.27
			25	25	1	21.02	20.83	21.13
		16QAM	50	0	1	21.13	20.71	21.17
			1	0	1	21.12	21.54	20.60
			1	25	1	21.17	21.29	21.04
			1	49	1	21.17	21.65	20.77
			25	0	2	20.24	19.78	20.43
			25	12	2	20.27	19.78	20.41
			25	25	2	20.16	19.80	20.38
			50	0	2	20.38	19.97	20.47
Band	BW (MHz)	Mode	RB Allocation	RB offset	Target MPR	Avg Pwr [dBm]		
						Max. Power		
						826.5 MHz	836.5 MHz	846.5 MHz
LTE Band 5	5	QPSK	1	0	0	22.94	23.13	23.28
			1	12	0	22.99	23.10	23.13
			1	24	0	22.95	23.08	23.16
			12	0	1	21.05	20.78	21.21
			12	7	1	21.08	20.86	21.12
			12	13	1	21.16	20.80	21.10
		16QAM	25	0	1	21.13	20.74	20.97
			1	0	1	20.94	21.08	21.62
			1	12	1	21.00	21.10	21.46
			1	24	1	20.98	21.02	21.43
			12	0	2	20.08	19.72	20.52
			12	7	2	20.02	19.82	20.36
			12	13	2	20.12	19.74	20.42
			25	0	2	20.45	20.04	20.13
Band	BW (MHz)	Mode	RB Allocation	RB offset	Target MPR	Avg Pwr [dBm]		
						Max. Power		
						825.5 MHz	836.5 MHz	847.5 MHz
LTE Band 5	3	QPSK	1	0	0	22.91	22.94	23.26
			1	8	0	22.95	22.98	23.25
			1	14	0	23.12	23.03	23.17
			8	0	1	21.17	20.84	21.10
			8	4	1	21.15	20.88	21.12
			8	7	1	21.14	20.89	21.14
		16QAM	15	0	1	21.16	20.91	21.07
			1	0	1	21.09	21.05	21.30
			1	8	1	21.18	21.02	20.92
			1	14	1	21.22	20.94	20.75
			8	0	2	20.36	19.93	20.78
			8	4	2	20.32	19.98	20.83
			8	7	2	20.37	20.00	20.82
			15	0	2	20.35	20.12	20.26
Band	BW (MHz)	Mode	RB Allocation	RB offset	Target MPR	Avg Pwr [dBm]		
						Max. Power		
						824.7 MHz	836.5 MHz	848.3 MHz
LTE Band 5	1.4	QPSK	1	0	0	22.98	23.10	23.00
			1	3	0	22.96	23.08	22.93
			1	5	0	22.89	23.15	22.95
			3	0	0	22.98	22.83	23.00
			3	1	0	22.98	22.82	22.97
			3	3	0	22.99	22.81	22.94
		16QAM	6	0	1	21.18	20.89	21.04
			1	0	1	21.54	20.81	21.64
			1	3	1	21.56	20.80	21.57
			1	5	1	21.50	20.89	21.56
			3	0	1	21.90	21.41	21.85
			3	1	1	21.90	21.40	21.78
			3	3	1	21.86	21.39	21.47
			6	0	2	20.32	20.16	20.36

## 9. PEAK TO AVERAGE RATIO

### Test Procedure

Per KDB 971168 D01 Power Meas License Digital Systems v02r02;

The transmitter output was connected to a CMW500 Test Set and configured to operate at maximum power. The PAR were measured on the Spectrum Analyzer.

### Test Spec

In addition, when the transmitter power is measured in terms of average value, the peak-to-average ratio of the power shall not exceed 13 dB.

### 9.1. CONDUCTED PEAK TO AVERAGE RESULT

#### LTE

Band	BW [MHz]	Channel	f [MHz]	Mode	Ratio [dB]	Limit [dB]
Band 5	10	20525	836.5	QPSK	4.25	13.00
				16QAM	5.73	
	5			QPSK	4.26	
				16QAM	5.69	
	3			QPSK	4.12	
				16QAM	5.66	
	1.4			QPSK	4.20	
				16QAM	5.62	

## 9.2. CONDUCTED PEAK TO AVERAGE PLOTS

### LTE Band 5

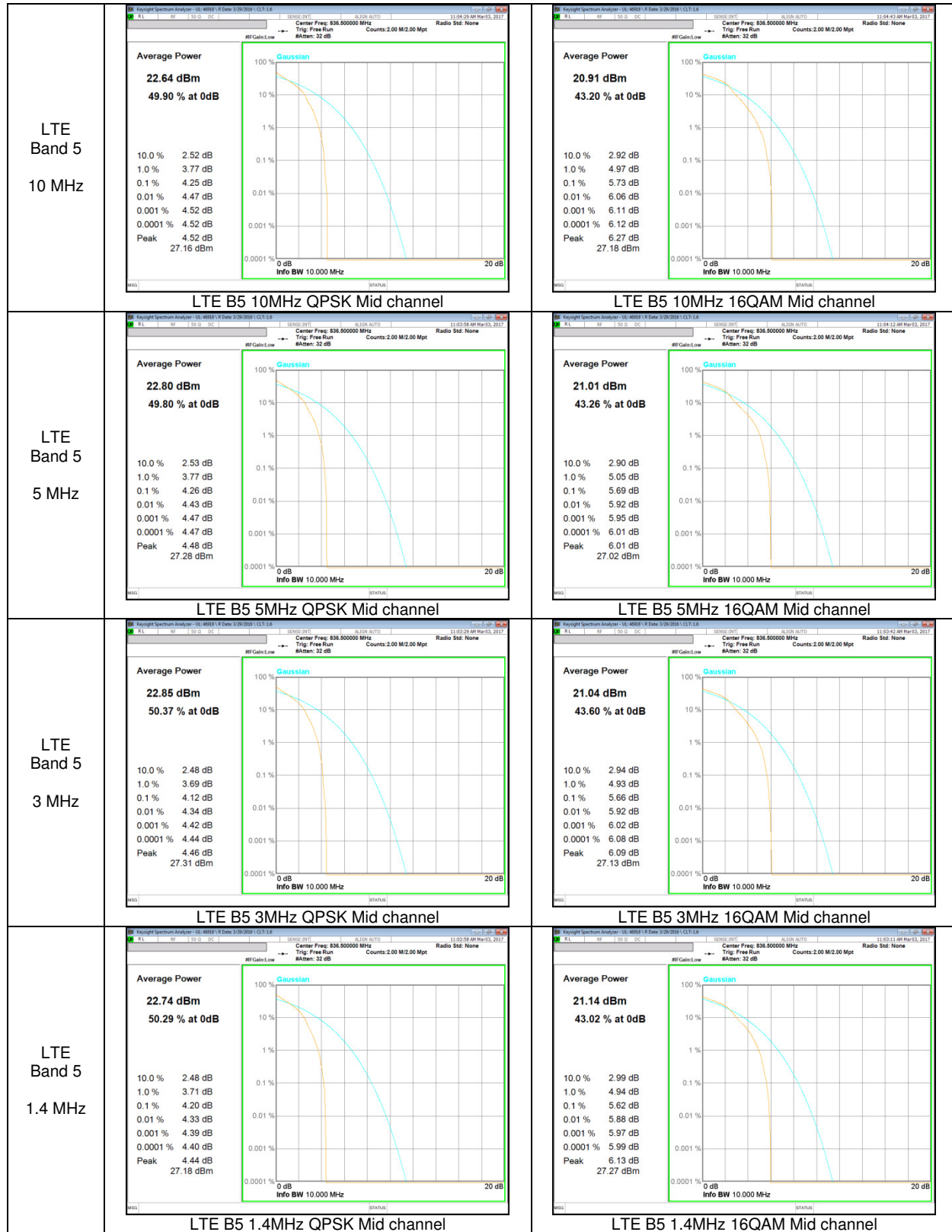

## 10. LIMITS AND CONDUCTED RESULTS

### 10.1. OCCUPIED BANDWIDTH

#### RULE PART(S)

FCC: §2.1049

#### LIMITS

For reporting purposes only

#### TEST PROCEDURE

The transmitter output was connected to a calibrated coaxial cable and coupler, the other end of which was connected to a spectrum analyzer. The occupied bandwidth was measured with the spectrum analyzer at the low, middle and high channel in each band. The -26dB bandwidth was also measured and recorded.

(KDB 971168 D01 Power Meas License Digital Systems v02r02)

**10.1.1. OCCUPIED BANDWIDTH RESULTS**

**LTE Band 5**

Band	BW [MHz]	Channel	f [MHz]	Mode	99% BW [MHz]	26dB BW [MHz]
Band 5	10	20450	829.0	QPSK	8.9679	9.878
				16QAM	8.9599	10.15
		20524	836.5	QPSK	8.9641	10.03
				16QAM	8.9677	10.16
		20599	844.0	QPSK	8.9861	9.968
				16QAM	8.9808	9.889
	5	20425	826.5	QPSK	4.5016	5.206
				16QAM	4.5010	5.300
		20524	836.5	QPSK	4.4883	5.124
				16QAM	4.4897	5.094
		20624	846.5	QPSK	4.4987	5.255
				16QAM	4.4948	5.101
	3	20415	825.5	QPSK	2.6908	3.127
				16QAM	2.6876	3.259
		20524	836.5	QPSK	2.6943	3.114
				16QAM	2.6923	3.130
		20634	847.5	QPSK	2.6941	3.114
				16QAM	2.6929	3.144
	1.4	20407	824.7	QPSK	1.0930	1.486
				16QAM	1.0917	1.429
		20524	836.5	QPSK	1.0985	1.523
				16QAM	1.1001	1.403
		20624	848.3	QPSK	1.0954	1.435
				16QAM	1.0941	1.550

### 10.1.2. OCCUPIED BANDWIDTH PLOTS

#### LTE Band 5

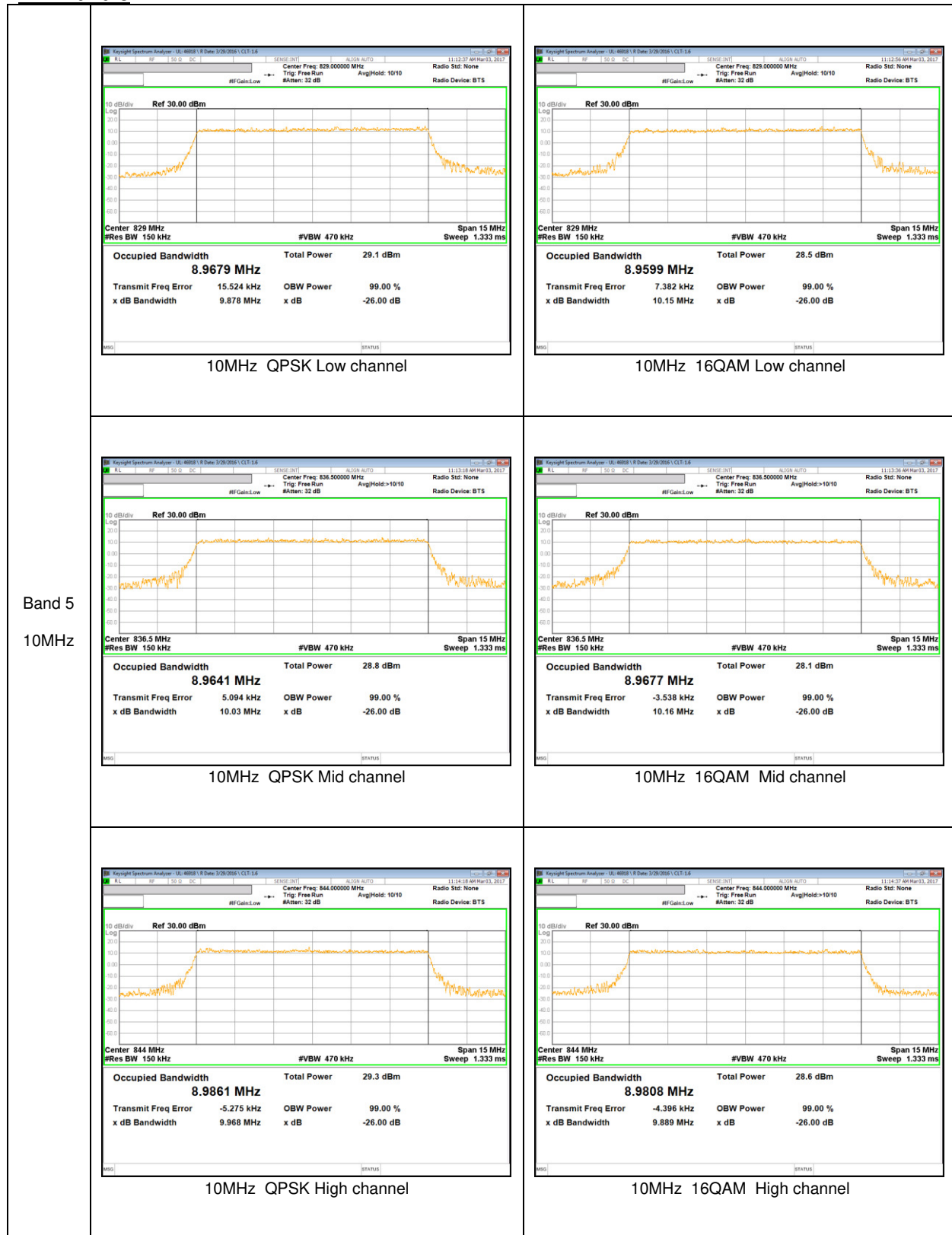

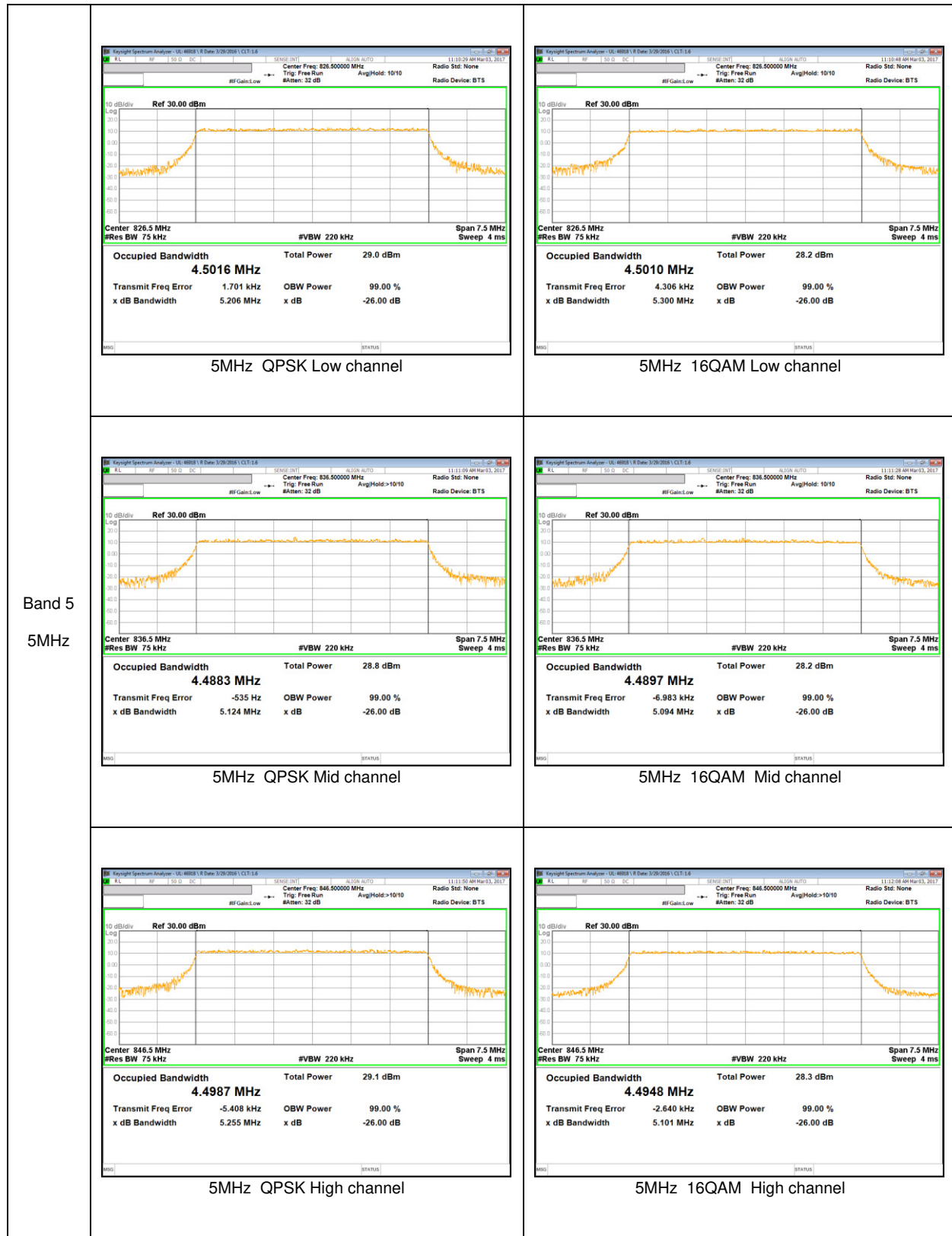

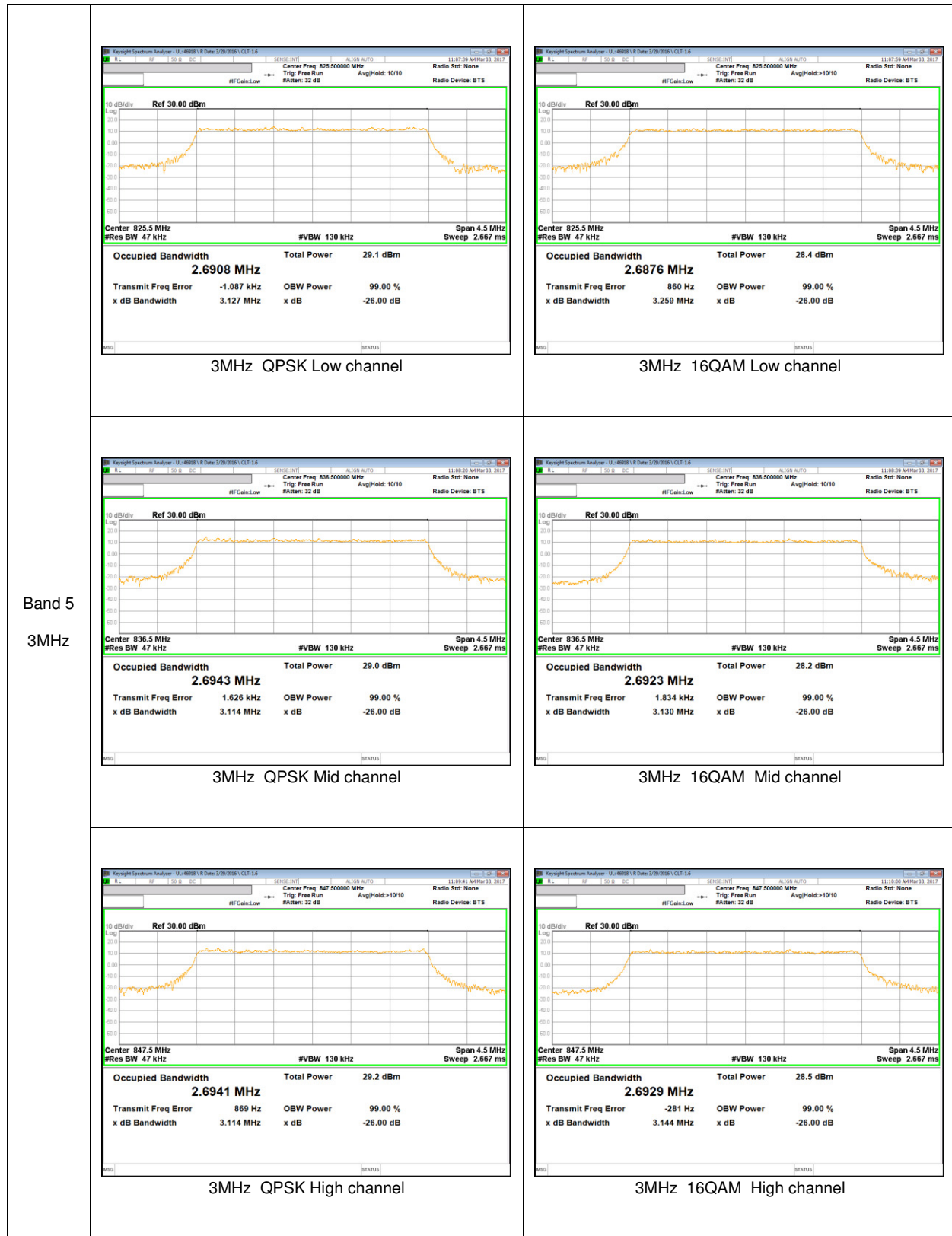

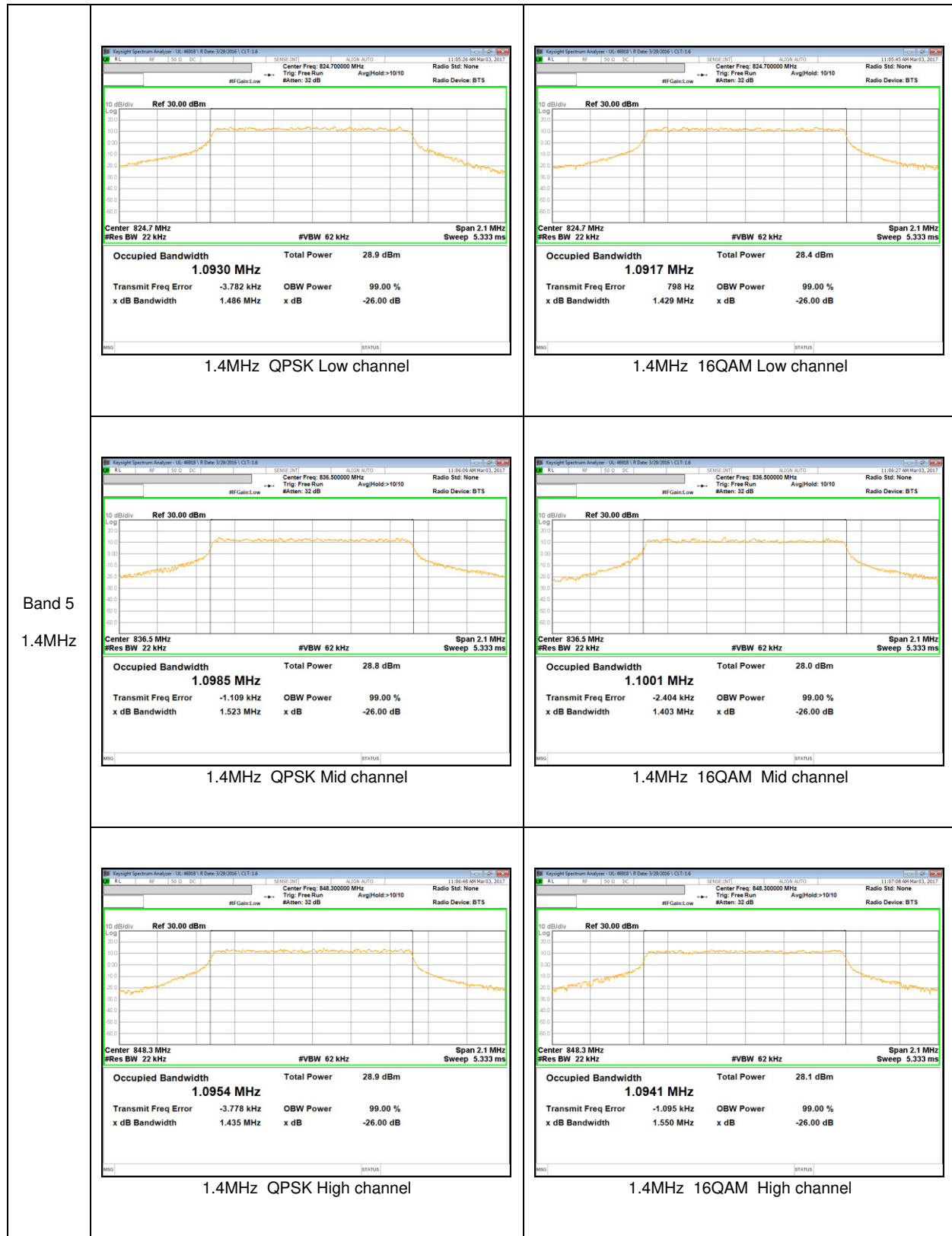

## 10.2. BAND EDGE EMISSIONS

### RULE PART(S)

FCC: §22.359

### LIMITS

The power of any emission outside of the authorized operating frequency ranges must be attenuated below the transmitting power (P) by a factor of at least  $43 + 10 \log (P)$  dB.

### TEST PROCEDURE

Per KDB 971168 D01 Power Meas License Digital Systems v02r02

The transmitter output was connected to a CMW500 Test Set and configured to operate at maximum power. The band edge emissions were measured at the required operating frequencies in each band on the Spectrum Analyzer.

### LTE

- a) Set the RBW = 1 ~ 1.5 % of OBW(Typically limited to a minimum RBW of 1% of the OBW)
- b) Set VBW  $\geq 3 \times$  RBW;
- c) Set span  $\geq 1.5$  times the OBW;
- d) Sweep time = Auto;
- e) Detector = RMS;
- f) Ensure that the number of measurement points  $\geq 2 \times$  Span/RBW;
- g) Trace mode = Average (100);

### RESULTS

**LTE 5**

Bandwidth	Mode	Side	RB Status	f [MHz]	Level [dBm]	Limit [dBm]
10 MHz	QPSK	Lower	1RB	824.000	-20.268	-13.00
			FRB	824.000	-36.024	
		Upper	1RB	849.000	-22.470	
			FRB	849.000	-34.048	
	16QAM	Lower	1RB	824.000	-22.426	
			FRB	824.000	-32.444	
		Upper	1RB	849.000	-25.499	
			FRB	849.000	-34.156	
5 MHz	QPSK	Lower	1RB	824.000	-15.984	
			FRB	824.000	-27.474	
		Upper	1RB	849.000	-14.377	
			FRB	849.000	-27.229	
	16QAM	Lower	1RB	824.000	-16.563	
			FRB	824.000	-28.463	
		Upper	1RB	849.000	-16.745	
			FRB	849.000	-27.724	
3 MHz	QPSK	Lower	1RB	824.000	-14.191	
			FRB	824.000	-25.565	
		Upper	1RB	849.000	-14.536	
			FRB	849.000	-24.920	
	16QAM	Lower	1RB	824.000	-16.340	
			FRB	824.000	-27.348	
		Upper	1RB	849.000	-15.706	
			FRB	849.000	-26.512	
1.4 MHz	QPSK	Lower	1RB	824.000	-14.517	
			FRB	824.000	-21.090	
		Upper	1RB	849.000	-14.110	
			FRB	849.000	-21.093	
	16QAM	Lower	1RB	824.000	-15.833	
			FRB	824.000	-20.948	
		Upper	1RB	849.000	-15.439	
			FRB	849.000	-22.468	

## 10.2.1. BAND EDGE PLOTS

### LTE Band 5

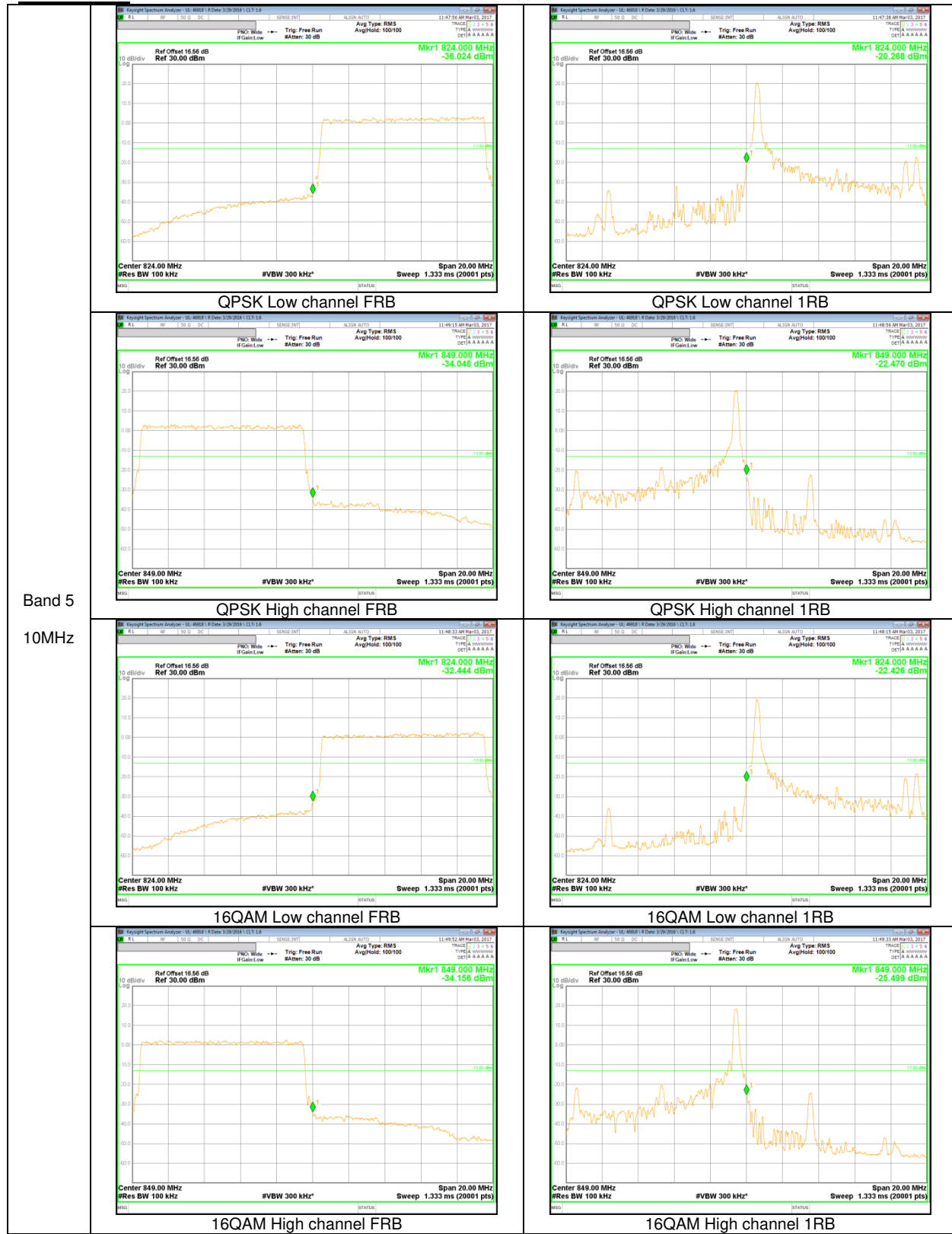

Band 5  
10MHz

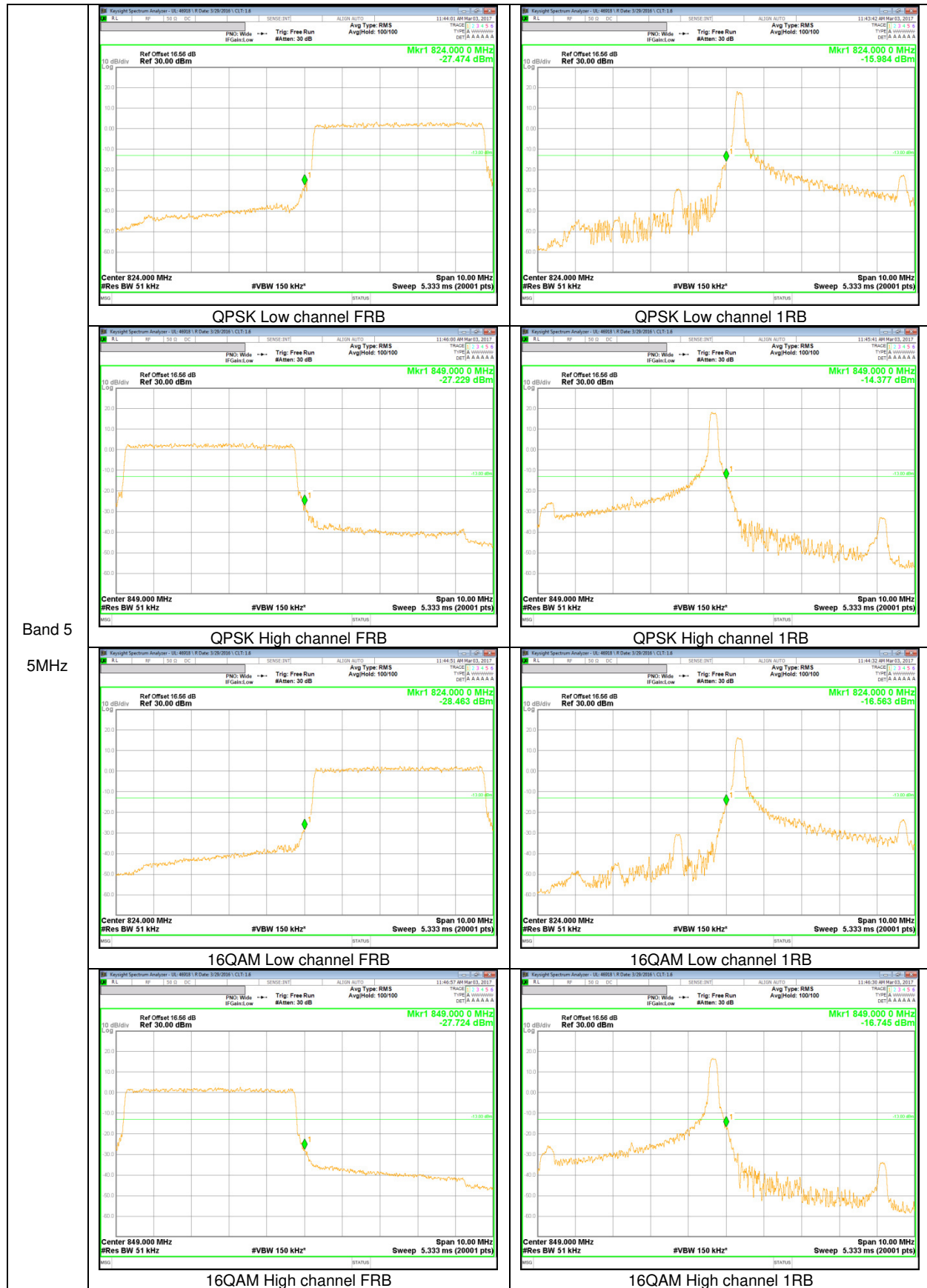

Band 5  
5MHz

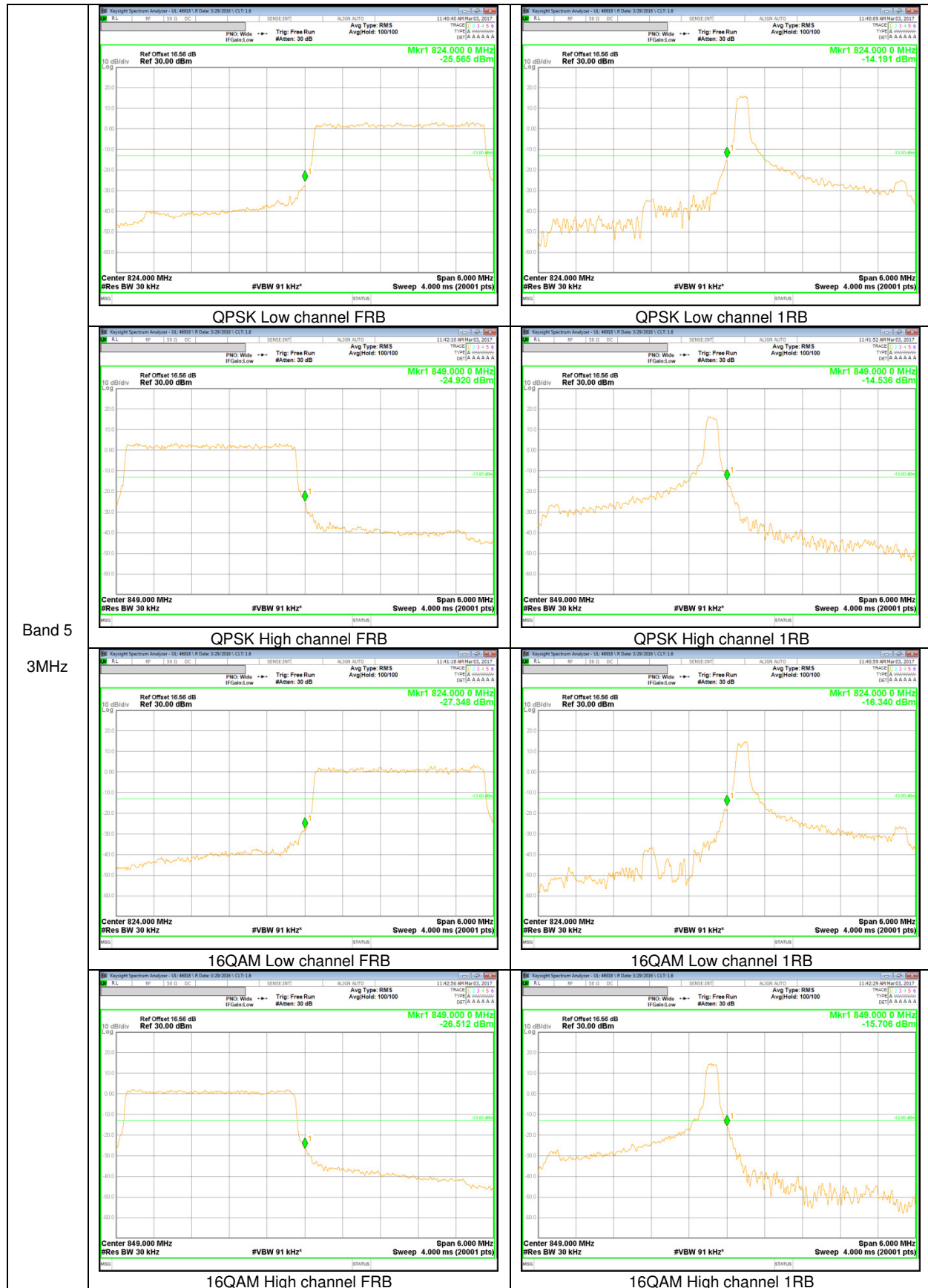

Band 5  
 3MHz

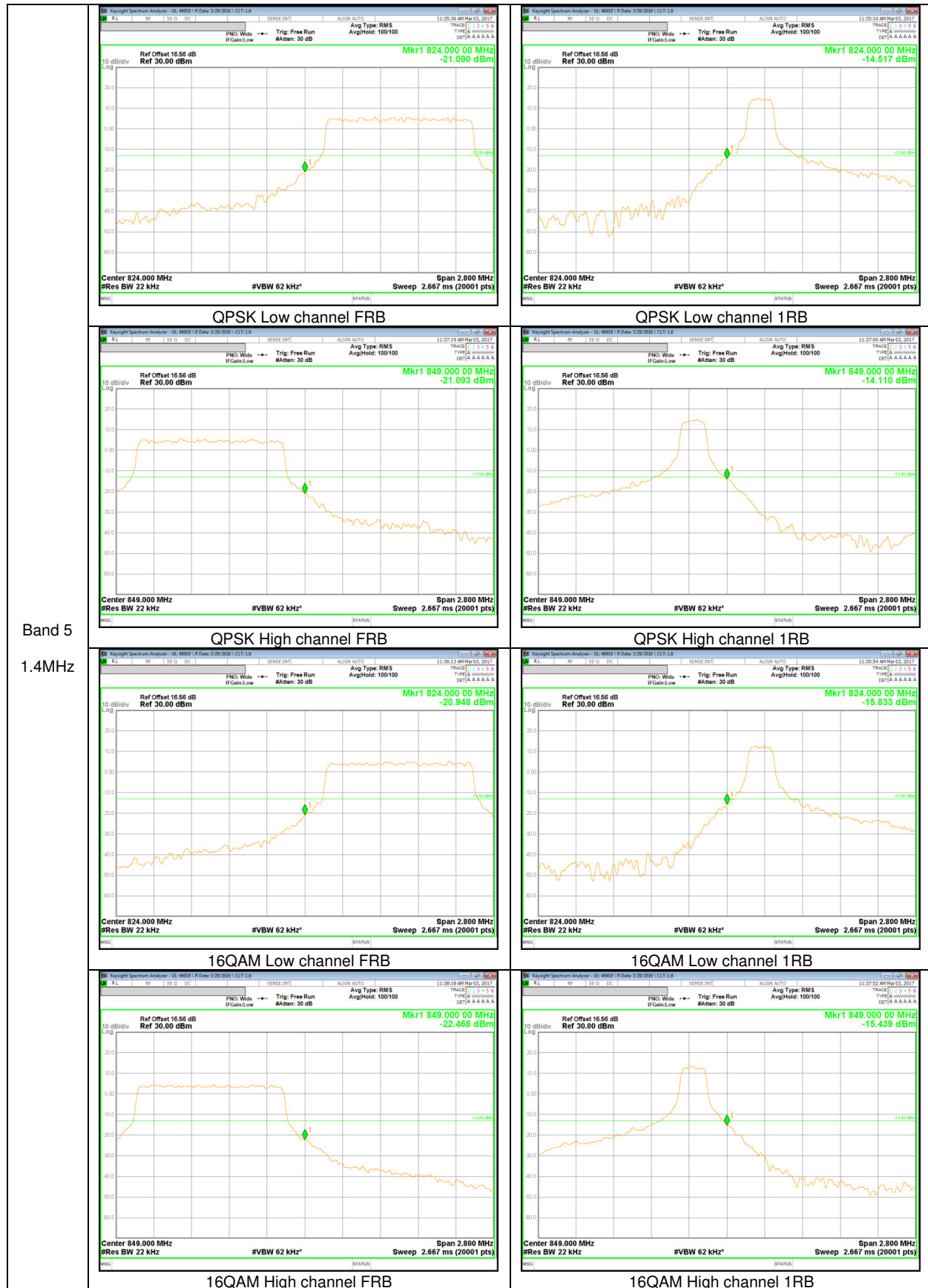

Band 5  
1.4MHz

### **10.3. OUT OF BAND EMISSIONS**

#### **RULE PART(S)**

FCC: §2.1051, §22.901, §22.917

#### **LIMITS**

The power of any emission outside of the authorized operating frequency ranges must be attenuated below the transmitting power (P) by a factor of at least  $43 + 10 \log (P)$  dB.

#### **TEST PROCEDURE**

Per KDB 971168 D01 Power Meas License Digital Systems v02r02

The RF output of the transmitter was connected to a spectrum analyzer through a calibrated coaxial cable. Sufficient scans were taken to show the out-of-band Emissions, if any, up to 10th harmonic. Multiple sweeps were recorded in maximum hold mode using a peak detector to ensure that the worst-case emissions were caught.

- a) Set the RBW = 100KHz for emission below 1GHz and 1MHz for emissions above 1GHz  
(Tests were performed 1MHz [Worst case], to sweep 1 time for all frequency range)
- b) Set VBW  $\geq 3 \times$  RBW;
- c) Set span  $\geq 1.5$  times the OBW;
- d) Sweep time = auto couple;
- e) Detector = peak;
- f) Ensure that the number of measurement points = Max (40001);
- g) Trace mode = max hold;

#### **RESULTS**

**10.3.1. OUT OF BAND EMISSIONS RESULT**

**LTE 5**

Bandwidth	Mode	f [MHz]	Spurious [dBm]	Limit [dBm]
10 MHz	QPSK	829.0	-28.97	-13.00
		836.5	-28.21	
		844.0	-29.29	
	16QAM	829.0	-28.62	
		836.5	-29.26	
		844.0	-28.72	
5 MHz	QPSK	826.5	-28.93	
		836.5	-28.42	
		846.5	-28.47	
	16QAM	826.5	-29.28	
		836.5	-29.20	
		846.5	-28.64	
3 MHz	QPSK	825.5	-28.82	
		836.5	-28.65	
		847.5	-29.00	
	16QAM	825.5	-27.98	
		836.5	-28.67	
		847.5	-29.05	
1.4 MHz	QPSK	824.7	-28.92	
		836.5	-28.54	
		848.3	-28.86	
	16QAM	824.7	-28.86	
		836.5	-28.83	
		848.3	-28.74	

### 10.3.2. OUT OF BAND EMISSIONS PLOTS

#### LTE Band 5

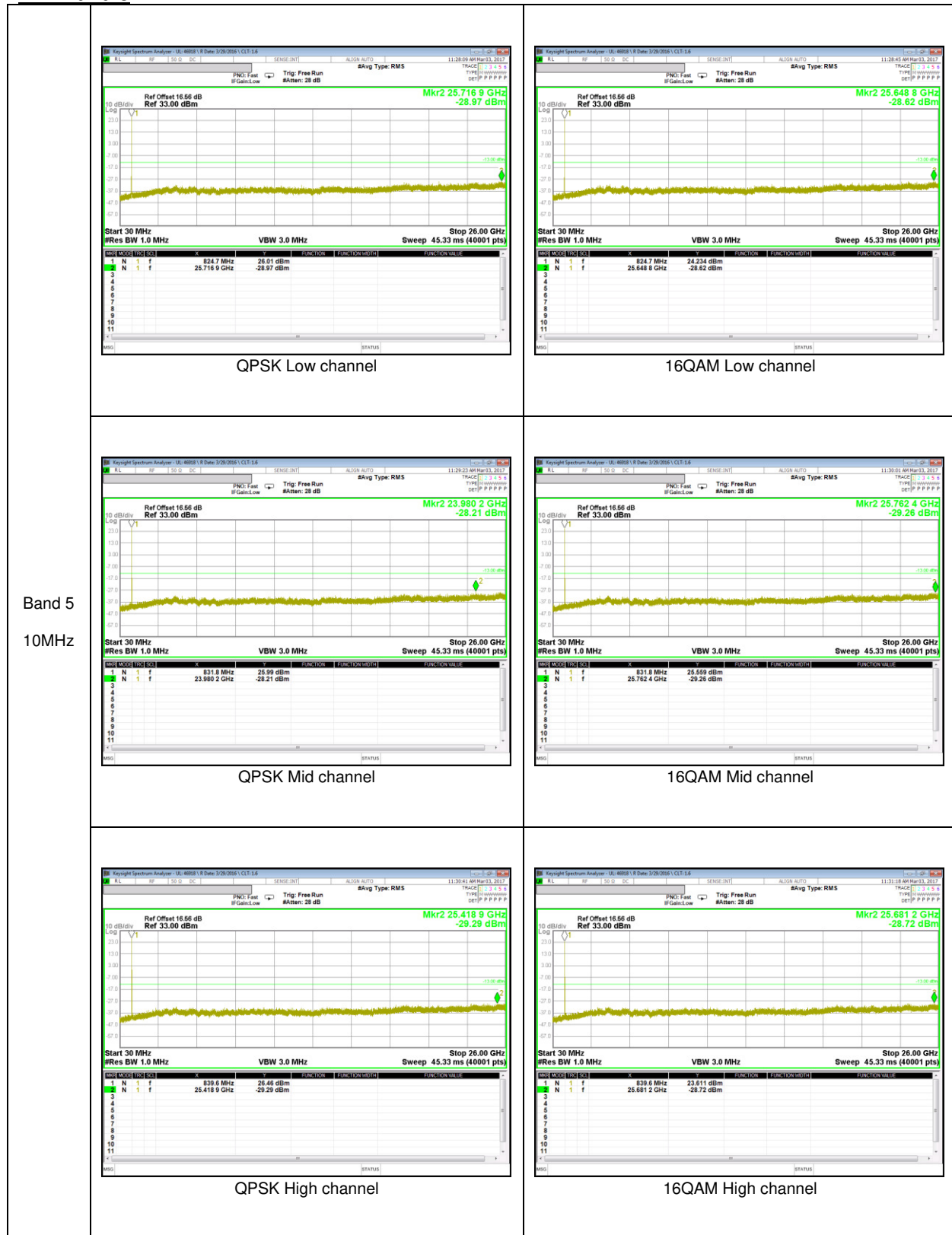

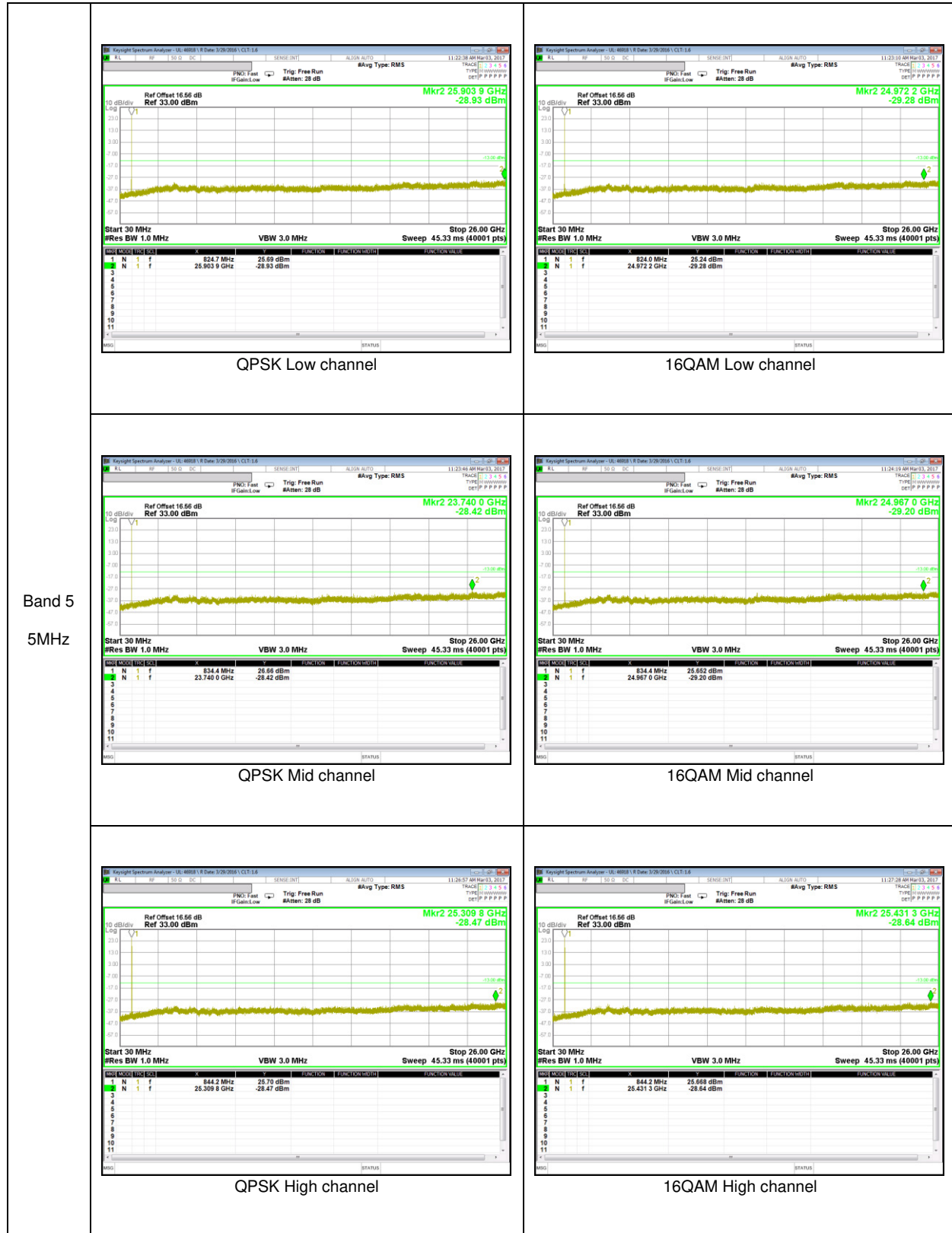

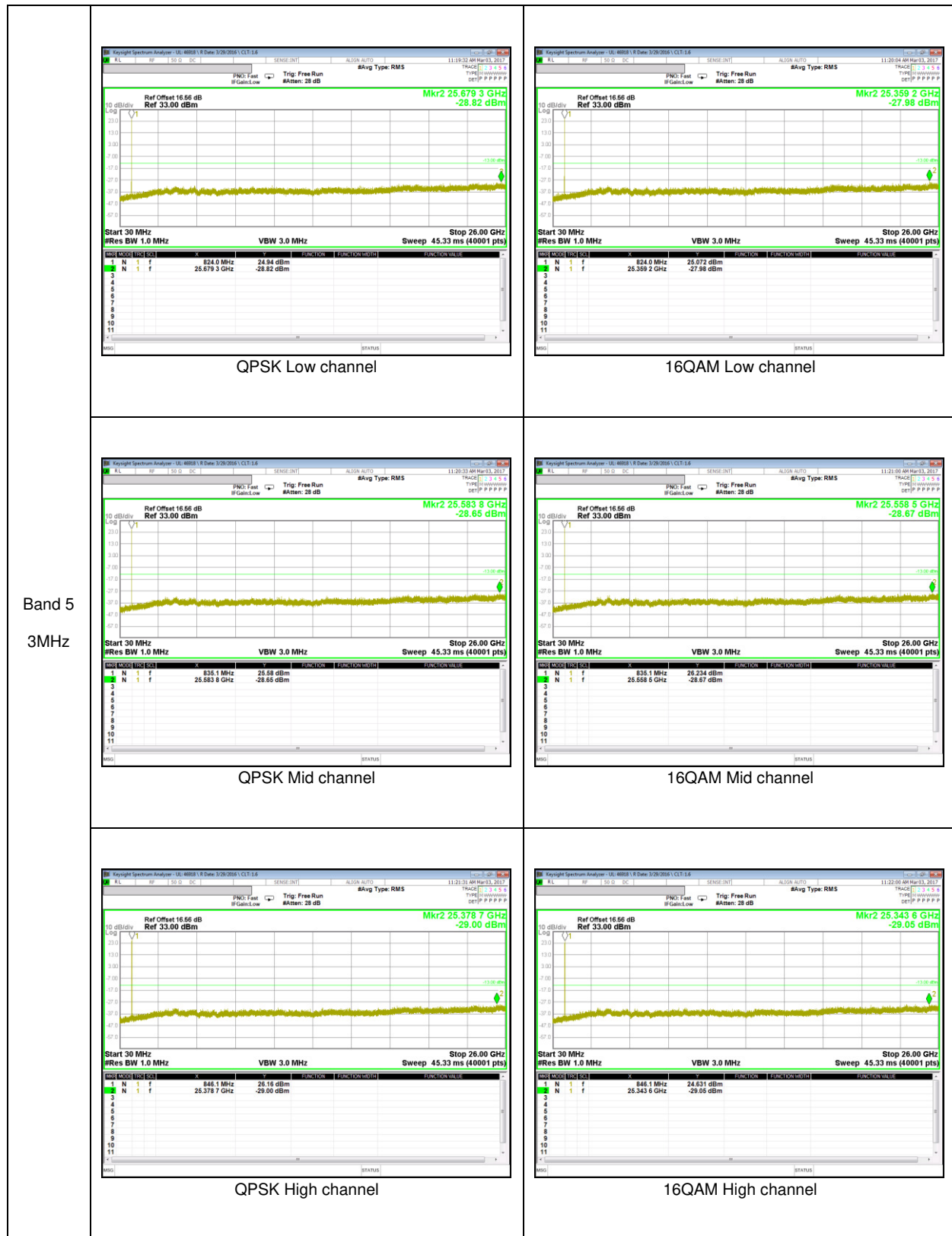

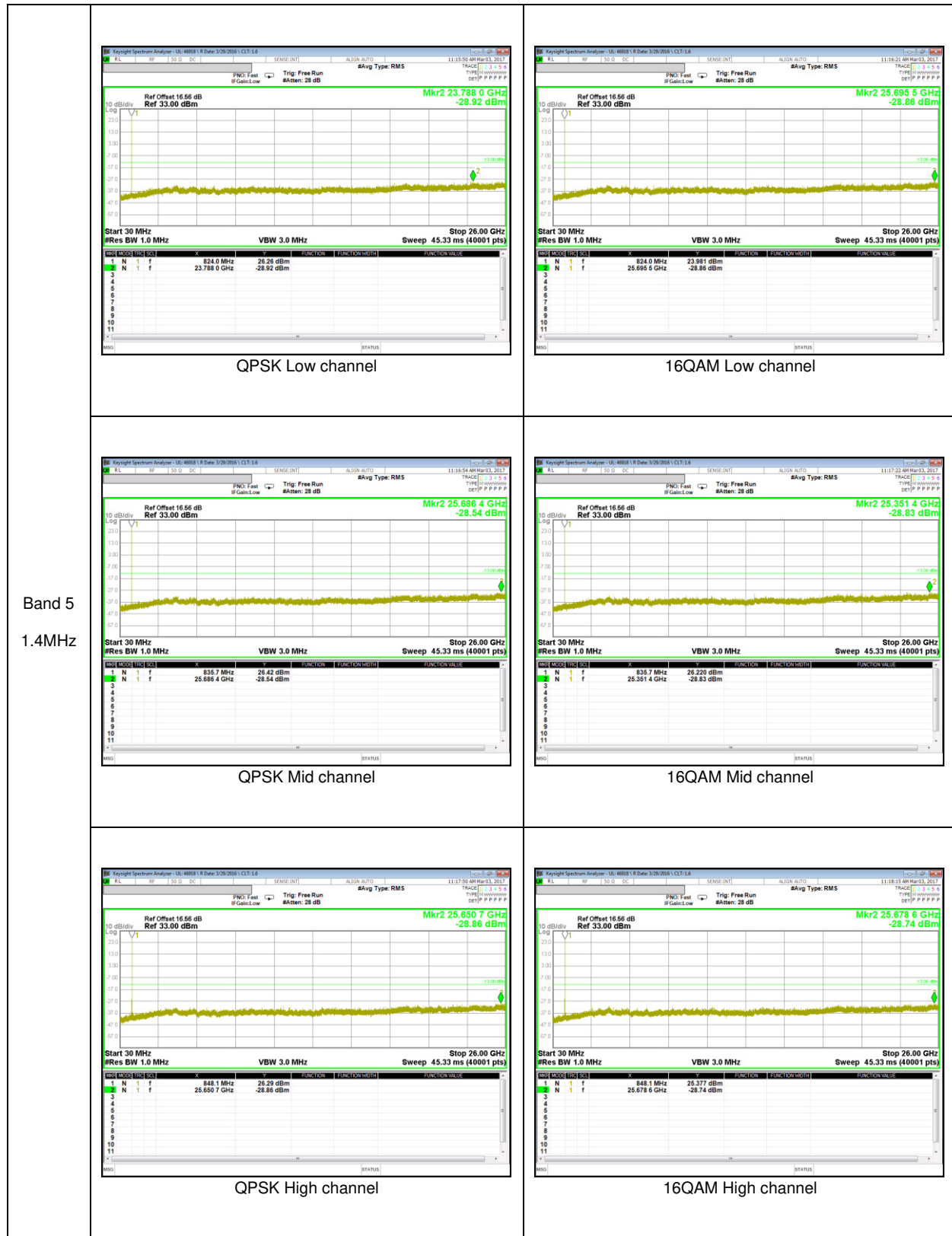

---

## 10.4. FREQUENCY STABILITY

### RULE PART(S)

FCC: §2.1055, §22.355

### LIMITS

§22.355 - The carrier frequency shall not depart from the reference frequency in excess of  $\pm 2.5$  ppm for mobile stations.

### TEST PROCEDURE

Per KDB 971168 D01 Power Meas License Digital Systems v02r02

### RESULTS

See the following pages.

### 10.4.1. FREQUENCY STABILITY RESULTS

#### LTE Band 5, Channel 20524, Frequency 836.5 MHz

Reference Frequency: LTE Band 5 Mid Channel 836.5 MHz @ 20°C				
Limit: +- 2.5 ppm = 2091.250 Hz				
Power Supply [Vdc]	Environment Temperature [°C]	Frequency Deviation Measured with Time Elapse		
		[MHz]	Delta [ppm]	Limit [ppm]
3.85	50	836.49998874	0.004	2.5
3.85	40	836.49999014	0.003	2.5
3.85	30	836.49999118	0.001	2.5
<b>3.85</b>	<b>20</b>	836.49999243	<b>0</b>	<b>2.5</b>
3.85	10	836.49999376	-0.002	2.5
3.85	0	836.49999286	-0.001	2.5
3.85	-10	836.49999396	-0.002	2.5
3.85	-20	836.49999282	0.000	2.5
3.85	-30	836.49999152	0.001	2.5

Reference Frequency: LTE Band 5 Mid Channel 836.5 MHz @ 20°C				
Limit: +- 2.5 ppm = 2091.250 Hz				
Power Supply [Vdc]	Environment Temperature [°C]	Frequency Deviation Measured with Time Elapse		
		[MHz]	Delta [ppm]	Limit [ppm]
<b>3.85</b>	<b>20</b>	<b>836.49999243</b>	<b>0</b>	<b>2.5</b>
4.43	20	836.49999376	-0.002	2.5
3.60	20	836.49999271	0.000	2.5

## 11. RADIATED TEST RESULTS

### 11.1. RADIATED POWER (ERP & EIRP)

#### RULE PART(S)

FCC: §2.1046, §22.913

#### LIMITS

22.913(a) - The ERP of mobile transmitters and auxiliary test transmitters must not exceed 7 Watts.

In addition, when the transmitter power is measured in terms of average value, the peak-to-average ratio of the power shall not exceed 13dB.

#### TEST PROCEDURE

ANSI / TIA / EIA 603D Clause 2.2.17; ESU40 setting reference to 971168 D01 v02r02

For peak power measurement with a ESU40:

a) Set the RBW  $\geq$  OBW; b) Set VBW  $\geq 3 \times$  RBW; c) Set span  $\geq 2 \times$  RBW; d) Sweep time = auto couple; e) Detector = peak; f) Ensure that the number of measurement points  $\geq$  span/RBW; g) Trace mode = max hold;

For average power measurement with a ESU40:

a) Set span to at least 1.5 times the OBW; b) Set RBW = 1-5% of the OBW, not to exceed 1 MHz; c) Set VBW  $\geq 3 \times$  RBW; d) Set number of points in sweep  $\geq 2 \times$  span / RBW; e) Sweep time = auto-couple; f) Detector = RMS (power averaging); g) Use free run trigger If burst duty cycle  $\geq 98$ ; h) Use trigger to capture bursts If burst duty cycle  $< 98$ ; i) Trace average at least 100 traces in power averaging (*i.e.*, RMS) mode. j) Compute the power by integrating the spectrum across the OBW of the signal using the instrument's band power measurement function.

#### TEST RESULTS

**11.1.1. ERP/EIRP Results**

**LTE Band 5**

Band	BW [MHz]	Mode	RB/RB Size	f [MHz]	ERP / EIRP	
			Full RB		[dBm]	[mW]
Band 5	10	QPSK	50/0	829.0	16.38	43.45
			50/0	836.5	16.50	44.67
			50/0	844.0	16.07	40.46
		16QAM	50/0	829.0	15.71	37.24
			50/0	836.5	15.85	38.46
			50/0	844.0	15.47	35.24
	5	QPSK	25/0	826.5	16.94	49.43
			25/0	836.5	16.52	44.87
			25/0	846.5	16.15	41.21
		16QAM	25/0	826.5	16.16	41.30
			25/0	836.5	15.66	36.81
			25/0	846.5	15.93	39.17
	3	QPSK	15/0	825.5	16.79	47.75
			15/0	836.5	16.81	47.97
			15/0	847.5	16.12	40.93
		16QAM	15/0	825.5	15.95	39.36
			15/0	836.5	16.05	40.27
			15/0	847.5	15.86	38.55
	1.4	QPSK	6/0	824.7	14.52	28.31
			6/0	836.5	13.98	25.00
			6/0	848.3	14.42	27.67
		16QAM	6/0	824.7	13.54	22.59
			6/0	836.5	13.19	20.84
			6/0	848.3	14.08	25.59

**11.1.2. ERP/EIRP DATA**

**LTE Band 5**

		High Frequency Substitution Measurement UL Korea, Ltd. Suwon Laboratory Chamber 2								
LTE Band 5 10MHz QPSK	<b>Company:</b> Samsung <b>Project #:</b> 4787852400 <b>Date:</b> 02-09-17 <b>Test Engineer:</b> JH Park <b>Configuration:</b> EUT ONLY, X Position <b>Mode:</b> TX, LTE BAND 5, 10MHz BW,QPSK  <b>Test Equipment:</b> Receiving: VULB9163-749, and 3m Chamber N-type Cable (Setup this one for testing EUT) Substitution: Dipole S/N: 00164753, 3m SMA Cable Warehouse.									
	f MHz	SG reading (dBm)	Ant. Pol. (H/V)	Cable Loss (dB)	Antenna Gain (dBd)	ERP (dBm)	Limit (dBm)	Margin (dB)	Notes	
	Low Ch									
	829.00	12.69	V	1.1	-1.5	10.11	38.5	-28.3		
	829.00	18.96	H	1.1	-1.5	16.38	38.5	-22.1		
	Mid Ch									
	836.50	12.26	V	1.1	-1.4	9.77	38.5	-28.7		
	836.50	18.99	H	1.1	-1.4	16.50	38.5	-22.0		
	High Ch									
	844.00	12.88	V	1.1	-1.3	10.49	38.5	-28.0		
	844.00	18.49	H	1.1	-1.3	16.07	38.5	-22.4		
	Rev. 3.17.11 Note: For Band 13/17 ERP limit is 34.77dBm; For Band 26 limit is 50dBm									
	LTE Band 5 10MHz 16QAM	<b>Company:</b> Samsung <b>Project #:</b> 4787852400 <b>Date:</b> 02-09-17 <b>Test Engineer:</b> JH Park <b>Configuration:</b> EUT ONLY, X Position <b>Mode:</b> LTE5 10MHz FUND 16QAM  <b>Test Equipment:</b> Receiving: VULB9163-749, and 3m Chamber N-type Cable (Setup this one for testing EUT) Substitution: Dipole S/N: 00164753, 3m SMA Cable Warehouse.								
		f MHz	SG reading (dBm)	Ant. Pol. (H/V)	Cable Loss (dB)	Antenna Gain (dBd)	ERP (dBm)	Limit (dBm)	Margin (dB)	Notes
Low Ch										
829.00		12.06	V	1.1	-1.5	9.48	38.5	-29.0		
829.00		18.29	H	1.1	-1.5	15.71	38.5	-22.7		
Mid Ch										
836.50		11.64	V	1.1	-1.4	9.13	38.5	-29.3		
836.50		18.36	H	1.1	-1.4	15.85	38.5	-22.6		
High Ch										
844.00		12.22	V	1.1	-1.3	9.80	38.5	-28.6		
844.00		17.89	H	1.1	-1.3	15.47	38.5	-23.0		
Rev. 3.17.11 Note: For Band 13/17 ERP limit is 34.77dBm; For Band 26 limit is 50dBm										

High Frequency Substitution Measurement UL Korea, Ltd. Suwon Laboratory Chamber 2										
LTE Band 5 5MHz QPSK	<b>Company:</b>		Samsung							
	<b>Project #:</b>		4787852400							
	<b>Date:</b>		03-06-17							
	<b>Test Engineer:</b>		YH Lim							
	<b>Configuration:</b>		EUT ONLY, X Position							
	<b>Mode:</b>		LTE5 5MHz FUND QPSK							
	<b>Test Equipment:</b>									
	Receiving: VULB9163-749, and 3m Chamber N-type Cable (Setup this one for testing EUT)									
	Substitution: Dipole S/N: 00164753, 3m SMA Cable Warehouse.									
	f MHz	SG reading (dBm)	Ant. Pol. (H/V)	Cable Loss (dB)	Antenna Gain (dBd)	ERP (dBm)	Limit (dBm)	Margin (dB)	Notes	
	Low Ch									
	826.50	12.17	V	1.1	-1.5	9.57	38.5	-28.9		
	826.50	19.54	H	1.1	-1.5	16.94	38.5	-21.5		
	Mid Ch									
836.50	12.20	V	1.1	-1.4	9.71	38.5	-28.7			
836.50	19.01	H	1.1	-1.4	16.52	38.5	-21.9			
High Ch										
846.50	11.31	V	1.6	-1.3	8.43	38.5	-30.0			
846.50	19.03	H	1.6	-1.3	16.15	38.5	-22.3			
Rev. 3.17.11 Note: For Band 13/17 ERP limit is 34.77dBm; For Band 26 limit is 50dBm										
LTE Band 5 5MHz 16QAM	High Frequency Substitution Measurement UL Korea, Ltd. Suwon Laboratory Chamber 2									
	<b>Company:</b>		Samsung							
	<b>Project #:</b>		4787852400							
	<b>Date:</b>		03-06-17							
	<b>Test Engineer:</b>		YH Lim							
	<b>Configuration:</b>		EUT ONLY, X Position							
	<b>Mode:</b>		LTE5 5MHz FUND 16QAM							
	<b>Test Equipment:</b>									
	Receiving: VULB9163-749, and 3m Chamber N-type Cable (Setup this one for testing EUT)									
	Substitution: Dipole S/N: 00164753, 3m SMA Cable Warehouse.									
	f MHz	SG reading (dBm)	Ant. Pol. (H/V)	Cable Loss (dB)	Antenna Gain (dBd)	ERP (dBm)	Limit (dBm)	Margin (dB)	Notes	
	Low Ch									
	826.50	11.32	V	1.1	-1.5	8.72	38.5	-29.7		
	826.50	18.76	H	1.1	-1.5	16.16	38.5	-22.3		
Mid Ch										
836.50	11.44	V	1.1	-1.4	8.95	38.5	-29.5			
836.50	18.15	H	1.1	-1.4	15.66	38.5	-22.8			
High Ch										
846.50	10.48	V	1.1	-1.3	8.10	38.5	-30.4			
846.50	18.31	H	1.1	-1.3	15.93	38.5	-22.5			
Rev. 3.17.11 Note: For Band 13/17 ERP limit is 34.77dBm; For Band 26 limit is 50dBm										

		High Frequency Substitution Measurement UL Korea, Ltd. Suwon Laboratory Chamber 2							
LTE Band 5 3MHz QPSK	<b>Company:</b> Samsung <b>Project #:</b> 4787852400 <b>Date:</b> 03-06-17 <b>Test Engineer:</b> YH Lim <b>Configuration:</b> EUT ONLY, X Position <b>Mode:</b> LTE5 3MHz FUND QPSK								
	<b>Test Equipment:</b> Receiving: VULB9163-749, and 3m Chamber N-type Cable (Setup this one for testing EUT) Substitution: Dipole S/N: 00164753, 3m SMA Cable Warehouse.								
	f	SG reading	Ant. Pol.	Cable Loss	Antenna Gain	ERP	Limit	Margin	Notes
	MHz	(dBm)	(H/V)	(dB)	(dBd)	(dBm)	(dBm)	(dB)	
	Low Ch								
	825.50	11.43	V	1.1	-1.5	8.83	38.5	-29.6	
	825.50	19.39	H	1.1	-1.5	16.79	38.5	-21.7	
	Mid Ch								
	836.50	12.16	V	1.1	-1.4	9.67	38.5	-28.8	
	836.50	19.30	H	1.1	-1.4	16.81	38.5	-21.6	
	High Ch								
	847.50	10.78	V	1.6	-1.3	7.90	38.5	-30.5	
	847.50	19.00	H	1.6	-1.3	16.12	38.5	-22.3	
Rev. 3.17.11 Note: For Band 13/17 ERP limit is 34.77dBm; For Band 26 limit is 50dBm									
LTE Band 5 3MHz 16QAM	<b>Company:</b> Samsung <b>Project #:</b> 4787852400 <b>Date:</b> 03-06-17 <b>Test Engineer:</b> YH Lim <b>Configuration:</b> EUT ONLY, X Position <b>Mode:</b> LTE5 3MHz FUND 16QAM								
	<b>Test Equipment:</b> Receiving: VULB9163-749, and 3m Chamber N-type Cable (Setup this one for testing EUT) Substitution: Dipole S/N: 00164753, 3m SMA Cable Warehouse.								
	f	SG reading	Ant. Pol.	Cable Loss	Antenna Gain	ERP	Limit	Margin	Notes
	MHz	(dBm)	(H/V)	(dB)	(dBd)	(dBm)	(dBm)	(dB)	
	Low Ch								
	825.50	10.58	V	1.1	-1.5	7.98	38.5	-30.5	
	825.50	18.55	H	1.1	-1.5	15.95	38.5	-22.5	
	Mid Ch								
	836.50	11.33	V	1.1	-1.4	8.84	38.5	-29.6	
	836.50	18.54	H	1.1	-1.4	16.05	38.5	-22.4	
	High Ch								
	847.50	9.99	V	1.1	-1.3	7.61	38.5	-30.8	
	847.50	18.24	H	1.1	-1.3	15.86	38.5	-22.6	
Rev. 3.17.11 Note: For Band 13/17 ERP limit is 34.77dBm; For Band 26 limit is 50dBm									

High Frequency Substitution Measurement UL Korea, Ltd. Suwon Laboratory Chamber 2										
LTE Band 5 1.4MHz QPSK	<b>Company:</b>		Samsung							
	<b>Project #:</b>		4787852400							
	<b>Date:</b>		03-07-17							
	<b>Test Engineer:</b>		YH Lim							
	<b>Configuration:</b>		EUT ONLY, X Position							
	<b>Mode:</b>		LTE5 1.4MHz FUND QPSK							
	<b>Test Equipment:</b>									
	Receiving: VULB9163-749, and 3m Chamber N-type Cable (Setup this one for testing EUT)									
	Substitution: Dipole S/N: 00164753, 3m SMA Cable Warehouse.									
	f MHz	SG reading (dBm)	Ant. Pol. (H/V)	Cable Loss (dB)	Antenna Gain (dBd)	ERP (dBm)	Limit (dBm)	Margin (dB)	Notes	
	Low Ch									
	824.70	9.95	V	1.1	-1.5	7.35	38.5	-31.1		
	824.70	17.12	H	1.1	-1.5	14.52	38.5	-23.9		
	Mid Ch									
	836.50	9.24	V	1.1	-1.4	6.75	38.5	-31.7		
836.50	16.47	H	1.1	-1.4	13.98	38.5	-24.5			
High Ch										
848.30	8.10	V	1.6	-1.3	5.22	38.5	-33.2			
848.30	17.30	H	1.6	-1.3	14.42	38.5	-24.0			
Rev. 3.17.11 Note: For Band 13/17 ERP limit is 34.77dBm; For Band 26 limit is 50dBm										
High Frequency Substitution Measurement UL Korea, Ltd. Suwon Laboratory Chamber 2										
<b>Company:</b>		Samsung								
<b>Project #:</b>		4787852400								
<b>Date:</b>		03-07-17								
<b>Test Engineer:</b>		YH Lim								
<b>Configuration:</b>		EUT ONLY, X Position								
<b>Mode:</b>		LTE5 1.4MHz FUND 16QAM								
<b>Test Equipment:</b>										
Receiving: VULB9163-749, and 3m Chamber N-type Cable (Setup this one for testing EUT)										
Substitution: Dipole S/N: 00164753, 3m SMA Cable Warehouse.										
f MHz	SG reading (dBm)	Ant. Pol. (H/V)	Cable Loss (dB)	Antenna Gain (dBd)	ERP (dBm)	Limit (dBm)	Margin (dB)	Notes		
Low Ch										
824.70	9.13	V	1.1	-1.5	6.53	38.5	-31.9			
824.70	16.14	H	1.1	-1.5	13.54	38.5	-24.9			
Mid Ch										
836.50	8.48	V	1.1	-1.4	5.99	38.5	-32.5			
836.50	15.68	H	1.1	-1.4	13.19	38.5	-25.3			
High Ch										
848.30	7.14	V	1.1	-1.3	4.76	38.5	-33.7			
848.30	16.46	H	1.1	-1.3	14.08	38.5	-24.4			
Rev. 3.17.11 Note: For Band 13/17 ERP limit is 34.77dBm; For Band 26 limit is 50dBm										

## 11.2. FIELD STRENGTH OF SPURIOUS RADIATION

### RULE PART(S)

FCC: §2.1053, §22.917

### LIMIT

Part 22.917(a) & Part 24.238(a) & Part 27.53(g) - The power of any emission outside of the authorized operating frequency ranges must be attenuated below the transmitting power (P) by a factor of at least  $43 + 10 \log (P)$  dB.

### TEST PROCEDURE

ANSI / TIA / EIA 603D Clause 2.2.12; ESU40 setting reference to 971168 D01 v02r02

- a) Set the RBW = 100 KHz for emission below 1GHz and 1MHz for emissions above 1GHz
- b) Set VBW  $\geq 3 \times$  RBW;
- c) Set span  $\geq 1.5$  times the OBW;
- d) Sweep time = auto couple;
- e) Detector = peak;
- f) Ensure that the number of measurement points  $\geq$  span/RBW;
- g) Trace mode = max hold;

### RESULTS