

# FCC LTE REPORT

## FCC Certification

**Applicant Name:**  
 SAMSUNG Electronics Co., Ltd.

**Date of Issue:**  
 April 12, 2017

**Location:**

**Address:**  
 129, Samsung-ro, Yeongtong-gu, Suwon-si,  
 Gyeonggi-do, 16677, Rep. of Korea

HCT CO., LTD.,  
 74, Seoicheon-ro 578beon-gil, Majang-myeon,  
 Icheon-si, Gyeonggi-do, 17383, Rep. of KOREA

**Report No.:** HCT-R-1704-F007  
**HCT FRN:** 0005866421

**FCC ID:** A3LSMZ200M

**APPLICANT:** SAMSUNG Electronics Co., Ltd.

**FCC Model(s):** SM-Z200M  
**EUT Type:** Mobile Phone  
**FCC Classification:** Licensed Portable Transmitter Held to Ear (PCE)  
**FCC Rule Part(s):** §27, §2

Mode (MHz)	Tx Frequency (MHz)	Emission Designator	Modulation	EIRP	
				Max. Power (W)	Max. Power (dBm)
LTE – Band4 (1.4)	1710.7 – 1754.3	1M11G7D	QPSK	0.200	23.01
		1M12W7D	16QAM	0.151	21.79
LTE – Band4 (3)	1711.5 – 1753.5	2M70G7D	QPSK	0.202	23.06
		2M71W7D	16QAM	0.165	22.18
LTE – Band4 (5)	1712.5 – 1752.5	4M53G7D	QPSK	0.195	22.89
		4M52W7D	16QAM	0.162	22.10
LTE – Band4 (10)	1715.0 – 1750.0	9M03G7D	QPSK	0.188	22.74
		8M99W7D	16QAM	0.158	21.99
LTE – Band4 (15)	1717.5 – 1747.5	13M5G7D	QPSK	0.190	22.79
		13M5W7D	16QAM	0.160	22.05
LTE – Band4 (20)	1720.0 – 1745.0	18M0G7D	QPSK	0.188	22.74
		18M0W7D	16QAM	0.156	21.94

Mode (MHz)	Tx Frequency (MHz)	Emission Designator	Modulation	ERP	
				Max. Power (W)	Max. Power (dBm)
LTE – Band17 (5)	706.5 – 713.5	4M53G7D	QPSK	0.033	15.13
		4M51W7D	16QAM	0.022	13.40
LTE – Band17 (10)	709.0 – 711.0	8M99G7D	QPSK	0.028	14.47
		8M98W7D	16QAM	0.020	13.02

The measurements shown in this report were made in accordance with the procedures specified in CFR47 section §2.947. I assume full responsibility for the accuracy and completeness of these measurements, and for the qualifications of all persons taking them.

HCT CO., LTD. Certifies that no party to this application has subject to a denial of Federal benefits that includes FCC benefits pursuant to section 5301 of the Anti-Drug Abuse Act of 1998, 21 U.S. C.853(a)



**Report prepared by : Jeong Ho Kim**  
**Engineer of Telecommunication Testing Center**



**Report approved by : Jong Seok Lee**  
**Manager of Telecommunication Testing Center**

This report only responds to the tested sample and may not be reproduced, except in full, without written approval of the HCT Co., Ltd.

## Version

TEST REPORT NO.	DATE	DESCRIPTION
HCT-R-1704-F007	April 12, 2017	- First Approval Report

# Table of Contents

1. GENERAL INFORMATION .....	6
2. INTRODUCTION .....	8
2.1. EUT DESCRIPTION.....	8
2.2. MEASURING INSTRUMENT CALIBRATION.....	8
2.3. TEST FACILITY .....	8
3. DESCRIPTION OF TESTS .....	9
3.1 ERP/EIRP RADIATED POWER AND RADIATED SPURIOUS EMISSIONS.....	9
3.2 AWS – MOBILE FREQUENCY BLOCKS (1710 – 1755 MHz) .....	10
3.3 BLOCK B FREQUENCY RANGE (704 – 710 and 734 – 740 MHz, 777 – 792 MHz) .....	10
3.4 PEAK-AVERAGE RATIO. ....	11
3.5 OCCUPIED BANDWIDTH. ....	13
3.6 SPURIOUS AND HARMONIC EMISSIONS AT ANTENNA TERMINAL.....	14
3.7 FREQUENCY STABILITY / VARIATION OF AMBIENT TEMPERATURE .....	15
4. LIST OF TEST EQUIPMENT .....	16
5. MEASUREMENT UNCERTAINTY.....	17
6. SUMMARY OF TEST RESULTS .....	18
7. SAMPLE CALCULATION.....	19
8. TEST DATA .....	20
8.1 EQUIVALENT ISOTROPIC RADIATED POWER (Band 4) .....	20
8.2 EFFECTIVE RADIATED POWER (Band 17).....	24
8.3 RADIATED SPURIOUS EMISSIONS.....	26
8.3.1 RADIATED SPURIOUS EMISSIONS (1.4 MHz Band 4 LTE) .....	26
8.3.2 RADIATED SPURIOUS EMISSIONS (3 MHz Band 4 LTE) .....	27
8.3.3 RADIATED SPURIOUS EMISSIONS (5 MHz Band 4 LTE) .....	28
8.3.4 RADIATED SPURIOUS EMISSIONS (10 MHz Band 4 LTE) .....	29
8.3.5 RADIATED SPURIOUS EMISSIONS (15 MHz Band 4 LTE) .....	30
8.3.6 RADIATED SPURIOUS EMISSIONS (20 MHz Band 4 LTE) .....	31
8.3.7 RADIATED SPURIOUS EMISSIONS (5 MHz Band 17 LTE).....	32
8.3.8 RADIATED SPURIOUS EMISSIONS (10 MHz Band 17 LTE).....	33
8.4 PEAK-TO-AVERAGE RATIO .....	34
8.5 OCCUPIED BANDWIDTH .....	35
8.6 CONDUCTED SPURIOUS EMISSIONS .....	36
8.6.1 BAND EDGE.....	37
8.7 FREQUENCY STABILITY / VARIATION OF AMBIENT TEMPERATURE .....	38
8.7.1 FREQUENCY STABILITY (1.4 MHz Band 4 LTE) .....	38

8.7.2 FREQUENCY STABILITY (3 MHz Band 4 LTE) .....	39
8.7.3 FREQUENCY STABILITY (5 MHz Band 4 LTE) .....	40
8.7.4 FREQUENCY STABILITY (10 MHz Band 4 LTE) .....	41
8.7.5 FREQUENCY STABILITY (15 MHz Band 4 LTE) .....	42
8.7.6 FREQUENCY STABILITY (20 MHz Band 4 LTE) .....	43
8.7.7 FREQUENCY STABILITY (5 MHz Band 17 LTE) .....	44
8.7.8 FREQUENCY STABILITY (10 MHz Band 17 LTE) .....	45
9. TEST PLOTS.....	46

# MEASUREMENT REPORT

## 1. GENERAL INFORMATION

**Applicant Name:** SAMSUNG Electronics Co., Ltd.

**Address:** 129, Samsung-ro, Yeongtong-gu, Suwon-si, Gyeonggi-do, 16677, Rep. of Korea

**FCC ID:** A3LSMZ200M

**Application Type:** Certification

**FCC Classification:** Licensed Portable Transmitter Held to Ear (PCE)

**FCC Rule Part(s):** §27, §2

**EUT Type:** Mobile Phone

**FCC Model(s):** SM-Z200M

**Tx Frequency:** 1710.7 MHz – 1754.3 MHz (LTE – Band 4 (1.4 MHz))  
1711.5 MHz – 1753.5 MHz (LTE – Band 4 (3 MHz))  
1712.5 MHz – 1752.5 MHz (LTE – Band 4 (5 MHz))  
1715.0 MHz – 1750.0 MHz (LTE – Band 4 (10 MHz))  
1717.5 MHz – 1747.5 MHz (LTE – Band 4 (15 MHz))  
1720.0 MHz – 1745.0 MHz (LTE – Band 4 (20 MHz))

706.5 MHz – 713.5 MHz (LTE – Band 17 (5 MHz))  
709.0 MHz – 711.0 MHz (LTE – Band 17 (10 MHz))

**Max. RF Output Power:**

Band 4 (1.4 MHz):	0.200 W (QPSK) (23.01 dBm)
	0.151 W (16-QAM) (21.79 dBm)
Band 4 (3 MHz):	0.202 W (QPSK) (23.06 dBm)
	0.165 W (16-QAM) (22.18 dBm)
Band 4 (5 MHz):	0.195 W (QPSK) (22.89 dBm)
	0.162 W (16-QAM) (22.10 dBm)
Band 4 (10 MHz):	0.188 W (QPSK) (22.74 dBm)
	0.158 W (16-QAM) (21.99 dBm)
Band 4 (15 MHz):	0.190 W (QPSK) (22.79 dBm)
	0.160 W (16-QAM) (22.05 dBm)
Band 4 (20 MHz):	0.188 W (QPSK) (22.74 dBm)
	0.156 W (16-QAM) (21.94 dBm)
Band 17 (5 MHz) :	0.033 W (QPSK) (15.13 dBm)
	0.022 W (16-QAM) (13.40 dBm)
Band 17 (10 MHz) :	0.028 W (QPSK) (14.47 dBm)
	0.020 W (16-QAM) (13.02 dBm)

**Emission Designator(s):**

Band 4 (1.4 MHz):	1M11G7D (QPSK) / 1M12W7D (16-QAM)
Band 4 (3 MHz):	2M70G7D (QPSK) / 2M71W7D (16-QAM)
Band 4 (5 MHz):	4M53G7D (QPSK) / 4M52W7D (16-QAM)
Band 4 (10 MHz):	9M03G7D (QPSK) / 8M99W7D (16-QAM)
Band 4 (15 MHz):	13M5G7D (QPSK) / 13M5W7D (16-QAM)
Band 4 (20 MHz):	18M0G7D (QPSK) / 18M0W7D (16-QAM)
Band 17 ( 5 MHz) :	4M53G7D (QPSK) / 4M51W7D (16-QAM)
Band 17 (10 MHz) :	8M99G7D (QPSK) / 8M98W7D (16-QAM)

**Date(s) of Tests:** March 24, 2017 ~ April 11, 2017

## **2. INTRODUCTION**

### **2.1. EUT DESCRIPTION**

The SAMSUNG Electronics Co., Ltd.SM-Z200M Mobile Phone consists of LTE 4 and 17.

### **2.2. MEASURING INSTRUMENT CALIBRATION**

The measuring equipment, which was utilized in performing the tests documented herein, has been calibrated in accordance with the manufacturer's recommendations for utilizing calibration equipment, which is traceable to recognized national standards.

### **2.3. TEST FACILITY**

The Fully-anechoic chamber and conducted measurement facility used to collect the radiated data are located at the **74, Seoicheon-ro 578beon-gil, Majang-myeon, Icheon-si, Gyeonggi-do, 17383, Rep. of KOREA.**

## **3. DESCRIPTION OF TESTS**

### **3.1 ERP/EIRP RADIATED POWER AND RADIATED SPURIOUS EMISSIONS**

Note: ERP(Effective Radiated Power), EIRP(Effective Isotropic Radiated Power)

Test Procedure

Radiated emission measurements are performed in the Fully-anechoic chamber. The equipment under test is placed on a non-conductive table 3-meters away from the receive antenna in accordance with ANSI/TIA-603-D-2010 Clause 2.2.17. The turntable is rotated through 360 degrees, and the receiving antenna scans in order to determine the level of the maximized emission. The level and position of the maximized emission is recorded with the spectrum analyzer using a RMS detector.

A half wave dipole is then substituted in place of the EUT. For emissions above 1GHz, a horn antenna is substituted in place of the EUT. The substitute antenna is driven by a signal generator and the previously recorded signal was duplicated.

The power is calculated by the following formula;

$$P_{d(dBm)} = P_{g(dBm)} - \text{cable loss (dB)} + \text{antenna gain (dB)}$$

Where:  $P_d$  is the dipole equivalent power and  $P_g$  is the generator output power into the substitution antenna.

The maximum EIRP is calculated by adding the forward power to the calibrated source plus its appropriate gain value. These steps are repeated with the receiving antenna in both vertical and horizontal polarization. the difference between the gain of the horn and an isotropic antenna are taken into consideration

#### **Radiated spurious emissions**

: Frequency Range : 9 kHz ~ 10<sup>th</sup> Harmonics of highest channel fundamental frequency.

### 3.2 AWS – MOBILE FREQUENCY BLOCKS (1710 – 1755 MHz)

§27.5(h)

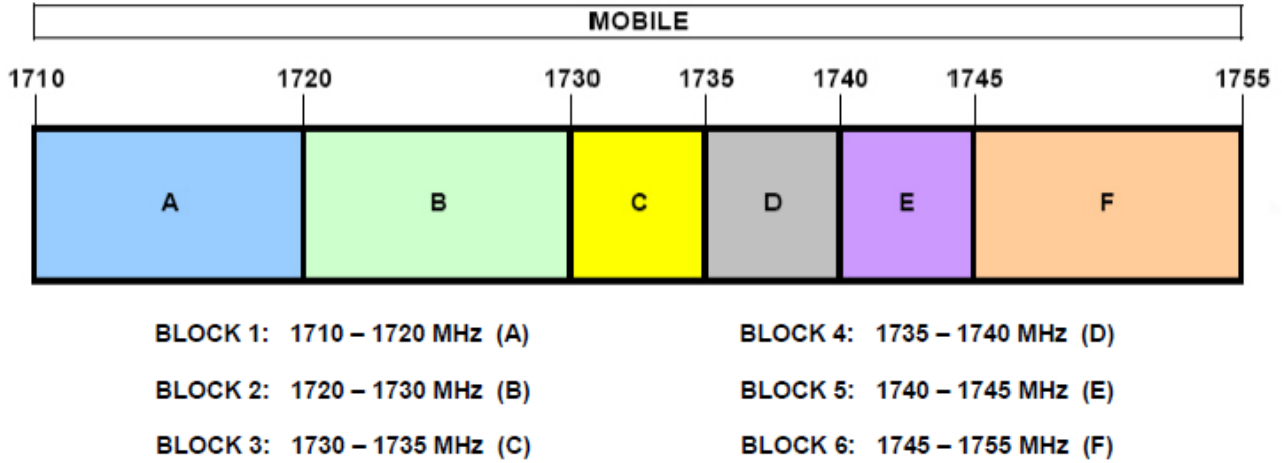

### 3.3 BLOCK B FREQUENCY RANGE (704 – 710 and 734 – 740 MHz, 777 – 792 MHz)

§27.5(c)

698-746 MHz Band. The following frequencies are available for licensing pursuant to this part in the 698–746 MHz band: (1) Three paired channel blocks of 12 MHz each are available for assignment as follows :

Block A : 698 – 704 MHz and 728 – 734 MHz ;

Block B : 704 – 710 MHz and 734 – 740 MHz ; and

Block C : 710 – 716 MHz and 740 – 746 MHz.

The EUT is only being authorized for operation in Blocks B and C.

### 3.4 PEAK-AVERAGE RATIO.

#### Test Procedure

Peak to Average Power Ratio is tested in accordance with KDB971168 D01 Power Meas License Digital Systems v02r02, October 17, 2014, Section 5.7.

#### - Section 5.7.1 CCDF Procedure

- a) Set resolution/measurement bandwidth  $\geq$  signal's occupied bandwidth;
- b) Set the number of counts to a value that stabilizes the measured CCDF curve;
- c) Set the measurement interval as follows:
  - 1) for continuous transmissions, set to 1 ms,
  - 2) for burst transmissions, employ an external trigger that is synchronized with the EUT burst timing sequence, or use the internal burst trigger with a trigger level that allows the burst to stabilize and set the measurement interval to a time that is less than or equal to the burst duration.
- d) Record the maximum PAPR level associated with a probability of 0.1%.

#### - Section 5.7.2 Alternate Procedure

Use one of the procedures presented in 5.1 to measure the total peak power and record as  $P_{Pk}$ . Use one of the applicable procedures presented 5.2 to measure the total average power and record as  $P_{Avg}$ . Determine the P.A.R. from:  $P.A.R_{(dB)} = P_{Pk (dBm)} - P_{Avg (dBm)}$  ( $P_{Avg}$  = Average Power + Duty cycle Factor)

#### 5.1.1 Peak power measurements with a spectrum/signal analyzer or EMI receiver

The following procedure can be used to determine the total peak output power.

- a) Set the RBW  $\geq$  OBW.
- b) Set VBW  $\geq 3 \times$  RBW.
- c) Set span  $\geq 2 \times$  RBW
- d) Sweep time = auto couple.
- e) Detector = peak.
- f) Ensure that the number of measurement points  $\geq$  span/RBW.
- g) Trace mode = max hold.
- h) Allow trace to fully stabilize.
- i) Use the peak marker function to determine the peak amplitude level.

### **5.2.2 Procedures for use with a spectrum/signal analyzer when EUT cannot be configured to transmit continuously and sweep triggering/signal gating cannot be properly implemented**

If the EUT cannot be configured to transmit continuously (burst duty cycle < 98%), then one of the following procedures can be used. The selection of the applicable procedure will depend on the characteristics of the measured burst duty cycle.

Measure the burst duty cycle with a spectrum/signal analyzer or EMC receiver can be used in zero-span mode if the response time and spacing between bins on the sweep are sufficient to permit accurate measurement of the burst on/off time of the transmitted signal.

#### **5.2.2.2 Constant burst duty cycle**

If the measured burst duty cycle is constant (i.e., duty cycle variations are less than  $\pm 2$  percent), then:

- a) Set span to at least 1.5 times the OBW.
- b) Set RBW = 1-5% of the OBW, not to exceed 1 MHz.
- c) Set VBW  $\geq 3 \times$  RBW.
- d) Number of points in sweep  $\geq 2 \times$  span / RBW. (This gives bin-to-bin spacing  $\leq$  RBW/2, so that narrowband signals are not lost between frequency bins.)
- e) Sweep time = auto.
- f) Detector = RMS (power averaging).
- g) Set sweep trigger to "free run".
- h) Trace average at least 100 traces in power averaging (i.e., RMS) mode.
- i) Compute power by integrating the spectrum across the OBW of the signal using the instrument's band power measurement function with band limits set equal to the OBW band edges. If the instrument does not have a band power function, sum the spectrum levels (in power units) at intervals equal to the RBW extending across the entire OBW of the spectrum.
- j) Add  $10 \log (1/x)$ , where  $x$  is the duty cycle, to the measured power in order to compute the average power during the actual transmission times (because the measurement represents an average over both the on and off times of the transmission).

For example, add  $10 \log (1/0.25) = 6$  dB if the duty cycle is a constant 25%.

### 3.5 OCCUPIED BANDWIDTH.

Test set-up

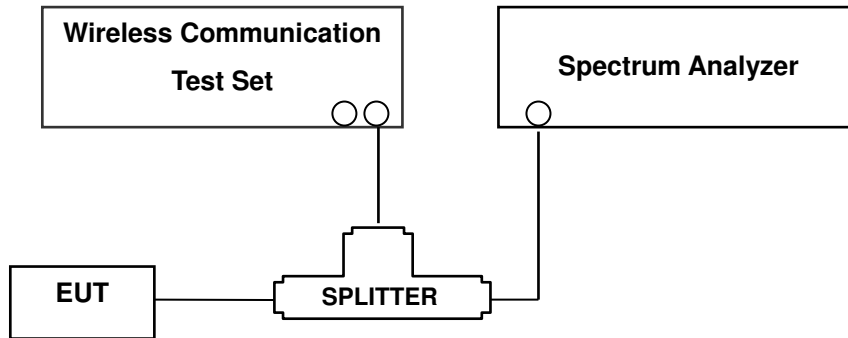

(Configuration of conducted Emission measurement)

The width of a frequency band such that, below the lower and above the upper frequency limits, the mean powers emitted are each equal to a specified percentage 0.5 % of the total mean power of a given emission.

#### Test Procedure

OBW is tested in accordance with KDB971168 D01 Power Meas License Digital Systems v02r02, October 17, 2014, Section 4.2.

The EUT makes a call to the communication simulator. The power was measured with R&S Spectrum Analyzer. All measurements were done at 3 channels(low, middle and high operational range.)

The conducted occupied bandwidth used the power splitter via EUT RF power connector between simulation base station and spectrum analyzer.

The communication simulator station system controlled a EUT to export maximum output power under transmission mode and specific channel frequency. Use OBW measurement function of Spectrum analyzer to measure 99 % occupied bandwidth

### 3.6 SPURIOUS AND HARMONIC EMISSIONS AT ANTENNA TERMINAL.

#### Test Procedure

Spurious and harmonic emissions at antenna terminal is tested in accordance with KDB971168 D01 Power Meas License Digital Systems v02r02, October 17, 2014, Section 6.0.

The level of the carrier and the various conducted spurious and harmonic frequencies is measured by means of a calibrated spectrum analyzer.

The spectrum is scanned from the lowest frequency generated in the equipment up to a frequency including its 10th harmonic. On any frequency outside a licensee's frequency block, the power of any emission shall be attenuated below the transmitter power (P) by at least  $43 + 10 \log(P)$  dB. Compliance with these provisions is based on the use of measurement instrumentation employing a resolution bandwidth of 1 MHz or greater. However, in the 100 kHz bands immediately outside and adjacent to the frequency block a resolution bandwidth of at least 30kHz bandwidth may be employed. The emission bandwidth is defined as the width of the signal between two points, one below the carrier center frequency and one above the carrier center frequency

**NOTES:** The analyzer plot offsets were determined by below conditions.

- For LTE Band 4, total offset 27.2 dB = 20 dB attenuator + 6 dB Divider + 1.2 dB RF cables.
- For LTE Band 17 total offset 26.7 dB = 20 dB attenuator + 6 dB Divider + 0.7 dB RF cables.

### 3.7 FREQUENCY STABILITY / VARIATION OF AMBIENT TEMPERATURE

#### Test Set-up

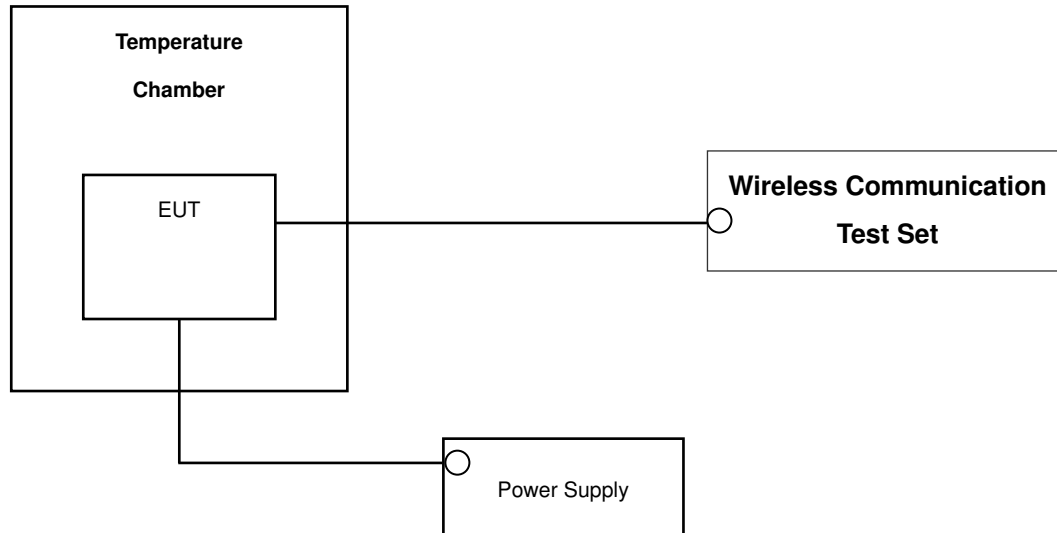

\* Nominal Operating Voltage

#### Test Procedure

Frequency stability is tested in accordance with ANSI/TIA-603-D-2010 section 2.2.2

The frequency stability of the transmitter is measured by:

- a.) **Temperature:** The temperature is varied from - 30 °C to + 50 °C using an environmental chamber.
- b.) **Primary Supply Voltage:** The primary supply voltage is varied from the end point to 100 % of the voltage normally at the input to the device or at the power supply terminals if cables are not normally supplied.

Specification — the frequency stability shall be sufficient to ensure that the fundamental emission stays within the authorized frequency block

#### Time Period and Procedure:

The carrier frequency of the transmitter is measured at room temperature (20°C to provide a reference).

1. The equipment is turned on in a "standby" condition for one minute before applying power to the transmitter. Measurement of the carrier frequency of the transmitter is made within one minute after applying power to the transmitter.
2. Frequency measurements are made at 10°C intervals ranging from -30°C to +50°C. A period of at least one half-hour is provided to allow stabilization of the equipment at each temperature level.

**NOTE: The EUT is tested down to the battery endpoint.**

## 4. LIST OF TEST EQUIPMENT

Manufacture	Model/ Equipment	Serial Number	Calibration Date	Calibration Interval	Calibration Due
REOHDE & SCHWARZ	SCU 18 / AMPLIFIER	10094	09/07/2016	Annual	09/07/2017
Wainwright	WHK1.2/15G-10EF/H.P.F	4	04/11/2016	Annual	04/11/2017
Wainwright	WHK3.3/18G-10EF/H.P.F	2	04/11/2016	Annual	04/11/2017
Hewlett Packard	11667B / Power Splitter	10545	02/15/2017	Annual	02/15/2018
Hewlett Packard	11667B / Power Splitter	11275	04/29/2016	Annual	04/29/2017
Agilent	E3632A/DC Power Supply	KR75303243	07/12/2016	Annual	07/12/2017
Schwarzbeck	UHAP/ Dipole Antenna	557	03/31/2017	Biennial	03/31/2019
Schwarzbeck	UHAP/ Dipole Antenna	558	03/31/2017	Biennial	03/31/2019
EXP	EX-TH400/ Chamber	None	05/31/2016	Annual	05/31/2017
Schwarzbeck	BBHA 9120D/ Horn Antenna	147	09/09/2016	Biennial	09/09/2018
Schwarzbeck	BBHA 9120D/ Horn Antenna	1299	05/15/2015	Biennial	05/15/2017
Schwarzbeck	BBHA 9170/ Horn Antenna(15~40GHz)	BBHA9170342	04/30/2015	Biennial	04/30/2017
Schwarzbeck	BBHA 9170/ Horn Antenna(15~35GHz)	BBHA9170124	04/30/2015	Biennial	04/30/2017
Agilent	N9020A/Signal Analyzer	MY52090906	05/13/2016	Annual	05/13/2017
Hewlett Packard	8493C/ATTENUATOR	17280	06/22/2016	Annual	06/22/2017
REOHDE & SCHWARZ	FSV40/Spectrum Analyzer	1307.9002K40-100931-NK	06/15/2016	Annual	06/15/2017
Agilent	8960 (E5515C)/ Base Station(Now)	MY48360800	10/19/2016	Annual	10/19/2017
Schwarzbeck	FMZB1513/ Loop Antenna(9kHz~30MHz)	1513-175	02/23/2016	Biennial	02/23/2018
Schwarzbeck	VULB9160/ Bilog Antenna	3150	09/30/2016	Biennial	09/30/2018
Schwarzbeck	VULB9160/ Bilog Antenna	3368	10/14/2016	Biennial	10/14/2018
Anritsu Corp.	MT8820C/Wideband Radio Communication Tester	6200576565	07/05/2016	Annual	07/05/2017
Anritsu Corp.	MT8820C/Wideband Radio Communication Tester	6201026545	02/13/2017	Annual	02/13/2018

## 5. MEASUREMENT UNCERTAINTY

The measurement uncertainties shown below were calculated in accordance with the requirements of ANSI C63.4:2014.

All measurement uncertainty values are shown with a coverage factor of  $k = 2$  to indicate a 95 % level of confidence. The measurement data shown herein meets or exceeds the  $U_{\text{CISPR}}$  measurement uncertainty values specified in CISPR 16-4-2 and, thus, can be compared directly to specified limits to determine compliance.

Parameter	Expanded Uncertainty ( $\pm$ dB)
Conducted Disturbance (150 kHz ~ 30 MHz)	1.82
Radiated Disturbance (9 kHz ~ 30 MHz)	3.40
Radiated Disturbance (30 MHz ~ 1 GHz)	4.80
Radiated Disturbance (1 GHz ~ 18 GHz)	6.07

## 6. SUMMARY OF TEST RESULTS

FCC Part Section(s)	Test Description	Test Limit	Test Condition	Test Result
2.1049	Occupied Bandwidth	N/A	CONDUCTED	PASS
2.1051, 27.53(g), 27.53(h)	Band Edge / Spurious and Harmonic Emissions at Antenna Terminal.	$< 43 + 10 \log_{10} (P[\text{Watts}])$ at Band Edge and for all-of-band emissions		PASS
27.50(d)(5)	Peak-Average Ratio	$< 13 \text{ dB}$		PASS
2.1046	* Conducted Output Power	N/A		PASS
2.1055, 27.54	Frequency stability / variation of ambient temperature	Emission must remain in band		PASS
27.50(c)(10)	Effective Radiated Power (Band 17)	$< 3 \text{ Watts max. ERP}$	RADIATED	PASS
27.50(d)(4)	Equivalent Isotropic Radiated Power (Band 4)	$< 1 \text{ Watts max. EIRP}$		PASS
2.1053, 27.53(g), 27.53(h)	Undesirable Out-of-Band Emissions	$< 43 + 10 \log_{10} (P[\text{Watts}])$ for all out-of-band emissions		PASS

\*: See SAR Report

## 7. SAMPLE CALCULATION

### A. EIRP Sample Calculation

Mode	Ch./ Freq.		Measured Level(dBm)	Substitute LEVEL(dBm)	Ant. Gain (dBi)	C.L	Pol.	Limit W	EIRP	
	channel	Freq.(MHz)							W	dBm
LTE Band4	20175	1,732.50	-15.75	18.45	9.90	1.76	H	< 1.00	0.456	26.59

**EIRP = Substitute LEVEL(dBm) + Ant. Gain – CL(Cable Loss)**

- 1) The EUT mounted on a wooden tripod is 2.5 meter above test site ground level.
- 2) During the test , the turn table is rotated and the antenna height is found.
- 3) Record the field strength meter's level.
- 4) Replace the EUT with dipole/Horn antenna that is connected to a calibrated signal generator.
- 5) Increase the signal generator output till the field strength meter's level is equal to the item (3).
- 6) The signal generator output level with Ant. Gain and cable loss are the rating of equivalent isotropic radiated power (EIRP).

## B. Emission Designator

### QPSK Modulation

**Emission Designator = 4M48G7D**

LTE BW = 4.48 MHz

G = Phase Modulation

7 = Quantized/Digital Info

D = Data transmission; telemetry; telecommand

### 16QAM Modulation

**Emission Designator = 4M48W7D**

LTE BW = 4.48 MHz

W = main carrier modulated in a combination of two

or more of the following modes;

amplitude, angle, pulse

7 = Quantized/Digital Info

D = Data transmission; telemetry; telecommand

## 8. TEST DATA

### 8.1 EQUIVALENT ISOTROPIC RADIATED POWER (Band 4)

Freq (MHz)	Bandwidth	Modulation	Measured Level (dBm)	Substitute Level (dBm)	Ant. Gain(dBi)	C.L	Pol	Limit	EIRP	
								W	W	dBm
1710.7	1.4 MHz	QPSK	-17.68	15.66	9.37	2.45	H	< 1.00	0.181	22.58
		16-QAM	-18.47	14.87	9.37	2.45	H		0.151	21.79
1732.5		QPSK	-17.50	15.82	9.44	2.47	H		0.190	22.79
		16-QAM	-18.99	14.33	9.44	2.47	H		0.135	21.30
1754.3		QPSK	-17.37	15.95	9.53	2.47	H		0.200	23.01
		16-QAM	-18.66	14.66	9.53	2.47	H		0.149	21.72

#### Equivalent Isotropic Radiated Power Data (1.4 MHz Band4 LTE)

Note: All of RB size has been tested for emissions and EIRP, with the 1RB configuration observed as the worst case

Freq (MHz)	Bandwidth	Modulation	Measured Level (dBm)	Substitute Level (dBm)	Ant. Gain(dBi)	C.L	Pol	Limit	EIRP	
								W	W	dBm
1711.5	3 MHz	QPSK	-17.64	15.70	9.37	2.45	H	< 1.00	0.183	22.62
		16-QAM	-18.46	14.88	9.37	2.45	H		0.151	21.80
1732.5		QPSK	-17.52	15.80	9.44	2.47	H		0.189	22.77
		16-QAM	-18.89	14.43	9.44	2.47	H		0.138	21.40
1753.5		QPSK	-17.32	16.00	9.53	2.47	H		0.202	23.06
		16-QAM	-18.20	15.12	9.53	2.47	H		0.165	22.18

#### Equivalent Isotropic Radiated Power Data (3 MHz Band4 LTE)

Note: All of RB size has been tested for emissions and EIRP, with the 1RB configuration observed as the worst case

Freq (MHz)	Bandwidth	Modulation	Measured Level (dBm)	Substitute Level (dBm)	Ant. Gain(dBi)	C.L	Pol	Limit	EIRP	
								W	W	dBm
1712.5	5 MHz	QPSK	-17.70	15.64	9.37	2.45	H	< 1.00	0.180	22.56
		16-QAM	-18.58	14.76	9.37	2.45	H		0.147	21.68
1732.5		QPSK	-17.58	15.74	9.44	2.47	H		0.187	22.71
		16-QAM	-19.06	14.26	9.44	2.47	H		0.133	21.23
1752.5		QPSK	-17.47	15.85	9.51	2.47	H		0.195	22.89
		16-QAM	-18.26	15.06	9.51	2.47	H		0.162	22.10

**Equivalent Isotropic Radiated Power Data (5 MHz Band4 LTE)**

Note: All of RB size has been tested for emissions and EIRP, with the 1RB configuration observed as the worst case

Freq (MHz)	Bandwidth	Modulation	Measured Level (dBm)	Substitute Level (dBm)	Ant. Gain(dBi)	C.L	Pol	Limit	EIRP	
								W	W	dBm
1715.0	10 MHz	QPSK	-17.83	15.51	9.39	2.46	H	< 1.00	0.175	22.44
		16-QAM	-18.57	14.77	9.39	2.46	H		0.148	21.70
1732.5		QPSK	-17.67	15.65	9.44	2.47	H		0.183	22.62
		16-QAM	-18.95	14.37	9.44	2.47	H		0.136	21.34
1750.0		QPSK	-17.62	15.70	9.51	2.47	H		0.188	22.74
		16-QAM	-18.37	14.95	9.51	2.47	H		0.158	21.99

**Equivalent Isotropic Radiated Power Data (10 MHz Band4 LTE)**

Note: All of RB size has been tested for emissions and EIRP, with the 1RB configuration observed as the worst case

Freq (MHz)	Bandwidth	Modulation	Measured Level (dBm)	Substitute Level (dBm)	Ant. Gain(dBi)	C.L	Pol	Limit	EIRP	
								W	W	dBm
1717.5	15 MHz	QPSK	-17.73	15.61	9.40	2.47	H	< 1.00	0.180	22.54
		16-QAM	-18.53	14.81	9.40	2.47	H		0.149	21.74
1732.5		QPSK	-17.56	15.76	9.44	2.47	H		0.187	22.73
		16-QAM	-18.88	14.44	9.44	2.47	H		0.138	21.41
1747.5		QPSK	-17.57	15.75	9.51	2.47	H		0.190	22.79
		16-QAM	-18.31	15.01	9.51	2.47	H		0.160	22.05

**Equivalent Isotropic Radiated Power Data (15 MHz Band4 LTE)**

Note: All of RB size has been tested for emissions and EIRP, with the 1RB configuration observed as the worst case

Freq (MHz)	Bandwidth	Modulation	Measured Level (dBm)	Substitute Level (dBm)	Ant. Gain(dBi)	C.L	Pol	Limit	EIRP	
								W	W	dBm
1720.0	20 MHz	QPSK	-17.79	15.55	9.40	2.47	H	< 1.00	0.177	22.48
		16-QAM	-18.56	14.78	9.40	2.47	H		0.148	21.71
1732.5		QPSK	-17.61	15.71	9.44	2.47	H		0.185	22.68
		16-QAM	-18.35	14.97	9.44	2.47	H		0.156	21.94
1745.0		QPSK	-17.64	15.72	9.49	2.47	H		0.188	22.74
		16-QAM	-18.50	14.86	9.49	2.47	H		0.154	21.88

**Equivalent Isotropic Radiated Power Data (20 MHz Band4 LTE)**

Note: All of RB size has been tested for emissions and EIRP, with the 1RB configuration observed as the worst case

**NOTES:**

Equivalent Isotropic Radiated Power Measurements by Substitution Method  
according to ANSI/TIA/EIA-603-D-2010 June 24, 2010:

The EUT was placed on a non-conductive styrofoam resin table 3-meters from the receive antenna. The receive antenna height and turntable rotation was adjusted for the highest reading on the receive spectrum analyzer. For LTE signals, RBW = 1-5% of the OBW, not to exceed 1MHz, VBW  $\geq 3 \times$  RBW, Detector = RMS. A Horn antenna was substituted in place of the EUT. This Horn antenna was driven by a signal generator and the level of the signal generator was adjusted to obtain the same receive spectrum analyzer reading. The conducted power at the terminals of the Horn antenna is measured. The difference between the gain of the horn and an isotropic antenna is taken into consideration and the EIRP is recorded.

Also, we have done x, y, z planes in EUT and horizontal and vertical polarization in detecting antenna. The worst case of the EUT is x plane in LTE mode. Also worst case of detecting Antenna is horizontal polarization in LTE mode.

### 8.2 EFFECTIVE RADIATED POWER (Band 17)

Freq (MHz)	Bandwidth	Modulation	Measured Level (dBm)	Substitute Level (dBm)	Ant. Gain(dBd)	C.L	Pol	Limit	ERP	
								W	W	dBm
706.5	5 MHz	QPSK	-35.47	26.35	-10.20	1.54	V	< 3.00	0.029	14.61
		16-QAM	-37.37	24.45	-10.20	1.54	V		0.019	12.71
710.0		QPSK	-34.95	26.65	-10.22	1.55	V		0.031	14.88
		16-QAM	-36.43	25.17	-10.22	1.55	V		0.022	13.40
713.5		QPSK	-34.52	26.92	-10.24	1.55	V		0.033	15.13
		16-QAM	-36.39	25.05	-10.24	1.55	V		0.021	13.26

#### Effective Radiated Power Data (5 MHz Band 17 LTE)

Note: All of RB size has been tested for emissions and ERP, with the 1RB configuration observed as the worst case

Freq (MHz)	Bandwidth	Modulation	Measured Level (dBm)	Substitute Level (dBm)	Ant. Gain(dBd)	C.L	Pol	Limit	ERP	
								W	W	dBm
709.0	10 MHz	QPSK	-35.47	26.21	-10.22	1.54	V	< 3.00	0.028	14.45
		16-QAM	-37.43	24.25	-10.22	1.54	V		0.018	12.49
710.0		QPSK	-35.37	26.23	-10.22	1.55	V		0.028	14.46
		16-QAM	-36.84	24.76	-10.22	1.55	V		0.020	12.99
711.0		QPSK	-35.24	26.25	-10.23	1.55	V		0.028	14.47
		16-QAM	-36.69	24.80	-10.23	1.55	V		0.020	13.02

#### Effective Radiated Power Data (10 MHz Band 17 LTE)

Note: All of RB size has been tested for emissions and ERP, with the 1RB configuration observed as the worst case

**NOTES:**

Effective Radiated Power Output Measurements by Substitution Method  
according to ANSI/TIA/EIA-603-D-2010 June 24, 2010:

The EUT was placed on a non-conductive styrofoam resin table 3-meters from the receive antenna. The receive antenna height and turntable rotation was adjusted for the highest reading on the receive spectrum analyzer. For LTE signals, RBW = 1-5% of the OBW, not to exceed 1MHz, VBW  $\geq 3 \times$  RBW, Detector = RMS. A half-wave dipole was substituted in place of the EUT. This dipole antenna was driven by a signal generator and the level of the signal generator was adjusted to obtain the same receive spectrum analyzer reading. The conducted power at the terminals of the dipole is measured. The ERP is recorded.

Also, we have done x, y, z planes in EUT and horizontal and vertical polarization in detecting antenna. The worst case of the EUT is y plane in LTE mode. Also worst case of detecting Antenna is vertical polarization in LTE mode.

## 8.3 RADIATED SPURIOUS EMISSIONS

### 8.3.1 RADIATED SPURIOUS EMISSIONS (1.4 MHz Band 4 LTE)

- ▣ OPERATING FREQUENCY: 1754.30 MHz
- ▣ MEASURED OUTPUT POWER: 23.01 dBm = 0.200 W
- ▣ MODULATION SIGNAL: 1.4 MHz QPSK
- ▣ DISTANCE: 3 meters
- ▣ LIMIT:  $43 + 10 \log_{10}(W) =$  36.01 dBc

Ch	Freq (MHz)	Measured Level (dBm)	Ant. Gain (dBi)	Substitute Level (dBm)	C.L	Pol	EIRP (dBm)	dBc
19957 (1710.7)	3,421.40	-51.81	12.19	-58.98	1.49	H	-48.28	71.29
	5,132.10	-55.06	12.76	-55.94	2.49	H	-45.67	68.68
	6,842.80	-49.83	12.06	-46.12	3.49	V	-37.55	60.56
20175 (1732.5)	3,465.00	-53.84	12.28	-60.73	1.49	V	-49.94	72.95
	5,197.50	-54.62	12.86	-55.73	2.57	V	-45.44	68.45
	6,930.00	-48.55	11.87	-43.95	3.53	H	-35.61	58.62
20393 (1754.3)	3,508.60	-55.31	12.36	-61.76	1.53	V	-50.93	73.94
	5,262.90	-51.54	12.95	-53.33	2.63	H	-43.01	66.02
	7,017.20	-45.40	11.73	-42.37	3.64	H	-34.28	57.29

- NOTES:**
1. Radiated Spurious Emission Measurements at 3 meters by Substitution Method according to ANSI/TIA/EIA-603-D-2010 June 24, 2010:
  2. We are performed all frequency to 10<sup>th</sup> harmonics from 9 kHz. Measurements above show only up to 3 maximum emissions noted, or would be lesser if no specific emissions from the EUT are recorded (ie: margin > 20 dB from the applicable limit) and considered that's already beyond the background noise floor.
  3. We have done x, y, z planes in EUT and horizontal and vertical polarization in detecting antenna.
  4. All of RB size has been tested for emissions and EIRP, with the 1RB configuration observed as the worst case
  5. We are performed 16QAM and QPSK modulations. The worst case data are reported in the table above.

### 8.3.2 RADIATED SPURIOUS EMISSIONS (3 MHz Band 4 LTE)

- ▣ OPERATING FREQUENCY: 1753.50 MHz
- ▣ MEASURED OUTPUT POWER: 23.06 dBm = 0.202 W
- ▣ MODULATION SIGNAL: 3 MHz QPSK
- ▣ DISTANCE: 3 meters
- ▣ LIMIT:  $43 + 10 \log_{10}(W) =$  36.06 dBc

Ch	Freq (MHz)	Measured Level (dBm)	Ant. Gain (dBi)	Substitute Level (dBm)	C.L	Pol	EIRP (dBm)	dBc
19965 (1711.5)	3,423.00	-53.35	12.20	-60.64	1.50	H	-49.93	72.99
	5,134.50	-56.95	12.76	-57.83	2.49	H	-47.56	70.62
	6,846.00	-50.43	12.05	-46.56	3.49	H	-38.00	61.06
20175 (1732.5)	3,465.00	-55.78	12.28	-62.67	1.49	H	-51.88	74.94
	5,197.50	-57.32	12.86	-58.43	2.57	V	-48.14	71.20
	6,930.00	-51.10	11.87	-46.50	3.53	V	-38.16	61.22
20385 (1753.5)	3,507.00	-55.35	12.36	-61.80	1.53	H	-50.97	74.03
	5,260.50	-56.86	12.95	-58.65	2.63	V	-48.33	71.39
	7,014.00	-46.88	11.73	-44.10	3.64	H	-36.01	59.07

- NOTES:**
1. Radiated Spurious Emission Measurements at 3 meters by Substitution Method according to ANSI/TIA/EIA-603-D-2010 June 24, 2010:
  2. We are performed all frequency to 10<sup>th</sup> harmonics from 9 kHz. Measurements above show only up to 3 maximum emissions noted, or would be lesser if no specific emissions from the EUT are recorded (ie: margin > 20 dB from the applicable limit) and considered that's already beyond the background noise floor.
  3. We have done x, y, z planes in EUT and horizontal and vertical polarization in detecting antenna.
  4. All of RB size has been tested for emissions and EIRP, with the 1RB configuration observed as the worst case
  5. We are performed 16QAM and QPSK modulations. The worst case data are reported in the table above.

### 8.3.3 RADIATED SPURIOUS EMISSIONS (5 MHz Band 4 LTE)

- ▣ OPERATING FREQUENCY: 1752.50 MHz
- ▣ MEASURED OUTPUT POWER: 22.89 dBm = 0.195 W
- ▣ MODULATION SIGNAL: 5 MHz QPSK
- ▣ DISTANCE: 3 meters
- ▣ LIMIT:  $43 + 10 \log_{10}(W) =$  35.89 dBc

Ch	Freq (MHz)	Measured Level (dBm)	Ant. Gain (dBi)	Substitute Level (dBm)	C.L	Pol	EIRP (dBm)	dBc
19975 (1712.5)	3,425.00	-52.78	12.20	-60.07	1.50	H	-49.36	72.25
	5,137.50	-57.51	12.77	-58.34	2.50	H	-48.07	70.96
	6,850.00	-49.98	12.04	-45.95	3.49	H	-37.40	60.29
20175 (1732.5)	3,465.00	-55.76	12.28	-62.65	1.49	V	-51.86	74.75
	5,197.50	-57.23	12.86	-58.34	2.57	V	-48.05	70.94
	6,930.00	-49.22	11.87	-44.62	3.53	H	-36.28	59.17
20375 (1752.5)	3,505.00	-55.10	12.36	-61.65	1.54	H	-50.83	73.72
	5,257.50	-56.01	12.95	-57.80	2.63	V	-47.48	70.37
	7,010.00	-48.93	11.73	-46.15	3.64	H	-38.06	60.95

- NOTES:**
1. Radiated Spurious Emission Measurements at 3 meters by Substitution Method according to ANSI/TIA/EIA-603-D-2010 June 24, 2010:
  2. We are performed all frequency to 10<sup>th</sup> harmonics from 9 kHz. Measurements above show only up to 3 maximum emissions noted, or would be lesser if no specific emissions from the EUT are recorded (ie: margin > 20 dB from the applicable limit) and considered that's already beyond the background noise floor.
  3. We have done x, y, z planes in EUT and horizontal and vertical polarization in detecting antenna.
  4. All of RB size has been tested for emissions and EIRP, with the 1RB configuration observed as the worst case
  5. We are performed 16QAM and QPSK modulations. The worst case data are reported in the table above.

### 8.3.4 RADIATED SPURIOUS EMISSIONS (10 MHz Band 4 LTE)

- ▣ OPERATING FREQUENCY: 1750.00 MHz
- ▣ MEASURED OUTPUT POWER: 22.74 dBm = 0.188 W
- ▣ MODULATION SIGNAL: 10 MHz QPSK
- ▣ DISTANCE: 3 meters
- ▣ LIMIT:  $43 + 10 \log_{10}(W) =$  35.74 dBc

Ch	Freq (MHz)	Measured Level (dBm)	Ant. Gain (dBi)	Substitute Level (dBm)	C.L	Pol	EIRP (dBm)	dBc
20000 (1715.0)	3,430.00	-52.51	12.21	-59.91	1.50	H	-49.20	71.94
	5,145.00	-56.18	12.78	-56.94	2.51	H	-46.67	69.41
	6,860.00	-51.38	12.01	-47.30	3.49	V	-38.78	61.52
20175 (1732.5)	3,465.00	-56.82	12.28	-63.71	1.49	V	-52.92	75.66
	5,197.50	-57.13	12.86	-58.24	2.57	H	-47.95	70.69
	6,930.00	-49.98	11.87	-45.38	3.53	H	-37.04	59.78
20350 (1750.0)	3,500.00	-54.01	12.35	-60.66	1.55	H	-49.86	72.60
	5,250.00	-57.29	12.93	-59.10	2.63	H	-48.80	71.54
	7,000.00	-50.62	11.73	-48.49	3.63	H	-40.39	63.13

- NOTES:**
1. Radiated Spurious Emission Measurements at 3 meters by Substitution Method according to ANSI/TIA/EIA-603-D-2010 June 24, 2010:
  2. We are performed all frequency to 10<sup>th</sup> harmonics from 9 kHz. Measurements above show only up to 3 maximum emissions noted, or would be lesser if no specific emissions from the EUT are recorded (ie: margin > 20 dB from the applicable limit) and considered that's already beyond the background noise floor.
  3. We have done x, y, z planes in EUT and horizontal and vertical polarization in detecting antenna.
  4. All of RB size has been tested for emissions and EIRP, with the 1RB configuration observed as the worst case
  5. We are performed 16QAM and QPSK modulations. The worst case data are reported in the table above.

### 8.3.5 RADIATED SPURIOUS EMISSIONS (15 MHz Band 4 LTE)

- ▣ OPERATING FREQUENCY: 1747.50 MHz
- ▣ MEASURED OUTPUT POWER: 22.79 dBm = 0.190 W
- ▣ MODULATION SIGNAL: 15 MHz QPSK
- ▣ DISTANCE: 3 meters
- ▣ LIMIT:  $43 + 10 \log_{10}(W) =$  35.79 dBc

Ch	Freq (MHz)	Measured Level (dBm)	Ant. Gain (dBi)	Substitute Level (dBm)	C.L	Pol	EIRP (dBm)	dBc
20025 (1717.5)	3,435.00	-52.72	12.22	-59.97	1.51	H	-49.26	72.05
	5,152.50	-55.78	12.79	-56.47	2.52	V	-46.20	68.99
	6,870.00	-51.26	11.99	-47.50	3.44	H	-38.95	61.74
20175 (1732.5)	3,465.00	-56.43	12.28	-63.32	1.49	H	-52.53	75.32
	5,197.50	-57.34	12.86	-58.45	2.57	V	-48.16	70.95
	6,930.00	-50.84	11.87	-46.24	3.53	H	-37.90	60.69
20325 (1747.5)	3,495.00	-54.75	12.34	-61.36	1.54	H	-50.56	73.35
	5,242.50	-57.72	12.92	-59.18	2.60	V	-48.86	71.65
	6,990.00	-51.85	11.75	-46.91	3.52	H	-38.68	61.47

- NOTES:**
1. Radiated Spurious Emission Measurements at 3 meters by Substitution Method according to ANSI/TIA/EIA-603-D-2010 June 24, 2010:
  2. We are performed all frequency to 10<sup>th</sup> harmonics from 9 kHz. Measurements above show only up to 3 maximum emissions noted, or would be lesser if no specific emissions from the EUT are recorded (ie: margin > 20 dB from the applicable limit) and considered that's already beyond the background noise floor.
  3. We have done x, y, z planes in EUT and horizontal and vertical polarization in detecting antenna.
  4. All of RB size has been tested for emissions and EIRP, with the 1RB configuration observed as the worst case
  5. We are performed 16QAM and QPSK modulations. The worst case data are reported in the table above.

### 7.3.6 RADIATED SPURIOUS EMISSIONS (20 MHz Band 4 LTE)

- ▣ OPERATING FREQUENCY: 1745.00 MHz
- ▣ MEASURED OUTPUT POWER: 22.74 dBm = 0.188 W
- ▣ MODULATION SIGNAL: 20 MHz QPSK
- ▣ DISTANCE: 3 meters
- ▣ LIMIT:  $43 + 10 \log_{10}(W) =$  35.74 dBc

Ch	Freq (MHz)	Measured Level (dBm)	Ant. Gain (dBi)	Substitute Level (dBm)	C.L	Pol	EIRP (dBm)	dBc
20050 (1720.0)	3,440.00	-53.16	12.23	-60.27	1.52	V	-49.56	72.30
	5,160.00	-57.49	12.80	-58.52	2.53	H	-48.25	70.99
	6,880.00	-50.68	11.97	-46.75	3.46	H	-38.24	60.98
20175 (1732.5)	3,465.00	-57.41	12.28	-64.30	1.49	H	-53.51	76.25
	5,197.50	-56.48	12.86	-57.59	2.57	V	-47.30	70.04
	6,930.00	-51.29	11.87	-46.69	3.53	H	-38.35	61.09
20300 (1745.0)	3,490.00	-54.98	12.33	-61.55	1.53	H	-50.75	73.49
	5,235.00	-57.23	12.91	-58.76	2.59	V	-48.44	71.18
	6,980.00	-52.69	11.77	-47.62	3.50	V	-39.35	62.09

- NOTES:**
1. Radiated Spurious Emission Measurements at 3 meters by Substitution Method according to ANSI/TIA/EIA-603-D-2010 June 24, 2010:
  2. We are performed all frequency to 10<sup>th</sup> harmonics from 9 kHz. Measurements above show only up to 3 maximum emissions noted, or would be lesser if no specific emissions from the EUT are recorded (ie: margin > 20 dB from the applicable limit) and considered that's already beyond the background noise floor.
  3. We have done x, y, z planes in EUT and horizontal and vertical polarization in detecting antenna.
  4. All of RB size has been tested for emissions and EIRP, with the 1RB configuration observed as the worst case
  5. We are performed 16QAM and QPSK modulations. The worst case data are reported in the table above.

### 8.3.7 RADIATED SPURIOUS EMISSIONS (5 MHz Band 17 LTE)

- ▣ OPERATING FREQUENCY: 713.50 MHz
- ▣ MEASURED OUTPUT POWER: 15.13 dBm = 0.033 W
- ▣ MODULATION SIGNAL: 5 MHz QPSK
- ▣ DISTANCE: 3 meters
- ▣ LIMIT:  $43 + 10 \log_{10}(W) =$  28.13 dBc

Ch	Freq (MHz)	Measured Level (dBm)	Ant. Gain (dBd)	Substitute Level (dBm)	C.L	Pol	ERP (dBm)	dBc
23755 (706.50)	1,413.00	-43.06	8.05	-51.13	1.19	H	-44.27	59.40
	2,119.50	-44.97	10.46	-52.54	1.18	H	-43.26	58.39
	2,826.00	-35.11	11.18	-41.36	1.23	H	-31.41	46.54
	3,532.50	-37.76	12.38	-44.15	1.53	H	-33.30	48.43
23790 (710.00)	1,420.00	-44.92	8.09	-53.26	1.18	H	-46.35	61.48
	2,130.00	-44.78	10.47	-52.03	1.17	H	-42.73	57.86
	2,840.00	-39.35	11.19	-45.49	1.26	H	-35.56	50.69
	3,550.00	-43.15	12.39	-49.44	1.55	H	-38.60	53.73
23825 (713.50)	1,427.00	-43.79	8.11	-52.32	1.18	H	-45.39	60.52
	2,140.50	-48.83	10.49	-55.73	1.17	H	-46.41	61.54
	2,854.00	-37.32	11.20	-43.51	1.27	H	-33.58	48.71
	3,567.50	-43.03	12.40	-49.33	1.51	H	-38.44	53.57

- NOTES:**
1. Radiated Spurious Emission Measurements at 3 meters by Substitution Method according to ANSI/TIA/EIA-603-D-2010 June 24, 2010:
  2. We are performed all frequency to 10<sup>th</sup> harmonics from 9 kHz. Measurements above show only up to 3 maximum emissions noted, or would be lesser if no specific emissions from the EUT are recorded (ie: margin > 20 dB from the applicable limit) and considered that's already beyond the background noise floor.
  3. We have done x, y, z planes in EUT and horizontal and vertical polarization in detecting antenna.
  4. All of RB size has been tested for emissions and ERP, with the 1RB configuration observed as the worst case
  5. We are performed 16QAM and QPSK modulations. The worst case data are reported in the table above.

### 8.3.8 RADIATED SPURIOUS EMISSIONS (10 MHz Band 17 LTE)

- ▣ OPERATING FREQUENCY: 711.00 MHz
- ▣ MEASURED OUTPUT POWER: 14.47 dBm = 0.028 W
- ▣ MODULATION SIGNAL: 10 MHz QPSK
- ▣ DISTANCE: 3 meters
- ▣ LIMIT:  $43 + 10 \log_{10}(W) =$  27.47 dBc

Ch	Freq (MHz)	Measured Level (dBm)	Ant. Gain (dBd)	Substitute Level (dBm)	C.L	Pol	ERP (dBm)	dBc
23780 (709.00)	1,418.00	-43.21	8.08	-51.48	1.18	H	-44.58	59.05
	2,127.00	-45.05	10.47	-52.40	1.17	H	-43.10	57.57
	2,836.00	-34.64	11.19	-40.80	1.25	H	-30.86	45.33
	3,545.00	-38.61	12.39	-45.03	1.56	H	-34.20	48.67
23790 (710.00)	1,420.00	-46.03	8.09	-54.37	1.18	H	-47.46	61.93
	2,130.00	-46.39	10.47	-53.64	1.17	H	-44.34	58.81
	2,840.00	-37.09	11.19	-43.23	1.26	H	-33.30	47.77
	3,550.00	-37.95	12.39	-44.24	1.55	H	-33.40	47.87
23800 (711.00)	1,422.00	-49.51	8.10	-57.91	1.18	H	-50.99	65.46
	2,133.00	-45.39	10.47	-52.53	1.17	H	-43.23	57.70
	2,844.00	-37.67	11.19	-43.86	1.26	H	-33.93	48.40
	3,555.00	-42.84	12.39	-49.19	1.54	H	-38.34	52.81

- NOTES:**
1. Radiated Spurious Emission Measurements at 3 meters by Substitution Method according to ANSI/TIA/EIA-603-D-2010 June 24, 2010:
  2. We are performed all frequency to 10<sup>th</sup> harmonics from 9 kHz. Measurements above show only up to 3 maximum emissions noted, or would be lesser if no specific emissions from the EUT are recorded (ie: margin > 20 dB from the applicable limit) and considered that's already beyond the background noise floor.
  3. We have done x, y, z planes in EUT and horizontal and vertical polarization in detecting antenna.
  4. All of RB size has been tested for emissions and ERP, with the 1RB configuration observed as the worst case
  5. We are performed 16QAM and QPSK modulations. The worst case data are reported in the table above.

**8.4 PEAK-TO-AVERAGE RATIO**

Band	Band Width	Frequency (MHz)	Modulation	Resource Block Size	Resource Block Offset	Data (dB )
4	1.4 MHz	1732.5	QPSK	6	0	5.50
			16-QAM	6		6.08
	3 MHz		QPSK	15		5.67
			16-QAM	15		6.34
	5 MHz		QPSK	25		5.54
			16-QAM	25		6.17
	10 MHz		QPSK	50		5.71
			16-QAM	50		6.21
	15 MHz		QPSK	75		5.56
			16-QAM	75		6.14
	20 MHz		QPSK	100		5.51
			16-QAM	100		6.16

- Plots of the EUT's Peak- to- Average Ratio are shown Page 55~ 60.

### 8.5 OCCUPIED BANDWIDTH

Band	Band Width	Frequency (MHz)	Modulation	Resource Block Size	Resource Block Offset	Data ( MHz )
4	1.4 MHz	1732.5	QPSK	6	0	1.1128
			16-QAM	6	0	1.1167
	3 MHz		QPSK	15	0	2.6976
			16-QAM	15	0	2.7054
	5 MHz		QPSK	25	0	4.5263
			16-QAM	25	0	4.5206
	10 MHz		QPSK	50	0	9.0321
			16-QAM	50	0	8.9865
	15 MHz		QPSK	75	0	13.486
			16-QAM	75	0	13.487
	20 MHz		QPSK	100	0	17.963
			16-QAM	100	0	18.008

Band	Band Width	Frequency (MHz)	Modulation	Resource Block Size	Resource Block Offset	Data ( MHz )
17	5 MHz	710.0	QPSK	25	0	4.5274
			16-QAM	25	0	4.5142
	10 MHz		QPSK	50	0	8.9877
			16-QAM	50	0	8.9776

- Plots of the EUT's Occupied Bandwidth are shown Page 47 ~ 54.

## 8.6 CONDUCTED SPURIOUS EMISSIONS

### ■FACTORS FOR FREQUENCY

Frequency Range (GHz)	Factor [dB]
0.03 – 1	27.145
1 – 5	26.960
5 – 10	27.542
10 – 15	28.439
15 – 20	29.144
Above 20	30.148

### NOTES:

Factor(dB) = Cable Loss + Attenuator +Power Splitter

Band	Band Width (MHz)	Frequency (MHz)	Frequency of Maximum Harmonic (GHz)	Factor (dB)	Measurement Maximum Data (dBm)	Result (dBm)	Limit (dBm)
4	1.4	1710.7	18.9435	29.144	-62.32	-33.176	-13.00
		1732.5	18.9070	29.144	-62.07	-32.926	
		1754.3	18.9645	29.144	-62.22	-33.076	
	3	1711.5	16.6365	29.144	-62.47	-33.326	
		1732.5	18.9305	29.144	-62.31	-33.166	
		1753.5	18.9090	29.144	-62.36	-33.216	
	5	1712.5	18.9765	29.144	-62.17	-33.026	
		1732.5	18.8915	29.144	-62.23	-33.086	
		1752.5	18.9340	29.144	-62.30	-33.156	
	10	1715.0	18.9390	29.144	-62.50	-33.356	
		1732.5	18.9070	29.144	-62.22	-33.076	
		1750.0	18.9360	29.144	-62.57	-33.426	
	15	1717.5	18.9190	29.144	-62.05	-32.906	
		1732.5	16.6435	29.144	-62.36	-33.216	
		1747.5	18.8790	29.144	-62.33	-33.186	
	20	1720.0	18.8990	29.144	-62.47	-33.326	
		1732.5	18.9030	29.144	-62.00	-32.856	
		1745.0	18.9175	29.144	-62.57	-33.426	

Band	Band Width (MHz)	Frequency (MHz)	Frequency of Maximum Harmonic (GHz)	Factor (dB)	Measurement Maximum Data (dBm)	Result (dBm)	Limit (dBm)
17	5	706.5	3.52217	26.96	-59.94	-32.98	-13.00
		710.0	3.53981	26.96	-60.40	-33.44	
		713.5	3.55746	26.96	-62.05	-35.09	
	10	709.0	3.52341	26.96	-61.25	-34.29	
		710.0	3.52863	26.96	-59.55	-32.59	
		711.0	3.53360	26.96	-60.24	-33.28	

**NOTES:**

1. Conducted Spurious Emissions was Tested QPSK Modulation, Resource Block Size 1 and Resource Block Offset 0
2. Result (dBm) = Measurement Maximum Data (dBm) + Factor (dB)

- Plots of the EUT's Conducted Spurious Emissions are shown Page 84 ~ 107.

**8.6.1 BAND EDGE**

- Plots of the EUT's Band Edge are shown Page 61 ~ 83.

## 8.7 FREQUENCY STABILITY / VARIATION OF AMBIENT TEMPERATURE

### 8.7.1 FREQUENCY STABILITY (1.4 MHz Band 4 LTE)

- OPERATING FREQUENCY: 1732,500,000 Hz
- CHANNEL: 20175 (1.4 MHz)
- REFERENCE VOLTAGE: 3.8 VDC
- DEVIATION LIMIT: Emission must remain in band

Voltage (%)	Power (VDC)	Temp. (°C)	Frequency (Hz)	Frequency Error (Hz)	Deviation (%)	ppm
100%	3.8	+20(Ref)	1732 499 992	0.0	0.000 000	0.000
100%		-30	1732 500 001	9.0	0.000 001	0.005
100%		-20	1732 499 986	-6.1	0.000 000	-0.004
100%		-10	1732 499 983	-8.9	-0.000 001	-0.005
100%		0	1732 499 981	-10.7	-0.000 001	-0.006
100%		+10	1732 499 984	-7.9	0.000 000	-0.005
100%		+30	1732 499 982	-10.0	-0.000 001	-0.006
100%		+40	1732 499 982	-9.9	-0.000 001	-0.006
100%		+50	1732 499 985	-7.0	0.000 000	-0.004
Batt. Endpoint	3.0	+20	1732 499 978	-14.6	-0.000 001	-0.008

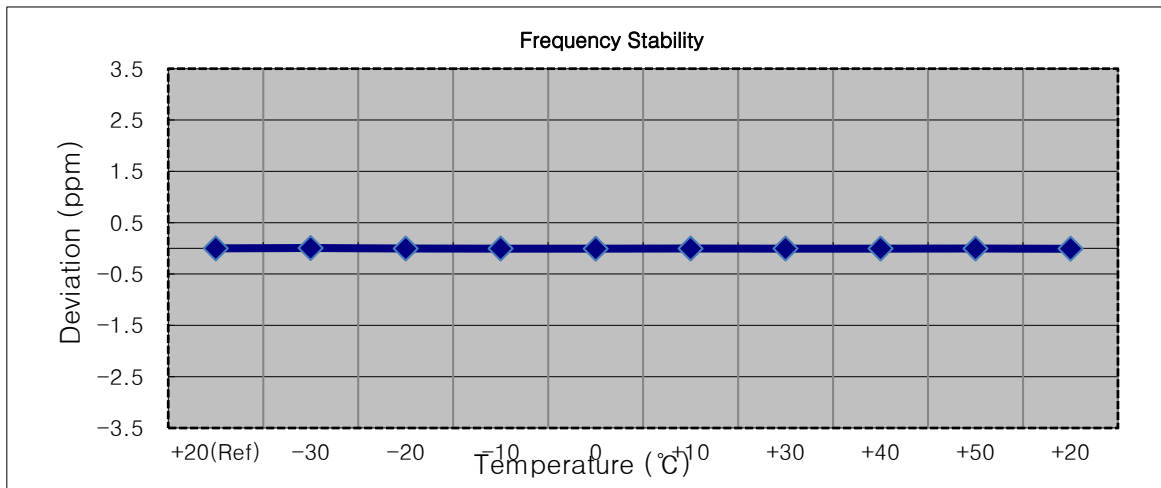

**8.7.2 FREQUENCY STABILITY (3 MHz Band 4 LTE)**

- OPERATING FREQUENCY: 1732,500,000 Hz
- CHANNEL: 20175 (3 MHz)
- REFERENCE VOLTAGE: 3.8 VDC
- DEVIATION LIMIT: Emission must remain in band

Voltage (%)	Power (VDC)	Temp. (°C)	Frequency (Hz)	Frequency Error (Hz)	Deviation (%)	ppm
100%	3.8	+20(Ref)	1732 499 992	0.0	0.000 000	0.000
100%		-30	1732 499 986	-5.7	0.000 000	-0.003
100%		-20	1732 499 983	-8.5	0.000 000	-0.005
100%		-10	1732 499 980	-11.9	-0.000 001	-0.007
100%		0	1732 499 983	-8.1	0.000 000	-0.005
100%		+10	1732 499 982	-9.8	-0.000 001	-0.006
100%		+30	1732 499 981	-10.6	-0.000 001	-0.006
100%		+40	1732 499 984	-7.5	0.000 000	-0.004
100%		+50	1732 499 981	-10.2	-0.000 001	-0.006
Batt. Endpoint		3.0	+20	1732 499 983	-8.7	-0.000 001

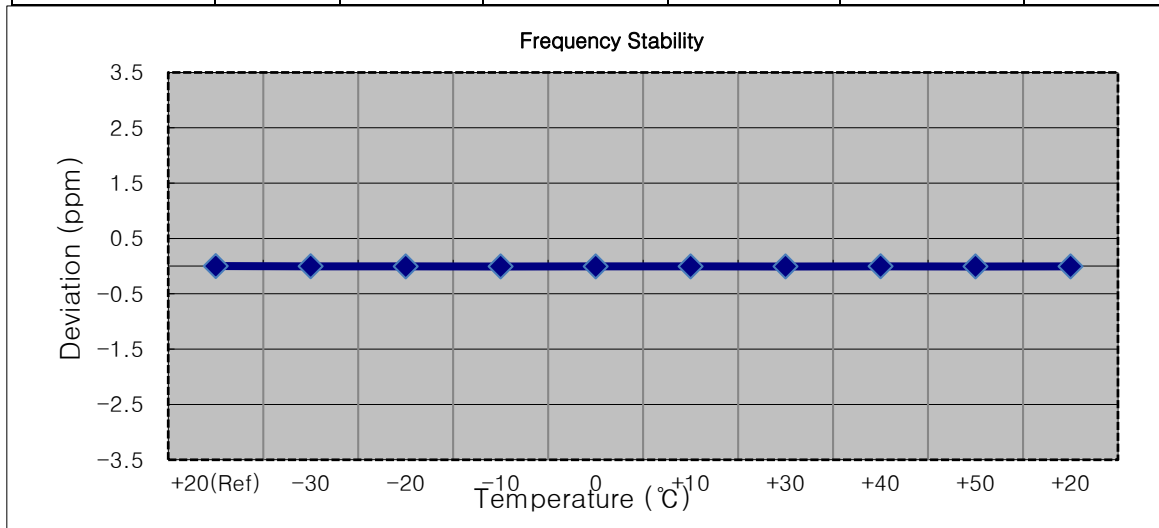

**8.7.3 FREQUENCY STABILITY (5 MHz Band 4 LTE)**

- ▣ OPERATING FREQUENCY: 1732,500,000 Hz
- ▣ CHANNEL: 20175 (5 MHz)
- ▣ REFERENCE VOLTAGE: 3.8 VDC
- ▣ DEVIATION LIMIT: Emission must remain in band

Voltage (%)	Power (VDC)	Temp. (°C)	Frequency (Hz)	Frequency Error (Hz)	Deviation (%)	ppm
100%	3.8	+20(Ref)	1732 500 010	0.0	0.000 000	0.000
100%		-30	1732 500 005	-5.2	0.000 000	-0.003
100%		-20	1732 500 020	10.0	0.000 001	0.006
100%		-10	1732 500 013	3.6	0.000 000	0.002
100%		0	1732 500 014	4.3	0.000 000	0.002
100%		+10	1732 500 001	-8.6	0.000 000	-0.005
100%		+30	1732 500 006	-3.8	0.000 000	-0.002
100%		+40	1732 500 021	11.7	0.000 001	0.007
100%		+50	1732 500 004	-6.1	0.000 000	-0.004
Batt. Endpoint	3.0	+20	1732 500 014	4.6	0.000 000	0.003

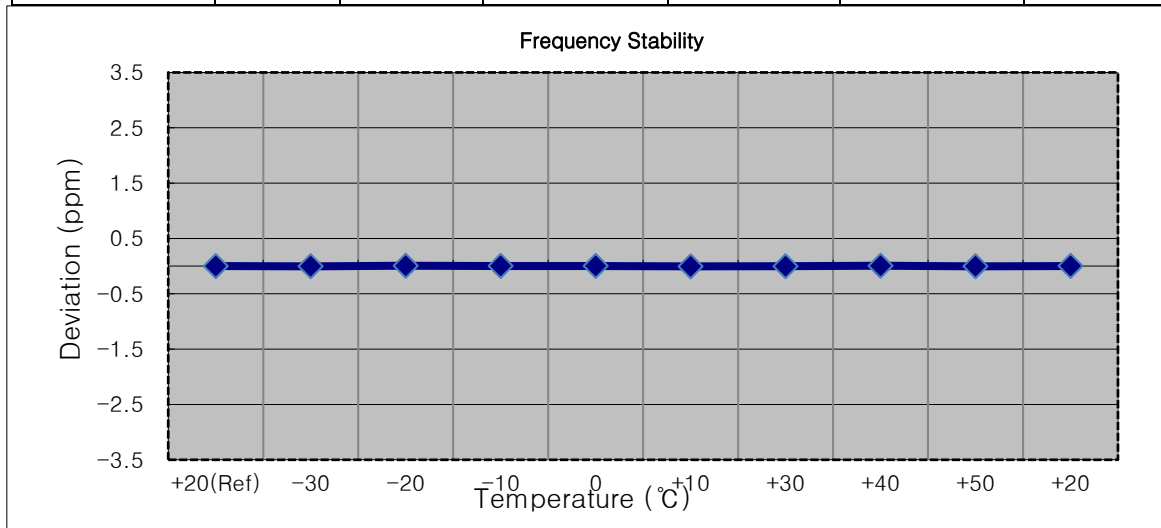

**8.7.4 FREQUENCY STABILITY (10 MHz Band 4 LTE)**

- OPERATING FREQUENCY: 1732,500,000 Hz
- CHANNEL: 20175 (10 MHz)
- REFERENCE VOLTAGE: 3.8 VDC
- DEVIATION LIMIT: Emission must remain in band

Voltage (%)	Power (VDC)	Temp. (°C)	Frequency (Hz)	Frequency Error (Hz)	Deviation (%)	ppm
100%	3.8	+20(Ref)	1732 500 009	0.0	0.000 000	0.000
100%		-30	1732 500 014	5.3	0.000 000	0.003
100%		-20	1732 500 002	-6.7	0.000 000	-0.004
100%		-10	1732 500 018	9.1	0.000 001	0.005
100%		0	1732 500 002	-6.2	0.000 000	-0.004
100%		+10	1732 500 002	-6.6	0.000 000	-0.004
100%		+30	1732 500 014	5.5	0.000 000	0.003
100%		+40	1732 500 016	7.6	0.000 000	0.004
100%		+50	1732 500 015	6.7	0.000 000	0.004
Batt. Endpoint	3.0	+20	1732 500 019	10.3	0.000 001	0.006

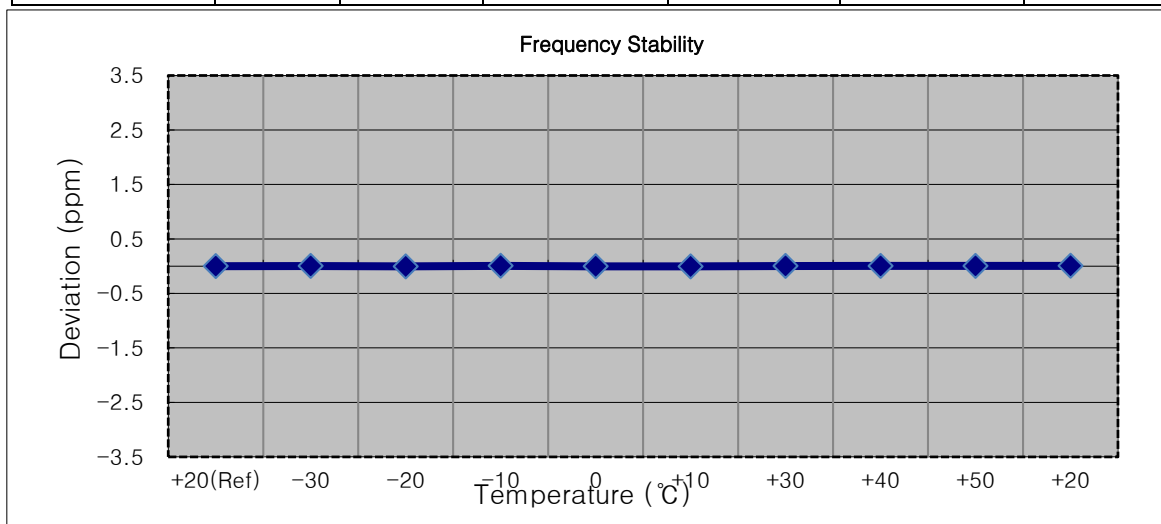

**8.7.5 FREQUENCY STABILITY (15 MHz Band 4 LTE)**

- OPERATING FREQUENCY: 1732,500,000 Hz
- CHANNEL: 20175 (15 MHz)
- REFERENCE VOLTAGE: 3.8 VDC
- DEVIATION LIMIT: Emission must remain in band

Voltage (%)	Power (VDC)	Temp. (°C)	Frequency (Hz)	Frequency Error (Hz)	Deviation (%)	ppm
100%	3.8	+20(Ref)	1732 499 995	0.0	0.000 000	0.000
100%		-30	1732 499 985	-10.2	-0.000 001	-0.006
100%		-20	1732 500 000	4.4	0.000 000	0.003
100%		-10	1732 500 002	6.4	0.000 000	0.004
100%		0	1732 500 002	6.4	0.000 000	0.004
100%		+10	1732 500 002	6.7	0.000 000	0.004
100%		+30	1732 500 002	7.0	0.000 000	0.004
100%		+40	1732 500 003	7.5	0.000 000	0.004
100%		+50	1732 500 003	7.9	0.000 000	0.005
Batt. Endpoint	3.0	+20	1732 500 000	4.5	0.000 000	0.003

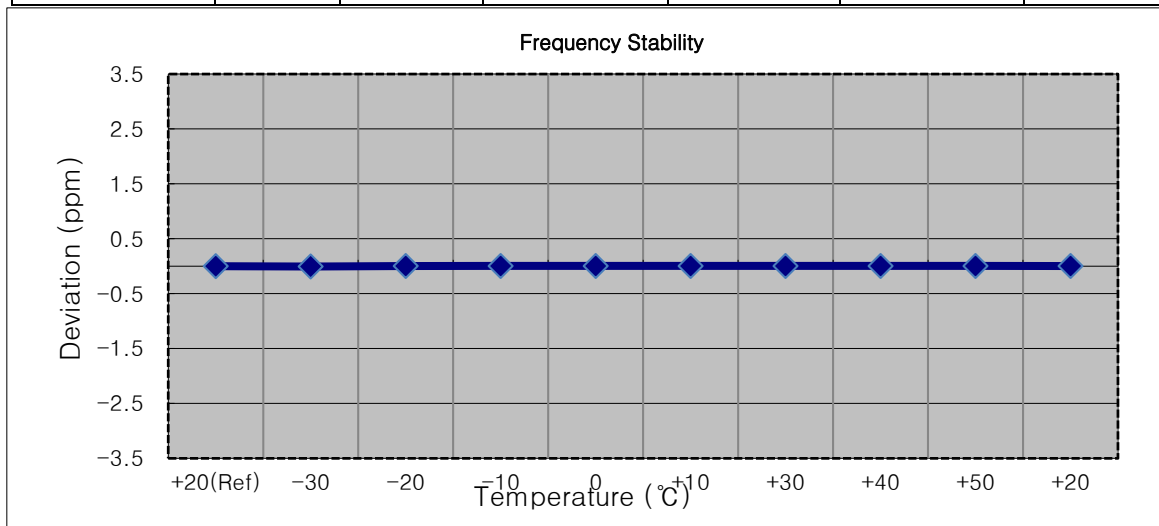

**8.7.6 FREQUENCY STABILITY (20 MHz Band 4 LTE)**

- OPERATING FREQUENCY: 1732,500,000 Hz
- CHANNEL: 20175 (20 MHz)
- REFERENCE VOLTAGE: 3.8 VDC
- DEVIATION LIMIT: Emission must remain in band

Voltage (%)	Power (VDC)	Temp. (°C)	Frequency (Hz)	Frequency Error (Hz)	Deviation (%)	ppm
100%	3.8	+20(Ref)	1732 499 993	0.0	0.000 000	0.000
100%		-30	1732 499 987	-5.7	0.000 000	-0.003
100%		-20	1732 499 988	-5.0	0.000 000	-0.003
100%		-10	1732 500 000	6.8	0.000 000	0.004
100%		0	1732 500 003	10.1	0.000 001	0.006
100%		+10	1732 500 002	9.1	0.000 001	0.005
100%		+30	1732 499 987	-6.3	0.000 000	-0.004
100%		+40	1732 500 000	7.4	0.000 000	0.004
100%		+50	1732 499 986	-7.0	0.000 000	-0.004
Batt. Endpoint		3.0	+20	1732 499 998	5.0	0.000 000

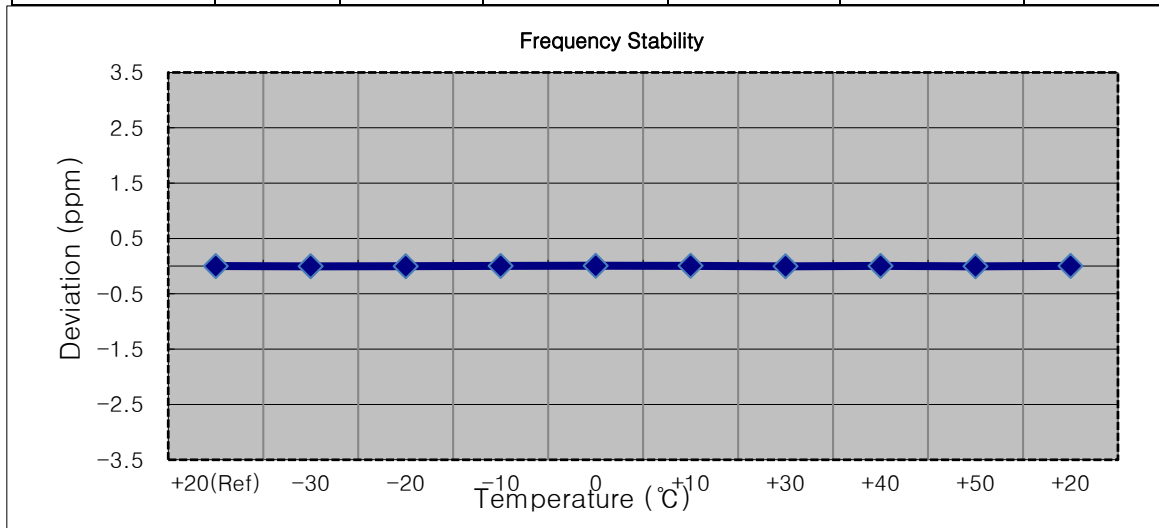

**8.7.7 FREQUENCY STABILITY (5 MHz Band 17 LTE)**

- OPERATING FREQUENCY: 710,000,000 Hz
- CHANNEL: 23790 (5 MHz)
- REFERENCE VOLTAGE: 3.8 VDC
- DEVIATION LIMIT: Emission must remain in band

Voltage (%)	Power (VDC)	Temp. (°C)	Frequency (Hz)	Frequency Error (Hz)	Deviation (%)	ppm
100%	3.8	+20(Ref)	709 999 995	0.0	0.000 000	0.000
100%		-30	710 000 002	6.7	0.000 001	0.009
100%		-20	709 999 999	3.7	0.000 001	0.005
100%		-10	709 999 998	2.8	0.000 000	0.004
100%		0	709 999 997	2.0	0.000 000	0.003
100%		+10	709 999 991	-4.8	-0.000 001	-0.007
100%		+30	709 999 999	4.0	0.000 001	0.006
100%		+40	709 999 992	-3.9	-0.000 001	-0.005
100%		+50	710 000 000	4.5	0.000 001	0.006
Batt. Endpoint		3.0	+20	709 999 992	-3.9	-0.000 001

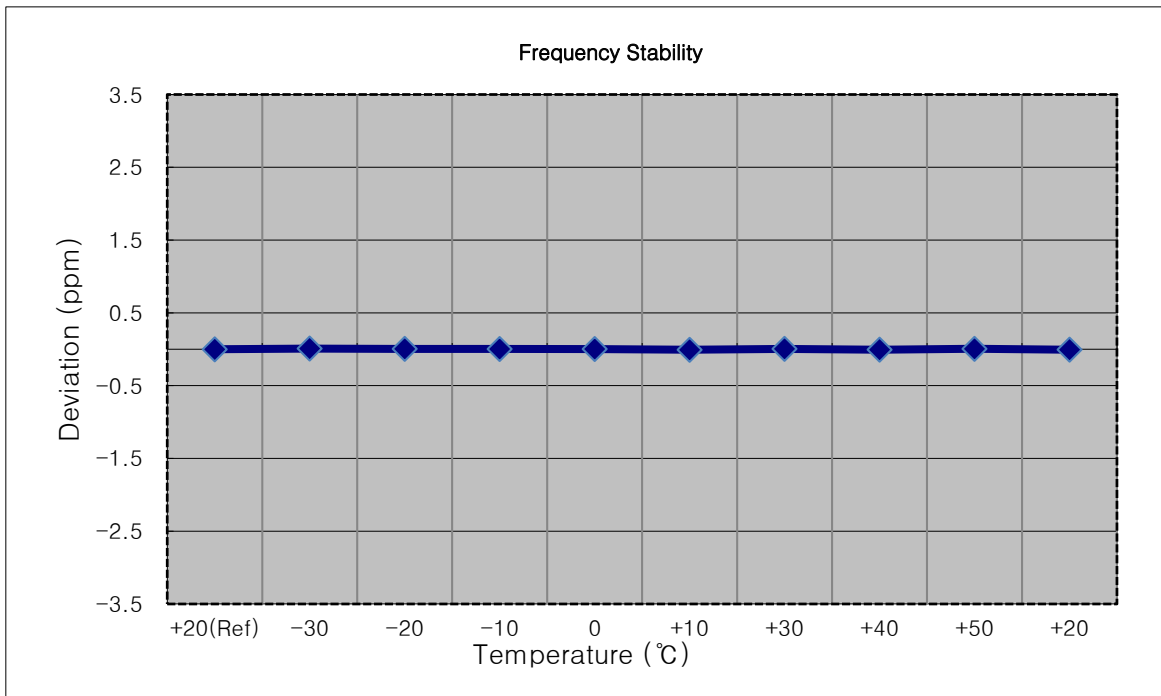

**8.7.8 FREQUENCY STABILITY (10 MHz Band 17 LTE)**

- OPERATING FREQUENCY: 710,000,000 Hz
- CHANNEL: 23790 (10 MHz)
- REFERENCE VOLTAGE: 3.8 VDC
- DEVIATION LIMIT: Emission must remain in band

Voltage (%)	Power (VDC)	Temp. (°C)	Frequency (Hz)	Frequency Error (Hz)	Deviation (%)	ppm
100%	3.8	+20(Ref)	710 000 005	0.0	0.000 000	0.000
100%		-30	709 999 999	-5.5	-0.000 001	-0.008
100%		-20	709 999 998	-6.7	-0.000 001	-0.009
100%		-10	710 000 008	2.8	0.000 000	0.004
100%		0	710 000 014	9.1	0.000 001	0.013
100%		+10	710 000 001	-3.9	-0.000 001	-0.005
100%		+30	709 999 998	-6.4	-0.000 001	-0.009
100%		+40	710 000 009	4.1	0.000 001	0.006
100%		+50	710 000 000	-5.1	-0.000 001	-0.007
Batt. Endpoint		3.0	+20	710 000 010	5.3	0.000 001

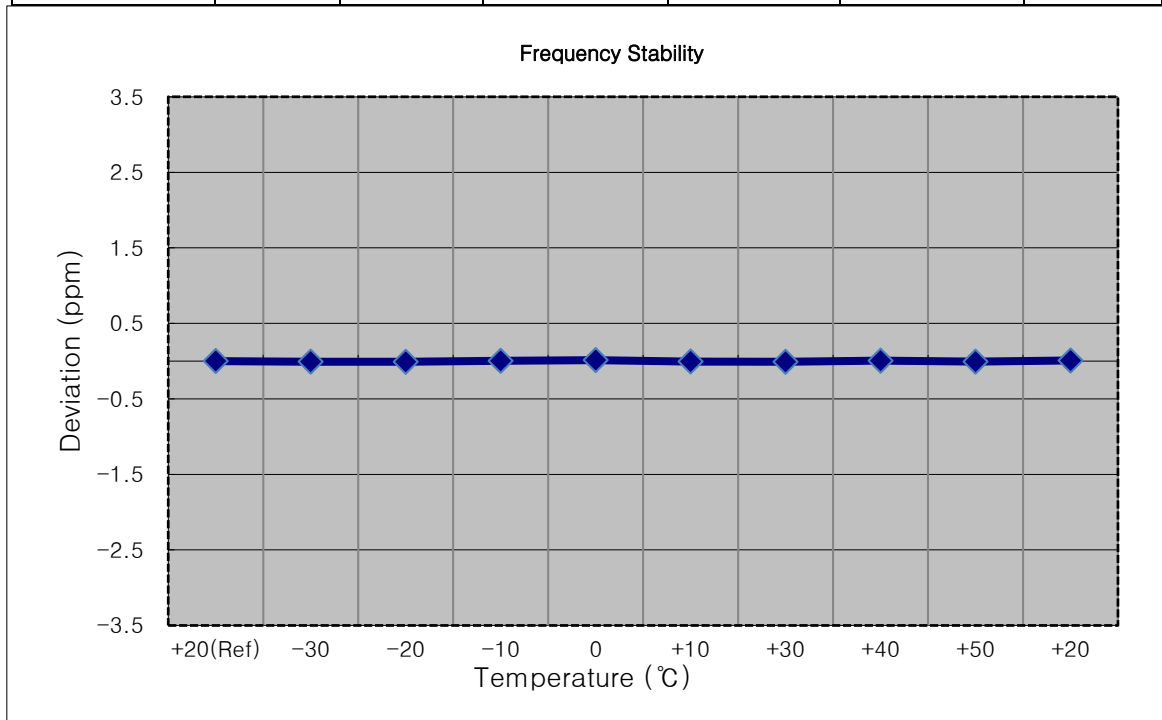

## 9. TEST PLOTS

BAND 4. Occupied Bandwidth Plot (1.4M BW Ch.20175 QPSK RB 6)

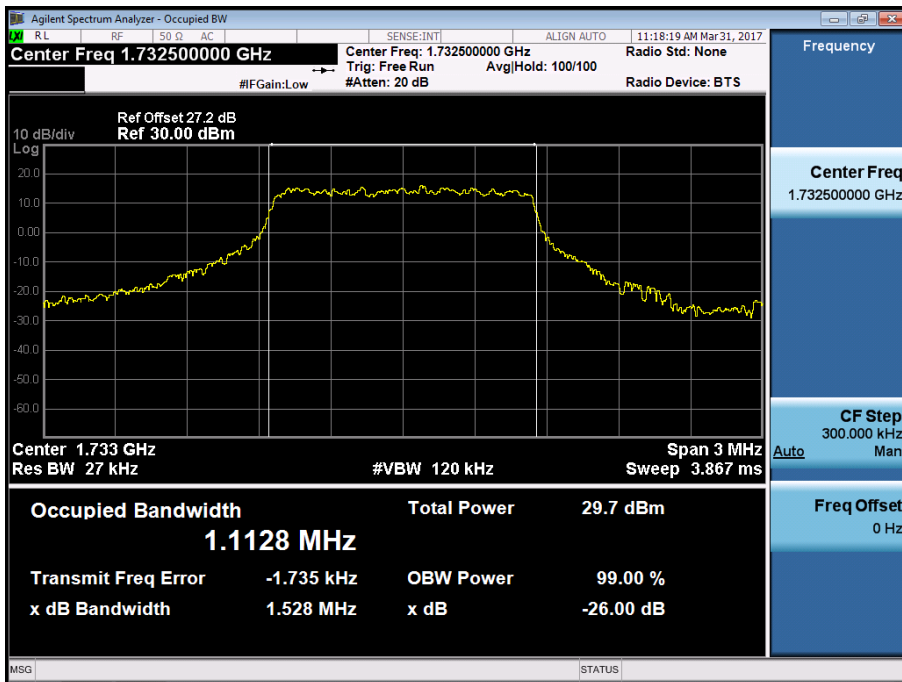

BAND 4. Occupied Bandwidth Plot (1.4M BW Ch.20175 16QAM RB 6)

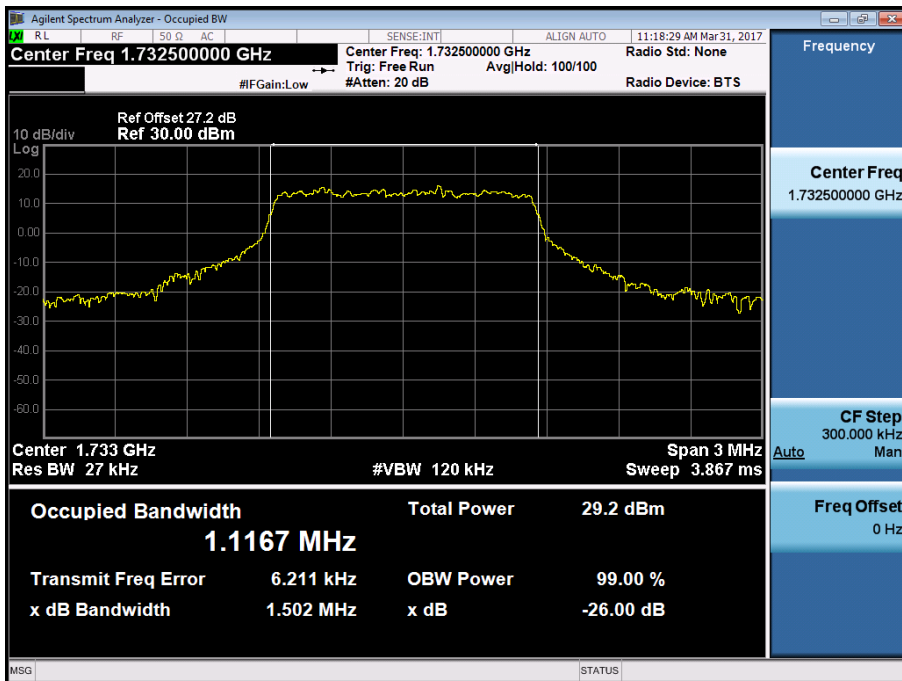

BAND 4. Occupied Bandwidth Plot (3M BW Ch.20175 QPSK RB 15)

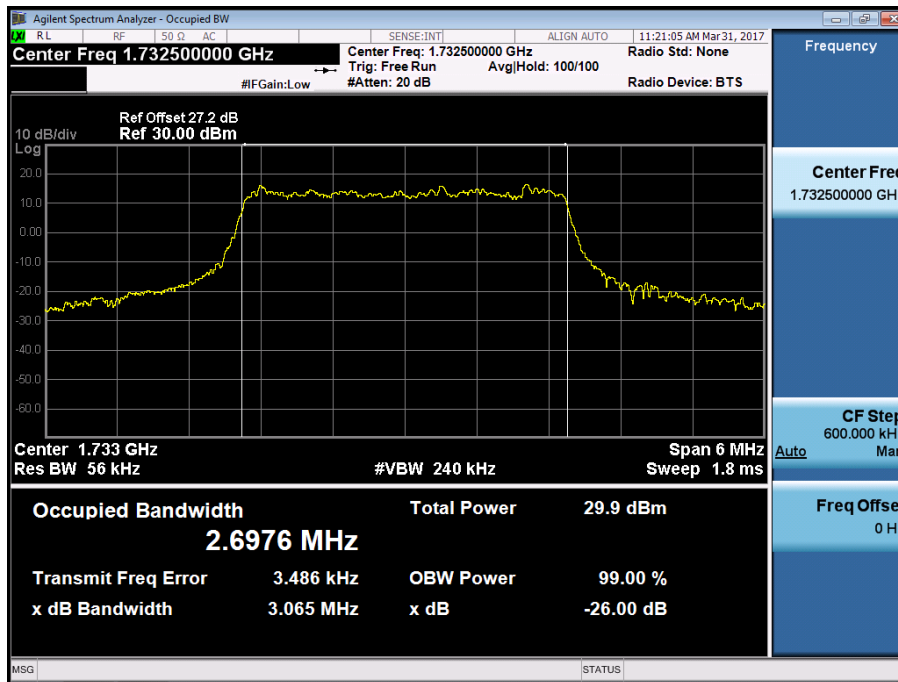

BAND 4. Occupied Bandwidth Plot (3M BW Ch.20175 16QAM RB 15)

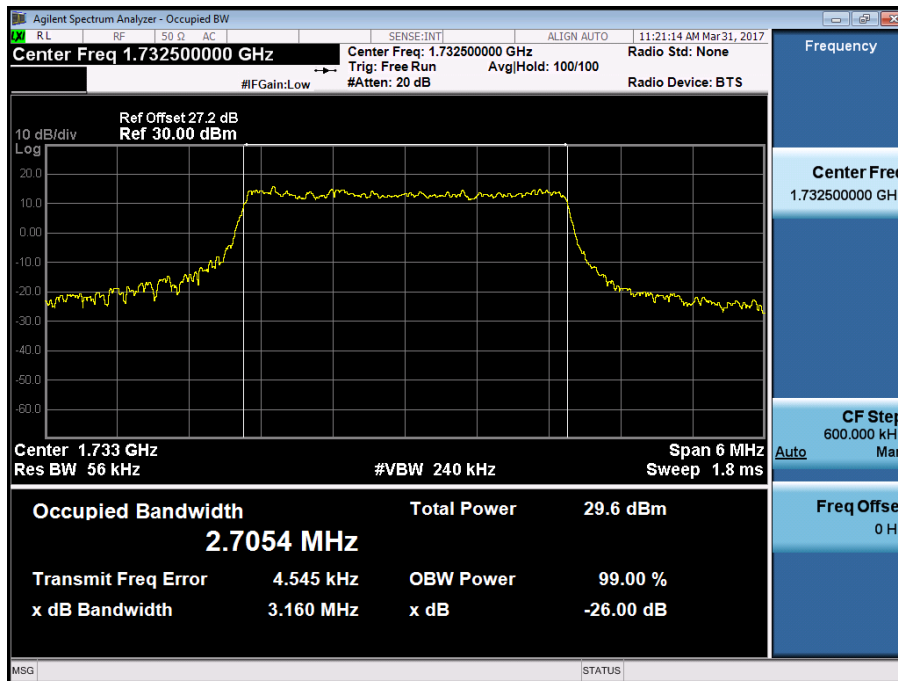

BAND 4. Occupied Bandwidth Plot (5M BW Ch.20175 QPSK RB 25)

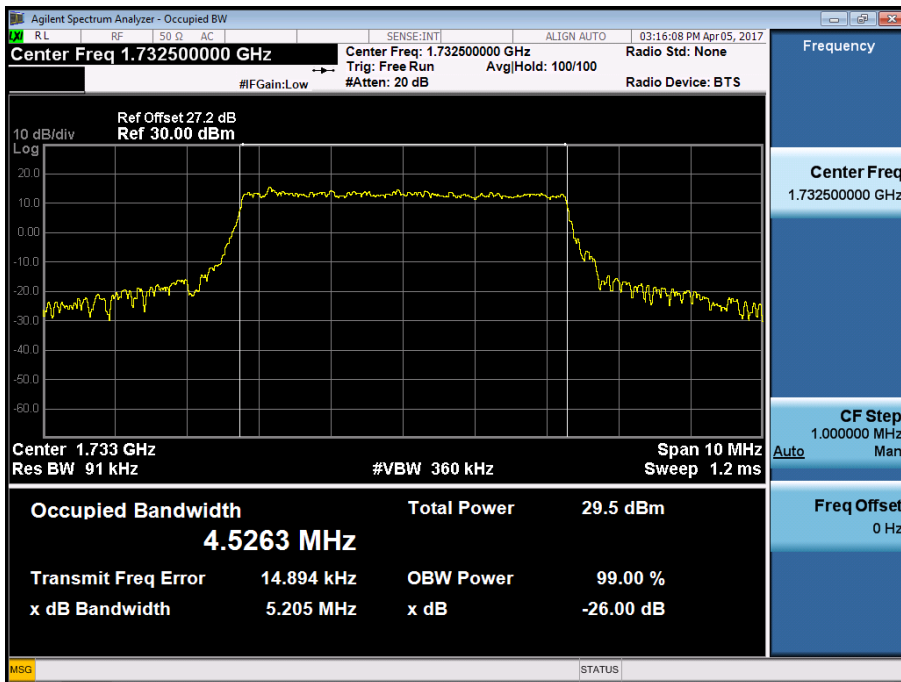

BAND 4. Occupied Bandwidth Plot (5M BW Ch.20175 16QAM RB 25)

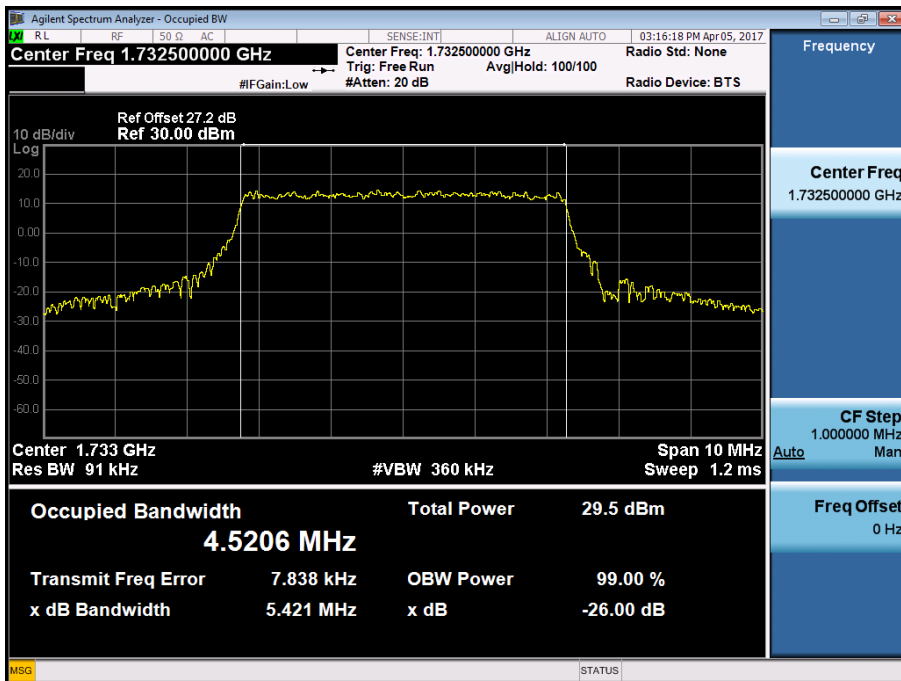

BAND 4. Occupied Bandwidth Plot (10M BW Ch.20175 QPSK RB 50)

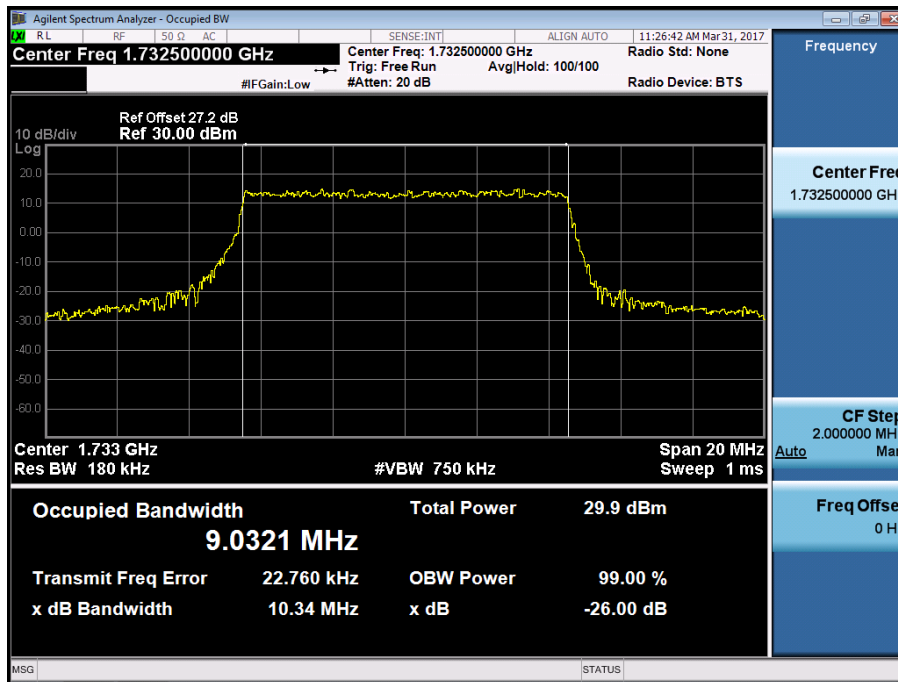

BAND 4. Occupied Bandwidth Plot (10M BW Ch.20175 16QAM RB 50)

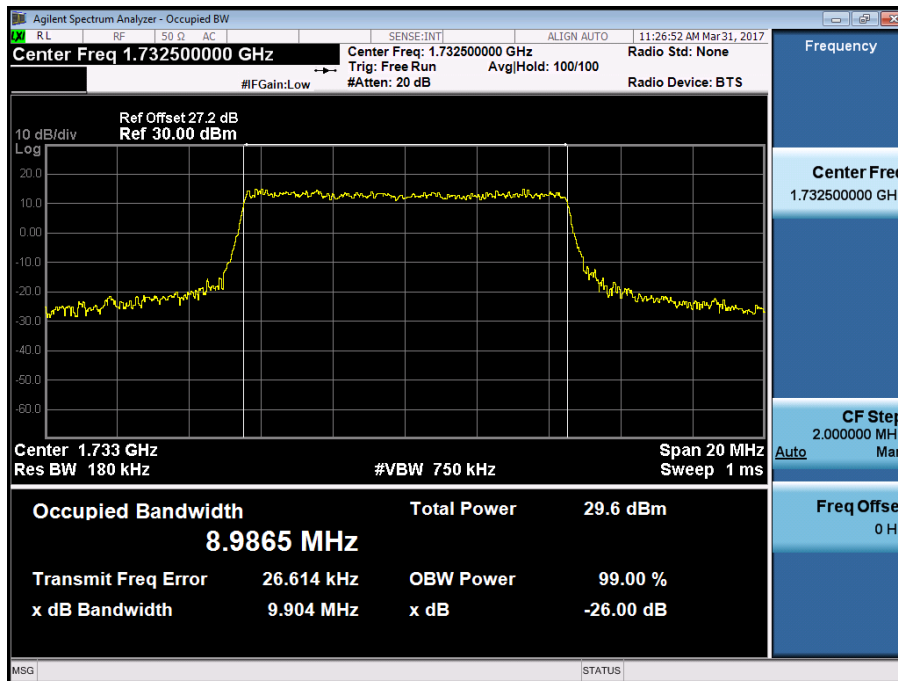

BAND 4. Occupied Bandwidth Plot (15M BW Ch.20175 QPSK RB 75)

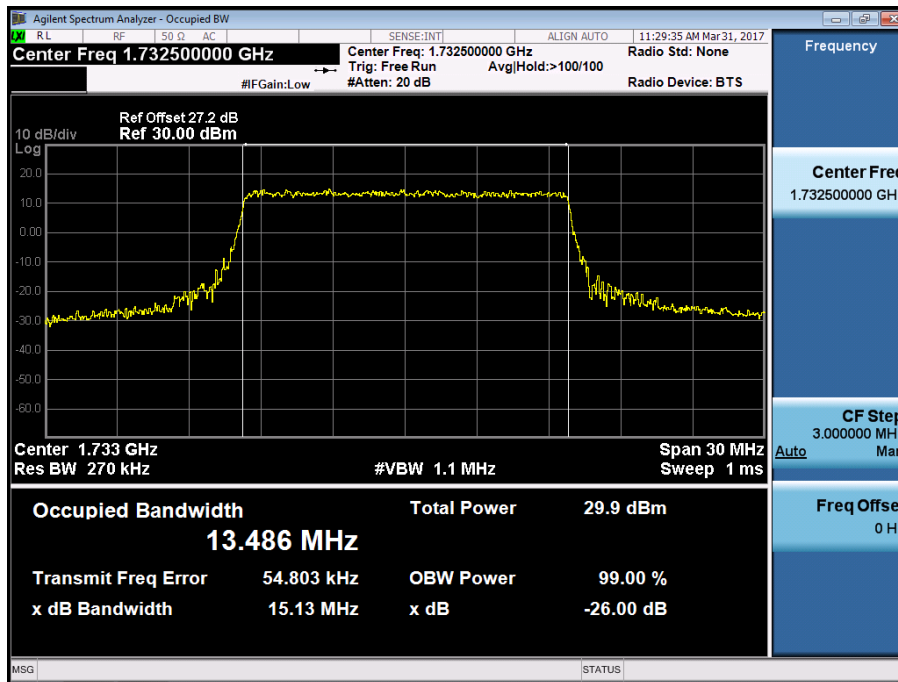

BAND 4. Occupied Bandwidth Plot (15M BW Ch.20175 16QAM RB 75)

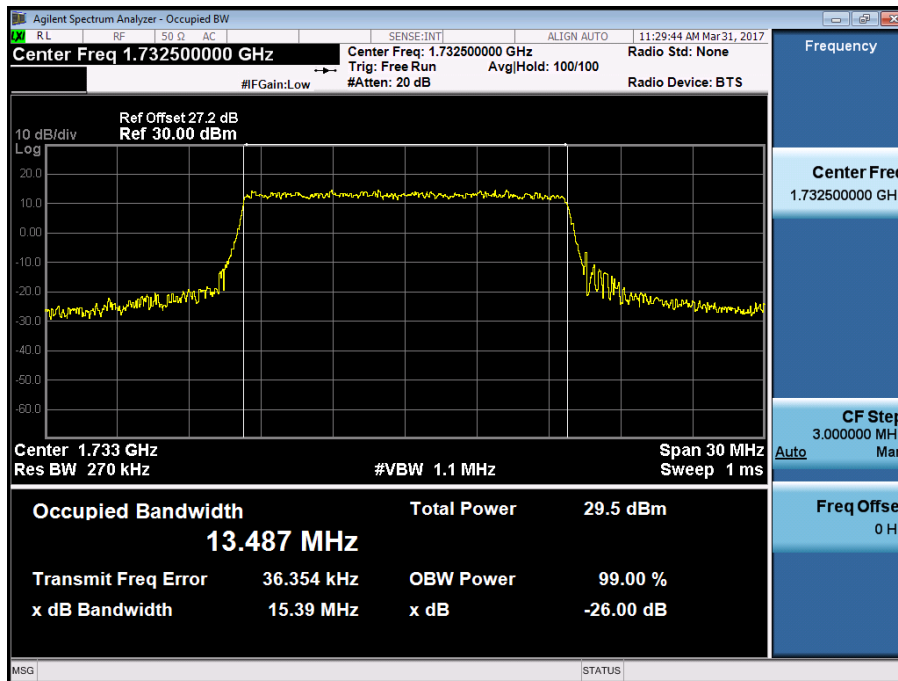

BAND 4. Occupied Bandwidth Plot (20M BW Ch.20175 QPSK RB 100)

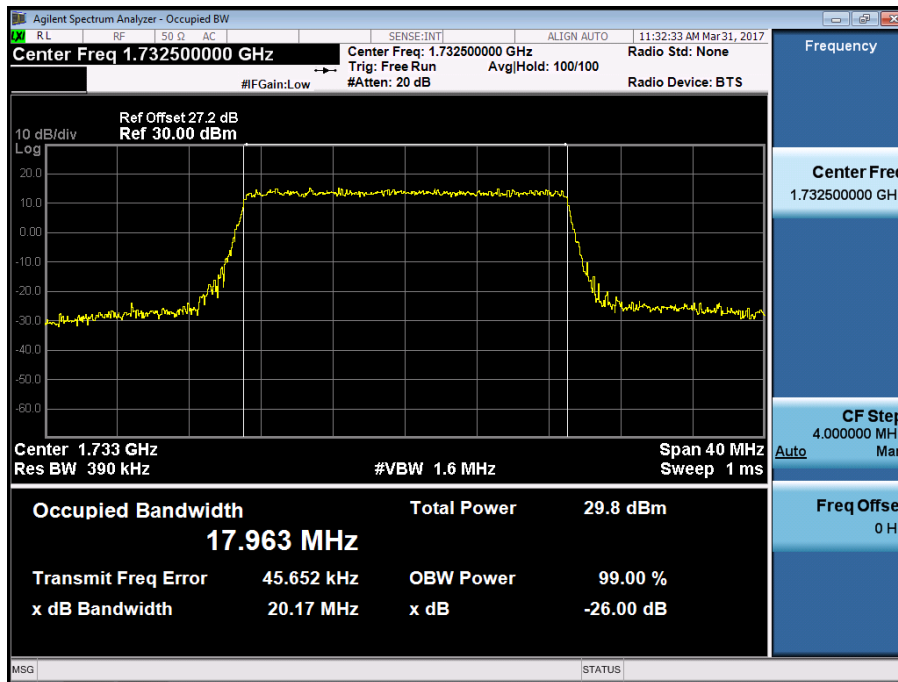

BAND 4. Occupied Bandwidth Plot (20M BW Ch.20175 16QAM RB 100)

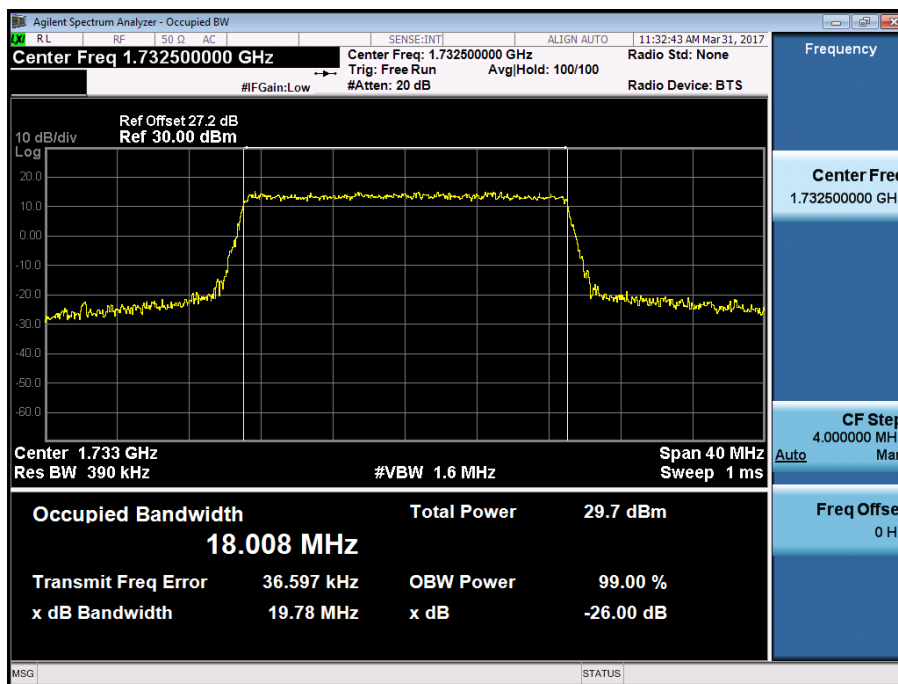

BAND 17. Occupied Bandwidth Plot (5M BW Ch.23790 QPSK RB 25)

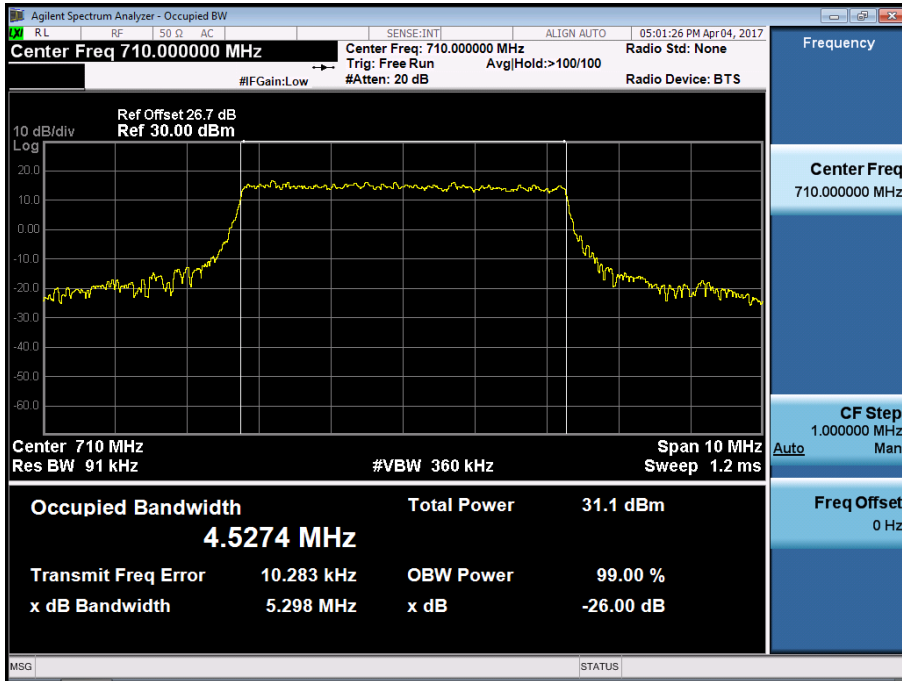

BAND 17. Occupied Bandwidth Plot (5M BW Ch.23790 16QAM RB 25)

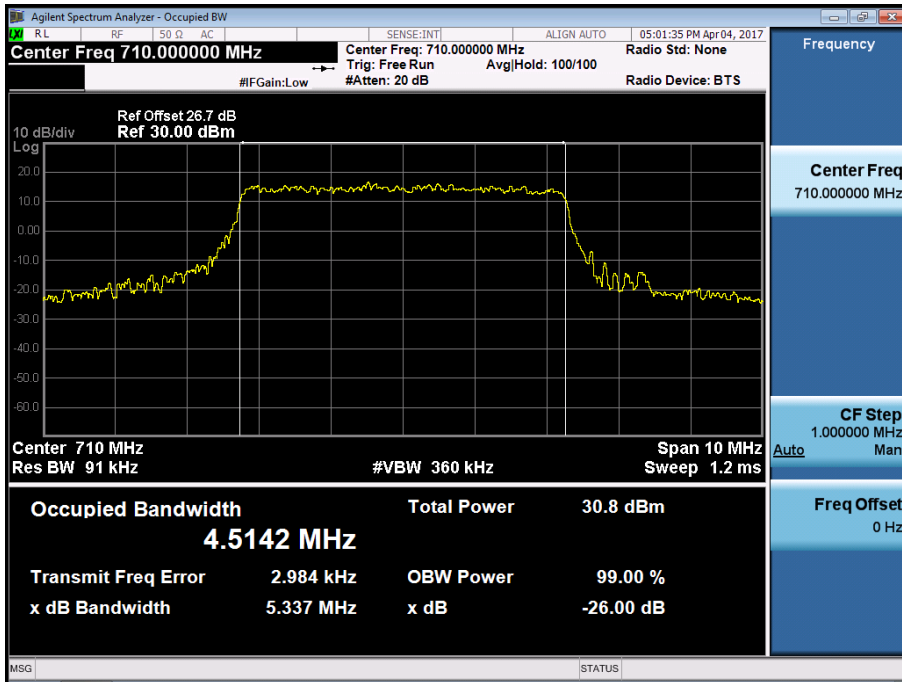

BAND 17. Occupied Bandwidth Plot (10M BW Ch.23790 QPSK RB 50)

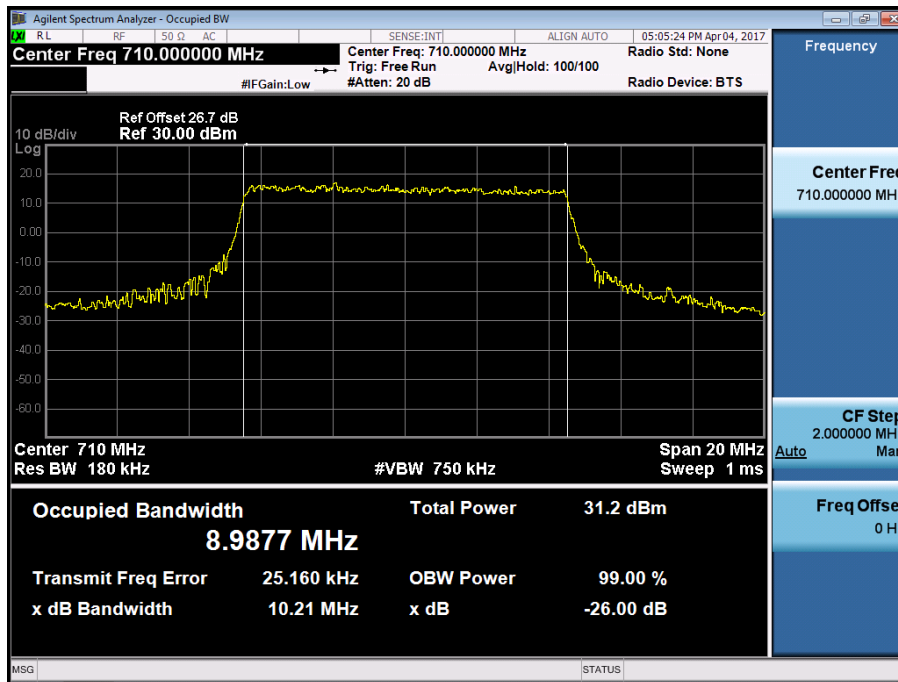

BAND 17. Occupied Bandwidth Plot (10M BW Ch.23790 16QAMRB 50)

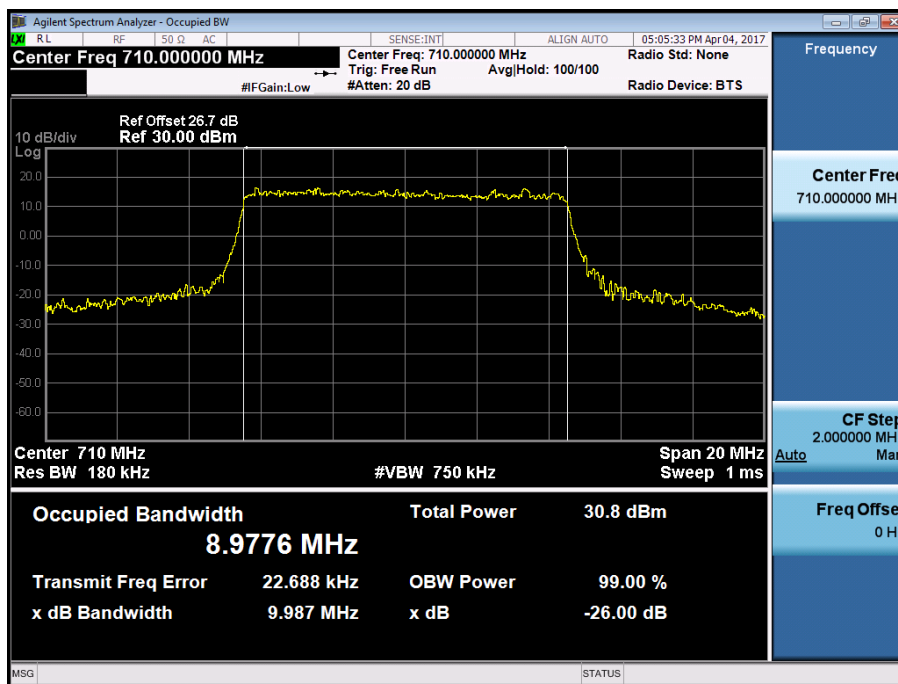

BAND 4. PAR Plot (1.4M BW\_Ch.20175\_QPSK\_RB6\_0)

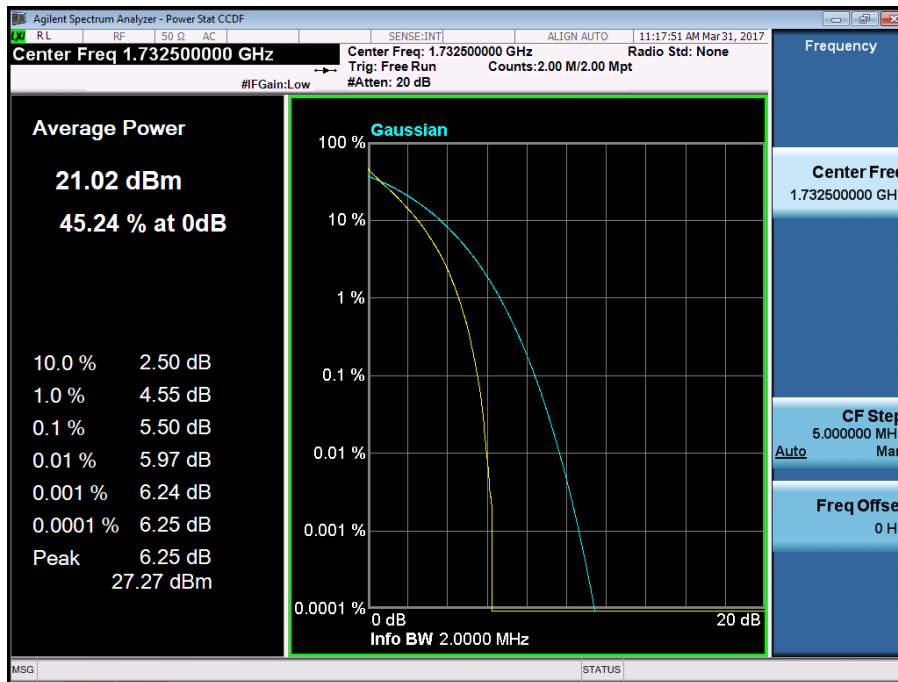

BAND 4. PAR Plot (1.4M BW\_Ch.20175\_16QAM\_RB6\_0)

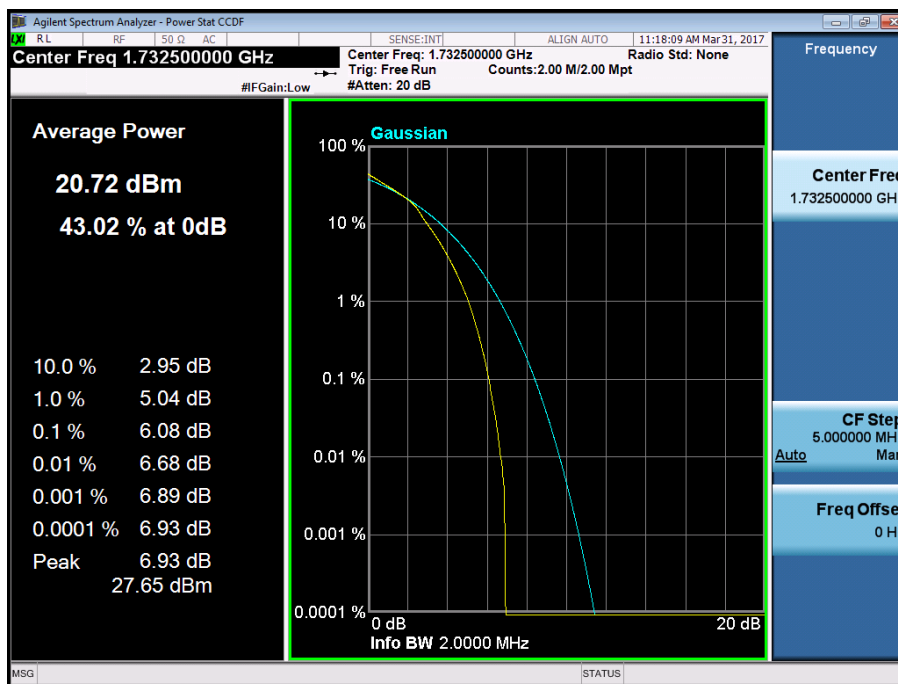

BAND 4. PAR Plot (3M BW\_Ch.20175\_QPSK\_RB15\_0)

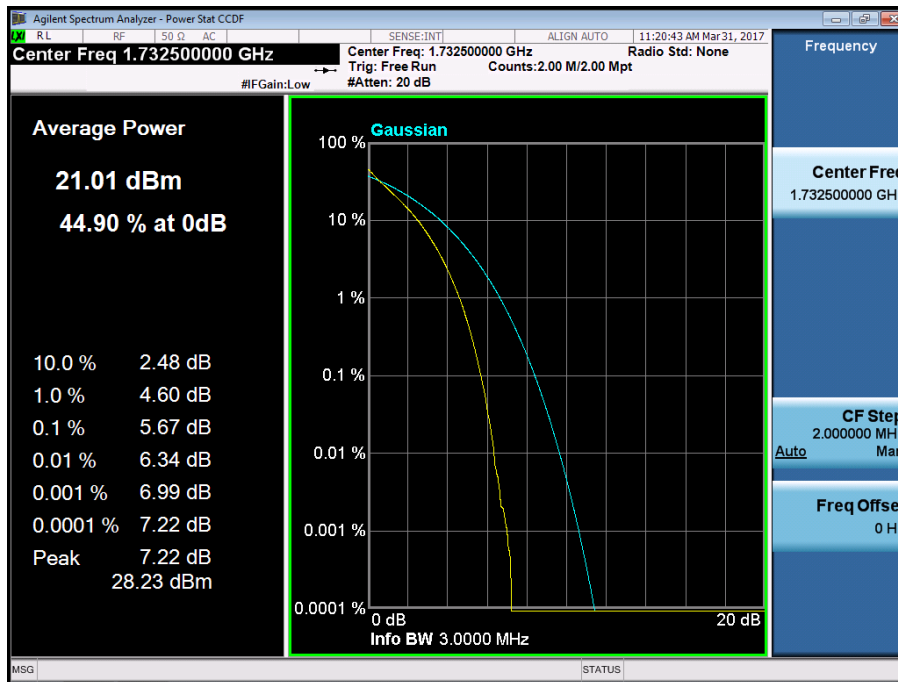

BAND 4. PAR Plot (3M BW\_Ch.20175\_16QAM\_RB15\_0)

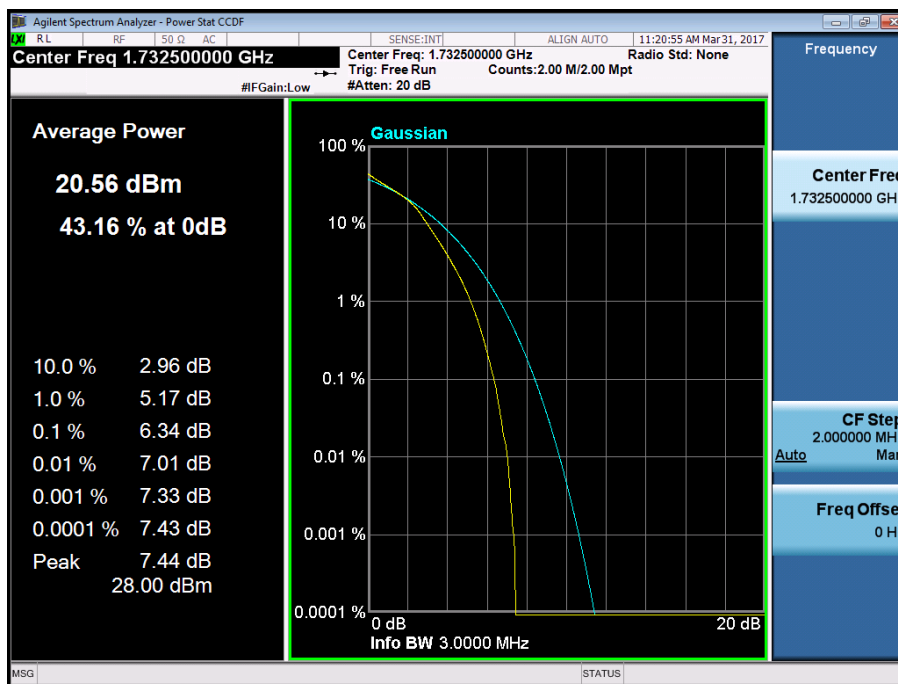

BAND 4. PAR Plot (5M BW\_Ch.20175\_QPSK\_RB25\_0)

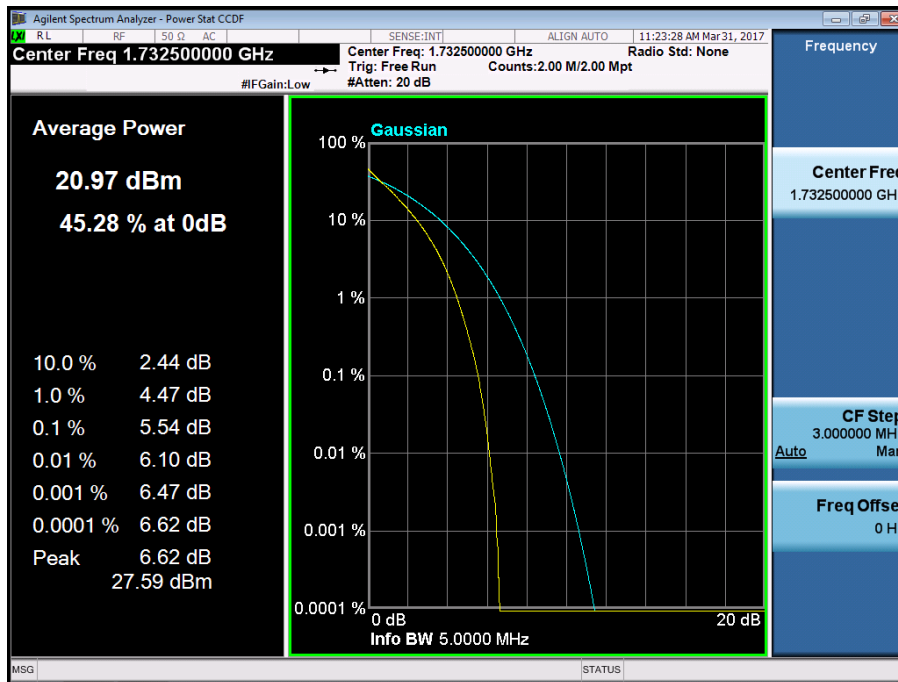

BAND 4. PAR Plot (5M BW\_Ch.20175\_16QAM\_RB25\_0)

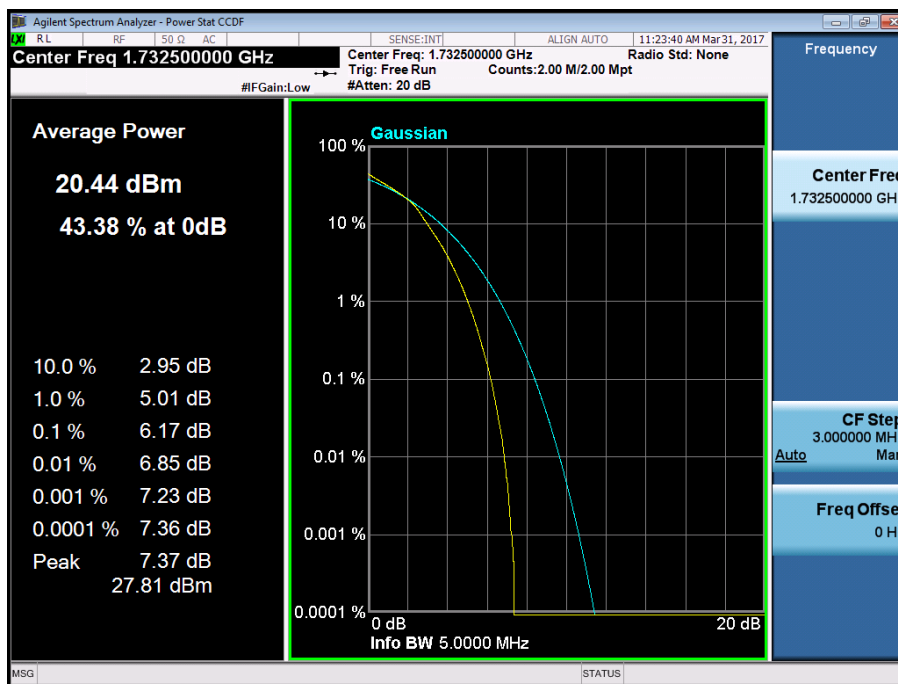

BAND 4. PAR Plot (10M BW\_Ch.20175\_QPSK\_RB50\_0)

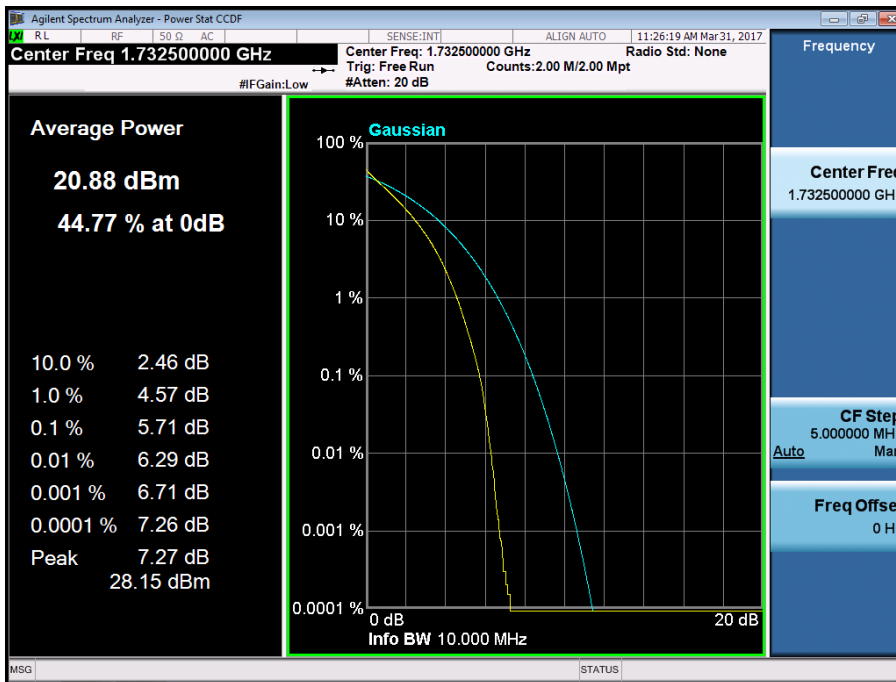

BAND 4. PAR Plot (10M BW\_Ch.20175\_16QAM\_RB50\_0)

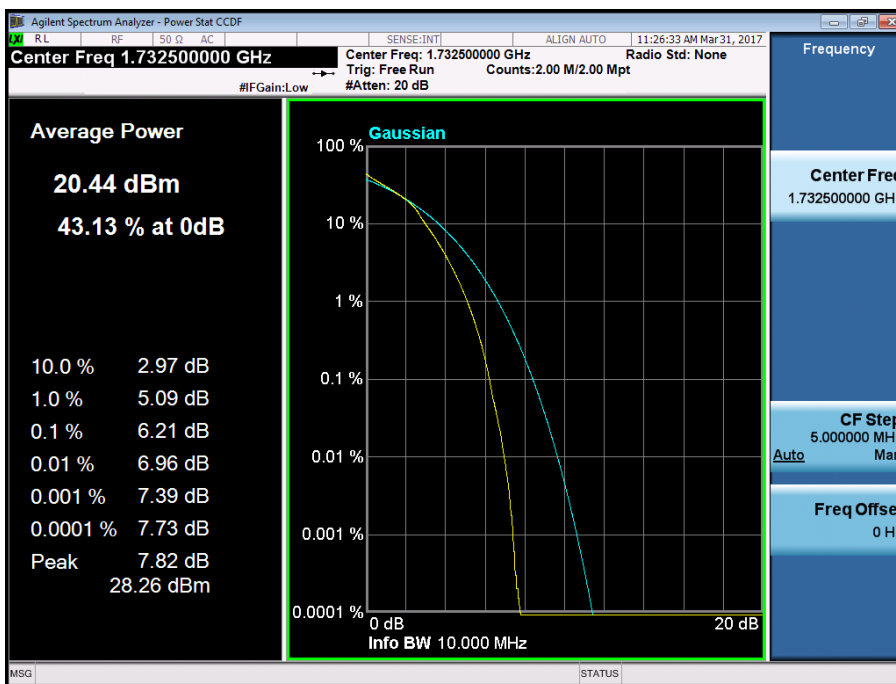

BAND 4. PAR Plot (15M BW\_Ch.20175\_QPSK\_RB75\_0)

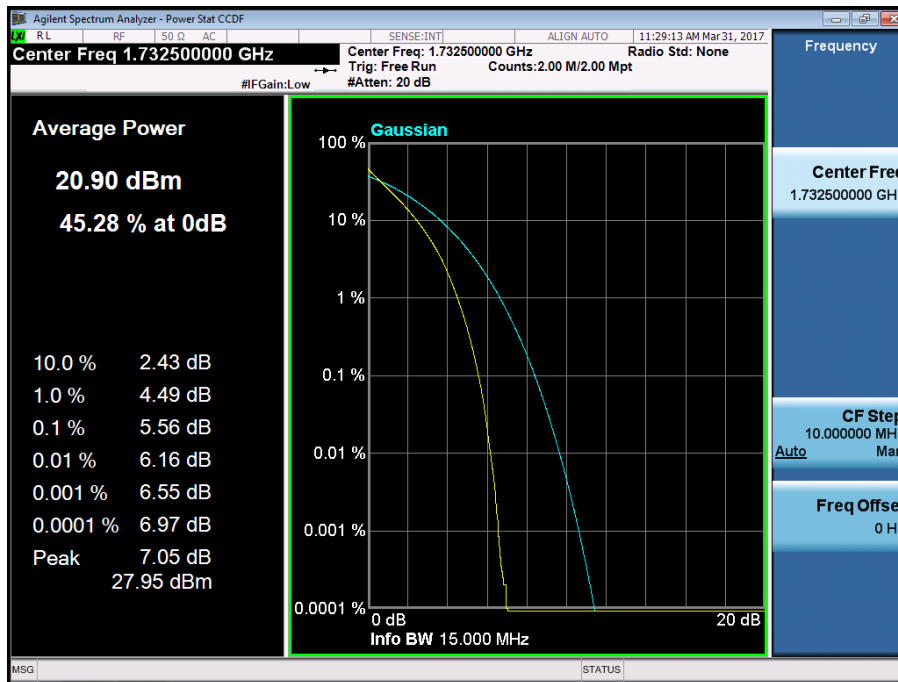

BAND 4. PAR Plot (15M BW\_Ch.20175\_16QAM\_RB75\_0)

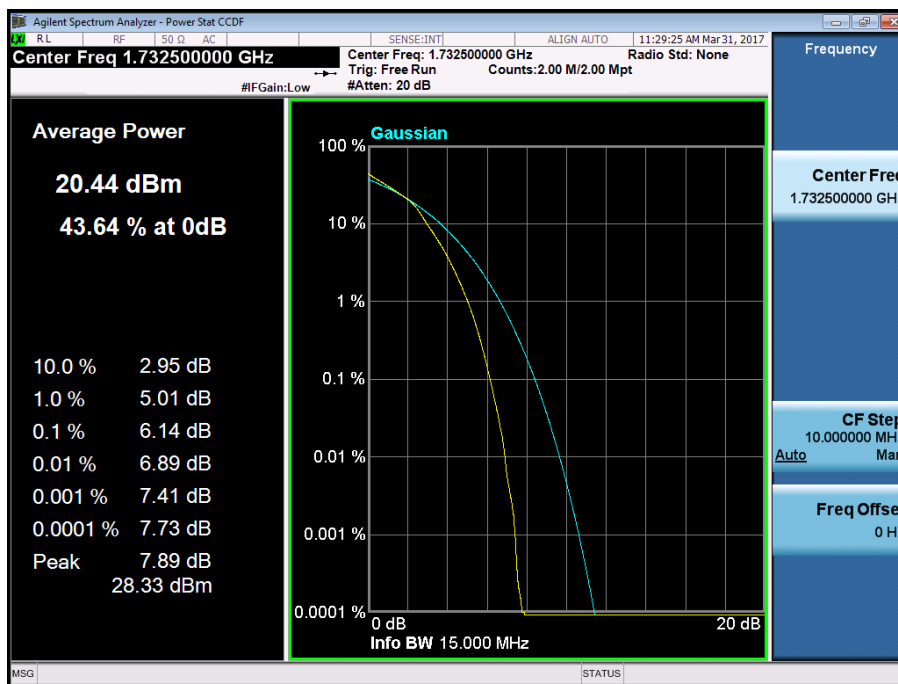

BAND 4. PAR Plot (20M BW\_Ch.20175\_QPSK\_RB100\_0)

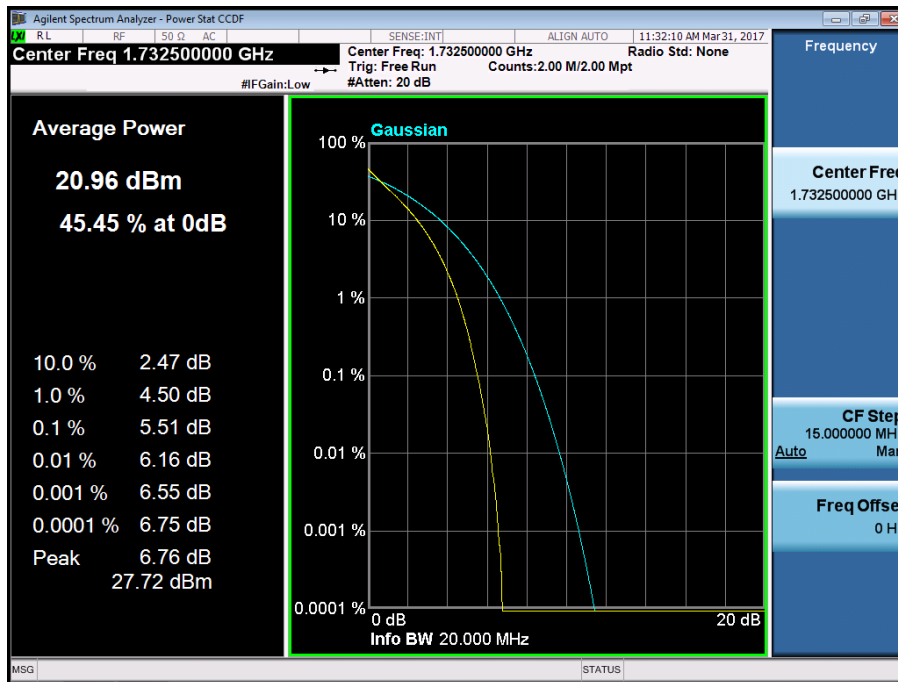

BAND 4. PAR Plot (20M BW\_Ch.20175\_16QAM\_RB100\_0)

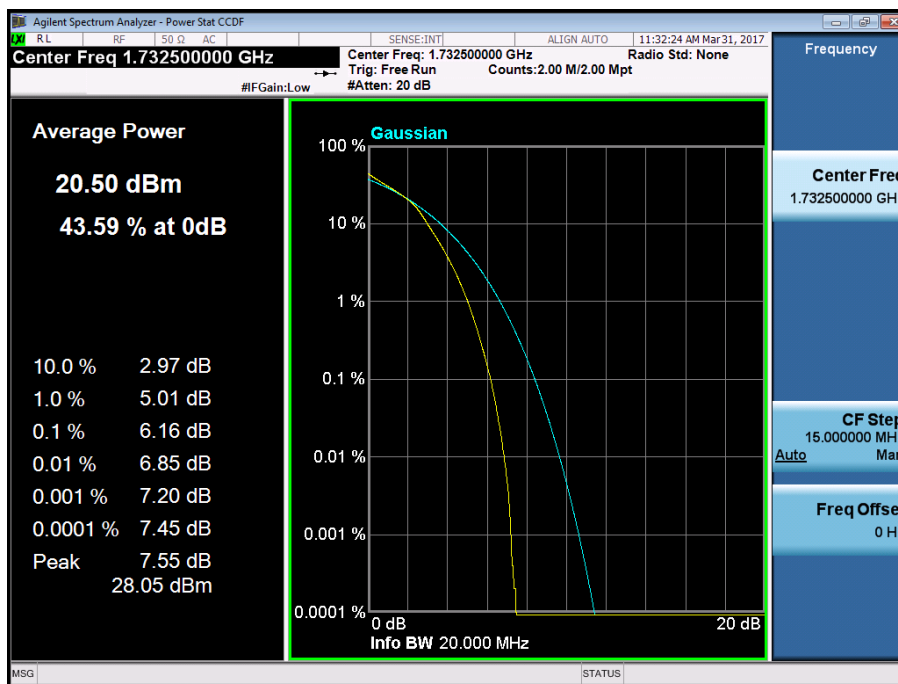

BAND 4. Lower Band Edge Plot (1.4M BW Ch.19957 QPSK RB 1, Offset 0) -1

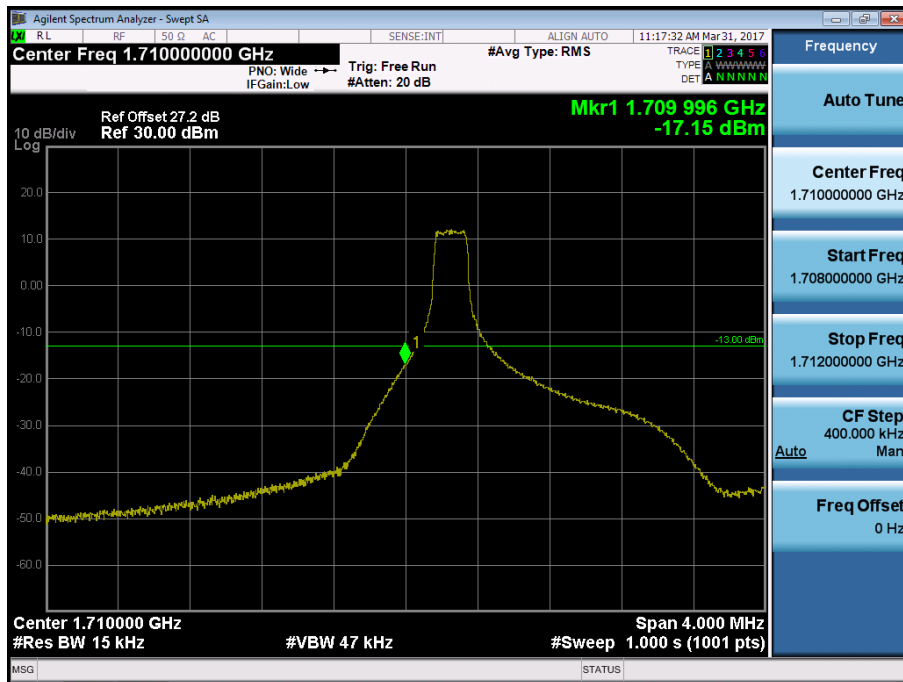

BAND 4. Lower Band Edge Plot (1.4M BW Ch.19957 QPSK RB 6) -2

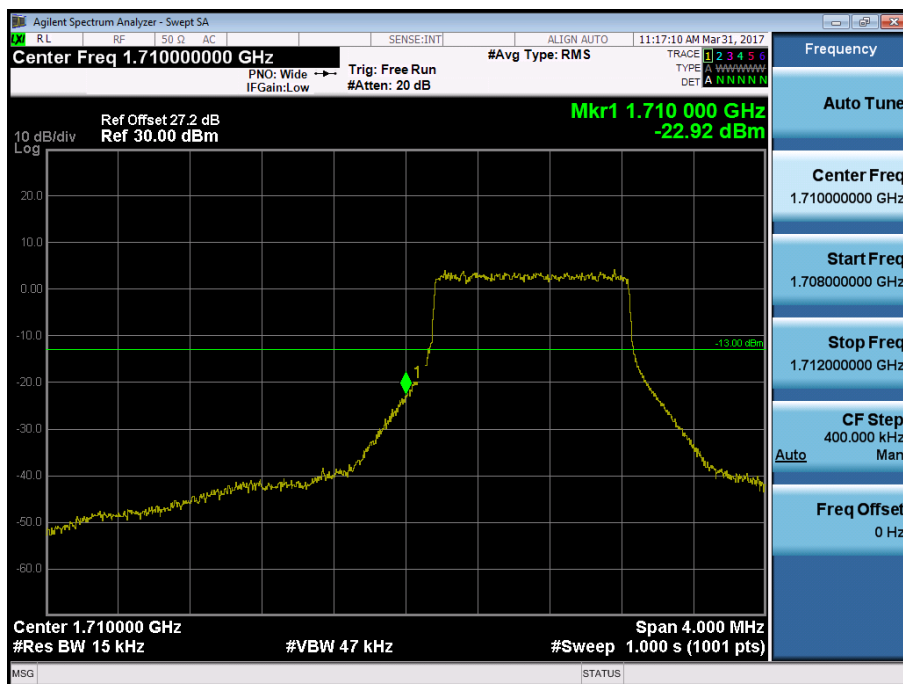

BAND 4. Lower Extended Band Edge Plot (1.4M BW Ch.19957 QPSK\_RB6\_0) -3

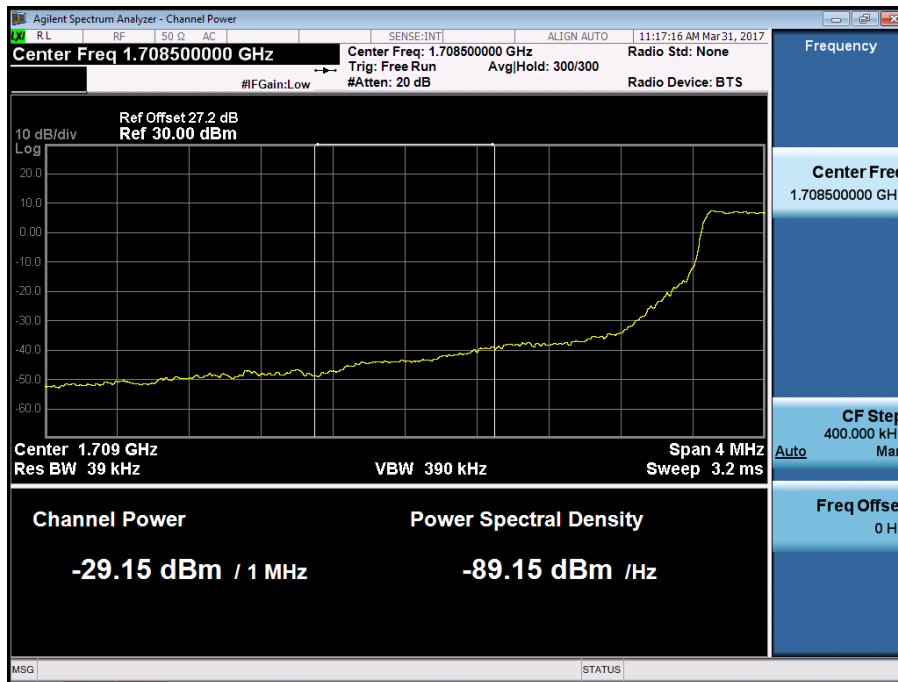

BAND 4. Lower Band Edge Plot (3M BW Ch.19965 QPSK RB 1, Offset 0) -1

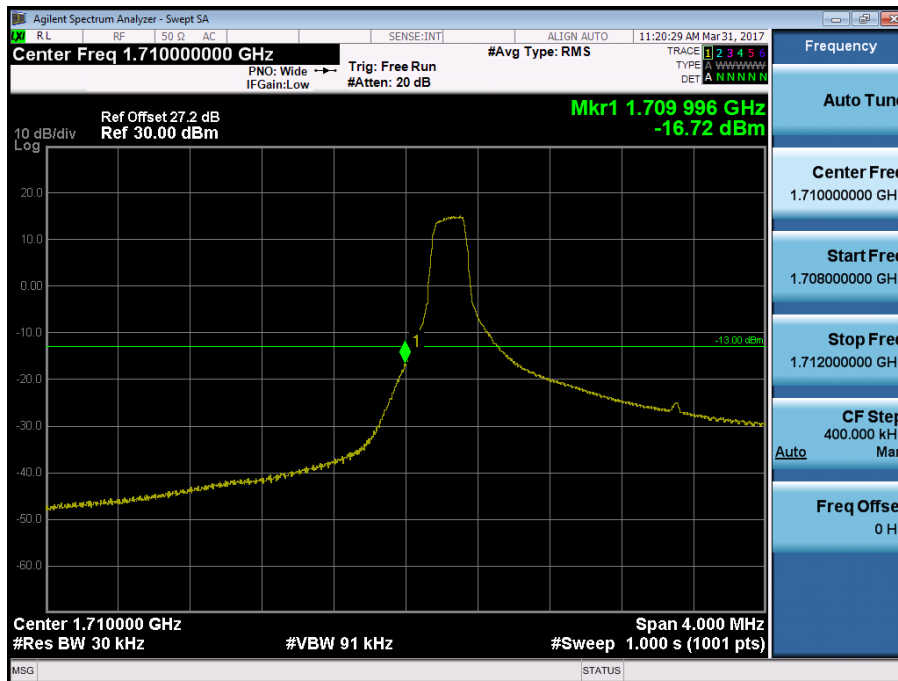

BAND 4. Lower Band Edge Plot (3M BW Ch.19965 QPSK RB 15) -2

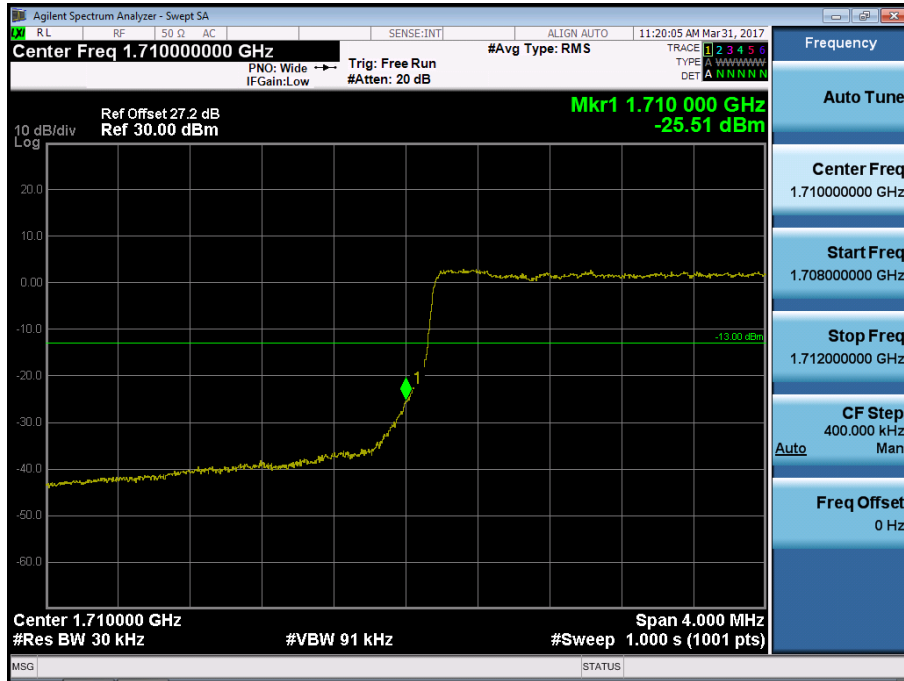

BAND 4. Lower Extended Band Edge Plot (3M BW Ch.19965 QPSK\_RB15\_0) -3

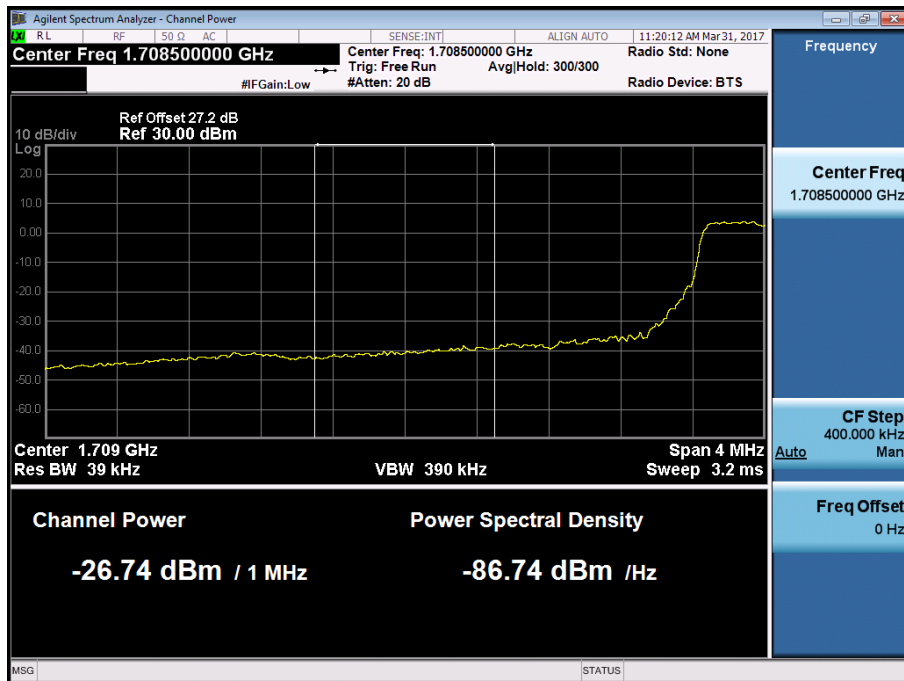

BAND 4. Lower Band Edge Plot (5M BW Ch.19975 QPSK RB 1, Offset 0) -1

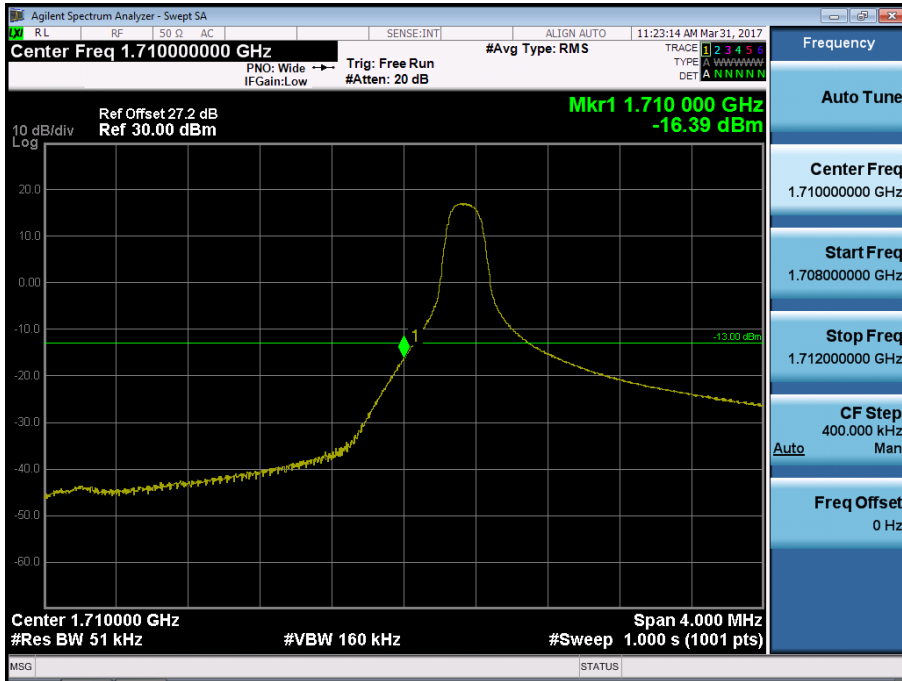

BAND 4. Lower Band Edge Plot (5M BW Ch.19975 QPSK RB 25) -2

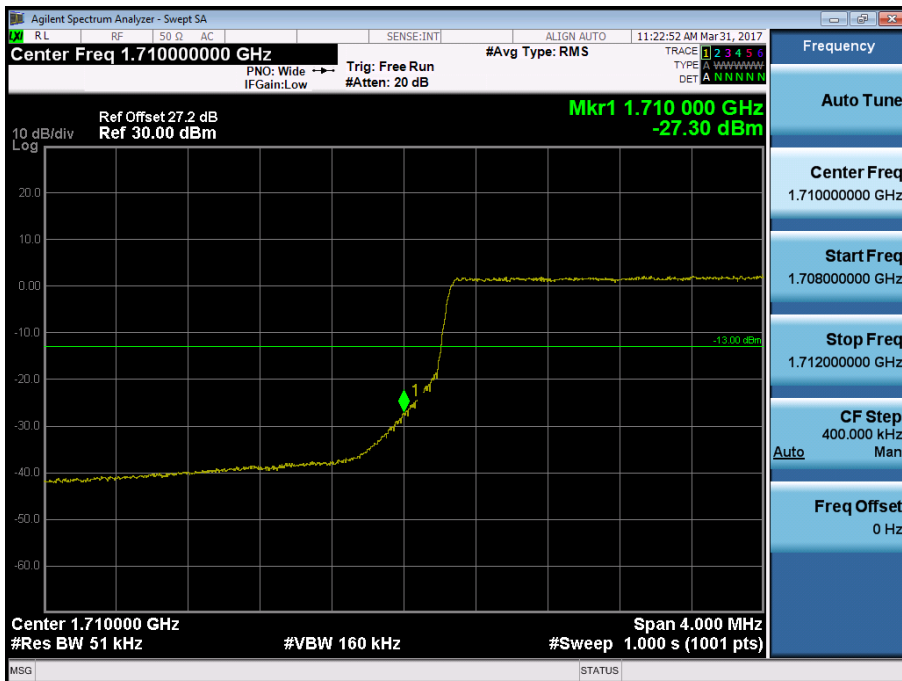

BAND 4. Lower Extended Band Edge Plot (5M BW Ch.19975 QPSK\_RB25\_0) -3

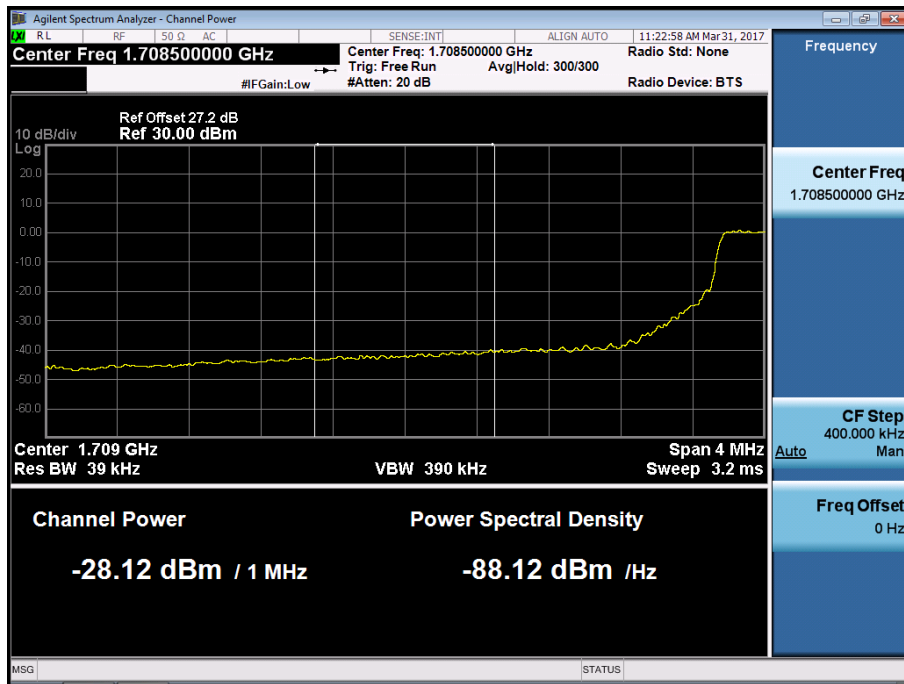

BAND 4. Lower Band Edge Plot (10M BW Ch.20000 QPSK RB 1, Offset 0) -1

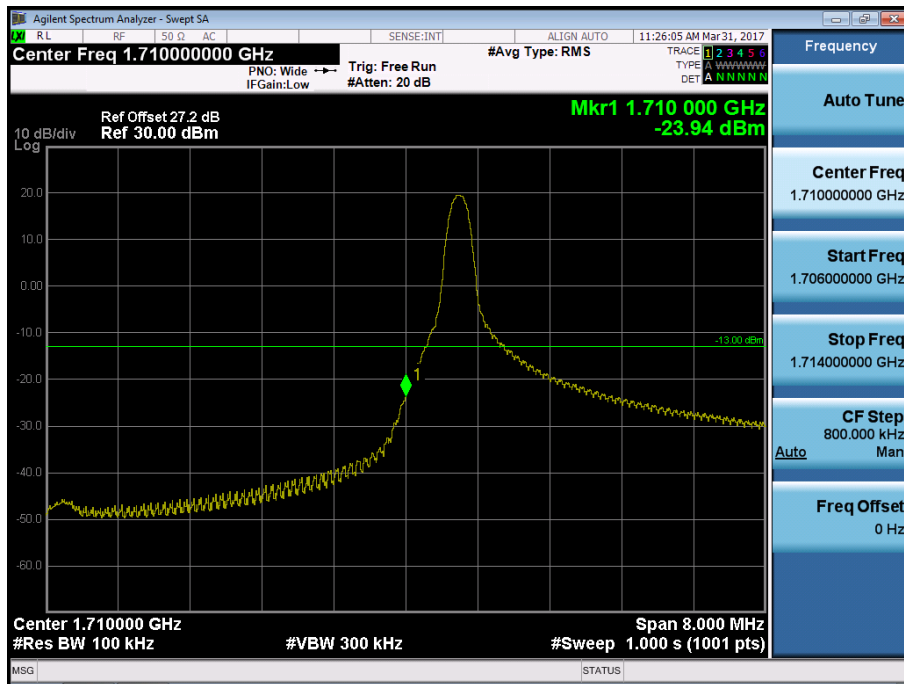

BAND 4. Lower Band Edge Plot (10M BW Ch.20000 QPSK RB 50) -2

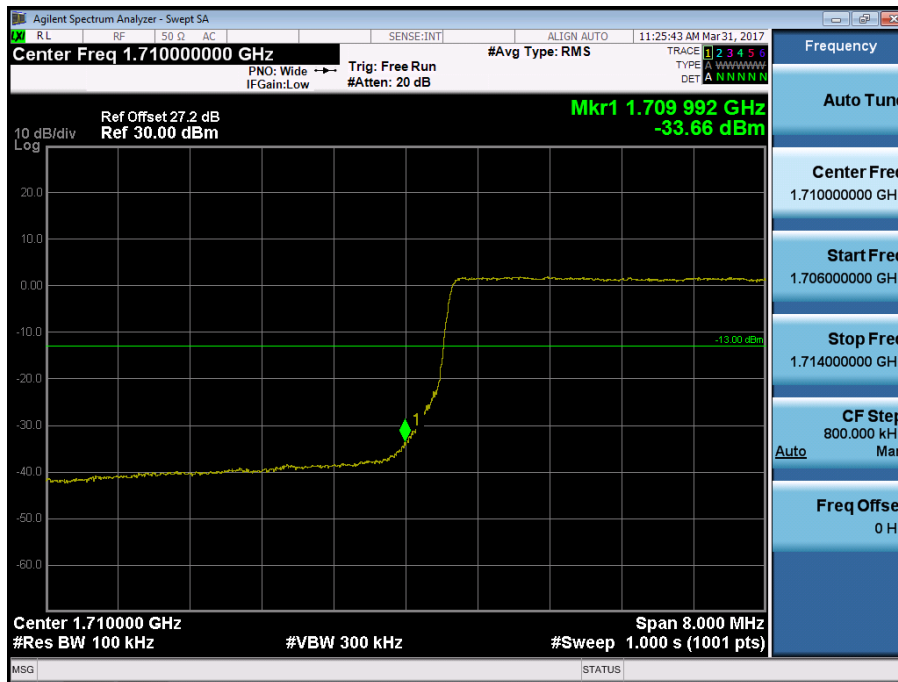

BAND 4. Lower Extended Band Edge Plot (10M BW Ch.20000 QPSK\_RB50\_0) -3

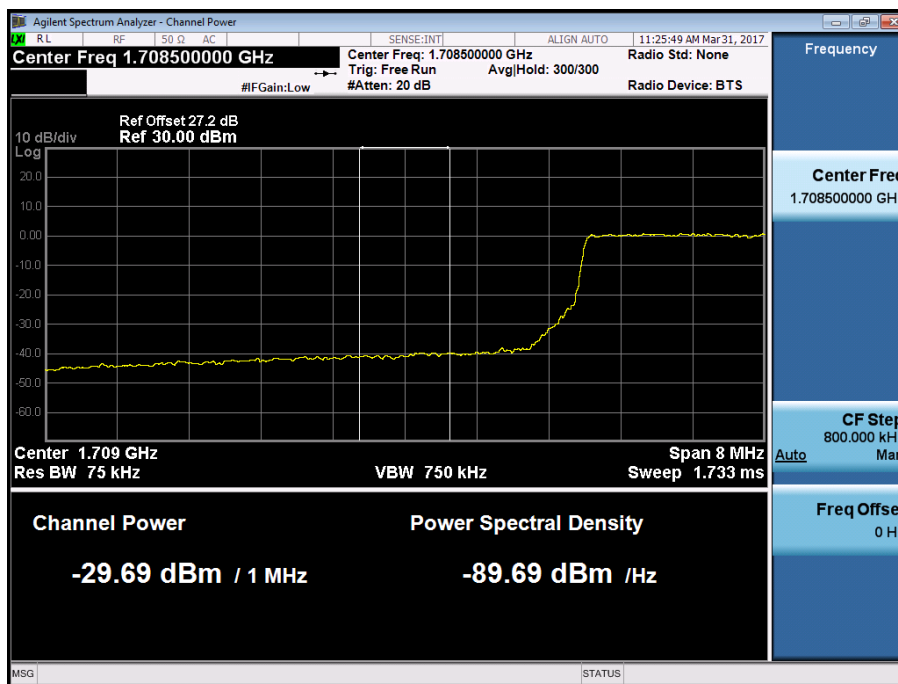

BAND 4. Lower Band Edge Plot (15M BW Ch.20025 QPSK RB 1, Offset 0) -1

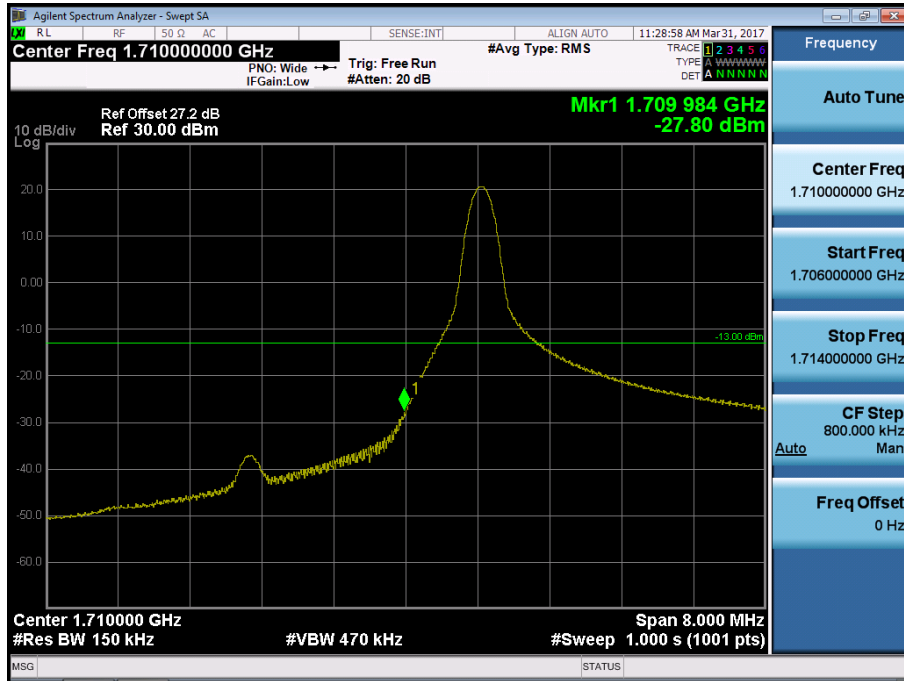

BAND 4. Lower Band Edge Plot (15M BW Ch.20025 QPSK RB 75) -2

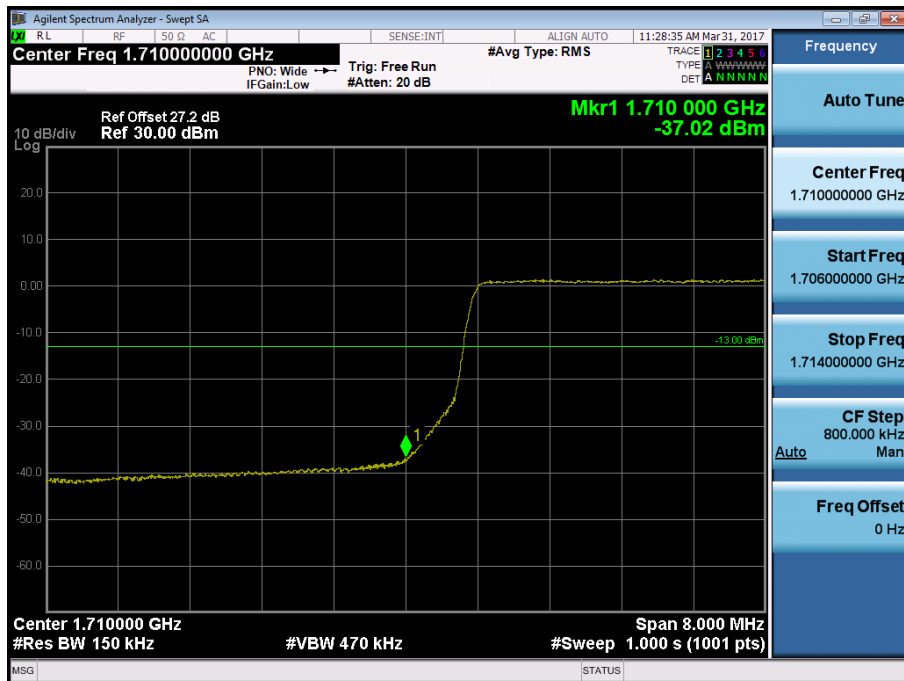

BAND 4. Lower Extended Band Edge Plot (15M BW Ch.20025 QPSK\_RB75\_0) -3

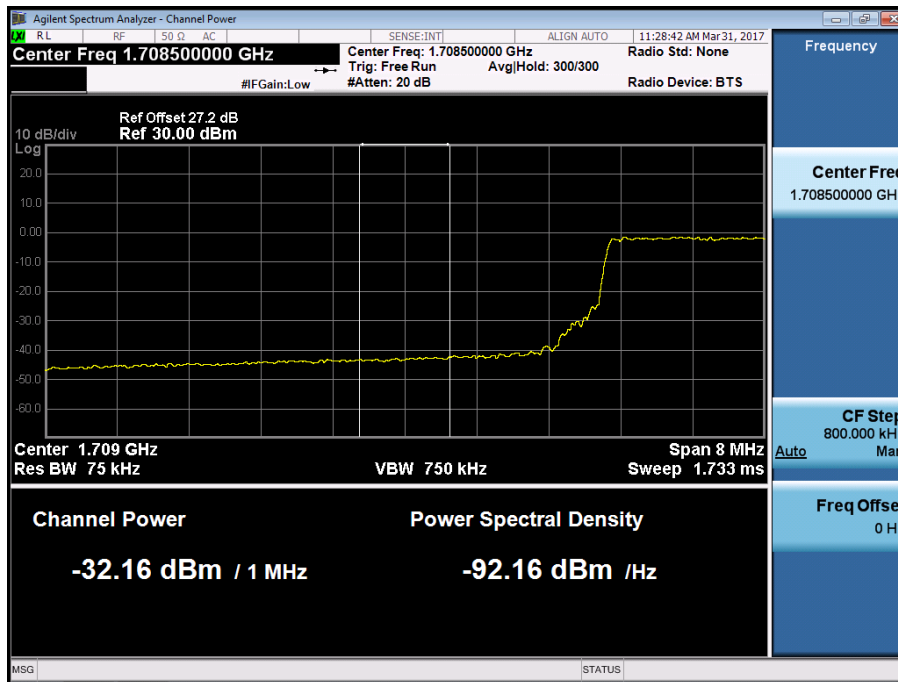

BAND 4. Lower Band Edge Plot (20M BW Ch.20050 QPSK RB 1, Offset 0) -1



BAND 4. Lower Band Edge Plot (20M BW Ch.20050 QPSK RB 100) -2



BAND 4. Lower Extended Band Edge Plot (20M BW Ch.20050 QPSK\_RB100\_0) -3

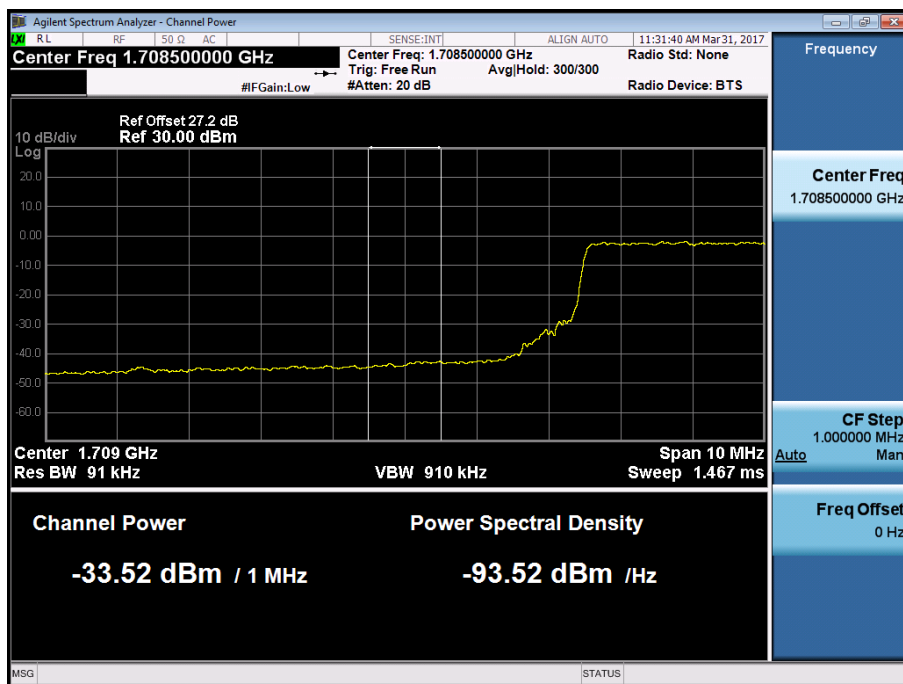

BAND 4. Upper Band Edge Plot (1.4M BW Ch.20393 QPSK\_RB1\_Offset 5) -1

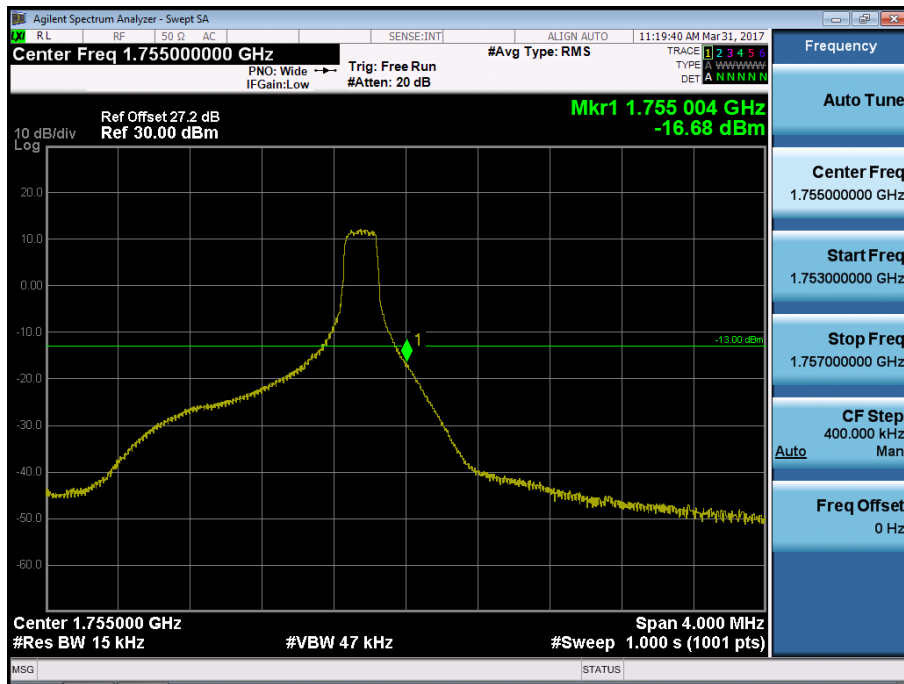

BAND 4. Upper Band Edge Plot (1.4M BW Ch.20393 QPSK\_RB6) -2



BAND 4. Upper Extended Band Edge Plot (1.4M BW Ch. 20393 QPSK\_RB6\_0) -3

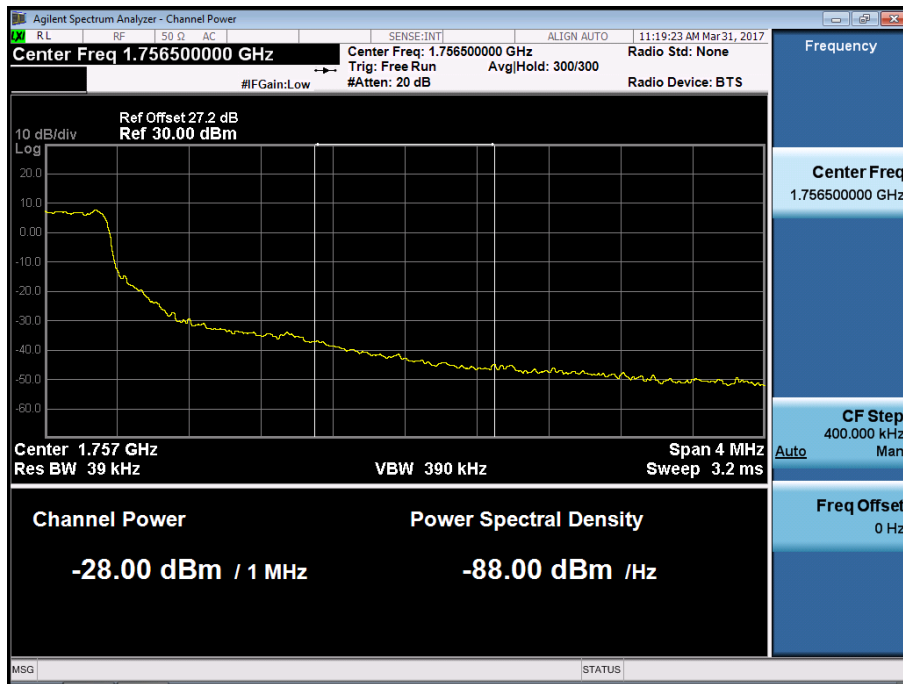

BAND 4. Upper Band Edge Plot (3M BW Ch.20385 QPSK\_RB1\_Offset 14) -1

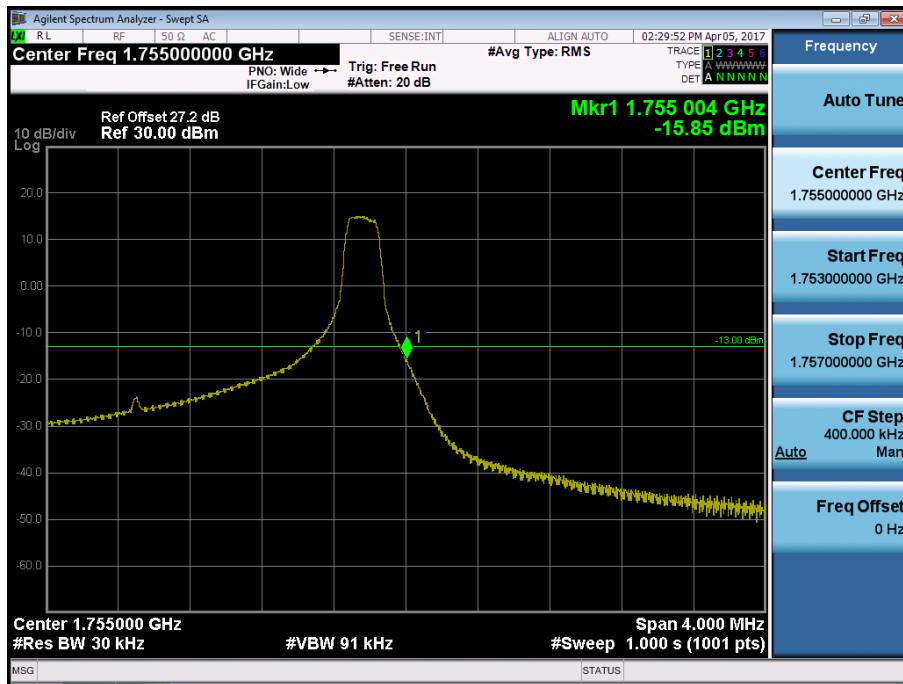

BAND 4. Upper Band Edge Plot (3M BW Ch.20385 QPSK\_RB15) -2



BAND 4. Upper Extended Band Edge Plot (3M BW Ch.20385 QPSK\_RB15\_0) -3

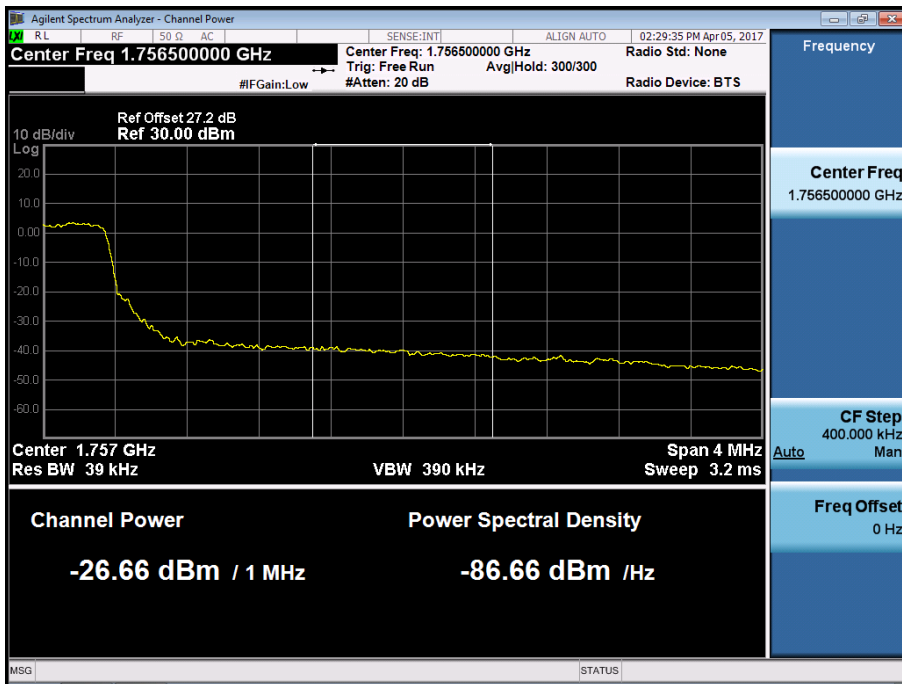

BAND 4. Upper Band Edge Plot (5M BW Ch.20375 QPSK\_RB1\_Offset 24) -1

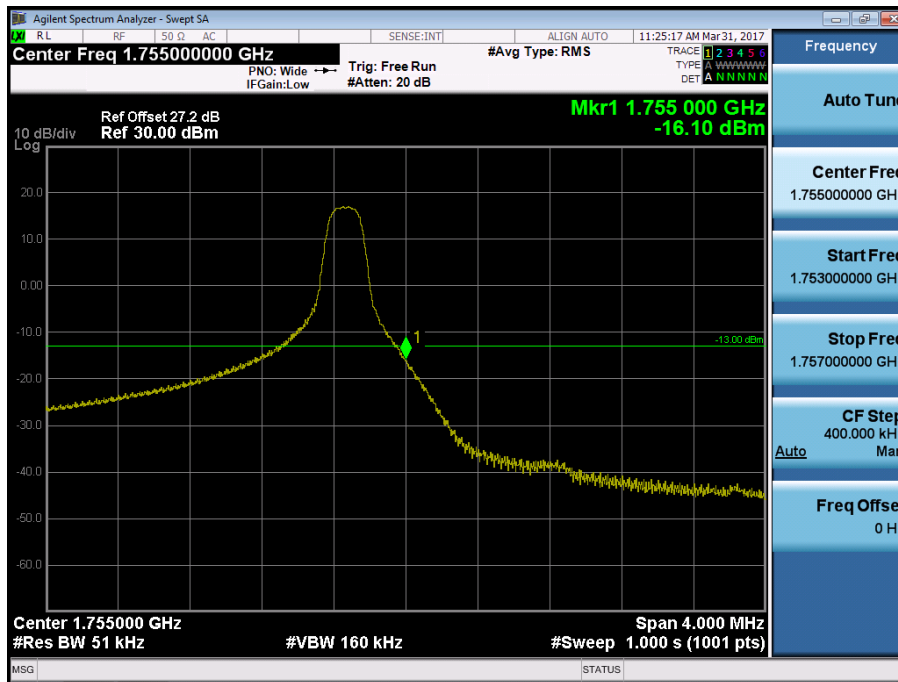

BAND 4. Upper Band Edge Plot (5M BW Ch.20375 QPSK\_RB25) -2



BAND 4. Upper Extended Band Edge Plot (5M BW Ch.20375 QPSK\_RB25) -3

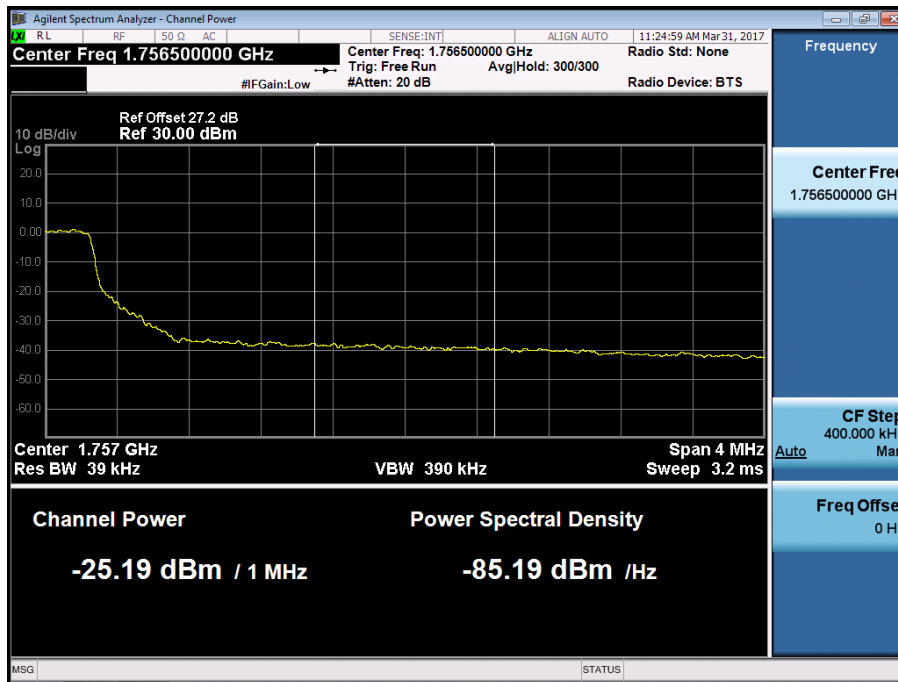

BAND 4. Upper Band Edge Plot (10M BW Ch.20350 QPSK\_RB1\_Offset 49) -1

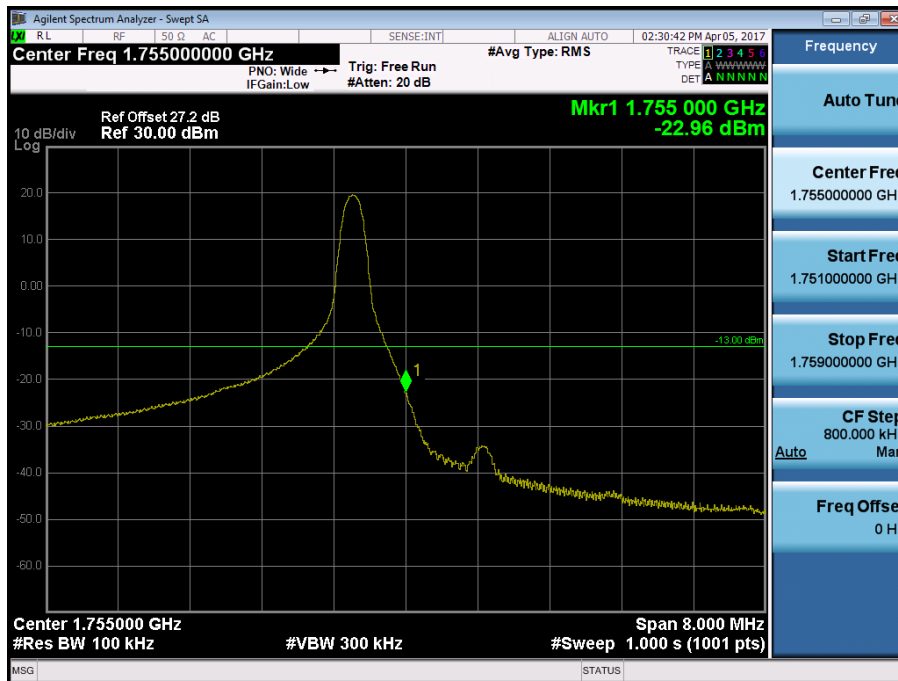

BAND 4. Upper Band Edge Plot (10M BW Ch.20350 QPSK\_RB50) -2



BAND 4. Upper Extended Band Edge Plot (10M BW Ch.20350 QPSK\_RB50) -3

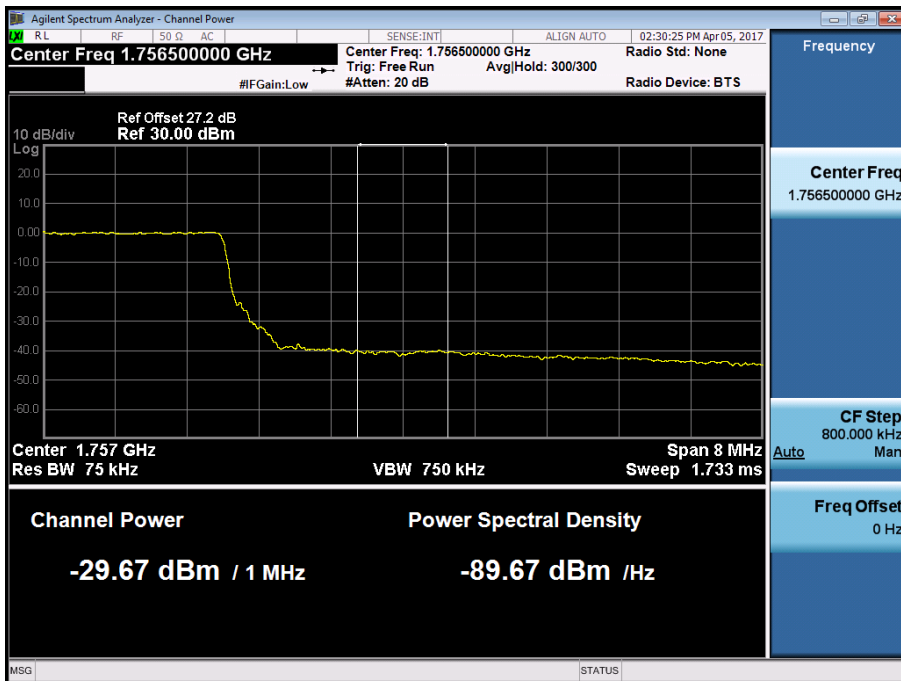

BAND 4. Upper Band Edge Plot (15M BW Ch.20325 QPSK\_RB1\_Offset 74) -1

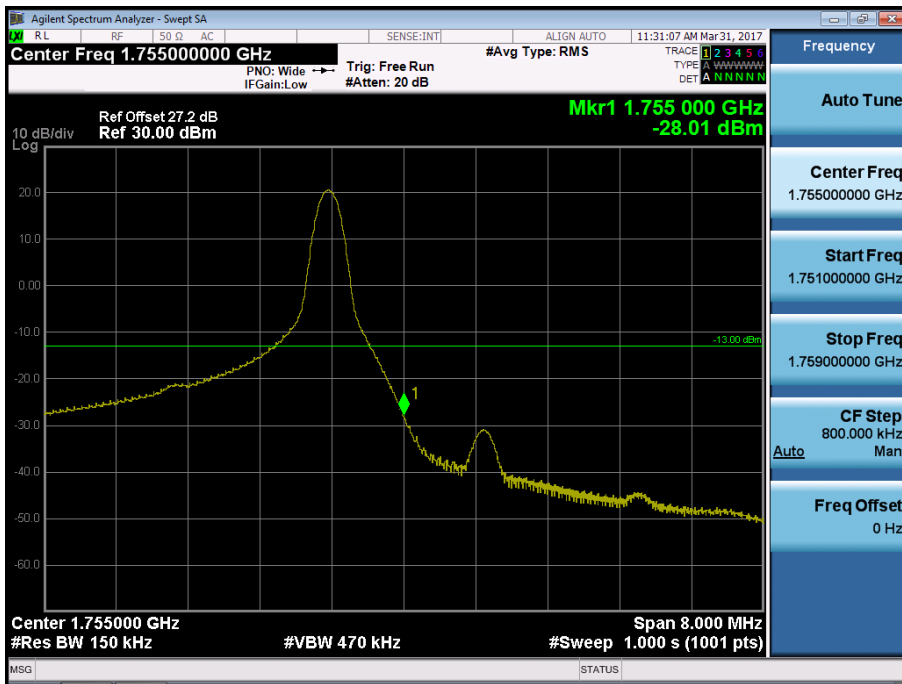

BAND 4. Upper Band Edge Plot (15M BW Ch.20325 QPSK\_RB75) -2

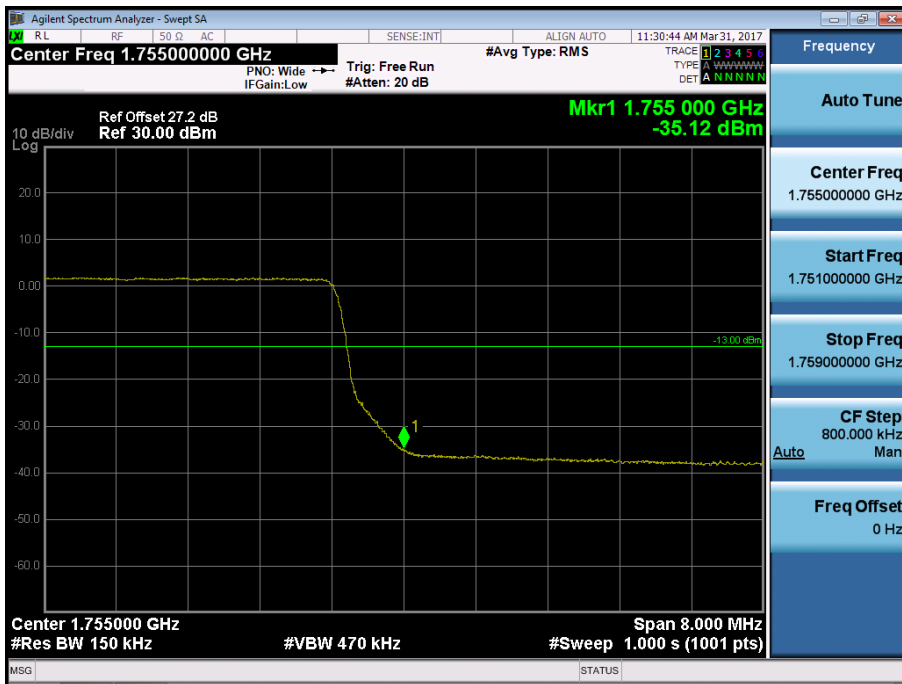

BAND 4. Upper Extended Band Edge Plot (15M BW Ch.20325 QPSK\_RB75) -3

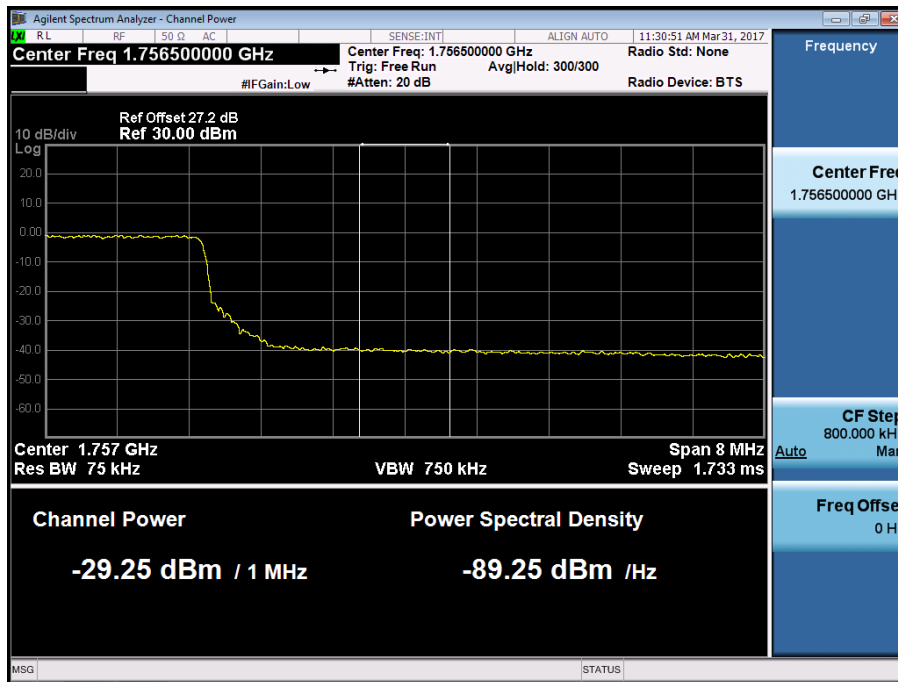

BAND 4. Upper Band Edge Plot (20M BW Ch.20300 QPSK\_RB1\_Offset 99) -1



BAND 4. Upper Band Edge Plot (20M BW Ch.20300 QPSK\_RB100) -2



BAND 4. Upper Extended Band Edge Plot (20M BW Ch.20300 QPSK\_RB100) -3

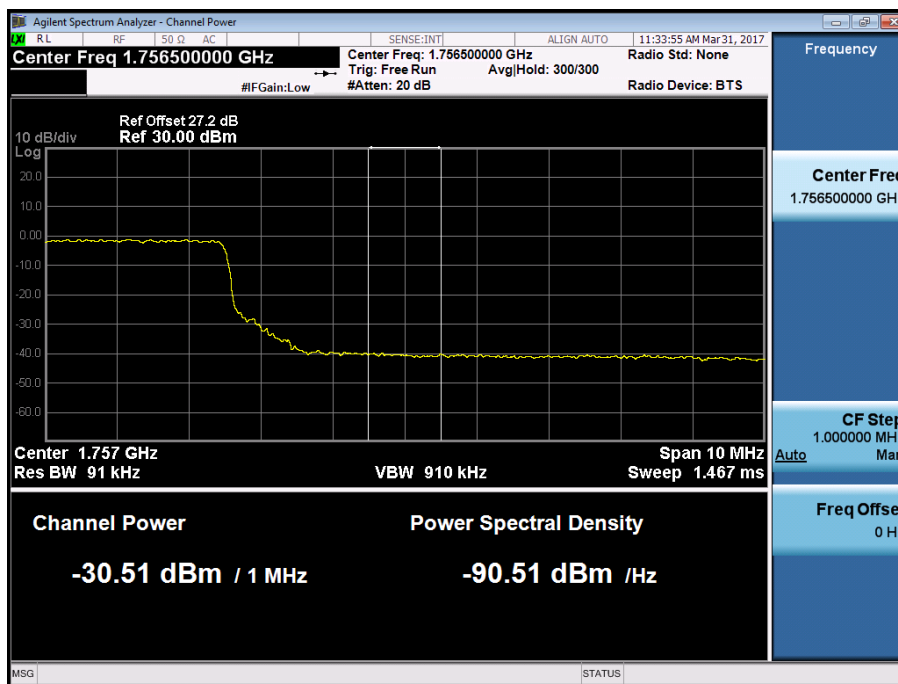

Band 17 Lower Band Edge Plot (5M BW Ch.23755 QPSK\_RB1 OFFSET0)



Band 17 Lower Band Edge Plot (5M BW Ch.23755 QPSK\_RB25)



Band 17 Lower Band Edge Plot (10M BW Ch.23780 QPSK\_RB1 OFFSET0)



Band 17 Lower Band Edge Plot (10M BW Ch.23780 QPSK\_RB50\_0)



Band 17 Upper Band Edge Plot (5M BW Ch.23825 QPSK\_RB1\_Offset 24)



Band 17 Upper Band Edge Plot (5M BW Ch.23825 QPSK\_RB25)



Band 17 Upper Extended Band Edge Plot (5M BW Ch.23825 QPSK\_RB25\_0)



Band 17 Upper Band Edge Plot (10M BW Ch.23800 QPSK\_RB1\_Offset 49)

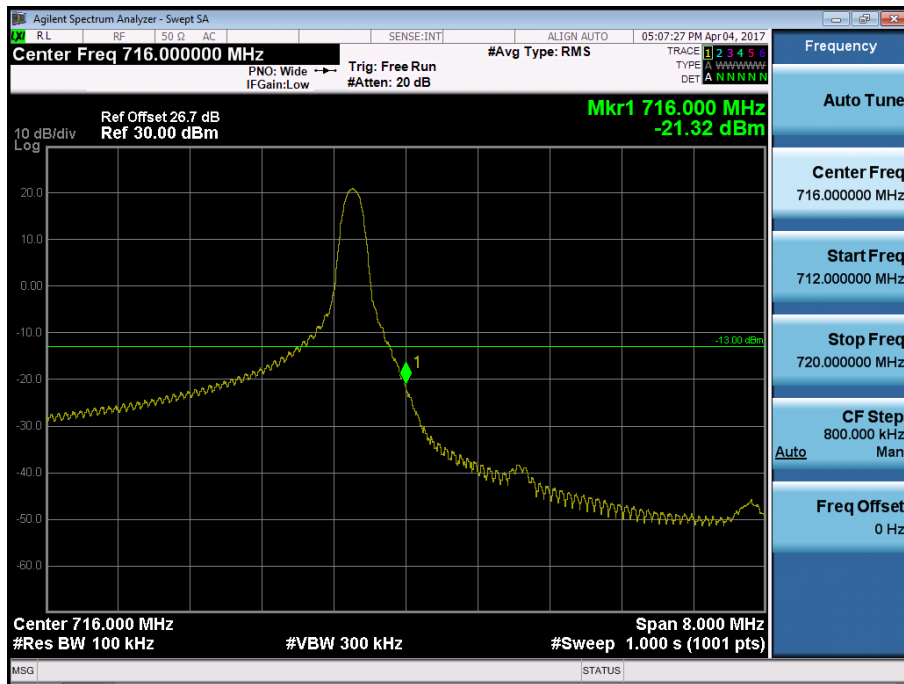

Band 17 Upper Band Edge Plot (10M BW Ch.23800 QPSK\_RB50)

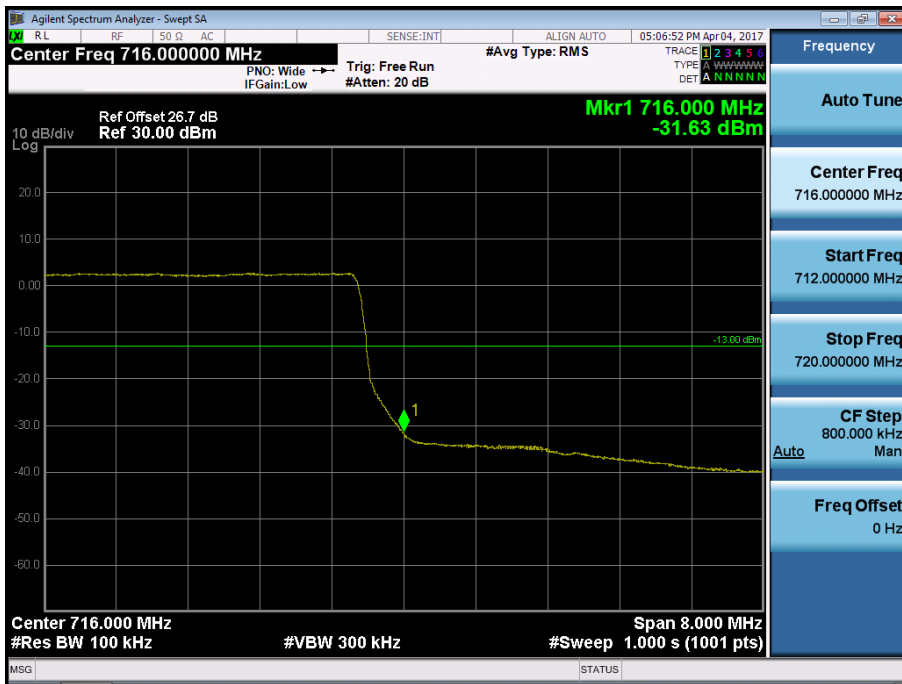

Band 17 Upper Extended Band Edge Plot (10M BW Ch.23800 QPSK\_RB50\_0)

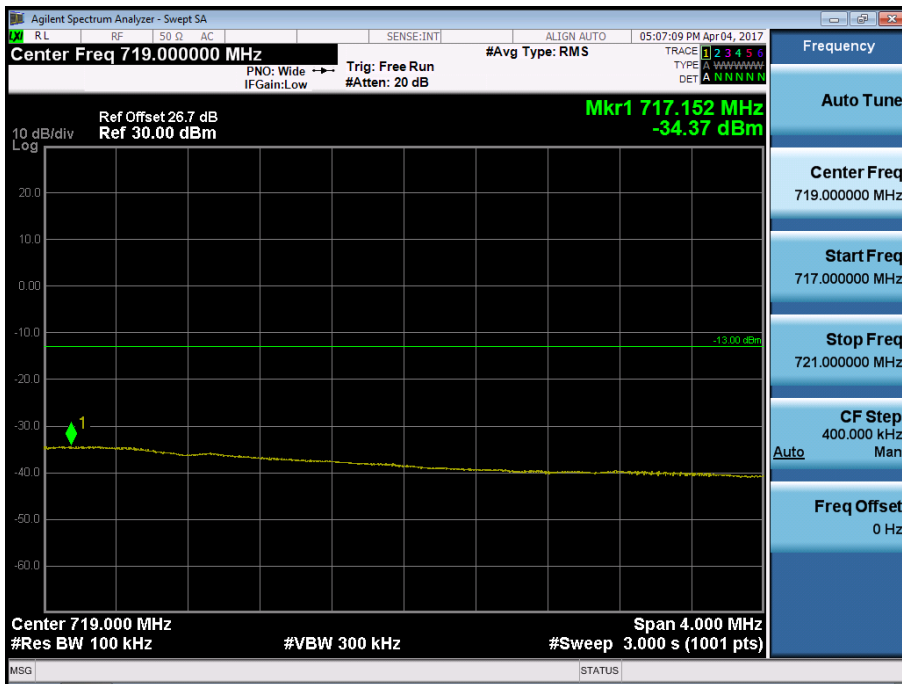

BAND 4. Conducted Spurious Plot\_1 (19957ch\_1.4MHz\_QPSK\_RB 1\_0)

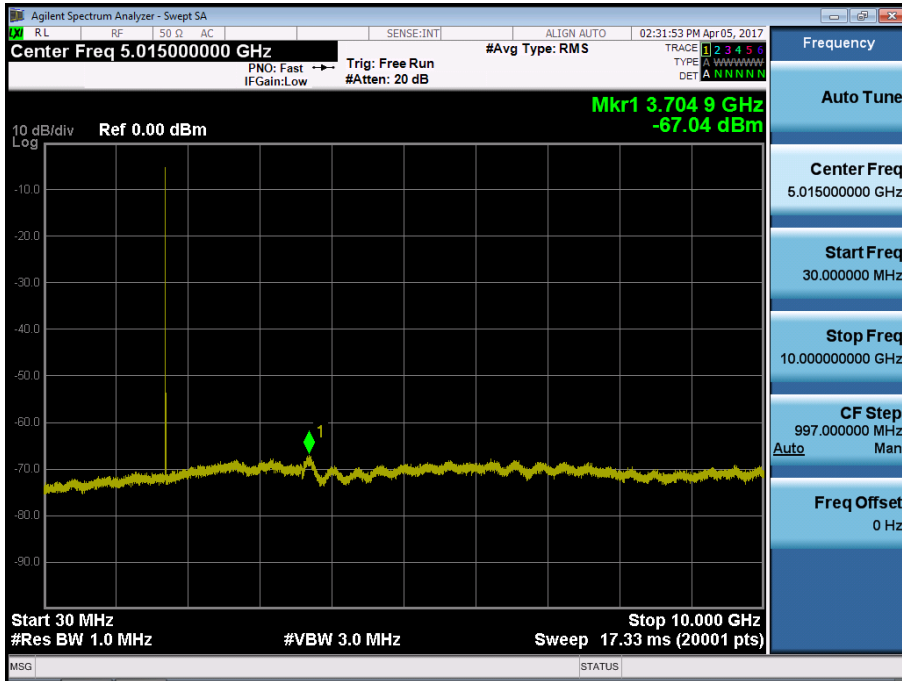

BAND 4. Conducted Spurious Plot\_2 (19957ch\_1.4MHz\_QPSK\_RB 1\_0)



BAND 4. Conducted Spurious Plot\_1 (20175ch\_1.4MHz\_QPSK\_RB 1\_0)

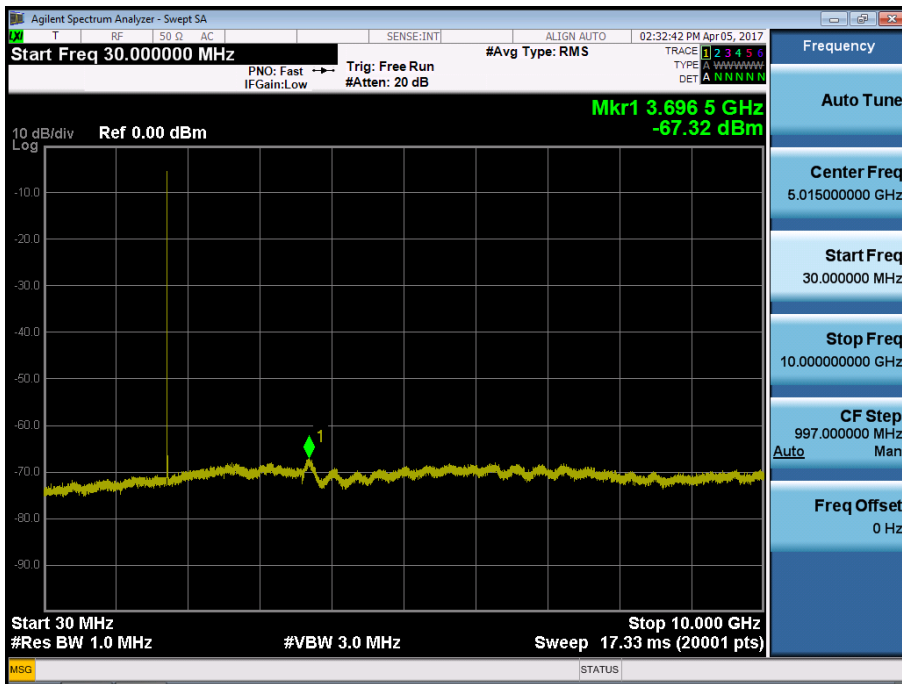

BAND 4. Conducted Spurious Plot\_2 (20175ch\_1.4MHz\_QPSK\_RB 1\_0)



BAND 4. Conducted Spurious Plot\_1 (20393ch\_1.4MHz\_QPSK\_RB 1\_0)

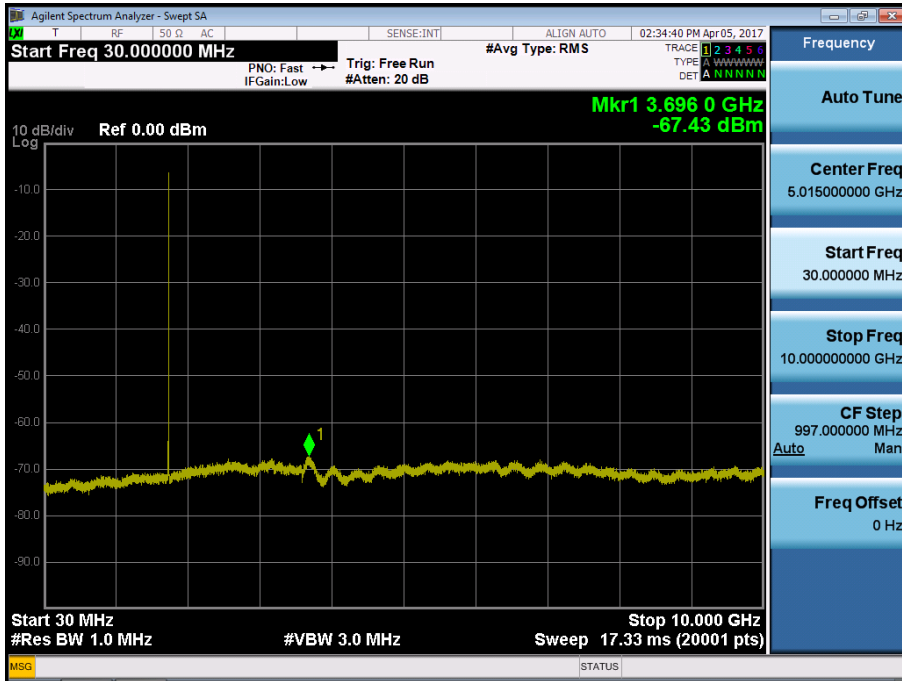

BAND 4. Conducted Spurious Plot\_2 (20393ch\_1.4MHz\_QPSK\_RB 1\_0)

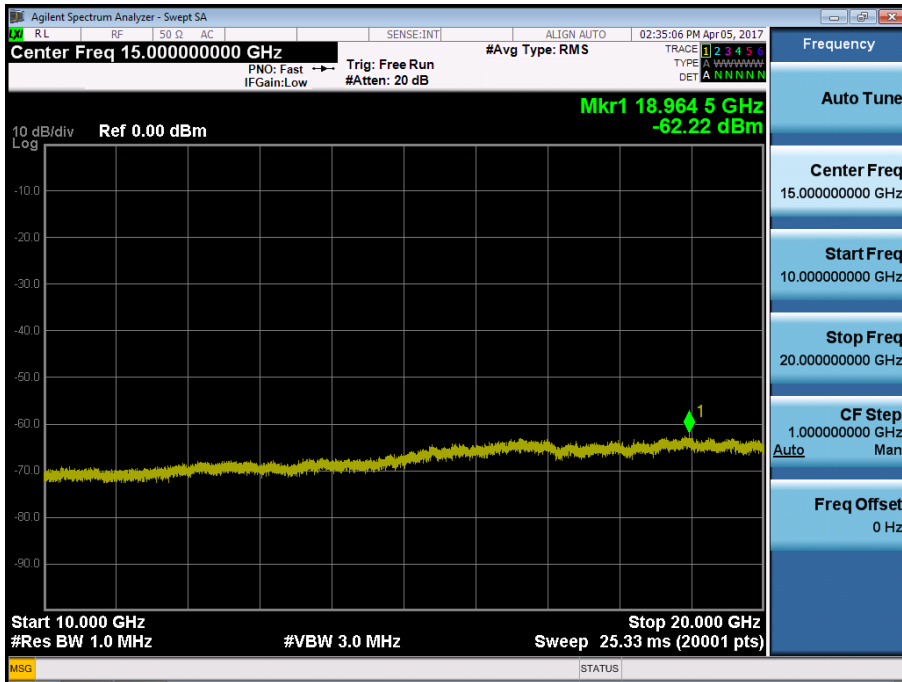

BAND 4. Conducted Spurious Plot\_1 (19965ch\_3MHz\_QPSK\_RB 1\_0)

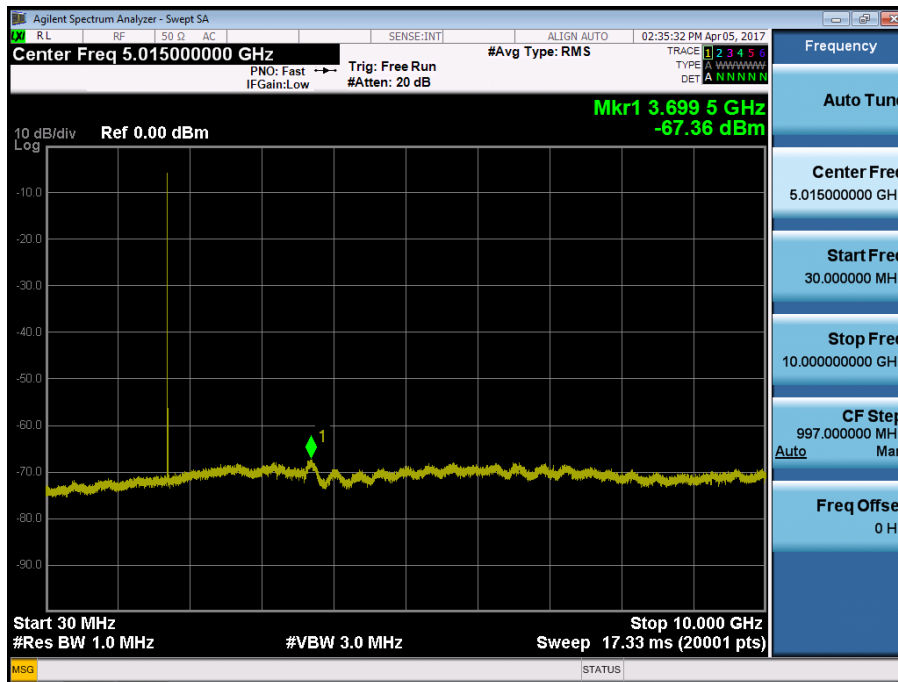

BAND 4. Conducted Spurious Plot\_2 (19965ch\_3MHz\_QPSK\_RB 1\_0)

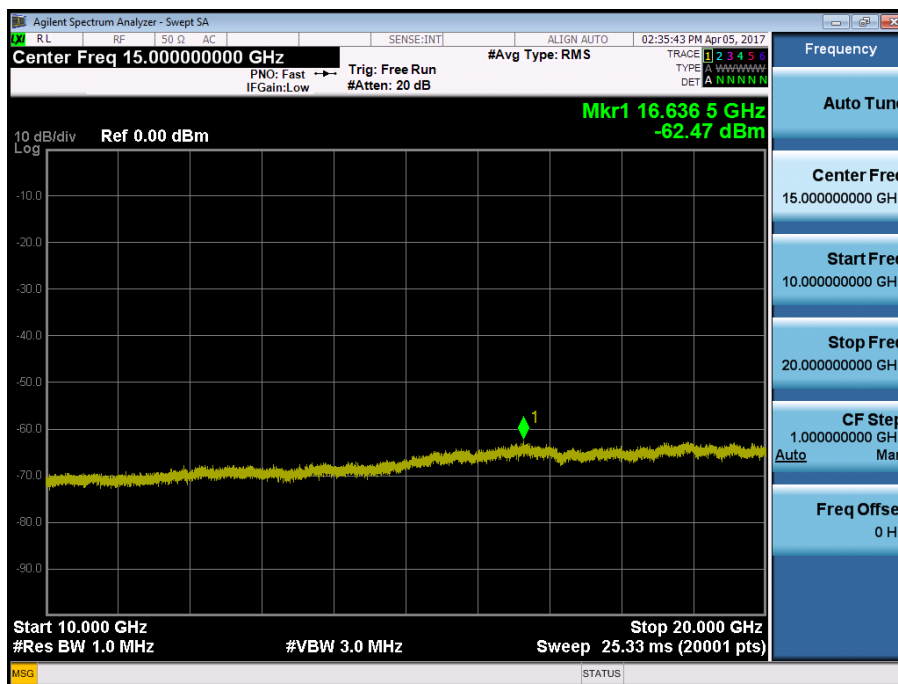

BAND 4. Conducted Spurious Plot\_1 (20175ch\_3MHz\_QPSK\_RB 1\_0)

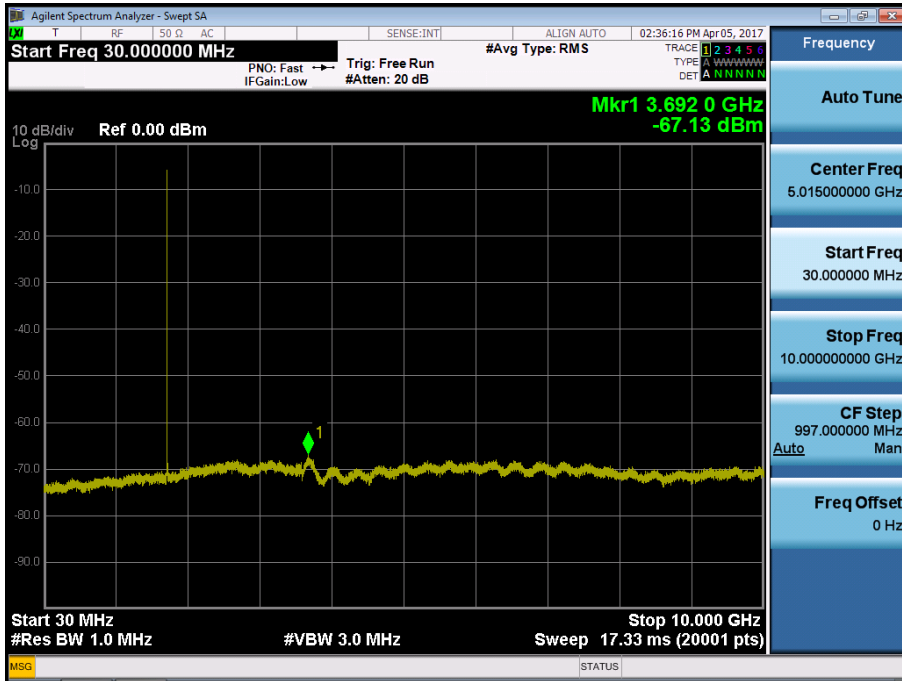

BAND 4. Conducted Spurious Plot\_2 (20175ch\_3MHz\_QPSK\_RB 1\_0)



BAND 4. Conducted Spurious Plot\_1 (20385ch\_3MHz\_QPSK\_RB 1\_0)

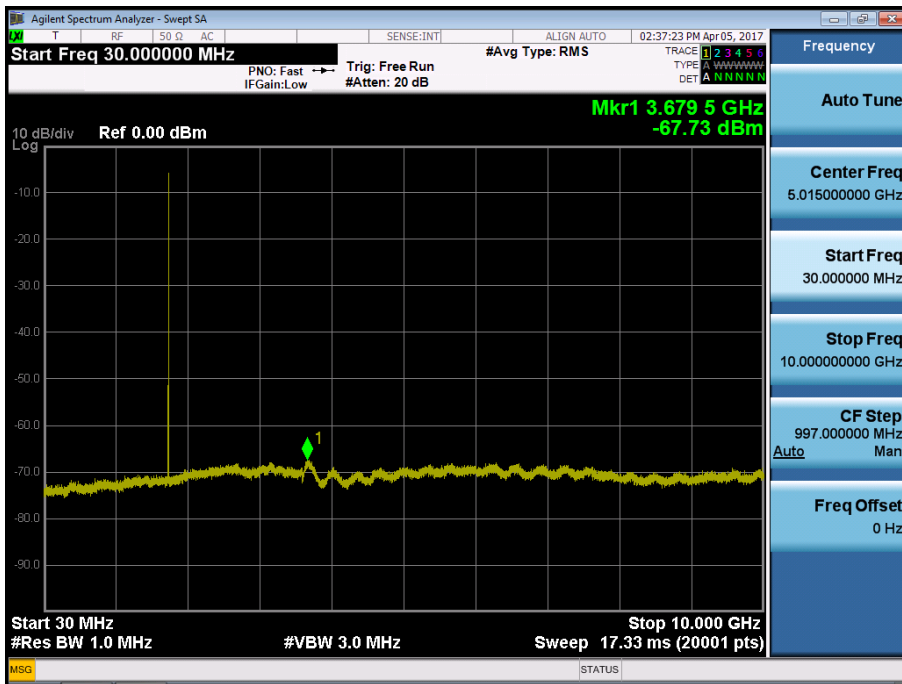

BAND 4. Conducted Spurious Plot\_2 (20385ch\_3MHz\_QPSK\_RB 1\_0)



BAND 4. Conducted Spurious Plot\_1 (19975ch\_5MHz\_QPSK\_RB 1\_0)

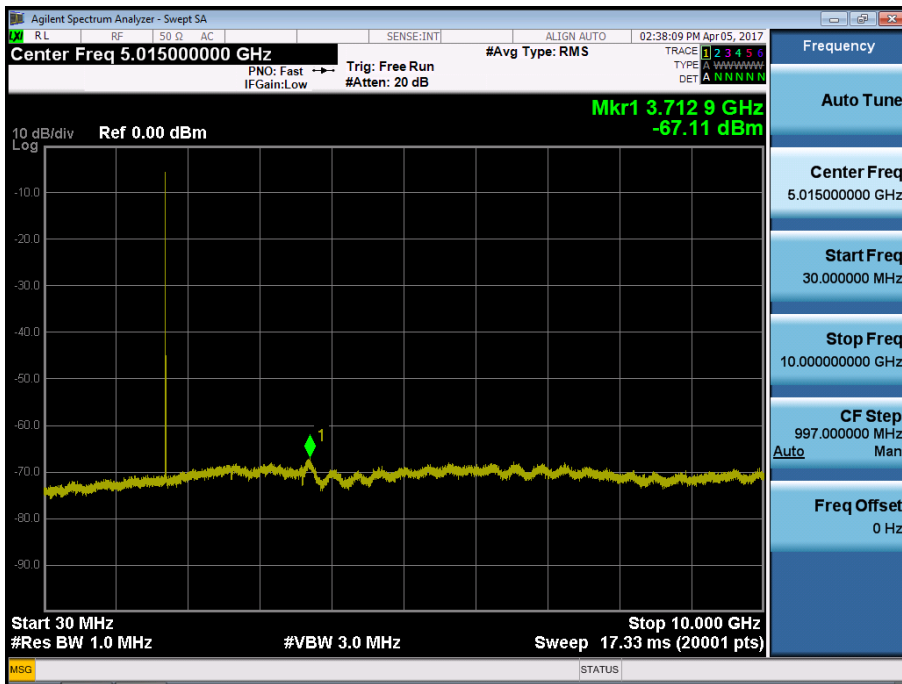

BAND 4. Conducted Spurious Plot\_2 (19975ch\_5MHz\_QPSK\_RB 1\_0)

