



HCT Co., Ltd.
74, Seoicheon-ro 578beon-gil, Majang-myeon, Icheon-si, Gyeonggi-do, 17383 KOREA
Tel. +82 31 634 6300 Fax. +82 31 645 6401

PART 2 : RF Exposure Compliance Test Report

Applicant Name: SAMSUNG Electronics Co., Ltd. 129, Samsung-ro, Yeongtong-gu, Suwon-Si, Gyeonggi-do, 16677 Rep. of Korea	Date of Issue: May 09, 2023 Test Report No.: HCT-SR-2305-FC005 Test Site: HCT CO., LTD.
---------------------------------------------------------------------------------------------------------------------------------------------	--------------------------------------------------------------------------------------------------------------------

FCC ID:

A3LSMX818U

Equipment Type:	Tablet
Application Type:	Certification
FCC Rule Part(s):	CFR §2.1093
Model Name:	SM-X818U
Date of Test:	Apr. 18. 2023 ~ May. 04. 2023
Results:	Pass

I attest to the accuracy of data. All measurements reported herein were performed by me or were made under my supervision and are correct to the best of my knowledge and belief. I assume full responsibility for the completeness of these measurements and vouch for the qualifications of all persons taking them.

Tested By

Jee-ILL, Lee
Test Engineer
SAR Team
Certification Division

Reviewed By

Yun-jeang, Heo
Technical Manager
SAR Team
Certification Division

This report only responds to the tested sample and may not be reproduced, except in full, without written approval of the HCT Co., Ltd.

REVISION HISTORY

The revision history for this test report is shown in table.

Revision No.	Date of Issue	Description
0	May 09, 2023	Initial Release

This test results were applied only to the test methods required by the standard.

The above Test Report is not related to the accredited test result by (KS Q) ISO/IEC 17025 and KOLAS(Korea Laboratory Accreditation Scheme), which signed the ILAC-MRA.

Table of Contents

1. RF Exposure Limits	4
2. Test Location	6
3. Information of the DUT	7
4. Tx Varying Transmission Test Cases and Test Proposal	12
5. SAR Time Averageing Validation Test Procedures	15
6. PD Time Averageing Validation Test Procedures	27
7. Test Configurations	34
8. Time-varying Tx power measurement for below 6GHz frequency	38
9. Radiated Power Test Results for mmW Smart Transmit Feature Validation.....	60
10. Equipment List.....	66
11. Measurement Uncertainties	67
12. Conclusion	68
Appendix A: Test Sequences	69
Appendix B: Test Procedures for sub6 NR + LTE Radio	71
Appendix C: Test setup Photo	

1. RF Exposure Limits

1.1 RF Exposure Limits for Frequencies < 6 GHz

HUMAN EXPOSURE	UNCONTROLLED ENVIRONMENT General Population (W/kg) or (mW/g)	CONTROLLED ENVIRONMENT Occupational (W/kg) or (mW/g)
SPATIAL PEAK SAR * (Partial Body)	1.6	8.0
SPATIAL AVERAGE SAR ** (Whole Body)	0.08	0.4
SPATIAL PEAK SAR *** (Hands / Feet / Ankle / Wrist)	4.0	20.0

NOTES:

* The Spatial Peak value of the SAR averaged over any 1 g of tissue (defined as a tissue volume in the shape of a cube) and over the appropriate averaging time.

** The Spatial Average value of the SAR averaged over the whole-body.

*** The Spatial Peak value of the SAR averaged over any 10 g of tissue (defined as a tissue volume in the shape of a cube) and over the appropriate averaging time.

Uncontrolled Environments are defined as locations where there is the exposure of individuals who have no knowledge or control of their exposure. The general population/uncontrolled exposure limits are applicable to situations in which the general public may be exposed or in which persons who are exposed as a consequence of their employment may not be made fully aware of the potential for exposure or cannot exercise control over their exposure. Members of the general public would come under this category when exposure is not employment-related; for example, in the case of a wireless transmitter that exposes persons in its vicinity.

Controlled Environments are defined as locations where there is exposure that may be incurred by persons who are aware of the potential for exposure, (i.e. as a result of employment or occupation). In general, occupational/controlled exposure limits are applicable to situations in which persons are exposed as a consequence of their employment, who have been made fully aware of the potential for exposure and can exercise control over their exposure. This exposure category is also applicable when the exposure is of a transient nature due to incidental passage through a location where the exposure levels may be higher than the general population/uncontrolled limits, but the exposed person is fully aware of the potential for exposure and can exercise control over his or her exposure by leaving the area or by some other appropriate means.

1.2 RF Exposure Limits for Frequencies > 6 GHz

Per §1.1310 (d)(3), the MPE limits are applied for frequencies above 6 GHz. Power Density is expressed in units of W/m² or mW/cm².

Peak Spatially Averaged Power Density was evaluated over a circular area of 4 cm² per interim FCC Guidance for near-field power density evaluations per October 2018 TCB Workshop notes

Frequency range (MHz)	Power density (mW/cm ²)	Averaging time (minutes)
(A) Limits for Occupational/Controlled Exposure		
1,500-100,000	5	6
(B) Limits for General Population/Uncontrolled Exposure		
1,500-100,000	1	30

Note: 1.0 mW/cm² is 10 W/m²

1.3 T Interim Guidance for Time Averaging

Per October 2018 TCB Workshop Notes, the below time-averaging windows can be used for assessing time-averaged exposures for devices that are capable of actively monitoring and adjusting power output over time to comply with exposure limits.

Interim Guidance	Frequency (GHz)	Maximum Averaging Time (sec)
SAR	< 3	100
	3 – 6	60
MPE	6 - 10	30
	10 - 16	14
	16 – 24	8
	24 – 42	4
	42 – 95	2

2. Test Location

2.1 Test Laboratory

Company Name	HCT Co., Ltd.
Address	74, Seoicheon-ro 578beon-gil, Majang-myeon, Icheon-si, Gyeonggi-do, 17383 KOREA
Telephone	031-645-6300
Fax.	031-645-6401

2.2 Test Facilities

Our laboratories are accredited and approved by the following approval agencies according to ISO/IEC 17025.

Korea	National Radio Research Agency (Designation No. KR0032)
	KOLAS (Testing No. KT197)

3. Information of the DUT

3.1 General Information of the DUT

Model Name	SM-X818U
Equipment Type	Tablet
FCC ID	A3LSMX818U
Application Type	Certification
Applicant	SAMSUNG Electronics Co., Ltd.

3.2 DUT Specification overview

Device Wireless specification overview		
Band & Mode	Operating Mode	Tx Frequency
UMTS Band 5	Data	826.4 MHz ~ 846.6 MHz
UMTS Band 4	Data	1 712.4 MHz ~ 1 752.6 MHz
UMTS Band 2	Data	1 852.4 MHz ~ 1 907.6 MHz
LTE Band 2 (PCS)	Data	1 850.7 MHz ~ 1 909.3 MHz
LTE Band 4 (AWS)	Data	1 710.7 MHz ~ 1 754.3 MHz
LTE Band 5 (Cell)	Data	824.7 MHz ~ 848.3 MHz
LTE Band 7	Data	2 502.5 MHz ~ 2 567.5 MHz
LTE Band 12	Data	699.7 MHz ~ 715.3 MHz
LTE Band 13	Data	779.5 MHz ~ 784.5 MHz
LTE Band 14	Data	790.5 MHz ~ 795.5 MHz
LTE Band 25 (PCS)	Data	1 850.7 MHz ~ 1 914.3 MHz
LTE Band 26	Data	814.7 MHz ~ 848.3 MHz
LTE Band 30	Data	2 307.5 MHz ~ 2 312.5 MHz
LTE TDD Band 41	Data	2 498.5 MHz ~ 2 687.5 MHz
LTE TDD Band 48	Data	3 552.5 MHz ~ 3 697.5 MHz
LTE Band 66 (AWS)	Data	1 710.7 MHz ~ 1 779.3 MHz
LTE Band 71	Data	665.5 MHz ~ 695.5 MHz
NR Band n2	Data	1 852.5 MHz ~ 1 907.5 MHz
NR Band n5	Data	826.5 MHz ~ 846.5 MHz
NR Band n7	Data	2 502.5 MHz ~ 2 567.5 MHz
NR Band n12	Data	701.5 MHz ~ 713.5 MHz
NR Band n25	Data	1 852.5 MHz ~ 1912.5 MHz
NR Band n26	Data	816.5 MHz ~ 846.5 MHz
NR Band n30	Data	2 307.5 MHz ~ 2 312.5 MHz
NR Band n41	Data	2 501.01 MHz ~ 2 685 MHz
NR Band n48	Data	3 560.01 MHz ~ 3 690 MHz
NR Band n66	Data	1 712.5 MHz ~ 1 777.5 MHz
NR Band n71	Data	665.5 MHz - 695.5 MHz
NR Band n77	Data	3 705 MHz ~ 3 975 MHz
NR Band n77 DoD	Data	3 450 MHz ~ 3 550 MHz
NR Band n258	Data	24 250 MHz ~ 24 450 MHz; 24 750 MHz ~ 25 250 MHz
NR Band n260	Data	37 000 MHz ~ 40 000 MHz
NR Band n261	Data	27 500 MHz ~ 28 350 MHz
2.4 GHz WLAN	Data	2 412 MHz ~ 2 462 MHz
U-NII-1	Data	5 180 MHz ~ 5 240 MHz
U-NII-2A	Data	5 260 MHz ~ 5 320 MHz
U-NII-2C	Data	5 500 MHz ~ 5 720 MHz
U-NII-3	Data	5 745 MHz ~ 5 825 MHz
U-NII-4	Data	5 845 MHz ~ 5 885 MHz
U-NII-5	Data	5 935 MHz ~ 6 415 MHz
U-NII-6	Data	6 435 MHz ~ 6 515 MHz
U-NII-7	Data	6 535 MHz ~ 6 875 MHz
U-NII-8	Data	6 875 MHz ~ 7 115 MHz
Bluetooth / LE 5.3	Data	2 402 MHz ~ 2 480 MHz
S-Pen	Data	531 kHz
Device Serial Numbers	Mode	Serial Number
	2G/3G/4G	WBR0892M
	5G Sub 6 NR	WBR0892M
	5G FR2 mmWave	WCK0886M
The manufacturer has confirmed that the devices tested have the same physical, mechanical and thermal characteristics are within operational tolerances expected for production units.		

3.3 Time-Averaging Algorithm for RF Exposure Compliance

The device is enabled with Qualcomm® Smart Transmit feature.

This feature performs time averaging algorithm in real time to control and manage transmitting power and ensure the time-averaged RF exposure is in compliance with FCC requirements all the time. DUT contains embedded file system(EFS) version 19 configured the second generation (GEN 2) for sub 6 and for the first generation(GEN 1) for mmWave with MCC Settings for the US market.

The Smart Transmit algorithm maintains the time-averaged transmit power, in turn, time-averaged RF exposure of SAR_design_target for sub 6 radio or PD_design_target for 5G mmW NR, below the predefined time averaged power limit for each characterized technology and band.

Smart Transmit allows the device to transmit at higher power instantaneously, as high as Pmax, when needed , but enforces power limiting to maintain time-averaged transmit power to Plimit for frequencies < 6 GHz and input.power.limit for frequencies > 6 GHz.

Note that the device uncertainty for sub 6GHz WWAN is 1.0dB for this DUT, the device uncertainty for mmW is 2.0 dB, and the reserve power margin is 3 dB.

The reserve margin for WWAN radios can be configured for each sub6 antenna group, and each exposure category as shown below:

For a given exposure category (head vs. non-head) and antenna group, OEM can configure:

- o TOTAL_MIN_RES_RATIO

This entry corresponds to the minimum reserve margin for WWAN radio or WLAN radio when operating in standalone mode per antenna group. Here, TOTAL_MIN_RES_RATIO is 0.5.

- o WWAN_PRI_SPLIT_RATIO, WWAN_SEC_SPLIT_RATIO

In multi-Tx scenarios in the same antenna group, minimum reserve for each active radio (i.e., WWAN primary radio, WWAN secondary radio) is a product of the corresponding fraction out of sum of active radio split ratios and TOTAL_MIN_RES_RATIO.

In case of WWAN primary and WWAN secondary simultaneous transmission in the same antenna group, the minimum reserve for each radio, respectively, are:

- o $TOTAL_MIN_RES_RATIO * \{WWAN_PRI_SPLIT_RATIO / (WWAN_PRI_SPLIT_RATIO + WWAN_SEC_SPLIT_RATIO)\}$
- o $TOTAL_MIN_RES_RATIO * \{WWAN_SEC_SPLIT_RATIO / (WWAN_PRI_SPLIT_RATIO + WWAN_SEC_SPLIT_RATIO)\}$

Here, WWAN_PRI_SPLIT_RATIO is 0.6 and WWAN_SEC_SPLIT_RATIO is 0.4

This purpose of the Part 2 report is to demonstrate the DUT complies with FCC RF exposure requirement under Tx varying transmission scenarios, thereby validity of Qualcomm® Smart Transmit feature implementation in this device. It serves to compliment the Part 0 and Part 1 Test Reports to justify compliance per FCC.

■ Regulatory body configuration:

Based on regulatory requirement for each countries/regions, FCC time window/limits and/or ICNIRP 1998 time window/limits can be selected and/or combined. Additionally, Time-Averaged Exposure mode or Peak Exposure mode can be selected based on MCC for Smart Transmit to operate. In Time-Averaged Exposure mode, the wireless device can instantaneously transmit at high transmit powers and exceed the Plimit for a short duration before limiting the power to maintain the time-averaged transmit power under the Plimit; while in Peak Exposure mode, the maximum instantaneous transmit power is limited to Plimit. Depending on EFS version, regulatory body configuration is different.

■ force peak for Tx transmitting frequency

The Smart Transmit feature applies time-averaging windows when the device detects an MCC that matches Time-Averaged Exposure MCCs list. For each of the MCCs under Time-Averaged Exposure MCCs list, the Smart Transmit feature can limit either maximum peak power or maximum time-average power to Plimit per tech/band/antenna/DSI. If force peak is set to '1' for a given tech/band/antenna/DSI in the EFS, then the Smart Transmit feature limits the maximum Tx power to Plimit for the selected tech/band/antenna/DSI. In other words, with force peak set to '1', under static condition (i.e., fixed tech/band/antenna/DSI) and in single active Tx scenario, Smart Transmit can guarantee Tx power level of Plimit at all times.

The EFS Version of DUT is EFS ver.19

This device was tested in part 2 of Tx Varying transmission(Time-Averaged Exposure mode) testing using US MCC (310).and MCC , '1' was used to test the peak exposure mode.

All Part 2 tests of this device were conducted according to the guidelines of the Qualcomm document 80-W2112-5 Rev. YA

■ Test case reduction for multiple filings

Per the Guidance of the FCC and Qualcomm (Document No: 80-W2112-5 Rev. YA, Sec.4.2.2, Appendix K)

For multiple filings with same chipset, the test case reduction proposal for Part 2 testing is:

1. Full set of tests in the first filing, i.e., both power measurement and RF exposure measurement, are required.
2. For all subsequent filings with the same chipset, only power measurement (scenarios (a) – (h)) is required. In the case of scenario (a) time-varying Tx transmission test, only one band (instead of two bands) per technology is sufficient

Measurement Plot Summary Table

Test Case#	Test Scenario	Tech	Band	Antenna	DSI	Channel	Frequency [MHz]	Conducted Plot No.
1	Time-varying Tx. power transmission (Conducted Power, SAR)	LTE	B7	Main1	3	21100	2535	1
2			B13	Main1	3	23230	782	2
3		UMTS	B4	Main1	3	1513	1752.6	3
4		Sub6 NR	n7	Main 1	1	376500	1882.5	4
5			n77	Main 2	1	662000	3930	5
6	Change in Call	Sub6 NR	n77	Main 2	1	662000	3930	6
7	Tech/Band Switch	LTE	B7	Main 1	1	21100	2535	7
		UMTS	B5	Main 1	3	4183	836.6	
8	DSI Switch	Sub6 NR	n77	Main 2	1	662000	3930	8
					0	662000	3930	
9	Antenna Switch	Sub6 NR	n41	Main 1	1	518598	2593.99	9
			n77	Main 2	1	662000	3930	
10	Time Window	Sub6 NR	n41	Main 1	1	518598	2593.99	10
			n77	Main 2	1	662000	3930	
11	SAR1 vs SAR2	LTE	B5	Main 1	1	20525	836.5	11
		Sub6 NR	n7	Main 1	1	376500	1882.5	

Test Case #	Transmission Scenario	Test	Technology and Band	mmW Beam	Radiation Plot No.
12	Time-varying Tx power test	Cond. & Rad. Power meas.	LTE Band 2 and n261	Beam ID 36	12
13	Switch in SAR vs. PD	Cond. & Rad. Power meas.	LTE Band 2 and n261	Beam ID 36	13
14	Beam switch test	Cond. & Rad. Power meas.	LTE Band 2 and n261	Beam ID 36 to Beam ID 6	14

4. Tx Varying Transmission Test Cases and Test Proposal

To validate time averaging feature and demonstrate the compliance in Tx varying transmission conditions, the following transmission scenarios are covered in Part 2 test:

1. During a time-varying Tx power transmission: To prove that the Smart Transmit feature accounts for Tx power variations in time accurately.
2. During a call disconnect and re-establish scenario: To prove that the Smart Transmit feature accounts for history of past Tx power transmissions accurately.
3. During technology/band handover: To prove that the Smart Transmit feature functions correctly during transitions in technology/band.
4. During DSI (Device State Index) change: To prove that the Smart Transmit feature functions correctly during transition from one device state (DSI) to another.
5. During antenna (or beam) switch: To prove that the Smart Transmit feature functions correctly during transitions in antenna (such as AsDiv scenario) or beams (different antenna array configurations).
6. SAR vs. PD exposure switching during sub-6+mmW transmission: To prove that the Smart Transmit feature functions correctly and ensures total RF exposure compliance during transitions in SAR dominant exposure, SAR+PD exposure, and PD dominant exposure scenarios.
7. During time window switch: To prove that the Smart Transmit feature correctly handles the transition from one time window to another specified by FCC, and maintains the normalized time-averaged RF exposure to be less than normalized FCC limit of 1.0 at all times.
8. SAR exposure switching between two active radios (radio1 and radio2): To prove that the Smart Transmit feature functions correctly and ensures total RF exposure compliance when exposure varies among SAR_radio1 only, SAR_radio1 + SAR_radio2, and SAR_radio2 only scenarios.

As described in Part 0 report, the RF exposure is proportional to the Tx power for a SAR- and PD- characterized wireless device. Thus, feature validation in Part 2 can be effectively performed through conducted (for $f < 6\text{GHz}$) and radiated (for $f \geq 6\text{GHz}$) power measurement. Therefore, the compliance demonstration under dynamic transmission conditions and feature validation are done in conducted/radiated power measurement setup for transmission scenario 1 through 8.

■ Test case reduction for multiple filings

Per Qualcomm Document(80-W2112-5 Rev. YA ,Sec 4.2.2 , For Multiple variants which uses the same chipset. -the same chipset and Smart Transmit algorithm are used in the new model- the number of test cases in Part 2 can be reduced in the case of multiple filings using same chipset (post full part 2 test on the first filing), i.e., the essential test cases in power measurement are required to ensure the Smart Transmit performs as expected in the new design, but the RF exposure measurement can be excluded.

Furthermore, as described in Section 5.2.1 of 80-W2112-5 Rev. YA, for scenario (a), two bands per technology are selected for time-varying Tx transmission test to provide high confidence. In this case, one band per technology can be considered as well to reduce test cases further

The strategy for testing in Tx varying transmission condition is outlined as follows:

Demonstrate the total RF exposure averaged over FCC defined time windows does not exceed FCC’s SAR and PD limits, through time-averaged power measurements

Measure conducted Tx power (for $f < 6\text{GHz}$) versus time, and radiated Tx power (EIRP for $f > 10\text{GHz}$) versus time.

Convert it into RF exposure and divide by respective FCC limits to get normalized exposure versus time.

Perform running time-averaging over FCC defined time windows.

Demonstrate that the total normalized time-averaged RF exposure is less than 1 for all transmission scenarios (i.e., transmission scenarios 1, 2, 3, 4, 5, 6, 7, and 8) at all times.

Mathematical expression:

– For sub-6 transmissions only:

$$1g_or_10gSAR(t) = \frac{conducted_Tx_power(t)}{conducted_Tx_power_Plimit} * 1g_or_10gSAR_Plimit \quad (1a)$$

$$\frac{\frac{1}{TSAR} \int_{t-TSAR}^t 1g_or_10gSAR(\tau) d\tau}{FCC\ SAR\ limit} \leq 1 \quad (1b)$$

– For sub-6+mmW transmission:

$$1g_or_10gSAR(t) = \frac{conducted_Tx_power(t)}{conducted_Tx_power_Plimit} * 1g_or_10gSAR_Plimit \quad (2a)$$

$$4cm^2PD(t) = \frac{radiated_Tx_power(t)}{radiated_Tx_power_input_power_limit} * 4cm^2PD_input_power_limit \quad (2b)$$

$$\frac{\frac{1}{TSAR} \int_{t-TSAR}^t 1g_or_10gSAR(\tau) d\tau}{FCC\ SAR\ limit} + \frac{\frac{1}{TPD} \int_{t-TPD}^t 4cm^2PD(\tau) d\tau}{FCC\ 4cm^2\ PD\ limit} \leq 1 \quad (2c)$$

where, $conducted_Tx_power(t)$, $conducted_Tx_power_Plimit$, and $1g_or_10gSAR_Plimit$ correspond to the measured instantaneous conducted Tx power, measured conducted Tx power at Plimit, and measured 1gSAR or 10gSAR values at Plimit corresponding to sub-6 transmission. Similarly, $radiated_Tx_power(t)$, $radiated_Tx_power_input_power_limit$, and $4cm^2PD_input_power_limit$ correspond to the measured instantaneous radiated Tx power, radiated Tx power at input.power.limit (i.e., radiated power limit), and 4cm2PD value at input.power.limit corresponding to mmW transmission. Both Plimit and input.power.limit are the parameters pre-defined in Part 0 and loaded via Embedded File System (EFS) onto the EUT. TSAR is the FCC defined time window for sub-6 radio; TPD is the FCC defined time window for mmW radio.

Demonstrate the total RF exposure averaged over FCC defined time windows does not exceed FCC’s SAR and PD limits, through time-averaged SAR and PD measurements. Note as mentioned earlier, this measurement is performed for transmission scenario 1 only.

For sub-6 transmission only, measure instantaneous SAR versus time; for LTE+sub6 NR transmission, request low power (or all-down bits) on LTE so that measured SAR predominantly corresponds to sub6 NR.

For LTE + mmW transmission, measure instantaneous E-field versus time for mmW radio and instantaneous conducted power versus time for LTE radio.

Convert it into RF exposure and divide by respective FCC limits to obtain normalized exposure versus time. Perform time averaging over FCC defined time window.

Demonstrate that the total normalized time-averaged RF exposure is less than 1 for transmission scenario 1 at all times.

Mathematical expression:

- For sub-6 transmission only:

$$1g_or_10gSAR(t) = \frac{pointSAR(t)}{pointSAR_Plimit} * 1g_or_10gSAR(t)_Plimit \quad (3a)$$

$$\frac{\frac{1}{T_{SAR}} \int_{t-T_{SAR}}^t 1g_or_10gSAR(t) dt}{FCC\ SAR\ limit} \leq 1 \quad (3b)$$

- For LTE+mmW transmission:

$$1g_or_10gSAR(t) = \frac{conducted_Tx_power(t)}{conducted_Tx_power_Plimit} * 1g_or_10gSAR_Plimit \quad (4a)$$

$$4cm^2PD(t) = \frac{[pointE(t)]^2}{[pointE_input.power.limit]^2} * 4cm^2PD_input.power.limit \quad (4b)$$

$$\frac{\frac{1}{T_{SAR}} \int_{t-T_{SAR}}^t 1g_or_10gSAR(t) dt}{FCC\ SAR\ limit} + \frac{\frac{1}{T_{PD}} \int_{t-T_{PD}}^t 4cm^2PD(t) dt}{FCC\ 4cm^2PD\ limit} \leq 1 \quad (4c)$$

where, pointSAR(t), PointSAR_Plimit and 1g_or_10gSAR_Plimit correspond to the measured instantaneous point SAR, measured.

point SAR at Plimit, and measured 1gSAR or 10gSAR values at Plimit corresponding to sub-6 transmission.

Similarly, pointE(t), pointE_input.power.limit and 4cm²PD_input.power.limit correspond to the measured instantaneous E-field, E-field at input.power.limit, and 4cm²PD value at input.power.limit corresponding to mmW transmission.

Note: cDASY6 measurement system by Schmid & Partner Engineering AG (SPEAG) of Zurich, Switzerland measures relative E-field, and provides ratio of [pointE(t)]²/[pointE_input.power.limit]² versus time

5. SAR Time Averaging Validation Test Procedures

This chapter provides the test plan and test procedure for validating Qualcomm Smart Transmit feature for sub-6 transmission. The 100 seconds time window for operating $f < 3\text{GHz}$ is used as an example to detail the test procedures in this chapter. The same test plan and test procedures described in this chapter apply to 60 seconds time window for operating $f \geq 3\text{GHz}$.

5.1 Test sequence determination for validation

Following the FCC recommendation, two test sequences having time-variation in Tx power are predefined for sub-6 ($f < 6\text{GHz}$) validation:

Test sequence 1: request EUT's Tx power to be at maximum power, measured P_{max}^\dagger , for 80s, then requesting for half of the maximum power, i.e., measured $P_{max}/2$, for the rest of the time.

Test sequence 2: request EUT's Tx power to vary with time. This sequence is generated relative to measured P_{max} , measured P_{limit} and calculated $P_{reserve}$ (= measured P_{limit} in dBm - $total_min_resrve$ in dB) of EUT based on measured P_{limit} .

The details for generating these two test sequences is described and listed in Appendix A.

NOTE: For test sequence generation, "measured P_{limit} " and "measured P_{max} " are used instead of the " P_{limit} " specified in EFS entry and " P_{max} " specified for the device, because Smart Transmit feature operates against the actual power level of the " P_{limit} " that was calibrated for the EUT. The "measured P_{limit} " accurately reflects what the feature is referencing to, therefore, it should be used during feature validation testing. The RF tune up and device- to-device variation are already considered in Part 0 report prior to determining P_{limit} .

5.2 Test configuration selection criteria for validating Smart Transmit feature

For validating Smart Transmit feature, this section provides a general guidance to select test cases. In practice, an adjustment can be made in test case selection. The justification/clarification may be provided.

5.2.1 Test configuration selection for time-varying Tx power transmission

The Smart Transmit time averaging feature operation is independent of bands, modes, and channels for a given technology. Hence, validation of Smart Transmit in one band/mode/channel per technology is sufficient. Two bands per technology are proposed and selected for this testing to provide high confidence in this validation.

The criteria for the selection are based on the P_{limit} values determined in Part 0 report. Select two bands* in each supported technology that correspond to least** and highest*** P_{limit} values that are less than P_{max} for validating Smart Transmit.

* If one P_{limit} level applies to all the bands within a technology, then only one band needs to be tested. In this case, within the bands having the same P_{limit} , the radio configuration (e.g., # of RBs, channel#) and device position that correspond to the highest measured 1gSAR at P_{limit} shown in Part 1 report is selected.

** In case of multiple bands having the same least P_{limit} within the technology, then select the band having the highest measured 1gSAR at P_{limit} .

*** The band having a higher P_{limit} needs to be properly selected so that the power limiting enforced by Smart Transmit can be validated using the pre-defined test sequences. If the highest P_{limit} in a technology is too high where the power limiting enforcement is not needed when testing with the pre-defined test sequences, then the next highest level is checked. This process is continued within the technology until the second band for validation testing is determined.

5.2.2 Test configuration selection for change in call

The criteria to select a test configuration for call-drop measurement is:

Select technology/band with least P_{limit} among all supported technologies/bands, and select the radio configuration (e.g., # of RBs, channel#) in this technology/band that corresponds to the highest *measured* 1gSAR at P_{limit} listed in Part 1 report.

In case of multiple bands having same least P_{limit} , then select the band having the highest *measured* 1gSAR at P_{limit} in Part 1 report.

This test is performed with the EUT's Tx power requested to be at maximum power, the above band selection will result in Tx power enforcement (i.e., EUT forced to have Tx power at $P_{reserve}$) for longest duration in one FCC defined time window. The call change (call drop/reestablish) is performed during the Tx power enforcement duration (i.e., during the time when EUT is forced to have Tx power at $P_{reserve}$). One test is sufficient as the feature operation is independent of technology and band.

5.2.3 Test configuration selection for change in technology/band

The selection criteria for this measurement is, for a given antenna, to have EUT switch from a technology/band with lowest P_{limit} within the technology group (in case of multiple bands having the same P_{limit} , then select the band with highest *measured* 1gSAR at P_{limit}) to a technology/band with highest P_{limit} within the technology group, in case of multiple bands having the same P_{limit} , then select the band with lowest *measured* 1gSAR at P_{limit} in Part 1 report, or vice versa.

This test is performed with the EUT's Tx power requested to be at maximum power, the technology/band switch is performed during Tx power enforcement duration (i.e., during the time when EUT is forced to have Tx power at $P_{reserve}$).

5.2.4 Test configuration selection for change in antenna

The criteria to select a test configuration for antenna switch measurement is:

Whenever possible and supported by the EUT, first select antenna switch configuration within the same technology/band (i.e., same technology and band combination).

Then, select any technology/band that supports multiple Tx antennas, and has the highest difference in P_{limit} among all supported antennas.

In case of multiple bands having same difference in P_{limit} among supported antennas, then select the band having the highest *measured* 1gSAR at P_{limit} in Part 1 report.

This test is performed with the EUT's Tx power requested to be at maximum power in selected technology/band, and antenna change is conducted during Tx power enforcement duration (i.e., during the time when EUT is forced to have Tx power at $P_{reserve}$).

5.2.5 Test configuration selection for change in DSI

The criteria to select a test configuration for DSI change test is

Select a technology/band having the $P_{limit} < P_{max}$ within any technology and DSI group, and for the same technology/band having a different P_{limit} in any other DSI group. Note that the selected DSI transition need to be supported by the device.

This test is performed with the EUT's Tx power requested to be at maximum power in selected technology/band, and DSI change is conducted during Tx power enforcement duration (i.e., during the time when EUT is forced to have Tx power at $P_{reserve}$).

5.2.6 Test configuration selection for change in time window

FCC specifies different time window for time averaging based on operation frequency. The criteria to select a test configuration for validating Smart Transmit feature and demonstrating the compliance during the change in time window is

Select any technology/band that has operation frequency classified in one time window defined by FCC (such as 100-seconds time window), and its corresponding P_{limit} is less than P_{max} if possible.

Select the 2nd technology/band that has operation frequency classified in a different time window defined by FCC (such as 60-seconds time window), and its corresponding P_{limit} is less than P_{max} if possible.

Note it is preferred both P_{limit} values of two selected technology/band less than corresponding P_{max} , but if not possible, at least one of technologies/bands has its P_{limit} less than P_{max} .

This test is performed with the EUT's Tx power requested to be at maximum power in selected technology/band. Test for one pair of time windows selected is sufficient as the feature operation is the same.

5.2.7 Test configuration selection for SAR exposure switching

If supported, the test configuration for SAR exposure switching should cover

1. SAR exposure switch when two active radios are in the same time window
2. SAR exposure switch when two active radios are in different time windows. One test with two active radios in any two different time windows is sufficient as Smart Transmit operation is the same for RF exposure switch in any combination of two different time windows. For device supporting LTE + mmW NR, this test is covered in Section 6.3.2 and 6.3.3.

The Smart Transmit time averaging operation is independent of the source of SAR exposure (for example, LTE vs. Sub6 NR) and ensures total time-averaged RF exposure compliance. Hence, validation of Smart Transmit in any one simultaneous SAR transmission scenario (i.e., one combination for LTE + Sub6 NR transmission) is sufficient, where the SAR exposure varies among SARradio1 only, SARradio1 + SARradio2, and SARradio2 only scenarios.

The criteria to select a test configuration for validating Smart Transmit feature during SAR exposure switching scenarios is

- Select any two < 6GHz technologies/bands that the EUT supports simultaneous transmission (for example, LTE+Sub6 NR).
- Among all supported simultaneous transmission configurations, the selection order is select one configuration where both P_{limit} of radio1 and radio2 is less than their corresponding P_{max} , preferably, with different P_{limits} . If this configuration is not available, then, select one configuration that has P_{limit} less than its P_{max} for at least one radio. If this can not be found, then, select one configuration that has P_{limit} of radio1 and radio2 greater than P_{max} but with least ($P_{limit} - P_{max}$) delta.

Test for one simultaneous transmission scenario is sufficient as the feature operation is the same.

5.3 Test procedures for conducted power measurements

This section provides general conducted power measurement procedures to perform compliance test under dynamic transmission scenarios described in Section 4. In practice, an adjustment can be made in these procedures. The justification/clarification may be provided.

5.3.1 Time-varying Tx power transmission scenario

This test is performed with the two pre-defined test sequences described in Section 5.1 for all the technologies and bands selected in Section 5.2.1. The purpose of the test is to demonstrate the effectiveness of power limiting enforcement and that the time-averaged SAR (corresponding time-averaged Tx power) does not exceed the FCC limit at all times (see Eq. (1a) and (1b)).

Test procedure

1. Measure P_{max} , measure P_{limit} and calculate $Reserve (= \text{measured } P_{limit} \text{ in dBm} - Reserve_power_margin \text{ in dB})$ and follow Section 5.1 to generate the test sequences for all the technologies and bands selected in Section 5.2.1. Both test sequence 1 and test sequence 2 are created based on measured P_{max} and measured P_{limit} of the EUT. Test condition to measure P_{max} and P_{limit} is:

- Measure P_{max} with Smart Transmit disabled and callbox set to request maximum power.
- Measure P_{limit} with Smart Transmit enabled and $Reserve_power_margin$ set to 0 dB, callbox set to request maximum power.

2. Set $Reserve_power_margin$ to actual (intended) value (3dB for this EUT based on Part 1 report) and reset power on EUT to enable Smart Transmit, establish radio link in desired radio configuration, with callbox requesting the EUT's Tx power to be at pre-defined test sequence 1, measure and record Tx power versus time, and then convert the conducted Tx power into 1gSAR or 10gSAR value (see Eq. (1a)) using measured P_{limit} from above Step 1. Perform running time average to determine time-averaged power and 1gSAR or 10gSAR versus time as illustrated in Figure 5-1 where using 100-seconds time window as an example.

NOTE: In Eq.(1a), instantaneous Tx power is converted into instantaneous 1gSAR or 10gSAR value by applying the measured worst-case 1gSAR or 10gSAR value at P_{limit} for the corresponding technology/band/antenna/DSI reported in Part 1 report.

NOTE: For an easier computation of the running time average, 0 dBm can be added at the beginning of the test sequences the length of the responding time window, for example, add 0dBm for 100-seconds so the running time average can be directly performed starting with the first 100-seconds data using excel spreadsheet. This technique applies to all tests performed in this Part 2 report for easier time-averaged computation using excel spreadsheet.

Figure 5-1 100s running average illustration

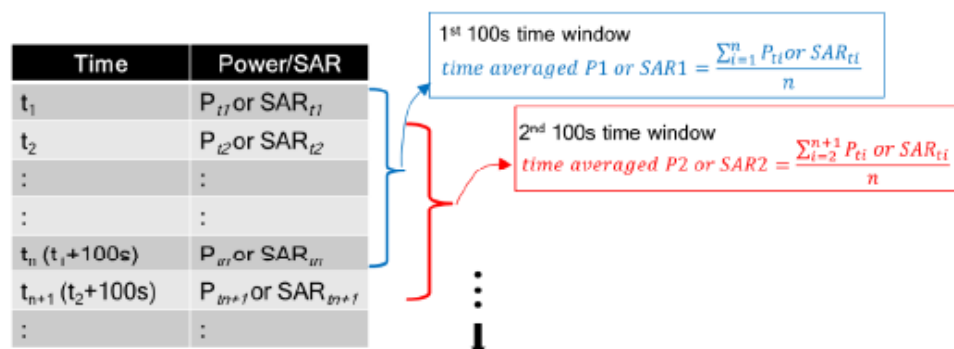

3. Make one plot containing:

- a. Instantaneous Tx power versus time measured in Step 2,
- b. Requested Tx power used in Step 2 (test sequence 1),
- c. Computed time-averaged power versus time determined in Step 2,
- d. Time-averaged power limit (corresponding to FCC SAR limit of 1.6 W/kg for 1gSAR or 4.0W/kg for 10gSAR) given by

$$\text{Time averaged power limit} = \text{meas. } P_{\text{limit}} + 10 \times \log\left(\frac{\text{FCC SAR limit}}{\text{meas.SAR_P}_{\text{limit}}}\right) \quad (5a)$$

where *meas. P_{limit}* and *meas. SAR_P_{limit}* correspond to measured power at *P_{limit}* and measured SAR at *P_{limit}*.

4. Make another plot containing:

- a. Computed time-averaged 1gSAR or 10gSAR versus time determined in Step 2
 - b. FCC *1gSAR_{limit}* of 1.6W/kg or FCC *10gSAR_{limit}* of 4.0W/kg.
5. Repeat Steps 2 ~ 4 for pre-defined test sequence 2 and replace the requested Tx power (test sequence 1) in Step 2 with test sequence 2.
6. Repeat Steps 2 ~ 5 for all the selected technologies and bands.

The validation criteria are, at all times, the time-averaged power versus time shown in Step 3 plot shall not exceed the time-averaged power limit (defined in Eq. (5a)), in turn, the time-averaged 1gSAR or 10gSAR versus time shown in Step 4 plot shall not exceed the FCC limit of 1.6 W/kg for 1gSAR or 4.0 W/kg for 10gSAR (i.e., Eq. (1b)).

5.3.2 Change in call scenario

This test is to demonstrate that Smart Transmit feature accurately accounts for the past Tx powers during time-averaging when a new call is established.

The call disconnect and re-establishment needs to be performed during power limit enforcement, i.e., when the EUT's Tx power is at *P_{reserve}* level, to demonstrate the continuity of RF exposure management and limiting in call change scenario. In other words, the RF exposure averaged over any FCC defined time window (including the time windows containing the call change) doesn't exceed FCC limit of 1.6 W/kg for 1gSAR or 4.0 W/kg for 10gSAR.

Test procedure

1. Measure *P_{limit}* for the technology/band selected in Section 5.2.2. Measure *P_{limit}* with Smart Transmit enabled and *Reserve_power_margin* set to 0 dB, callbox set to request maximum power.
2. Set *Reserve_power_margin* to actual (intended) value and reset power on EUT to enable Smart Transmit.
3. Establish radio link with callbox in the selected technology/band.
4. Request EUT's Tx power at 0 dBm for at least one time window specified for the selected technology/band, followed by requesting EUT's Tx power to be at maximum power for about ~60 seconds, and then drop the call for ~10 seconds. Afterwards, re-establish another call in the same radio configuration (i.e., same technology/band/channel) and continue callbox requesting EUT's Tx power to be at maximum power for the remaining time of at least another full duration of the specified time window. Measure and record Tx power versus time. Once the measurement is done, extract instantaneous Tx power versus time, convert the measured conducted Tx power into 1gSAR or 10gSAR value using Eq. (1a), and then perform the running time average to determine time-averaged power and 1gSAR or 10gSAR versus time.

NOTE: In Eq.(1a), instantaneous Tx power is converted into instantaneous 1gSAR or 10gSAR value by applying the measured worst-case 1gSAR or 10gSAR value at *Plimit* for the corresponding technology/band/antenna/DSI reported in Part 1 report.

5. Make one plot containing: (a) instantaneous Tx power versus time, (b) requested power, (c) computed time-averaged power, (d) time-averaged power limit calculated using Eq.(5a).
6. Make another plot containing: (a) computed time-averaged 1gSAR or 10gSAR versus time, and (b) FCC limit of 1.6 W/kg for 1gSAR or 4.0 W/kg for 10gSAR.

The validation criteria are, at all times, the time-averaged power versus time shall not exceed the time-averaged power limit (defined in Eq.(5a)), in turn, the time-averaged 1gSAR or 10gSAR versus time shall not exceed the FCC limit of 1.6 W/kg for 1gSAR or 4.0 W/kg for 10gSAR (i.e., Eq. (1b)).

5.3.3. Change in technology and band

This test is to demonstrate the correct power control by Smart Transmit during technology switches and/or band handovers.

Similar to the change in call test in Section 5.3.2, to validate the continuity of RF exposure limiting during the transition, the technology and band handover needs to be performed when EUT's Tx power is at *Preserve* level (i.e., during Tx power enforcement) to make sure that the EUT's Tx power from previous *Preserve* level to the new *Preserve* level (corresponding to new technology/band). Since the *Plimit* could vary with technology and band, Eq. (1a) can be written as follows to convert the instantaneous Tx power in 1gSAR or 10gSAR exposure for the two given radios, respectively:

$$1g_or_10gSAR_1(t) = \frac{conducted_Tx_power_1(t)}{conducted_Tx_power_Plimit_1} * 1g_or_10gSAR_Plimit_1 \quad (6a)$$

$$1g_or_10gSAR_2(t) = \frac{conducted_Tx_power_2(t)}{conducted_Tx_power_Plimit_2} * 1g_or_10gSAR_Plimit_2 \quad (6b)$$

$$\frac{1}{T_{SAR}} \left[\int_{t-T_{SAR}}^{t_1} \frac{1g_or_10gSAR_1(t)}{FCC\ SAR\ limit} dt + \int_{t-T_{SAR}}^t \frac{1g_or_10gSAR_2(t)}{FCC\ SAR\ limit} dt \right] \leq 1 \quad (6c)$$

where, *conducted_Tx_power_1(t)*, *conducted_Tx_power_Plimit_1*, and *1g_or_10gSAR_Plimit_1* correspond to the measured instantaneous conducted Tx power, measured conducted Tx power at *Plimit*, and measured 1gSAR or 10gSAR value at *Plimit* of technology1/band1; *conducted_Tx_power_2(t)*, *conducted_Tx_power_Plimit_2(t)*, and *1g_or_10gSAR_Plimit_2* correspond to the measured instantaneous conducted Tx power, measured conducted Tx power at *Plimit*, and measured 1gSAR or 10gSAR value at *Plimit* of technology2/band2. Transition from technology1/band1 to the technology2/band2 happens at time-instant 't1'.

Test procedure

1. Measure P_{limit} for both the technologies and bands selected in Section 5.2.3. Measure P_{limit} with Smart Transmit enabled and $Reserve_power_margin$ set to 0 dB, callbox set to request maximum power.
2. Set $Reserve_power_margin$ to actual (intended) value and reset power on EUT to enable Smart Transmit
3. Establish radio link with callbox in first technology/band selected.
4. Request EUT's Tx power at 0 dBm for at least one time window specified for the selected technology/band, followed by requesting EUT's Tx power to be at maximum power for about ~60 seconds, and then switch to second technology/band selected. Continue with callbox requesting EUT's Tx power to be at maximum power for the remaining time of at least another full duration of the specified time window. Measure and record Tx power versus time for the full duration of the test.
5. Once the measurement is done, extract instantaneous Tx power versus time, and convert the conducted Tx power into 1gSAR or 10gSAR value using Eq. (6a) and (6b) and corresponding measured P_{limit} values from Step 1 of this section. Perform the running time average to determine time-averaged power and 1gSAR or 10gSAR versus time.

NOTE: In Eq.(6a) & (6b), instantaneous Tx power is converted into instantaneous 1gSAR or 10gSAR value by applying the measured worst-case 1gSAR or 10gSAR value at P_{limit} for the corresponding technology/band/antenna/DSI reported in Part 1 report.

6. Make one plot containing: (a) instantaneous Tx power versus time, (b) requested power, (c) computed time-averaged power, (d) time-averaged power limit calculated using Eq.(5a).
7. Make another plot containing: (a) computed time-averaged 1gSAR or 10gSAR versus time, and (b) FCC limit of 1.6 W/kg for 1gSAR or 4.0 W/kg for 10gSAR.

The validation criteria are, at all times, the time-averaged 1gSAR or 10gSAR versus time shall not exceed the FCC limit of 1.6 W/kg for 1gSAR or 4.0 W/kg for 10gSAR (i.e., Eq. (6c)).

5.3.4 Change in antenna

This test is to demonstrate the correct power control by Smart Transmit during antenna switches from one antenna to another. The test procedure is identical to Section 5.3.3, by replacing technology/band switch operation with antenna switch. The validation criteria are, at all times, the time-averaged 1gSAR or 10gSAR versus time shall not exceed FCC limit of 1.6 W/kg for 1gSAR or 4.0 W/kg for 10gSAR.

5.3.5 Change in DSI

This test is to demonstrate the correct power control by Smart Transmit during DSI switches from one DSI to another. The test procedure is identical to Section 5.3.3, by replacing technology/band switch operation with DSI switch. The validation criteria are, at all times, the time-averaged 1gSAR or 10gSAR versus time shall not exceed FCC limit of 1.6 W/kg for 1gSAR or 4.0 W/kg for 10gSAR.

5.3.6 Change in time window

This test is to demonstrate the correct power control by Smart Transmit during the change in averaging time window when a specific band handover occurs. FCC specifies time-averaging windows of 100s for Tx frequency < 3GHz, and 60s for Tx frequency between 3GHz and 6GHz.

To validate the continuity of RF exposure limiting during the transition, the band handover test needs to be performed when EUT handovers from operation band less than 3GHz to greater than 3GHz and vice versa. The equations (3a) and (3b) in Section 4 can be written as follows for transmission scenario having change in time window,

$$1gSAR_1(t) = \frac{conducted_Tx_power_1(t)}{conducted_Tx_power_Plimit_1} * 1g_or_10g_SAR_Plimit_1 \quad (7a)$$

$$1gSAR_2(t) = \frac{conducted_Tx_power_2(t)}{conducted_Tx_power_Plimit_2} * 1g_or_10g_SAR_Plimit_2 \quad (7b)$$

$$\frac{1}{T1SAR} \left[\int_{t-T1SAR}^{t_1} \frac{1g_or_10g_SAR_1(t)}{FCC\ SAR\ limit} dt \right] + \frac{1}{T2SAR} \left[\int_{t-T2SAR}^t \frac{1g_or_10g_SAR_2(t)}{FCC\ SAR\ limit} dt \right] \leq 1 \quad (7c)$$

where, *conducted_Tx_power_1(t)*, *conducted_Tx_power_Plimit_1*, and *1g_or_10g_SAR_Plimit_1* correspond to the instantaneous Tx power, conducted Tx power at *Plimit*, and compliance *1g_or_10g_SAR* values at *Plimit_1* of band1 with time-averaging window 'T1SAR'; *conducted_Tx_power_2(t)*, *conducted_Tx_power_Plimit_2*, and *1g_or_10g_SAR_Plimit_2* correspond to the instantaneous Tx power, conducted Tx power at *Plimit*, and compliance *1g_or_10g_SAR* values at *Plimit_2* of band2 with time-averaging window 'T2SAR'. One of the two bands is less than 3GHz, another is greater than 3GHz. Transition from first band with time-averaging window 'T1SAR' to the second band with time-averaging window 'T2SAR' happens at time-instant 't1'.

Test procedure

1. Measure *Plimit* for both the technologies and bands selected in Section 5.2.6. Measure *Plimit* with Smart Transmit enabled and *Reserve_power_margin* set to 0 dB, callbox set to request maximum power.
2. Set *Reserve_power_margin* to actual (intended) value and enable Smart Transmit

Transition from 100s time window to 60s time window, and vice versa

3. Establish radio link with callbox in the technology/band having 100s time window selected in Section 5.2.6.
4. Request EUT's Tx power to be at 0 dBm for at least 100 seconds, followed by requesting EUT's Tx power to be at maximum power for about ~140 seconds, and then switch to second technology/band (having 60s time window) selected in Section 5.2.6. Continue with callbox requesting EUT's Tx power to be at maximum power for about ~60s in this second technology/band, and then switch back to the first technology/band. Continue with callbox requesting EUT's Tx power to be at maximum power for at least another 100s.

Measure and record Tx power versus time for the entire duration of the test.

5. Once the measurement is done, extract instantaneous Tx power versus time, and convert the conducted Tx power into 1gSAR or 10gSAR value (see Eq. (7a) and (7b)) using corresponding technology/band Step 1 result, and then perform 100s running average to determine time-averaged 1gSAR or 10gSAR versus time. Note that in Eq.(7a) & (7b), instantaneous Tx power is converted into instantaneous 1gSAR or 10gSAR value by applying the worst-case 1gSAR or 10gSAR value tested in Part 1 for the selected technologies/bands at P_{limit} .
6. Make one plot containing: (a) instantaneous Tx power versus time measured in Step 4.
7. Make another plot containing: (a) instantaneous 1gSAR versus time determined in Step 5, (b) computed time-averaged 1gSAR versus time determined in Step 5, and (c) corresponding regulatory $1gSAR_{limit}$ of 1.6W/kg or $10gSAR_{limit}$ of 4.0W/kg.

Transition from 60s time window to 100s time window, and vice versa

8. Establish radio link with callbox in the technology/band having 60s time window selected in Section 5.2.6.
9. Request EUT's Tx power to be at 0 dBm for at least 60 seconds, followed by requesting EUT's Tx power to be at maximum power for about ~80 seconds, and then switch to second technology/band (having 100s time window) selected in Section 5.2.6. Continue with callbox requesting EUT's Tx power to be at maximum power for about ~100s in this second technology/band, and then switch back to the first technology/band. Continue with callbox requesting EUT's Tx power to be at maximum power for the remaining time for a total test time of 500 seconds. Measure and record Tx power versus time for the entire duration of the test.
10. Repeat above Step 5~7 to generate the plots

The validation criteria is, at all times, the time-averaged 1gSAR or 10gSAR versus time shall not exceed the regulatory $1gSAR_{limit}$ of 1.6W/kg or $10gSAR_{limit}$ of 4.0W/kg.

5.3.7 SAR exposure switching

This test is to demonstrate that Smart Transmit feature accurately accounts for switching in exposures among SAR from radio1 only, SAR from both radio1 and radio2, and SAR from radio2 only scenarios, and ensures total time-averaged RF exposure complies with the FCC limit. The detailed test procedure for SAR exposure switching in the case of LTE+Sub6 NR non- standalone mode transmission scenario is provided in Appendix B.2.

Test procedure:

1. Measure conducted Tx power corresponding to P_{limit} for radio1 and radio2 in selected band. Test condition to measure conducted P_{limit} is:
 - Establish device in call with the callbox for radio1 technology/band. Measure conducted Tx power corresponding to radio1 P_{limit} with Smart Transmit enabled and *Reserve_power_margin* set to 0 dB, callbox set to request maximum power.
 - Repeat above step to measure conducted Tx power corresponding to radio2 P_{limit} . If radio2 is dependent on radio1 (for example, non-standalone mode of Sub6 NR requiring radio1 LTE as anchor), then establish radio1 + radio2 call with callbox, and request all down bits for radio1 LTE. In this scenario, with callbox requesting maximum power from radio2 Sub6 NR, measured conducted Tx power corresponds to radio2 P_{limit} (as radio1 LTE is at all-down bits)
2. Set *Reserve_power_margin* to actual (intended) value, with EUT setup for radio1 + radio2 call. In this description, it is assumed that radio2 has lower priority than radio1. Establish device in radio1+radio2 call, and request all-down bits or low power on radio1, with callbox requesting EUT's Tx power to be at maximum power in radio2 for at least one time window. After one time window, set callbox to request EUT's Tx power to be at maximum power on radio1, i.e., all-up bits. Continue radio1+radio2 call with both radios at maximum power for at least one time window, and drop (or request all-down bits on) radio2. Continue radio1 at maximum power for at least one time window. Record the conducted Tx power for both radio1 and radio2 for the entire duration of this test.
3. Once the measurement is done, extract instantaneous Tx power versus time for both radio1 and radio2 links. Convert the conducted Tx power for both these radios into 1gSAR or 10gSAR value (see Eq. (6a) and (6b)) using corresponding technology/band P_{limit} measured in Step 1, and then perform the running time average to determine time-averaged 1gSAR or 10gSAR versus time.
4. Make one plot containing: (a) instantaneous Tx power versus time measured in Step 2.
5. Make another plot containing: (a) instantaneous 1gSAR versus time determined in Step 3, (b) computed time-averaged 1gSAR versus time determined in Step 3, and (c) corresponding regulatory $1gSAR_{limit}$ of 1.6W/kg or $10gSAR_{limit}$ of 4.0W/kg.

The validation criteria is, at all times, the time-averaged 1gSAR or 10gSAR versus time shall not exceed the regulatory $1gSAR_{limit}$ of 1.6W/kg or $10gSAR_{limit}$ of 4.0W/kg.

NOTE: If multi_Tx_factor is set to > 1.0 with EFS version 19 (or higher), then in single Tx transmission scenarios, Smart Transmit ensures time-averaged RF exposure is $\leq (\text{SAR_design_target} * 10(+ \text{sub6 device uncertainty}/10)) < \text{regulatory RF exposure limit for sub6 radio managed by Smart Transmit}$. In simultaneous Tx transmission scenarios, Smart Transmit ensures time-averaged RF exposure is $\leq (\text{SAR_design_target} * \text{multi_Tx_factor} * 10(+ \text{sub6 device uncertainty}/10)) < \text{regulatory RF exposure limit for sub6 radios managed by Smart Transmit}$. These simultaneous transmission scenarios are listed below:

- 2-or-more radio scenarios within WWAN like EN-DC, LTE ULCA, ETC
- 2-or-more radio across technologies such as WWAN+WLAN, WWAM+BT,WLAN+BT and WWAN+WLAN+BT transmission scenarios (if WLAN/BT radios are also managed by Smart Transmit

5.4 Test procedure for time-varying SAR measurements

This section provides general time-varying SAR measurement procedures to perform compliance test under dynamic transmission scenarios described in Section 4. In practice, an adjustment can be made in these procedures. The justification/clarification may be provided.

To perform the validation through SAR measurement for transmission scenario 1 described in Section 4, the “path loss” between callbox antenna and EUT needs to be calibrated to ensure that the EUT Tx power reacts to the requested power from callbox in a radiated call. It should be noted that when signaling in closed loop mode, protocol-level power control is in play, resulting in EUT not solely following callbox TPC (Tx power control) commands. In other words, EUT response has many dependencies (RSSI, quality of signal, path loss variation, fading, etc..) other than just TPC commands. These dependencies have less impact in conducted setup (as it is a controlled environment and the path loss can be very well calibrated) but have significant impact on radiated testing in an uncontrolled environment, such as SAR test setup. Therefore, the deviation in EUT Tx power from callbox requested power is expected, however the time- averaged SAR should not exceed FCC SAR requirement at all times as Smart Transmit controls Tx power at EUT.

The following steps are for time averaging feature validation through SAR measurement:

1. “Path Loss” calibration: Place the EUT against the phantom in the worst-case position determined based on Section 5.2.1. For each band selected, prior to SAR measurement, perform “path loss” calibration between callbox antenna and EUT. Since the SAR test environment is not controlled and well calibrated for OTA (Over the Air) test, extreme care needs to be taken to avoid the influence from reflections. The test setup is described in Section 7.1.
2. Time averaging feature validation:
 - i For a given radio configuration (technology/band) selected in Section 5.2.1, enable Smart Transmit and set *Reserve_power_margin* to 0 dB, with callbox to request maximum power, perform area scan, conduct pointSAR measurement at peak location of the area scan. This point SAR value, *pointSAR_Plimit*, corresponds to point SAR at the measured *Plimit* (i.e., measured *Plimit* from the EUT in Step 1 of Section 5.3.1).
 - ii Set *Reserve_power_margin* to actual (intended) value and reset power on EUT to enable Smart Transmit. Note, if *Reserve_power_margin* cannot be set wirelessly, care must be taken to re-position the EUT in the exact same position relative to the SAM phantom as in above Step 2.i. Establish radio link in desired radio configuration, with callbox requesting the EUT’s Tx power at power levels described by test sequence 1 generated in Step 1 of Section 5.3.1, conduct point SAR measurement versus time at peak location of the area scan determined in Step 2.i of this section. Once the measurement is done, extract instantaneous point SAR vs time data, *pointSAR(t)*, and convert it into instantaneous 1gSAR or 10gSAR vs. time using Eq. (3a), re-written below:

$$1g_or_10gSAR(t) = \frac{pointSAR(t)}{pointSAR_Plimit} * 1g_or_10gSAR_Plimit$$

where, pointSAR_Plimit is the value determined in Step 2.i, and $\text{pointSAR}(t)$ is the instantaneous point SAR measured in Step 2.

ii, $\text{1g-or10gSAR_Plimit}$ is the measured 1gSAR or 10gSAR value listed in Part 1 report.

iii. Perform 100s running average to determine time-averaged 1gSAR or 10gSAR versus time.

iv. Make one plot containing: (a) time-averaged 1gSAR or 10gSAR versus time determined in Step 2.iii of this section, (b) FCC limit of 1.6 W/kg for 1gSAR or 4.0 W/kg for 10gSAR.

v Repeat 2.ii ~ 2.iv for test sequence 2 generated in Step 1 of Section 5.3.1.

vi. Repeat 2.i ~ 2.v for all the technologies and bands selected in Section 5.2.1.

The time-averaging validation criteria for SAR measurement is that, at all times, the time- averaged 1gSAR or 10gSAR versus time shall not exceed FCC limit of 1.6 W/kg for 1gSAR or 4.0 W/kg for 10gSAR (i.e., Eq. (3b)).

6. PD Time Averaging Validation Test Procedures

This chapter provides the test plan and test procedures for validating Qualcomm Smart Transmit feature for mmW transmission. For this EUT, millimeter wave (mmW) transmission is only in non-standalone mode, i.e., it requires an LTE link as anchor.

6.1 Test sequence for validation in mmW NR transmission

In 5G mmW NR transmission, the test sequence for validation is with the callbox requesting EUT's Tx power in 5G mmW NR at maximum power all the time.

6.2 Test configuration selection criteria for validating Smart Transmit feature

6.2.1 Test configuration selection for time-varying Tx power transmission

The Smart Transmit time averaging feature operation is independent of bands, modes, channels, and antenna configurations (beams) for a given technology. Hence, validation of Smart Transmit in any one band/mode/channel per technology is sufficient.

6.2.2 Test configuration selection for change in antenna configuration (beam)

The Smart Transmit time averaging feature operation is independent of bands, modes, channels, and antenna configurations (beams) for a given technology. Hence, validation of Smart Transmit with beam switch between any two beams is sufficient.

6.2.3 Test configuration selection for SAR vs. PD exposure switch during transmission

The Smart Transmit time averaging feature operation is independent of the nature of exposure (SAR vs. PD) and ensures total time-averaged RF exposure compliance. Hence, validation of Smart Transmit in any one band/mode/channel/beam for mmW + sub-6 (LTE) transmission is sufficient, where the exposure varies among SAR dominant scenario, SAR+PD scenario, and PD dominant scenario.

6.3 Test procedures for mmW radiated power measurements

Perform conducted power measurement (for $f < 6\text{GHz}$) and radiated power measurement (for $f > 6\text{GHz}$) for LTE + mmW transmission to validate Smart Transmit time averaging feature in the various transmission scenarios described in Section 4.

This section provides general conducted power measurement procedures to perform compliance test under dynamic transmission scenarios described in Section 4. In practice, an adjustment can be made in these procedures. The justification/clarification may be provided.

6.3.1 Time-varying Tx power scenario

The purpose of the test is to demonstrate the effectiveness of power limiting enforcement and that the time-averaged Tx power when converted into RF exposure values does not exceed the FCC limit at all times (see Eq. (2a), (2b) & (2c) in Section 4).

Test procedure:

1. Measure conducted Tx power corresponding to P_{limit} for LTE in selected band, and measure radiated Tx power corresponding to *input.power.limit* in desired mmW band/channel/beam by following below steps:
 - Measure radiated power corresponding to mmW *input.power.limit* by setting up the EUT's Tx power in desired band/channel/beam at *input.power.limit* in Factory Test Mode (FTM). This test is performed in a calibrated anechoic chamber. Rotate the EUT to obtain maximum radiated Tx power, keep the EUT in this position and do not disturb the position of the EUT inside the anechoic chamber for the rest of this test.
 - Reset EUT to place in online mode and establish radio link in LTE, measure conducted Tx power corresponding to LTE P_{limit} with Smart Transmit enabled and *Reserve_power_margin* set to 0 dB, callbox set to request maximum power.
2. Set *Reserve_power_margin* to actual (intended) value and reset power on EUT to enable Smart Transmit. With EUT setup for a mmW NR call in the desired/selected LTE band and mmW NR band, perform the following steps:
 - Establish LTE and mmW NR connection in desired band/channel/beam used in Step 1. As soon as the mmW connection is established, immediately request all-down bits on LTE link. With callbox requesting EUT's Tx power to be at maximum mmW power to test predominantly PD exposure scenario (as SAR exposure is less when LTE's Tx power is at low power).
 - After 120s, request LTE to go all-up bits for at least 100s. SAR exposure is dominant. There are two scenarios:

If $P_{limit} < P_{max}$ for LTE, then the RF exposure margin (provided to mmW NR) gradually runs out (due to high SAR exposure). This results in gradual reduction in the 5G mmW NR transmission power and eventually seized 5G mmW NR transmission when LTE goes to *Preserve* level.

If $P_{limit} \geq P_{max}$ for LTE, then the 5G mmW NR transmission's averaged power should gradually reduce but the mmW NR connection can sustain all the time (assuming TxAGC uncertainty = 0dB).
 - Record the conducted Tx power of LTE and radiated Tx power of mmW for the full duration of this test of at least 300s.
3. Once the measurement is done, extract instantaneous Tx power versus time for both LTE and mmW links. Convert the conducted Tx power for LTE into 1gSAR or 10gSAR value using Eq. (2a) and P_{limit} measured in Step 1.b, and then divide by FCC limit of 1.6 W/kg for 1gSAR or 4.0 W/kg for 10gSAR to obtain instantaneous normalized 1gSAR or 10gSAR versus time. Perform 100s running average to determine normalized 100s-averaged 1gSAR or 10gSAR versus time.

NOTE: In Eq.(2a), instantaneous Tx power is converted into instantaneous 1gSAR or 10gSAR value by applying the measured worst-case 1gSAR or 10gSAR value at P_{limit} for the corresponding technology/band/antenna/DSI reported in Part 1 report.

4. Similarly, convert the radiated Tx power for mmW into $4\text{cm}^2\text{PD}$ value using Eq. (2b) and the radiated Tx power limit (i.e., radiated Tx power at *input.power.limit*) measured in Step 1.a, then divide by FCC $4\text{cm}^2\text{PD}$ limit of $10\text{W}/\text{m}^2$ to obtain instantaneous normalized $4\text{cm}^2\text{PD}$ versus time. Perform 4s running average to determine normalized 4s-averaged $4\text{cm}^2\text{PD}$ versus time.

NOTE: In Eq.(2b), instantaneous radiated Tx power is converted into instantaneous $4\text{cm}^2\text{PD}$ by applying the worst-case $4\text{cm}^2\text{PD}$ value measured at *input.power.limit* for the selected band/beam in Part 1 report.

5. Make one plot containing: (a) instantaneous conducted Tx power for LTE versus time, (b) computed 100s-averaged conducted Tx power for LTE versus time, (c) instantaneous radiated Tx power for mmW versus time, as measured in Step 2, (d) computed 4s-averaged radiated Tx power for mmW versus time, and (e) time-averaged conducted and radiated power limits for LTE and mmW radio using Eq. (5a) & (5b), respectively:

$$\text{Time avearged LTE power limit} = \text{meas. } P_{\text{limit}} + 10 \times \log\left(\frac{\text{FCC SAR limit}}{\text{meas.SAR_Plimit}}\right) \quad (5a)$$

$$\text{Time avearged mmW NR power limit} = \text{meas. } EIRP_{\text{input.power.limit}} + 10 \times \log\left(\frac{\text{FCC PD limit}}{\text{meas.PD_input.power.limit}}\right) \quad (5b)$$

where *meas. EIRP_{input.power.limit}* and *meas. PD_{input.power.limit}* correspond to measured EIRP at *input.power.limit* and measured power density at *input.power.limit*.

6. Make another plot containing: (a) computed normalized 100s-averaged 1gSAR or 10gSAR versus time determined in Step 3, (b) computed normalized 4s-averaged 4cm²PD versus time determined in Step 4, and (c) corresponding total normalized time-averaged RF exposure (sum of steps (6.a) and (6.b)) versus time.

The validation criteria are, at all times, the total normalized time-averaged RF exposure versus time determined in Step 6.c shall not exceed the normalized limit of 1.0 of FCC requirement (i.e., Eq. (2c)).

6.3.2 Switch in SAR vs. PD exposure during transmission

This test is to demonstrate that Smart Transmit feature is independent of the nature of exposure (SAR vs. PD), accurately accounts for switching in exposures among SAR dominant, SAR+PD, and PD dominant scenarios, and ensures total time-averaged RF exposure compliance.

Test procedure:

1. Measure conducted Tx power corresponding to *P_{limit}* for LTE in selected band, and measure radiated Tx power corresponding to *input.power.limit* in desired mmW band/channel/beam by following below steps:
 - Measure radiated power corresponding to *input.power.limit* by setting up the EUT's Tx power in desired band/channel/beam at *input.power.limit* in FTM. This test is performed in a calibrated anechoic chamber. Rotate the EUT to obtain maximum radiated Tx power, keep the EUT in this position and do not disturb the position of the EUT inside the anechoic chamber for the rest of this test.
 - Reset EUT to place in online mode and establish radio link in LTE, measure conducted Tx power corresponding to LTE *P_{limit}* with Smart Transmit enabled and *Reserve_power_margin* set to 0 dB, callbox set to request maximum power.
2. Set *Reserve_power_margin* to actual (intended) value and reset power in EUT, with EUT setup for LTE + mmW call, perform the following steps:
 - Establish LTE (sub-6) and mmW NR connection with callbox.
 - As soon as the mmW connection is established, immediately request all-down bits on LTE link. Continue LTE (all-down bits) + mmW transmission for more than 100s duration to test predominantly PD exposure scenario (as SAR exposure is negligible from all-down bits in LTE).
 - After 120s, request LTE to go all-up bits, mmW transmission should gradually run out of RF exposure margin if LTE's *P_{limit}* < *P_{max}* and seize mmW transmission (SAR only scenario); or mmW transmission should gradually reduce in Tx power and will sustain the connection if LTE's *P_{limit}* > *P_{max}*.

- After 75s, request LTE to go all-down bits, mmW transmission should start getting back RF exposure margin and resume transmission again.
- Record the conducted Tx power of LTE and radiated Tx power of mmW for the entire duration of this test of at least 300s.

3. Once the measurement is done, extract instantaneous Tx power versus time for both LTE and mmW links. Convert the conducted Tx power for LTE into 1gSAR or 10gSAR value using Eq. (2a) and P_{limit} measured in Step 1.b, and then divide by FCC limit of 1.6 W/kg for 1gSAR or 4.0 W/kg for 10gSAR to obtain instantaneous normalized 1gSAR or 10gSAR versus time. Perform 100s running average to determine normalized 100s-averaged 1gSAR or 10gSAR versus time.

NOTE: In Eq.(2a), instantaneous Tx power is converted into instantaneous 1gSAR or 10gSAR value by applying the measured worst-case 1gSAR or 10gSAR value at P_{limit} for the corresponding technology/band/antenna/DSI reported in Part 1 report.

4. Similarly, convert the radiated Tx power for mmW into 4cm²PD value using Eq. (2b) and the radiated Tx power limit (i.e., radiated Tx power at *input.power.limit*) measured in Step 1.a, then divide this by FCC 4cm²PD limit of 10W/m² to obtain instantaneous normalized 4cm²PD versus time. Perform 4s running average to determine normalized 4s-averaged 4cm²PD versus time.

NOTE: In Eq.(2b), instantaneous radiated Tx power is converted into instantaneous 4cm²PD by applying the worst-case 4cm²PD value measured at *input.power.limit* for the selected band/beam in Part 1 report.

5. Make one plot containing: (a) instantaneous conducted Tx power for LTE versus time, (b) computed 100s-averaged conducted Tx power for LTE versus time, (c) instantaneous radiated Tx power for mmW versus time, as measured in Step 2, (d) computed 4s-averaged radiated Tx power for mmW versus time, and (e) time-averaged conducted and radiated power limits for LTE and mmW radio using Eq. (5a) & (5b), respectively.

6. Make another plot containing: (a) computed normalized 100s-averaged 1gSAR or 10gSAR versus time determined in Step 3, (b) computed normalized 4s-averaged 4cm²PD versus time determined in Step 4, and (c) corresponding total normalized time-averaged RF exposure (sum of steps (6.a) and (6.b)) versus time.

The validation criteria are, at all times, the total normalized time-averaged RF exposure versus time determined in Step 6.c shall not exceed the normalized limit of 1.0 of FCC requirement (i.e., Eq. (2c)).

6.3.3 Change in antenna configuration (beam)

This test is to demonstrate the correct power control by Smart Transmit during changes in antenna configuration (beam). Since the *input.power.limit* varies with beam, the Eq. (2a), (2b) and (2c) in Section 4 are written as below for transmission scenario having change in beam,

$$1g_or_10gSAR(t) = \frac{conducted_Tx_power(t)}{conducted_Tx_power_Plimit} * 1g_or_10gSAR_Plimit \quad (8a)$$

$$4cm^2PD_1(t) = \frac{radiated_Tx_power_1(t)}{radiated_Tx_power_input.power.limit_1} * 4cm^2PD_input.power.limit_1 \quad (8b)$$

$$4cm^2PD_2(t) = \frac{radiated_Tx_power_2(t)}{radiated_Tx_power_input.power.limit_2} * 4cm^2PD_input.power.limit_2 \quad (8c)$$

where, *conducted_Tx_power(t)*, *conducted_Tx_power_Plimit*, and *1g_or_10gSAR_Plimit* correspond to the measured instantaneous conducted Tx power, measured conducted Tx power at P_{limit} and measured *1g_or_10gSAR* or *10gSAR* values at P_{limit} corresponding to LTE transmission.

Similarly, *radiated_Tx_power_1(t)*, *radiated_Tx_power_input.power.limit_1*, and *4cm²PD_input.power.limit_1* correspond to the measured instantaneous radiated Tx power, radiated Tx power at *input.power.limit*, and *4cm²PD* value at *input.power.limit* of beam 1; *radiated_Tx_power_2(t)*, *radiated_Tx_power_input.power.limit_2*, and *4cm²PD_input.power.limit_2* correspond to the measured instantaneous radiated Tx power, radiated Tx power at *input.power.limit*, and *4cm²PD* value at *input.power.limit* of beam 2 corresponding to mmW transmission.

Test procedure:

1. Measure conducted Tx power corresponding to P_{limit} for LTE in selected band, and measure radiated Tx power corresponding to *input.power.limit* in desired mmW band/channel/beam by following below steps:
 - Measure radiated power corresponding to mmW *input.power.limit* by setting up the EUT's Tx power in desired band/channel at *input.power.limit* of beam 1 in FTM. Do not disturb the position of the EUT inside the anechoic chamber for the rest of this test. Repeat this Step 1.a for beam 2.
 - Reset EUT to place in online mode and establish radio link in LTE, measure conducted Tx power corresponding to LTE P_{limit} with Smart Transmit enabled and *Reserve_power_margin* set to 0 dB, callbox set to request maximum power.
2. Set *Reserve_power_margin* to actual (intended) value and reset power in EUT, With EUT setup for LTE + mmW connection, perform the following steps:
 - Establish LTE (sub-6) and mmW NR connection in beam 1. As soon as the mmW connection is established, immediately request all-down bits on LTE link with the callbox requesting EUT's Tx power to be at maximum mmW power.
 - After beam 1 continues transmission for at least 20s, request the EUT to change from beam 1 to beam 2, and continue transmitting with beam 2 for at least 20s.
 - Record the conducted Tx power of LTE and radiated Tx power of mmW for the entire duration of this test.
3. Once the measurement is done, extract instantaneous Tx power versus time for both LTE and mmW links. Convert the conducted Tx power for LTE into 1gSAR or 10gSAR value using the similar approach described in Step 3 of Section 4.3.2. Perform 100s running average to determine normalized 100s-averaged 1gSAR versus time.
4. Similarly, convert the radiated Tx power for mmW NR into 4cm²PD value using Eq. (8b), (8c) and the radiated Tx power limits (i.e., radiated Tx power at *input.power.limit*) measured in Step 1.a for beam 1 and

beam 2, respectively, and then divide the resulted PD values by FCC 4cm²PD limit of 10W/m² to obtain instantaneous normalized 4cm²PD versus time for beam 1 and beam 2. Perform 4s running average to determine normalized 4s-averaged 4cm²PD versus time.

NOTE: In Eq.(8b) and (8c), instantaneous radiated Tx power of beam 1 and beam 2 is converted into instantaneous 4cm²PD by applying the worst-case 4cm²PD value measured at the *input.power.limit* of beam 1 and beam 2 in Part 1 report, respectively.

5. Since the measured radiated powers for beam 1 and beam 2 in Step 1.a were performed at an arbitrary rotation of EUT in anechoic chamber, repeat Step 1.a of this procedure by rotating the EUT to determine maximum radiated power at *input.power.limit* in FTM mode for both beams separately. Re-scale the measured instantaneous radiated power in Step 2.c by the delta in radiated power measured in Step 5 and the radiated power measured in Step 1.a for plotting purposes in next Step. In other words, this step essentially converts measured instantaneous radiated power during the measurement in Step 2 into maximum instantaneous radiated power for both beams. Perform 4s running average to compute 4s-averaged radiated Tx power. Additionally, use these EIRP values measured at *input.power.limit* at respective peak locations to determine the EIRP limits (using Eq. (5b)) for both these beams.
6. Make one plot containing: (a) instantaneous conducted Tx power for LTE versus time, (b) computed 100s-averaged conducted Tx power for LTE versus time, (c) instantaneous radiated Tx power for mmW versus time, as obtained in Step 5, (d) computed 4s-averaged radiated Tx power for mmW versus time, as obtained in Step 5, and (e) time-averaged conducted and radiated power limits for LTE and mmW radio, respectively.
7. Make another plot containing: (a) computed normalized 100s-averaged 1gSAR versus time determined in Step 3, (b) computed normalized 4s-averaged 4cm²PD versus time determined in Step 4, and (c) corresponding total normalized time-averaged RF exposure (sum of steps (6.a) and (6.b)) versus time. The validation criteria are, at all times, the total normalized time-averaged RF exposure versus time determined in Step 6.c shall not exceed the normalized limit of 1.0 of FCC requirement .

6.4 Test procedure for time-varying PD measurements

The following steps are used to perform the validation through PD measurement for transmission scenario 1 described in Section 4:

1. Place the EUT on the cDASY6 platform to perform PD measurement in the worst-case position/surface for the selected mmW band/beam. In PD measurement, the callbox is set to request maximum Tx power from EUT all the time. Hence, “path loss” calibration between callbox antenna and EUT is not needed in this test.
2. Time averaging feature validation:
 - Measure conducted Tx power corresponding to P_{limit} for LTE in selected band, and measure point E-field corresponding to $input.power.limit$ in desired mmW band/channel/beam by following the below steps:

Measure conducted Tx power corresponding to LTE P_{limit} with Smart Transmit enabled and Reserve_power_margin set to 0 dB, with callbox set to request maximum power.

Measure point E-field at peak location of fast area scan corresponding to $input.power.limit$ by setting up the EUT’s Tx power in desired mmW band/channel/beam at $input.power.limit$ in FTM. Do not disturb the position of EUT and mmW cDASY6 probe.

- Set Reserve_power_margin to actual value (i.e., intended value) and reset power on EUT, place EUT in online mode. With EUT setup for LTE (sub-6) + mmW NR call, as soon as the mmW NR connection is established, request all-down bits on LTE link. Continue LTE (all-down bits) + mmW transmission for more than 100s duration to test predominantly PD exposure scenario. After 120s, request LTE to go all-up bits, mmW transmission should gradually reduce. Simultaneously, record the conducted Tx power of LTE transmission using power meter and point E-field (in terms of ratio of

$$\frac{[pointE(t)]^2}{[pointE_{input.power.limit}]^2}) \text{ of mmW transmission using cDASY6 E-field probe at peak location identified in Step 2.a.ii for the entire duration of this test of at least 300s.}$$

- c. Once the measurement is done, extract instantaneous conducted Tx power versus time for LTE transmission and $\frac{[pointE(t)]^2}{[pointE_{input.power.limit}]^2}$ ratio versus time from cDASY6 system

for mmW transmission. Convert the conducted Tx power for LTE into 1gSAR or 10gSAR value using Eq. (4a) and P_{limit} measured in Step 2.a.i, and then divide this by FCC limit of 1.6 W/kg for 1gSAR or 4.0 W/kg for 10gSAR to obtain instantaneous normalized 1gSAR or 10gSAR versus time. Perform 100s running average to determine normalized 100s-averaged 1gSAR or 10gSAR versus time

NOTE: In Eq.(4a), instantaneous Tx power is converted into instantaneous 1gSAR or 10gSAR value by applying the measured worst-case 1gSAR or 10gSAR value at P_{limit} for the corresponding technology/band reported in Part 1 report.

3. Similarly, convert the point E-field for mmW transmission into $4cm^2PD$ value using Eq. (4b) and radiated power limit measured in Step 2.a.ii, and then divide this by FCC $4cm^2PD$ limit of $10W/m^2$ to obtain instantaneous normalized $4cm^2PD$ versus time. Perform 4s running average to determine normalized 4s-averaged $4cm^2PD$ versus time.
4. Make one plot containing: (i) computed normalized 100s-averaged 1gSAR or 10gSAR versus time determined in Step 2.c, (ii) computed normalized 4s-averaged $4cm^2PD$ versus time determined in Step 2.d, and (iii) corresponding total normalized time-averaged RF exposure (sum of steps (2.e.i) and (2.e.ii)) versus time.

The validation criteria are, at all times, the total normalized time-averaged RF exposure versus time determined in Step 2.e.iii shall not exceed the normalized limit of 1.0 of FCC requirement (i.e., Eq. (4c)).

7. Test Configurations

7.1 WWAN (sub-6) transmission

The *Plimit* values, corresponding to 1.0 W/kg (1gSAR) and 2.5 W/kg (10gSAR) of *SAR_design_target*, for technologies and bands supported by EUT are derived in Part 0 report and summarized in Table 7-1. Note all *Plimit* power levels entered in Table 7-1 correspond to average power levels after accounting for duty cycle in the case of TDD modulation schemes.

Table 7-1: *Plimit* for supported technologies and bands (*Plimit* in EFS file)

Plim values in green indicate Plim < Pmax Plim corresponding to 1 W/kg (1g) SAR_Design_target				Plim values in grey indicate Plim > Pmax		Pmax	Pmax	
SAR Exposure Position				Body at Max Power	Body Grip on Back-off	Maximum Tune-up Output Power (Burst Average Power) [dBm]	Maximum Tune-up Output Power (Frame Averaged Power) [dBm]	UL:DL Ratio
Averaging volume				1g	1g			
seperation Distance				19,22,24,9,17 mm	0			
Mode	Band	Antenna	Antenna Group	DSI = 0	DSI = 1			
UMTS	5	Main 1	AG0	25.1	16.0	23.5	23.5	100%
UMTS	4	Main 1	AG0	27.5	13.5	23.5	23.5	100%
UMTS	2	Main 1	AG0	25.5	14.0	23.5	23.5	100%
LTE FDD	7	Main 1	AG0	25.2	11.5	23.0	23.0	100%
LTE FDD	7	SUB 2	AG1	30.3	11.5	23.0	23.0	100%
LTE FDD	12	Main 1	AG0	28.3	15.5	24.0	24.0	100%
LTE FDD	13	Main 1	AG0	25.9	16.0	24.0	24.0	100%
LTE FDD	14	Main 1	AG0	26.3	16.0	24.0	24.0	100%
LTE FDD	25(2)	Main 1	AG0	26.0	14.5	24.0	24.0	100%
LTE FDD	25(2)	SUB 2	AG1	27.5	13.0	23.0	23.0	100%
LTE FDD	26(5)	Main 1	AG0	25.4	15.0	24.0	24.0	100%
LTE FDD	30	Main 1	AG0	28.4	12.0	22.5	22.5	100%
LTE FDD	30	SUB 2	AG1	26.7	12.0	22.5	22.5	100%
LTE TDD PC3	41	Main 1	AG0	27.2	11.5	22.0	20.0	63.3%
LTE TDD PC2	41	Main 1	AG0	29.3	9.9	22.4	18.7	43.3%
LTE TDD	48	Main 2	AG1	25.0	9.5	19.5	17.5	63.3%
LTE FDD	66(4)	Main 1	AG0	27.2	14.0	24.0	24.0	100.0%
LTE FDD	66(4)	SUB 2	AG1	29.3	14.0	23.5	23.5	100%
LTE FDD	71	Main 1	AG0	27.7	17.0	24.0	24.0	100%
NR FDD	7	Main 1	AG0	27.7	11.5	24.0	24.0	100%
NR FDD	12	Main 1	AG0	29.4	15.5	24.0	24.0	100%
NR FDD	25(2)	Main 1	AG0	29.0	15.0	24.0	24.0	100%
NR FDD	26(5)	Main 1	AG0	26.4	15.0	24.0	24.0	100%
NR FDD	30	Main 1	AG0	28.4	12.0	22.5	22.5	100%
NR TDD (PC2)	41	Main 1	AG0	18.5	11.5	27.0	27.0	100%
NR TDD SRS2(PC2)	41	SUB 2	AG1	11.5	10.0	17.0	17.0	100%
NR TDD SRS3(PC2)	41	SUB 4	AG1	13.0	10.0	18.5	18.5	100%
NR TDD SRS4(PC2)	41	SUB 1	AG1	8.5	8.5	14.0	14.0	100%
NR TDD (PC3)	41	Main 1	AG0	18.5	11.5	24.0	24.0	100%
NR TDD SRS2(PC3)	41	SUB 2	AG1	11.5	10.0	17.0	17.0	100%
NR TDD SRS3(PC3)	41	SUB 4	AG1	13.0	10.0	18.5	18.5	100%
NR TDD SRS4(PC3)	41	SUB 1	AG1	8.5	8.5	14.0	14.0	100%
NR TDD	48	Main 2	AG1	16.0	10.5	21.5	21.5	100%
NR TDD SRS2	48	Sub 2	AG1	9.5	9.0	15.0	15.0	100%
NR TDD SRS3	48	Sub 3	AG1	13.0	9.0	18.5	18.5	100%
NR TDD SRS4	48	SUB 3	AG0	16.0	9.0	21.5	21.5	100%
NR FDD	66(4)	Main 1	AG0	24.0	14.5	24.0	24.0	100%
NR FDD	71	Main 1	AG0	24.0	17.0	24.0	24.0	100%
NR TDD (PC2)	77	Main2	AG1	18.5	10.0	27.0	27.0	100%
NR TDD SRS2(PC2)	77	SUB 2	AG1	11.5	8.5	17.0	17.0	100%
NR TDD SRS3(PC2)	77	SUB 4	AG1	14.5	8.5	20.0	20.0	100%
NR TDD SRS4(PC2)	77	SUB 3	AG0	17.0	8.5	22.5	22.5	100%
NR TDD (PC3)	77	Main2	AG1	18.5	10.0	24.0	24.0	100%
NR TDD SRS2(PC3)	77	SUB 2	AG1	11.5	8.5	17.0	17.0	100%
NR TDD SRS3(PC3)	77	SUB 4	AG1	14.5	8.5	20.0	20.0	100%
NR TDD SRS4(PC3)	77	SUB 3	AG0	17.0	8.5	22.5	22.5	100%
NR DoD (PC3)	77	Main2	AG1	18.5	10.0	24.0	24.0	100%
NR DoD SRS2(PC3)	77	SUB 2	AG1	11.5	8.5	17.0	17.0	100%
NR DoD SRS3(PC3)	77	SUB 4	AG1	14.5	8.5	20.0	20.0	100%
NR DoD SRS4(PC3)	77	SUB 3	AG0	17.0	8.5	22.5	22.5	100%
NR DoD (PC2)	77	Main2	AG1	18.5	10.0	27.0	27.0	100%
NR DoD SRS2(PC2)	77	SUB 2	AG1	11.5	8.5	17.0	17.0	100%
NR DoD SRS3(PC2)	77	SUB 4	AG1	14.5	8.5	20.0	20.0	100%
NR DoD SRS4(PC2)	77	SUB 3	AG0	17.0	8.5	22.5	22.5	100%

* Maximum tune up target power, *Pmax*, is configured in NV settings in EUT to limit maximum transmitting power. This power is converted into peak power in NV settings for TDD schemes. The EUT maximum allowed

output power is equal to $P_{max} + 1\text{dB}$ device uncertainty.

Based on selection criteria described in Section 5.2.1, the selected technologies/bands for testing time-varying test sequences are highlighted in yellow in Table 7-1. As per Part 1 report, the *Reserve_power_margin* (dB) for Samsung Portable Tablet (FCC ID: A3LSMX818U) is set to 3dB in EFS, and is used in Part 2 test.

The radio configurations used in Part 2 test for selected technologies, bands, DSIs and antennas are listed in Table 7-2. The corresponding worst-case radio configuration 1gSAR or 10gSAR values for selected technology/band/DSI are extracted from Part 1 report and are listed in the last column of Table 7-2.

Based on equations (1a), (2a), (3a) and (4a), it is clear that Part 2 testing outcome is normalized quantity, which implies that it can be applied to any radio configuration within a selected technology/band/DSI. Thus, as long as applying the worst-case SAR obtained from the worst radio configuration in Part 1 testing to calculate time-varying SAR exposure in equations (1a), (2a), (3a) and (4a), the accuracy in compliance demonstration remains the same.

Table 7-2: Radio configurations selected for Part 2 test

Test Case #	Test Scenario	Tech	Band	Antenna	DSI	Channel	Frequency [MHz]	RB/RB Offset/Bandwidth (MHz)	Mode	SAR Exposure Scenario	Part 1 Worst Case Measured SAR at Plimit (W/kg)
1	Time-varying Tx power transmission	LTE	B7	Main 1	1	21100	2535	50/25/20 MHz BW	QPSK	Grip, Rear, 0mm	0.927
2			B13	Main 1	1	23230	782	25/0/10 MHz BW	QPSK	Grip, Top, 0mm	0.890
3		UMTS	B4	Main 1	1	1513	1752.6	-	RMC	Grip, Top, 0mm	0.777
4		Sub6 NR	n7	Main 1	1	507000	2535	108/54/40 MHz BW	QPSK	Grip, Top, 0mm	0.453
5		Sub6 NR	n77	Main2	1	662000	3930	1/1/100 MHz BW	QPSK	Grip, Left, 0mm	0.718
6	Change in Call	Sub6 NR	n77	Main2	1	662000	3930	1/1/100 MHz BW	QPSK	Grip, Left, 0mm	0.718
7	Tech/Band Switch	LTE	B7	Main 1	1	21100	2535	50/25/20 MHz BW	QPSK	Grip, Rear, 0mm	0.927
		UMTS	B5	Main 1	1	4183	836.6	-	RMC	Grip, Top, 0mm	0.768
8	DSI Switch	Sub6 NR	n77	Main2	1	662000	3930	1/1/100 MHz BW	QPSK	Grip, Left, 0mm	0.718
			n77	Main2	0	662000	3930	135/0/100 MHz BW	QPSK	Free , Left, 9mm	0.569
9	Antenna Switch	Sub6 NR	n41	Main 1	1	518598	2592.99	1/1/100 MHz BW	QPSK	Grip, Rear, 0mm	0.733
			n77	Main2	1	662000	3930	1/1/100 MHz BW	QPSK	Grip, Left, 0mm	0.718
10	Time Window	Sub6 NR	n41	Main 1	1	518598	2592.99	1/1/100 MHz BW	QPSK	Grip, Left, 0mm	0.733
			n77	Main2	1	662000	3930	1/1/100 MHz BW	QPSK	Grip, Left, 0mm	0.718
11	SAR1 vs SAR2	LTE	B5	Main 1	1	20525	836.5	1/0/10 MHz BW	QPSK	Grip, Top, 0mm	0.693
		Sub6 NR	n7	Main 1	1	507000	2535	108/54/40 MHz BW	QPSK	Grip, Top, 0mm	0.453

Note

1. the EUT has a proximity sensor to manage Body SAR exposure at 0 mm, which is represented using DSI = 1 the maximum 1g SAR among all remaining exposure scenarios or the minimum *P_{limit}* among all remaining exposure scenarios is used in Smart Transmit feature for time averaging operation
2. Antenna switch test case was not included in the test plan selection since the DUT does not support any SA transmission on any additional antennas.

Based on the selection criteria described in Section 7.2, the radio configurations for the Tx varying transmission test cases listed in Section 6 are:

1. Technologies and bands for time-varying Tx power transmission: The test case 1~5 listed in Table 7-2 are selected to test with the test sequences defined in Section 7.1 in both time-varying conducted power measurement and time-varying SAR measurement.

2. Technology and band for change in call test: Sub 6 NR B77 band (test case 6 in Table 7-2) is selected for performing the call drop test in conducted power setup.

3. Technologies and bands for change in technology/band test: Following the guidelines in Section 5.2.3 and 5.2.4, test case 7 in Table 7-2 is selected for handover test from a technology/band/antenna with lowest *P_{limit}* within one technology group (LTE B7, DSI=1 Grip Sensor mode), to a technology/band in the same DSI with highest *P_{limit}* within another technology group (UMTS B5, DSI=1 Grip Sensor mode) in conducted power setup.

4. Technologies and bands for change in DSI: Based on selection criteria in Section 5.2.5, for a given technology and band, test case 8 in Table 7-2 is selected for DSI switch test by establishing a call in Sub 6 NR B77 in DSI = 1 with Grip sensor exposure scenario, and then handing over to Free space condition (i.e., DSI=0) in conducted power setup.

5. Technologies and bands for change in time-window/antenna: Based on selection criteria in Section 5.2.4, 5.2.6 for a given DSI=1, test case 9, 10 in Table 7-2 is selected for time window switch between 60s window (Sub 6 NR B77, Main 2) and 100s window (Sub 5 NR B41, Main 1) in conducted power setup.

6. Technologies and bands for switch in SAR exposure: Based on selection criteria in Section 5.2.7 Scenario 1, test case 11 in Table 7-2 is selected for SAR exposure switching test in one of the supported simultaneous WWAN transmission scenario, i.e., LTE + Sub6 NR active in the same 100s time window, in conducted power setup. Since this device supports LTE+mmW NR, test for Section 5.2.7 Scenario 2 for RF exposure switch is covered in Sections 6.3.2 and 6.3.3 between LTE (100s window) and mmW NR (4s window).

7.2 LTE + mmW NR transmission

Based on the selection criteria described in Section 6.2, the selections for LTE and mmW NR validation test are listed in Table 7-3. The radio configurations used in this test are listed in Table 7-4.

Table 7-3 Selections for LTE + mmW NR validation measurements

Test Case #	Transmission Scenario	Test	Technology and Band	mmW Beam
12	Time-varying Tx power test	Cond. & Rad. Power meas.	LTE Band 2 and n261	Beam ID 154
13	Switch in SAR vs. PD	Cond. & Rad. Power meas.	LTE Band 2 and n261	Beam ID 154
14	Beam switch test	Cond. & Rad. Power meas.	LTE Band 2 and n261	Beam ID 154 to Beam ID 134

Table 7-4: Test configuration for LTE + mmW NR validation

Tech	Band	Ant.	DSI	Channel	RB/Offset	Freq. (MHz)	Mode	UL Duty Cycle
LTE	B2	Main 1	1	18900	1/0/20 MHz BW	1880	QPSK	100%
mmW NR	n261	K	1	2077915	20/22/100 MHz BW	27924.96	DFTS-OFDM, QPSK	75.6%*

* mmW NR callbox UL duty cycle should be configured to be greater than 75.6% for all LTE+mmW NR Part 2 tests.

8. Time-varying Tx power measurement for below 6GHz frequency

8.1 Conducted Measurement Test setup

Legacy Test Setup

The Rohde & Schwarz CMW500 callbox is used in this test. The test setup picture and schematic are shown in Figures 8-1a for measurements with a single antenna of EUT (see Appendix C–The test Setup Photo 1).and in Figures 8-1b for measurements involving antenna switch (see Appendix CThe test Setup Photo 2).

For single antenna measurement, one port (RF1 COM) of the callbox is connected to the RF port of the EUT using a directional coupler. For antenna & technology switch measurement, two ports (RF1 COM and RF3 COM) of the callbox used for signaling two different technologies are connected to a combiner, which is in turn connected to a directional coupler. The other end of the directional coupler is connected to a splitter to connect to two RF ports of the EUT corresponding to the two antennas of interest. In both the setups, power meter is used to tap the directional coupler for measuring the conducted output power of the EUT. For time averaging validation test (Section 5.3.1), call drop test (Section 5.3.2), and DSI switch test (Section 5.3.4), only RF1 COM port of the callbox is used to communicate with the EUT. For technology/band switch measurement (Section. 5.3.3), both RF1 COM and RF3 COM port of callbox are used to switch from one technology communicating on RF1 COM port to another technology communicating on RF3 COM port. All the path losses from RF port of EUT to the callbox RF COM port and to the power meter are calibrated and automatically entered as offsets in the callbox and the power meter via test scripts on the PC used to control callbox and power meter.

LTE+Sub6 NR test setup:

If LTE conducted port and Sub6 NR conducted port are same on this EUT (i.e., they share the same antenna), then low-/high-pass filter is used to separate LTE and Sub6 NR signals for power meter measurement via directional couplers, as shown in below Figures 8-(c) (see Appendix C- Test setup photo-3)

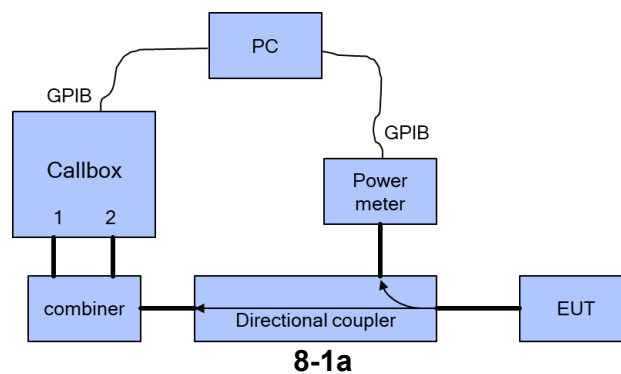

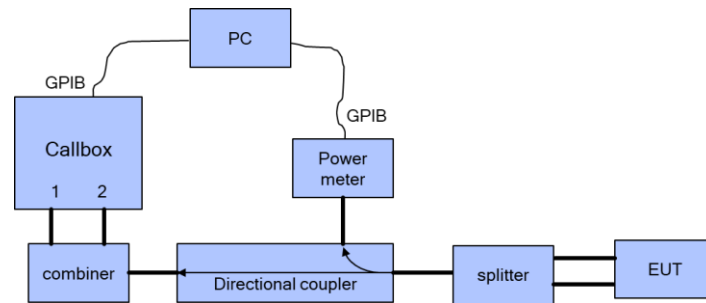

8-1b

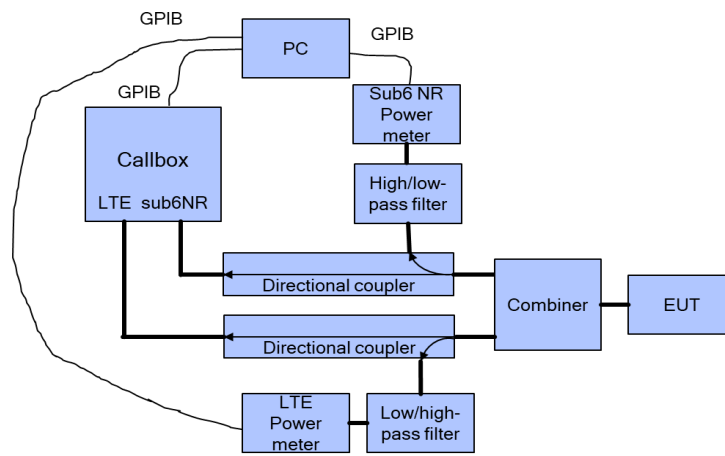

8-1c

Figure 8-1 Conducted power measurement setup

Both the callbox and power meter are connected to the PC using GPIB cables. Two test scripts are custom made for automation, and the test duration set in the test scripts is 600 seconds.

For time-varying Tx power measurement, the PC runs the 1st test script to send GPIB commands to control the callbox’s requested power versus time, while at the same time to record the conducted power measured at EUT RF port using the power meter. The commands sent to the callbox to request power are:

- 0dBm for 100 seconds
- test sequence 1 or test sequence 2 (defined in Section 5.1 and generated in Section 5.5.1), for 360 seconds
- stay at the last power level of test sequence 1 or test sequence 2 for the remaining time.

Power meter readings are periodically recorded every 100ms. A running average of this measured Tx power over 100 seconds is performed in the post-data processing to determine the 100s-time averaged power.

For call drop, technology/band/antenna switch, and DSI switch tests, after the call is established, the callbox is set to request the EUT’s Tx power at 0dBm for 100 seconds while simultaneously starting the 2nd test script runs at the same time to start recording the Tx power measured at EUT RF port using the power meter. After the initial 100 seconds since starting the Tx power recording, the callbox is set to request maximum power from the EUT for the rest of the test.

Note that the call drop/re-establish, or technology/band/antenna switch or DSI switch is manually performed when the Tx power of EUT is at *Preserve* level. See Section 5.3 for detailed test procedure of call drop test, technology/band/antenna switch test and DSI switch test.

8.2 Plimit and Pmax measurement Results

The measured *Plimit* for all the selected radio configurations given in Table 7-2 are listed in below Table 8-1. *Pmax* was also measured for radio configurations selected for testing time-varying Tx power transmission scenarios in order to generate test sequences following the test procedures in Section 5.1.

Table 8-1: Measured Plimit and Pmax of selected radio configuration

Test Case #	Test Scenario	Tech	Band	Antenna	DSI	Channel	Frequency [MHz]	RB/RB Offset/Bandwidth (MHz)	Mode	SAR Exposure Scenario	Plimit EFS Setting[dBm]	Tune Up Target Power Pmax[dBm]	Measured Plimit [dBm]	Measured Pmax [dBm]	Part 1 Worst Case Measured SAR at Plimit (W/kg)
1	Time-varying Tx power transmission	LTE	B7	Main 1	1	21100	2535	50/25/20 MHz BW	QPSK	Grip, Rear, 0mm	11.50	22.00	12.39	22.53	0.927
2			B13	Main 1	1	23230	782	25/0/10 MHz BW	QPSK	Grip, Top, 0mm	16.00	23.00	16.49	23.14	0.890
3		UMTS	B4	Main 1	1	1513	1752.6	-	RMC	Grip, Top, 0mm	13.50	23.50	13.96	23.94	0.777
4		Sub6 NR	n7	Main 1	1	507000	2535	108/54/40 MHz BW	QPSK	Grip, Top, 0mm	11.50	24.00	11.83	24.20	0.453
5		Sub6 NR	n77	Main2	1	662000	3930	1/1/100 MHz BW	QPSK	Grip, Left, 0mm	10.00	24.00	9.98	23.17	0.718
6	Change in Call	Sub6 NR	n77	Main2	1	662000	3930	1/1/100 MHz BW	QPSK	Grip, Left, 0mm	10.00	24.00	9.98	23.17	0.718
7	Tech/Band Switch	LTE	B7	Main 1	1	21100	2535	50/25/20 MHz BW	QPSK	Grip, Rear, 0mm	11.50	22.00	12.39	22.53	0.927
		UMTS	B5	Main 1	1	4183	836.6	-	RMC	Grip, Top, 0mm	16.00	23.50	15.82	23.23	0.768
8	DSI Switch	Sub6 NR	n77	Main2	1	662000	3930	1/1/100 MHz BW	QPSK	Grip, Left, 0mm	10.00	24.00	9.98	23.17	0.718
			n77	Main2	0	662000	3930	135/0/100 MHz BW	QPSK	Free, Left, 9mm	18.50	23.00	18.25	22.24	0.569
9	Antenna Switch	Sub6 NR	n41	Main 1	1	518598	2593.99	1/1/100 MHz BW	QPSK	Grip, Rear, 0mm	11.50	24.00	11.48	23.51	0.733
			n77	Main2	1	662000	3930	1/1/100 MHz BW	QPSK	Grip, Left, 0mm	10.00	24.00	9.98	23.17	0.718
10	Time Window	Sub6 NR	n41	Main 1	1	518598	2593.99	1/1/100 MHz BW	QPSK	Grip, Left, 0mm	11.50	24.00	11.48	23.51	0.733
			n77	Main2	1	662000	3930	1/1/100 MHz BW	QPSK	Grip, Left, 0mm	10.00	24.00	9.98	23.17	0.718
11	SAR1 vs SAR2	LTE	B5	Main 1	1	20525	836.5	1/0/10 MHz BW	QPSK	Grip, Top, 0mm	15.00	24.00	14.80	24.01	0.693
		Sub6 NR	n7	Main 1	1	507000	2535	108/54/40 MHz BW	QPSK	Grip, Top, 0mm	11.50	24.00	11.83	24.20	0.453

Note:

1. The device uncertainty of *Pmax* is +1dB/-1.5dB as provided by manufacturer.
2. Mult-Tx factor is set to 1.0 per the manufacturer.
3. WLAN and BT time-averaging is disabled per the manufacturer.
4. Tests including duty-cycle transmit are normalized to frame average.
5. Due to a limitation of the available test equipment, a modified procedure was used for Sub6 NR TDD Cases. The relevant parameters are shown below. On the above table, NR Band n41 & n77 measured Pmax and Measured Plimit values represent Pmax_seq and Plimit_seq. Section B.2 contains more details about the modified procedure used for NR Band n41 & n77 evaluation.

8.3 Time-varying Tx power measurement results

The measurement setup is shown in Figures 8-1(a), 8-1(b) and 8-1(c). The purpose of the time-varying Tx power measurement is to demonstrate the effectiveness of power limiting enforcement and that the time-averaged Tx power when represented in time-averaged 1gSAR or 10gSAR values does not exceed FCC limit as shown in Eq. (1a) and (1b), rewritten below:

$$1g_or_10gSAR(t) = \frac{conducted_Tx_power(t)}{conducted_Tx_power_P_{limit}} * 1g_or_10gSAR_P_{limit} \quad (1a)$$

$$\frac{\frac{1}{T_{SAR}} \int_{t-T_{SAR}}^t 1g_or_10gSAR(t) dt}{FCC\ SAR\ limit} \leq 1 \quad (1b)$$

where, $conducted_Tx_Power(t)$, $conducted_Tx_P_{limit}$, and $1g_or_10g\ SAR_P_{limit}$ correspond to the measured instantaneous conducted Tx power, measured conducted Tx power at P_{limit} , and measured 1gSAR and 10gSAR values at P_{limit} reported in Part 1 test (listed in Table 7-2 of this report as well).

Following the test procedure in Section 5.3, the conducted Tx power measurement for all selected configurations are reported in this section. In all the conducted Tx power plots, the dotted line represents the requested power by callbox (test sequence 1 or test sequence 2), the blue curve represents the instantaneous conducted Tx power measured using power meter, the green curve represents time-averaged power and red line represents the conducted power limit that corresponds to FCC limit of 1.6 W/kg for 1gSAR or 4.0 W/kg for 10gSAR.

Similarly, in all the 1g or 10gSAR plots (when converted using Eq. (1a)), the green curve represents the 100s time averaged 1gSAR or 10gSAR value calculated based on instantaneous 1gSAR or 10gSAR; and the red line limit represents the FCC limit of 1.6 W/kg for 1gSAR or 4.0 W/kg for 10gSAR.

Time-varying Tx power measurements were conducted on test cases #1 ~ #5 in Table 7-2, by generating test sequence 1 and test sequence 2 given in Appendix A using measured P_{limit} and measured P_{max} for each of these test cases. Measurement results for test cases #1 ~ #5 are given in Sections 8.3.1 - 8.3.5.

8.3.1 LTE Band 7 (test case 1 in Table 7-2)

Conducted Plot No. 1

Test result for test sequence 1:

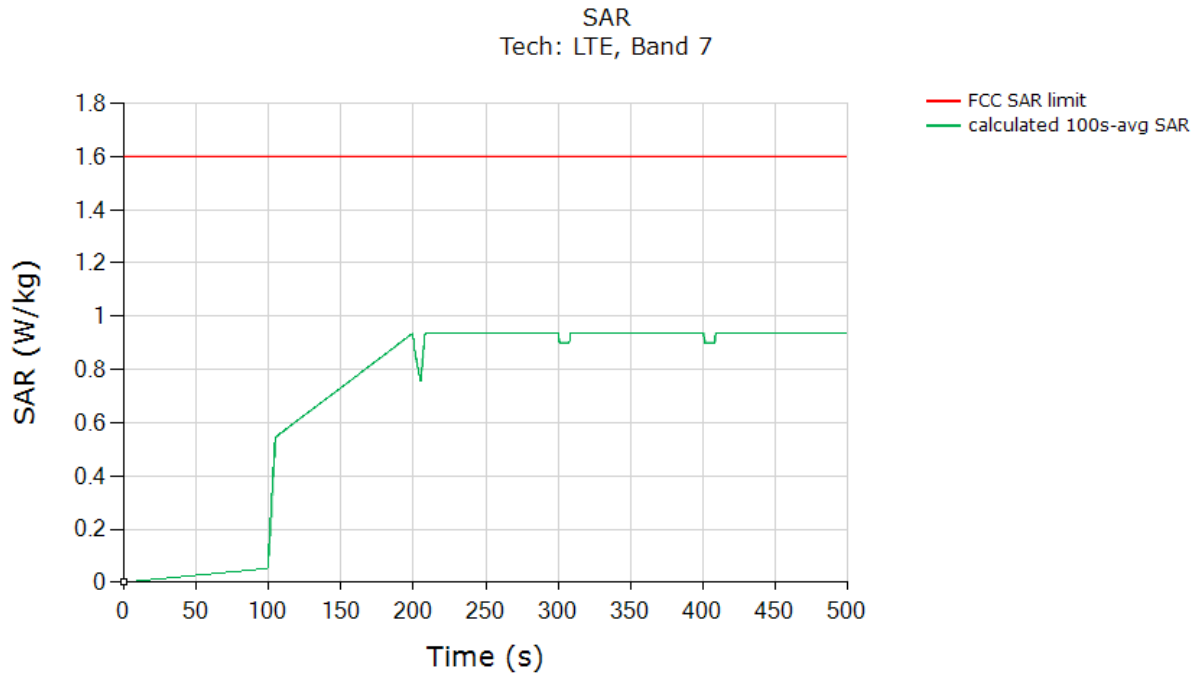

Above time-averaged conducted Tx power is converted/calculated into time-averaged 1g SAR using Equation (1a) and plotted below to demonstrate that the time-averaged 1g SAR versus time does not exceed the FCC limit of 1.6 W/kg for 1g SAR:

FCC 1g SAR Limit [W/kg]	1.6 W/kg
Max 100s-time averaged 1gSAR (green curve)	0.937 W/kg
Validated: Max time averaged SAR (green curve) is within 1dB device uncertainty of measured SAR at <i>P</i> _{limit} (last column in Table 7-2).	

Test result for test sequence 2:

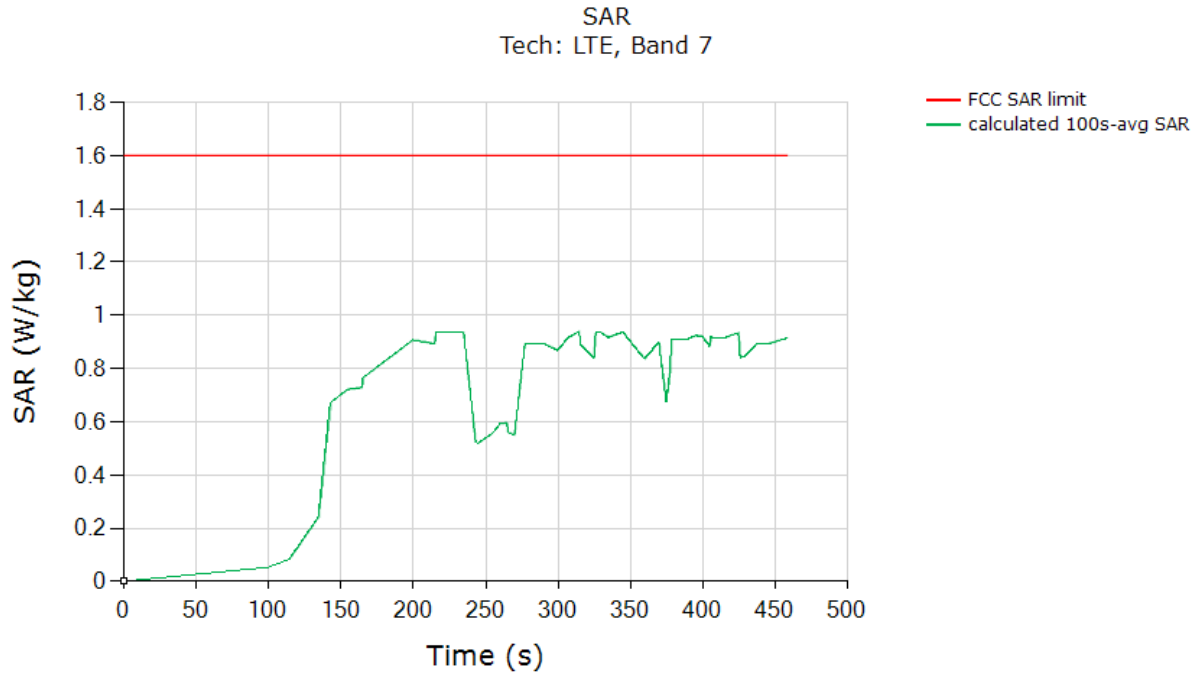

Above time-averaged conducted Tx power is converted/calculated into time-averaged 1g SAR using Equation (1a) and plotted below to demonstrate that the time-averaged 1g SAR versus time does not exceed the FCC limit of 1.6 W/kg for 1g SAR:

FCC 1g SAR Limit [W/kg]	1.6 W/kg
Max 100s-time averaged 1g SAR (green curve)	0.938 W/kg
Validated: Max time averaged SAR (green curve) is within 1dB device uncertainty of measured SAR at <i>P</i> _{limit} (last column in Table 7-2).	

8.3.2 LTE Band 13 (test case 2 in Table 7-2)

Conducted Plot No. 2

Test result for test sequence 1:

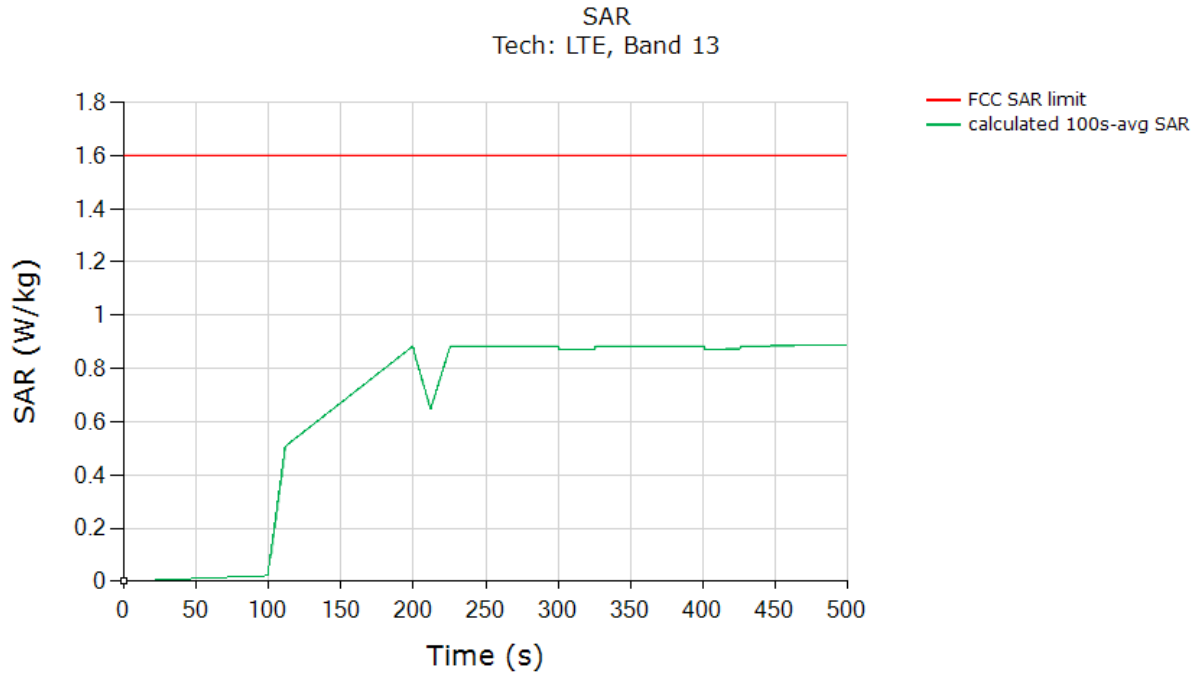

Above time-averaged conducted Tx power is converted/calculated into time-averaged 1g SAR using Equation (1a) and plotted below to demonstrate that the time-averaged 1g SAR versus time does not exceed the FCC limit of 1.6 W/kg for 1g SAR:

FCC 1g SAR Limit [W/kg]	1.6 W/kg
Max 60s-time averaged 1g SAR (green curve)	0.886 W/kg
Validated: Max time averaged SAR (green curve) is within 1dB device uncertainty of measured SAR at <i>P</i> _{limit} (last column in Table 7-2).	

Test result for test sequence 2:

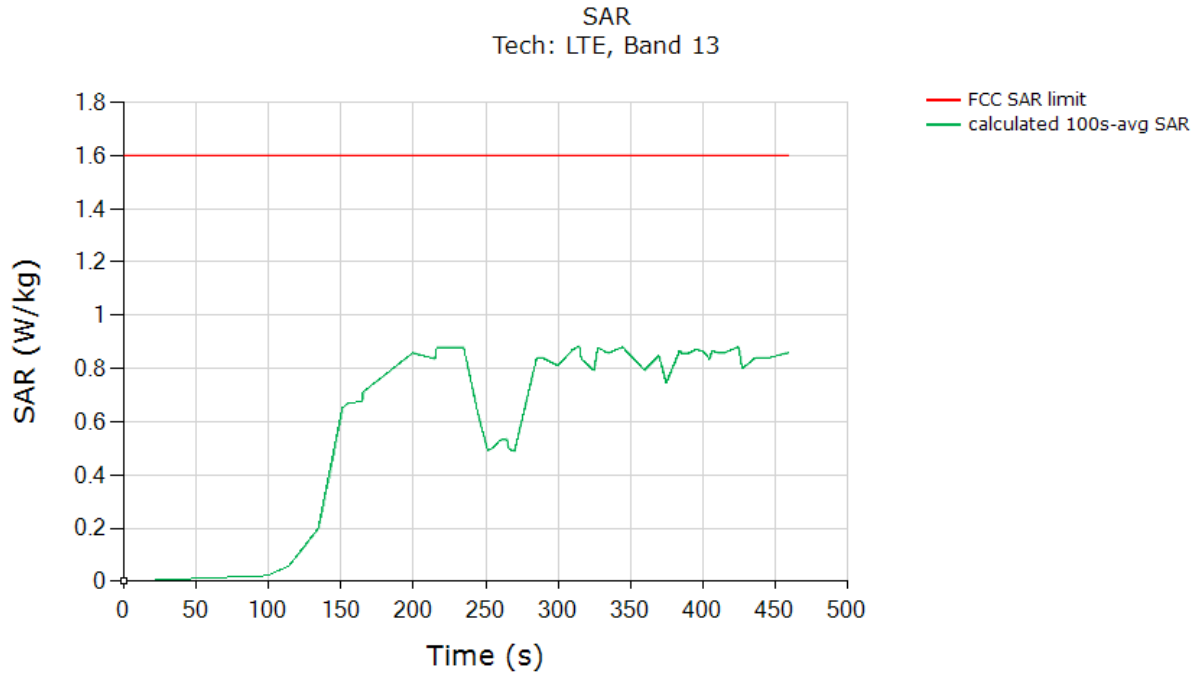

Above time-averaged conducted Tx power is converted/calculated into time-averaged 1g SAR using Equation (1a) and plotted below to demonstrate that the time-averaged 1g SAR versus time does not exceed the FCC limit of 1.6 W/kg for 1g SAR:

FCC 1g SAR Limit [W/kg]	1.6 W/kg
Max 60s-time averaged 1g SAR (green curve)	0.884 W/kg
Validated: Max time averaged SAR (green curve) is within 1dB device uncertainty of measured SAR at <i>P</i> _{limit} (last column in Table 7-2).	

8.3.3 UMTS Band 4 (test case 3 in Table 7-2)

Conducted Plot No. 3

Test result for test sequence 1

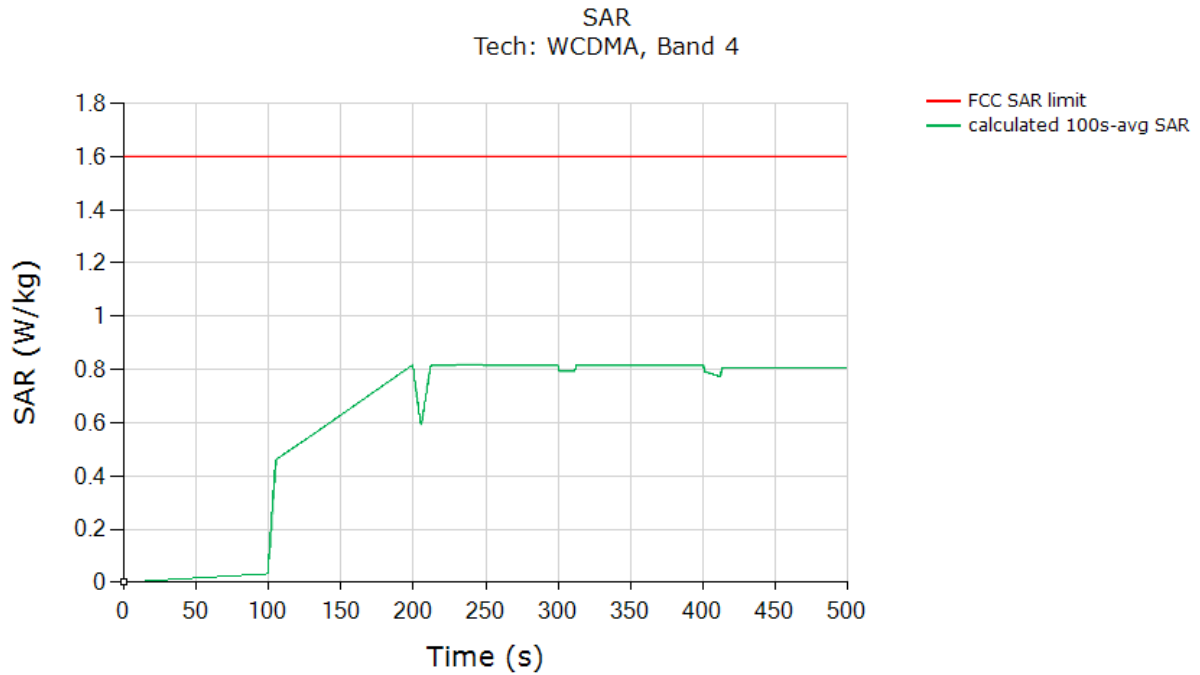

Above time-averaged conducted Tx power is converted/calculated into time-averaged 1g SAR using Equation (1a) and plotted below to demonstrate that the time-averaged 1g SAR versus time does not exceed the FCC limit of 1.6 W/kg for 1g SAR:

FCC 1g SAR Limit [W/kg]	1.6 W/kg
Max 100s-time averaged 1g SAR (green curve)	0.817 W/kg
Validated: Max time averaged SAR (green curve) is within 1dB device uncertainty of measured SAR at <i>P_{limit}</i> (last column in Table 7-2).	

Test result for test sequence 2:

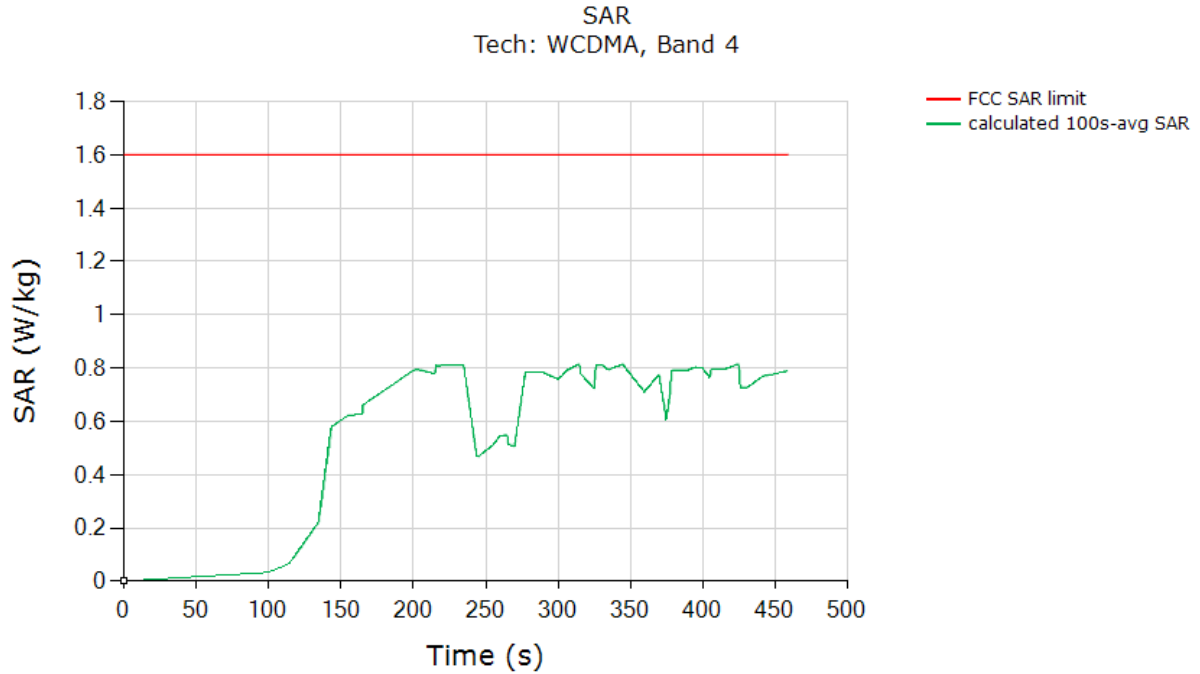

Above time-averaged conducted Tx power is converted/calculated into time-averaged 1g SAR using Equation (1a) and plotted below to demonstrate that the time-averaged 1g SAR versus time does not exceed the FCC limit of 1.6 W/kg for 1g SAR:

FCC 1g SAR Limit [W/kg]	1.6 W/kg
Max 100s-time averaged 1g SAR (green curve)	0.815 W/kg
Validated: Max time averaged SAR (green curve) is within 1dB device uncertainty of measured SAR at P_{limit} (last column in Table 7-2).	

8.3.4 Sub6 NR n7 (test case4 in Table 7-2)

Conducted Plot No. 4

Test result for test sequence 1

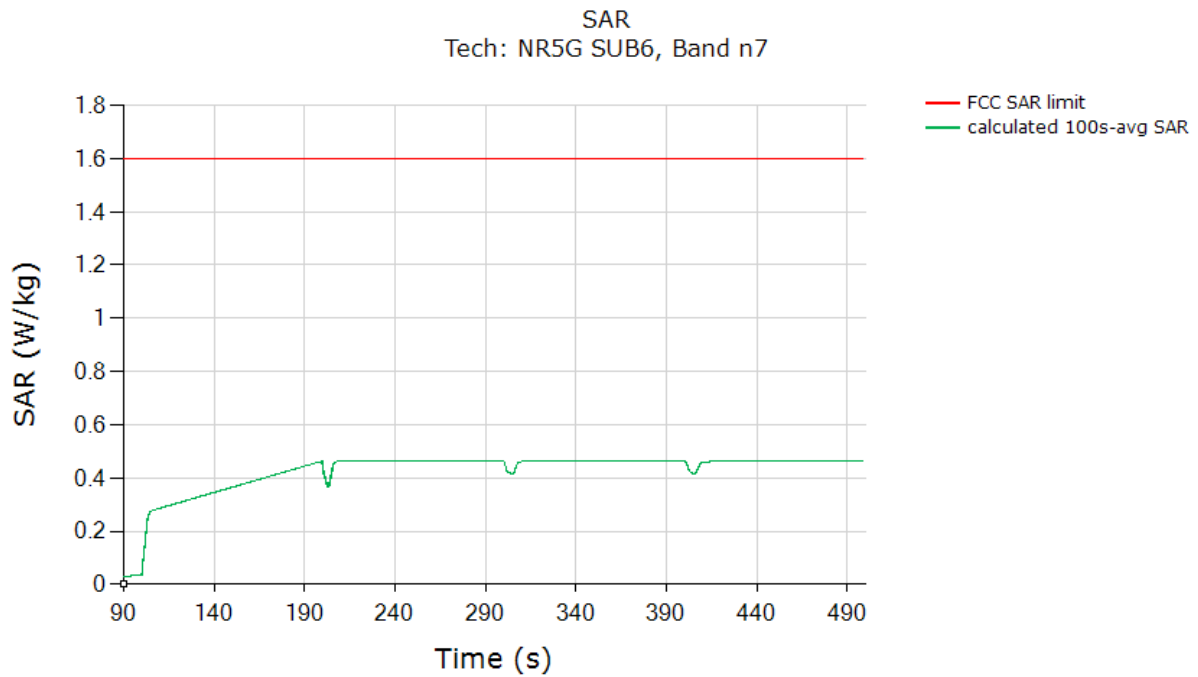

Above time-averaged conducted Tx power is converted/calculated into time-averaged 1g SAR using Equation (1a) and plotted below to demonstrate that the time-averaged 1g SAR versus time does not exceed the FCC limit of 1.6 W/kg for 1g SAR:

FCC 1g SAR Limit [W/kg]	1.6 W/kg
Max 100s-time averaged 1g SAR (green curve)	0.463 W/kg
Validated: Max time averaged SAR (green curve) is within 1dB device uncertainty of measured SAR at <i>P</i> _{limit} (last column in Table 7-2).	

Test result for test sequence 2:

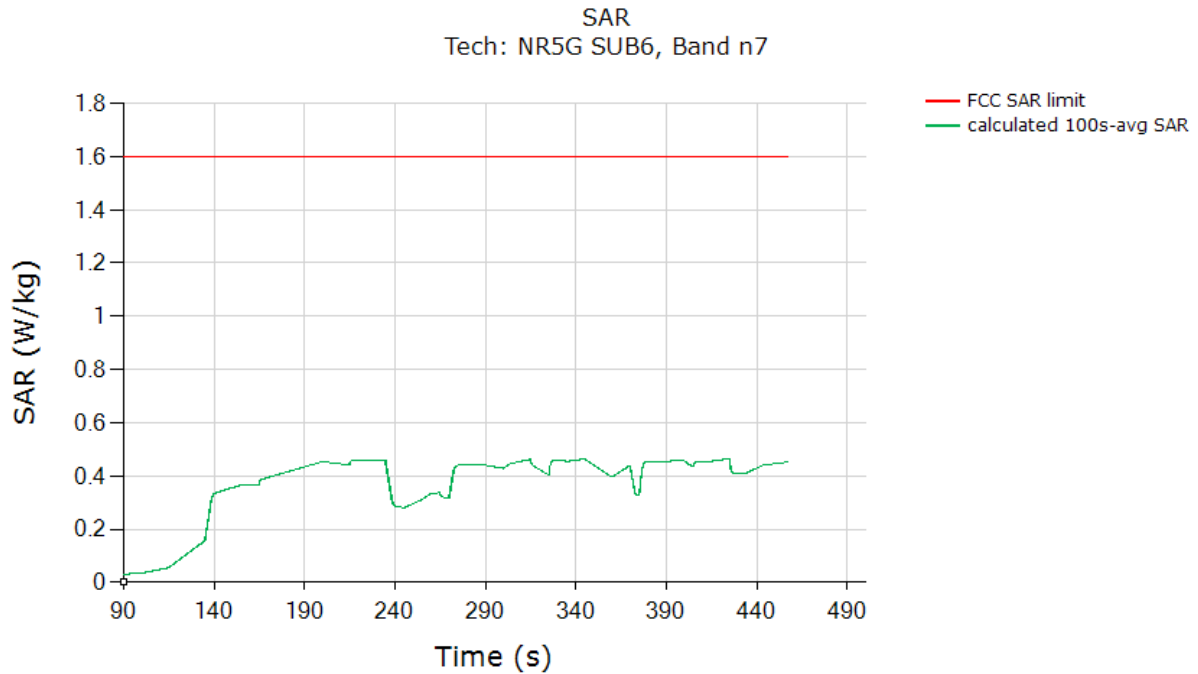

Above time-averaged conducted Tx power is converted/calculated into time-averaged 1g SAR using Equation (1a) and plotted below to demonstrate that the time-averaged 1g SAR versus time does not exceed the FCC limit of 1.6 W/kg for 1g SAR:

FCC 1g SAR Limit [W/kg]	1.6 W/kg
Max 100s-time averaged 1g SAR (green curve)	0.464 W/kg
Validated: Max time averaged SAR (green curve) is within 1dB device uncertainty of measured SAR at <i>P</i> _{limit} (last column in Table 7-2).	

8.3.5 Sub6 NR n77 (test case 5 in Table 7-2)

Conducted Plot No. 5

Test result for test sequence 1

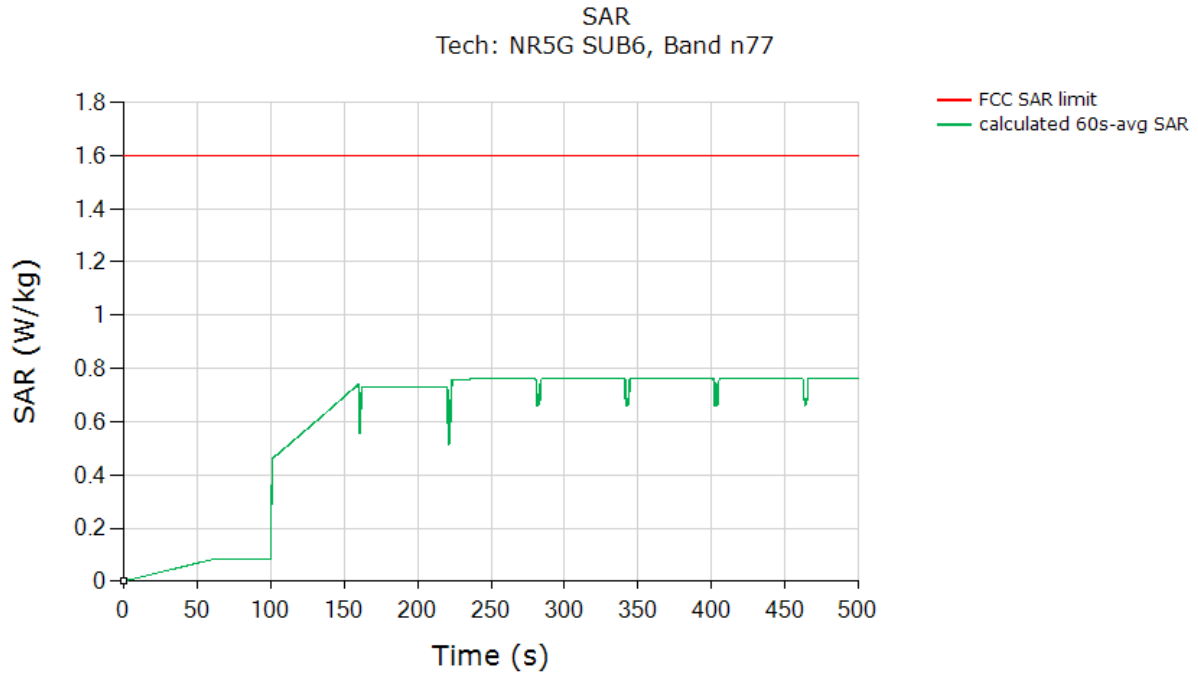

Above time-averaged conducted Tx power is converted/calculated into time-averaged 1g SAR using Equation (1a) and plotted below to demonstrate that the time-averaged 1g SAR versus time does not exceed the FCC limit of 1.6 W/kg for 1g SAR:

FCC 1g SAR Limit [W/kg]	1.6 W/kg
Max 100s-time averaged 1g SAR (green curve)	0.762 W/kg
Validated: Max time averaged SAR (green curve) is within 1dB device uncertainty of measured SAR at <i>P</i> limit (last column in Table 7-2).	

Test result for test sequence 2:

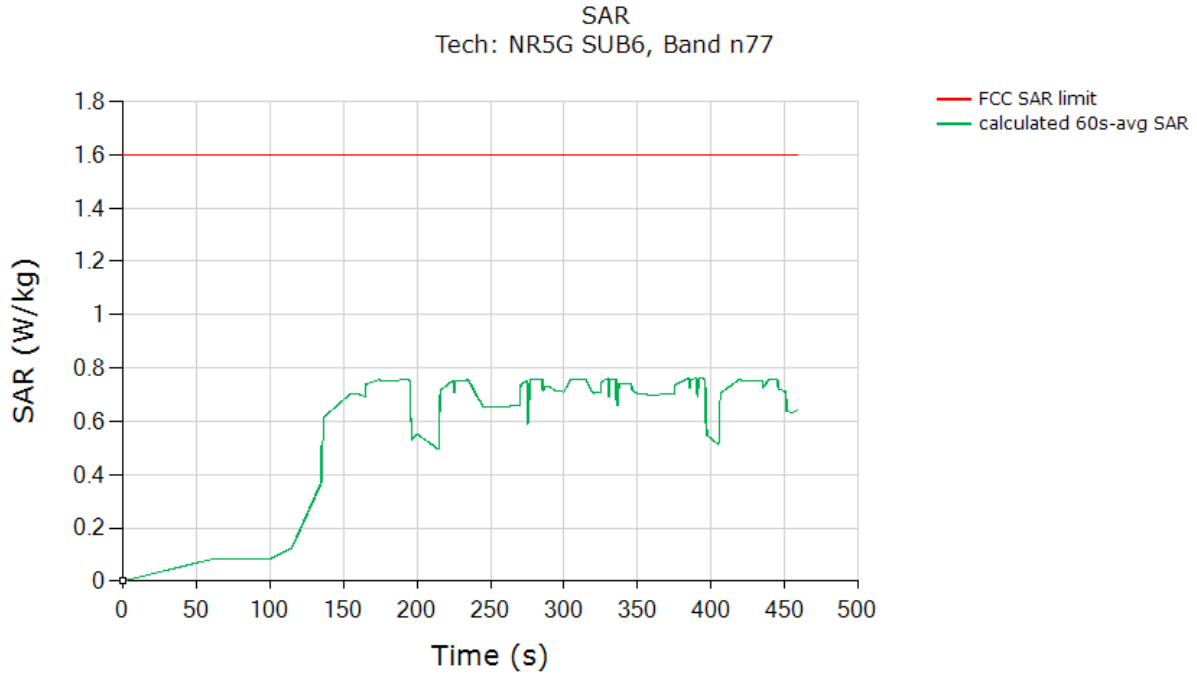

Above time-averaged conducted Tx power is converted/calculated into time-averaged 1g SAR using Equation (1a) and plotted below to demonstrate that the time-averaged 1g SAR versus time does not exceed the FCC limit of 1.6 W/kg for 1g SAR:

FCC 1g SAR Limit [W/kg]	1.6 W/kg
Max 100s-time averaged 1g SAR (green curve)	0.761 W/kg
Validated: Max time averaged SAR (green curve) is within 1dB device uncertainty of measured SAR at <i>P</i> _{limit} (last column in Table 7-2).	

8.4 Change in Call Test results (test case 6 in Table 7-2)

This test was measured with Sub 6 NR B77, DSI=1, and with callbox requesting maximum power. The call drop was manually performed when the EUT is transmitting at *Preserve* level as shown in the plot below (dotted black region). The measurement setup is shown in Figure 8-1(a) and (c). The detailed test procedure is described in Section 5.3.2.

Conducted Plot No. 6

Call drop test result:

Above time-averaged conducted Tx power is converted/calculated into time-averaged 1g SAR using Equation (1a) and plotted below to demonstrate that the time-averaged 1g SAR versus time does not exceed the FCC limit of 1.6 W/kg for 1g SAR:

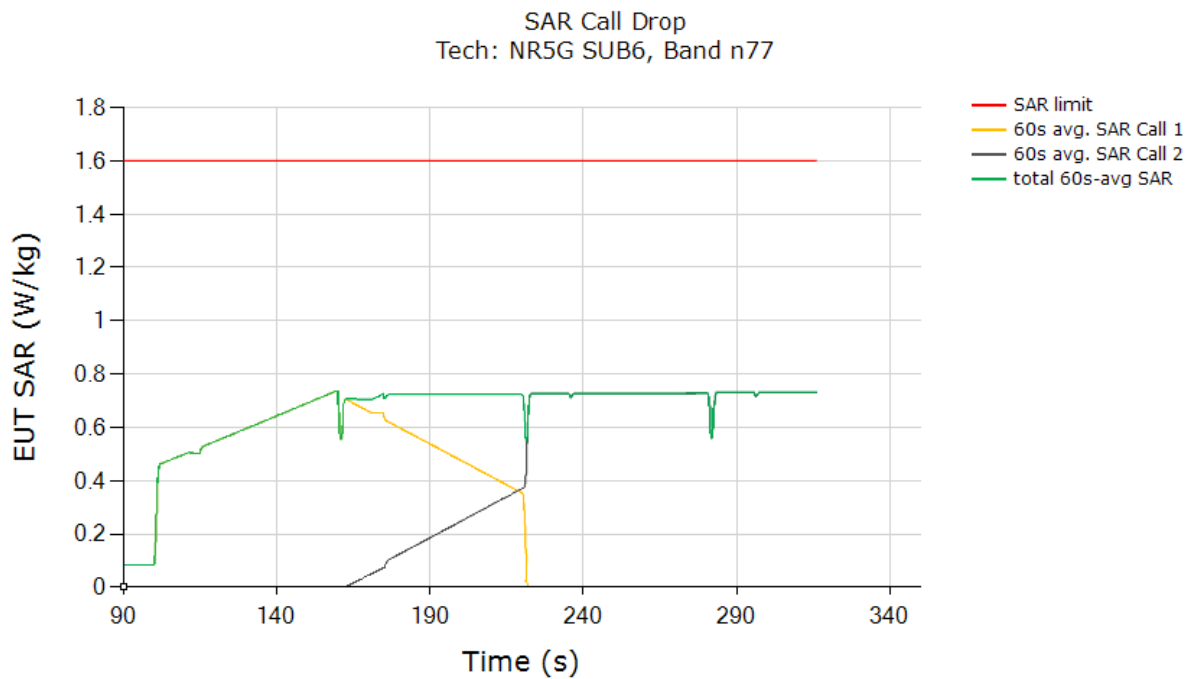

FCC 1g SAR Limit [W/kg]	1.6 W/kg
Max 100s-time averaged 1g SAR (green curve)	0.738 W/kg
Validated: Max time averaged SAR (green curve) is within 1dB device uncertainty of measured SAR at <i>P_{limit}</i> (last column in Table 7-2).	

The test result validated the continuity of power limiting in call change scenario.

8.5 Change in technology/band test results (test case 7 in Table 7-2)

This test was conducted with callbox requesting maximum power, and with technology switch from LTE B7, DSI = 1 (Grip Sensor) to UMTS B5, DSI =1 (Grip Sensor). Following procedure detailed in Section 5.3.3, and using the measurement setup shown in Figure 8-1(a) the technology/band switch was performed when the EUT is transmitting at *Preserve* level as shown in the plot below (dotted black region).

Conducted Plot No. 7

Test result for change in technology/band:

As per Part 1 report, *Reserve_power_margin* = 3dB. Based on Table 7-1, EFS *Plimit* = 11.5 dBm for LTE B7 (DSI=1), and EFS *Plimit* = 16.0 dBm for UMTS B5 (DSI=1), it can be seen from above plot that the difference in *Preserve* (= *Plimit* – 3dB *Reserve_power_margin*) power level corresponds to the expected difference in *Plimit* levels of 1 dB (within 1dB of sub6 radio design related uncertainty).

All the time-averaged conducted Tx power measurement results were converted into time- averaged normalized SAR values using Equation (6a), (6b) and (6c), and plotted below to demonstrate that the time-averaged normalized SAR versus time does not exceed the normalized FCC limit of 1.0:

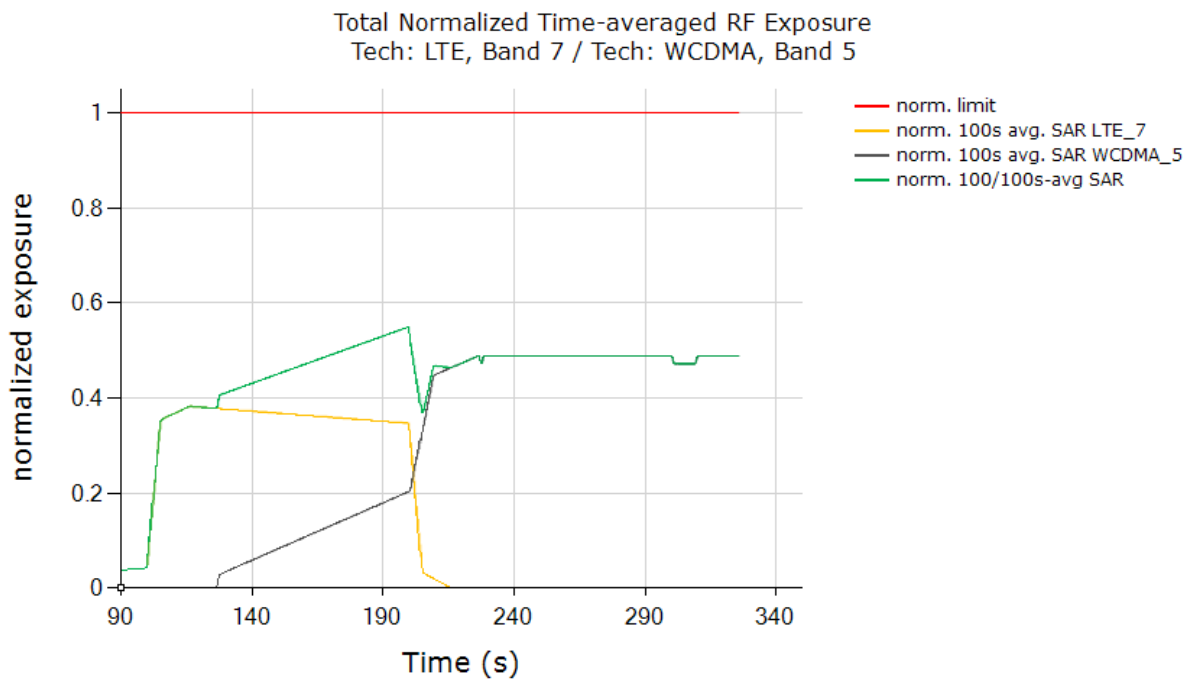

FCC normalized SAR limit	1.0
Max 100s-time averaged normalized SAR (green curve)	0.550
Validated:	

The test result validated the continuity of power limiting in technology/band switch scenario.

8.6 Change in DSI test results (test case 8 in Table 7-2)

This test was conducted with callbox requesting maximum power, and with DSI switch from NR n77 DSI = 1 (Grip on) to DSI = 0 (Grip Off, Free space). Following procedure detailed in Section 5.3.5 using the measurement setup shown in Figure 8-1(a) and (c), the DSI switch was performed when the EUT is transmitting at $P_{reserve}$ level as shown in the plot below (dotted black circle).

Conducted Plot No.8

Test result for change in DSI:

As per the manufacturer, $Reserve_power_margin = 3dB$. Based on Table 8-1, $EFS\ Plimit = 10.0\ dBm$ for NR n77, Grip Sensor DSI = 1, and $EFS\ Plimit = 23.0\ dBm$ (Apply MPR=1) for Free space DSI = 0. The difference in $P_{reserve} (= Plimit - 3dB\ Reserve_power_margin)$ level corresponds to the expected different in $Plimit$ levels of 3.0 dB (within 1dB of sub6 radio design related uncertainty).

All the time-averaged conducted Tx power measurement results were converted into time-averaged normalized SAR values using Equation (6a), (6b) and (6c), and plotted below to demonstrate that the time-averaged normalized SAR versus time does not exceed the FCC limit of 1 unit.

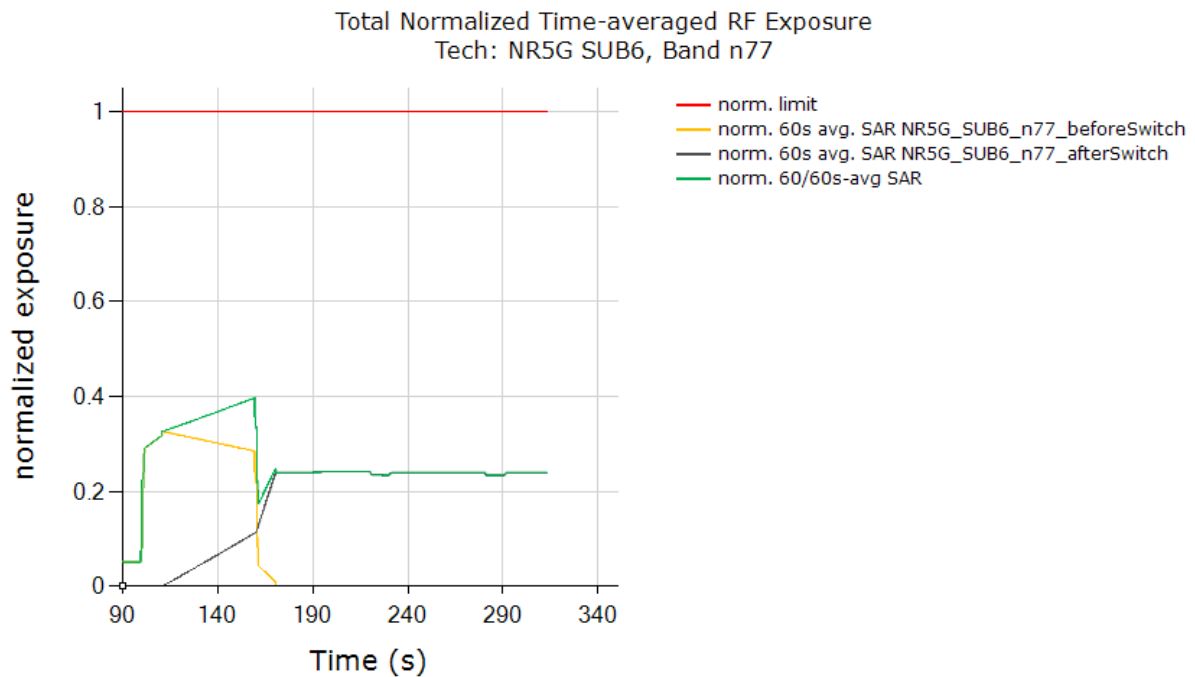

FCC normalized SAR limit	1.0
Max 60s-time averaged normalized SAR (green curve)	0.397
Validated:	

The test result validated the continuity of power limiting in DSI switch scenario.

8.7.1 Change in antenna switch test results (test case 9 in Table 7-2)

This test was conducted with callbox requesting maximum power, and with antenna switch between NR Band n77, Main2, DSI = 1(60s window) and NR Band n41, Main 1, DSI = 1(100s window). Following procedure detailed in Section 5.3.4 using the measurement setup shown in Figure 8-1(a) and (c), the antenna switch was performed when the EUT is transmitting at *Preserve* level as shown in the plot below (dotted black circle).

Conducted Plot No.9

Test result for change in Antenna:

All the conducted Tx power measurement results were converted into time-averaged normalized SAR values using Equation (7a),(7b)and (7c), and plotted below to demonstrate that the time-averaged normalized SAR versus time does not exceed the FCC limit of 1 unit. Equation (7a) is used to convert the Tx power of device to obtain 100s-averaged normalized SAR in NR Band n41 as shown in black curve. Similarly, equation (7b) is used to obtain 60s-averaged SAR in NR Band n77 as shown in orange curve. Equation (7c) is used to obtain total time-averaged normalized SAR as shown in green curve (i.e., sum of black and orange curves).

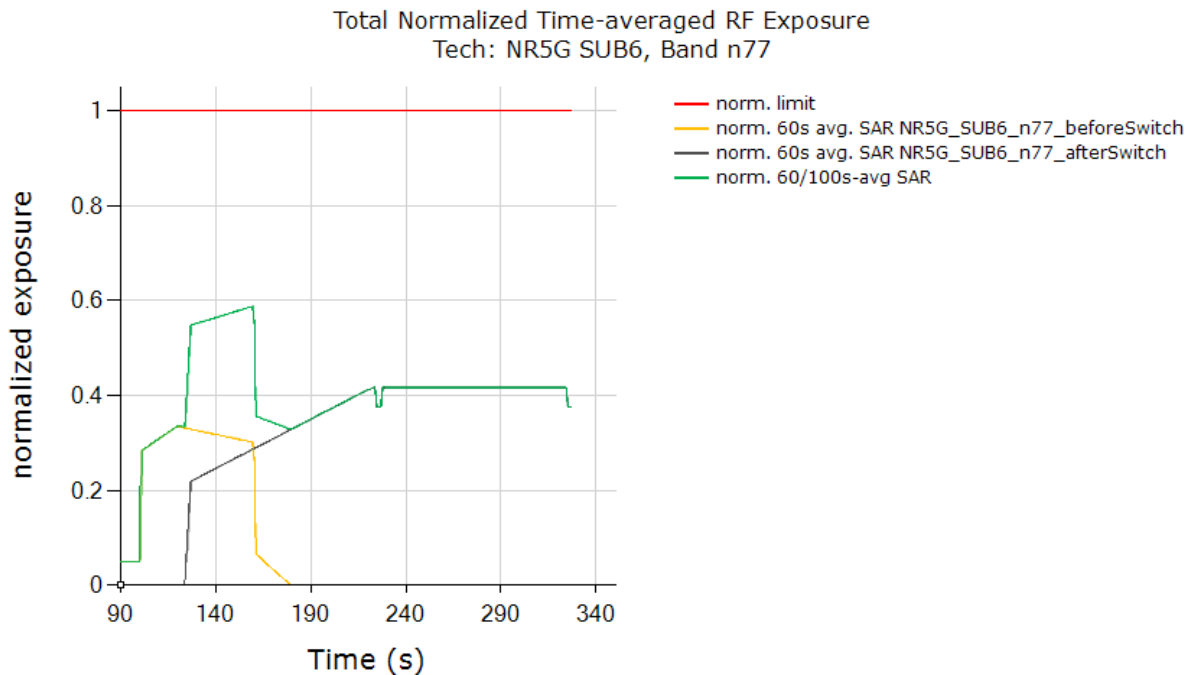

FCC normalized SAR limit	1.0
Max 60s-time averaged normalized SAR (green curve)	0.588
Validated:	

The test result validated the continuity of power limiting in antenna switch scenario.

8.7.2 Change in Time window switch test results (test case 10 in Table 7-2)

This test was conducted with callbox requesting maximum power, and with antenna switch between NR Band n77, Main2, DSI = 1(60s window) and NR Band n41, Main 1, DSI = 1(100s window). Following procedure detailed in Section 5.3.6 using the measurement setup shown in Figure 8-1(a) and (c), the antenna switch was performed when the EUT is transmitting at *Preserve* level as shown in the plot below (dotted black circle).

Conducted Plot No.10-1

Test result for Time window switch (from 100s to 60s to 100s) :

All the conducted Tx power measurement results were converted into time-averaged normalized SAR values using Equation (7a),(7b)and (7c), and plotted below to demonstrate that the time-averaged normalized SAR versus time does not exceed the FCC limit of 1 unit. Equation (7a) is used to convert the Tx power of device to obtain 100s-averaged normalized SAR in NR Band n41 as shown in black curve. Similarly, equation (7b) is used to obtain 60s-averaged SAR in NR Band n77 as shown in orange curve. Equation (7c) is used to obtain total time-averaged normalized SAR as shown in green curve (i.e., sum of black and orange curves).

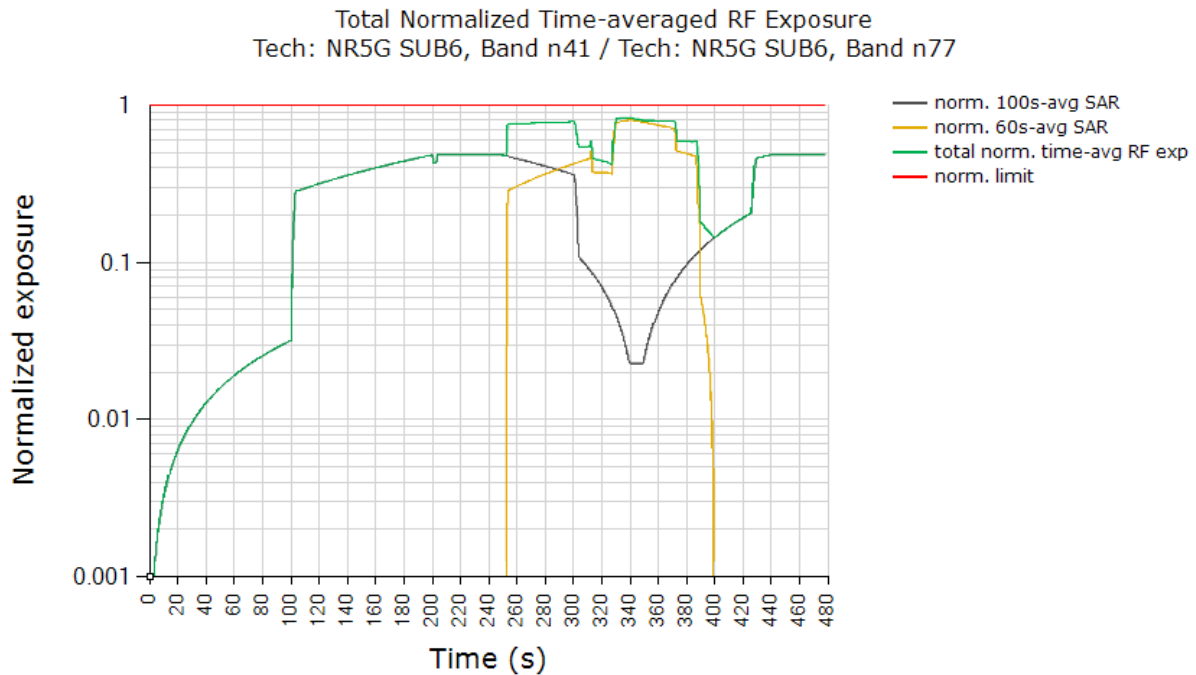

FCC normalized SAR limit	1.0
Max 60s-time averaged normalized SAR (green curve)	0.827
Validated:	

The test result validated the continuity of power limiting in time window switch scenario.

Conducted Plot No.10-2

Test result for Time window switch (from 60s to 100s to 60s) :

All the conducted Tx power measurement results were converted into time-averaged normalized SAR values using Equation (7a),(7b)and (7c), and plotted below to demonstrate that the time-averaged normalized SAR versus time does not exceed the FCC limit of 1 unit. Equation (7a) is used to convert the Tx power of device to obtain 60s-averaged normalized SAR in NR Band n77 as shown in black curve. Similarly, equation (7b) is used to obtain 100s-averaged SAR in NR Band n41 as shown in orange curve. Equation (7c) is used to obtain total time-averaged normalized SAR as shown in green curve (i.e., sum of black and orange curves).

Total Normalized Time-averaged RF Exposure
 Tech: NR5G SUB6, Band n77 / Tech: NR5G SUB6, Band n41

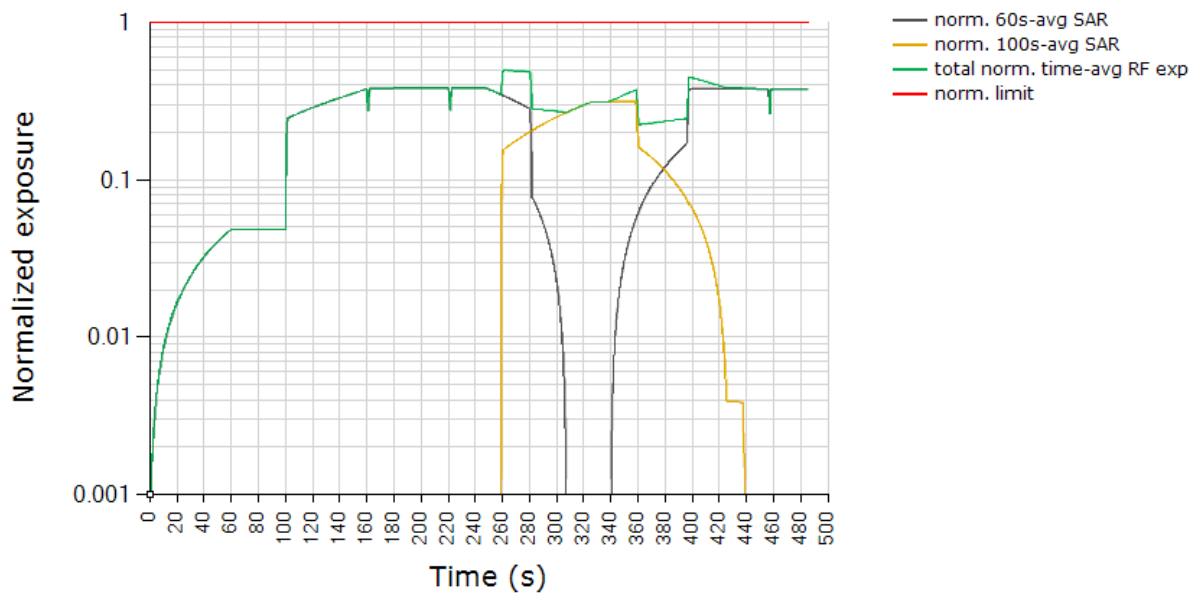

FCC normalized SAR limit	1.0
Max 60s-time averaged normalized SAR (green curve)	0.496
Validated:	

The test result validated the continuity of power limiting in time window switch scenario.

8.8 Switch in SAR exposure test results (test case 11 in Table 7-2)

This test was conducted with callbox requesting maximum power, and with the EUT in LTE B5 + Sub6 NR Band n7 call. Here, LTE B5, DSI = 1 (100s window, EFS P_{limit} = 15.0 dBm, P_{max} = 24.0 dBm, measured P_{limit} = 14.80 dBm), and Sub6 NR Band n7, DSI = 1 (100s window, P_{limit} = 11.5 dBm in EFS setting, EUT's average P_{max} = 24.0 dBm, measured P_{limit} = 11.83 dBm). Following procedure detailed in Section 5.3.7 and Appendix B.2, and using the measurement setup shown in Figure 6-1(c) since LTE and Sub6 NR are sharing the same antenna port. The SAR exposure switch measurement is performed with the EUT in various SAR exposure scenarios, i.e., in SARsub6NR only scenario (t =10s ~125s), SARsu6NR + SARLTE scenario (t =125s ~ 245s) and SARLTE only scenario (t > 245s).

Conducted Plot No.11

Plot note: All the conducted Tx power measurement results were converted into time-averaged normalized SAR values using Equation (7a), (7b) and (7c), and plotted below to demonstrate that the time-averaged normalized SAR versus time does not exceed the FCC limit of 1 unit. Equation (7a) is used to convert the LTE Tx power of device to obtain 100s-averaged normalized SAR in LTE B5 as shown in black curve. Similarly, equation (7b) is used to obtain 100s-averaged normalized SAR in Sub6 NR n7 as shown in orange curve. Equation (7c) is used to obtain total time-averaged normalized SAR as shown in green curve (i.e., sum of black and orange curves).

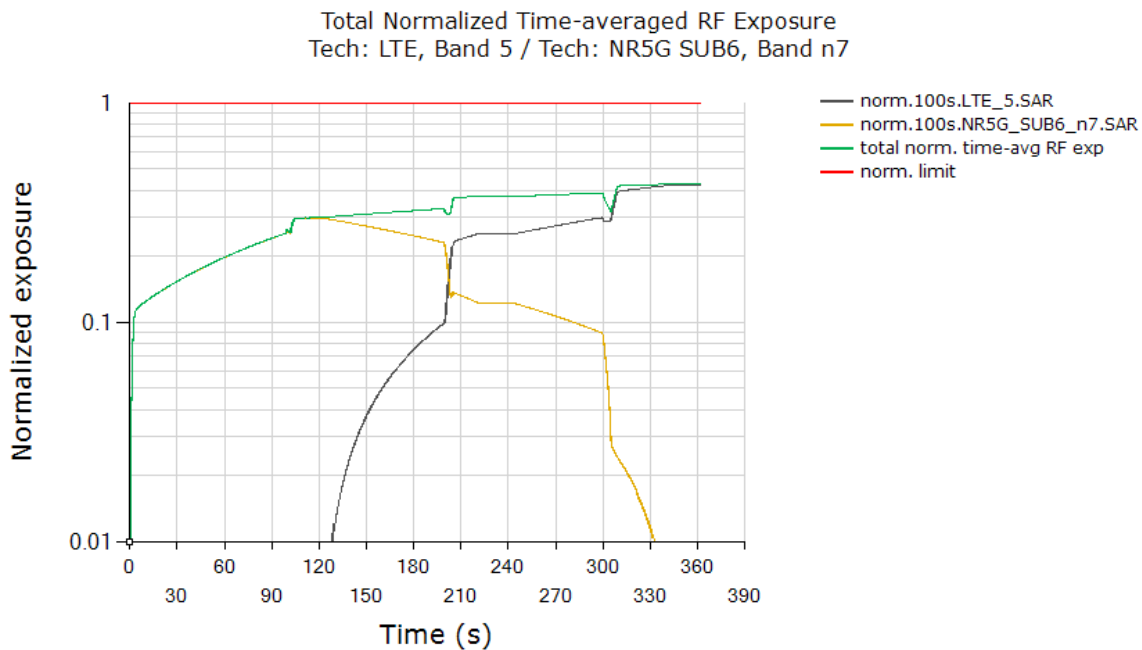

FCC normalized total exposure limit	1.0
Max Norm. Total time-avg. SAR (green curve) (green curve)	0.428
Validated:	

Plot Notes:

Device starts predominantly in Sub6 NR SAR exposure scenario between 5s and 125s, and in LTE SAR + Sub6 NR SAR exposure scenario between 125s and 245s, and in predominantly in LTE SAR exposure scenario after t=245s. Here, Smart Transmit allocates a maximum of 100% of exposure margin (based on 3dB reserve margin setting) for Sub6 NR. This corresponds to a normalized 1gSAR exposure value = $100\% * 0.453 \text{ W/kg measured SAR at Sub6 NR } P_{limit} / 1.6 \text{ W/kg limit} = 0.300 \pm 1 \text{ dB device related uncertainty}$ (see orange curve between 5s~125s). For predominantly LTE SAR exposure scenario, maximum normalized 1gSAR exposure should correspond to 100% exposure margin = $0.693 \text{ W/kg measured SAR at LTE } P_{limit} / 1.6 \text{ W/kg limit} = 0.424 \pm 1 \text{ dB device related uncertainty}$ (see black curve after t = 245s).

Additionally, in SAR exposure switch test, at all times the total time-averaged normalized RF exposure (green curve) should not exceed normalized SAR_design_target + 1dB device uncertainty. In this test, with a maximum normalized SAR of 0.428 being $\leq 0.794 (= 1/1.6 + 1 \text{ dB device uncertainty})$, the above test result validated the continuity of power limiting in SAR exposure switch scenario.

9. Radiated Power Test Results for mmW Smart Transmit Feature Validation

9.1 Measurement Setup

The Keysight Technologies E7515B UXM callbox is used in this test. The test setup is shown in Figure 8-1a and the schematic of the setup is shown in Figure 8-1b (see Appendix C : Test setup photo-6 for PD). The UXM callbox has two RF radio heads to up/down convert IF to mmW frequencies, which in turn are connected to two horn antennas for V- and H-polarizations for downlink communication. In the uplink, a directional coupler is used in the path of one of the horn antennas to measure and record radiated power using a Rohde & Schwarz NR40S power sensor and NRP2 power meter. Note here that the isolation of the directional coupler may not be sufficient to attenuate the downlink signal from the callbox, which will result in high noise floor masking the recording of radiated power from EUT. In that case, either lower the downlink signal strength emanating from the RF radio heads of callbox or add an attenuator between callbox radio heads and directional coupler. Additionally, note that since the measurements performed in this validation are all relative, measurement of EUT's radiated power in one polarization is sufficient. The EUT is placed inside an anechoic chamber with V- and H-pol horn antennas to establish the radio link as shown in Figure 9-1. The callbox's LTE port is directly connected to the EUT's RF port via a directional coupler to measure the EUT's conducted Tx power using a Rohde & Schwarz NR8S power sensor and NRP2 power meter. Additionally, EUT is connected to the PC via USB connection for sending beam switch command. Care is taken to route the USB cable and RF cable (for LTE connection) away from the EUT's mmW antenna modules.

Setup in Figure 9-1 is used for the test scenario 1, 4 and 5 described in Section 4. The test procedures described in Section 6 are followed. The path losses from the EUT to both the power meters are calibrated and used as offset in the power meter.

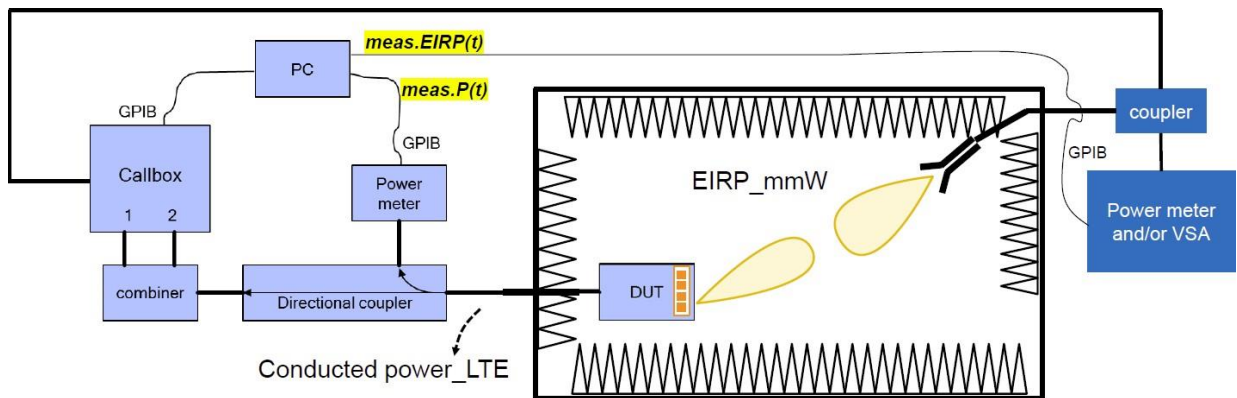

Figure 9-1: mmW NR radiated power measurement setup (see Appendix C for missing figures)

Both the callbox and power meters are connected to the PC using USB cables. Test scripts are custom made for automation of establishing LTE + mmW call, conducted Tx power recording for LTE and radiated Tx power recording for mmW. These tests are manually stopped after desired time duration. Test script is programmed to set LTE Tx power to all-down bits on the callbox immediately after the mmW link is established, and programmed to set toggle between all-up and all-down bits depending on the transmission scenario being evaluated. Similarly, test script is also programmed to send beam switch command manually to the EUT via USB connection. For all the tests, the callbox is set to request maximum Tx power in mmW NR radio from EUT all the time.

Test configurations for this validation are detailed in Section 7.2. Test procedures are listed in Section 6.3.

9.2 mmW NR radiated power test results

To demonstrate the compliance, the conducted Tx power of LTE B2 in DSI = 1 (Grip On mode) is converted to 1g SAR exposure by applying the corresponding worst-case 1gSAR value at P_{limit} as reported in Part 1 report and listed in Table 7-2 of this report.

Similarly, following Step 4 in Section 6.3.1, radiated Tx power of mmW Band n261 for the beams tested is converted by applying the corresponding worst-case 4cm²PD values measured in HCT lab, and listed in below Table 9-1. Qualcomm Smart Transmit feature operates based on time-averaged Tx power reported on a per symbol basis, which is independent of modulation, channel and bandwidth (RBs), therefore the worst-case 4cm²PD was conducted with the EUT in FTM mode, with CW modulation and 100% duty cycle. cDASY6 system verification for power density measurement is provided in Appendix C, and the associated SPEAG certificates are attached in Appendix D.

Both the worst-case 1gSAR and 4cm²PD values used in this section are listed in Table 9-1. The measured EIRP at *input.power.limit* for the beams tested in this section are also listed in Table 9-1

Table 9-1: Worst-case 1gSAR, 4cm² avg. PD and EIRP measured at *input.power.limit* for the selected configurations

Tech	Band	Antenna	Beam ID	input.power.limit (dBm)	meas. 4cm ² PD		meas. EIRP at input.power.limit (dBm)
					at	Configuration	
					input.power.limit (W/m ²)		
mmW NR	n261	K	154	1.1	7.01	Front	17.55
		K	134	7.6	5.58	Front	11.69

Tech	Band	Antenna	DSI	meas. Plimit (dBm)	Measured 1g SAR at Plimit	
					at Plimit (W/kg)	Configuration
LTE	B2(25)	Main 1	1	15.08	0.868	Grip On,0mm

The 4cm²PD psPD distributions for the PD value per band, as listed in Table 9-1 are plotted below.

Figure 9-1: 4cm² psPD distribution measured at input.power.limit of 1.1 dBm on the front for n261 Beam 154.

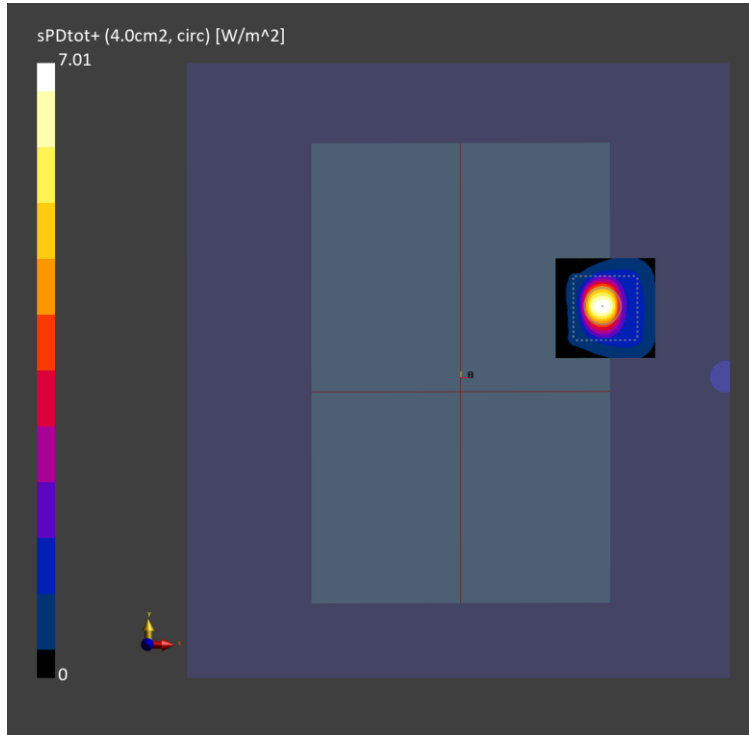
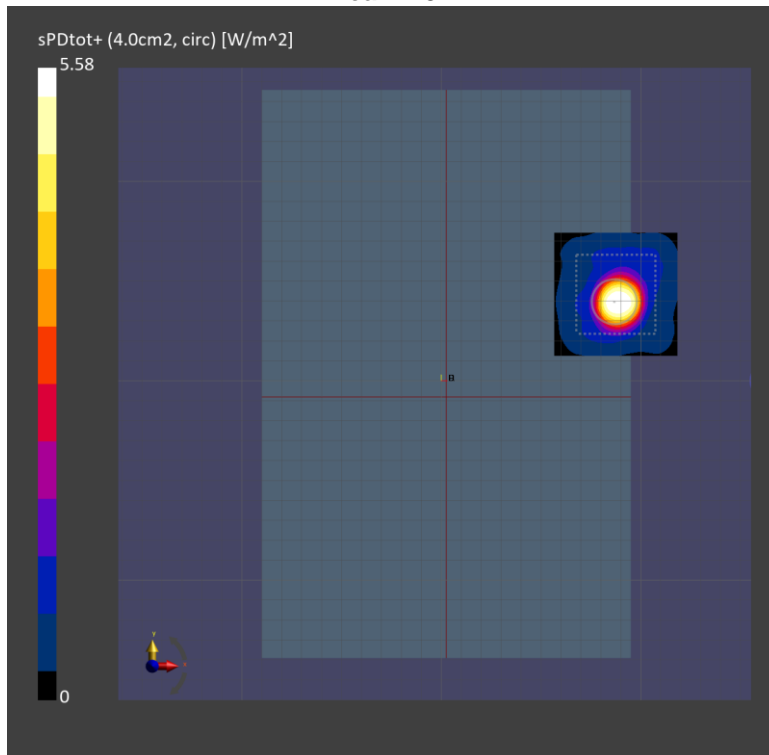

Figure 9-2: 4cm² psPD distribution measured at input.power.limit of 7.6 dBm on the front for n261 Beam 134.



9.2.1 Maximum Tx power test results for n261(test case 12 in table 7-3)

This test was measured with LTE B2 (DSI = 1) and mmW Band n261 Beam ID 154 by following the detailed test procedure described in Section 6.3.1.

Time-averaged conducted Tx power for LTE B2 and radiated Tx power for mmW NR n261 beam 154 are converted into time-averaged 1g SAR and time-averaged 4cm²PD using Equation (2a) and (2b), which are divided by FCC 1g SAR limit of 1.6 W/kg and 4cm²PD limit of 10 W/m², respectively, to obtain normalized exposures versus time. Below plot shows (a) normalized time-averaged 1gSAR versus time, (b) normalized time-averaged 4cm²-avg.PD versus time, (c) sum of normalized time-averaged 1g SAR and normalized time-averaged 4cm²- avg.PD:

Plot No. 12

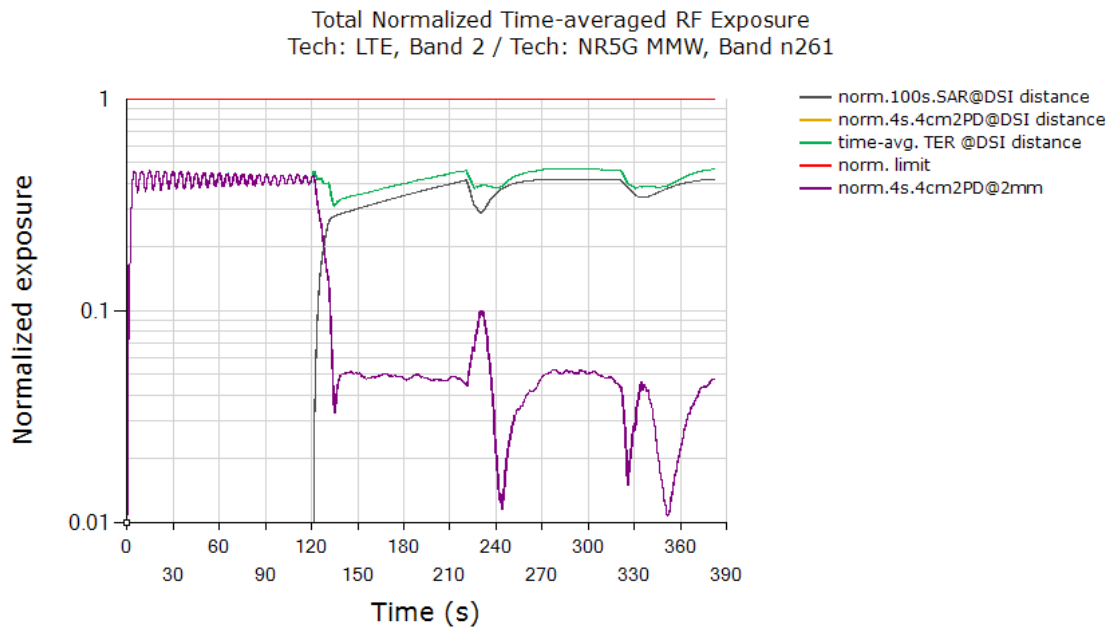

FCC requirement for total RF exposure (normalized)	1.0
Max total normalized time-averaged RF exposure (green curve)	0.468
Validated	

Plot notes:

As soon as 5G mmW NR call was established, LTE was placed in all-down bits immediately. Between 0s~120s, mmW exposure is the dominant contributor. Here, Smart Transmit feature allocates a maximum of 100% for mmW (based on the 3dB reserve setting in Part 1 report). From Table 9-1, this corresponds to a normalized 4cm²PD exposure value for Beam ID 154 of $(100\% * 7.01 \text{ W/m}^2)/(10 \text{ W/m}^2) = 70.1\% \pm 2.0\text{dB}$ device related uncertainty. At ~120s time mark, LTE is set to all-up bits, taking away margin from mmW exposure gradually. Towards the end of test, LTE is the dominant contributor towards RF exposure, i.e., corresponding normalized 1gSAR exposure value of $(100\% * 0.868 \text{ W/kg})/(1.6 \text{ W/kg}) = 54.25\% \pm 1\text{dB}$ design related uncertainty.

As can be seen, the power limiting enforcement is effective and the total normalized time- averaged RF exposure does not exceed 1.0. Therefore, Qualcomm® Smart Transmit time averaging feature is validated.

9.2.2 Switch in SAR vs. PD test results for n261(Test case13 in table 7-3)

This test was measured with LTE Band 2 (DSI =1) and mmW Band n261 Beam ID 154, by following the detailed test procedure is described in Section 6.3.2

Normalized time-averaged exposures for LTE (1gSAR) and mmW (4cm2PD), as well as total normalized time-averaged exposure versus time:

Plot No. 13

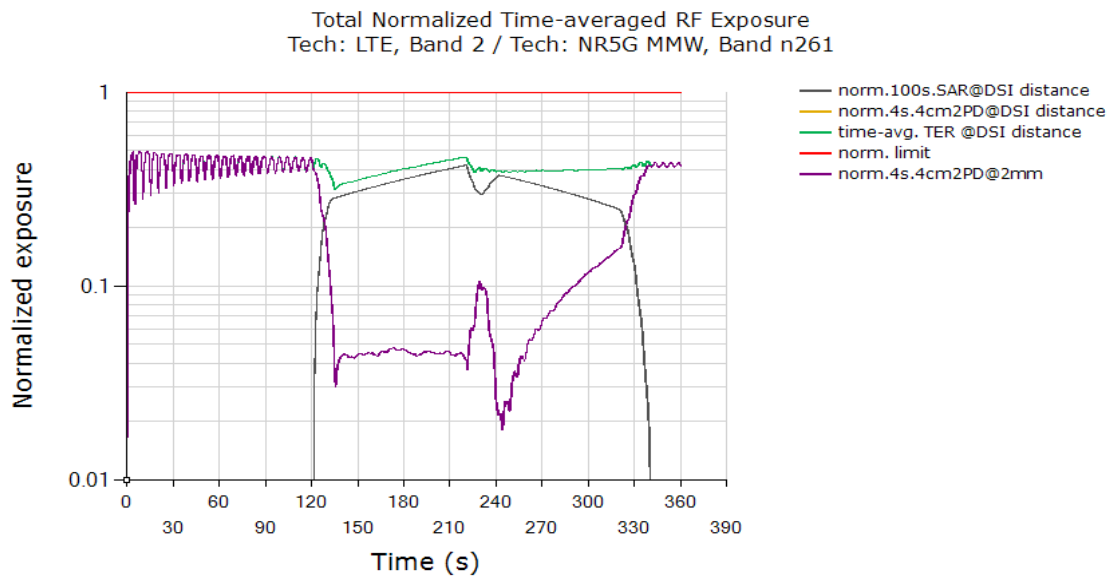

FCC requirement for total RF exposure (normalized)	1.0
Max total normalized time-averaged RF exposure (green curve)	0.498
Validated	

Plot notes:

As soon as 5G mmW NR call was established, LTE was placed in all-down bits immediately. Between 0s~120s, mmW exposure is the dominant contributor. Here, Smart Transmit feature allocates a maximum of 100% for mmW (based on 3dB reserve setting in Part 1 report). From Table 9-1, this corresponds to a normalized 4cm²PD exposure value for Beam ID 154 of $(100\% * 7.01 \text{ W/m}^2)/(10 \text{ W/m}^2) = 70.1\% \pm 2.0\text{dB}$ device related uncertainty. At ~120s time mark, LTE is set to all-up bits, taking away margin from mmW exposure gradually. At ~240s time mark, LTE is set to all-down bits, which results in mmW getting back RF margin slowly as seen by gradual increase in mmW exposure.

The calculated maximum RF exposure from LTE corresponds to normalized 1g SAR exposure value of $(100\% * 0.868 \text{ W/kg})/(1.6 \text{ W/kg}) = 54.25\% \pm 1\text{dB}$ design related uncertainty (note that this level will be achieved by green and black curves if LTE remains in all-up bits for longer time duration which was already demonstrated in maximum Tx power test in Section 10.2.1). Total normalized time-averaged exposure (green curve) for this test should be within the calculated range between 70.1 % \pm 2.0dB device related uncertainty (only PD exposure) and 54.25% \pm 1dB design related uncertainty (only SAR exposure).

As can be seen, the power limiting enforcement is effective during transmission when SAR and PD exposures are switched, and the total normalized time-averaged RF exposure does not exceed 1.0. Therefore, Qualcomm® Smart Transmit time averaging feature is validated.

9.2.3 Change in Beam test results for n261(Test case 14 in table 7-3)

This test was measured with LTE Band 2 (DSI = 1) and mmW Band n261, with beam switch from Beam ID 154 to Beam ID 134 by following the test procedure is described in Section 6.3.3.

Normalized time-averaged exposures for LTE and mmW (4cm2PD), as well as total normalized time-averaged exposure versus time:

Plot No. 14

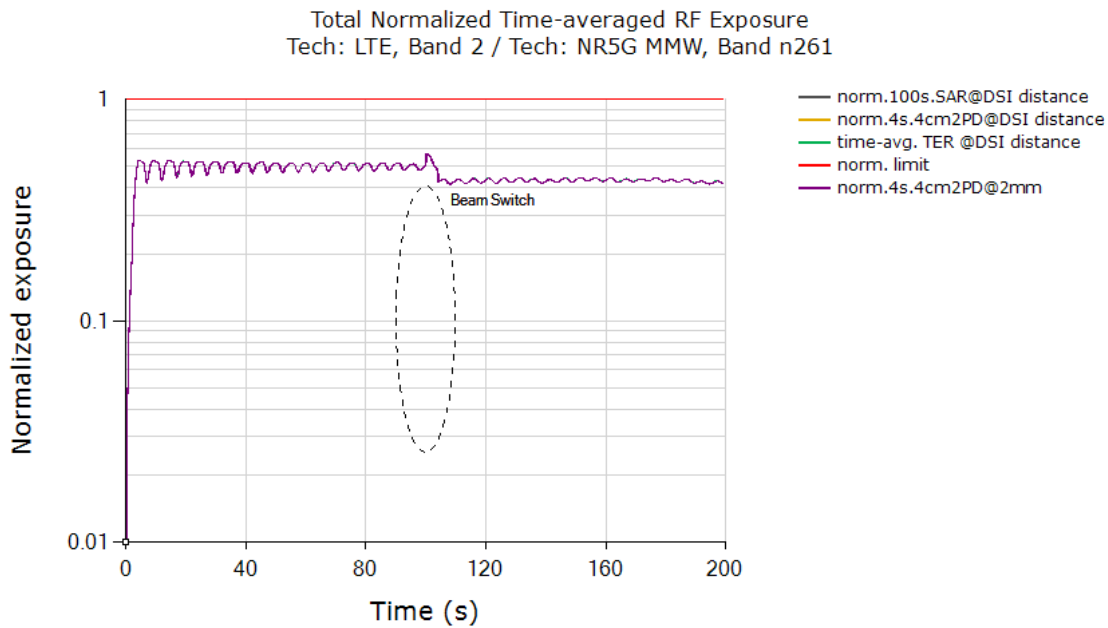

FCC requirement for total RF exposure (normalized)	1.0
Max total normalized time-averaged RF exposure (green curve)	0.662
Validated	

Plot notes:

5G mmW NR call was established at ~1s time mark and LTE was placed in all-down bits immediately after 5G mmW NR call was established. For the rest of this test, mmW exposure is the dominant contributor as LTE is left in all-down bits. Here, Smart Transmit feature allocates a maximum of 1.0 for mmW (based on 3dB reserve setting in Part 1 report). From Table 9-1, exposure between 1s ~100s corresponds to a normalized 4cm2PD exposure value for Beam ID 154 of $(7.01 \text{ W/m}^2)/(10 \text{ W/m}^2) = 70.1\% \pm 2.0\text{dB}$ device related uncertainty. At ~100s time mark (shown in black dotted ellipse), beam was switched to Beam ID 154. From table 9-1, exposure between 100s ~200s corresponds to a normalized 4cm2PD exposure value for Beam ID 134 $(5.58 \text{ W/m}^2)/(10 \text{ W/m}^2) = 55.8\% \pm 2.0\text{dB}$ device related uncertainty.

Additionally, during the switch, the ratio between the averaged radiated powers of the two beams (yellow curve) should correspond to the difference in EIRPs measured at each corresponding input.power.limit for these beams listed in Table 9-1.

10. Equipment List

Manufacturer	Type / Model	S/N	Calib. Date	Calib.Interval	Calib.Due
KEYSIGHT	UXM 5G Wireless Test Set/E7515B	MY60101105	05/31/2022	Annual	05/31/2023
KEYSIGHT	mmWave Transceiver/M1740A	MY59292349	09/27/2022	Annual	09/27/2023
R&S	Power Sensor/NRP8S	108076	02/27/2023	Annual	02/27/2024
R&S	Power Sensor/NRP40S	101278	02/27/2023	Annual	02/27/2024
Narda	Directional Coupler/4226-10	03096	02/27/2023	Annual	02/27/2024
Narda	Directional Coupler/PE2CP1126-6	1918	02/27/2023	Annual	02/27/2024
R&S	Wireless Communication Test Set/ CMW500	167918	03/23/2023	Annual	03/23/2024
Anritsu	Radio communication analyzer/MT8821C	6262287674	04/25/2023	Annual	04/25/2024
Anritsu	Radio communication test station/MT000A	6261967108	04/25/2023	Annual	04/25/2024
R&S	Power Sensor/NRP8S	109996	11/29/2022	Annual	11/29/2023
R&S	Power Sensor/NRP50S	101351	11/30/2022	Annual	11/30/2023
Narda	Directional Coupler/4216-10	01490	11/29/2022	Annual	11/29/2023
Narda	Directional Coupler/4216-10	01489	11/29/2022	Annual	11/29/2023
Mini-Circuits	Power Splitter/ZN2PD2-63-S+	UU95102009	03/28/2023	Annual	03/28/2024
Microlab	LP-Filter/LA-30N	-	09/27/2022	Annual	09/27/2023
WEINWRIGHT INSTRUMENTS	High Pass Filter/WHKX12-935	95	02/23/2023	Annual	02/23/2024

11. Measurement Uncertainties

Measurement Uncertainty for CDASY6 mmWave module						
a	b	c	d	e	$f = b \times e / d$	g
Source of uncertainty	Uncertainty Value	Probability distribution	Div.	ci	Standard Uncertainty	vi
	(± dB)					
Probe calibration	0.49	N	1	1	0.49	∞
Probe correction	0.00	R	1.73	1	0.00	∞
Frequency Response(BW ≤ 1GHz)	0.20	R	1.73	1	0.12	∞
Sensor cross coupling	0.00	R	1.73	1	0.00	∞
Istropy	0.50	R	1.73	1	0.29	∞
Linearity	0.20	R	1.73	1	0.12	∞
Probe scattering	0.00	R	1.73	1	0.00	∞
Probe positioning offset	0.30	R	1.73	1	0.17	∞
Probe positioning Repeatability	0.04	R	1.73	1	0.02	∞
Probe spatial Resolution	0.00	R	1.73	1	0.00	∞
Field Impedence Dependence	0.00	R	1.73	1	0.00	∞
Sensor Mechanical Offset	0.00	R	1.73	1	0.00	∞
Amplitude and Phase drift	0.00	R	1.73	1	0.00	∞
Amplitude and Phase noise	0.04	R	1.73	1	0.02	∞
Measurement area truncation	0.00	R	1.73	1	0.00	∞
System Detection Limit	0.04	R	1.73	1	0.02	∞
Data acquisition	0.03	N	1	1	0.03	∞
Field Reconstruction	0.60	R	1.73	1	0.35	∞
Forward Transformation	0.00	R	1.73	1	0.00	∞
Power density Scailing	0.00	R	1.73	1	0.00	∞
Spatial Averaging	0.10	R	1.73	1	0.06	∞
Test sample and Environmental Factors						
Probe coupling with DUT	0.00	R	1.73	1	0.00	∞
Modulation Response	0.40	R	1.73	1	0.23	∞
Integration time	0.00	R	1.73	1	0.00	∞
Response time	0.00	R	1.73	1	0.00	∞
Device holder influence	0.10	R	1.73	1	0.06	∞
DUT alignment	0.00	R	1.73	1	0.00	∞
RF Ambient Conditions	0.04	R	1.73	1	0.02	∞
RF ambient - reflections	0.04	R	1.73	1	0.02	∞
Immunity/Secondary Reception	0.00	R	1.73	1	0.00	∞
Power Drif of DUT	0.22	R	1.73	1	0.13	∞
Combined standard uncertainty (k = 1)		RSS			0.76	∞
Expanded uncertainty (95% confidence level)		k = 2			1.52	

12. Conclusion

Qualcomm Smart Transmit feature employed in Samsung Portable Tablet (FCC ID: A3LSMX818U) has been validated through the conducted/radiated power measurement (as demonstrated in Chapters 8 and 9)

As demonstrated in this report, the power limiting enforcement is effective and the total normalized time-averaged RF exposure does not exceed 1.0 for all the transmission scenarios described in Section 4.

Therefore, the EUT complies with FCC RF exposure requirement.

Appendix A: Test Sequences

1. Test sequence is generated based on below parameters of the EUT:

- a. Measured maximum power (P_{max})
- b. Measured Tx_power_at_SAR_design_target (P_{limit})
- c. Reserve_power_margin (dB)

$P_{reserve} \text{ (dBm)} = \text{measured } P_{limit} \text{ (dBm)} - \text{Reserve_power_margin (dB)}$
- d. SAR_time_window (100s for FCC)

2. Test Sequence 1 Waveform:

Based on the parameters above, the Test Sequence 1 is generated with one transition between high and low Tx powers. Here, high power = P_{max} ; low power = $P_{max}/2$, and the transition occurs after 80 seconds at high power P_{max} . As long as the power enforcement is taking into effective during one 100s/60s time window, the validation test with this defined test sequence 1 is valid, otherwise, select other radio configuration (band/DSI within the same technology group) having lower P_{limit} for this test. The Test sequence 1 waveform is shown below:

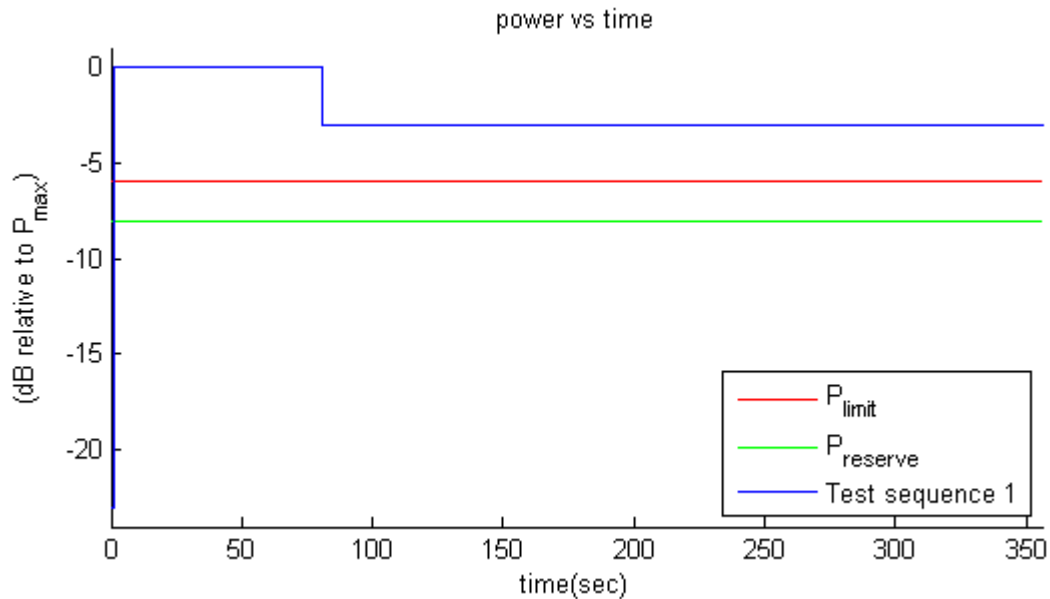

Figure 1 Test sequence 1 waveform

3. Test Sequence 2 Waveform:

Based on the parameters in A-1, the Test Sequence 2 is generated as described in Table A-1, which contains two 170 second-long sequences (yellow and green highlighted rows) that are mirrored around the center row of 20s, resulting in a total duration of 360 seconds:

Table -1 Test Sequence 2

Time duration (seconds)	dB relative to P_{limit} or $P_{reserve}$
15	$P_{reserve} - 2$
20	P_{limit}
20	$(P_{limit} + P_{max})/2$ averaged in mW and rounded to nearest 0.1 dB step
10	$P_{reserve} - 6$
20	P_{max}
15	P_{limit}
15	$P_{reserve} - 5$
20	P_{max}
10	$P_{reserve} - 3$
15	P_{limit}
10	$P_{reserve} - 4$
20	$(P_{limit} + P_{max})/2$ averaged in mW and rounded to nearest 0.1 dB step
10	$P_{reserve} - 4$
15	P_{limit}
10	$P_{reserve} - 3$
20	P_{max}
15	$P_{reserve} - 5$
15	P_{limit}
20	P_{max}
10	$P_{reserve} - 6$
20	$(P_{limit} + P_{max})/2$ averaged in mW and rounded to nearest 0.1 dB step
20	P_{limit}
15	$P_{reserve} - 2$

The Test Sequence 2 waveform is shown in Figure A-2

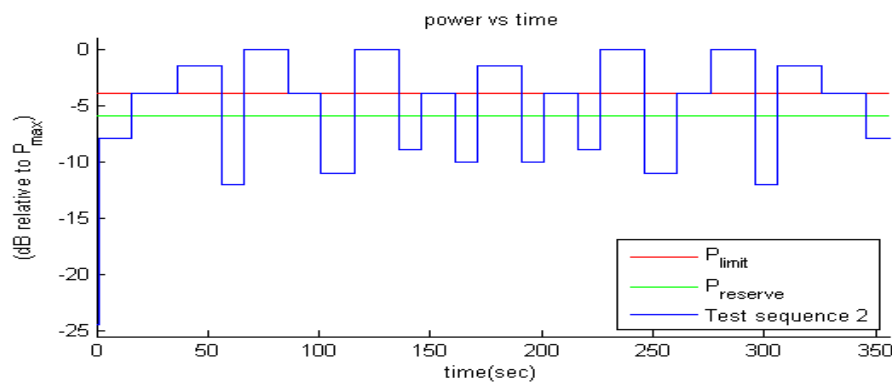

Appendix B: Test Procedures for sub6 NR + LTE Radio

Appendix B provides the test procedures for validating Qualcomm Smart Transmit feature for LTE + Sub6 NR non-standalone (NSA) mode transmission scenario, where sub-6GHz LTE link acts as an anchor.

B.1 Time-varying Tx power test for sub6 NR in NSA mode

Follows Section 5.2.1 to select test configurations for time-varying test. This test is performed with two pre-defined test sequences (described in Section 5.1) applied to Sub6 NR (with LTE on all-down bits or low power for the entire test after establishing the LTE+Sub6 NR call with the callbox). Follow the test procedures described in Section 5.3.1 to demonstrate the effectiveness of power limiting enforcement and that the time averaged Tx power of Sub6 NR when converted into 1gSAR values does not exceed the regulatory limit at all times (see Eq. (1a) and (1b)). Sub6 NR response to test sequence1 and test sequence2 will be similar to other technologies (say, LTE), and are shown in Sections 8.3.7 and 8.3.8.

B.2 Switch in SAR exposure between LTE vs. Sub6 NR during transmission

This test is to demonstrate that Smart Transmit feature accurately accounts for switching in exposures among SAR for LTE radio only, SAR from both LTE radio and sub6 NR, and SAR from sub6 NR only scenarios, and ensures total time-averaged RF exposure compliance with FCC limit.

Test procedure:

1. Measure conducted Tx power corresponding to P_{limit} for LTE and sub6 NR in selected band. Test condition to measure conducted P_{limit} is:

- Establish device in call with the callbox for LTE in desired band. Measure conducted Tx power corresponding to LTE P_{limit} with Smart Transmit enabled and *Reserve_power_margin* set to 0 dB, callbox set to request maximum power.
- Repeat above step to measure conducted Tx power corresponding to Sub6 NR P_{limit} . If testing LTE+Sub6 NR in non-standalone mode, then establish LTE+Sub6 NR call with callbox and request all down bits for radio1 LTE. In this scenario, with callbox requesting maximum power from Sub6 NR, measured conducted Tx power corresponds to radio2 P_{limit} (as radio1 LTE is at all-down bits)

2. Set *Reserve_power_margin* to actual (intended) value with EUT setup for LTE + Sub6 NR call. First, establish LTE connection in all-up bits with the callbox, and then Sub6 NR connection is added with callbox requesting UE to transmit at maximum power in Sub6 NR. As soon as the Sub6 NR connection is established, request all-down bits on LTE link (otherwise, Sub6 NR will not have sufficient RF exposure margin to sustain the call with LTE in all-up bits). Continue LTE (all-down bits)+Sub6 NR transmission for more than one time-window duration to test predominantly Sub6 NR SAR exposure scenario (as SAR exposure is negligible from all-down bits in LTE). After at least one time-window, request LTE to go all-up bits to test LTE SAR and Sub6 NR SAR exposure scenario. After at least one more time-window, drop (or request all-down bits) Sub6 NR transmission to test predominantly LTE SAR exposure scenario. Continue the test for at least one more time-window. Record the conducted Tx powers for both LTE and Sub6 NR for the entire duration of this test.

3. Once the measurement is done, extract instantaneous Tx power versus time for both LTE and Sub6 NR links. Similar to technology/band switch test in Section 5.3.3, convert the conducted Tx power for both these radios into 1gSAR value (see Eq. (6a) and (6b)) using corresponding technology/band P_{limit} measured in Step 1, and then perform 100s running average to determine time-averaged 1gSAR versus time as illustrated in Figure 3-1. Note that here it is assumed both radios have Tx frequencies < 3GHz, otherwise, 60s running average should be performed for radios having Tx frequency between 3GHz and 6GHz.

3-1. Note that here it is assumed both radios have Tx frequencies < 3GHz, otherwise, 60s running average should be performed for radios having Tx frequency between 3GHz and 6GHz.

4. Make one plot containing: (a) instantaneous Tx power versus time measured in Step 2.

5. Make another plot containing: (a) instantaneous 1gSAR versus time determined in Step 3, (b) computed time-averaged 1gSAR versus time determined in Step 3, and (c) corresponding regulatory $1gSAR_{limit}$ of 1.6W/kg. The validation criteria is, at all times, the time-averaged 1gSAR versus time shall not exceed the regulatory $1gSAR_{limit}$ of 1.6W/kg.

Test procedure for Conducted Test Sequences:

For Sub6 NR TDD test cases, a modified procedure was used due to a limitation of the available test equipment.

1. Measure Pmax, measure Plimit and calculate Preserve (= measured Plimit in dBm = Reserve_power_margin in dB) and follow Section 5.1 to generate the test sequences for all the technologies and bands selected in Section 5.2.1. Both test sequence 1 and test sequence 2 are created based on generated Pmax_sequences of the DUT as described below. Test condition to measure Pmax and Plimit is:

- 1) Measure Pmax_online_avg_dBm with Smart Transmit disabled and callbox set to request maximum power.
- 2) Measure Plimit_online_avg_dBm with Smart Transmit enabled and Reserve_power_margin set to 0 dB, callbox

set to request maximum power.

3) Measure $P_{\text{limit_ftm_dbm}}$ in FTM Mode at 25% Duty Cycle.

4) Calculate the $\text{DutyCycle_dB} = P_{\text{limit_ftm_dbm}} - P_{\text{limit_online_avg_dBm}} + 6 \text{ dB}$

5) Calculate $P_{\text{max_seq}} = P_{\text{max_online_avg_dBm}} + \text{DutyCycle_dB}$

6) Calculate $P_{\text{limit_seq}} = P_{\text{limit_online_avg_dBm}} + \text{DutyCycle_dB}$

2. Follow remaining steps in Section 5.3.1 to complete time-varying Tx test cases

For the SAR test cases, the procedure in Section 5.4 applies however the initial area scan as described in section 5.4 step 2) i) is performed with the device in FTM mode.