

# SETUP PHOTOS EXHIBIT

**Report Number:** R14720543-EP1

**Applicant :** Samsung Electronics Co., Ltd.  
129 Samsung-Ro, Yeongtong-Gu  
Suwon-Si, Gyeonggi-Do, 16677, Korea

**Model :** SM-X710

**FCC ID :** A3LSMX710

**IC :** 649E-SMX710

**EUT Description :** BT/BLE Tablet + DTS/UNII a/b/g/n/ac/ax and WPT

**Test Standard(s) :** FCC 47 CFR PART 15 SUBPART C, E: 2023  
ISED RSS-247 ISSUE 2: 2020  
ISED RSS-GEN ISSUE 5 + A1 + A2: 2021

**Date Of Issue:**

2023-05-18

**Prepared by:**

UL LLC

12 Laboratory Dr.

Research Triangle Park, NC 27709 U.S.A.

TEL: (919) 549-1400



## REVISION HISTORY

Rev.	Issue Date	Revisions	Revised By
V1	2023-05-18	Initial Issue	Charles Moody

## TABLE OF CONTENTS

REVISION HISTORY .....	2
TABLE OF CONTENTS .....	3
1. SETUP DIAGRAMS .....	4
2. SETUP PHOTOS.....	6
END OF REPORT .....	11

# 1. SETUP DIAGRAMS

Radiated:

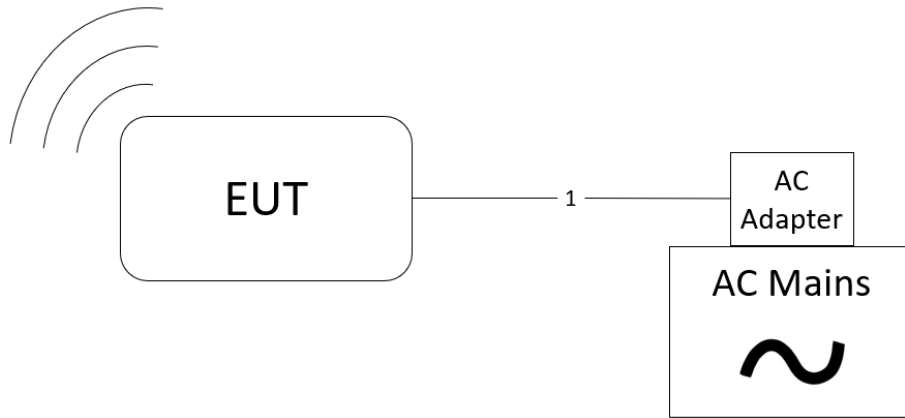

Dynamic Frequency Selection:

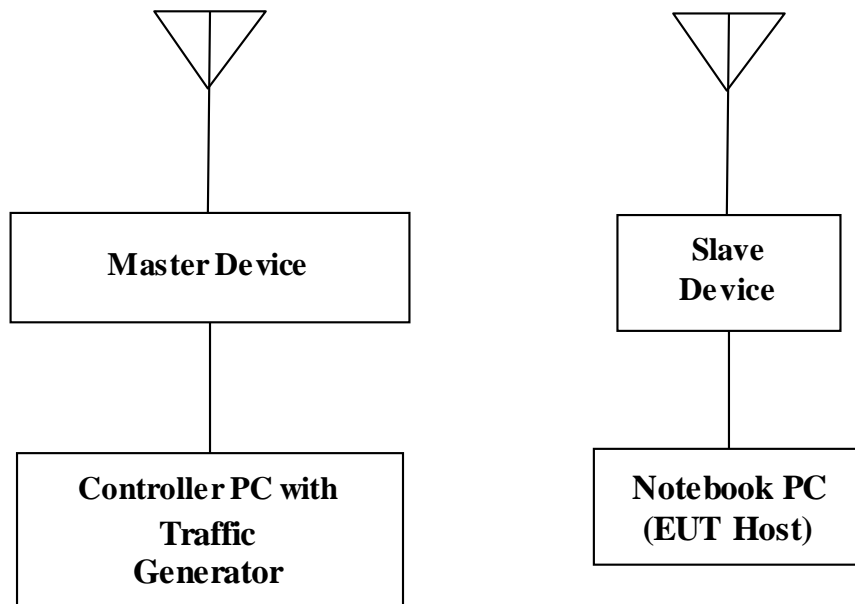

Contention Based Protocol:

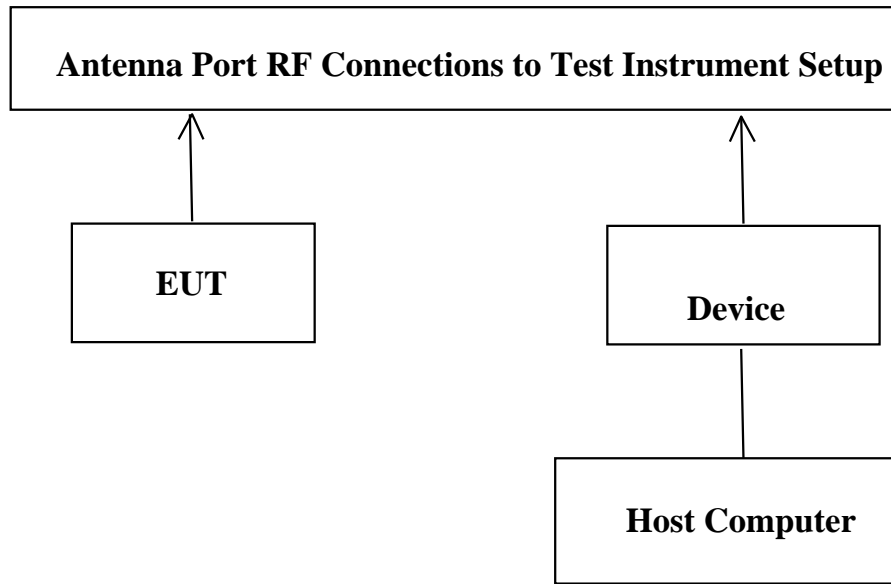

## 2. SETUP PHOTOS

### RADIATED RF MEASUREMENT SETUP

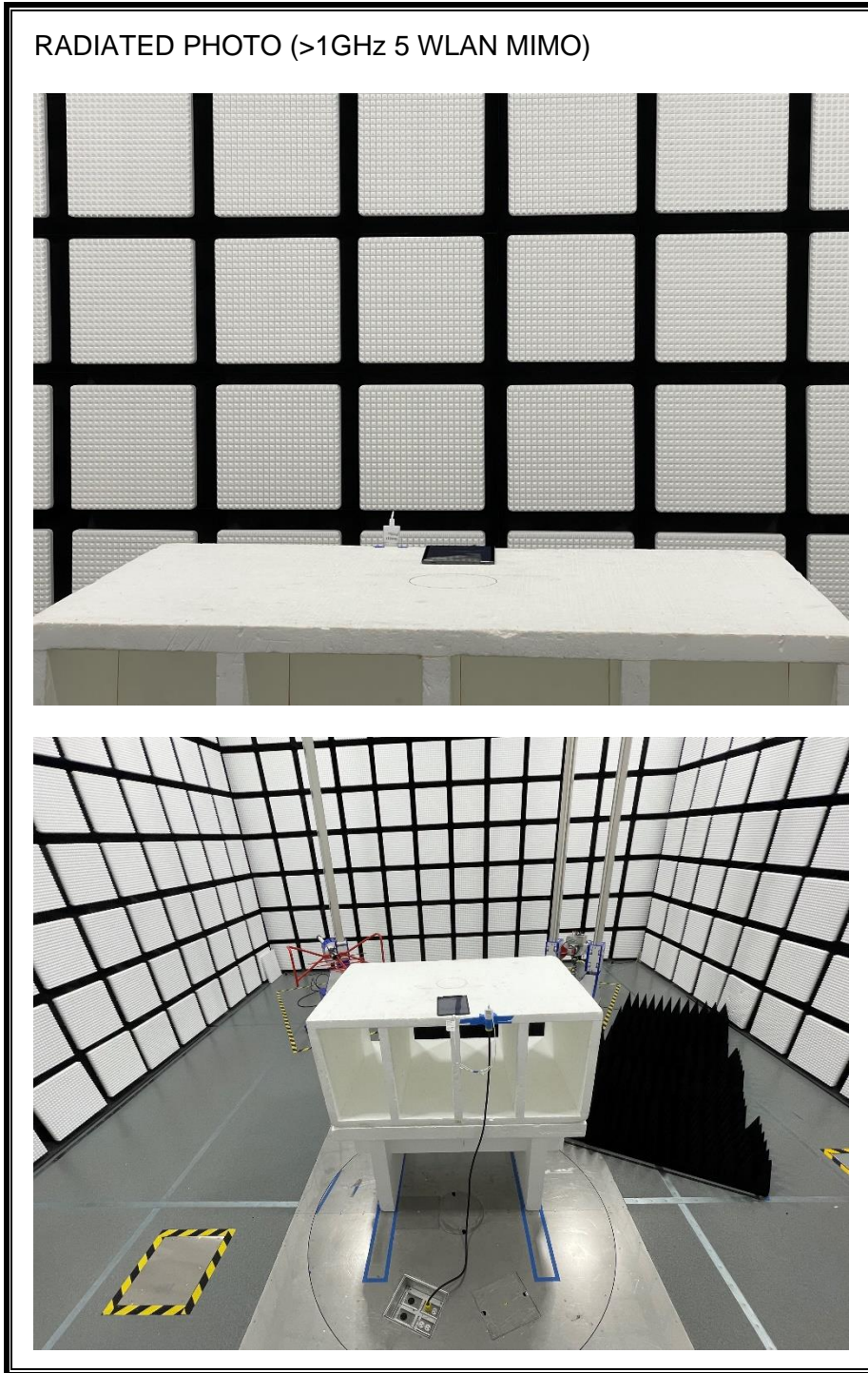

RADIATED PHOTO (>1GHz 2.4 WLAN / 6 WLAN MIMO)

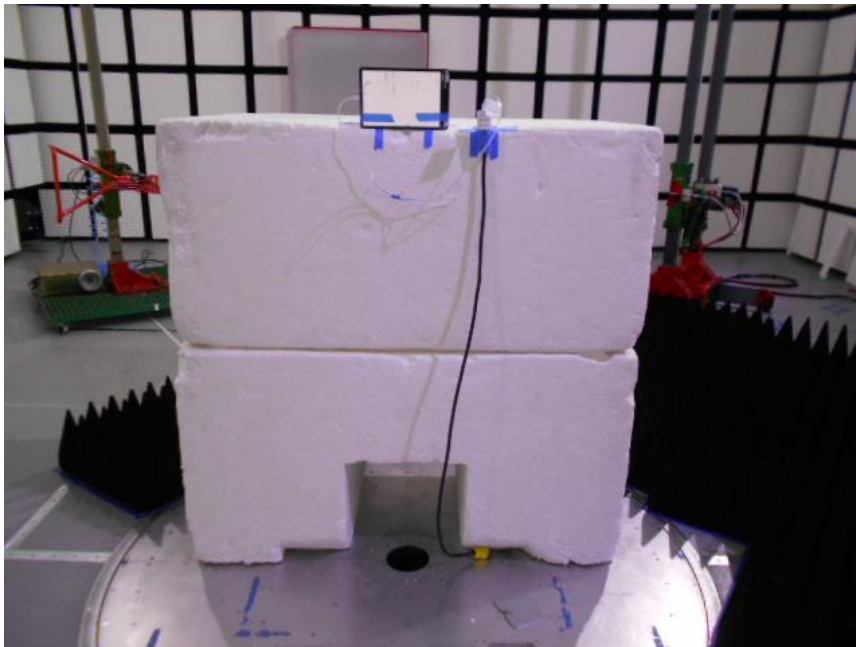

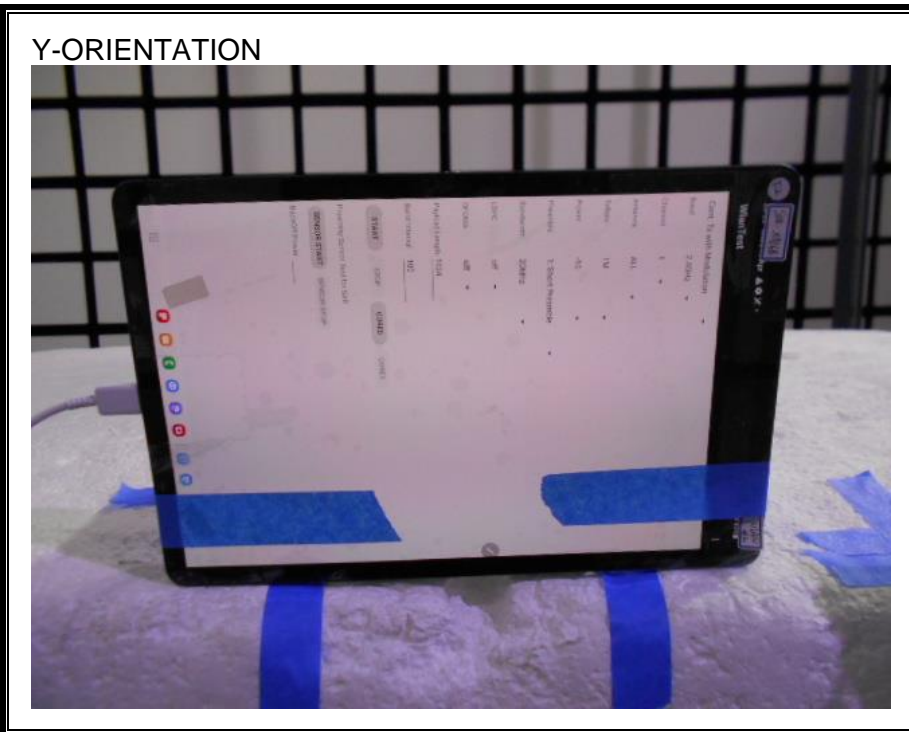
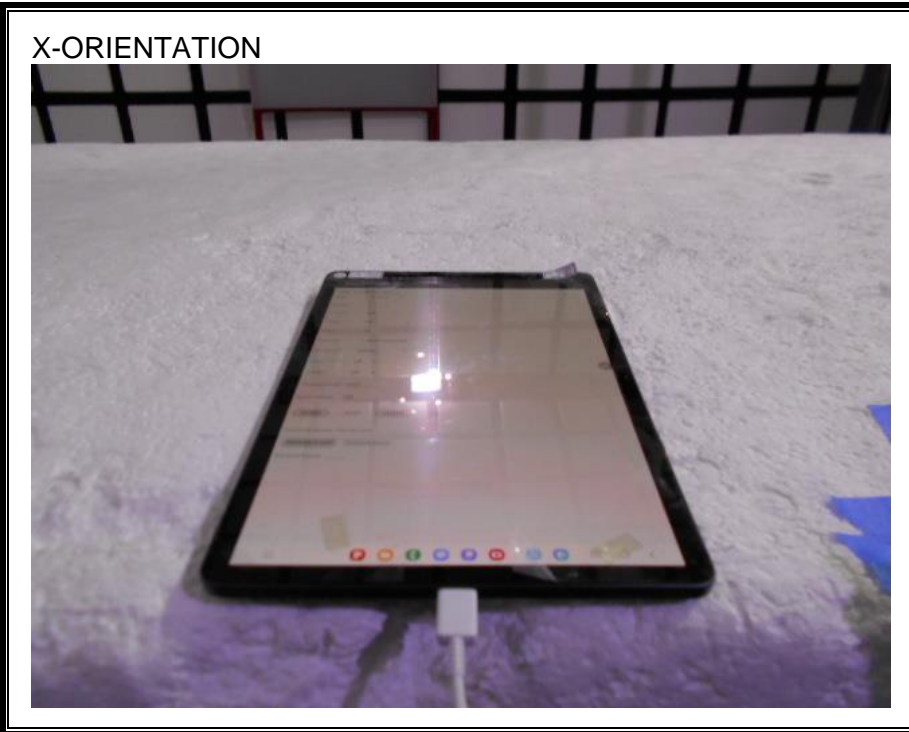





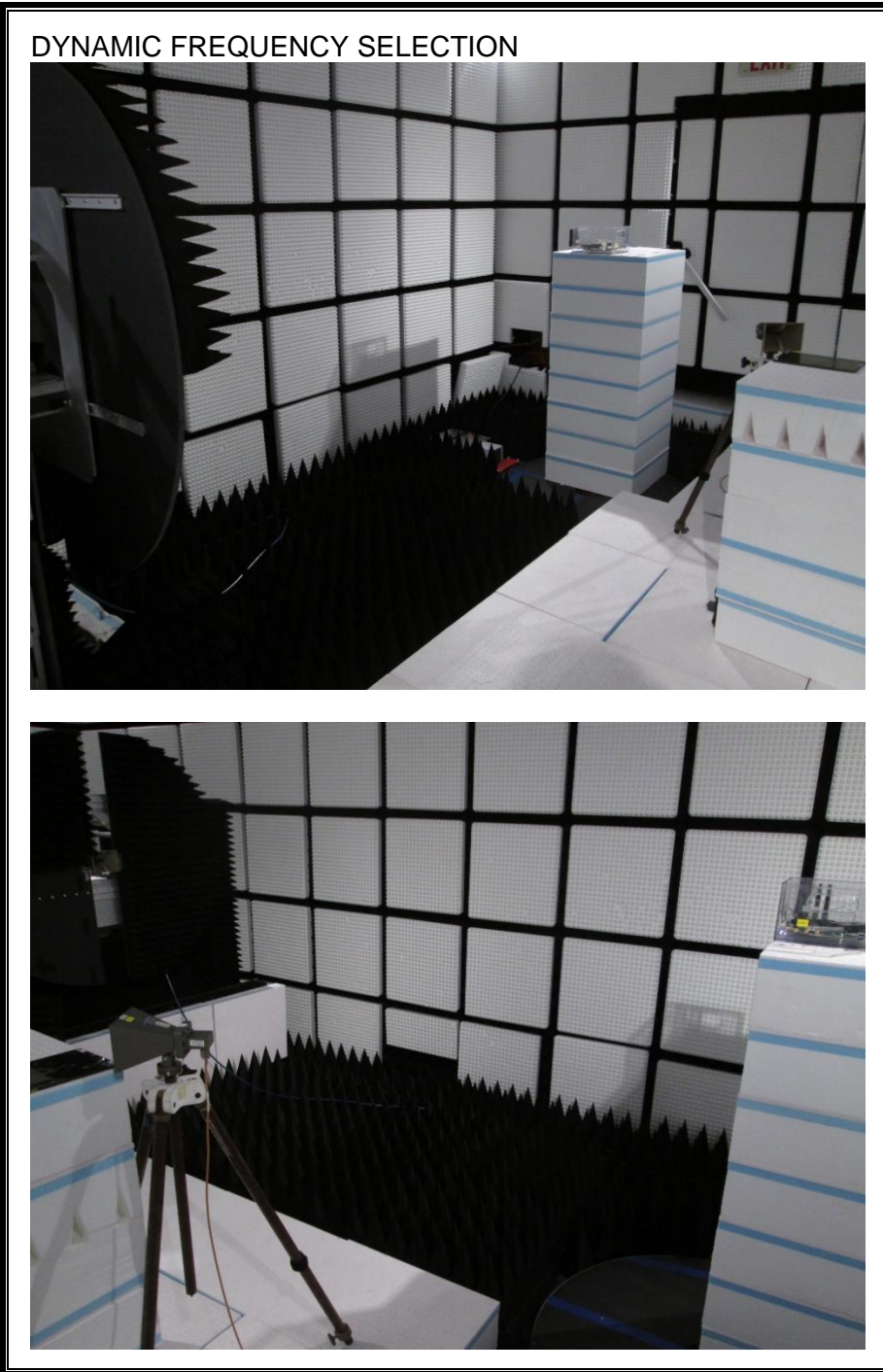

CONTENTION BASED PROTOCOL

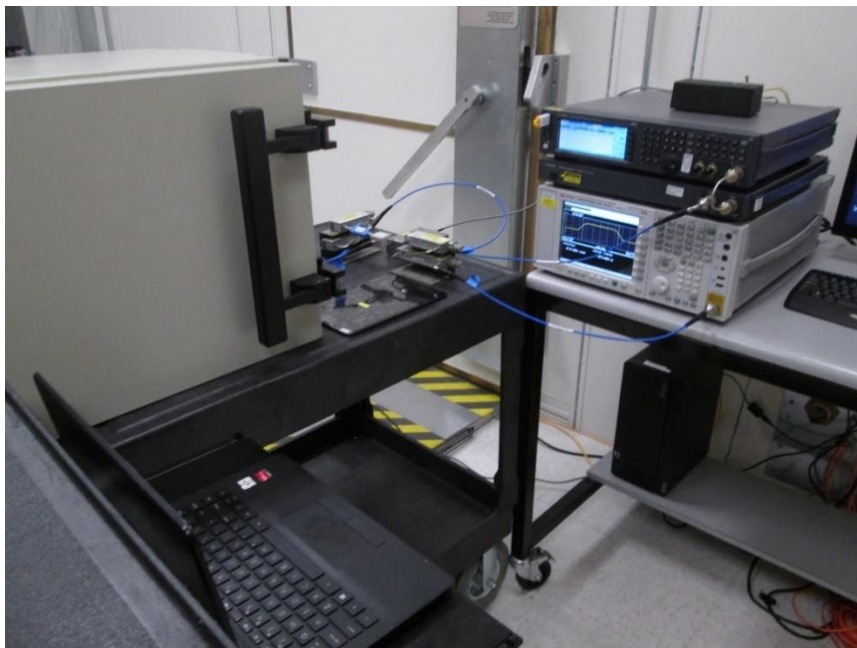

**END OF REPORT**