

EMC TEST REPORT



Project No.	LBE20230120	Issue No.	0
Applicant	Name of organization	Samsung Electronics Co., Ltd.	
	Address	(Maetan-dong) 129, Samsung-ro, Yeongtong-gu, Suwon-si, Gyeonggi-do, 16677, Korea	
	Date of receipt	April 20, 2023	
EUT	Type of device	<input type="checkbox"/> All other receivers subject to Part 15 <input checked="" type="checkbox"/> Class B personal computers and peripherals <input checked="" type="checkbox"/> Other Class B digital devices and peripherals <input type="checkbox"/> FM Broadcast Receiver	
	Equipment authorization	<input checked="" type="checkbox"/> Certification <input type="checkbox"/> Supplier's Declaration of Conformity	
	FCC ID	A3LSMX710	
	Kind of product	Portable Device	
	Model No.	SM-X710	
	Variant Model No.	Refer to clause 4.6	
	Manufacturer	Samsung Electronics Vietnam Thai Nguyen Co., Ltd Yen Binh I industrial Park, Pho Yen District, Thai Nguyen Province, Vietnam	
Applied Standards	47 CFR Part 15, Subpart B, Class B / ANSI C63.4-2014		
Test Period	April 26, 2023 ~ May 2, 2023		
Issue date	May 3, 2023		
Test result : Complied The equipment under test has found to be compliant with the applied standards. (Refer to the attached test result for more detail.)			
Tested by : Soo-Joon Kim 		Reviewed by : Chang-Eun Park 	
The test results in this report only apply to the tested sample. This report must not be reproduced, except in full, without written permission from Global CS center. * Not KOLAS report			
Samsung Electronics Co., Ltd., Global CS Center (Maetan dong) 129, Samsung-ro, Yeongtong-Gu, Suwon-Si, Gyeonggi-Do 16677, Korea			

Table of Contents

1. Report Information	3
1.1 Revision history	3
2. Summary of test results	3
2.1 Emission.....	3
3. General Information	3
3.1 Test facility	3
4. Test Setup configuration	4
4.1 Test Peripherals	4
4.2 EUT operating mode	5
4.3 Details of Sampling.....	5
4.4 Used cable description	6
4.5 Test arrangement	7
4.6 EUT Description.....	10
4.7 EUT Frequencies	10
4.8 Test configuration and condition	11
4.9 Measurement uncertainty	11
5. Results of individual test	12
5.1 Conducted Emission	12
5.2 Radiated Emission.....	17

1. Report Information

1.1 Revision history

No.	Date of Issue	Revised detailed information
Issue 0	May 3, 2023	There are no revisions and this version is basic test report.

2. Summary of test results

2.1 Emission

The EUT has been tested according to the following specifications:

Applied	Test type	Applied standard	Result
■	Conducted Emission (Mains port)	47 CFR Part 15 Subpart B / ANSI C63.4-2014 (Class B)	Complied
■	Radiated Emission		Complied

3. General Information

3.1 Test facility

The Global CS Center is located on Samsung Electronics Co., Ltd. at (Maetan-dong) 129, Samsung-ro, Yeongtong-gu, Suwon-si, Gyeonggi-do, 16677, Korea.

All testing are performed in Semi-anechoic chambers conforming to the site attenuation characteristics defined by ANSI C63.4, CISPR 32, CISPR 16-1-4 and Shielded rooms.

And all antennas are properly calibrated using ANSI C63.5:2017.

The Global CS Center is an ISO/IEC 17025 accredited testing laboratory by the National Radio Research Agency with designation No. KR0004. for EMC testing.

4. Test Setup configuration

4.1 Test Peripherals

The cables used for these peripherals are either permanently attached by the peripheral manufacturer or coupled with an assigned cable as defined below.

The following is a listing of the EUT and peripherals utilized during the performance of EMC test:

Description	Model No.	Serial No.	Manufacturer / Trademark	FCC ID
Portable Device	SM-X710	-	SAMSUNG	A3LSMX710
Headset	YBD-19HS	-	CRESYN	-
Data Cable	EP-DW767	-	RF TECH	-
Laptop Computer	Latitude5580	1WYRYM2	Dell	DoC
Laptop Computer	Latitude5580	D3HRYM2	Dell	DoC
Laptop AC Adapter	LA65NM130	5DEA	Dell	DoC
Laptop AC Adapter	LA65NM130	5B3C	Dell	DoC
Mouse	AA-SM7PCPB	CN57BA5903634ADV 8JJCD4371	SAMSUNG	DoC
Mouse	SMH-210UB	TAKGA05788Z	SAMSUNG	DoC
Router	DIR-806A	RF0F1D8018454	D-Link	DoC
Router	DIR-806A	RF0F1D8011504	D-Link	DoC
Travel Adapter	EP-TA800	R37TCCA00JBDKA	Dongyang E&P	-
DP Monitor	27DU88	711NTQD8H004	LG	DoC
DP Monitor Power Supply	LCAP31	EH8NN629490055062	LG	DoC
DP Cable	JCA141	BW2K1709000770	J5CREATE	-
Micro SD Card	64GB	-	SAMSUNG	-
Keyboard	EF-DX715	-	SAMSUNG	-
S-Pen	EJ-PX710	-	SAMSUNG	-

This tablet device does not contain the minimum number of ports required for personal computer testing per ANSI C63.4, but the EUT is attached to a computer through its only available port, which represents worst case emissions. All other aspects of C63.4 testing requirements were maintained..

4.2 EUT operating mode

To achieve compliance applied standard specification including JAB and JBP requirement, the following mode(s) were made during compliance testing:

4.2.1 Conducted Emission

No.	Operating mode
1	Camera (Rear) + Charging (w/TA) + Book cover keyboard (Pogo pin)
2	Camera (Front) + Charging (w/TA) + Book cover keyboard (Pogo pin)
3	Video + Audio playback from internal memory + Charging (w/TA) + Book cover keyboard (Pogo pin)
4	USB data communication with PC (from external memory) + Book cover keyboard (Pogo pin)

4.2.2 Radiated Emission

No.	Operating mode
1	Camera (Rear) + Charging (w/TA) + Book cover keyboard (Pogo pin)
2	Camera (Front) (w/Headset) + Book cover keyboard (Pogo pin)
3	Video + Audio playback from internal memory (w/Headset) + Book cover keyboard (Pogo pin)
4	Video + Audio playback from internal memory + Display out (w/ USB to Direct DP cable) + Book cover keyboard (Pogo pin)
5	USB data communication with PC (from external memory) + Book cover keyboard (Pogo pin)

4.3 Details of Sampling

Customer selected, single unit.

4.4 Used cable description

The EUT is configured, installed, arranged and operated in a manner consistent with typical applications. Interface cables/loads/devices are connected to at least one of each type of interface port of the EUT, and where practical, each cable shall be terminated in a device typical of actual usage. The type(s) of interconnecting cables to be used and the interface port (of the EUT) to which these were connected:

Connected cable	Length [m]	Shielded [Y/N]	Note
Data Cable	1.8	Y	From EUT to Laptop Computer or Travel Adapter
Headset	1.2	N	For EUT
Power	1.8	N	From Laptop Computer to AC Adapter
Power	1.5	N	For Laptop AC Adapter
LAN	1.5	N	From Laptop Computer to Router
USB	0.8	Y	From Laptop Computer to Router for DC Power
USB	1.8	Y	From Laptop Computer to Mouse
DP Cable	1.1	Y	From EUT to DP Monitor
Power	1.2	N	From DP Monitor to Power Supply
Power	2.2	N	For DP Monitor Power Supply

4.5 Test arrangement

4.5.1 Conducted Emission

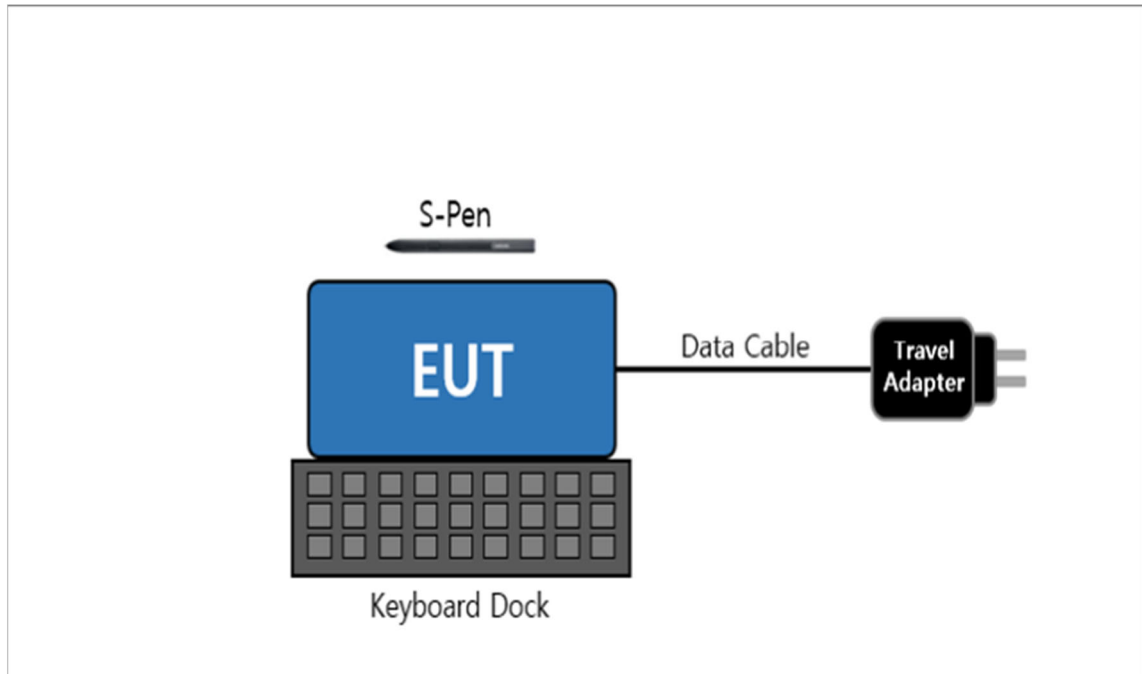

[Mode 1 – 3]

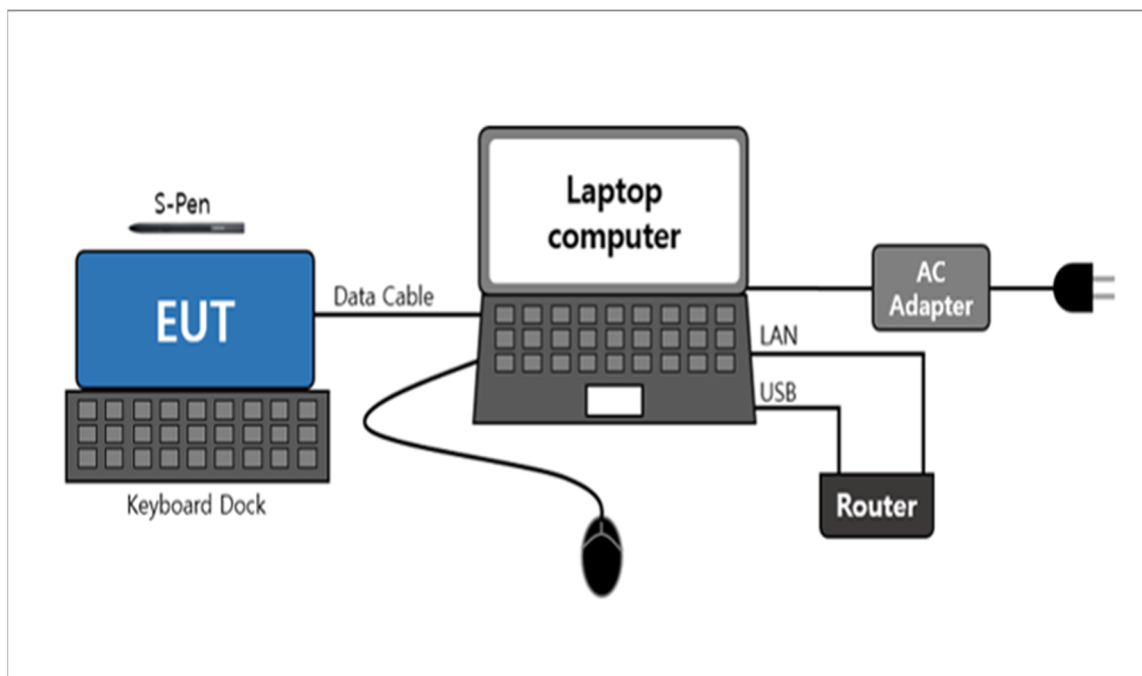

[Mode 4]

4.5.2 Radiated Emission

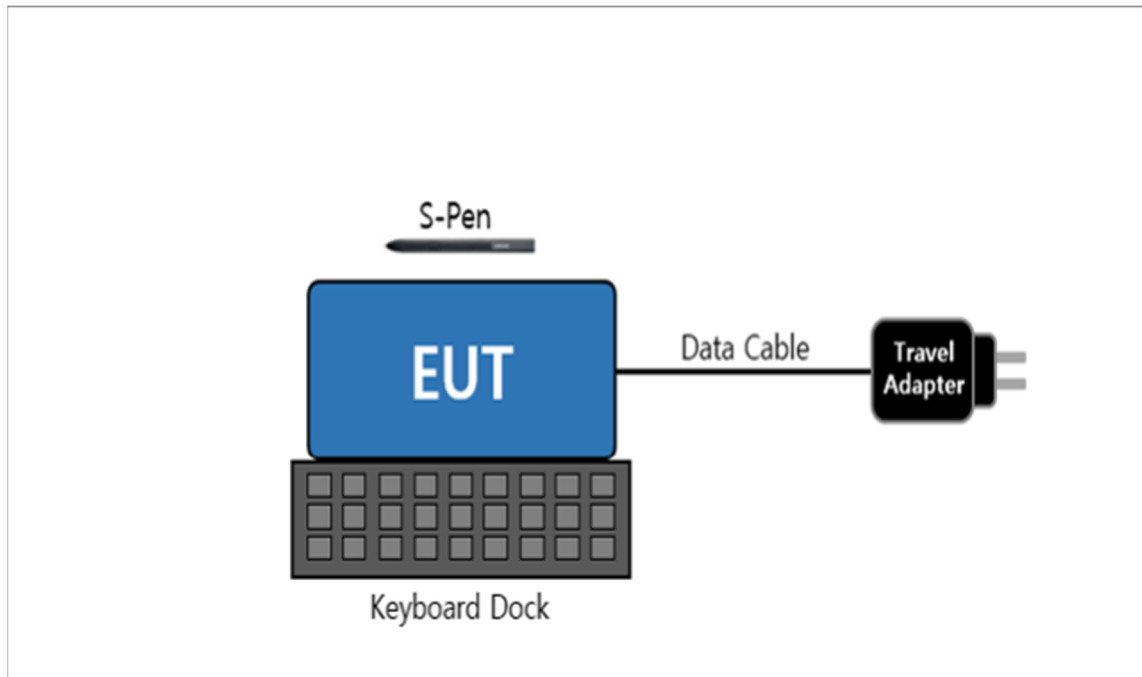

[Mode 1]

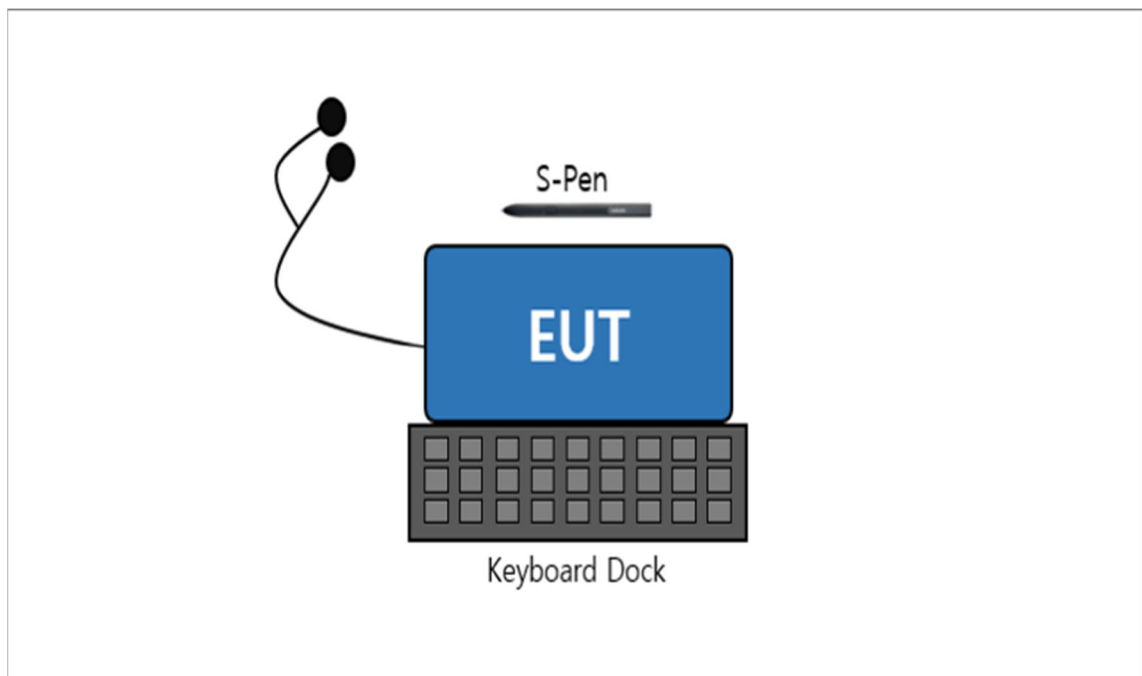

[Mode 2 – 3]

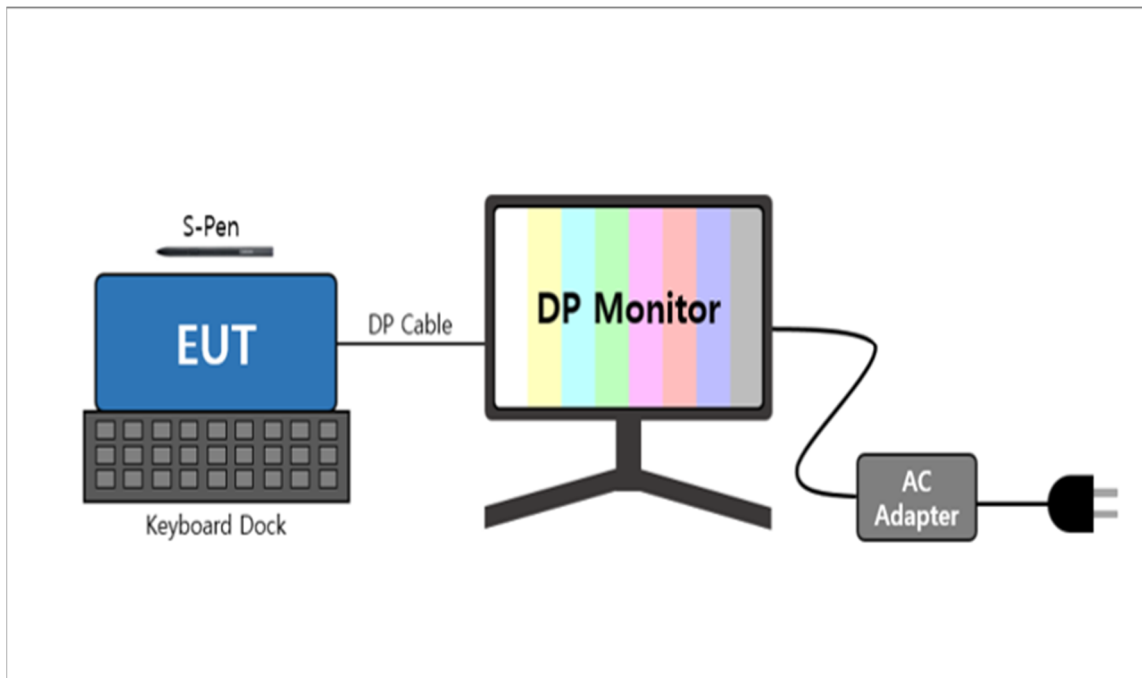

[Mode 4]

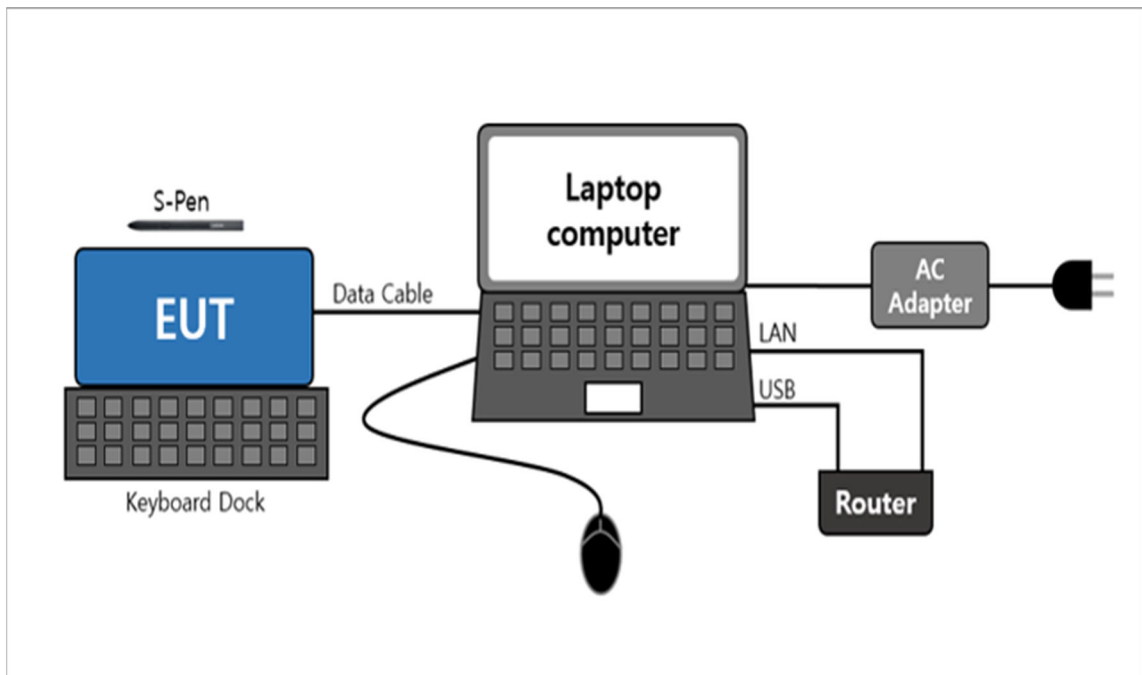

[Mode 5]

4.6 EUT Description

The EUT is a tablet type portable device which can operate on and incorporates a Bluetooth, Wi-Fi (802.11 b/g/n/a/ac/ax), Camera, Audio, Video, GNSS, DP, SD Card, Pogo and S-Pen.

4.6.1 The variant models

- None

4.7 EUT Frequencies

The highest frequencies (Generated and used)	Frequency [MHz]
Wi-Fi	7 125

4.8 Test configuration and condition

The system was configured for testing in a typical fashion that a customer would normally use. Cables were attached to each of the available I/O Ports. Where applicable, peripherals were attached to the I/O cables.

All the external I/O ports are exercised, as well as internal and the external SD card(if available), by writing and reading arbitrary data or charging with TA.

The EUT was investigated in three orientations and the worst case orientation is reported.

The video and audio(1 kHz sound) were repetitively played with the earphone connected.

The video and audio(1 kHz sound) were played on monitor through display out function using direct DP cable.

The camera of the EUT was operated continuously.

Power source for the EUT operating was supplied by CVCF.

- Test Voltage : AC 120 V, 60 Hz

4.9 Measurement uncertainty

Where relevant, the following measurement uncertainty levels have been estimated for tests performed on the apparatus : (According to CISPR 16-4-2 and UKAS M3003)

Test type		Measurement uncertainty (C.L. approximately 95 %, $k = 2$)
Conducted Emission	AC Mains	2.82 dB
Radiated Emission (Below 1 GHz)	Horizontal	5.05 dB
	Vertical	5.84 dB
Radiated Emission (Above 1 GHz)	Horizontal	5.18 dB
	Vertical	5.18 dB

* Remark

- 1) The values for uncertainty of conducted and radiated emissions are less than the Corresponding values of Ucispr given in CISPR 16-4-2. Therefore no adjustment of measurement results is necessary when comparing them with the relevant limits.

5. Results of individual test

5.1 Conducted Emission

The EUT is connected to a LISN via travel adapter. If the EUT is connected to the Laptop Computer USB port, the Laptop AC adapter is connected to a LISN.

Both conducted lines are measured in Quasi-Peak and CISPR-Average mode, including the worst-case data points for each tested configuration. The EUT measured in accordance with the methods described in standards.

Limits for Conducted emission at the mains ports of Class B

Frequency range Limits [MHz]	Resolution Bandwidth [kHz]	Limits [dB(μ V)]	
		Quasi-peak	Average
0.15 to 0.50	9	66 to 56	56 to 46
0.50 to 5	9	56	46
5 to 30	9	60	50

NOTE 1 The lower limit shall apply at the transition frequency.

NOTE 2 The limit decreases linearly with the logarithm of the frequency in the range 0.15 MHz to 0.50 MHz.

5.1.1 Test instrumentation

EMC No.	Test Instrument	Model name	Manufacturer	Serial No.	Next Calibration	
					Date	Interval (Month)
E5I-127	Two-Line V-Network	ENV216	R&S	102061	2024-01-20	12
E5I-247	EMI Test Receiver	ESW8	R&S	103124	2023-07-20	12
-	Test software	EMC32	R&S	Ver 10.60.20	-	-

5.1.2 Temperature and humidity condition

Test date	2023-05-02	Test engineer	Soo-Joon Kim
Climate condition	Ambient temperature	(22.6 \pm 0.5) °C	Limit (15.0 to 35.0) °C
	Humidity	(41.5 \pm 0.5) % R.H.	Limit (25.0 to 75.0) % R.H.
	Atmospheric pressure	(101.8 \pm 0.5) kPa	Limit (86.0 to 106.0) kPa
Test place	Shield Room (SR8)		

5.1.3 Test Results

□ Operating Mode 1: AC Mains

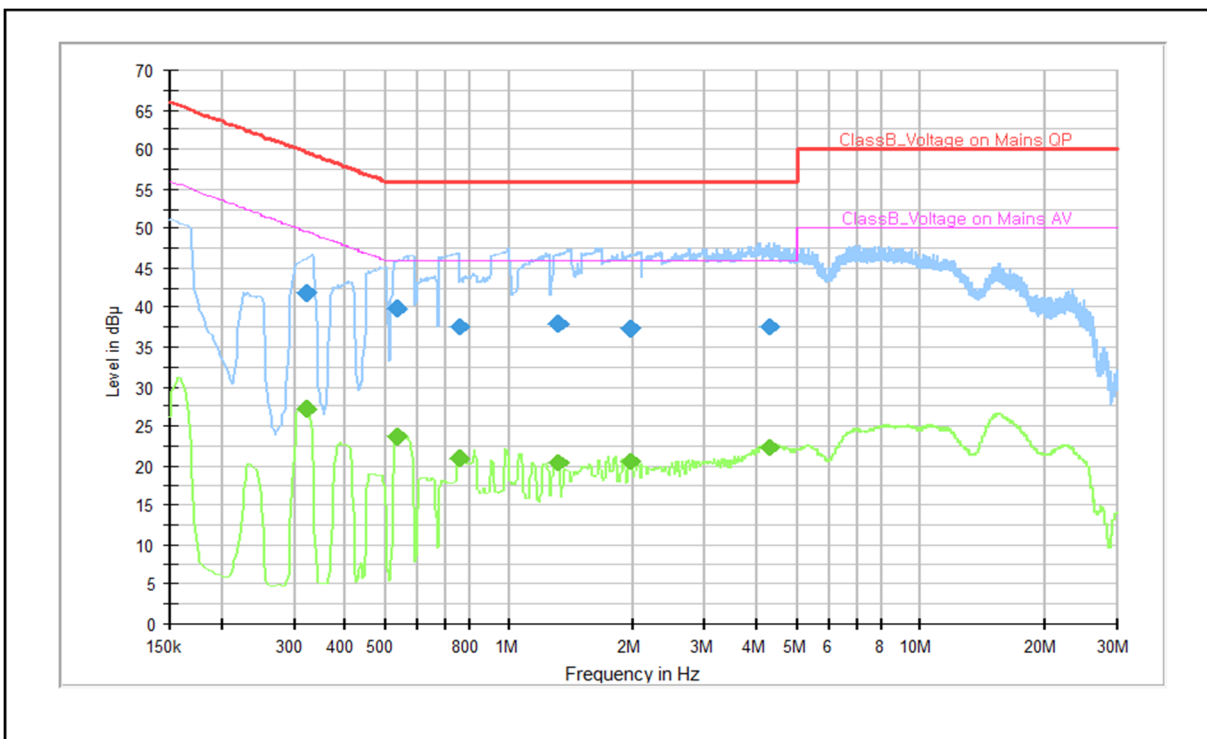

Note 1) Two graphs measured for both Live(L1) and Neutral(N) of the LISN are combined into one graph.

QP / CAV final measurement results table:

Frequency (MHz)	QP (dBµV)	CAV (dBµV)	Limit (dBµV)	Margin (dB)	Line	Corr. (dB)
0.323	---	27.2	49.6	22.4	L1	10.1
0.323	41.8	---	59.6	17.8	L1	10.1
0.535	---	23.8	46.0	22.2	L1	10.2
0.535	39.9	---	56.0	16.1	L1	10.2
0.762	---	20.9	46.0	25.1	L1	10.1
0.762	37.6	---	56.0	18.4	L1	10.1
1.311	---	20.4	46.0	25.6	L1	10.0
1.311	38.0	---	56.0	18.0	L1	10.0
1.968	---	20.6	46.0	25.4	L1	10.0
1.968	37.4	---	56.0	18.6	L1	10.0
4.270	---	22.3	46.0	23.7	L1	10.0
4.270	37.5	---	56.0	18.5	L1	10.0

Note 2) Level (QP and/or CAV) = Meter Reading (QP and/or CAV) + Corr. (LISN Insertion Loss + Cable Loss)
 Margin (QP and/or CAV) = Limit – Level (QP and/or CAV)
 QP = Quasi-Peak, CAV = CISPR-Average, Corr. = Correction Factor

□ **Operating Mode 2: AC Mains**

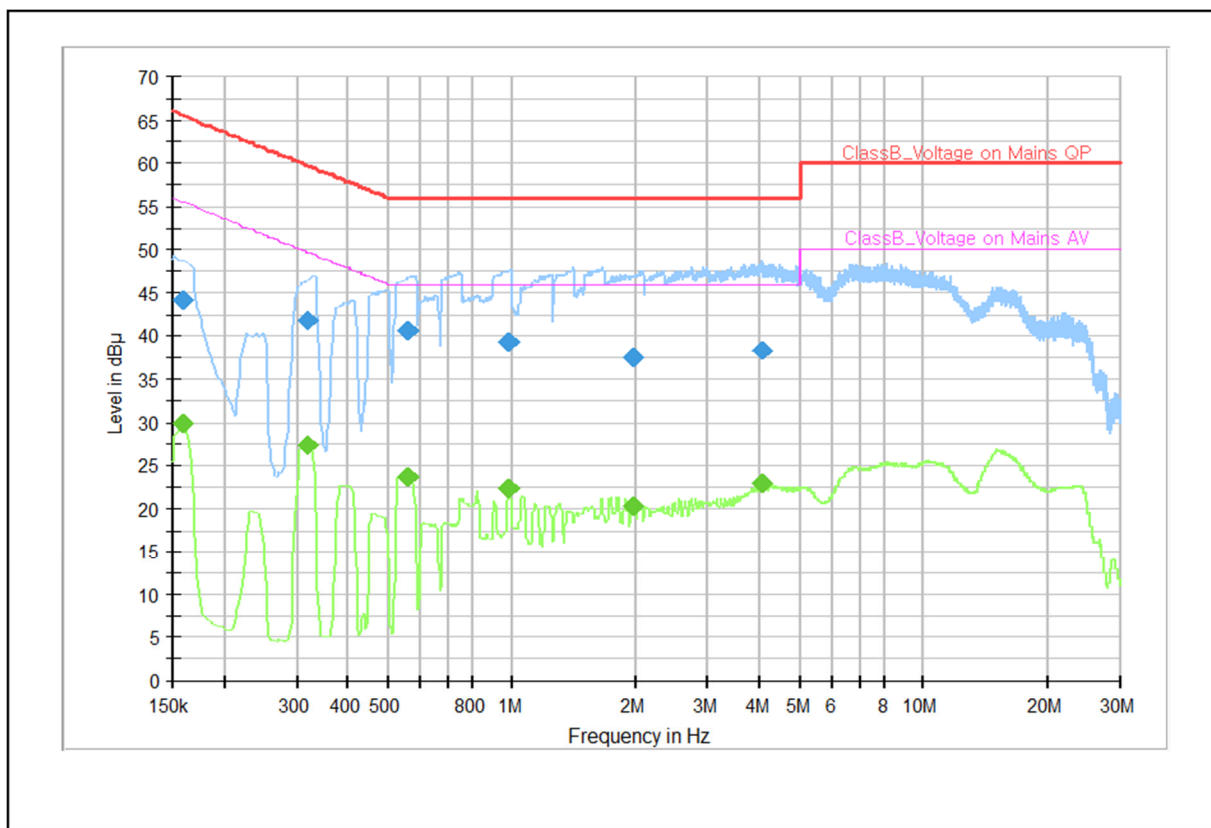

Note 1) Two graphs measured for both Live(L1) and Neutral(N) of the LISN are combined into one graph.

QP / CAV final measurement results table:

Frequency (MHz)	QP (dBµV)	CAV (dBµV)	Limit (dBµV)	Margin (dB)	Line	Corr. (dB)
0.159	---	29.9	55.5	25.7	L1	10.1
0.159	44.2	---	65.5	21.4	L1	10.1
0.319	---	27.3	49.7	22.5	L1	10.1
0.319	41.9	---	59.7	17.8	L1	10.1
0.562	---	23.6	46.0	22.4	L1	10.2
0.562	40.6	---	56.0	15.4	L1	10.2
0.983	---	22.3	46.0	23.7	L1	10.0
0.983	39.3	---	56.0	16.7	L1	10.0
1.966	---	20.4	46.0	25.6	L1	10.0
1.966	37.6	---	56.0	18.4	L1	10.0
4.067	---	22.9	46.0	23.1	L1	10.0
4.067	38.3	---	56.0	17.7	L1	10.0

Note 2) Level (QP and/or CAV) = Meter Reading (QP and/or CAV) + Corr. (LISN Insertion Loss + Cable Loss)
 Margin (QP and/or CAV) = Limit – Level (QP and/or CAV)
 QP = Quasi-Peak, CAV = CISPR-Average, Corr. = Correction Factor

□ **Operating Mode 3: AC Mains**

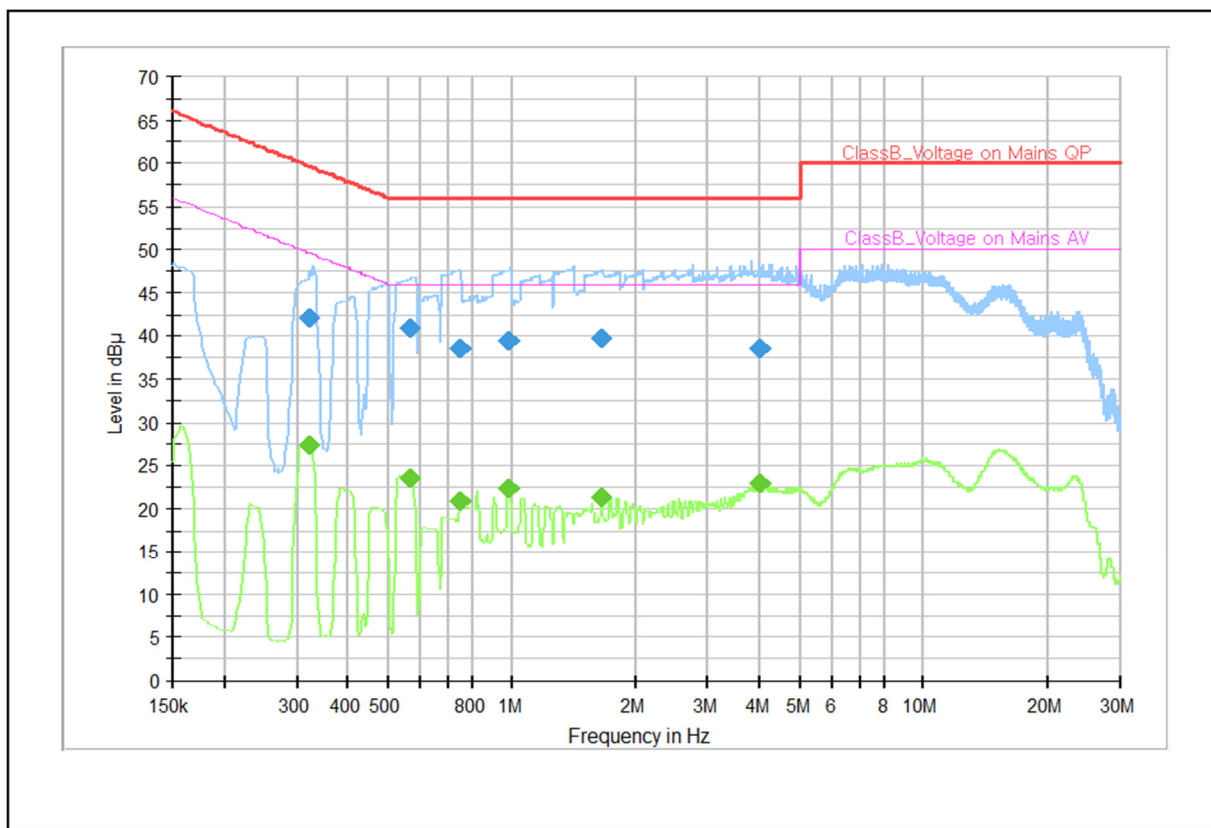

Note 1) Two graphs measured for both Live(L1) and Neutral(N) of the LISN are combined into one graph.

QP / CAV final measurement results table:

Frequency (MHz)	QP (dBµV)	CAV (dBµV)	Limit (dBµV)	Margin (dB)	Line	Corr. (dB)
0.321	---	27.4	49.7	22.3	L1	10.1
0.321	42.0	---	59.7	17.7	L1	10.1
0.566	---	23.5	46.0	22.5	L1	10.2
0.566	40.8	---	56.0	15.2	L1	10.2
0.753	---	21.0	46.0	25.0	L1	10.1
0.753	38.6	---	56.0	17.4	L1	10.1
0.983	---	22.3	46.0	23.7	L1	10.0
0.983	39.5	---	56.0	16.5	L1	10.0
1.655	---	21.4	46.0	24.6	L1	10.0
1.655	39.8	---	56.0	16.2	L1	10.0
3.984	---	22.8	46.0	23.2	L1	10.0
3.984	38.4	---	56.0	17.6	L1	10.0

Note 2) Level (QP and/or CAV) = Meter Reading (QP and/or CAV) + Corr. (LISN Insertion Loss + Cable Loss)
 Margin (QP and/or CAV) = Limit – Level (QP and/or CAV)
 QP = Quasi-Peak, CAV = CISPR-Average, Corr. = Correction Factor

□ **Operating Mode 4: AC Mains**

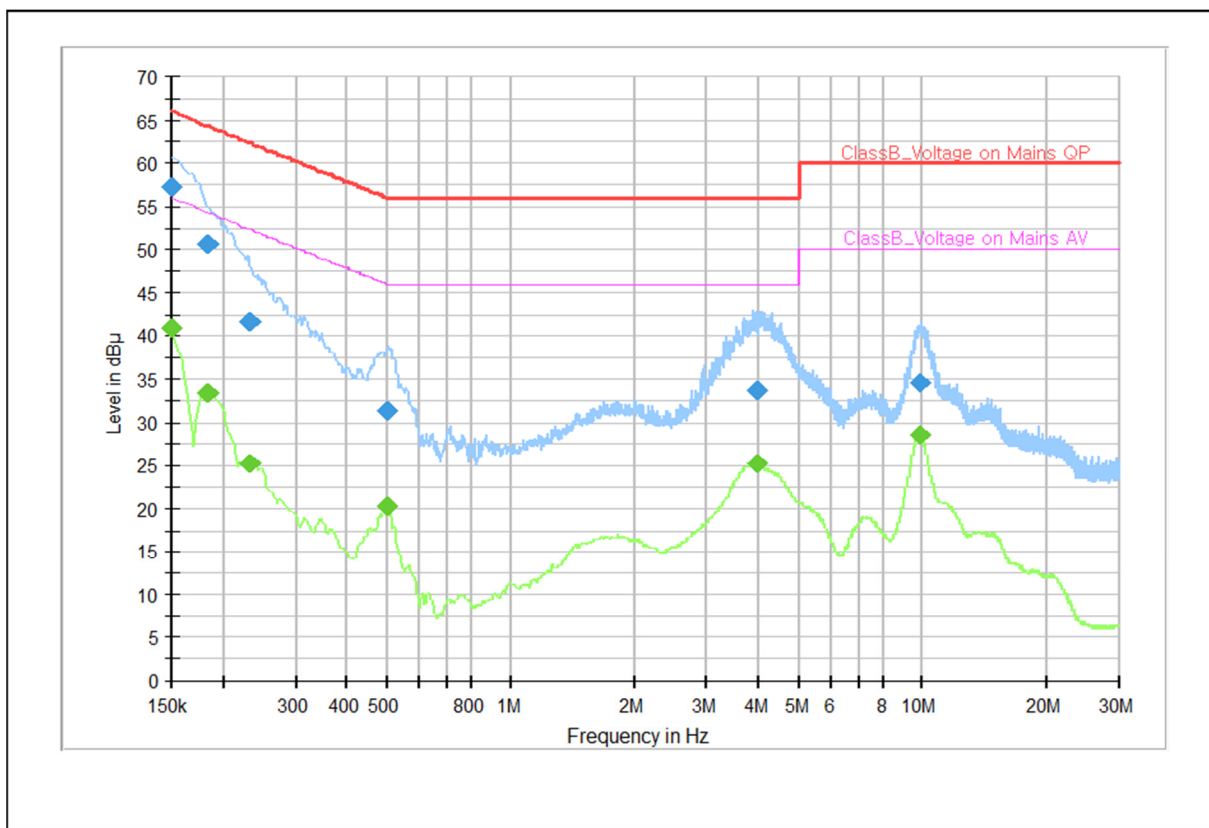

Note 1) Two graphs measured for both Live(L1) and Neutral(N) of the LISN are combined into one graph.

QP / CAV final measurement results table:

Frequency (MHz)	QP (dBµV)	CAV (dBµV)	Limit (dBµV)	Margin (dB)	Line	Corr. (dB)
0.150	---	40.8	56.0	15.2	N	10.0
0.150	57.2	---	66.0	8.8	N	10.0
0.184	---	33.4	54.3	20.9	N	10.2
0.184	50.6	---	64.3	13.8	N	10.2
0.233	---	25.3	52.3	27.1	L1	9.9
0.233	41.6	---	62.3	20.7	L1	9.9
0.499	31.2	---	56.0	24.8	L1	10.2
0.499	---	20.3	46.0	25.7	L1	10.2
3.944	---	25.2	46.0	20.8	N	9.9
3.944	33.6	---	56.0	22.4	N	9.9
9.827	34.6	---	60.0	25.4	L1	10.1
9.827	---	28.5	50.0	21.5	L1	10.1

Note 2) Level (QP and/or CAV) = Meter Reading (QP and/or CAV) + Corr. (LISN Insertion Loss + Cable Loss)
 Margin (QP and/or CAV) = Limit – Level (QP and/or CAV)
 QP = Quasi-Peak, CAV = CISPR-Average, Corr. = Correction Factor

5.2 Radiated Emission

The following data lists the significant emission frequencies, measured levels, correction factors (for antenna and cables), orientation of table, polarization and height of antenna, the corrected reading, the limit, and the amount of margin.

Peak measurements were made over the changeable frequency range 30 MHz to 1 GHz at a measurement distance of 3 m for the following antenna and turntable arrangements:

Antenna Height [cm]	Antenna Polarization	Resolution Bandwidth [kHz]	Video Bandwidth [kHz]	Turntable position [degrees]
100 ~ 400	Horizontal, Vertical	120	300	Continuous

Measurements within 6 dB of the limit were then maximized by adjusting turntable position.

Final measurements were made using quasi-peak detector.

Peak/CISPR-Average measurements were made over the changeable frequency range 1 GHz to 40 GHz or 5th harmonics of the highest frequency generated or used in the device or on which the device operates or tunes at a measurement distance of 3 m for the following antenna and turntable arrangements. The measurements above 1 GHz were performed with the bore-sighting antenna aimed at the EUT.

Antenna Height [cm]	Antenna Polarization	Resolution Bandwidth [MHz]	Video Bandwidth [MHz]	Turntable position [degrees]
100 ~ 400	Horizontal, Vertical	1	3	Continuous

Measurements within 6 dB of the limit were then maximized by adjusting turntable position.

Final measurements were made using peak and CISPR-average detectors.

Limits for Radiated emission of Class B at a measuring distance of 3 m and 10 m

Frequency range Limits [MHz]	Field Strength		
	3 m [$\mu\text{V/m}$]	3 m [dB($\mu\text{V/m}$)]	10 m [dB($\mu\text{V/m}$)]
30 to 88	100	40.0	29.5
88 to 216	150	43.5	33.0
216 to 960	200	46.0	35.5
Above 960	500	54.0	43.5

Note) Distance correction formula from D1(3m) to D2(10m)

: Limit at D2 = Limit at D1 + 20Log(D1 / D2)

Results checked manually; and points close to the limit line were re-measured.

5.2.1 Test instrumentation

EMC No.	Test Instrument	Model name	Manufacturer	Serial No.	Next Calibration	
					Date	Interval (Month)
E5I-020	EMI Test Receiver	ESU40	R&S	100375	2023-09-28	12
E5I-018	EMI Test Receiver	ESU8	R&S	100484	2023-05-26	12
E5I-248	EMI Test Receiver	ESW44	R&S	103129	2023-07-20	12
E5I-069	BiLog Antenna	CBL6112D	TESEQ	35382	2023-08-09	24
E5I-138	6 dB Fixed Attenuator	8491A	Keysight	MY52462285	2023-08-09	24
E5I-071	BiLog Antenna	CBL6112D	TESEQ	35384	2023-08-09	24
E5I-136	6 dB Fixed Attenuator	8491A	Keysight	MY52462355	2023-08-09	24
E5I-093	Preamplifier	310N	SONOMA	273122	2024-01-17	12
E5I-094	Preamplifier	310N	SONOMA	282363	2024-01-17	12
E5I-035	Horn Antenna	HF907	R&S	100506	2023-10-25	12
E5I-039	Signal Conditioning Unit	SCU-18	R&S	10211	2024-04-05	12
E5I-243	WideBand Horn Antenna	QMS-00880	STEATITE	25187	2023-11-23	12
E5I-042	Signal Conditioning Unit	SCU-40A	R&S	10004	2023-09-21	12
-	Test software	EP7RE	TOYO	Ver 8.0.20	-	-
-	Test software	EMC32	R&S	Ver 10.60.20	-	-

5.2.2 Temperature and humidity condition

Test date	2023-04-26	Test engineer	Soo-Joon Kim
Climate condition	Ambient temperature	(22.9 ± 0.5) °C	Limit (15.0 to 35.0) °C
	Humidity	(34.1 ± 0.5) % R.H.	Limit (25.0 to 75.0) % R.H.
	Atmospheric pressure	(101.9 ± 0.5) kPa	Limit (86.0 to 106.0) kPa
Test place	Semi-Anechoic Chamber (SAC5)		

5.2.3 Test Results

□ Operating Mode 1

- Frequencies below 1 GHz

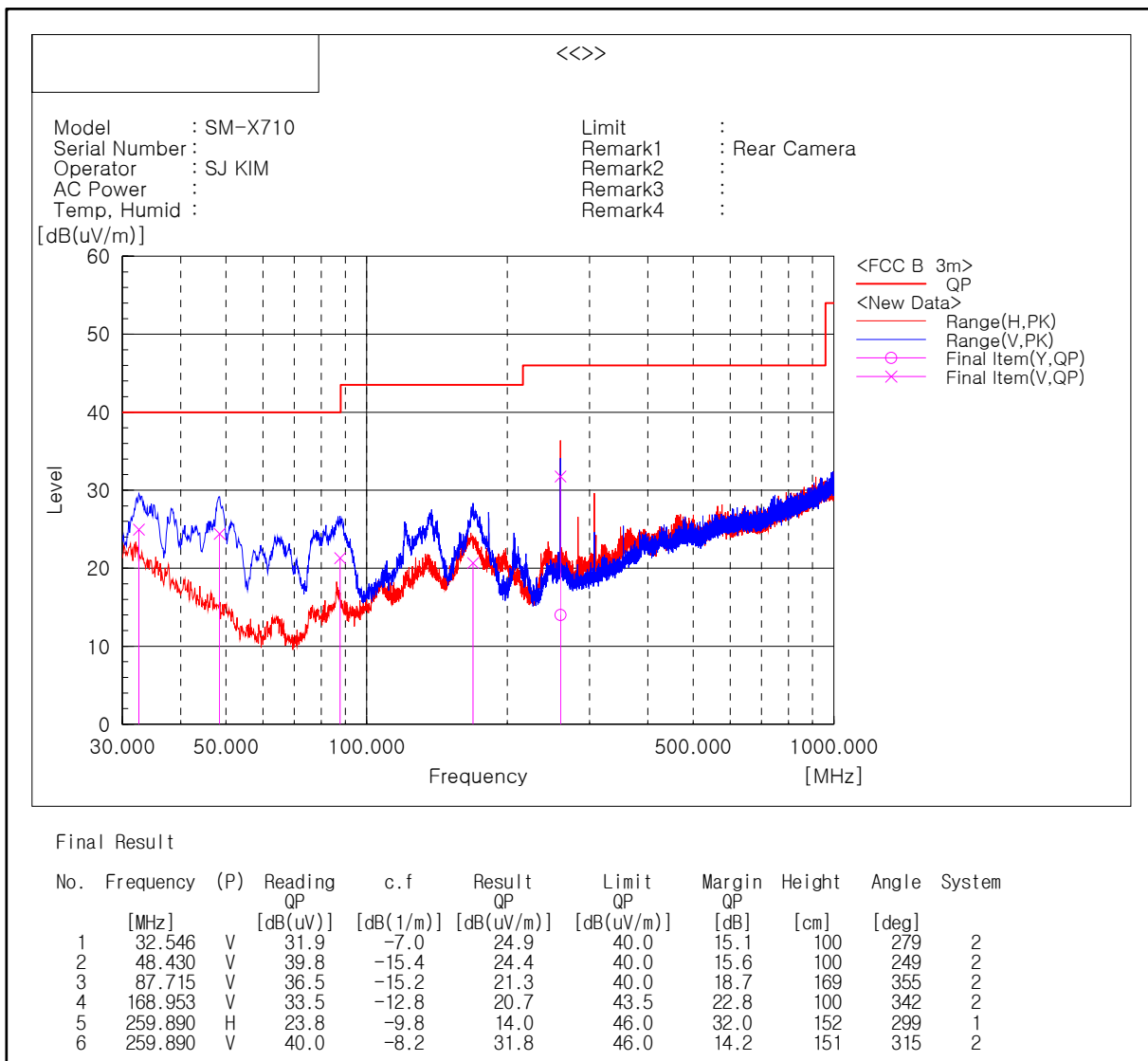

Note1) Receiving antenna polarization : Horizontal, Vertical

Test Distance : 3 m, Antenna Height : 1 to 4 meters

Result (QP) = Reading (QP) + c.f (Antenna Factor + Cable Loss - Amp. Gain)

Margin (QP) = Limit – Level (QP)

QP = Quasi-Peak, c.f = Correction Factor

- Frequencies above 1 GHz

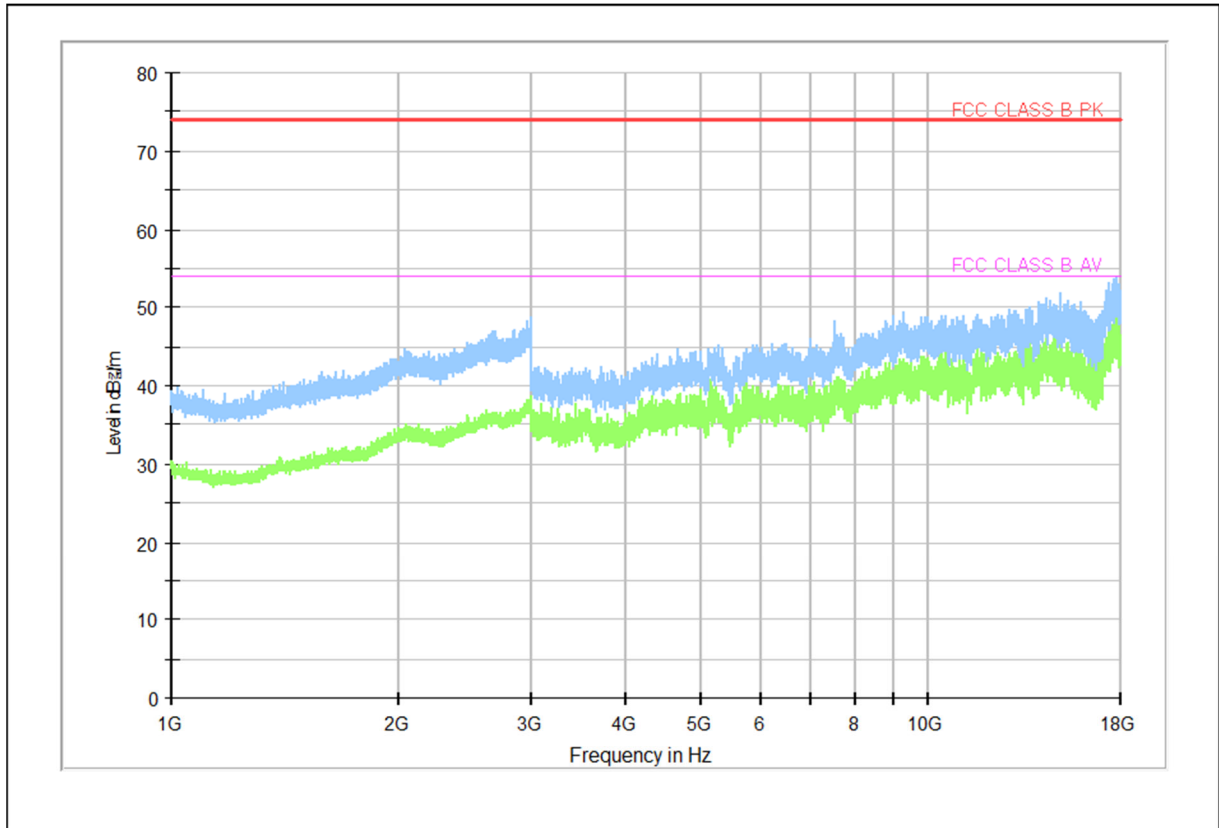

Note 1) We have also tested from 18 GHz to 40 GHz and found no emissions.

Note 2) Receiving antenna polarization : Horizontal, Vertical

Test Distance : 3 m, Antenna Height : 1 to 4 meters

Level (PK and/or CAV) = Reading (PK and/or CAV) + Corr. (Antenna Factor + Cable Loss - Amp. Gain)

Margin (PK and/or CAV) = Limit – Level (PK and/or CAV)

PK = Peak, CAV = CISPR-Average, Corr. = Correction Factor

□ Operating Mode 2

- Frequencies below 1 GHz

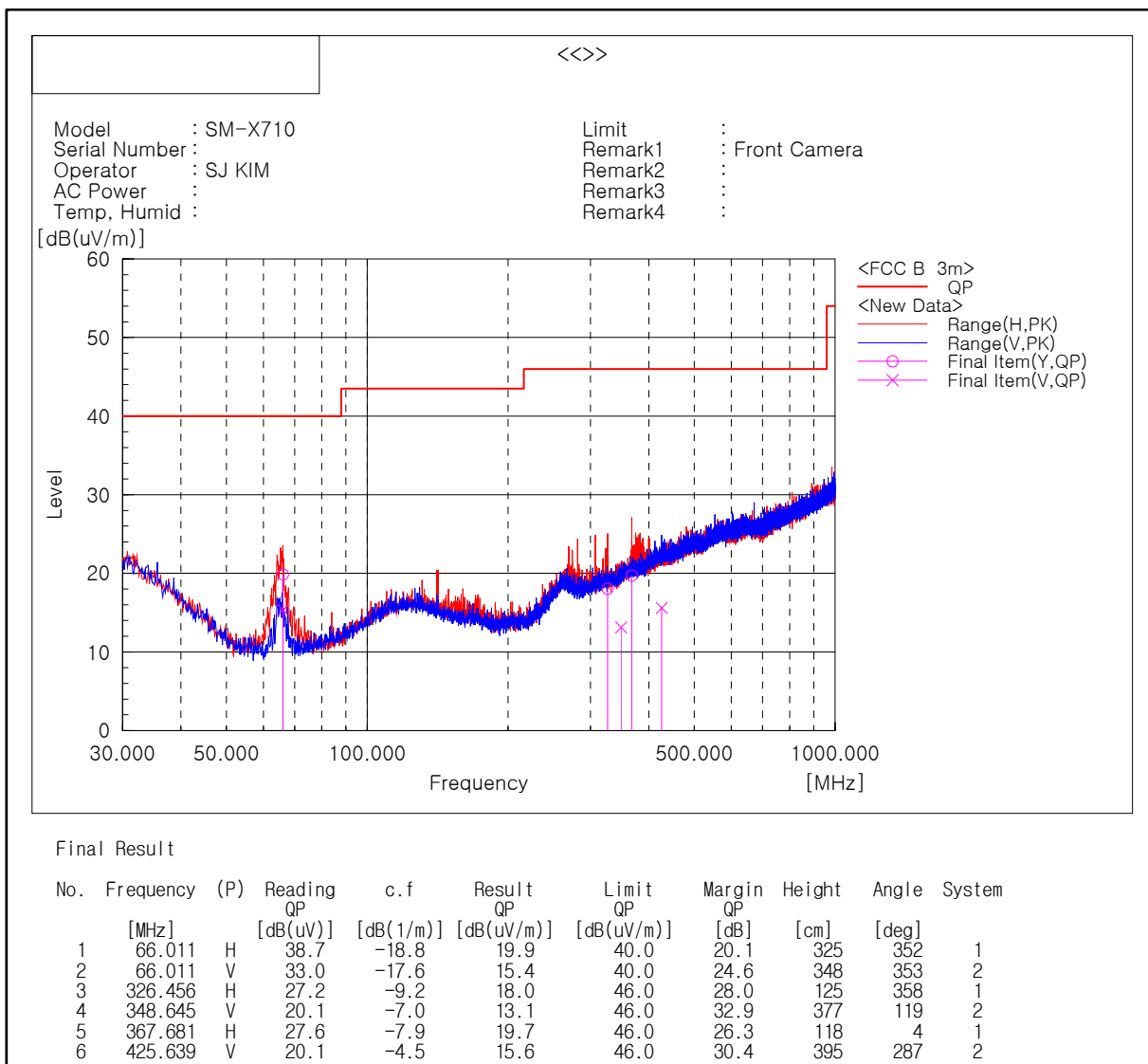

Note1) Receiving antenna polarization : Horizontal, Vertical

Test Distance : 3 m, Antenna Height : 1 to 4 meters

Result (QP) = Reading (QP) + c.f (Antenna Factor + Cable Loss - Amp. Gain)

Margin (QP) = Limit - Level (QP)

QP = Quasi-Peak, c.f = Correction Factor

- Frequencies above 1 GHz

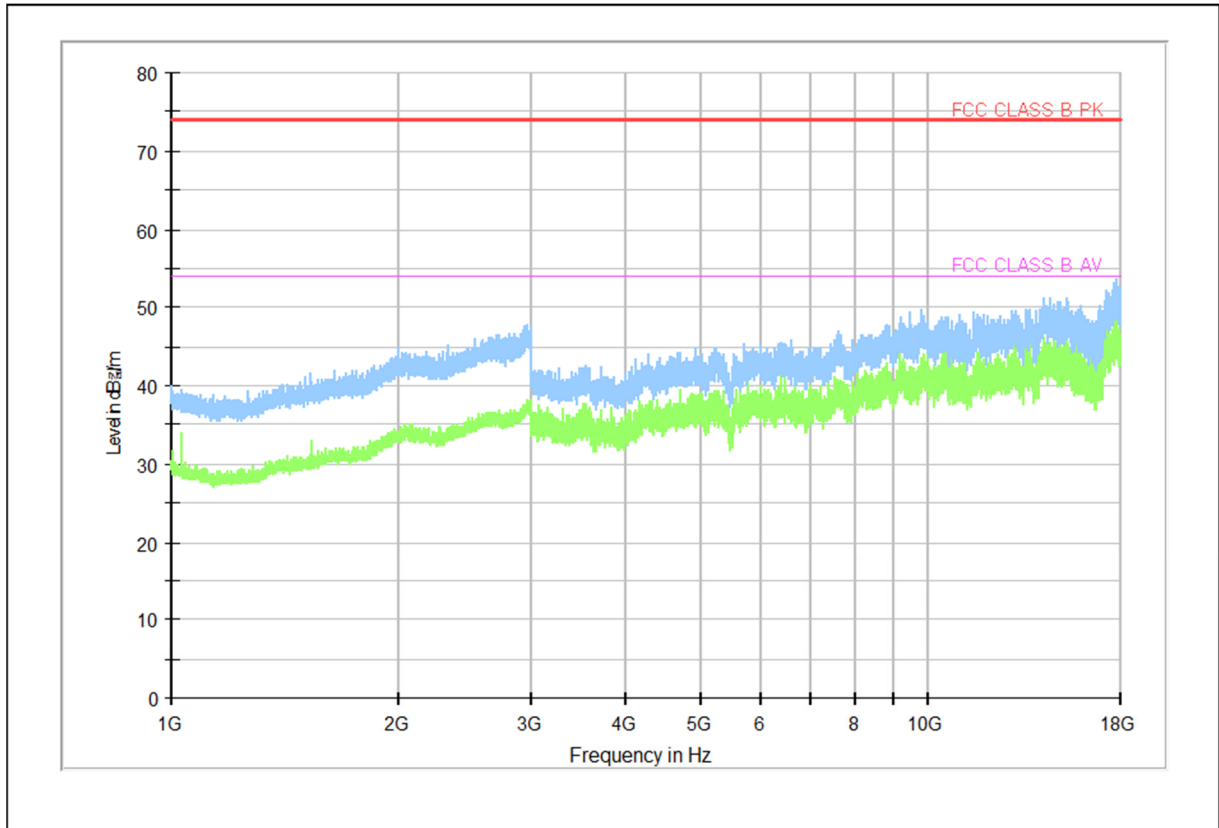

Note 1) We have also tested from 18 GHz to 40 GHz and found no emissions.

Note 2) Receiving antenna polarization : Horizontal, Vertical

Test Distance : 3 m, Antenna Height : 1 to 4 meters

Level (PK and/or CAV) = Reading (PK and/or CAV) + Corr. (Antenna Factor + Cable Loss - Amp. Gain)

Margin (PK and/or CAV) = Limit – Level (PK and/or CAV)

PK = Peak, CAV = CISPR-Average, Corr. = Correction Factor

□ Operating Mode 3

- Frequencies below 1 GHz

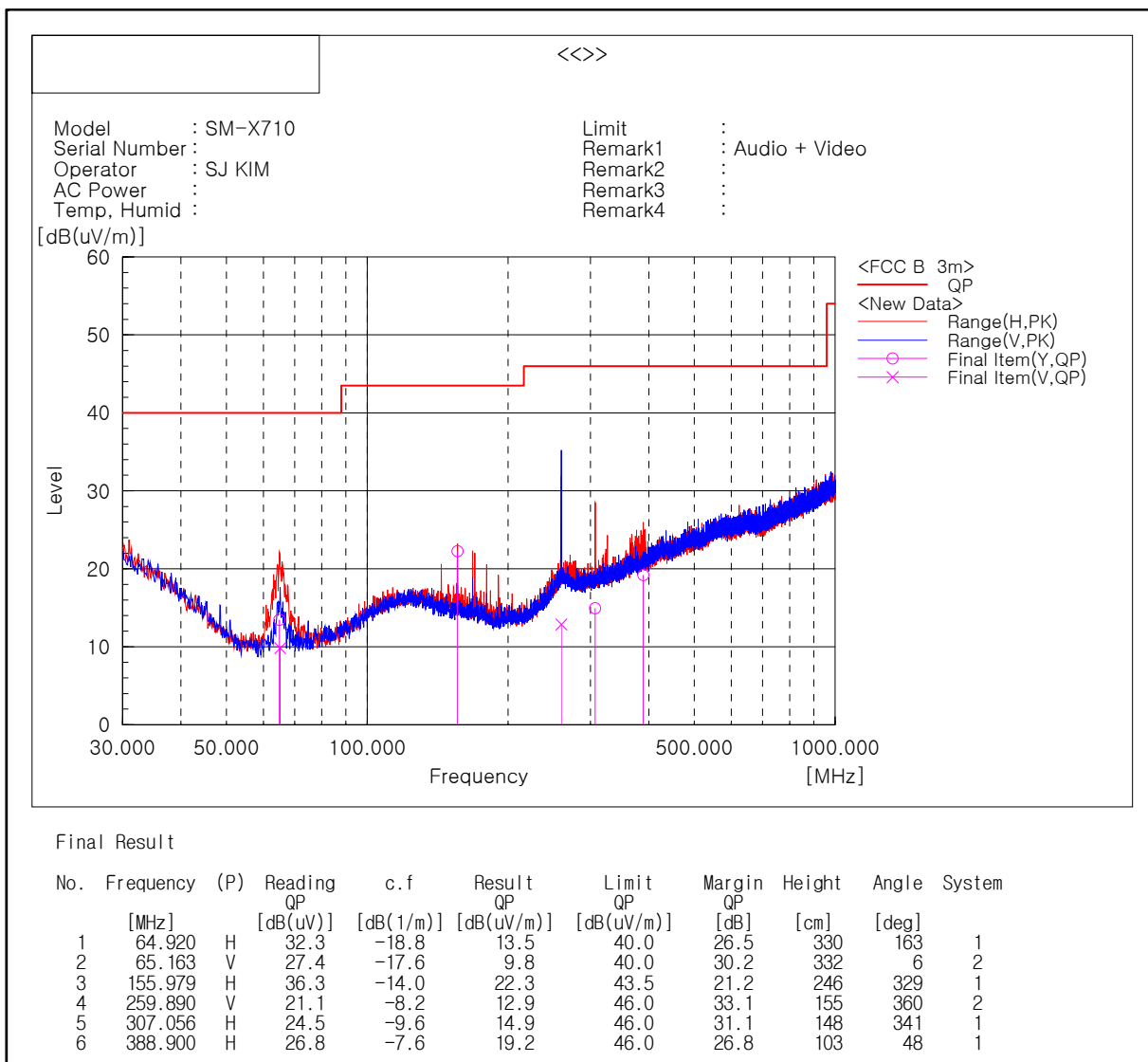

Note1) Receiving antenna polarization : Horizontal, Vertical

Test Distance : 3 m, Antenna Height : 1 to 4 meters

Result (QP) = Reading (QP) + c.f (Antenna Factor + Cable Loss - Amp. Gain)

Margin (QP) = Limit - Level (QP)

QP = Quasi-Peak, c.f = Correction Factor

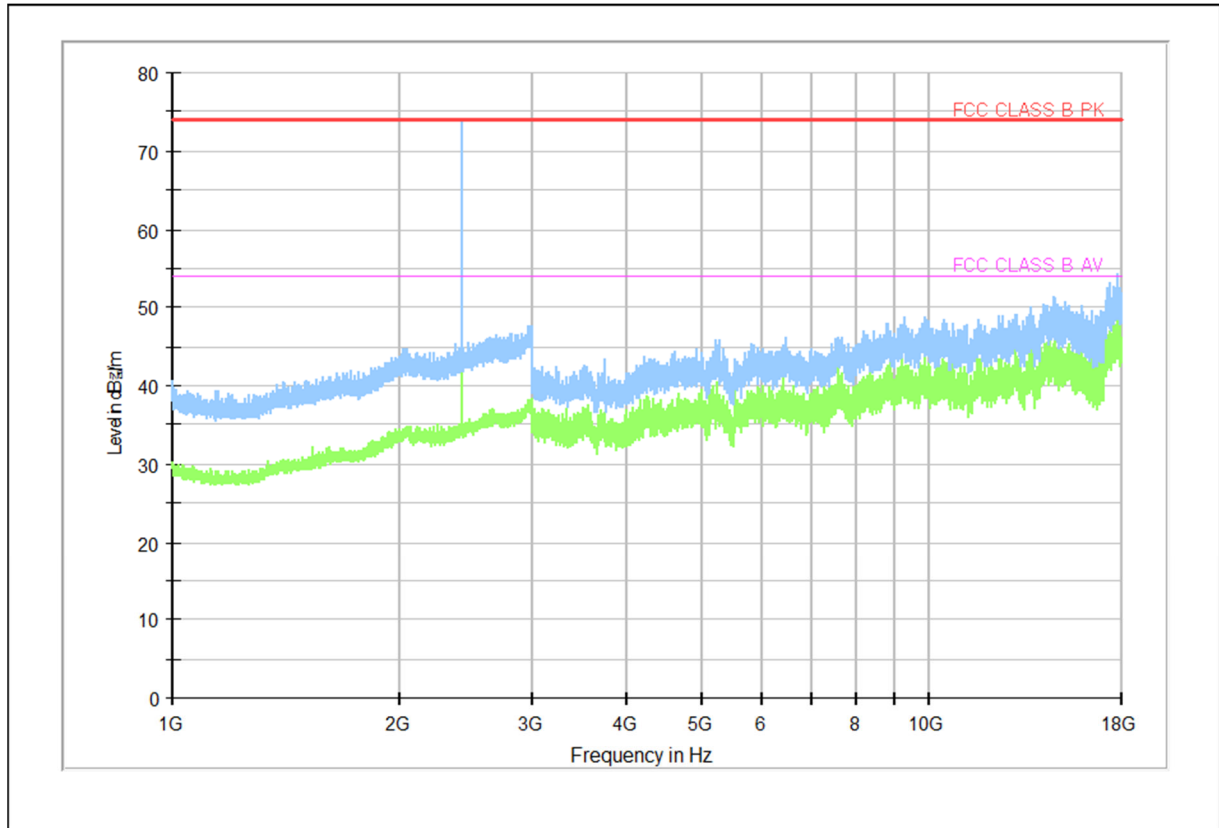
- Frequencies above 1 GHz

Note 1) We have also tested from 18 GHz to 40 GHz and found no emissions.

Note 2) Receiving antenna polarization : Horizontal, Vertical

Test Distance : 3 m, Antenna Height : 1 to 4 meters

Level (PK and/or CAV) = Reading (PK and/or CAV) + Corr. (Antenna Factor + Cable Loss - Amp. Gain)

Margin (PK and/or CAV) = Limit – Level (PK and/or CAV)

PK = Peak, CAV = CISPR-Average, Corr. = Correction Factor

Note 3) Radiated emissions (Tx / Rx frequency) from the transceiver shall be ignored.

- Data transmission in the 2.4 GHz ISM band (Bluetooth/Wi-Fi)

: Operating frequencies (2 400 ~ 2 483.5) MHz

□ Operating Mode 4

- Frequencies below 1 GHz

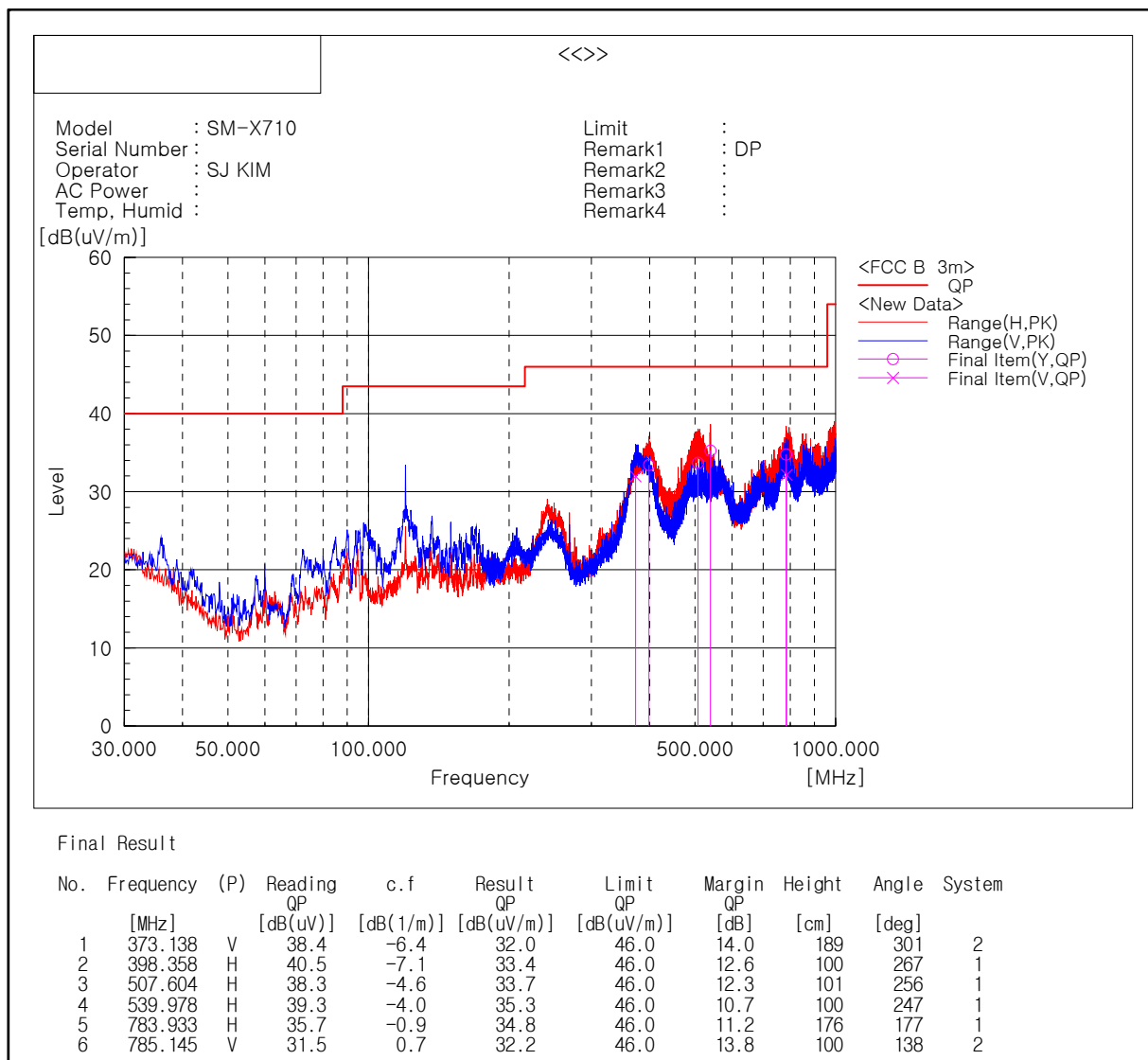

Note1) Receiving antenna polarization : Horizontal, Vertical

Test Distance : 3 m, Antenna Height : 1 to 4 meters

Result (QP) = Reading (QP) + c.f (Antenna Factor + Cable Loss - Amp. Gain)

Margin (QP) = Limit - Level (QP)

QP = Quasi-Peak, c.f = Correction Factor

- Frequencies above 1 GHz

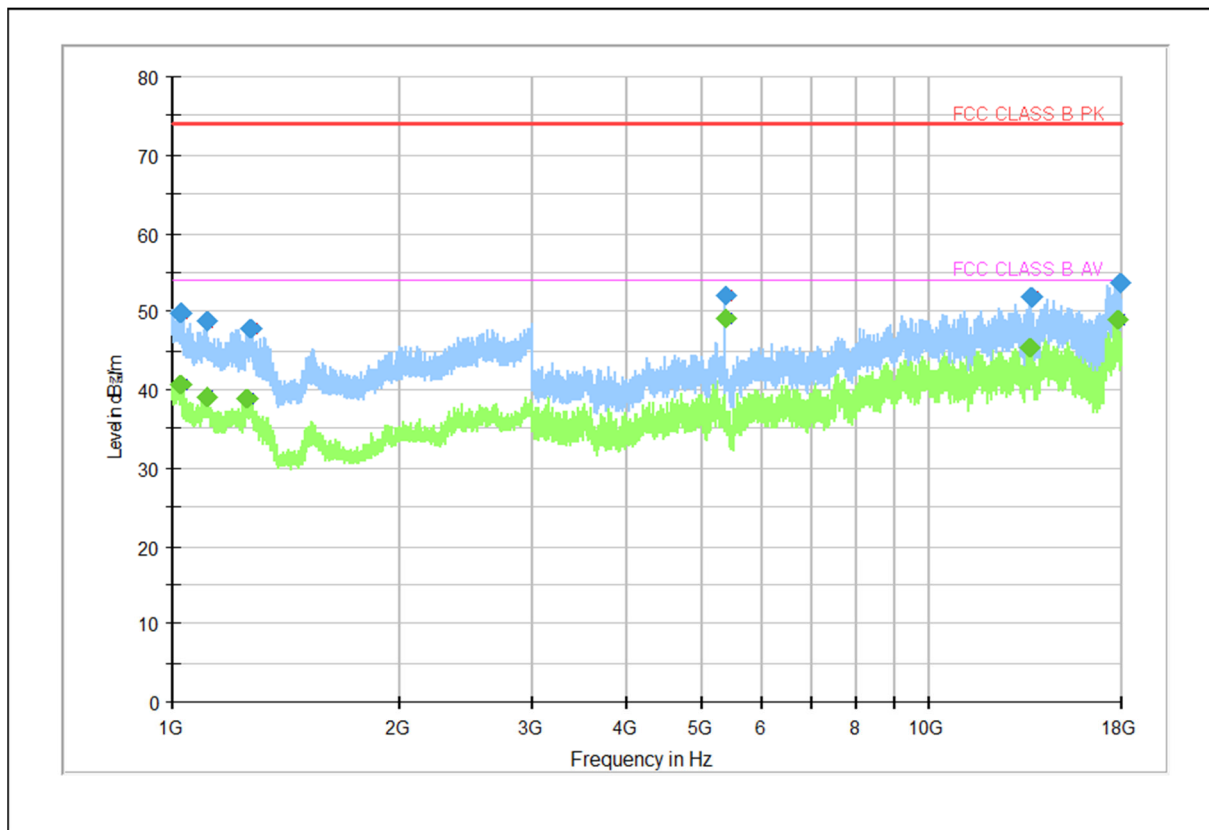

Frequency (MHz)	PK (dBµV/m)	CAV (dBµV/m)	Limit (dBµV/m)	Margin (dB)	Height (cm)	Pol	Azimuth (deg)	Corr. (dB)
1 023.000	---	40.66	54.00	13.34	101.00	V	216.00	10.30
1 023.000	49.89	---	74.00	24.11	112.00	V	216.00	10.30
1 108.800	48.76	---	74.00	25.24	106.00	H	162.00	9.90
1 110.400	---	39.09	54.00	14.91	100.00	H	162.00	9.80
1 253.600	---	38.97	54.00	15.03	107.00	H	237.00	10.30
1 266.000	47.82	---	74.00	26.18	109.00	H	237.00	10.40
5 399.500	---	49.16	54.00	4.84	115.00	H	120.00	12.10
5 400.000	52.01	---	74.00	21.99	101.00	H	128.00	12.10
13 619.500	---	45.41	54.00	8.59	102.00	H	164.00	34.30
13 636.000	51.88	---	74.00	22.12	100.00	H	120.00	34.20
17 801.500	---	48.97	54.00	5.03	110.00	H	146.00	40.80
17 862.500	53.60	---	74.00	20.40	105.00	V	348.00	39.40

Note 1) We have also tested from 18 GHz to 40 GHz and found no emissions.

Note 2) Receiving antenna polarization : Horizontal, Vertical

Test Distance : 3 m, Antenna Height : 1 to 4 meters

Level (PK and/or CAV) = Reading (PK and/or CAV) + Corr. (Antenna Factor + Cable Loss - Amp. Gain)

Margin (PK and/or CAV) = Limit – Level (PK and/or CAV)

PK = Peak, CAV = CISPR-Average, Corr. = Correction Factor

□ Operating Mode 5

- Frequencies below 1 GHz

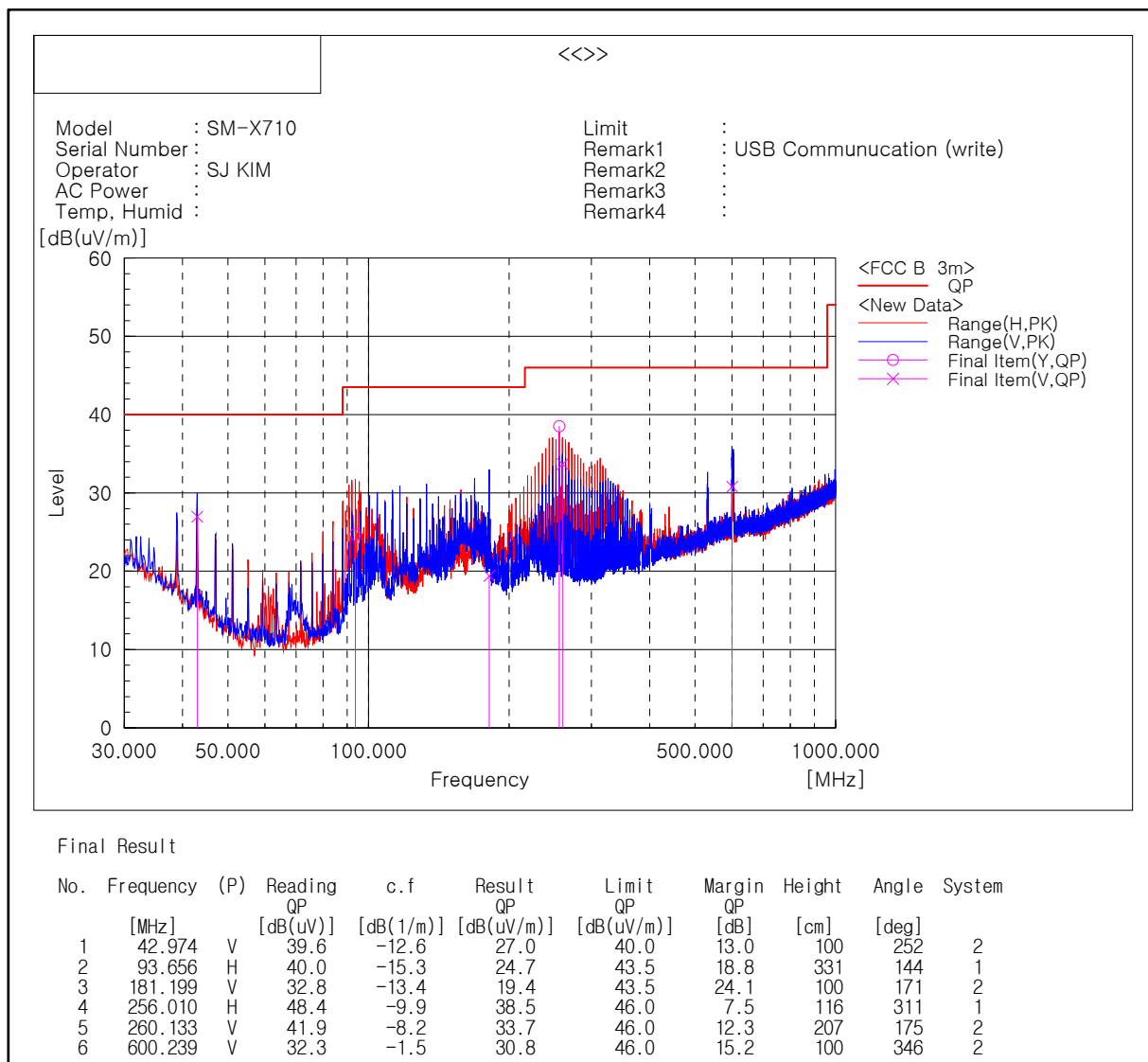

Note1) Receiving antenna polarization : Horizontal, Vertical

Test Distance : 3 m, Antenna Height : 1 to 4 meters

Result (QP) = Reading (QP) + c.f (Antenna Factor + Cable Loss - Amp. Gain)

Margin (QP) = Limit - Level (QP)

QP = Quasi-Peak, c.f = Correction Factor

- Frequencies above 1 GHz

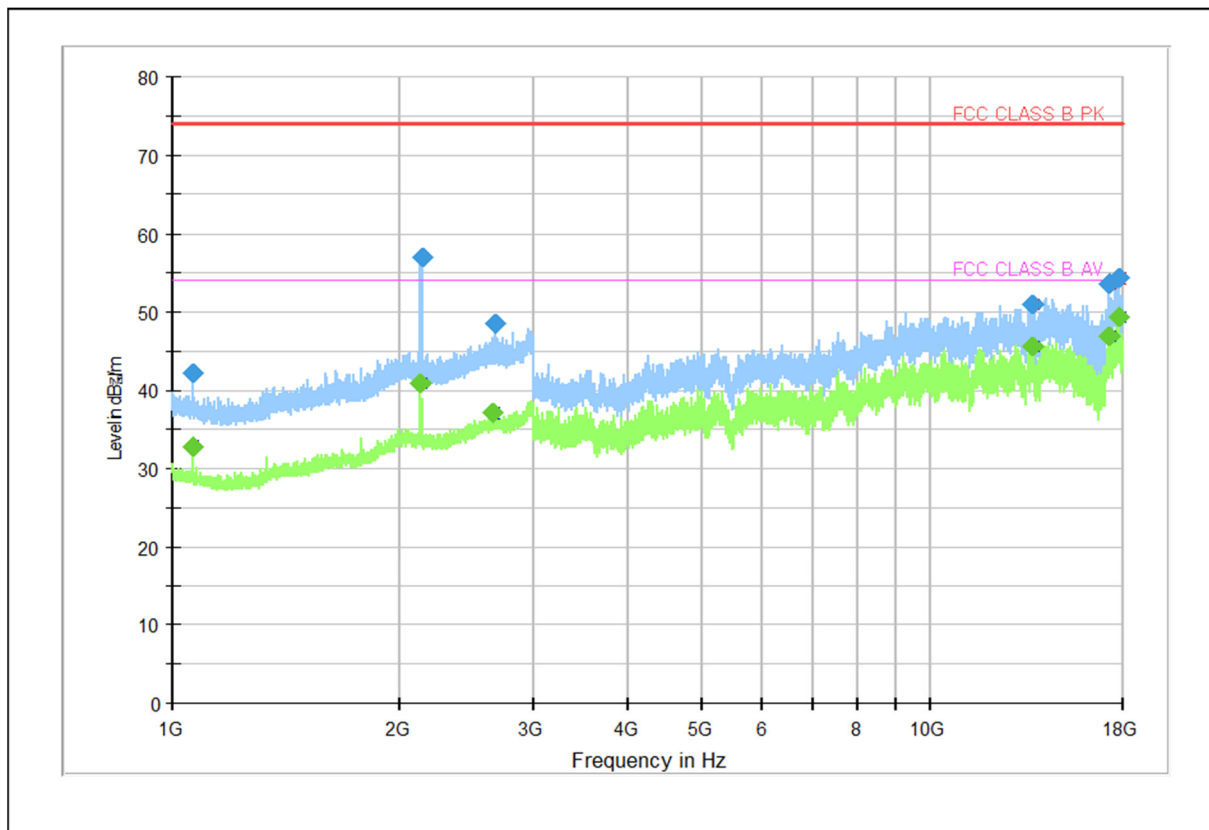

Frequency (MHz)	PK (dBµV/m)	CAV (dBµV/m)	Limit (dBµV/m)	Margin (dB)	Height (cm)	Pol	Azimuth (deg)	Corr. (dB)
1 061.600	42.31	---	74.00	31.69	105.00	V	17.00	10.00
1 063.800	---	32.76	54.00	21.24	100.00	V	6.00	10.10
2 124.400	---	41.00	54.00	13.00	103.00	V	262.00	17.00
2 130.400	57.05	---	74.00	16.95	101.00	V	151.00	16.90
2 654.800	---	37.01	54.00	16.99	116.00	V	278.00	19.40
2 658.000	48.39	---	74.00	25.61	107.00	V	191.00	19.40
13 647.000	50.96	---	74.00	23.04	101.00	V	109.00	34.10
13 659.000	---	45.54	54.00	8.46	101.00	V	250.00	34.00
17 211.500	53.65	---	74.00	20.35	109.00	V	80.00	39.10
17 224.500	---	46.98	54.00	7.02	104.00	V	0.00	39.30
17 796.500	54.39	---	74.00	19.61	100.00	H	81.00	40.80
17 796.500	---	49.49	54.00	4.51	102.00	H	81.00	40.80

Note 1) We have also tested from 18 GHz to 40 GHz and found no emissions.

Note 2) Receiving antenna polarization : Horizontal, Vertical

Test Distance : 3 m, Antenna Height : 1 to 4 meters

Level (PK and/or CAV) = Reading (PK and/or CAV) + Corr. (Antenna Factor + Cable Loss - Amp. Gain)

Margin (PK and/or CAV) = Limit – Level (PK and/or CAV)

PK = Peak, CAV = CISPR-Average, Corr. = Correction Factor