

UNII Straddle Ch. IEEE 802.11ax HE80(SU) mode Output Power and PSD

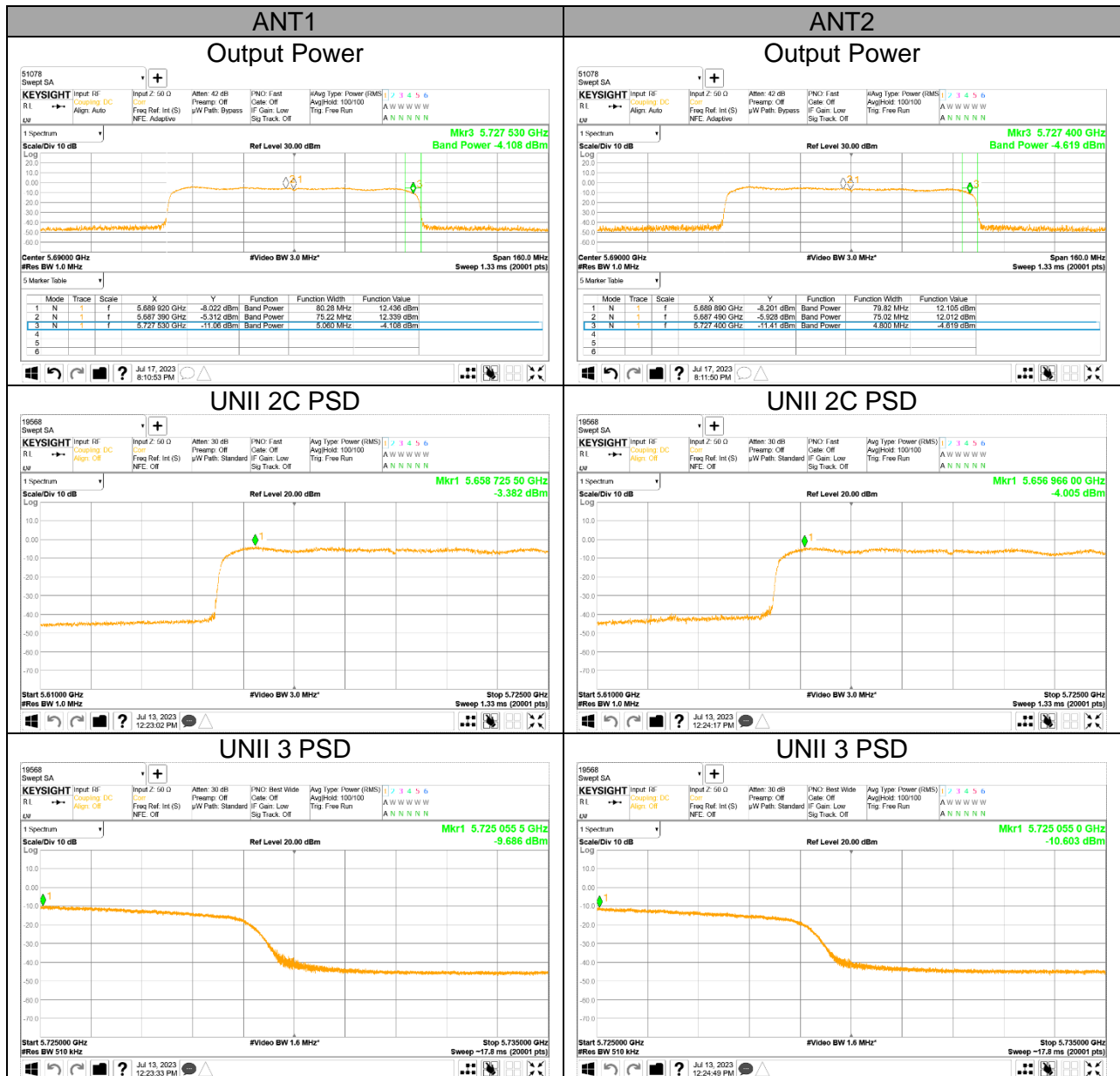

UNII Straddle Ch. IEEE 802.11ax HE20(6RU) mode Output Power and PSD

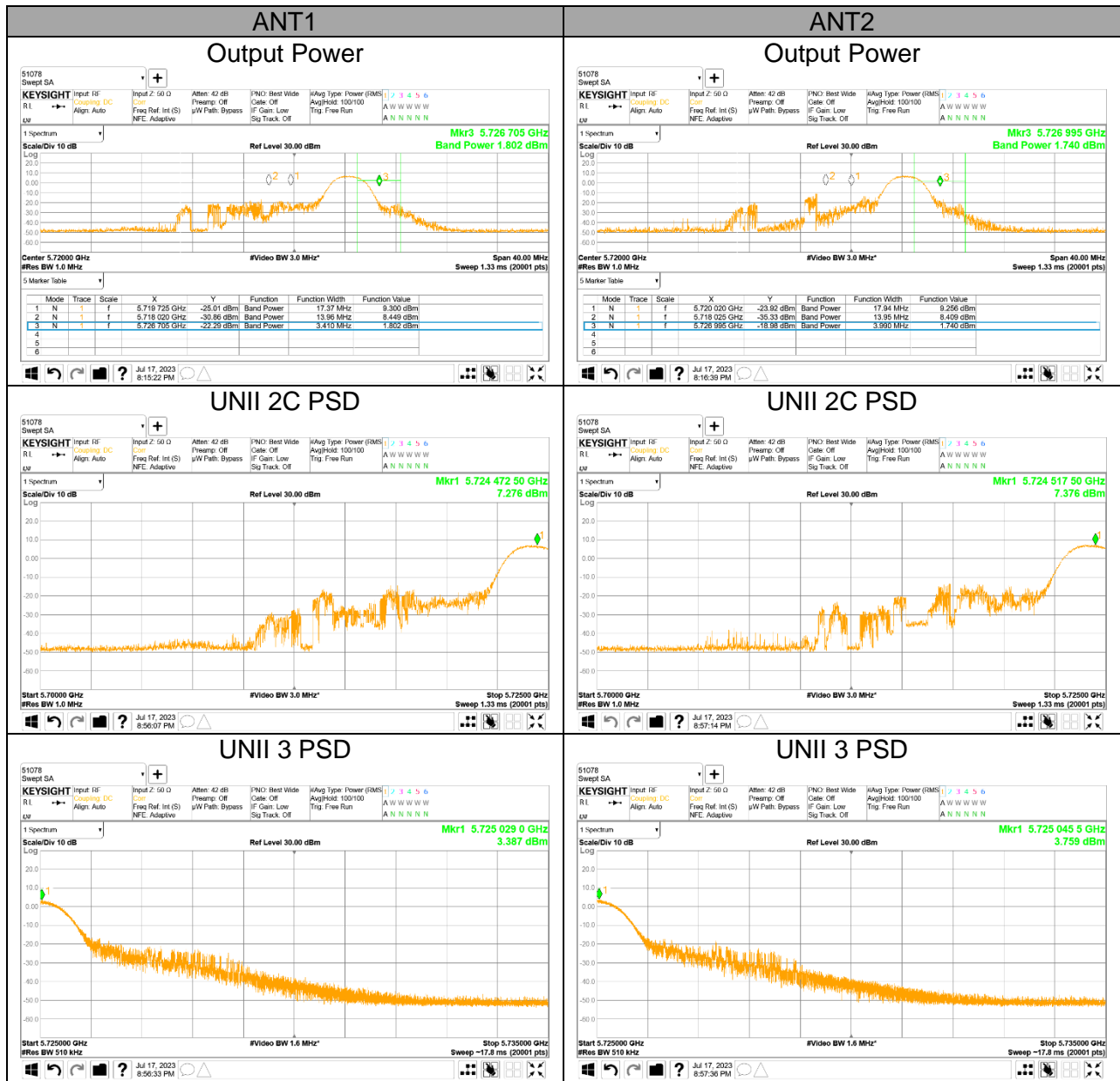

UNII Straddle Ch. IEEE 802.11ax HE40(15RU) mode Output Power and PSD

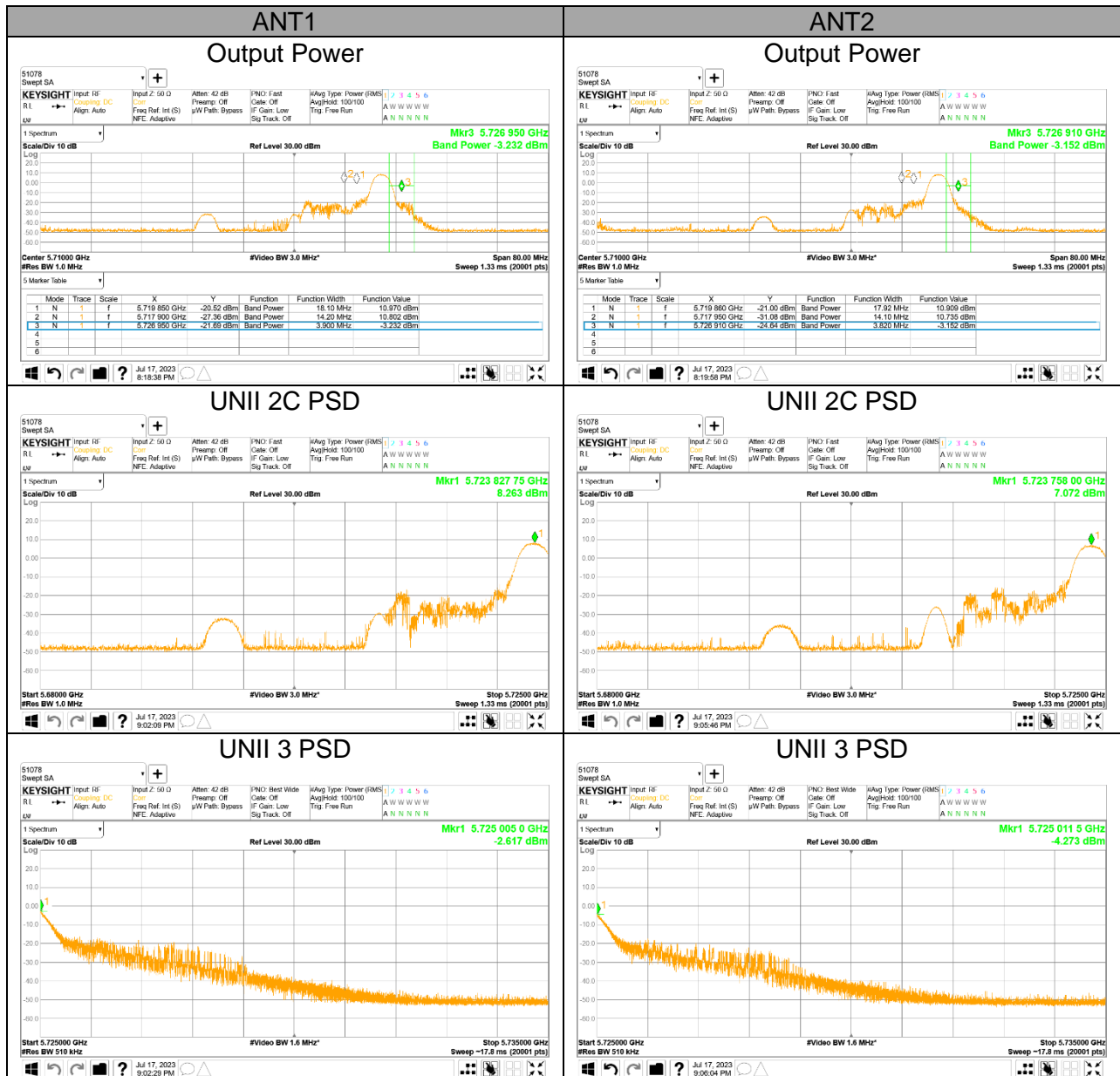

UNII Straddle Ch. IEEE 802.11ax HE80(34RU) mode Output Power and PSD

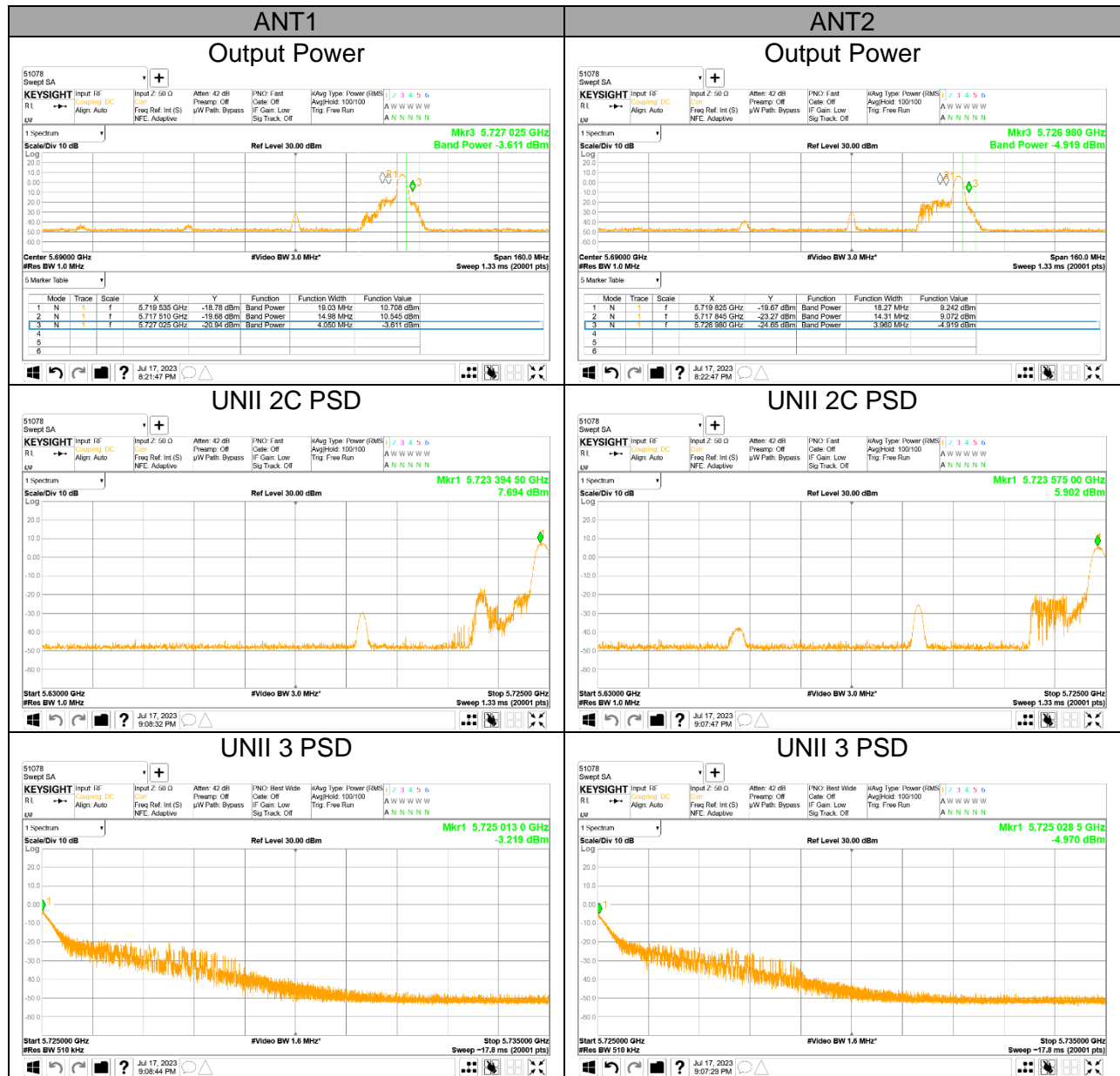

11. TRANSMITTER ABOVE 1 GHz

LIMITS

FCC §15.205 and §15.209

FCC §15.209 (a)

Frequency (MHz)	E-Field Strength (mV/meter)	Measurement Distance (m)
0.009–0.490	2400/F(kHz)	300
0.490–1.705	24000/F(kHz)	30
1.705–30.0	30	30
30–88	100	3
88 to 216	150	3
216 to 960	200	3
Above 960 MHz	500	3

Note: The lower limit shall apply at the transition frequency.

** Except as provided in paragraph (g), fundamental emissions from intentional radiators operating under this section shall not be located in the frequency bands 54-72 MHz, 76-88 MHz, 174-216 MHz or 470-806 MHz. However, operation within these frequency bands is permitted under other sections of this part, e.g. §§ 15.231 and 15.241.

IC RSS-GEN Sections 8.9 and 8.10.

Frequency (MHz)	H-Field Strength (mA/meter)	Measurement Distance (m)
0.009–0.490	6.37/F(kHz)	300
0.490–1.705	63.7/F(kHz)	30
1.705–30.0	0.08	30

Sample calculation (FCC Part 15.209 verse IC RSS-GEN 8.9)

FCC and IC limit are similar or have more margin, so FCC measurement data meets IC limit.

Standard \ Range	0.009 ~ 0.490	0.490 ~ 1.705	1.705 ~ 30.0
FCC(E-field)	48.52 ~ 13.80	33.80 ~ 22.97	29.54
IC(H-field)	-3.00 ~ -37.72	-17.72 ~ -28.55	-21.94
IC(H-field to E-field)Note1	48.50 ~ 13.78	33.78 ~ 22.95	29.56

Note1. $\text{dB}\mu\text{A/m} + 51.5 = \text{dB}\mu\text{V/m}$

FCC Part 15.205 (a) : Only spurious emissions are permitted in any of the frequency bands listed below :

MHz	MHz	MHz	MHz	GHz	GHz
0.009 ~ 0.110	8.41425 ~ 8.41475	108 ~ 121.94	1300 ~ 1427	4.5 ~ 5.15	14.47 ~ 14.5
0.495 ~ 0.505	12.29 ~ 12.293	123 ~ 138	1435 ~ 1626.5	5.35 ~ 5.46	15.35 ~ 16.2
2.1735 ~ 2.1905	12.51975 ~ 12.52025	149.9 ~ 150.05	1645.5 ~ 1646.5	7.25 ~ 7.75	17.7 ~ 21.4
4.125 ~ 4.128	12.57675 ~ 12.57725	156.52475 ~ 156.52525	1660 ~ 1710	8.025 ~ 8.5	22.01 ~ 23.12
4.17725 ~ 4.17775	13.36 ~ 13.41	156.7 ~ 156.9	1718.8 ~ 1722.2	9.0 ~ 9.2	23.6 ~ 24.0
4.20725 ~ 4.20775	16.42 ~ 16.423	162.0125 ~ 167.17	2200 ~ 2300	9.3 ~ 9.5	31.2 ~ 31.8
6.215 ~ 6.218	16.69475 ~ 16.69525	167.72 ~ 173.2	2310 ~ 2390	10.6 ~ 12.7	36.43 ~ 36.5
6.26775 ~ 6.26825	16.80425 ~ 16.80475	240 ~ 285	2483.5 ~ 2500	13.25 ~ 13.4	Above 38.6
6.31175 ~ 6.31225	25.5 ~ 25.67	322 ~ 335.4	2655 ~ 2900		
8.291 ~ 8.294	37.5 ~ 38.25	399.90 ~ 410	3260 ~ 3267		
8.362 ~ 8.366	73 ~ 74.6	608 ~ 614	3332 ~ 3339		
8.37625 ~ 8.38675	74.8 ~ 75.2	960 ~ 1240	3345.8 ~ 3358 3600 ~ 4400		

▪ FCC Part 15.205(b) : The field strength of emissions appearing within these frequency bands shall not exceed the limits shown in §15.209. At frequencies equal to or less than 1000 MHz, compliance with the limits in §15.209 shall be demonstrated using measurement instrumentation employing a CISPR quasi-peak detector. Above 1000 MHz, compliance with the emission limits in §15.209 shall be demonstrated based on the average value of the measured emissions. The provisions in §15.35 apply to these measurements.

FCC §15.407 (b)

(b) Undesirable emission limits. Except as shown in paragraph (b)(7) of this section, the maximum emissions outside of the frequency bands of operation shall be attenuated in accordance with the following limits:

- (1) For transmitters operating in the 5.15-5.25 GHz band: All emissions outside of the 5.15-5.35 GHz band shall not exceed an e.i.r.p. of -27 dBm/MHz.
- (2) For transmitters operating in the 5.25-5.35 GHz band: All emissions outside of the 5.15-5.35 GHz band shall not exceed an e.i.r.p. of -27 dBm/MHz.
- (3) For transmitters operating in the 5.47-5.725 GHz band: All emissions outside of the 5.47-5.725 GHz band shall not exceed an e.i.r.p. of -27 dBm/MHz.
- (4) For transmitters operating solely in the 5.850-5.895 GHz band or operating on a channel that spans across 5.725-5.895 GHz:

(iii) For a client device or indoor access point or subordinate device, all emissions below 5.725 GHz shall not exceed an e.i.r.p. of -27 dBm/MHz at 5.65 GHz increasing linearly to 10 dBm/MHz at 5.7 GHz, and from 5.7 GHz increasing linearly to a level of 15.6 dBm/MHz at 5.72 GHz, and from 5.72 GHz increasing linearly to a level of 27 dBm/MHz at 5.725 GHz

- (5) The emission measurements shall be performed using a minimum resolution bandwidth of 1 MHz. A lower resolution bandwidth may be employed near the band edge, when necessary,
provided the measured energy is integrated to show the total power over 1 MHz.
- (6) Unwanted emissions below 1 GHz must comply with the general field strength limits set forth in §15.209. Further, any U-NII devices using an AC power line are required to comply also with the conducted limits set forth in §15.207.
- (7) The provisions of §15.205 apply to intentional radiators operating under this section.
- (8) When measuring the emission limits, the nominal carrier frequency shall be adjusted as close to the upper and lower frequency band edges as the design of the equipment permits.

Note

- Limit translation to field strength level (FCC §15.407)

$$E[\text{dBuV/m}] = \text{EIRP}[\text{dBm}] + 95.2 = -27\text{dBm} + 95.2 = 68.2\text{dBuV/m}$$

$$E[\text{dBuV/m}] = \text{EIRP}[\text{dBm}] + 95.2 = -17\text{dBm} + 95.2 = 78.2\text{dBuV/m}$$

TEST PROCEDURE

The EUT is placed on a non-conducting table 80 cm above the ground plane for below 1GHz and 100 cm for above 1GHz. The antenna to EUT distance is 3 meters. The EUT is configured in accordance with ANSI C63.10. The EUT is set to transmit in a continuous mode.

For measurements below 1 GHz the resolution bandwidth is set to 100 kHz for peak detection measurements or 120 kHz for quasi-peak detection measurements. Peak detection is used unless otherwise noted as quasi-peak.

Reference to KDB 789033 D02 v02r01 UNII part G) 6) c) Method AD:

For measurements above 1 GHz the resolution bandwidth is set to 1 MHz; the video bandwidth is set to 3 MHz for peak measurements and add duty cycle factor to the reading offset for average measurements.

Pre-scans to detect harmonic and spurious emissions, the resolution bandwidth is set to 1 MHz; the video bandwidth is set to 30 kHz for peak measurements.

The spectrum from 1GHz to 40 GHz is investigated with the transmitter set to the lowest, middle, and highest channels in each applicable band.
(From 30MHz to 1GHz, test was performed with the EUT set to transmit at the channel with highest output power)

The frequency range of interest is monitored at a fixed antenna height and EUT azimuth. The EUT is rotated through 360 degrees to maximize emissions received. The antenna is scanned from 1 to 4 meters above the ground plane to further maximize the emission. Measurements are made with the antenna polarized in both the vertical and the horizontal positions.

Note : Emission was pre-scanned from 9kHz to 30MHz; No emissions were detected which was at least 20dB below the specification limit (consider distance correction factor).
Per FCC part 15.31(o), test results were not reported.

Although these tests were performed other than open field test site, adequate comparison measurements were confirmed against 30 m open are test site.
Therefore sufficient tests were made to demonstrate that the alternative site produces results that correlate with the one of tests made in an open field based on KDB 414788.

11.1. TX ABOVE 1GHz 2Tx MODE IN THE 5.2GHz BAND

BANDEDGE (WORST CASE: 802.11n HT40 / 5190 MHz)

HORIZONTAL PEAK AND AVERAGE DATA

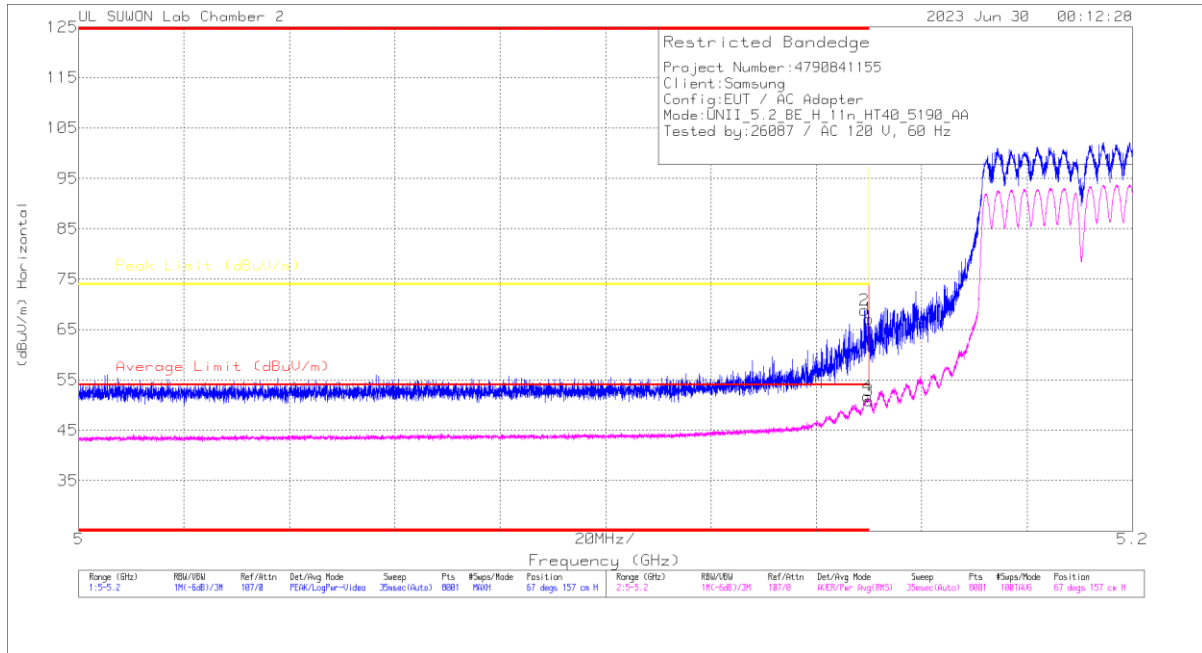

Trace Markers

Marker	Frequency (GHz)	Meter Reading (dBuV)	Det	3117_00168724	10dB_ATT(dB)	DC Corr (dB)	Corrected Reading (dBuV/m)	Average Limit (dBuV/m)	Margin (dB)	Peak Limit (dBuV/m)	PK Margin (dB)	Azimuth (Degs)	Height (cm)	Polarity
1	* 5.15	50.14	Pk	34.2	-17.2	0	67.14	-	-	74	-6.86	67	157	H
2	* 5.14918	51.76	Pk	34.2	-17.1	0	68.86	-	-	74	-5.14	67	157	H
3	* 5.15	33.73	RMS	34.2	-17.2	.1	50.83	54	-3.17	-	-	67	157	H
4	* 5.14978	34.7	RMS	34.2	-17.2	.1	51.8	54	-2.2	-	-	67	157	H

* - indicates frequency in CFR47 Pt 15 / IC RSS-Restricted Band

Pk - Peak detector

RMS - RMS detection

BANDEDGE TEST DATA

Mode	Freq. [MHz]	Antenna	Frequency [GHz]	Reading [dBuV]	Detector Mode	ANT Factor	Loss [dB]	DC Corr [dB]	Result [dBuV/m]	AV Limit [dBuV/m]	AV Margin [dB]	PK Limit [dBuV/m]	PK Margin [dB]	Azimuth [Degs]	Height [cm]	Polarity	
802.11a	5180	MIMO	* 5.15	37.27	Pk	34.20	-17.20	0.00	54.27	-	-	74.00	-19.73	66	115	H	
			* 5.14808	42.63	Pk	34.20	-17.10	0.00	59.73	-	-	74.00	-14.27	66	115	H	
			* 5.15	28.33	RMS	34.20	-17.20	0.14	45.47	54.00	-8.53	-	-	-	66	115	H
			* 5.1482	29.24	RMS	34.20	-17.10	0.14	46.48	54.00	-7.52	-	-	-	66	115	H
			* 5.15	38.63	Pk	34.20	-17.20	0.00	55.63	-	-	-	74.00	-18.37	85	106	V
			* 5.14545	43.16	Pk	34.20	-17.20	0.00	60.16	-	-	-	74.00	-13.84	85	106	V
			* 5.15	28.02	RMS	34.20	-17.20	0.14	45.16	54.00	-8.84	-	-	-	85	106	V
			* 5.14933	28.16	RMS	34.20	-17.10	0.14	45.40	54.00	-8.60	-	-	-	85	106	V
			* 5.15	37.63	Pk	34.20	-17.20	0.00	54.63	-	-	-	74.00	-19.37	65	118	H
			* 5.1468	44.78	Pk	34.20	-17.20	0.00	61.78	-	-	-	74.00	-12.22	65	118	H
802.11n (HT20)	5180	MIMO	* 5.15	28.31	RMS	34.20	-17.20	0.00	45.31	54.00	-8.69	-	-	65	118	H	
			* 5.04383	29.76	RMS	34.00	-17.30	0.00	46.46	54.00	-7.54	-	-	65	118	H	
			* 5.15	37.42	Pk	34.20	-17.20	0.00	54.42	-	-	-	74.00	-19.58	87	100	V
			* 5.14995	45.84	Pk	34.20	-17.20	0.00	62.84	-	-	-	74.00	-11.16	87	100	V
			* 5.15	27.86	RMS	34.20	-17.20	0.00	44.86	54.00	-9.14	-	-	-	87	100	V
			* 5.14915	27.98	RMS	34.20	-17.10	0.00	45.08	54.00	-8.92	-	-	-	87	100	V
			* 5.15	50.14	Pk	34.20	-17.20	0.00	67.14	-	-	-	74.00	-6.86	67	157	H
			* 5.14918	51.76	Pk	34.20	-17.10	0.00	68.86	-	-	-	74.00	-5.14	67	157	H
			* 5.15	33.73	RMS	34.20	-17.20	0.10	50.83	54.00	-3.17	-	-	-	67	157	H
			* 5.14978	34.70	RMS	34.20	-17.20	0.10	51.80	54.00	-2.20	-	-	-	67	157	H
802.11n (HT40)	5190	MIMO	* 5.15	51.71	Pk	34.20	-17.20	0.00	68.71	-	-	74.00	-5.29	88	109	V	
			* 5.14945	54.31	Pk	34.20	-17.20	0.00	71.31	-	-	74.00	-2.69	88	109	V	
			* 5.15	33.69	RMS	34.20	-17.20	0.10	50.79	54.00	-3.21	-	-	-	88	109	V
			* 5.14908	34.17	RMS	34.20	-17.10	0.10	51.37	54.00	-2.63	-	-	-	88	109	V
			* 5.15	45.46	Pk	34.20	-17.20	0.00	62.46	-	-	-	74.00	-11.54	68	208	H
			* 5.14815	48.59	Pk	34.20	-17.10	0.00	65.69	-	-	-	74.00	-8.31	68	208	H
			* 5.15	33.27	RMS	34.20	-17.20	0.44	50.71	54.00	-3.29	-	-	-	68	208	H
			* 5.14975	34.01	RMS	34.20	-17.20	0.44	51.45	54.00	-2.55	-	-	-	68	208	H
			* 5.15	40.71	Pk	34.20	-17.20	0.00	57.71	-	-	-	74.00	-16.29	87	149	V
			* 5.14768	45.67	Pk	34.20	-17.10	0.00	62.77	-	-	-	74.00	-11.23	87	149	V
802.11ac (VHT80)	5210	MIMO	* 5.15	30.91	RMS	34.20	-17.20	0.44	48.35	54.00	-5.65	-	-	87	149	V	
			* 5.14915	31.54	RMS	34.20	-17.10	0.44	49.08	54.00	-4.92	-	-	-	87	149	V
			* 5.15	42.92	Pk	34.50	-21.60	0.00	55.82	-	-	-	74.00	-18.18	67	226	H
			* 5.1491	51.88	Pk	34.50	-21.60	0.00	64.78	-	-	-	74.00	-9.22	67	226	H
			* 5.15	33.60	RMS	34.50	-21.60	0.15	46.65	54.00	-7.35	-	-	-	67	226	H
			* 5.04395	36.39	RMS	34.30	-21.70	0.15	49.14	54.00	-4.86	-	-	-	67	226	H
			* 5.15	47.89	Pk	34.50	-21.60	0.00	60.79	-	-	-	74.00	-13.21	94	100	V
			* 5.14798	51.01	Pk	34.50	-21.60	0.00	63.91	-	-	-	74.00	-10.09	94	100	V
			* 5.15	32.81	RMS	34.50	-21.60	0.15	45.86	54.00	-8.14	-	-	-	94	100	V
			* 5.14798	33.52	RMS	34.50	-21.60	0.15	46.57	54.00	-7.43	-	-	-	94	100	V
802.11ax (HE20)	5180	MIMO	* 5.15	47.60	Pk	34.50	-23.60	0.00	58.50	-	-	74.00	-15.50	65	203	H	
			* 5.14403	50.71	Pk	34.50	-23.60	0.00	61.61	-	-	74.00	-12.39	65	203	H	
			* 5.15	37.98	RMS	34.50	-23.60	0.35	49.23	54.00	-4.77	-	-	-	65	203	H
			* 5.14995	37.93	RMS	34.50	-23.60	0.35	49.18	54.00	-4.82	-	-	-	65	203	H
			* 5.15	49.18	Pk	34.50	-23.60	0.00	60.08	-	-	-	74.00	-13.92	93	134	V
			* 5.14278	50.07	Pk	34.50	-23.60	0.00	60.97	-	-	-	74.00	-13.03	93	134	V
			* 5.15	36.46	RMS	34.50	-23.60	0.35	47.71	54.00	-6.29	-	-	-	93	134	V
			* 5.14975	36.82	RMS	34.50	-23.60	0.35	48.07	54.00	-5.93	-	-	-	93	134	V
			* 5.15	47.14	Pk	34.50	-23.60	0.00	58.04	-	-	-	74.00	-15.96	68	120	H
			* 5.14785	51.69	Pk	34.50	-23.60	0.00	62.59	-	-	-	74.00	-11.41	68	120	H
802.11ax (HE40)	5190	MIMO	* 5.15	35.31	RMS	34.50	-23.60	0.42	46.63	54.00	-7.37	-	-	68	120	H	
			* 5.1479	36.82	RMS	34.50	-23.60	0.42	48.14	54.00	-5.86	-	-	-	68	120	H
			* 5.15	47.37	Pk	34.50	-23.60	0.00	58.27	-	-	-	74.00	-15.73	86	100	V
			* 5.14785	50.18	Pk	34.50	-23.60	0.00	61.08	-	-	-	74.00	-12.92	86	100	V
			* 5.15	34.08	RMS	34.50	-23.60	0.42	45.40	54.00	-8.60	-	-	-	86	100	V
			* 5.1496	34.80	RMS	34.50	-23.60	0.42	46.12	54.00	-7.88	-	-	-	86	100	V

Note1. Pk - Peak detector, RMS - RMS detector
 Note2. * - indicates frequency in CFR47 Pt 15 / IC RSS-Restricted Band

HARMONICS AND SPURIOUS EMISSIONS(WORST CASE: 802.11ax HE20 4RU / 5180 MHz)
5180 MHz HORIZONTAL

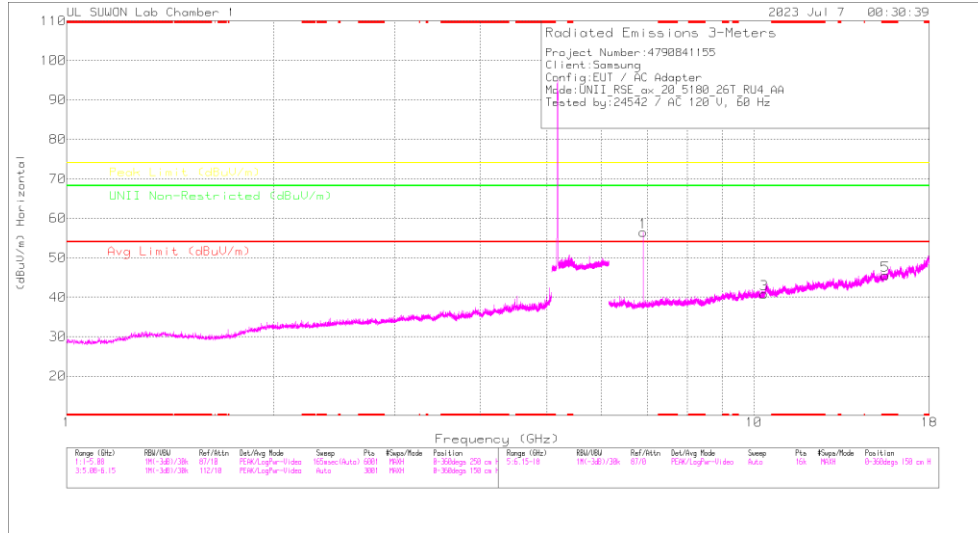

5180 MHz VERTICAL

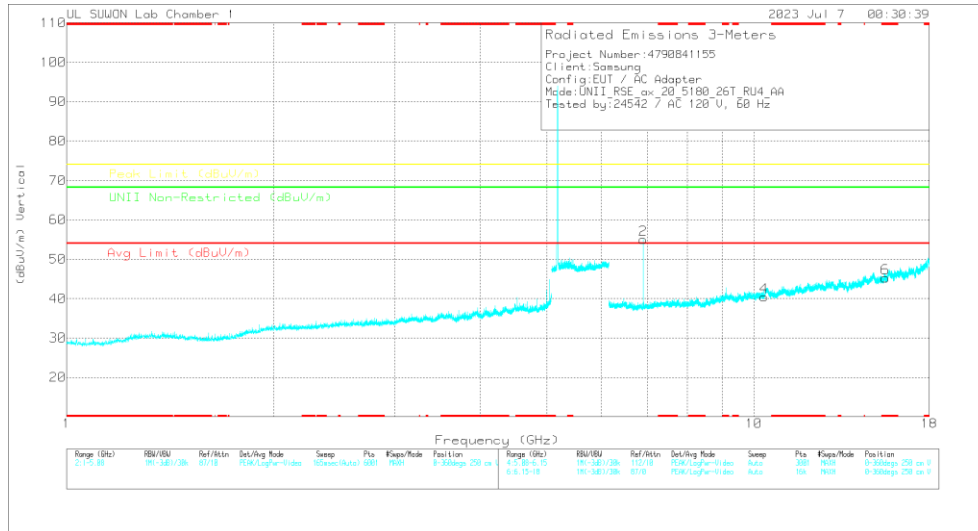

Note: Emission was scanned up to 40GHz; No emissions were detected above the noise floor which was at least 20dB below the specification limit.

5180 MHz DATA

Radiated Emissions

Frequency (GHz)	Meas Reading (dBuV)	Det	317_00188717	6GHz_HF(dB)	DC Corr (dB)	Corrected Reading (dBuV)	Avg Limit (dBuV/m)	Meas (dB)	Peak Limit (dBuV/m)	Meas (dB)	Limit Non-Restricted (dBuV/m)	Meas (dB)	Asmth (Flags)	Height (dB)	Priority
6.90653	54.25	PK-U	35.6	-30.3	0	59.55	-	-	-	-	68.2	-8.65	69	140	H
6.90655	52.94	PK-U	35.6	-30.3	0	58.24	-	-	-	-	68.2	-9.96	92	256	V
10.36216	41.37	PK-U	37.7	-27.5	0	51.57	-	-	-	-	68.2	-16.63	0	100	H
10.36289	41.06	PK-U	37.7	-27.5	0	51.26	-	-	-	-	68.2	-16.94	92	100	V
* 15.54064	38.35	PK-U	40.2	-23	0	55.55	-	-	74	-18.45	-	-	0	100	H
* 15.54	38.35	PK-U	40.2	-23	0	55.55	-	-	74	-18.45	-	-	92	100	V

* - indicates frequency in CFR47 Pt 15 / IC RSS-Restricted Band
 PK-U - U-NII: Maximum Peak

HARMONICS AND SPURIOUS EMISSIONS TEST DATA

Mode	Freq. [MHz]	Antenna	Frequency [GHz]	Reading [dBuV]	Detector Mode	ANT Factor	Loss [dB]	DC Corr [dB]	Result [dBuV/m]	AV Limit [dBuV/m]	AV Margin [dB]	PK Limit [dBuV/m]	PK Margin [dB]	Non-Restricted [dBuV/m]	Margin [dB]	Azimuth [Degs]	Height [cm]	Polarity		
802.11a	5180	MIMO	6.907	46.87	PK-U	35.50	-24.30	0.00	58.07	-	-	-	-	-	68.20	-10.13	69	136	H	
			6.907	45.11	PK-U	35.50	-24.30	0.00	56.31	-	-	-	-	-	-	68.20	-11.89	89	104	V
			10.361	33.16	PK-U	37.60	-20.40	0.00	50.36	-	-	-	-	-	-	68.20	-17.84	0	100	H
			10.358	34.06	PK-U	37.60	-20.40	0.00	51.26	-	-	-	-	-	-	68.20	-16.94	0	100	V
			* 15.53884	33.17	PK-U	39.90	-19.10	0.00	53.97	-	-	-	-	74.00	-20.03	-	-	0	100	H
	* 15.53982	33.29	PK-U	39.90	-19.10	0.00	54.09	-	-	-	-	74.00	-19.91	-	-	0	100	V		
	5200	MIMO	6.933	46.14	PK-U	35.60	-24.30	0.00	57.44	-	-	-	-	-	68.20	-10.76	69	131	H	
			6.933	44.72	PK-U	35.60	-24.30	0.00	56.02	-	-	-	-	-	68.20	-12.18	90	250	V	
			10.400	33.72	PK-U	37.60	-20.50	0.00	50.82	-	-	-	-	-	68.20	-17.38	0	100	H	
			10.401	34.00	PK-U	37.60	-20.50	0.00	51.10	-	-	-	-	-	68.20	-17.10	0	100	V	
			* 15.60072	34.36	PK-U	40.00	-19.60	0.00	54.76	-	-	-	-	74.00	-19.24	-	-	0	100	H
	* 15.59915	34.35	PK-U	40.00	-19.60	0.00	54.75	-	-	-	-	74.00	-19.25	-	-	0	100	V		
	5240	MIMO	6.987	44.07	PK-U	35.60	-24.70	0.00	54.97	-	-	-	-	-	68.20	-13.23	69	139	H	
			6.987	42.84	PK-U	35.60	-24.70	0.00	53.74	-	-	-	-	-	68.20	-14.46	93	176	V	
			10.480	33.78	PK-U	37.70	-20.10	0.00	51.38	-	-	-	-	-	68.20	-16.82	0	100	H	
10.479			33.06	PK-U	37.70	-20.10	0.00	50.66	-	-	-	-	-	68.20	-17.54	0	100	V		
* 15.71824			34.86	PK-U	40.10	-18.80	0.00	56.16	-	-	-	-	74.00	-17.84	-	-	0	100	H	
* 15.71949	34.72	PK-U	40.10	-18.80	0.00	56.02	-	-	-	-	74.00	-17.98	-	-	0	100	V			
802.11n HT20	5180	MIMO	6.907	46.79	PK-U	35.50	-24.30	0.00	57.99	-	-	-	-	-	68.20	-10.21	69	137	H	
			6.907	45.30	PK-U	35.50	-24.30	0.00	56.50	-	-	-	-	-	68.20	-11.70	85	106	V	
			10.359	33.12	PK-U	37.60	-20.40	0.00	50.32	-	-	-	-	-	68.20	-17.88	0	100	H	
			10.362	34.29	PK-U	37.60	-20.40	0.00	51.49	-	-	-	-	-	68.20	-16.71	0	100	V	
			* 15.53909	33.50	PK-U	39.90	-19.10	0.00	54.30	-	-	-	-	74.00	-19.70	-	-	0	100	H
* 15.54083	33.62	PK-U	39.90	-19.10	0.00	54.42	-	-	-	-	74.00	-19.58	-	-	0	100	V			
802.11n HT40	5190	MIMO	6.920	45.98	PK-U	35.60	-24.30	0.00	57.28	-	-	-	-	-	68.20	-10.92	68	134	H	
			6.920	45.31	PK-U	35.60	-24.30	0.00	56.61	-	-	-	-	-	68.20	-11.59	87	107	V	
			10.382	33.24	PK-U	37.60	-20.50	0.00	50.34	-	-	-	-	-	68.20	-17.86	0	100	H	
			* 10.382	33.32	PK-U	37.60	-20.50	0.00	50.42	-	-	-	-	-	68.20	-17.78	0	100	V	
			* 15.57046	33.78	PK-U	40.00	-19.00	0.00	54.78	-	-	-	-	74.00	-19.22	-	-	0	100	H
* 15.57159	34.60	PK-U	40.00	-19.00	0.00	55.60	-	-	-	-	74.00	-18.40	-	-	0	100	V			
802.11ac VHT80	5210	MIMO	6.946	45.81	PK-U	35.60	-24.30	0.00	57.11	-	-	-	-	-	68.20	-11.09	69	134	H	
			6.947	43.93	PK-U	35.60	-24.30	0.00	55.23	-	-	-	-	-	68.20	-12.97	79	107	V	
			10.419	33.51	PK-U	37.60	-20.40	0.00	50.71	-	-	-	-	-	68.20	-17.49	0	100	H	
			10.421	33.51	PK-U	37.60	-20.40	0.00	50.71	-	-	-	-	-	68.20	-17.49	0	100	V	
			* 15.63182	34.29	PK-U	40.00	-19.50	0.00	54.79	-	-	-	-	74.00	-19.21	-	-	0	100	H
* 15.62943	35.64	PK-U	40.00	-19.50	0.00	56.14	-	-	-	-	74.00	-17.86	-	-	0	100	V			
802.11ax (HE20) 4RU Spot-Check	5180	MIMO	6.907	54.25	PK-U	35.60	-30.30	0.00	59.55	-	-	-	-	-	68.20	-8.65	69	140	H	
			6.907	52.94	PK-U	35.60	-30.30	0.00	58.24	-	-	-	-	-	68.20	-9.96	92	256	V	
			10.362	41.37	PK-U	37.70	-27.50	0.00	51.57	-	-	-	-	-	68.20	-16.63	0	100	H	
			10.361	41.06	PK-U	37.70	-27.50	0.00	51.26	-	-	-	-	-	68.20	-16.94	92	100	V	
			* 15.54064	38.35	PK-U	40.20	-23.00	0.00	55.55	-	-	-	-	74.00	-18.45	-	-	0	100	H
	* 15.54	38.35	PK-U	40.20	-23.00	0.00	55.55	-	-	-	-	74.00	-18.45	-	-	92	100	V		
	5200	MIMO	6.933	52.83	PK-U	35.60	-30.00	0.00	58.43	-	-	-	-	-	68.20	-9.77	68	134	H	
			6.933	51.71	PK-U	35.60	-30.00	0.00	57.31	-	-	-	-	-	68.20	-10.89	82	179	V	
			10.401	40.66	PK-U	37.70	-26.10	0.00	52.26	-	-	-	-	-	68.20	-15.94	0	100	H	
			10.401	40.52	PK-U	37.70	-26.10	0.00	52.12	-	-	-	-	-	68.20	-16.08	0	100	V	
			* 15.60147	37.81	PK-U	40.20	-22.60	0.00	55.41	-	-	-	-	74.00	-18.59	-	-	0	100	H
	* 15.59916	38.88	PK-U	40.20	-22.70	0.00	56.38	-	-	-	-	74.00	-17.62	-	-	0	100	V		
	5240	MIMO	6.987	50.85	PK-U	35.70	-30.00	0.00	56.55	-	-	-	-	-	68.20	-11.65	67	136	H	
			6.987	50.25	PK-U	35.70	-30.00	0.00	55.95	-	-	-	-	-	68.20	-12.25	85	177	V	
			10.483	40.44	PK-U	37.80	-26.40	0.00	51.84	-	-	-	-	-	68.20	-16.36	0	100	H	
10.481			40.17	PK-U	37.80	-26.30	0.00	51.67	-	-	-	-	-	68.20	-16.53	0	100	V		
* 15.71842			38.61	PK-U	40.30	-21.80	0.00	57.11	-	-	-	-	74.00	-16.89	-	-	0	100	H	
* 15.71892	38.88	PK-U	40.30	-21.80	0.00	57.38	-	-	-	-	74.00	-16.62	-	-	0	100	V			
802.11ax (HE40) 9RU Spot-Check	5190	MIMO	6.920	53.50	PK-U	35.60	-30.10	0.00	59.00	-	-	-	-	-	68.20	-9.20	67	145	H	
			6.920	51.79	PK-U	35.60	-30.10	0.00	57.29	-	-	-	-	-	68.20	-10.91	86	178	V	
			10.388	40.80	PK-U	37.70	-26.60	0.00	51.90	-	-	-	-	-	68.20	-16.30	0	100	H	
			10.379	41.22	PK-U	37.70	-27.00	0.00	51.92	-	-	-	-	-	68.20	-16.28	0	100	V	
			* 15.57682	37.98	PK-U	40.20	-22.80	0.00	55.38	-	-	-	-	74.00	-18.62	-	-	0	100	H
* 15.56364	38.67	PK-U	40.20	-23.00	0.00	55.87	-	-	-	-	74.00	-18.13	-	-	0	100	V			
802.11ax (HE80) 18RU Spot-Check	5210	MIMO	6.947	51.94	PK-U	35.60	-29.90	0.00	57.64	-	-	-	-	-	68.20	-10.56	67	143	H	
			6.947	50.46	PK-U	35.60	-29.90	0.00	56.16	-	-	-	-	-	68.20	-12.04	87	243	V	
			10.413	40.70	PK-U	37.70	-25.90	0.00	52.50	-	-	-	-	-	68.20	-15.70	0	100	H	
			10.411	40.18	PK-U	37.70	-25.90	0.00	51.98	-	-	-	-	-	68.20	-16.22	0	100	V	
			* 15.6259	38.49	PK-U	40.20	-22.60	0.00	56.09	-	-	-	-	74.00	-17.91	-	-	0	100	H
* 15.62227	38.14	PK-U	40.20	-22.60	0.00	55.74	-	-	-	-	74.00	-18.26	-	-	0	100	V			

Note1. PK-U - U-NII: Maximum Peak
 Note2. * - indicates frequency in CFR47 Pt 15 / IC RSS-Restricted Band

11.2. TX ABOVE 1GHz 2Tx MODE IN THE 5.3GHz BAND

BANDEDGE (WORST CASE: 802.11ac VHT80 / 5290 MHz)

HORIZONTAL PEAK AND AVERAGE DATA

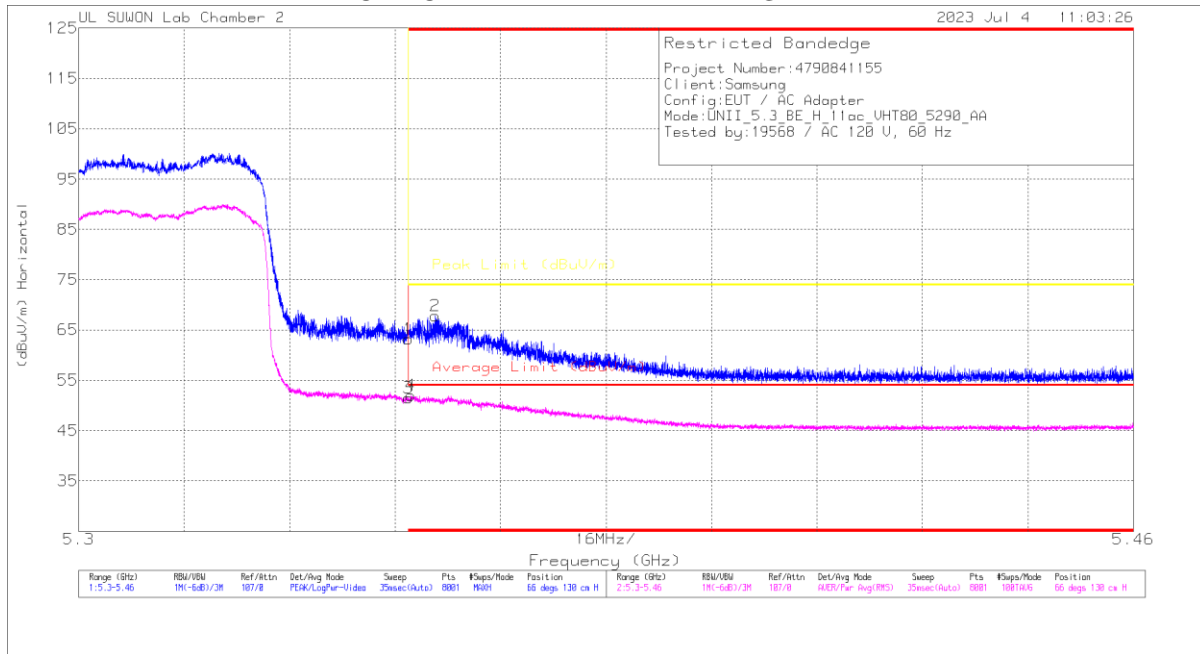

Trace Markers

Marker	Frequency (GHz)	Meter Reading (dBuV)	Det	3117_00168724	10dB_ATT(dB)	DC Corr (dB)	Corrected Reading (dBuV/m)	Average Limit (dBuV/m)	Margin (dB)	Peak Limit (dBuV/m)	PK Margin (dB)	Azimuth (Degs)	Height (m)	Polarity
1	* 5.35002	45.98	PK	34.4	-17.2	0	63.18	-	-	74	-10.82	66	130	H
2	* 5.35008	50.66	PK	34.4	-17.2	0	67.86	-	-	74	-6.14	66	130	H
3	* 5.35002	33.82	RMS	34.4	-17.2	.44	51.46	54	-2.54	-	-	66	130	H
4	* 5.35042	34.31	RMS	34.4	-17.2	.44	51.95	54	-2.05	-	-	66	130	H

* - indicates frequency in CFR47 Pt 15 / IC RSS-Restricted Band

Pk - Peak detector

RMS - RMS detection

BANDEDGE TEST DATA

Mode	Freq. [MHz]	Antenna	Frequency [GHz]	Reading [dBuV]	Detector Mode	ANT Factor	Loss [dB]	DC Corr [dB]	Result [dBuV/m]	AV Limit [dBuV/m]	AV Margin [dB]	PK Limit [dBuV/m]	PK Margin [dB]	Azimuth [Degs]	Height [cm]	Polarity
802.11a	5320	MIMO	* 5.35002	47.29	Pk	34.40	-17.20	0.00	64.49	-	-	74.00	-9.51	66	115	H
			* 5.35098	48.18	Pk	34.40	-17.20	0.00	65.38	-	-	74.00	-8.62	66	115	H
			* 5.35002	31.87	RMS	34.40	-17.20	0.14	49.21	54.00	-4.79	-	-	66	115	H
			* 5.35126	33.10	RMS	34.40	-17.20	0.14	50.44	54.00	-3.56	-	-	66	115	H
			* 5.35002	46.85	Pk	34.40	-17.20	0.00	64.05	-	-	74.00	-9.95	81	100	V
			* 5.35106	48.20	Pk	34.40	-17.20	0.00	65.40	-	-	74.00	-8.60	81	100	V
			* 5.35002	32.27	RMS	34.40	-17.20	0.14	49.61	54.00	-4.39	-	-	81	100	V
			* 5.35062	32.54	RMS	34.40	-17.20	0.14	49.88	54.00	-4.12	-	-	81	100	V
802.11n (HT20)	5320	MIMO	* 5.35002	47.59	Pk	34.40	-17.20	0.00	64.79	-	-	74.00	-9.21	68	115	H
			* 5.35084	49.17	Pk	34.40	-17.20	0.00	66.37	-	-	74.00	-7.63	68	115	H
			* 5.35002	31.05	RMS	34.40	-17.20	0.00	48.25	54.00	-5.75	-	-	68	115	H
			* 5.35036	32.05	RMS	34.40	-17.20	0.00	49.25	54.00	-4.75	-	-	68	115	H
			* 5.35002	47.59	Pk	34.40	-17.20	0.00	64.79	-	-	74.00	-9.21	81	100	V
			* 5.35094	49.26	Pk	34.40	-17.20	0.00	66.46	-	-	74.00	-7.54	81	100	V
			* 5.35002	31.28	RMS	34.40	-17.20	0.00	48.48	54.00	-5.52	-	-	81	100	V
			* 5.35016	31.46	RMS	34.40	-17.20	0.00	48.66	54.00	-5.34	-	-	81	100	V
802.11n (HT40)	5310	MIMO	* 5.35002	46.80	Pk	34.40	-17.20	0.00	64.00	-	-	74.00	-10.00	69	181	H
			* 5.35082	49.49	Pk	34.40	-17.20	0.00	66.69	-	-	74.00	-7.31	69	181	H
			* 5.35002	34.07	RMS	34.40	-17.20	0.10	51.37	54.00	-2.63	-	-	69	181	H
			* 5.35014	34.24	RMS	34.40	-17.20	0.10	51.54	54.00	-2.46	-	-	69	181	H
			* 5.35002	44.34	Pk	34.40	-17.20	0.00	61.54	-	-	74.00	-12.46	89	135	V
			* 5.35068	47.86	Pk	34.40	-17.20	0.00	65.06	-	-	74.00	-8.94	89	135	V
			* 5.35002	33.07	RMS	34.40	-17.20	0.10	50.37	54.00	-3.63	-	-	89	135	V
			* 5.35004	33.44	RMS	34.40	-17.20	0.10	50.74	54.00	-3.26	-	-	89	135	V
802.11ac (VHT80)	5290	MIMO	* 5.35002	45.98	Pk	34.40	-17.20	0.00	63.18	-	-	74.00	-10.82	66	130	H
			* 5.35408	50.66	Pk	34.40	-17.20	0.00	67.86	-	-	74.00	-6.14	66	130	H
			* 5.35002	33.82	RMS	34.40	-17.20	0.44	51.46	54.00	-2.54	-	-	66	130	H
			* 5.35042	34.31	RMS	34.40	-17.20	0.44	51.95	54.00	-2.05	-	-	66	130	H
			* 5.35002	43.83	Pk	34.40	-17.20	0.00	61.03	-	-	74.00	-12.97	90	108	V
			* 5.35396	47.82	Pk	34.40	-17.20	0.00	65.02	-	-	74.00	-8.98	90	108	V
			* 5.35002	31.24	RMS	34.40	-17.20	0.44	48.88	54.00	-5.12	-	-	90	108	V
			* 5.35092	31.88	RMS	34.40	-17.20	0.44	49.52	54.00	-4.48	-	-	90	108	V
802.11ax (HE20)	5320	MIMO	* 5.35002	51.18	Pk	34.60	-21.30	0.00	64.48	-	-	74.00	-9.52	67	137	H
			* 5.35168	54.29	Pk	34.60	-21.30	0.00	67.59	-	-	74.00	-6.41	67	137	H
			* 5.35002	38.02	RMS	34.60	-21.30	0.15	51.47	54.00	-2.53	-	-	67	137	H
			* 5.35026	38.00	RMS	34.60	-21.30	0.15	51.45	54.00	-2.55	-	-	67	137	H
			* 5.35002	50.14	Pk	34.60	-21.30	0.00	63.44	-	-	74.00	-10.56	93	99	V
			* 5.35128	55.94	Pk	34.60	-21.30	0.00	69.24	-	-	74.00	-4.76	93	99	V
			* 5.35002	37.54	RMS	34.60	-21.30	0.15	50.99	54.00	-3.01	-	-	93	100	V
			* 5.35042	37.56	RMS	34.60	-21.30	0.15	51.01	54.00	-2.99	-	-	93	100	V
802.11ax (HE40)	5310	MIMO	* 5.35002	49.15	Pk	34.60	-23.10	0.00	60.65	-	-	74.00	-13.35	68	141	H
			* 5.35128	54.10	Pk	34.60	-23.20	0.00	65.50	-	-	74.00	-8.50	68	141	H
			* 5.35002	39.15	RMS	34.60	-23.10	0.35	51.00	54.00	-3.00	-	-	68	141	H
			* 5.35018	39.57	RMS	34.60	-23.10	0.35	51.42	54.00	-2.58	-	-	68	141	H
			* 5.35002	51.23	Pk	34.60	-23.10	0.00	62.73	-	-	74.00	-11.27	91	101	V
			* 5.35024	55.62	Pk	34.60	-23.10	0.00	67.12	-	-	74.00	-6.88	91	101	V
			* 5.35002	38.90	RMS	34.60	-23.10	0.35	50.75	54.00	-3.25	-	-	91	101	V
			* 5.35004	39.38	RMS	34.60	-23.10	0.35	51.23	54.00	-2.77	-	-	91	101	V
802.11ax (HE80)	5290	MIMO	* 5.35002	45.79	Pk	34.60	-23.10	0.00	57.29	-	-	74.00	-16.71	65	127	H
			* 5.35234	56.31	Pk	34.60	-23.20	0.00	67.71	-	-	74.00	-6.29	65	127	H
			* 5.35002	36.53	RMS	34.60	-23.10	0.42	48.45	54.00	-5.55	-	-	65	127	H
			* 5.35086	37.47	RMS	34.60	-23.10	0.42	49.39	54.00	-4.61	-	-	65	127	H
			* 5.35002	48.19	Pk	34.60	-23.10	0.00	59.69	-	-	74.00	-14.31	83	113	V
			* 5.3537	53.61	Pk	34.60	-23.20	0.00	65.01	-	-	74.00	-8.99	83	113	V
			* 5.35002	36.38	RMS	34.60	-23.10	0.42	48.30	54.00	-5.70	-	-	83	113	V
			* 5.35014	36.73	RMS	34.60	-23.10	0.42	48.65	54.00	-5.35	-	-	83	113	V

Note1. Pk - Peak detector, RMS - RMS detector
 Note2. * - indicates frequency in CFR47 Pt 15 / IC RSS-Restricted Band

HARMONICS AND SPURIOUS EMISSIONS(WORST CASE: 802.11ax HE20 4RU / 5300 MHz)

5300 MHz HORIZONTAL

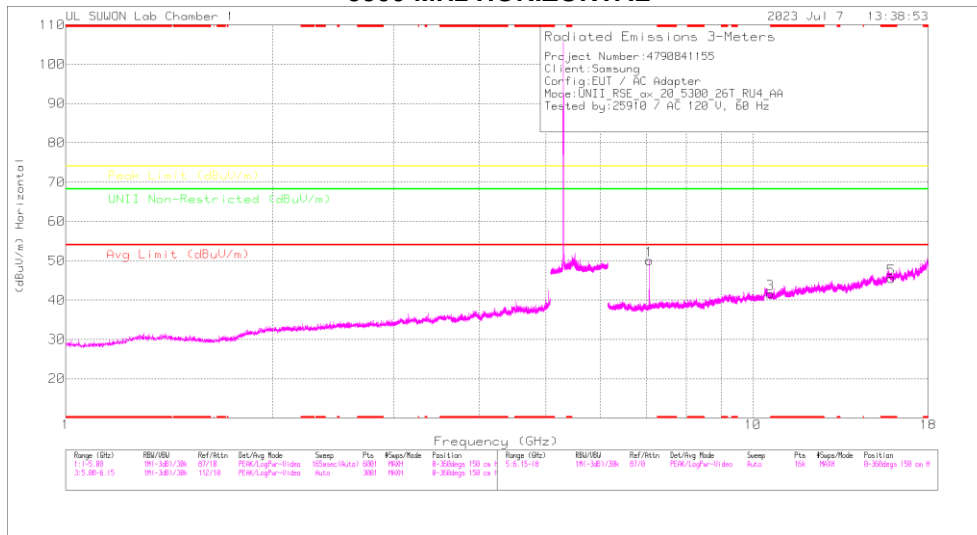

5300 MHz VERTICAL

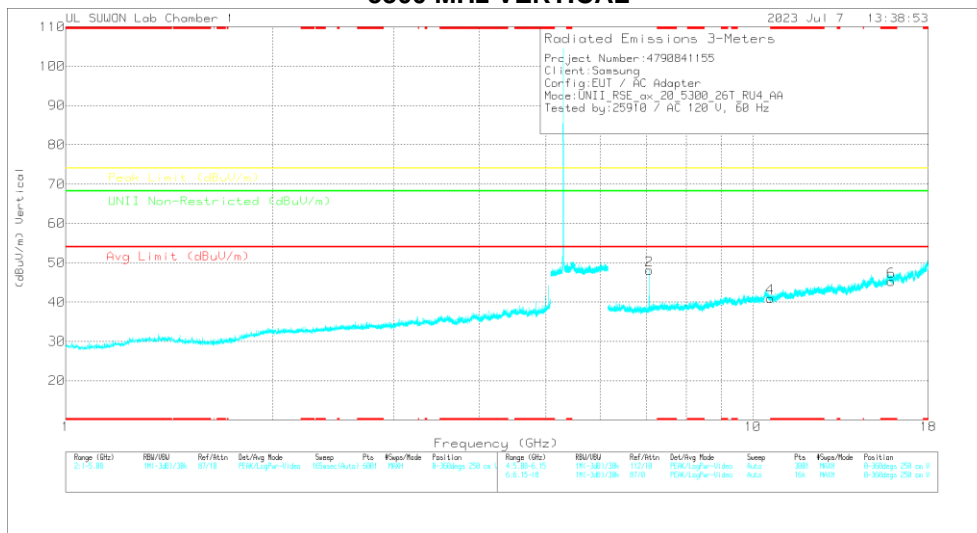

Note: Emission was scanned up to 40GHz; No emissions were detected above the noise floor which was at least 20dB below the specification limit.

5300 MHz DATA

Radiated Emissions

Frequency (GHz)	Meas Reading (dBuV)	Det	317.00168717	6GHz_HPt(dB)	DC Corr (dB)	Corrected Reading (dBuV)	Avg Limit (dBuV/m)	Margin (dB)	Peak Limit (dBuV/m)	Margin (dB)	UNII Non-Restricted (dBuV/m)	Margin (dB)	Azimuth (Degs)	Height (cm)	Polarity
7.06658	49.22	PK-U	35.8	-30.2	0	54.82	-	-	-	-	68.2	-13.38	69	141	H
7.06659	46.53	PK-U	35.8	-30.2	0	52.13	-	-	-	-	68.2	-16.07	278	104	V
10.59919	41.14	PK-U	37.9	-27.2	0	51.84	-	-	-	-	68.2	-16.36	0	100	H
10.59932	40.71	PK-U	37.9	-27.2	0	51.41	-	-	-	-	68.2	-16.79	0	100	V
* 15.89818	39.03	PK-U	40.7	-22.7	0	57.03	-	-	74	-16.97	-	-	0	100	H
* 15.89941	38.97	PK-U	40.7	-22.7	0	56.97	-	-	74	-17.03	-	-	0	100	V

* - indicates frequency in CFR47 Pt 15 / IC RSS-Restricted Band
 PK-U - U-NII: Maximum Peak

HARMONICS AND SPURIOUS EMISSIONS TEST DATA

Mode	Freq. [MHz]	Antenna	Frequency [GHz]	Reading [dBuV]	Detector Mode	ANT Factor	Loss [dB]	DC Corr [dB]	Result [dBuV/m]	AV Limit [dBuV/m]	AV Margin [dB]	PK Limit [dBuV/m]	PK Margin [dB]	Non-Restricted [dBuV/m]	Margin [dB]	Azimuth [Degs]	Height [cm]	Polarity		
802.11a	5260	MIMO	7.013	43.07	PK-U	35.60	-24.60	0.00	54.07	-	-	-	-	68.20	-14.13	70	136	H		
			* 7.013	41.79	PK-U	35.60	-24.60	0.00	52.79	-	-	-	-	-	68.20	-15.41	90	245	V	
			10.523	33.47	PK-U	37.70	-20.20	0.00	50.97	-	-	-	-	-	68.20	-17.23	0	100	H	
			* 10.522	33.48	PK-U	37.70	-20.20	0.00	50.98	-	-	-	-	-	68.20	-17.22	0	100	V	
			* 15.78294	34.76	PK-U	40.20	-19.10	0.00	55.86	-	-	-	-	74.00	-18.14	-	-	0	100	H
			* 15.77905	34.36	PK-U	40.20	-19.00	0.00	55.56	-	-	-	-	74.00	-18.44	-	-	0	100	V
	5300	MIMO	7.066	36.44	PK	35.60	-23.00	0.00	49.04	-	-	-	-	68.20	-19.16	0-360	150	H		
			* 10.60014	22.17	PK	37.80	-18.90	0.00	41.07	-	-	-	74.00	-32.93	-	-	0-360	150	H	
			* 15.90046	23.39	PK	40.30	-18.50	0.00	45.19	-	-	-	74.00	-28.81	-	-	0-360	150	H	
			7.066	34.74	PK	35.60	-23.00	0.00	47.34	-	-	-	-	-	68.20	-20.86	0-360	250	V	
			* 10.60014	22.05	PK	37.80	-18.90	0.00	40.95	-	-	-	74.00	-33.05	-	-	0-360	250	V	
			* 15.90046	22.12	PK	40.30	-18.50	0.00	43.92	-	-	-	74.00	-30.08	-	-	0-360	250	V	
	5320	MIMO	7.093	40.70	PK-U	35.60	-22.40	0.00	53.90	-	-	-	-	68.20	-14.30	70	141	H		
			* 7.093	38.11	PK-U	35.60	-22.40	0.00	51.31	-	-	-	-	68.20	-16.89	275	103	V		
			* 10.6441	33.10	PK-U	37.80	-18.90	0.00	52.00	-	-	-	74.00	-22.00	-	-	0	100	H	
			* 10.63853	33.10	PK-U	37.80	-18.80	0.00	52.10	-	-	-	74.00	-21.90	-	-	0	100	V	
			* 15.96253	34.28	PK-U	40.40	-18.90	0.00	55.78	-	-	-	74.00	-18.22	-	-	0	100	H	
			* 15.96201	34.38	PK-U	40.40	-18.90	0.00	55.88	-	-	-	74.00	-18.12	-	-	0	100	V	
802.11ax (HE20) 4RU Spot-Check	5300	MIMO	7.067	49.22	PK-U	35.80	-30.20	0.00	54.82	-	-	-	-	68.20	-13.38	69	141	H		
			* 7.067	46.53	PK-U	35.80	-30.20	0.00	52.13	-	-	-	-	68.20	-16.07	278	104	V		
			10.599	41.14	PK-U	37.90	-27.20	0.00	51.84	-	-	-	-	-	68.20	-16.36	0	100	H	
			* 10.599	40.71	PK-U	37.90	-27.20	0.00	51.41	-	-	-	-	-	68.20	-16.79	0	100	V	
			* 15.89818	39.03	PK-U	40.70	-22.70	0.00	57.03	-	-	-	74.00	-16.97	-	-	0	100	H	
			* 15.89941	38.97	PK-U	40.70	-22.70	0.00	56.97	-	-	-	74.00	-17.03	-	-	0	100	V	

Note1. PK-U - U-NII: Maximum Peak / ADR - U-NII AD primary method, RMS average
 Note2. * - indicates frequency in CFR47 Pt 15 / IC RSS-Restricted Band

11.3. TX ABOVE 1GHz 2Tx MODE IN THE 5.5 GHz BAND

BANDEDGE (WORST CASE: 802.11ac VHT80 / 5530 MHz)

HORIZONTAL PEAK AND AVERAGE DATA

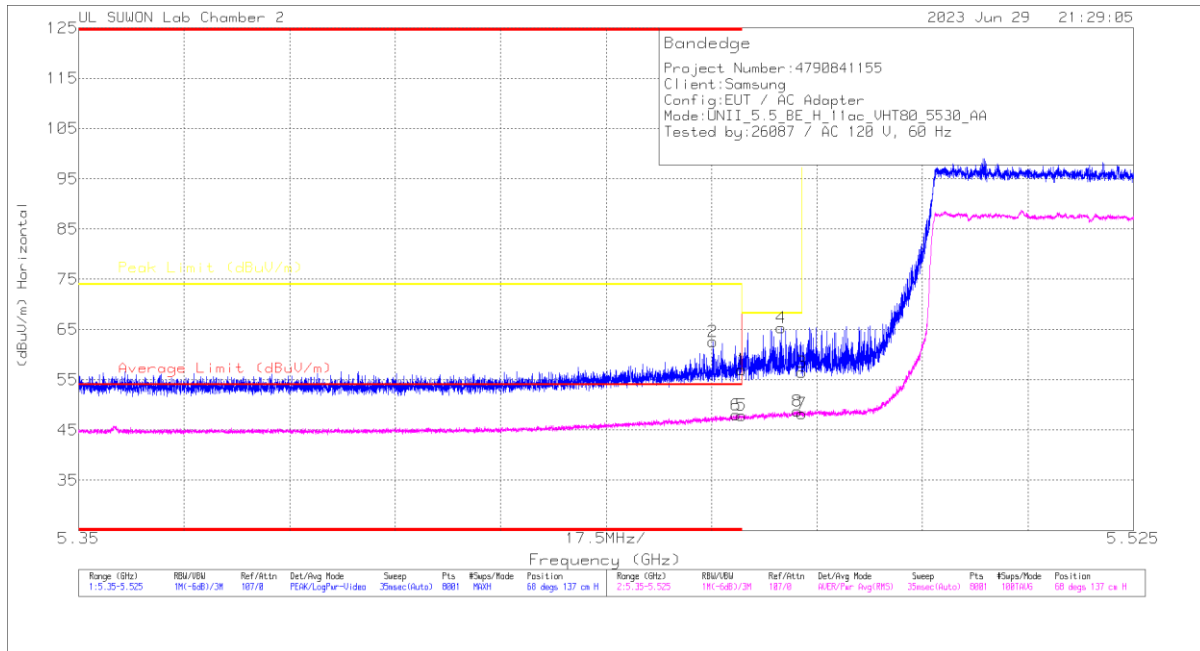

Trace Markers

Marker	Frequency (GHz)	Meter Reading (dBuV)	Det	3117_00168724	10dB_ATT(dB)	DC Corr (dB)	Corrected Reading (dBuV/m)	Average Limit (dBuV/m)	Margin (dB)	Peak Limit (dBuV/m)	PK Margin (dB)	Azimuth (Degs)	Height (cm)	Polarity
1	* 5.45999	39.93	Pk	34.4	-17.3	0	57.03	-	-	74	-16.97	68	137	H
2	* 5.45526	45.45	Pk	34.4	-17.3	0	62.55	-	-	74	-11.45	68	137	H
3	5.46998	39.31	Pk	34.4	-17.2	0	56.51	-	-	68.2	-11.69	68	137	H
4	5.46657	48.29	Pk	34.4	-17.3	0	65.39	-	-	68.2	-2.81	68	137	H
5	* 5.45999	30.41	RMS	34.4	-17.3	.44	47.95	54	-6.05	-	-	68	137	H
6	* 5.45905	30.46	RMS	34.4	-17.3	.44	48	54	-6	-	-	68	137	H
7	5.46998	30.66	RMS	34.4	-17.2	.44	48.3	-	-	-	-	68	137	H
8	5.46931	31.1	RMS	34.4	-17.2	.44	48.74	-	-	-	-	68	137	H

* - indicates frequency in CFR47 Pt 15 / IC RSS-Restricted Band
 Pk - Peak detector
 RMS - RMS detection

BANDEDGE TEST DATA

Mode	Freq. [MHz]	Antenna	Frequency [GHz]	Reading [dBuV]	Detector Mode	ANT Factor	Loss [dB]	DC Corr [dB]	Result [dBuV/m]	AV Limit [dBuV/m]	AV Margin [dB]	PK Limit [dBuV/m]	PK Margin [dB]	Azimuth [Degs]	Height [cm]	Polarity			
802.11a	5500	MIMO	* 5.45999	37.61	Pk	34.40	-17.30	0.00	54.71	-	-	74.00	-19.29	66	140	H			
			* 5.41834	40.52	Pk	34.40	-17.30	0.00	57.62	-	-	74.00	-16.38	66	140	H			
			5.46998	37.87	Pk	34.40	-17.20	0.00	55.07	-	-	68.20	-13.13	66	140	H			
			5.46896	41.62	Pk	34.40	-17.20	0.00	58.82	-	-	68.20	-9.38	66	140	H			
			* 5.45999	27.85	RMS	34.40	-17.30	0.14	45.09	54.00	-8.91	-	-	66	140	H			
			* 5.35595	28.60	RMS	34.40	-17.20	0.14	45.94	54.00	-8.06	-	-	66	140	H			
			5.46998	27.95	RMS	34.40	-17.20	0.14	45.29	-	-	-	-	66	140	H			
			5.46747	28.41	RMS	34.40	-17.20	0.14	45.75	-	-	-	-	66	140	H			
			* 5.45999	36.26	Pk	34.40	-17.30	0.00	53.36	-	-	74.00	-20.64	82	212	V			
			* 5.41646	39.94	Pk	34.40	-17.30	0.00	57.04	-	-	74.00	-16.96	82	212	V			
			5.46998	37.26	Pk	34.40	-17.20	0.00	54.46	-	-	68.20	-13.74	82	212	V			
			5.46515	39.24	Pk	34.40	-17.30	0.00	56.34	-	-	68.20	-11.86	82	212	V			
			* 5.45999	27.26	RMS	34.40	-17.30	0.14	44.50	54.00	-9.50	-	-	82	212	V			
			* 5.45666	27.74	RMS	34.40	-17.30	0.14	44.98	54.00	-9.02	-	-	82	212	V			
			5.46998	27.26	RMS	34.40	-17.20	0.14	44.60	-	-	-	-	82	212	V			
			5.46972	27.78	RMS	34.40	-17.20	0.14	45.12	-	-	-	-	82	212	V			
			5.72502	39.99	Pk	34.60	-16.60	0.00	57.99	-	-	68.20	-10.21	67	140	H			
			5.72506	43.29	Pk	34.60	-16.60	0.00	61.29	-	-	68.20	-6.91	67	140	H			
			5.72502	36.59	Pk	34.60	-16.60	0.00	54.59	-	-	68.20	-13.61	87	107	V			
			5.73208	40.89	Pk	34.60	-16.60	0.00	58.89	-	-	68.20	-9.31	87	107	V			
			802.11n (HT20)	5500	MIMO	* 5.45999	36.93	Pk	34.40	-17.30	0.00	54.03	-	-	74.00	-19.97	67	141	H
						* 5.44693	41.05	Pk	34.40	-17.30	0.00	58.15	-	-	74.00	-15.85	67	141	H
						5.46998	37.45	Pk	34.40	-17.20	0.00	54.65	-	-	68.20	-13.55	67	141	H
						5.46893	43.28	Pk	34.40	-17.20	0.00	60.48	-	-	68.20	-7.72	67	141	H
* 5.45999	28.24	RMS				34.40	-17.30	0.00	45.34	54.00	-8.66	-	-	67	141	H			
* 5.42608	28.52	RMS				34.40	-17.30	0.00	45.62	54.00	-8.38	-	-	67	141	H			
5.46998	27.90	RMS				34.40	-17.20	0.00	45.10	-	-	-	-	67	141	H			
5.46843	28.55	RMS				34.40	-17.20	0.00	45.75	-	-	-	-	67	141	H			
* 5.45999	36.38	Pk				34.40	-17.30	0.00	53.48	-	-	74.00	-20.52	88	210	V			
* 5.36719	40.04	Pk				34.40	-17.20	0.00	57.24	-	-	74.00	-16.76	88	210	V			
5.46998	36.10	Pk				34.40	-17.20	0.00	53.30	-	-	68.20	-14.90	88	210	V			
5.46725	40.47	Pk				34.40	-17.20	0.00	57.67	-	-	68.20	-10.53	88	210	V			
* 5.45999	27.15	RMS				34.40	-17.30	0.00	44.25	54.00	-9.75	-	-	88	210	V			
* 5.41556	27.98	RMS				34.40	-17.30	0.00	45.08	54.00	-8.92	-	-	88	210	V			
5.46998	27.41	RMS				34.40	-17.20	0.00	44.61	-	-	-	-	88	210	V			
5.46605	27.86	RMS				34.40	-17.30	0.00	44.96	-	-	-	-	88	210	V			
5.72502	39.90	Pk				34.60	-16.60	0.00	57.90	-	-	68.20	-10.30	67	141	H			
5.72592	46.06	Pk				34.60	-16.60	0.00	64.06	-	-	68.20	-4.14	67	141	H			
5.72502	35.93	Pk				34.60	-16.60	0.00	53.93	-	-	68.20	-14.27	85	107	V			
5.72620	42.86	Pk				34.60	-16.60	0.00	60.86	-	-	68.20	-7.34	85	107	V			
802.11n (HT40)	5510	MIMO				* 5.45999	40.47	Pk	34.40	-17.30	0.00	57.57	-	-	74.00	-16.43	67	164	H
						* 5.45627	42.25	Pk	34.40	-17.30	0.00	59.35	-	-	74.00	-14.65	67	164	H
						5.46998	39.85	Pk	34.40	-17.20	0.00	57.05	-	-	68.20	-11.15	67	164	H
						5.46913	45.40	Pk	34.40	-17.20	0.00	62.60	-	-	68.20	-5.60	67	164	H
			* 5.45999	28.22	RMS	34.40	-17.30	0.10	45.42	54.00	-8.58	-	-	67	164	H			
			* 5.45966	28.70	RMS	34.40	-17.30	0.10	45.90	54.00	-8.10	-	-	67	164	H			
			5.46998	29.93	RMS	34.40	-17.20	0.10	47.23	-	-	-	-	67	164	H			
			5.46909	30.03	RMS	34.40	-17.20	0.10	47.33	-	-	-	-	67	164	H			
			* 5.45999	37.13	Pk	34.40	-17.30	0.00	54.23	-	-	74.00	-19.77	85	212	V			
			* 5.42794	40.67	Pk	34.40	-17.30	0.00	57.77	-	-	74.00	-16.23	85	212	V			
			5.46998	38.36	Pk	34.40	-17.20	0.00	55.56	-	-	68.20	-12.64	85	212	V			
			5.46957	40.72	Pk	34.40	-17.20	0.00	57.92	-	-	68.20	-10.28	85	212	V			
			* 5.45999	27.18	RMS	34.40	-17.30	0.10	44.38	54.00	-9.62	-	-	85	212	V			
			* 5.45973	27.91	RMS	34.40	-17.30	0.10	45.11	54.00	-8.89	-	-	85	212	V			
			5.46998	28.09	RMS	34.40	-17.20	0.10	45.39	-	-	-	-	85	212	V			
			5.46981	28.33	RMS	34.40	-17.20	0.10	45.63	-	-	-	-	85	212	V			
			5.72502	36.60	Pk	34.60	-16.60	0.00	54.60	-	-	68.20	-13.60	66	121	H			
			5.72808	40.43	Pk	34.60	-16.60	0.00	58.43	-	-	68.20	-9.77	66	121	H			
			5.72502	37.03	Pk	34.60	-16.60	0.00	55.03	-	-	68.20	-13.17	91	260	V			
			5.72538	41.34	Pk	34.60	-16.60	0.00	59.34	-	-	68.20	-8.86	91	260	V			
			802.11ac (VHT80)	5530	MIMO	* 5.45999	39.93	Pk	34.40	-17.30	0.00	57.03	-	-	74.00	-16.97	68	137	H
						* 5.45526	45.45	Pk	34.40	-17.30	0.00	62.55	-	-	74.00	-11.45	68	137	H
						5.46998	39.31	Pk	34.40	-17.20	0.00	56.51	-	-	68.20	-11.69	68	137	H
						5.46657	48.29	Pk	34.40	-17.30	0.00	65.39	-	-	68.20	-2.81	68	137	H
* 5.45999	30.41	RMS				34.40	-17.30	0.44	47.95	54.00	-6.05	-	-	68	137	H			
* 5.45905	30.46	RMS				34.40	-17.30	0.44	48.00	54.00	-6.00	-	-	68	137	H			
5.46998	30.66	RMS				34.40	-17.20	0.44	48.30	-	-	-	-	68	137	H			
5.46931	31.10	RMS				34.40	-17.20	0.44	48.74	-	-	-	-	68	137	H			
* 5.45999	39.88	Pk				34.40	-17.30	0.00	56.98	-	-	74.00	-17.02	95	247	V			
* 5.45896	44.90	Pk				34.40	-17.30	0.00	62.00	-	-	74.00	-12.00	95	247	V			
5.46998	44.46	Pk				34.40	-17.20	0.00	61.66	-	-	68.20	-6.54	95	247	V			
5.46543	45.91	Pk				34.40	-17.30	0.00	63.01	-	-	68.20	-5.19	95	247	V			
* 5.45999	28.66	RMS				34.40	-17.30	0.44	46.20	54.00	-7.80	-	-	95	247	V			
* 5.45944	29.37	RMS				34.40	-17.30	0.44	46.91	54.00	-7.09	-	-	95	247	V			
5.46998	29.19	RMS				34.40	-17.20	0.44	46.83	-	-	-	-	95	247	V			
5.46994	30.16	RMS				34.40	-17.20	0.44	47.80	-	-	-	-	95	247	V			
5.72502	35.33	Pk				34.60	-16.60	0.00	53.33	-	-	68.20	-14.87	66	145	H			
5.78970	39.93	Pk				34.60	-16.60	0.00	57.93	-	-	68.20	-10.27	66	145	H			
5.72502	36.78	Pk				34.60	-16.60	0.00	54.78	-	-	68.20	-13.42	89	288	V			
5.75980	39.97	Pk				34.60	-16.60	0.00	57.97	-	-	68.20	-10.23	89	288	V			

Mode	Freq. [MHz]	Antenna	Frequency [GHz]	Reading [dBuV]	Detector Mode	ANT Factor	Loss [dB]	DC Corr [dB]	Result dBuV/m	AV Limit dBuV/m	AV Margin [dB]	PK Limit dBuV/m	PK Margin [dB]	Azimuth [Degs]	Height [cm]	Polarity	
802.11ax (HE20)	5500	MIMO	* 5.45999	42.14	Pk	34.70	-22.90	0.00	53.94	-	-	74.00	-20.06	66	142	H	
			* 5.45542	47.76	Pk	34.70	-23.00	0.00	59.46	-	-	74.00	-14.54	66	142	H	
			5.46998	42.07	Pk	34.70	-23.00	0.00	53.77	-	-	68.20	-14.43	66	142	H	
			5.46600	49.63	Pk	34.70	-22.90	0.00	61.43	-	-	68.20	-6.77	66	142	H	
			* 5.45999	32.58	RMS	34.70	-22.90	0.15	44.53	54.00	-9.47	-	-	-	66	142	H
			* 5.35584	33.89	RMS	34.60	-23.10	0.15	45.54	54.00	-8.46	-	-	-	66	142	H
			5.46998	33.21	RMS	34.70	-23.00	0.00	44.91	-	-	-	-	-	66	142	H
			5.46977	33.35	RMS	34.70	-23.00	0.00	45.05	-	-	-	-	-	66	142	H
			* 5.45999	42.16	Pk	34.70	-22.90	0.00	53.96	-	-	74.00	-20.04	82	246	V	
			* 5.45765	44.59	Pk	34.70	-23.00	0.00	56.29	-	-	74.00	-17.71	82	246	V	
	5.46998	45.00	Pk	34.70	-23.00	0.00	56.70	-	-	68.20	-11.50	82	246	V			
	5.46942	46.10	Pk	34.70	-22.90	0.00	57.90	-	-	68.20	-10.30	82	246	V			
	* 5.45999	31.76	RMS	34.70	-22.90	0.15	43.71	54.00	-10.29	-	-	-	82	246	V		
	* 5.35586	32.91	RMS	34.60	-23.10	0.15	44.56	54.00	-9.44	-	-	-	82	246	V		
	5.46998	32.27	RMS	34.70	-23.00	0.00	43.97	-	-	-	-	-	82	246	V		
	5.46478	32.78	RMS	34.70	-22.90	0.00	44.58	-	-	-	-	-	82	246	V		
	5700	MIMO	5.72500	47.21	Pk	34.80	-22.40	0.00	59.61	-	-	68.20	-8.59	68	147	H	
			5.72713	49.36	Pk	34.80	-22.40	0.00	61.76	-	-	68.20	-6.44	68	147	H	
			5.72502	42.25	Pk	34.80	-22.40	0.00	54.65	-	-	68.20	-13.55	92	274	V	
			5.72522	49.52	Pk	34.80	-22.40	0.00	61.92	-	-	68.20	-6.28	92	274	V	
* 5.45999			42.20	Pk	34.70	-22.90	0.00	54.00	-	-	74.00	-20.00	66	151	H		
* 5.4599			46.68	Pk	34.70	-22.90	0.00	58.48	-	-	74.00	-15.52	66	151	H		
802.11ax (HE40)	5510	MIMO	5.46998	42.95	Pk	34.70	-23.00	0.00	54.65	-	-	68.20	-13.55	66	151	H	
			5.46386	48.37	Pk	34.70	-22.90	0.00	60.17	-	-	68.20	-8.03	66	151	H	
			* 5.45999	32.82	RMS	34.70	-22.90	0.35	44.97	54.00	-9.03	-	-	66	151	H	
			* 5.45992	33.32	RMS	34.70	-22.90	0.35	45.47	54.00	-8.53	-	-	66	151	H	
			5.46998	33.93	RMS	34.70	-23.00	0.35	45.98	-	-	-	-	66	151	H	
			5.46926	34.15	RMS	34.70	-22.90	0.35	46.30	-	-	-	-	66	151	H	
			* 5.45999	41.01	Pk	34.70	-22.90	0.00	52.81	-	-	74.00	-21.19	94	221	V	
			* 5.44831	44.22	Pk	34.70	-22.90	0.00	56.02	-	-	74.00	-17.98	94	221	V	
			5.46998	42.04	Pk	34.70	-23.00	0.00	53.74	-	-	68.20	-14.46	94	221	V	
			5.46979	45.48	Pk	34.70	-23.00	0.00	57.18	-	-	68.20	-11.02	94	221	V	
	* 5.45999	31.80	RMS	34.70	-22.90	0.35	43.95	54.00	-10.05	-	-	94	221	V			
	* 5.35103	32.78	RMS	34.60	-23.20	0.35	44.53	54.00	-9.47	-	-	94	221	V			
	5.46998	32.16	RMS	34.70	-23.00	0.35	44.21	-	-	-	-	94	221	V			
	5.46928	32.83	RMS	34.70	-22.90	0.35	44.98	-	-	-	-	94	221	V			
	5670	MIMO	5.72500	40.57	Pk	34.80	-22.40	0.00	52.97	-	-	68.20	-15.23	69	150	H	
			5.72716	45.65	Pk	34.80	-22.40	0.00	58.05	-	-	68.20	-10.15	69	150	H	
			5.72502	41.55	Pk	34.80	-22.40	0.00	53.95	-	-	68.20	-14.25	85	195	V	
			5.72914	44.03	Pk	34.80	-22.40	0.00	56.43	-	-	68.20	-11.77	85	195	V	
			* 5.45999	44.01	Pk	34.70	-22.90	0.00	55.81	-	-	74.00	-18.19	66	121	H	
	802.11ax (HE80)	5530	MIMO	* 5.4527	46.75	Pk	34.70	-22.90	0.00	58.55	-	-	74.00	-15.45	66	121	H
5.46998				44.21	Pk	34.70	-23.00	0.00	55.91	-	-	68.20	-12.29	66	121	H	
5.46607				49.05	Pk	34.70	-22.90	0.00	60.85	-	-	68.20	-7.35	66	121	H	
* 5.45999				34.16	RMS	34.70	-22.90	0.42	46.38	54.00	-7.62	-	-	66	121	H	
* 5.45988				34.91	RMS	34.70	-22.90	0.42	47.13	54.00	-6.87	-	-	66	121	H	
5.46998				35.53	RMS	34.70	-23.00	0.42	47.65	-	-	-	-	66	121	H	
5.46815				35.35	RMS	34.70	-22.90	0.42	47.57	-	-	-	-	66	121	H	
* 5.45999				41.32	Pk	34.70	-21.20	0.00	54.82	-	-	74.00	-19.18	94	250	V	
* 5.45935				47.93	Pk	34.70	-21.20	0.00	61.43	-	-	74.00	-12.57	94	250	V	
5.46998				42.58	Pk	34.70	-21.20	0.00	56.08	-	-	68.20	-12.12	94	250	V	
5.46095		45.11	Pk	34.70	-21.20	0.00	58.61	-	-	68.20	-9.59	94	250	V			
* 5.45999		32.68	RMS	34.70	-21.20	0.42	46.60	54.00	-7.40	-	-	94	250	V			
* 5.45931		33.37	RMS	34.70	-21.20	0.42	47.29	54.00	-6.71	-	-	94	250	V			
5.46998		33.39	RMS	34.70	-21.20	0.42	47.31	-	-	-	-	94	250	V			
5.46970		34.03	RMS	34.70	-21.20	0.42	47.95	-	-	-	-	94	250	V			
5610		MIMO	5.72500	40.87	Pk	34.80	-20.90	0.00	54.77	-	-	68.20	-13.43	67	137	H	
			5.76005	44.67	Pk	34.80	-20.90	0.00	58.57	-	-	68.20	-9.63	67	137	H	
			5.72502	38.89	Pk	34.80	-20.90	0.00	52.79	-	-	68.20	-15.41	88	278	V	
			5.74536	43.84	Pk	34.80	-20.90	0.00	57.74	-	-	68.20	-10.46	88	278	V	

Note1. Pk - Peak detector, RMS - RMS detector
 Note2. * - indicates frequency in CFR47 Pt 15 / IC RSS-Restricted Band

HARMONICS AND SPURIOUS EMISSIONS(WORST CASE: 802.11ax HE20 4RU / 5580 MHz)

5580 MHz HORIZONTAL

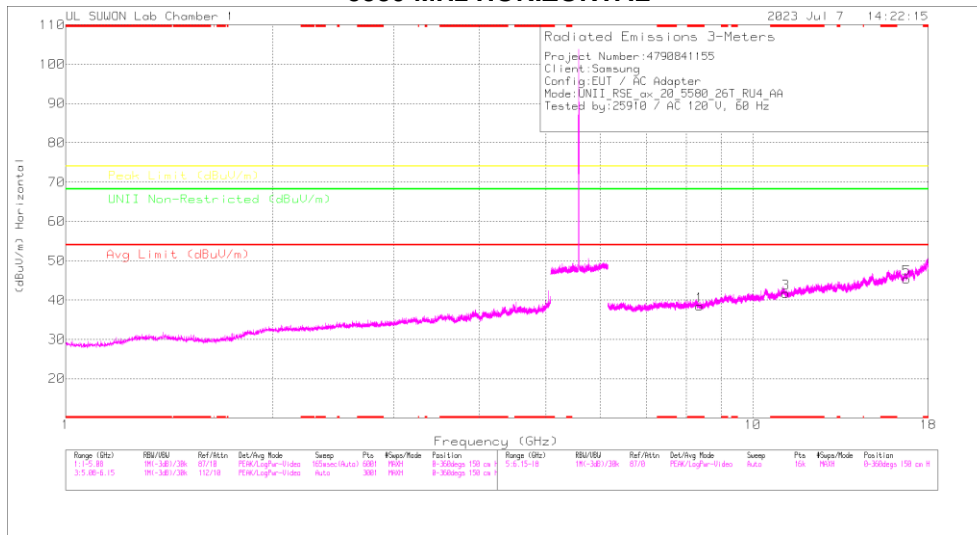

5580 MHz VERTICAL

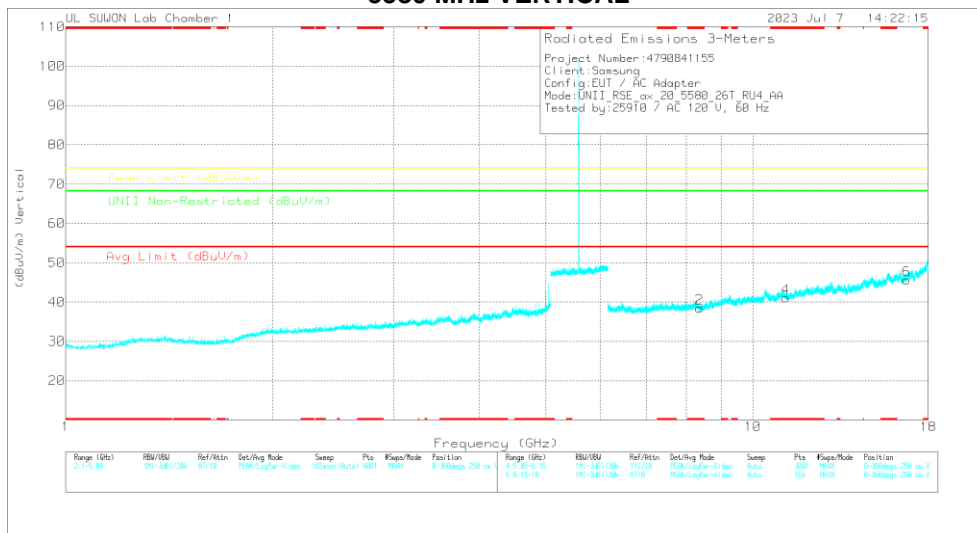

Note. Emission was scanned up to 40GHz; No emissions were detected above the noise floor which was at least 20dB below the specification limit.

5580 MHz DATA

Radiated Emissions

Frequency (GHz)	Meas. Reading (dBuV)	Det	317_00168717	6GHz_HF(dB)	DC Corr (dB)	Corrected Reading (dBuV/m)	Avg Limit (dBuV/m)	Margin (dB)	Peak Limit (dBuV/m)	Margin (dB)	UNII Non-Restricted (dBuV/m)	Margin (dB)	Altitude (Digits)	Height (cm)	Polarity
* 8.3718	42.4	PK-U	38.2	-29.1	0	49.5	-	-	74	-24.5	-	-	0	100	H
* 8.36908	42.5	PK-U	38.2	-29.1	0	49.7	-	-	74	-24.3	-	-	0	100	V
* 11.16115	41.15	PK-U	38.3	-29.9	0	52.55	-	-	74	-21.44	-	-	0	100	H
* 11.15962	40.94	PK-U	38.3	-29.8	0	52.44	-	-	74	-21.56	-	-	0	100	V
16.74115	37.72	PK-U	41.4	-22.5	0	56.62	-	-	-	-	68.2	-11.58	0	100	H
16.74149	39.14	PK-U	41.4	-22.5	0	58.04	-	-	-	-	68.2	-10.16	0	100	V

* - indicates frequency in CFR47 Pt 15 / IC RSS-Restricted Band
 PK-U - U-NII: Maximum Peak

HARMONICS AND SPURIOUS EMISSIONS TEST DATA

Mode	Freq. [MHz]	Antenna	Frequency [GHz]	Reading [dBuV]	Detector Mode	ANT Factor	Loss [dB]	DC Corr [dB]	Result [dBuV/m]	AV Limit [dBuV/m]	AV Margin [dB]	PK Limit [dBuV/m]	PK Margin [dB]	Non-Restricted [dBuV/m]	Margin [dB]	Azimuth [Degs]	Height [cm]	Polarity			
802.11a	5500	MIMO	* 8.24986	34.94	PK-U	35.90	-22.10	0.00	48.74	-	-	74.00	-25.26	-	-	0	100	H			
			* 8.25028	26.29	PK-U	35.90	-22.10	0.00	40.09	-	-	74.00	-33.91	-	-	-	0	100	V		
			* 10.99995	33.88	PK-U	37.90	-19.90	0.00	51.88	-	-	74.00	-22.12	-	-	-	0	100	H		
			* 10.99921	34.09	PK-U	37.90	-19.90	0.00	52.09	-	-	74.00	-21.91	-	-	-	0	100	V		
			16.500	34.35	PK-U	40.90	-19.20	0.00	56.05	-	-	-	-	-	-	68.20	-12.15	0	100	H	
			16.499	34.01	PK-U	40.90	-19.20	0.00	55.71	-	-	-	-	-	-	68.20	-12.49	0	100	V	
	5580	MIMO	* 8.37202	34.56	PK-U	35.90	-22.40	0.00	48.06	-	-	74.00	-25.94	-	-	-	0	100	H		
			* 8.3656	34.39	PK-U	35.90	-22.40	0.00	47.89	-	-	74.00	-26.11	-	-	-	0	100	V		
			* 11.59967	33.63	PK-U	38.20	-19.70	0.00	52.13	-	-	74.00	-21.87	-	-	-	0	100	H		
			* 11.59732	34.05	PK-U	38.20	-19.70	0.00	52.55	-	-	74.00	-21.45	-	-	-	0	100	V		
			16.740	33.85	PK-U	41.20	-18.30	0.00	56.75	-	-	-	-	-	-	68.20	-11.45	0	100	H	
			16.740	34.68	PK-U	41.20	-18.30	0.00	57.58	-	-	-	-	-	-	68.20	-10.62	0	100	V	
	5700	MIMO	8.551	33.84	PK-U	36.00	-21.10	0.00	48.74	-	-	-	-	-	68.20	-19.46	0	100	H		
			8.549	34.53	PK-U	36.00	-21.10	0.00	49.43	-	-	-	-	-	68.20	-18.77	0	100	V		
			* 11.39954	34.32	PK-U	38.10	-19.90	0.00	52.52	-	-	74.00	-21.48	-	-	-	0	100	H		
			* 11.40146	34.30	PK-U	38.10	-19.90	0.00	52.50	-	-	74.00	-21.50	-	-	-	0	100	V		
			17.101	33.66	PK-U	41.20	-17.90	0.00	56.96	-	-	-	-	-	-	68.20	-11.24	0	100	H	
			17.102	33.54	PK-U	41.20	-18.00	0.00	56.74	-	-	-	-	-	-	68.20	-11.46	0	100	V	
	5720	MIMO	8.587	33.59	PK-U	36.00	-20.60	0.00	48.99	-	-	-	-	-	68.20	-19.21	0	100	H		
			8.587	33.75	PK-U	36.00	-20.60	0.00	49.15	-	-	-	-	-	68.20	-19.05	0	100	V		
			* 11.44219	33.83	PK-U	38.10	-19.80	0.00	52.13	-	-	74.00	-21.87	-	-	-	0	100	V		
			* 11.43979	34.03	PK-U	38.10	-19.90	0.00	52.23	-	-	74.00	-21.77	-	-	-	0	100	H		
			17.160	33.32	PK-U	41.20	-18.10	0.00	56.42	-	-	-	-	-	-	68.20	-11.78	0	100	H	
			17.160	33.34	PK-U	41.20	-18.10	0.00	56.44	-	-	-	-	-	-	68.20	-11.76	0	100	V	
	802.11ax (HE20) 4RU Spot-Check	5580	MIMO	* 8.3718	42.40	PK-U	36.20	-29.10	0.00	49.50	-	-	74.00	-24.50	-	-	0	100	H		
				* 8.36908	42.60	PK-U	36.20	-29.10	0.00	49.70	-	-	74.00	-24.30	-	-	0	100	V		
				* 11.16115	41.16	PK-U	38.30	-26.90	0.00	52.56	-	-	74.00	-21.44	-	-	0	100	H		
				* 11.15952	40.94	PK-U	38.30	-26.80	0.00	52.44	-	-	74.00	-21.56	-	-	0	100	V		
				16.741	37.72	PK-U	41.40	-22.50	0.00	56.62	-	-	-	-	-	-	68.20	-11.58	0	100	H
				16.741	39.14	PK-U	41.40	-22.50	0.00	58.04	-	-	-	-	-	-	68.20	-10.16	0	100	V

Note1. PK-U - U-NII: Maximum Peak / ADR - U-NII AD primary method, RMS average
 Note2. * - indicates frequency in CFR47 Pt 15 / IC RSS-Restricted Band

11.4. TX ABOVE 1GHz 2Tx MODE IN THE 5.8 GHz BAND

BANDEDGE (WORST CASE: 802.11a / 5745 MHz)

HORIZONTAL PEAK DATA

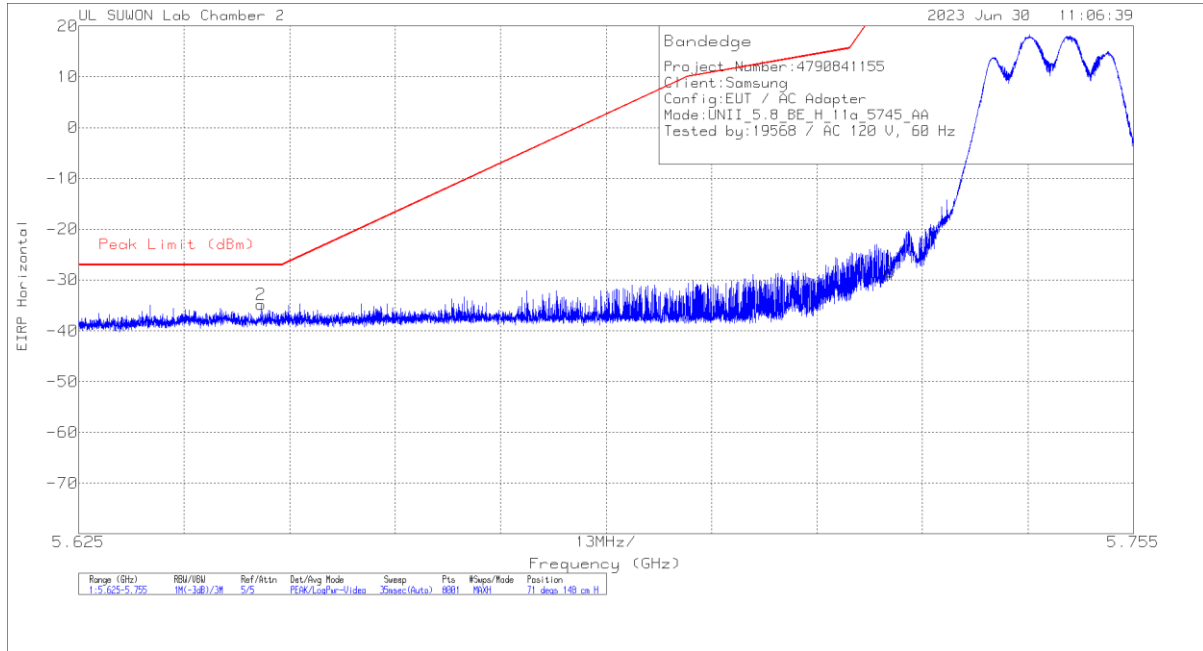

Trace Markers

Marker	Frequency (GHz)	Meter Reading (dBm)	Det	3117_00168724	10dB_ATT(dB)	Conversion Factor (dB)	DC Corr (dB)	Corrected Reading EIRP	Peak Limit (dBm)	PK Margin (dB)	Azimuth (Degs)	Height (cm)	Polarity
1	5.72499	-58.15	Pk		-16.6	11.8	0	-28.35	26.97	-55.32	71	148	H
2	5.64747	-64.44	Pk		-16.7	11.8	0	-34.84	-27	-7.84	71	148	H

Pk - Peak detector

BANDEDGE TEST DATA

Mode	Freq. [MHz]	Antenna	Frequency [GHz]	Reading [dBm]	Detector Mode	ANT Factor	Loss [dB]	Conv. F [dB]	DC Corr [dB]	Result [dBm]	PK Limit [dBm]	PK Margin [dB]	Azimuth [Degs]	Height [cm]	Polarity
802.11a	5745	MIMO	5.72499	-58.15	Pk	34.60	-16.60	11.80	0.00	-28.35	26.97	-55.32	71	148	H
			5.64747	-64.44	Pk	34.50	-16.70	11.80	0.00	-34.84	-27.00	-7.84	71	148	H
			5.72499	-61.55	Pk	34.60	-16.60	11.80	0.00	-31.75	26.97	-58.72	87	102	V
			5.64198	-66.90	Pk	34.50	-16.70	11.80	0.00	-37.30	-27.00	-10.30	87	102	V
			5.85003	-65.03	Pk	34.80	-16.50	11.80	0.00	-34.93	26.94	-61.87	70	151	H
	5825	MIMO	5.94233	-67.27	Pk	34.90	-16.30	11.80	0.00	-36.87	-27.00	-9.87	70	151	H
			5.85003	-68.52	Pk	34.80	-16.50	11.80	0.00	-38.42	26.94	-65.36	89	114	V
			5.98173	-67.10	Pk	35.00	-16.30	11.80	0.00	-36.60	-27.00	-9.60	89	114	V
			5.72499	-59.01	Pk	34.60	-16.60	11.80	0.00	-29.21	26.97	-56.18	71	150	H
			5.64752	-65.43	Pk	34.50	-16.70	11.80	0.00	-35.83	-27.00	-8.83	71	150	H
802.11n (HT20)	5745	MIMO	5.72499	-58.38	Pk	34.60	-16.60	11.80	0.00	-28.58	26.97	-55.55	92	120	V
			5.64739	-66.97	Pk	34.50	-16.70	11.80	0.00	-37.37	-27.00	-10.37	92	120	V
			5.85003	-65.49	Pk	34.80	-16.50	11.80	0.00	-35.39	26.94	-62.33	71	142	H
			5.98080	-67.33	Pk	35.00	-16.30	11.80	0.00	-36.83	-27.00	-9.83	71	142	H
			5.85003	-68.61	Pk	34.80	-16.50	11.80	0.00	-38.51	26.94	-65.45	91	115	V
	5825	MIMO	5.97343	-67.70	Pk	35.00	-16.30	11.80	0.00	-37.20	-27.00	-10.20	91	115	V
			5.72499	-62.24	Pk	34.60	-16.60	11.80	0.00	-32.44	26.97	-59.41	71	197	H
			5.64603	-66.05	Pk	34.50	-16.70	11.80	0.00	-36.45	-27.00	-9.45	71	197	H
			5.72499	-67.01	Pk	34.60	-16.60	11.80	0.00	-37.21	26.97	-64.18	88	228	V
			5.64541	-66.97	Pk	34.50	-16.70	11.80	0.00	-37.37	-27.00	-10.37	88	228	V
802.11n (HT40)	5755	MIMO	5.85003	-69.70	Pk	34.80	-16.50	11.80	0.00	-39.60	26.94	-66.54	69	127	H
			5.99503	-67.18	Pk	35.00	-16.30	11.80	0.00	-36.68	-27.00	-9.68	69	127	H
			5.85003	-69.86	Pk	34.80	-16.50	11.80	0.00	-39.76	26.94	-66.70	90	248	V
			5.99738	-68.14	Pk	35.00	-16.30	11.80	0.00	-37.64	-27.00	-10.64	90	248	V
			5.72499	-57.78	Pk	34.60	-16.60	11.80	0.00	-27.98	26.97	-54.95	65	136	H
	5775 (Lower Side)	MIMO	5.64278	-65.93	Pk	34.50	-16.70	11.80	0.00	-36.33	-27.00	-9.33	65	136	H
			5.72499	-61.81	Pk	34.60	-16.60	11.80	0.00	-32.01	26.97	-58.98	85	109	V
			5.63857	-67.33	Pk	34.50	-16.60	11.80	0.00	-37.63	-27.00	-10.63	85	109	V
			5.85003	-68.20	Pk	34.80	-16.50	11.80	0.00	-38.10	26.94	-65.04	66	150	H
			5.95878	-68.54	Pk	35.00	-16.30	11.80	0.00	-38.04	-27.00	-11.04	66	150	H
5775 (Upper Side)	MIMO	5.85003	-70.33	Pk	34.80	-16.50	11.80	0.00	-40.23	26.94	-67.17	86	109	V	
		5.96848	-67.81	Pk	35.00	-16.30	11.80	0.00	-37.31	-27.00	-10.31	86	109	V	
		5.72499	-54.52	Pk	34.80	-22.40	11.80	0.00	-30.32	26.97	-57.29	69	149	H	
		5.64665	-59.73	Pk	34.60	-22.70	11.80	0.00	-36.03	-27.00	-9.03	69	149	H	
		5.72499	-59.30	Pk	34.80	-22.40	11.80	0.00	-35.10	26.97	-62.07	95	101	V	
802.11ax (HE20)	5745	MIMO	5.64281	-61.48	Pk	34.60	-22.70	11.80	0.00	-37.78	-27.00	-10.78	95	101	V
			5.85003	-60.91	Pk	34.90	-22.30	11.80	0.00	-36.51	26.94	-63.45	67	163	H
			5.98035	-62.28	Pk	35.10	-21.90	11.80	0.00	-37.28	-27.00	-10.28	67	163	H
			5.85003	-62.21	Pk	34.90	-22.30	11.80	0.00	-37.81	26.94	-64.75	98	109	V
			5.93070	-62.19	Pk	35.00	-22.00	11.80	0.00	-37.39	-27.00	-10.39	98	109	V
	5755	MIMO	5.72499	-58.24	Pk	34.80	-20.90	11.80	0.00	-32.54	26.97	-59.51	68	148	H
			5.64414	-60.38	Pk	34.60	-20.90	11.80	0.00	-34.88	-27.00	-7.88	68	148	H
			5.72499	-57.41	Pk	34.80	-20.90	11.80	0.00	-31.71	26.97	-58.68	90	101	V
			5.64866	-61.84	Pk	34.60	-20.80	11.80	0.00	-36.24	-27.00	-9.24	90	101	V
			5.85003	-64.81	Pk	34.90	-20.80	11.80	0.00	-38.91	26.94	-65.85	68	161	H
5795	MIMO	5.92690	-62.79	Pk	35.00	-20.50	11.80	0.00	-36.49	-27.00	-9.49	68	161	H	
		5.85003	-64.72	Pk	34.90	-20.80	11.80	0.00	-38.82	26.94	-65.76	87	109	V	
		5.93955	-62.79	Pk	35.00	-20.50	11.80	0.00	-36.49	-27.00	-9.49	87	109	V	
		5.72499	-60.66	Pk	34.80	-20.90	11.80	0.00	-34.96	26.97	-61.93	68	147	H	
		5.63389	-61.11	Pk	34.60	-20.90	11.80	0.00	-35.61	-27.00	-8.61	68	147	H	
802.11ax (HE40)	5745	MIMO	5.72499	-59.63	Pk	34.80	-20.90	11.80	0.00	-33.93	26.97	-60.90	90	103	V
			5.63750	-62.03	Pk	34.60	-20.90	11.80	0.00	-36.53	-27.00	-9.53	90	103	V
			5.85003	-64.75	Pk	34.90	-20.80	11.80	0.00	-38.85	26.94	-65.79	68	152	H
			5.98125	-62.05	Pk	35.10	-20.40	11.80	0.00	-35.55	-27.00	-8.55	68	152	H
			5.85003	-66.00	Pk	34.90	-20.80	11.80	0.00	-40.10	26.94	-67.04	88	107	V
	5775 (Lower Side)	MIMO	5.96010	-61.88	Pk	35.10	-20.50	11.80	0.00	-35.48	-27.00	-8.48	88	107	V

Note. Pk - Peak detector

HARMONICS AND SPURIOUS EMISSIONS(WORST CASE: 802.11a / 5745 MHz)

5745 MHz HORIZONTAL

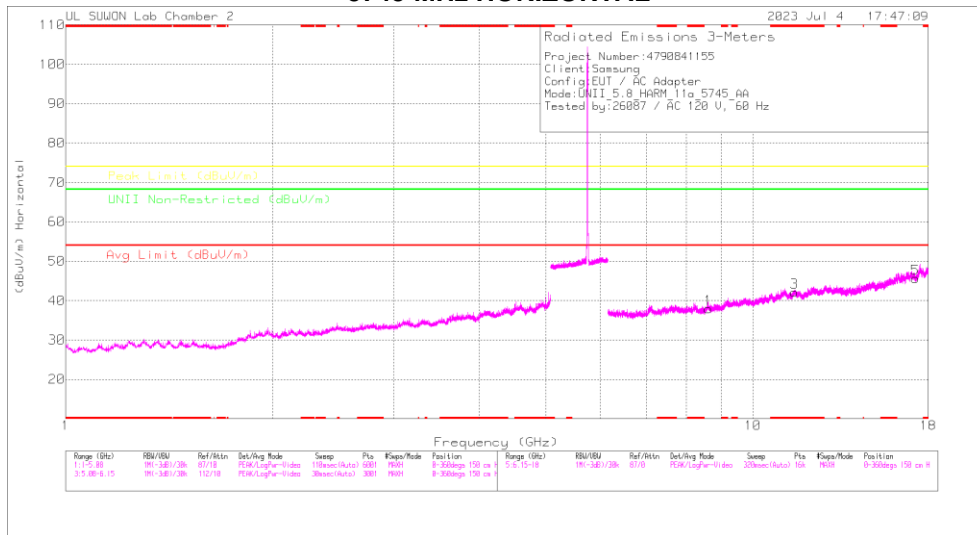

5745 MHz VERTICAL

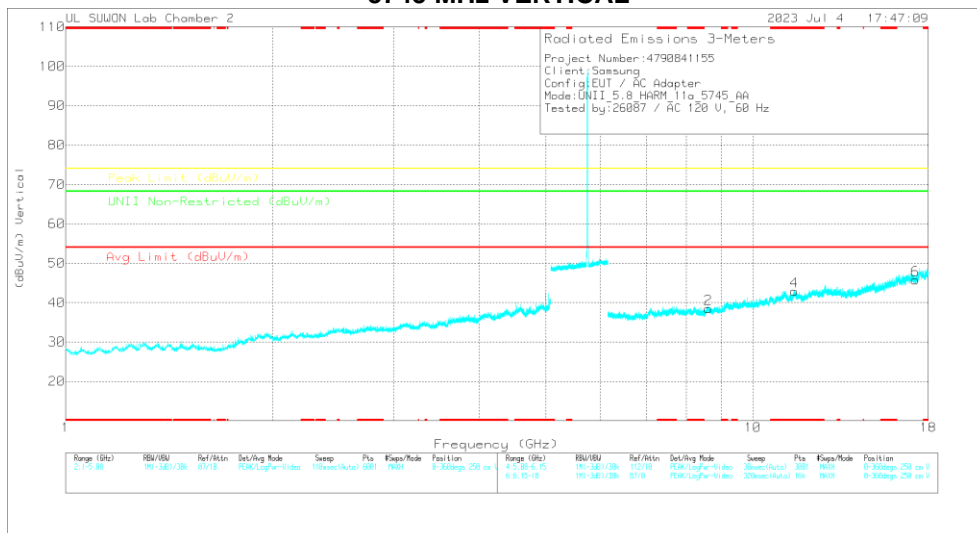

Note: Emission was scanned up to 40GHz; No emissions were detected above the noise floor which was at least 20dB below the specification limit.

5745 MHz DATA

Radiated Emissions

Frequency (GHz)	Meas. Reading (dBuV)	Det.	317_00168724	6GHz_HPI(dB)	DC Corr (dB)	Corrected Reading (dBuV/m)	Avg Limit (dBuV/m)	Margin (dB)	Peak Limit (dBuV/m)	Margin (dB)	UNII Non-Restricted (dBuV/m)	Margin (dB)	Azimuth (Deg)	Height (cm)	Polarity
8.6157	33.69	PK-U	36	-20.7	0	48.99	-	-	-	-	68.2	-19.21	0	100	H
8.61623	34.33	PK-U	36	-20.7	0	49.63	-	-	-	-	68.2	-18.57	0	100	V
*11.46831	33.93	PK-U	38.2	-19.3	0	52.83	-	-	74	-21.17	-	-	0	100	H
*11.48123	34.17	PK-U	38.2	-19.3	0	53.07	-	-	74	-20.93	-	-	0	100	V
17.23486	33.54	PK-U	41.2	-18.4	0	56.34	-	-	-	-	68.2	-11.86	0	100	H
17.23744	34.12	PK-U	41.2	-18.4	0	56.92	-	-	-	-	68.2	-11.28	0	100	V

* - indicates frequency in CFR47 Pt 15 / IC RSS-Restricted Band
 PK-U - U-NII: Maximum Peak

HARMONICS AND SPURIOUS EMISSIONS TEST DATA

Mode	Freq. [MHz]	Antenna	Frequency [GHz]	Reading [dBuV]	Detector Mode	ANT Factor	Loss [dB]	DC Corr [dB]	Result [dBuV/m]	AV Limit [dBuV/m]	AV Margin [dB]	PK Limit [dBuV/m]	PK Margin [dB]	Non-Restricted [dBuV/m]	Margin [dB]	Azimuth [Degs]	Height [cm]	Polarity		
802.11a	5745	MIMO	8.616	33.69	PK-U	36.00	-20.70	0.00	48.99	-	-	-	-	68.20	-19.21	0	100	H		
			8.616	34.33	PK-U	36.00	-20.70	0.00	49.63	-	-	-	-	-	68.20	-18.57	0	100	V	
			* 11.48931	33.93	PK-U	38.20	-19.30	0.00	52.83	-	-	74.00	-21.17	-	-	-	0	100	H	
			* 11.49129	34.17	PK-U	38.20	-19.30	0.00	53.07	-	-	74.00	-20.93	-	-	-	0	100	V	
			17.235	33.54	PK-U	41.20	-18.40	0.00	56.34	-	-	-	-	-	-	68.20	-11.86	0	100	H
			17.237	34.12	PK-U	41.20	-18.40	0.00	56.92	-	-	-	-	-	-	68.20	-11.28	0	100	V
	5785	MIMO	8.676	34.85	PK-U	36.10	-21.80	0.00	49.15	-	-	-	-	-	68.20	-19.05	0	100	H	
			8.676	33.94	PK-U	36.10	-21.80	0.00	48.24	-	-	-	-	-	68.20	-19.96	0	100	V	
			* 11.56959	33.89	PK-U	38.20	-19.50	0.00	52.59	-	-	74.00	-21.41	-	-	-	0	100	H	
			* 11.57034	33.39	PK-U	38.20	-19.50	0.00	52.09	-	-	74.00	-21.91	-	-	-	0	100	V	
			17.357	34.15	PK-U	41.30	-18.20	0.00	57.25	-	-	-	-	-	-	68.20	-10.95	0	100	H
			17.356	34.00	PK-U	41.30	-18.30	0.00	57.00	-	-	-	-	-	-	68.20	-11.20	0	100	V
	5825	MIMO	8.739	35.00	PK-U	36.10	-22.40	0.00	48.70	-	-	-	-	-	68.20	-19.50	0	100	H	
			8.736	34.62	PK-U	36.10	-22.40	0.00	48.32	-	-	-	-	-	68.20	-19.88	0	100	V	
			* 11.65042	34.03	PK-U	38.30	-19.30	0.00	53.03	-	-	74.00	-20.97	-	-	-	0	100	H	
			* 11.65107	33.29	PK-U	38.30	-19.30	0.00	52.29	-	-	74.00	-21.71	-	-	-	0	100	V	
			17.478	33.34	PK-U	41.50	-16.80	0.00	58.04	-	-	-	-	-	-	68.20	-10.16	0	100	H
			17.475	33.88	PK-U	41.50	-16.80	0.00	58.58	-	-	-	-	-	-	68.20	-9.62	0	100	V
	802.11ax (HE20) 4RU Spot-Check	5745	MIMO	8.616	42.69	PK-U	36.20	-28.60	0.00	50.29	-	-	-	-	68.20	-17.91	0	100	H	
				8.620	41.62	PK-U	36.20	-28.60	0.00	49.22	-	-	-	-	-	68.20	-18.98	0	100	V
				* 11.49017	41.11	PK-U	38.50	-27.30	0.00	52.31	-	-	74.00	-21.69	-	-	-	0	100	H
* 11.48434				41.72	PK-U	38.50	-27.40	0.00	52.82	-	-	74.00	-21.18	-	-	-	0	100	V	
17.229				37.05	PK-U	41.10	-20.20	0.00	57.95	-	-	-	-	-	-	68.20	-10.25	0	100	H
17.228				37.75	PK-U	41.20	-20.20	0.00	58.75	-	-	-	-	-	-	68.20	-9.45	0	100	V

Note1. PK-U - U-NII: Maximum Peak / ADR - U-NII AD primary method, RMS average
 Note2. * - indicates frequency in CFR47 Pt 15 / IC RSS-Restricted Band

12. WORST-CASE BELOW 1 GHz SPURIOUS EMISSIONS 30 TO 1000 MHz (WORST-CASE CONFIGURATION, HORIZONTAL)

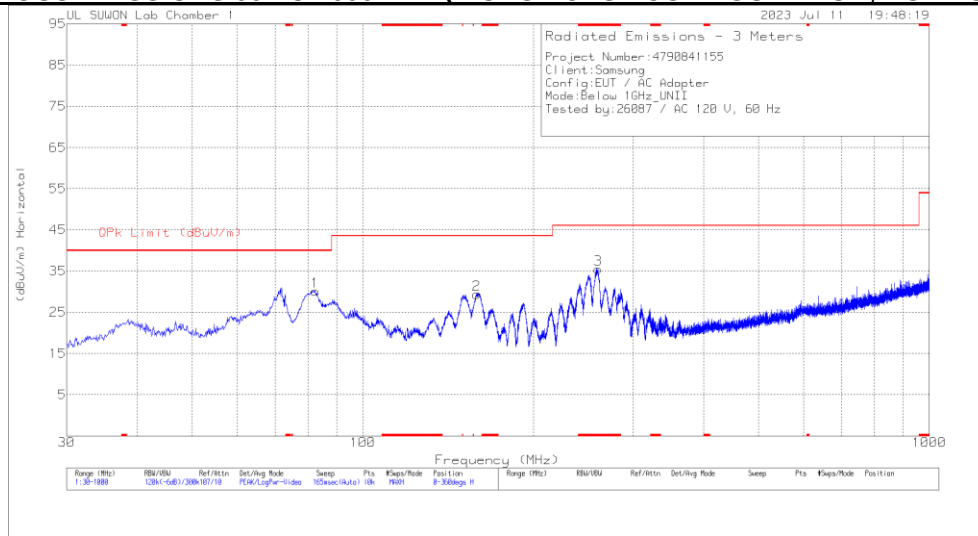

SPURIOUS EMISSIONS 30 TO 1000 MHz (WORST-CASE CONFIGURATION, VERTICAL)

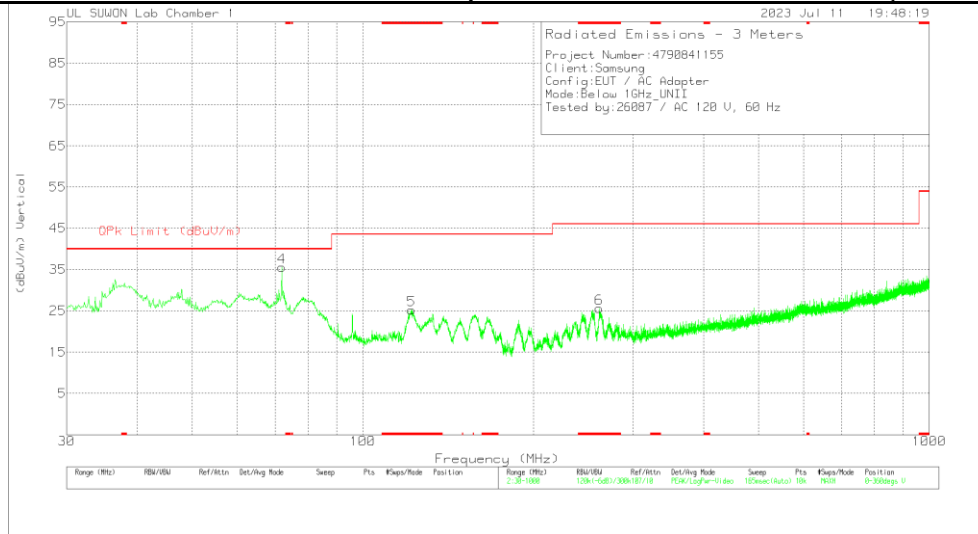

Trace Markers

Marker	Frequency (MHz)	Meter Reading (dBuV)	Det	VULB9163_750	Below_1G[dB]	DC Corr (dB)	Corrected Reading (dBuV/m)	QPk Limit (dBuV/m)	Margin (dB)	Azimuth (Degs)	Height (cm)	Polarity
1	82.477	47.35	Pk	13.3	-30.6	0	30.05	40	-9.95	0-360	300	H
2	158.913	44.84	Pk	14.2	-29.7	0	29.34	43.52	-14.18	0-360	100	H
3	* 260.181	46.21	Pk	18.1	-28.8	0	35.51	46.02	-10.51	0-360	100	H
4	71.904	51.95	Pk	14.2	-30.6	0	35.55	40	-4.45	0-360	100	V
5	* 121.859	40.03	Pk	15.3	-30.1	0	25.23	43.52	-18.29	0-360	100	V
6	* 261.345	36.33	Pk	18.1	-28.8	0	25.63	46.02	-20.39	0-360	100	V

* - indicates frequency in CFR47 Pt 15 / IC RSS-Restricted Band
 Pk - Peak detector

Radiated Emissions

Frequency (MHz)	Meter Reading (dBuV)	Det	VULB9163_750	Below_1G[dB]	DC Corr (dB)	Corrected Reading (dBuV/m)	QPk Limit (dBuV/m)	Margin (dB)	Azimuth (Degs)	Height (cm)	Polarity
71.904	41.03	Qp	14.2	-30.6	.14	24.77	40	-15.23	116	103	V

* - indicates frequency in CFR47 Pt 15 / IC RSS-Restricted Band
 Qp - Quasi-Peak detector

13. AC POWER LINE CONDUCTED EMISSIONS

LIMITS

FCC §15.207 (a)
IC RSS-GEN Clause 8.8

Frequency of Emission (MHz)	Conducted Limit (dBuV)	
	Quasi-peak	Average
0.15-0.5	66 to 56 [*]	56 to 46 [*]
0.5-5	56	46
5-30	60	50

^{*}Decreases with the logarithm of the frequency.

TEST PROCEDURE

The EUT is placed on a non-conducting table 40 cm from the vertical ground plane and 80 cm above the horizontal ground plane. The EUT is configured in accordance with ANSI C63.10.

The receiver is set to a resolution bandwidth of 9 kHz. Peak detection is used unless otherwise noted as quasi-peak or average.

Line conducted data is recorded for both NEUTRAL and HOT lines.

RESULTS

WORST EMISSIONS

LINE 1 DATA

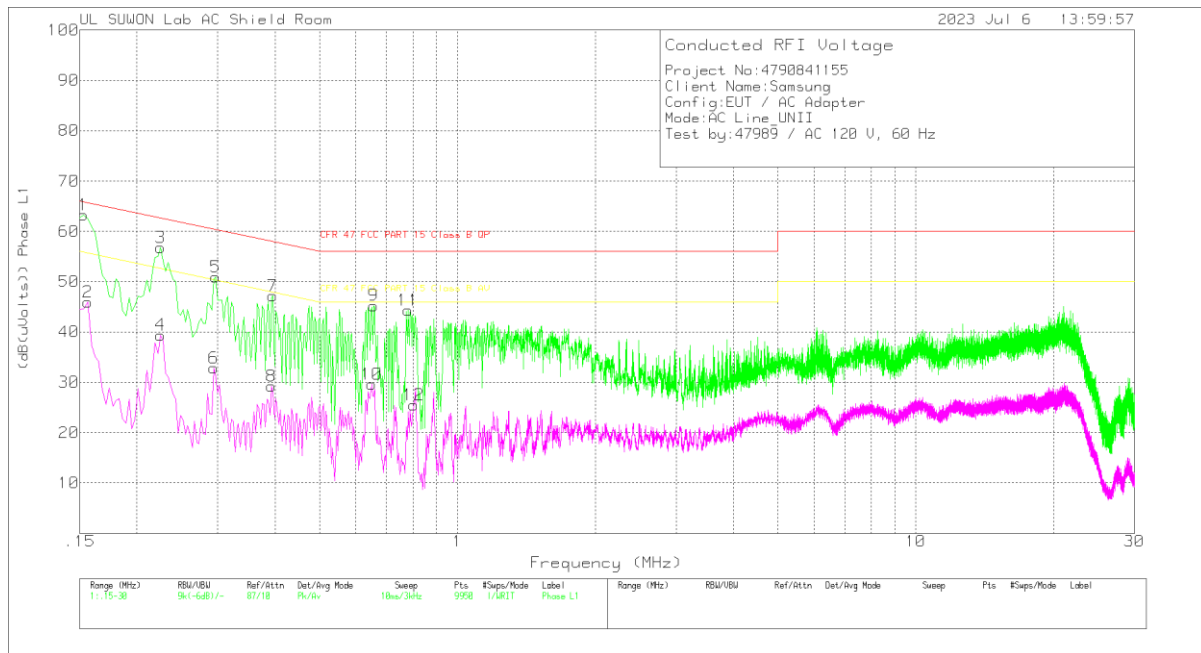

Trace Markers

Range 1: Phase L1 .15 - 30MHz

Marker	Frequency (MHz)	Meter Reading (dBuV)	Det	101836_AU TO_With EX_L1[dB]	CABLELOS S[dB]	Corrected Reading (dB(uVolts))	CFR 47 FCC PART 15 Class B QP	Margin (dB)	CFR 47 FCC PART 15 Class B AV	Margin (dB)
1	.153	53.62	Pk	9.5	.1	63.22	65.84	-2.62	-	-
2	.156	36.31	Av	9.5	.1	45.91	-	-	55.67	-9.76
3	.225	47.11	Pk	9.5	.2	56.81	62.63	-5.82	-	-
4	.225	29.7	Av	9.5	.2	39.4	-	-	52.63	-13.23
5	.297	41.25	Pk	9.5	.2	50.95	60.33	-9.38	-	-
6	.294	23.21	Av	9.5	.2	32.91	-	-	50.41	-17.5
7	.396	37.54	Pk	9.5	.2	47.24	57.94	-10.7	-	-
8	.393	19.55	Av	9.5	.2	29.25	-	-	48	-18.75
9	.657	35.46	Pk	9.6	.2	45.26	56	-10.74	-	-
10	.651	19.77	Av	9.6	.2	29.57	-	-	46	-16.43
11	.78	34.5	Pk	9.6	.2	44.3	56	-11.7	-	-
12	.804	15.67	Av	9.6	.2	25.47	-	-	46	-20.53

Pk - Peak detector

Av - Average detection

Quasi-Peak Emissions

Range 1: Phase L1 .15 - 30MHz

Frequency (MHz)	Meter Reading (dBuV)	Det	101836_AU O_With EX_L1[dB]	CABLELOS S[dB]	Corrected Reading (dB(uVolts))	CFR 47 FCC PART 15 Class B QP	Margin (dB)	CFR 47 FCC PART 15 Class B AV	Margin (dB)
.15225	24.62	Qp	9.5	.1	34.22	65.88	-31.66	-	-
.22575	27.32	Qp	9.5	.2	37.02	62.6	-25.58	-	-

Qp - Quasi-Peak detector

LINE 2 DATA

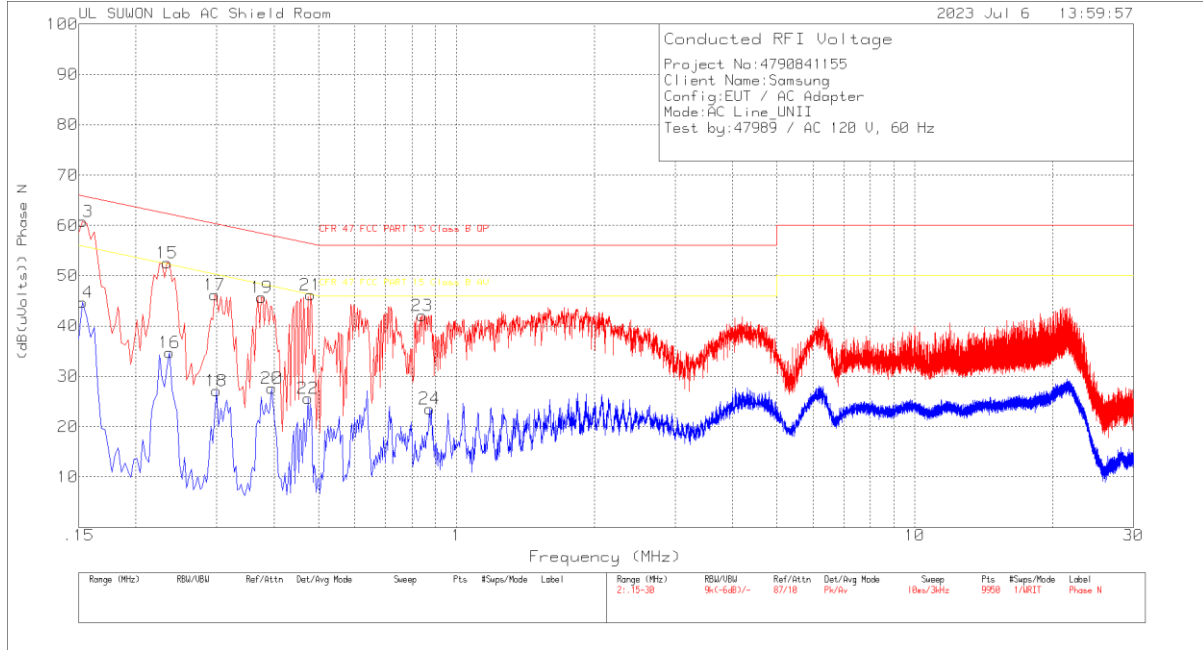

Trace Markers

Range 2: Phase N .15 - 30MHz

Marker	Frequency (MHz)	Meter Reading (dBuV)	Det	101836_AU TO_With EX_N[dB]	CABLELOS S[dB]	Corrected Reading (dB(uVolts))	CFR 47 FCC PART 15 Class B QP	Margin (dB)	CFR 47 FCC PART 15 Class B AV	Margin (dB)
13	.153	51.13	Pk	9.5	.1	60.73	65.84	-5.11	-	-
14	.153	35.06	Av	9.5	.1	44.66	-	-	55.84	-11.18
15	.234	42.86	Pk	9.5	.2	52.56	62.31	-9.75	-	-
16	.237	25.04	Av	9.5	.2	34.74	-	-	52.2	-17.46
17	.297	36.45	Pk	9.5	.2	46.15	60.33	-14.18	-	-
18	.3	17.41	Av	9.5	.2	27.11	-	-	50.24	-23.13
19	.3765	35.95	Pk	9.5	.2	45.65	58.36	-12.71	-	-
20	.396	17.88	Av	9.5	.2	27.58	-	-	47.94	-20.36
21	.48	36.5	Pk	9.5	.2	46.2	56.34	-10.14	-	-
22	.474	15.89	Av	9.5	.2	25.59	-	-	46.44	-20.85
23	.843	32.23	Pk	9.6	.3	42.13	56	-13.87	-	-
24	.873	13.67	Av	9.6	.3	23.57	-	-	46	-22.43

Pk - Peak detector

Av - Average detection

Quasi-Peak Emissions

Range 2: Phase N .15 - 30MHz

Frequency (MHz)	Meter Reading (dBuV)	Det	101836_AU O_With EX_N[dB]	CABLELOS S[dB]	Corrected Reading (dB(uVolts))	CFR 47 FCC PART 15 Class B QP	Margin (dB)	CFR 47 FCC PART 15 Class B AV	Margin (dB)
.15225	24.2	Qp	9.5	.1	33.8	65.88	-32.08	-	-
.23325	24.15	Qp	9.5	.2	33.85	62.33	-28.48	-	-

Qp - Quasi-Peak detector

14. DYNAMIC FREQUENCY SELECTION

14.1. OVERVIEW

14.1.1. LIMITS

FCC

§15.407 (h), FCC KDB 905462 D02 “COMPLIANCE MEASUREMENT PROCEDURES FOR UNLICENSED-NATIONAL INFORMATION INFRASTRUCTURE DEVICES OPERATING IN THE 5250-5350 MHz AND 5470-5725 MHz BANDS INCORPORATING DYNAMIC FREQUENCY SELECTION” and KDB 905462 D03 “U-NII CLIENT DEVICES WITHOUT RADAR DETECTION CAPABILITY”.

Table 1: Applicability of DFS requirements prior to use of a channel

Requirement	Operational Mode		
	Master	Client (without radar detection)	Client (with radar detection)
Non-Occupancy Period	Yes	Not required	Yes
DFS Detection Threshold	Yes	Not required	Yes
Channel Availability Check Time	Yes	Not required	Not required
U-NII Detection Bandwidth	Yes	Not required	Yes

Table 2: Applicability of DFS requirements during normal operation

Requirement	Operational Mode		
	Master	Client (without DFS)	Client (with DFS)
DFS Detection Threshold	Yes	Not required	Yes
Channel Closing Transmission Time	Yes	Yes	Yes
Channel Move Time	Yes	Yes	Yes
U-NII Detection Bandwidth	Yes	Not required	Yes

Additional requirements for devices with multiple bandwidth modes	Master Device or Client with Radar DFS	Client (without DFS)
U-NII Detection Bandwidth and Statistical Performance Check	All BW modes must be tested	Not required
Channel Move Time and Channel Closing Transmission Time	Test using widest BW mode available	Test using the widest BW mode available for the link
All other tests	Any single BW mode	Not required

Note: Frequencies selected for statistical performance check (Section 7.8.4) should include several frequencies within the radar detection bandwidth and frequencies near the edge of the radar detection bandwidth. For 802.11 devices it is suggested to select frequencies in all 20 MHz channel blocks and a null frequency between the bonded 20 MHz channel blocks.

Table 3: Interference Threshold values, Master or Client incorporating In-Service Monitoring

Maximum Transmit Power	Value (see notes)
E.I.R.P. \geq 200 mill watt	-64 dBm
E.I.R.P. < 200 mill watt and power spectral density < 10 dBm/MHz	-62 dBm
E.I.R.P. < 200 mill watt that do not meet power spectral density requirement	-64 dBm
<p>Note 1: This is the level at the input of the receiver assuming a 0 dBi receive antenna Note 2: Throughout these test procedures an additional 1 dB has been added to the amplitude of the test transmission waveforms to account for variations in measurement equipment. This will ensure that the test signal is at or above the detection threshold level to trigger a DFS response. Note 3: E.I.R.P. is based on the highest antenna gain. For MIMO devices refer to KDB publication 662911 D01.</p>	

Table 4: DFS Response requirement values

Parameter	Value
<i>Non-occupancy period</i>	30 minutes
<i>Channel Availability Check Time</i>	60 seconds
<i>Channel Move Time</i>	10 seconds (See Note 1)
<i>Channel Closing Transmission Time</i>	200 milliseconds + approx. 60 milliseconds over remaining 10 second period. (See Notes 1 and 2)
<i>U-NII Detection Bandwidth</i>	Minimum 100% of the U- NII 99% transmission power bandwidth. (See Note 3)
<p>Note 1: <i>Channel Move Time</i> and the <i>Channel Closing Transmission Time</i> should be performed with Radar Type 0. The measurement timing begins at the end of the Radar Type 0 burst. Note 2: The <i>Channel Closing Transmission Time</i> is comprised of 200 milliseconds starting at the beginning of the <i>Channel Move Time</i> plus any additional intermittent control signals required to facilitate a <i>Channel</i> move (an aggregate of 60 milliseconds) during the remainder of the 10 second period. The aggregate duration of control signals will not count quiet periods in between transmissions. Note 3: During the <i>U-NII Detection Bandwidth</i> detection test, radar type 0 should be used. For each frequency step the minimum percentage of detection is 90 percent. Measurements are performed with no data traffic.</p>	

Table 5 – Short Pulse Radar Test Waveforms

Radar Type	Pulse Width (usec)	PRI (usec)	Pulses	Minimum Percentage of Successful Detection	Minimum Trials
0	1	1428	18	See Note 1	See Note 1
1	1	Test A: 15 unique PRI values randomly selected from the list of 23 PRI values in table 5a	Roundup: $\{(1/360) \times (19 \times 10^6 \text{ PRI}_{\text{usec}})\}$	60%	30
		Test B: 15 unique PRI values randomly selected within the range of 518-3066 usec. With a minimum increment of 1 usec, excluding PRI values selected in Test A			
2	1-5	150-230	23-29	60%	30
3	6-10	200-500	16-18	60%	30
4	11-20	200-500	12-16	60%	30
Aggregate (Radar Types 1-4)				80%	120
Note 1: Short Pulse Radar Type 0 should be used for the <i>Detection Bandwidth</i> test, <i>Channel Move Time</i> , and <i>Channel Closing Time</i> tests.					

Table 6 – Long Pulse Radar Test Signal

Radar Waveform Type	Pulse Width (μsec)	Chirp Width (MHz)	PRI (μsec)	Pulses per Burst	Number of Bursts	Minimum Percentage of Successful Detection	Minimum Trials
5	50-100	5-20	1000-2000	1-3	8-20	80%	30

Table 7 – Frequency Hopping Radar Test Signal

Radar Waveform Type	Pulse Width (μsec)	PRI (μsec)	Pulses per Hop	Hopping Rate (kHz)	Hopping Sequence Length (msec)	Minimum Percentage of Successful Detection	Minimum Trials
6	1	333	9	0.333	300	70%	30

14.1.2. TEST AND MEASUREMENT SYSTEM

CONDUCTED METHOD SYSTEM BLOCK DIAGRAM

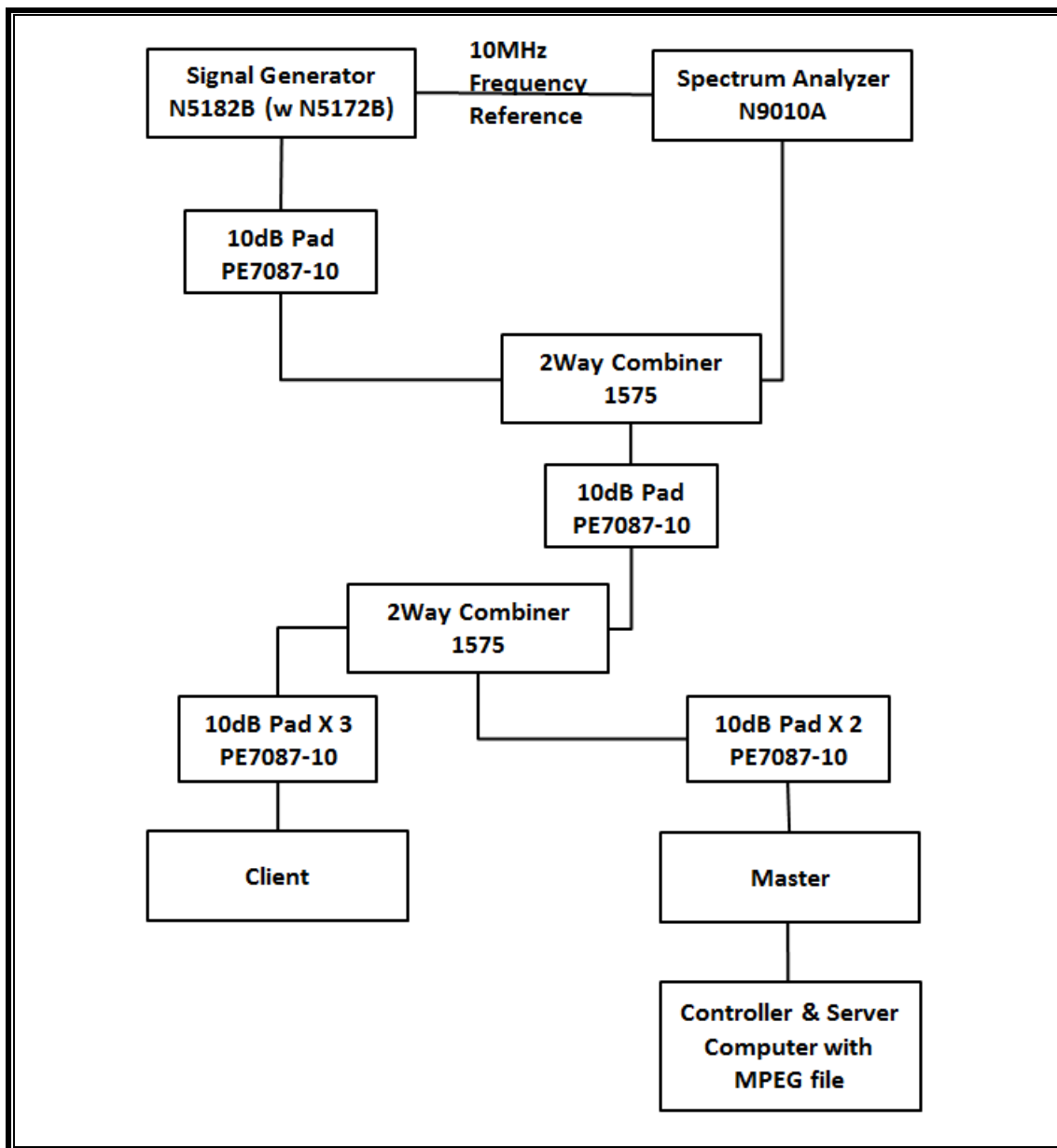

SYSTEM OVERVIEW

The short pulse and long pulse signal generating system utilizes the Keysite Signal Studio for Pulse Building as N5172B. The Vector Signal Generator has been validated by the NTIA. The hopping signal generating system utilizes the CCS simulated hopping method and system, which has been validated by the DoD, FCC and NTIA. The software selects waveform parameters from within the bounds of the signal type on a random basis using uniform distribution.

The short pulse types 1, 2, 3 and 4, and the long pulse type 5 parameters are randomized at run-time.

The hopping type 6 pulse parameters are fixed while the hopping sequence is based on the August 2005 NTIA Hopping Frequency List. The initial starting point randomized at run-time and each subsequent starting point is incremented by 475. Each frequency in the 100-length segment is compared to the boundaries of the EUT Detection Bandwidth and the software creates a hopping burst pattern in accordance with Section 7.4.1.3 Method #2 Simulated Frequency Hopping Radar Waveform Generating Subsystem of KDB 905462 D02. The frequency of the signal generator is incremented in 1 MHz steps from F_L to F_H for each successive trial. This incremental sequence is repeated as required to generate a minimum of 30 total trials and to maintain a uniform frequency distribution over the entire Detection Bandwidth.

The signal monitoring equipment consists of a spectrum analyzer. The aggregate ON time is calculated by multiplying the number of bins above a threshold during a particular observation period by the dwell time per bin, with the analyzer set to peak detection and max hold.

SYSTEM CALIBRATION

A 50-ohm load is connected in place of the spectrum analyzer, and the spectrum analyzer is connected to a horn antenna via a coaxial cable, with the reference level offset set to (horn antenna gain – coaxial cable loss). The signal generator is set to CW mode. The amplitude of the signal generator is adjusted to yield a level of –64 dBm as measured on the spectrum analyzer.

Without changing any of the instrument settings, the spectrum analyzer is reconnected to the Common port of the Spectrum Analyzer Combiner/Divider. The Reference Level Offset of the spectrum analyzer is adjusted so that the displayed amplitude of the signal is –64 dBm.

The spectrum analyzer displays the level of the signal generator as received at the antenna ports of the Master Device. The interference detection threshold may be varied from the calibrated value of –64 dBm and the spectrum analyzer will still indicate the level as received by the Master Device.

ADJUSTMENT OF DISPLAYED TRAFFIC LEVEL

A link is established between the Master and Slave and the distance between the units is adjusted as needed to provide a suitable received level at the Master and Slave devices. The video test file is streamed to generate WLAN traffic. The monitoring antenna is adjusted so that the WLAN traffic level, as displayed on the spectrum analyzer, is at lower amplitude than the radar detection threshold.

TEST AND MEASUREMENT EQUIPMENT

The following test and measurement equipment was utilized for the DFS tests documented in this report:

TEST EQUIPMENT LIST				
Description	Manufacturer	Model	S/N	Next Cal Due
Spectrum Analyzer, 7 GHz	Agilent / HP	N9010A	MY54200580	08-01-23
Vector Signal Generator, 6GHz	Agilent / HP	N5182B	MY53051241	08-01-23
Combiner	WEINSCHTEL	WA1534	UL001	01-13-24
Combiner	WEINSCHTEL	WA1534	UL003	01-09-24

14.1.3. SETUP OF EUT

CONDUCTED METHOD EUT TEST SETUP

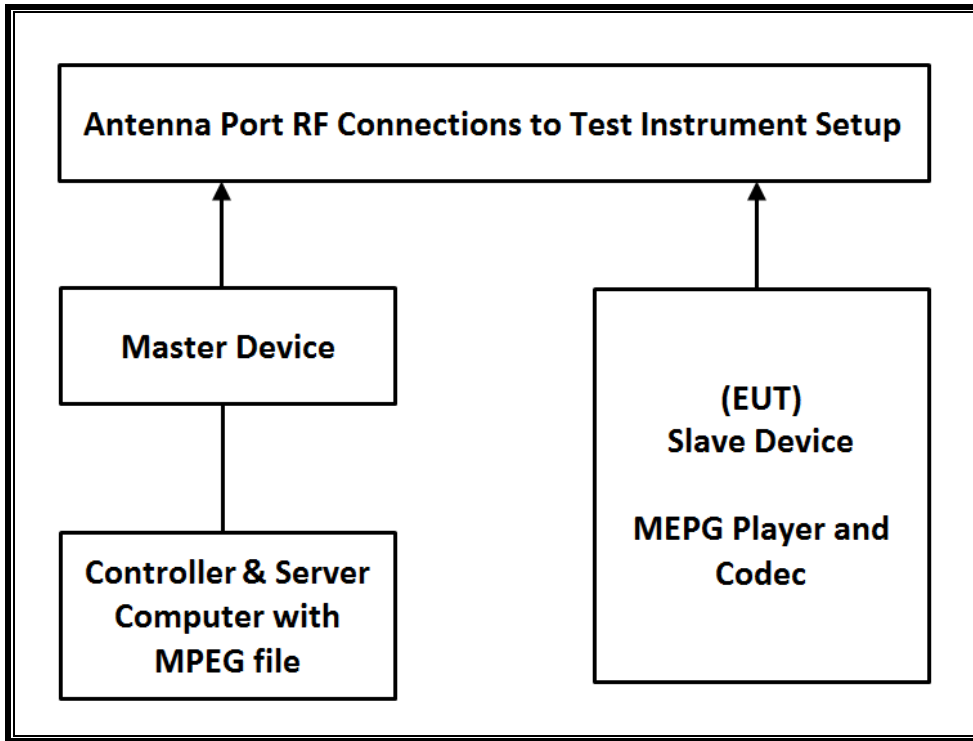

SUPPORT EQUIPMENT

The following support equipment was utilized for the DFS tests documented in this report:

PERIPHERAL SUPPORT EQUIPMENT LIST				
Description	Manufacturer	Model	Serial Number	FCC ID
Wireless Access Point	Cisco	AIR-CAP3702E-A-K9	FTX182276QX	LDK102087
Notebook PC (Controller/Server)	HP	HP EliteDesk 800 G1 TWR	CZC4125J25	DoC

14.1.4. DESCRIPTION OF EUT

The EUT operates over the 5250-5350 MHz and 5470-5725 MHz ranges.

The EUT is a Slave Device without Radar Detection.

The highest power level of the widest bandwidth (802.11ac VHT80) within these bands is 7.66 dBm in the 5250-5350 MHz band and 12.63 dBm in the 5470-5725 MHz band.

The antenna assembly utilized two antenna.

Gain of ANT1 : -6.0 dBi for UNII 2A and -5.9 dBi for UNII 2C.

Gain of ANT2 : -6.1 dBi for UNII 2A and -6.2 dBi for UNII 2C.

The rated output power of the Master unit is > 23dBm (EIRP). Therefore the required interference threshold level is -64 dBm. After correction for procedural adjustments, the required conducted threshold at the antenna port is $-64 + 1 = -63$ dBm.

The calibrated radiated DFS Detection Threshold level is set to -64 dBm. The tested level is lower than the required level hence it provides a margin to the limit.

The EUT uses one transmitter/receiver chain connected to an antenna to perform radiated tests. WLAN traffic that meets or exceeds the minimum required loading was generated by transferring a data stream from the controller/server PC to the EUT using iPerf version 2.0.5 software package.

TPC is not required since the maximum EIRP is less than 500 mW (27 dBm).

The EUT utilizes the 802.11 architecture. Three nominal channel bandwidths are implemented: 20 MHz, 40 MHz and 80 MHz.

The software installed in the access point is 12.4(25d)JA1.

UNIFORM CHANNEL SPREADING

This requirement is not applicable to Slave radio devices.

CHANNEL PUNCTURING(802.11ax)

This EUT does not support channel puncturing.

OVERVIEW OF MASTER DEVICE WITH RESPECT TO §15.407 (h) REQUIREMENTS

The Master Device is a Cisco Access Point, FCC ID: LDK102087. The minimum antenna gain for the Master Device is 6 dBi.

The rated output power of the Master unit is > 23dBm (EIRP). Therefore the required interference threshold level is -64 dBm. After correction for procedural adjustments, the required radiated threshold at the antenna port is $-64 + 1 = -63$ dBm.

The calibrated radiated DFS Detection Threshold level is set to -64 dBm. The tested level is lower than the required level hence it provides a margin to the limit.

14.2. RESULTS FOR 80 MHz BANDWIDTH (UNII-2A BAND)

14.2.1. TEST CHANNEL

All tests were performed at a channel center frequency of 5290 MHz.

14.2.2. RADAR WAVEFORM AND TRAFFIC

RADAR WAVEFORM

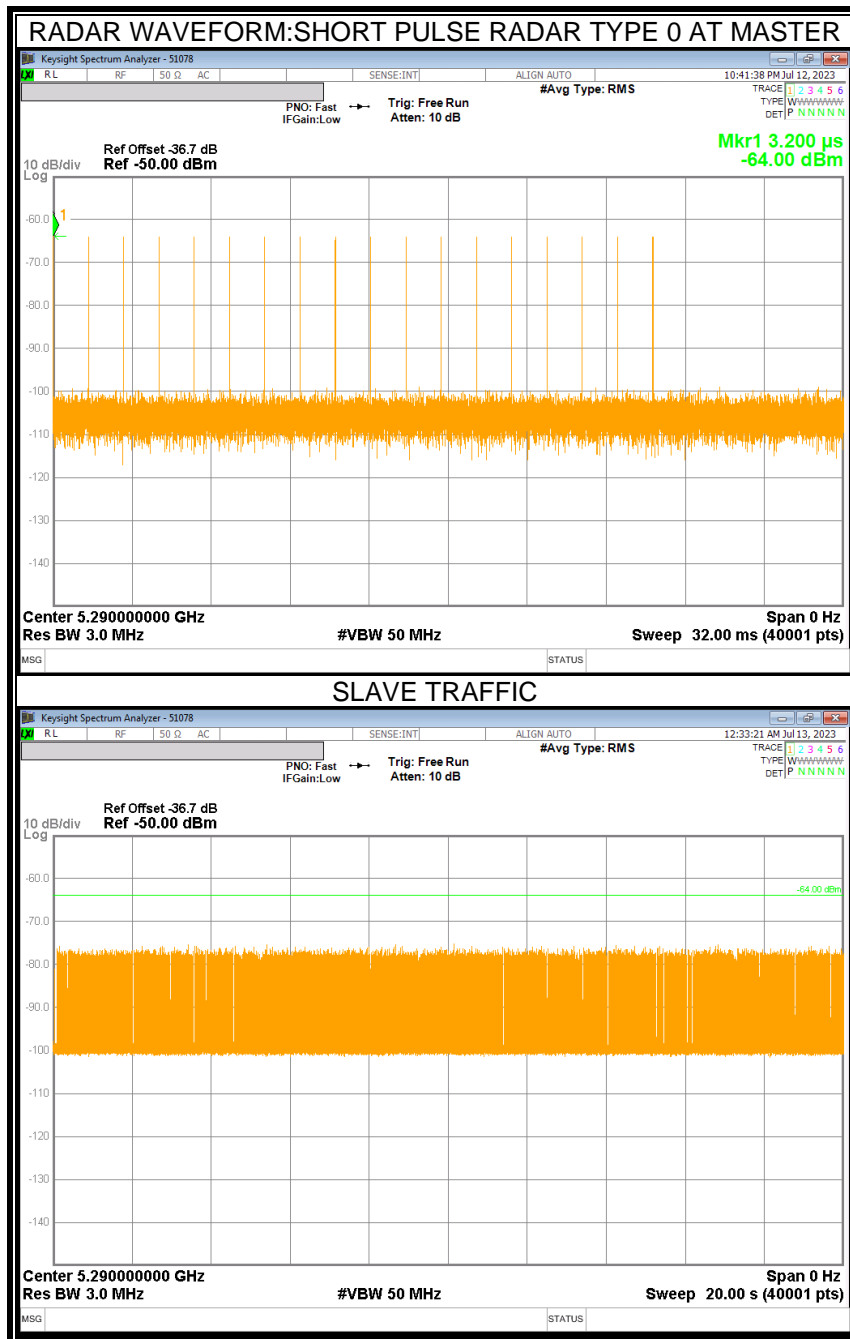

14.2.3. OVERLAPPING CHANNEL TESTS

RESULTS

These tests are not applicable.

14.2.4. MOVE AND CLOSING TIME

REPORTING NOTES

The reference marker is set at the end of last radar pulse.

The delta marker is set at the end of the last WLAN transmission following the radar pulse. This delta is the channel move time.

The aggregate channel closing transmission time is calculated as follows:

Aggregate Transmission Time =
(Number of analyzer bins showing transmission) * (dwell time per bin)

The observation period over which the aggregate time is calculated begins at (Reference Marker + 200 msec) and ends no earlier than (Reference Marker + 10 sec).

RESULTS

Channel Move Time (sec)	Limit (sec)
0.741	10

Aggregate Channel Closing Transmission Time (msec)	Limit (msec)
4.125	60

MOVE TIME & CHANNEL CLOSING TIME

AGGREGATE CHANNEL CLOSING TRANSMISSION TIME

No transmissions are observed during the aggregate monitoring period.

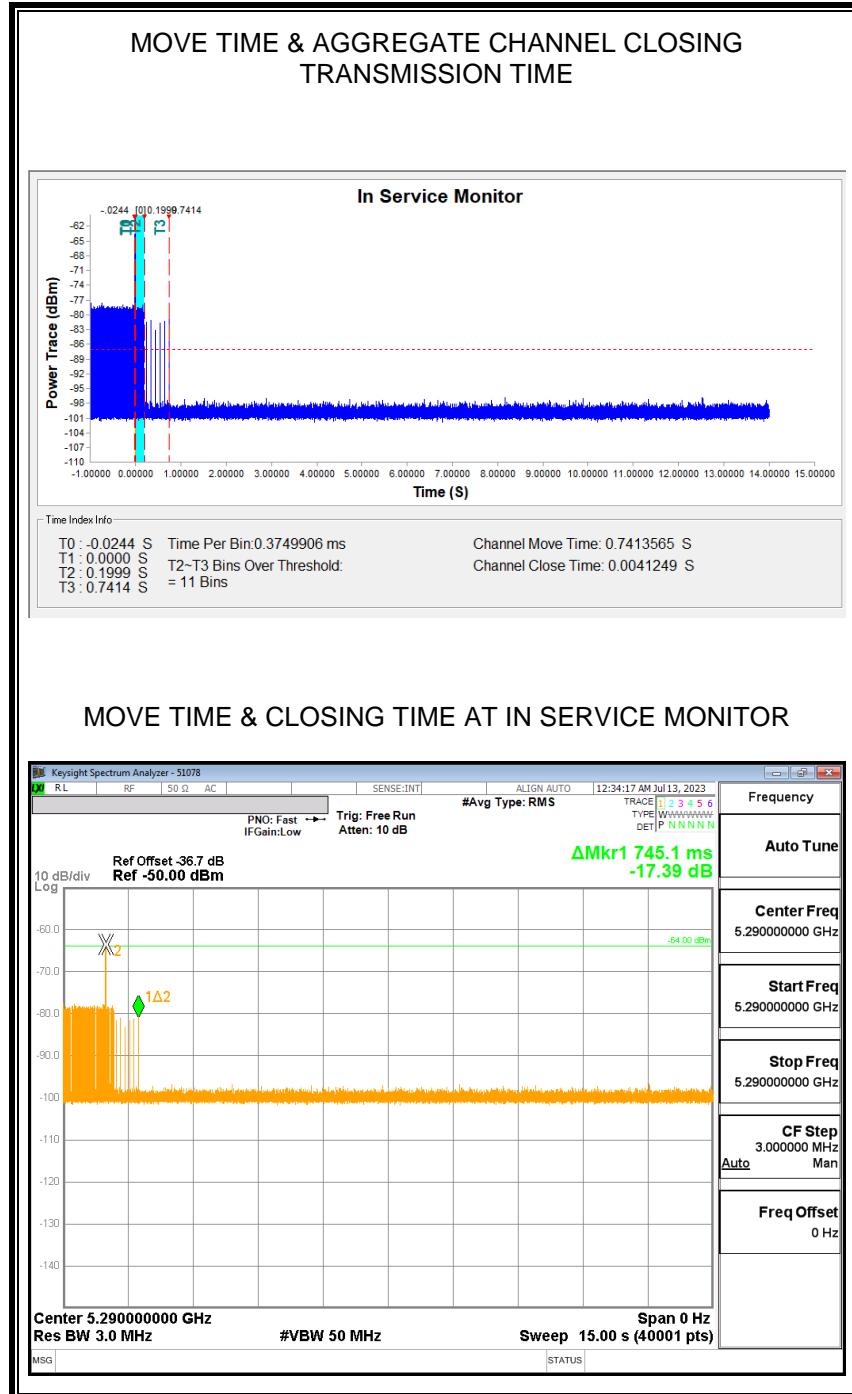

NON-OCCUPANCY PERIOD

RESULTS

No EUT transmissions were observed on the test channel during the 10-minute observation time.

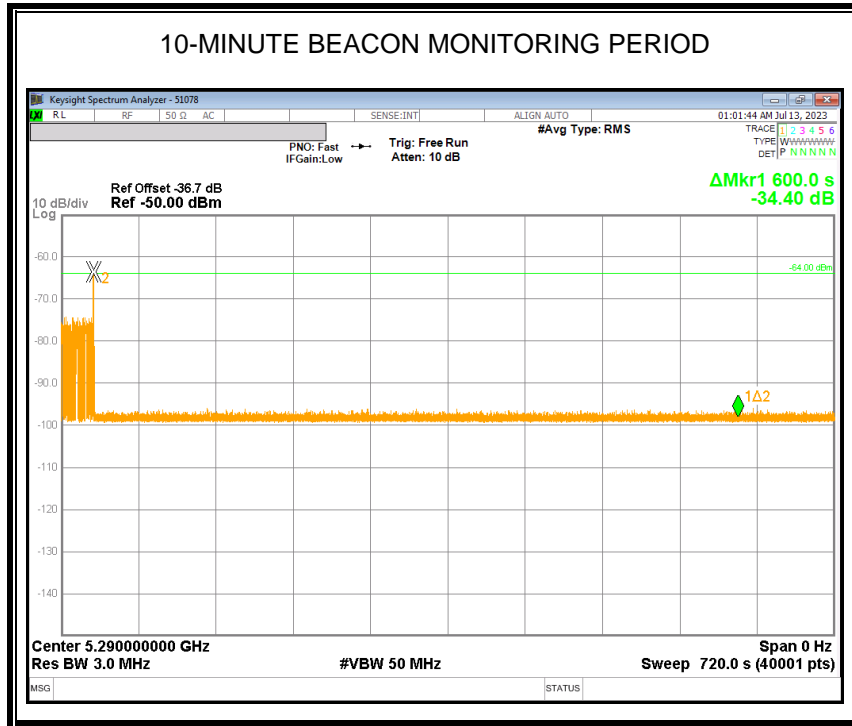

14.3. RESULTS FOR 80 MHz BANDWIDTH (UNII-2C BAND)

14.3.1. TEST CHANNEL

All tests were performed at a channel center frequency of 5530 MHz.

14.3.2. RADAR WAVEFORM AND TRAFFIC

RADAR WAVEFORM

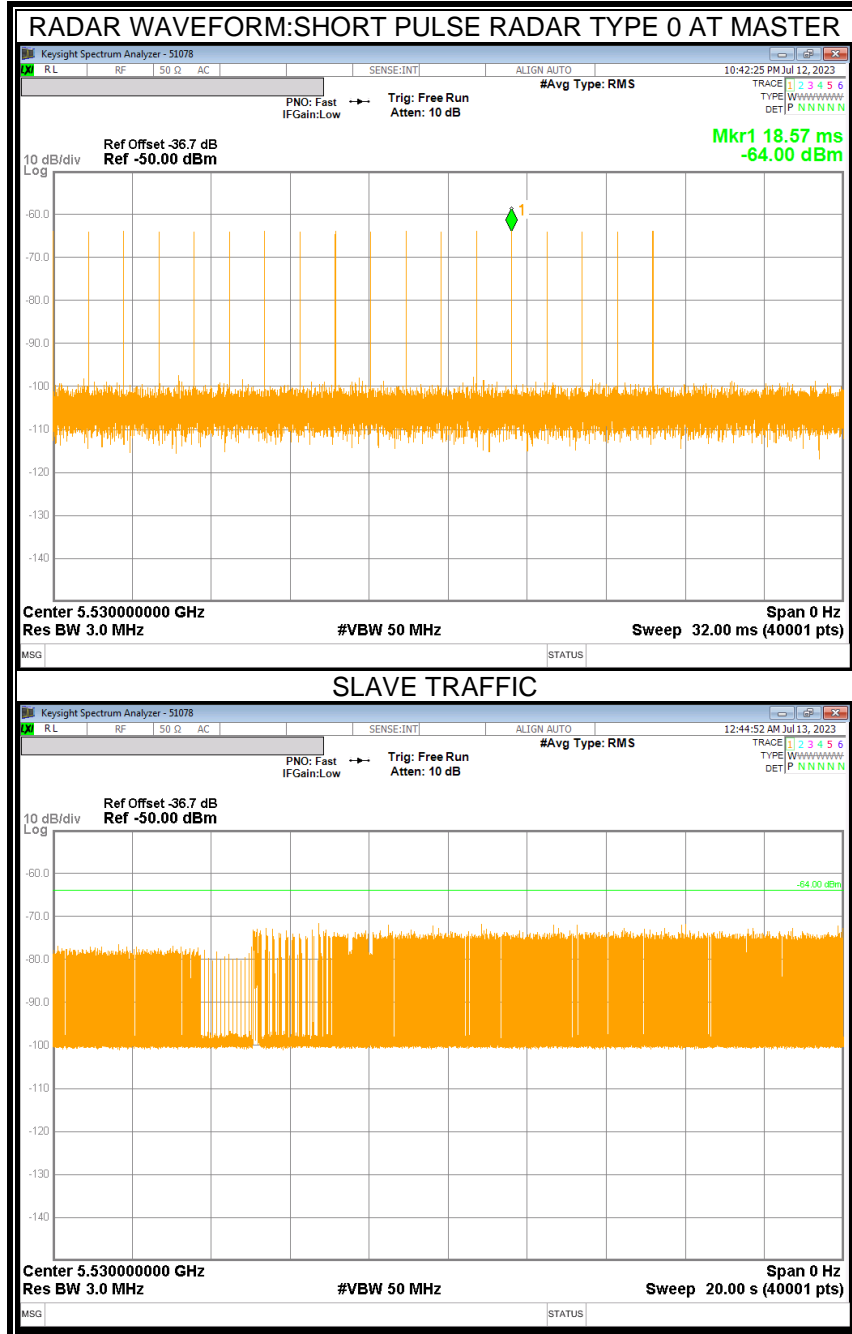

14.3.3. OVERLAPPING CHANNEL TESTS

RESULTS

These tests are not applicable.

14.3.4. MOVE AND CLOSING TIME

REPORTING NOTES

The reference marker is set at the end of last radar pulse.

The delta marker is set at the end of the last WLAN transmission following the radar pulse. This delta is the channel move time.

The aggregate channel closing transmission time is calculated as follows:

Aggregate Transmission Time =
(Number of analyzer bins showing transmission) * (dwell time per bin)

The observation period over which the aggregate time is calculated begins at (Reference Marker + 200 msec) and ends no earlier than (Reference Marker + 10 sec).

RESULTS

Channel Move Time (sec)	Limit (sec)
0.711	10

Aggregate Channel Closing Transmission Time (msec)	Limit (msec)
3.375	60

MOVE TIME & CHANNEL CLOSING TIME

AGGREGATE CHANNEL CLOSING TRANSMISSION TIME

No transmissions are observed during the aggregate monitoring period.

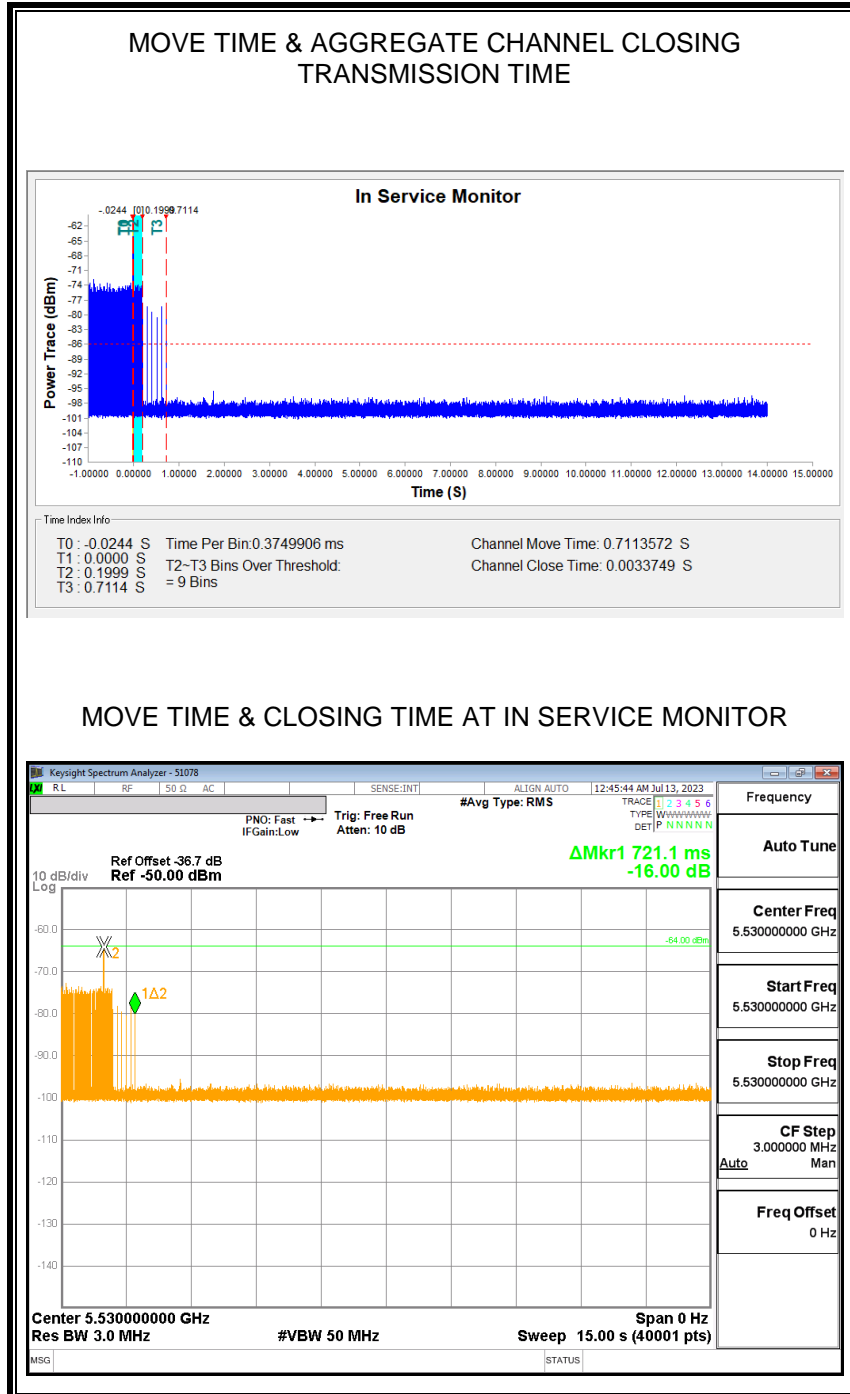

NON-OCCUPANCY PERIOD

RESULTS

No EUT transmissions were observed on the test channel during the 10-minute observation time.

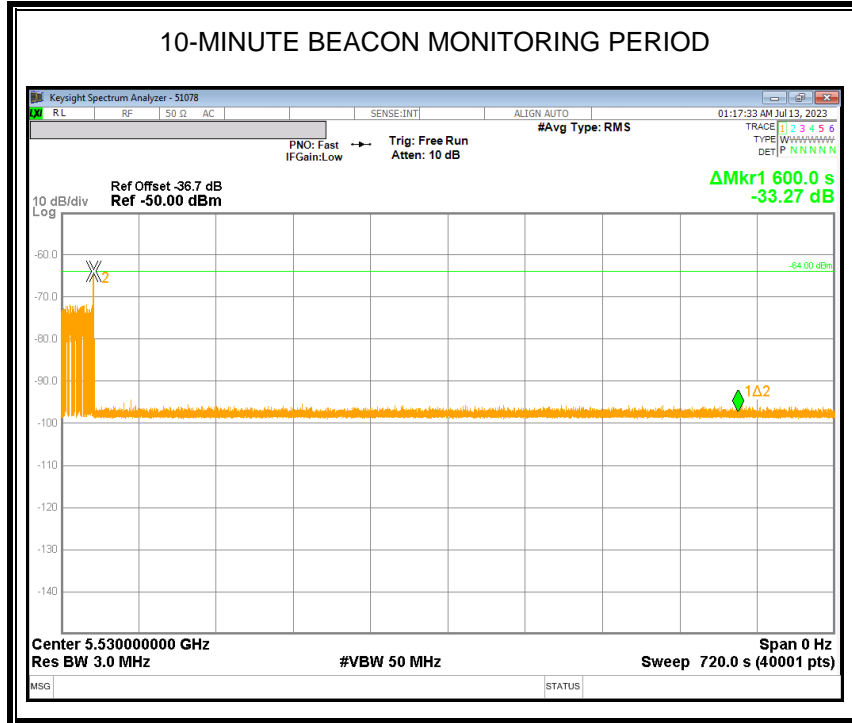

15. SPOT-CHECK TEST RESULT

BANDEDGE (WORST CASE: 802.11n HT40 / 5190 MHz)

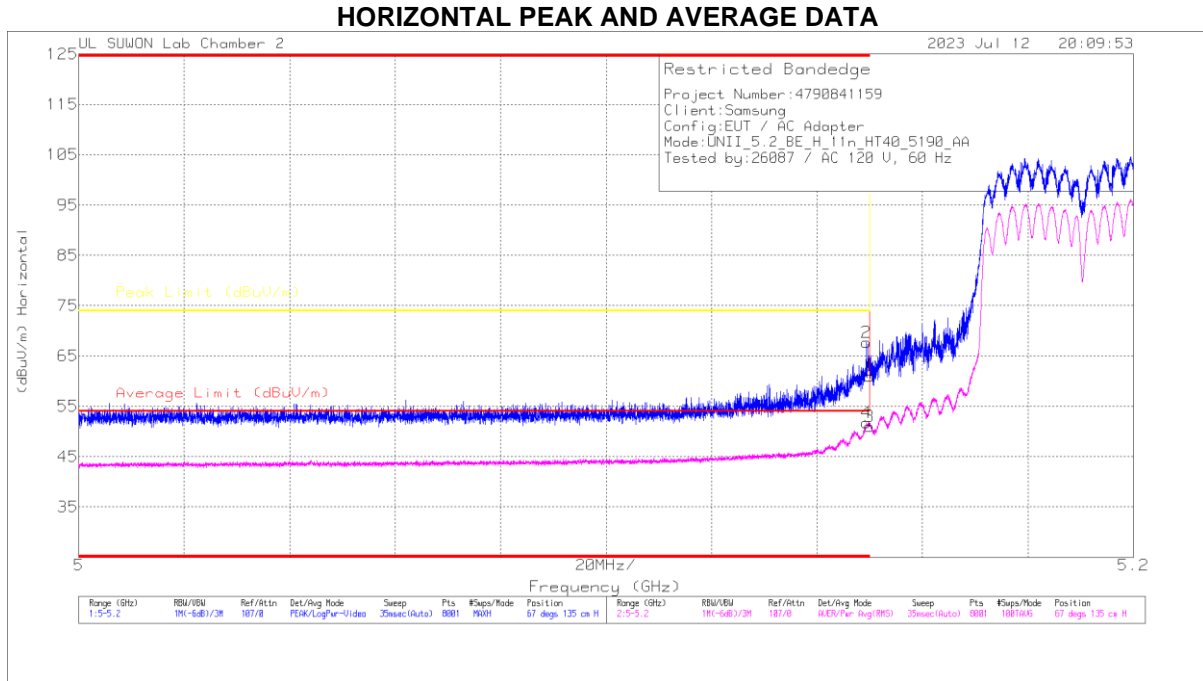

Trace Markers

Marker	Frequency (GHz)	Meter Reading (dBuV)	Det	3117_00168724	10dB_ATT(dB)	DC Corr (dB)	Corrected Reading (dBuV/m)	Average Limit (dBuV/m)	Margin (dB)	Peak Limit (dBuV/m)	PK Margin (dB)	Azimuth (Degs)	Height (cm)	Polarity
1	* 5.15	44.02	PK	34.2	-17.2	0	61.02	-	-	74	-12.98	67	135	H
2	* 5.14935	50.67	PK	34.2	-17.2	0	67.67	-	-	74	-6.33	67	135	H
3	* 5.15	33.91	RMS	34.2	-17.2	.1	51.01	54	-2.99	-	-	67	135	H
4	* 5.14943	34.66	RMS	34.2	-17.2	.1	51.76	54	-2.24	-	-	67	135	H

* - indicates frequency in CFR47 Pt 15 / IC RSS-Restricted Band
 PK - Peak detector
 RMS - RMS detection

HARMONICS AND SPURIOUS EMISSIONS(WORST CASE: 802.11a / 5180 MHz)
5180 MHz HORIZONTAL

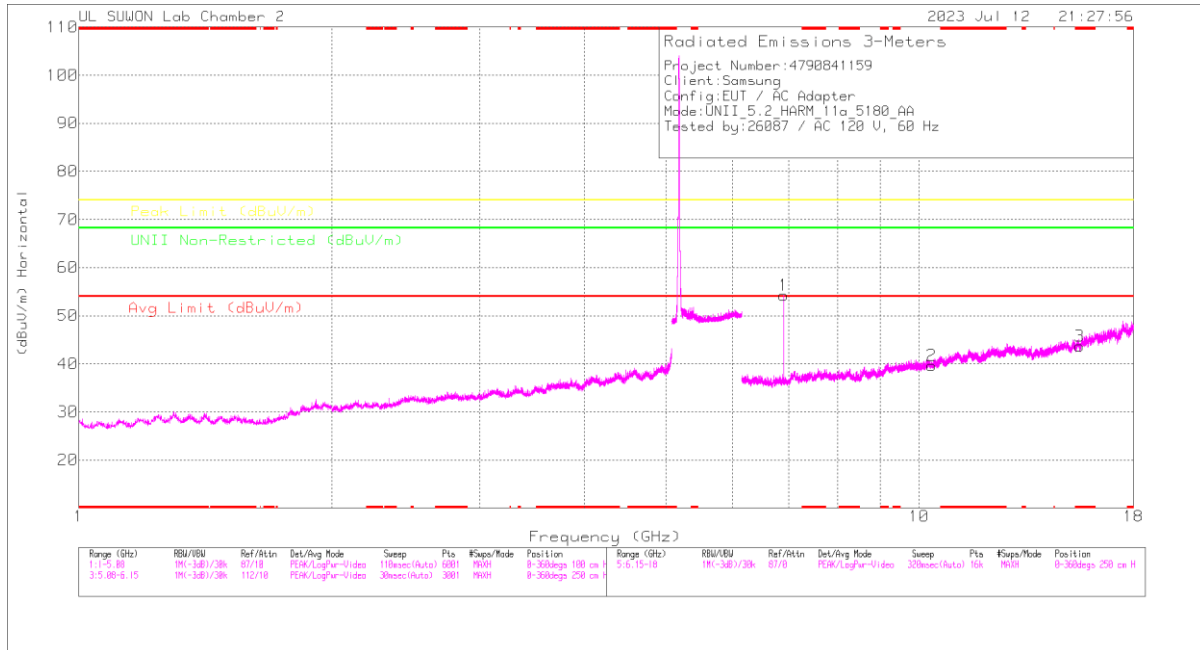

Note: Emission was scanned up to 40GHz; No emissions were detected above the noise floor which was at least 20dB below the specification limit.

Radiated Emissions

Frequency (GHz)	Meter Reading (dBm)	Det	3117_05168724	60Hz_HPL(B)	DC Corr (dB)	Conduct Reading (dB/m)	Avg Limit (dBuV/m)	Margin (dB)	Peak Limit (dBuV/m)	Margin (dB)	UNII Non-Restricted (dBuV/m)	Margin (dB)	Azimuth (Deg)	Height (cm)	Polarity
6.90662	48.11	PK-U	35.5	-24.3	0	59.31	-	-	-	-	68.2	-8.9	69	120	H

* - indicates frequency in CFR47 Pt 15 / IC RSS-Restricted Band
 PK-U - U-NII: Maximum Peak

BANDEDGE (WORST CASE: 802.11ac VHT80 / 5290 MHz)

HORIZONTAL PEAK AND AVERAGE DATA

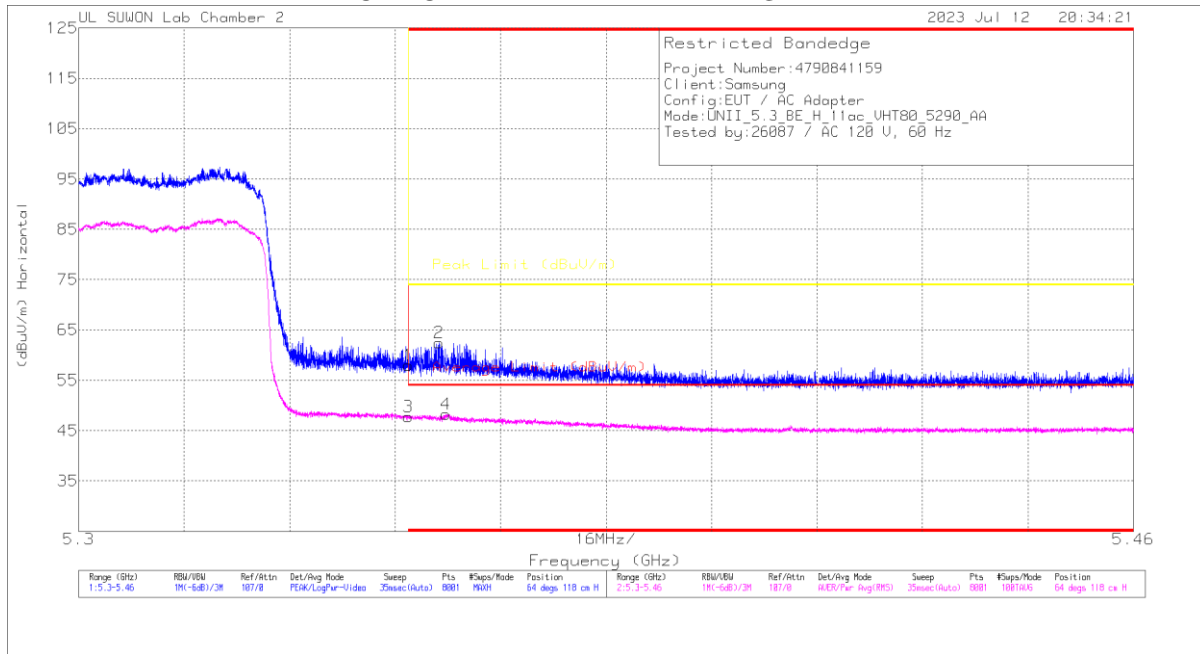

Trace Markers

Marker	Frequency (GHz)	Meter Reading (dBuV)	Det	3117_00168724	10dB_ATT(dB)	DC Corr (dB)	Corrected Reading (dBuV/m)	Average Limit (dBuV/m)	Margin (dB)	Peak Limit (dBuV/m)	PK Margin (dB)	Azimuth (Degs)	Height (cm)	Polarity
1	* 5.35002	40.8	PK	34.4	-17.2	0	58	-	-	74	-16	64	118	H
2	* 5.3547	45.23	PK	34.4	-17.2	0	62.43	-	-	74	-11.57	64	118	H
3	* 5.35002	30.11	RMS	34.4	-17.2	.44	47.75	54	-6.25	-	-	64	118	H
4	* 5.3557	30.64	RMS	34.4	-17.2	.44	48.28	54	-5.72	-	-	64	118	H

* - indicates frequency in CFR47 Pt 15 / IC RSS-Restricted Band
 PK - Peak detector
 RMS - RMS detection

HARMONICS AND SPURIOUS EMISSIONS(WORST CASE: 802.11a / 5260 MHz)
5260 MHz HORIZONTAL

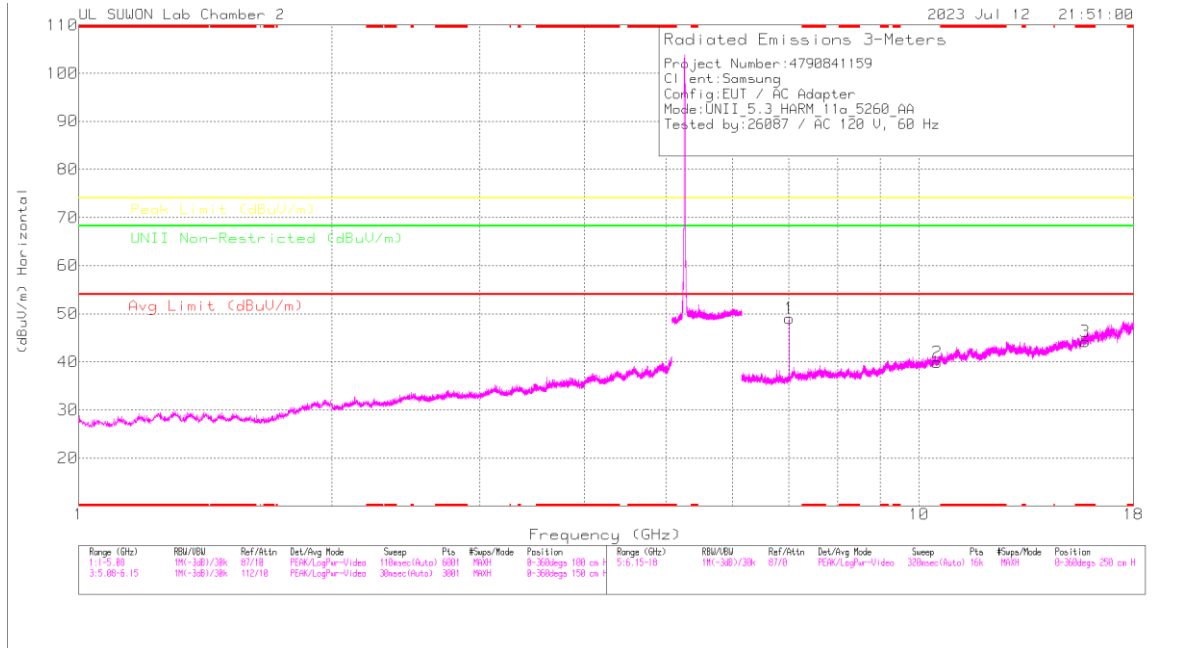

Note: Emission was scanned up to 40GHz; No emissions were detected above the noise floor which was at least 20dB below the specification limit.

Radiated Emissions

Frequency (GHz)	Mixer Reading (dBuV)	Det	3117_00168724	60MHz_HPLM8	DC Corr (dB)	Corrected Reading (dBuV/m)	Avg Limit (dBuV/m)	Margin (dB)	Peak Limit (dBuV/m)	Margin (dB)	UNII Non-Restricted (dBuV/m)	Margin (dB)	Azimuth (Degs)	Height (m)	Polarity
7.01335	43.22	PK-U	35.6	-24.6	0	54.22	-	-	-	-	68.2	-13.98	68	118	H

* - indicates frequency in CFR47 Pt 15 / IC RSS-Restricted Band
 PK-U - U-NII: Maximum Peak

BANDEDGE (WORST CASE: 802.11ac VHT80 / 5530 MHz)

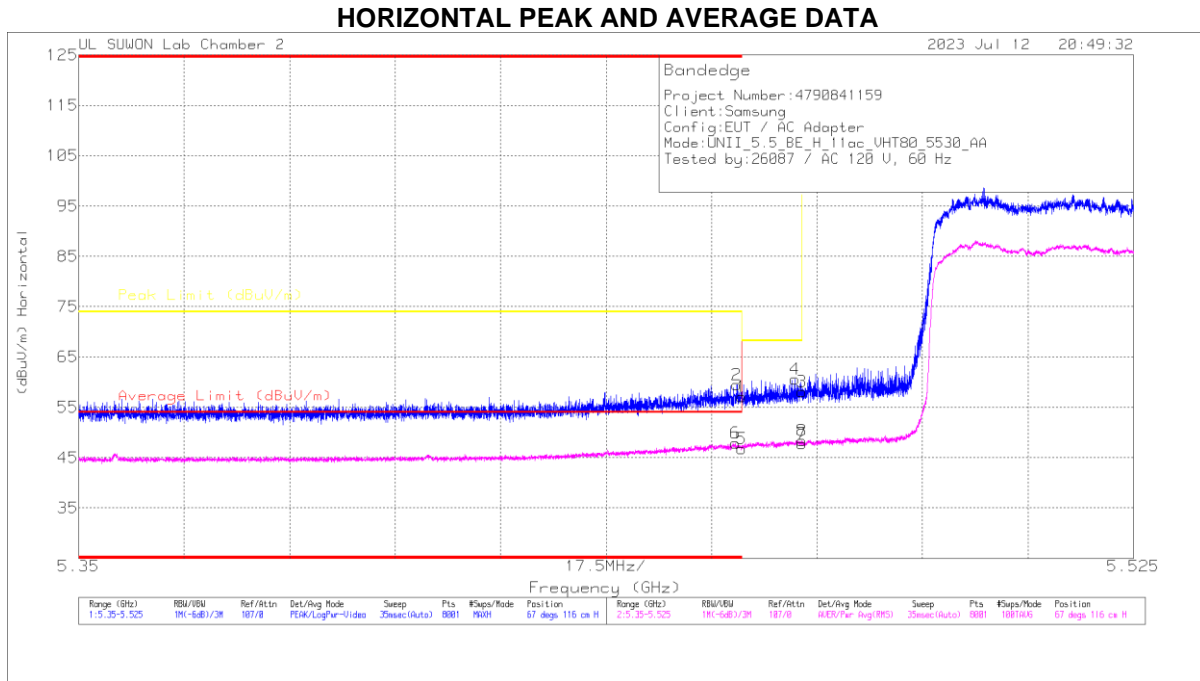

Trace Markers

Marker	Frequency (GHz)	Meter Reading (dBuV)	Det	3117_00168724	10dB_ATT(dB)	DC Corr (dB)	Corrected Reading (dBuV/m)	Average Limit (dBuV/m)	Margin (dB)	Peak Limit (dBuV/m)	PK Margin (dB)	Azimuth (Degs)	Height (cm)	Polarity
1	* 5.45999	39.96	PK	34.4	-17.3	0	57.06	-	-	74	-16.94	67	116	H
2	* 5.45918	42.42	PK	34.4	-17.3	0	59.52	-	-	74	-14.48	67	116	H
3	5.46998	40.86	PK	34.4	-17.2	0	58.06	-	-	68.2	-10.14	67	116	H
4	5.46889	43.42	PK	34.4	-17.2	0	60.62	-	-	68.2	-7.58	67	116	H
5	* 5.45999	29.2	RMS	34.4	-17.3	.44	46.74	54	-7.26	-	-	67	116	H
6	* 5.459	30.31	RMS	34.4	-17.3	.44	47.85	54	-6.15	-	-	67	116	H
7	5.46998	30.1	RMS	34.4	-17.2	.44	47.74	-	-	-	-	67	116	H
8	5.46994	30.8	RMS	34.4	-17.2	.44	48.44	-	-	-	-	67	116	H

* - indicates frequency in CFR47 Pt 15 / IC RSS-Restricted Band
 PK - Peak detector
 RMS - RMS detection

HARMONICS AND SPURIOUS EMISSIONS(WORST CASE: 802.11a / 5580 MHz)
5580 MHz VERTICAL

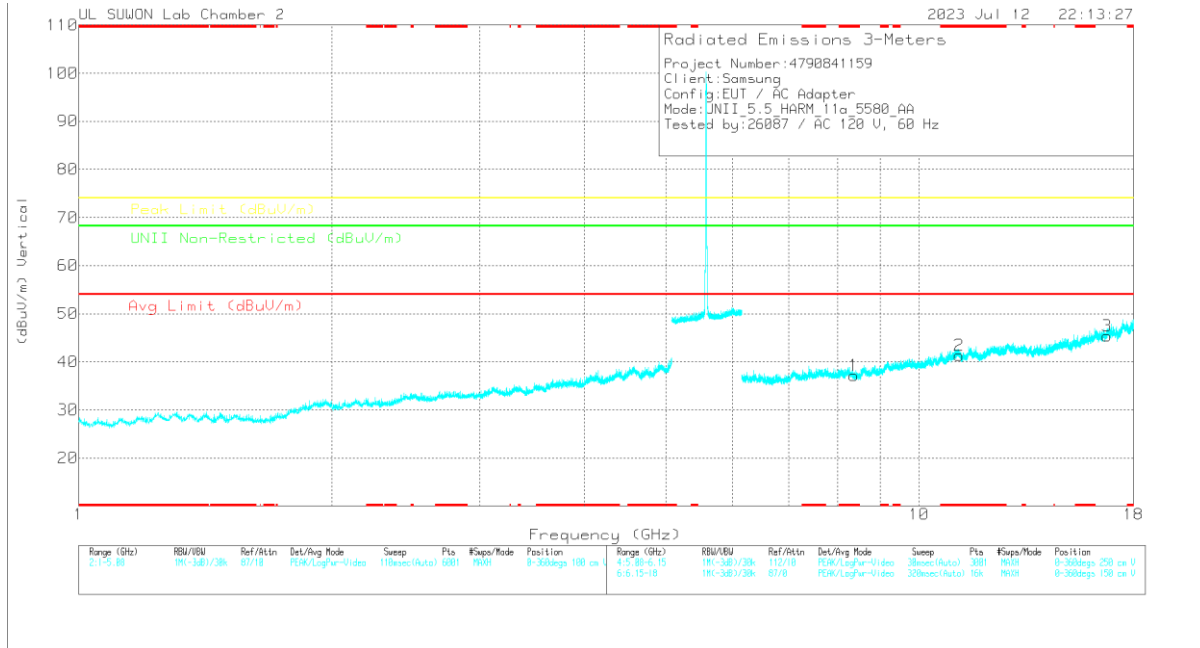

Note: Emission was scanned up to 40GHz; No emissions were detected above the noise floor which was at least 20dB below the specification limit.

Radiated Emissions

Frequency (GHz)	Mean Reading (dBu)	Det	3117_00168724	6GHz_HP(dB)	DC Corr (dB)	Corrected Reading (dBu/m)	Avg Limit (dBu/m)	Margin (dB)	Peak Limit (dBu/m)	Margin (dB)	UNII Non-Restricted (dBu/m)	Margin (dB)	Azimuth (Degs)	Height (cm)	Polarity
16.73928	33.44	PK-U	41.2	-18.3	0	56.34	-	-	-	-	68.2	-11.86	0	100	V

* - indicates frequency in CFR47 Pt 15 / IC RSS-Restricted Band
 PK-U - U-NII: Maximum Peak