





TEST REPORT

<p>Eurofins KCTL Co.,Ltd. 65, Sinwon-ro, Yeongtong-gu, Suwon-si, Gyeonggi-do, 16677, Korea TEL: 82-70-5008-1021 FAX: 82-505-299-8311 www.kctl.co.kr</p>	<p>Report No.: KR23-SRF0268-A Page (1) of (60)</p>	 
--	--	---

1. Client

- Name : Samsung Electronics Co., Ltd.
- Address : 129, Samsung-ro, Yeongtong-gu, Suwon-si, Gyeonggi-do, 16677, Rep. of Korea
- Date of Receipt : 2023-09-05

2. Use of Report : Certification

3. Name of Product / Model : Tablet PC / SM-X308U

4. Manufacturer / Country of Origin : Samsung Electronics Co., Ltd. / Vietnam

5. FCC ID : A3LSMX308U

6. Date of Test : 2023-09-20 to 2023-11-22

7. Location of Test : Permanent Testing Lab On Site Testing
 (Address:65, Sinwon-ro, Yeongtong-gu, Suwon-si, Gyeonggi-do, 16677, Korea)

8. Test method used : FCC Part 2
 FCC Part 96

9. Test Result : Refer to the test result in the test report

Affirmation	Tested by	Technical Manager
	Name : Kwonse Kim (Signature)	Name : Seungyong Kim (Signature)

2023-12-06

Eurofins KCTL Co.,Ltd.

As a test result of the sample which was submitted from the client, this report does not guarantee the whole product quality. This test report should not be used and copied without a written agreement by Eurofins KCTL Co.,Ltd.

REPORT REVISION HISTORY

Date	Revision	Page No
2023-11-27	Originally issued	-
2023-12-06	Added the SRS antenna information	4, 8

This report shall not be reproduced except in full, without the written approval of Eurofins KCTL Co.,Ltd. This document may be altered or revised by Eurofins KCTL Co.,Ltd. personnel only, and shall be noted in the revision section of the document. Any alteration of this document not carried out by Eurofins KCTL Co.,Ltd. will constitute fraud and shall nullify the document. This test report is a general report that does not use the KOLAS accreditation mark and is not related to KS Q ISO/IEC 17025 and KOLAS accreditation.

Note. The report No. KR23-SRF0268 is superseded by the report No. KR23-SRF0268-A.

General remarks for test reports

Statement concerning the uncertainty of the measurement systems used for the tests

(may be required by the product standard or client)

Internal procedure used for type testing through which traceability of the measuring uncertainty has been established:

Procedure number, issue date and title:

Calculations leading to the reported values are on file with the testing laboratory that conducted the testing.

Statement not required by the standard or client used for type testing

CONTENTS

1.	General information	4
2.	Device information	4
2.1.	Frequency/channel operations.....	5
3.	Maximum ERP/EIRP power.....	6
4.	Summary of tests.....	7
4.1.	Worst case orientation	8
5.	Measurement uncertainty	10
6.	Measurement results explanation example	11
7.	Test results	12
7.1.	Conducted output power.....	12
7.2.	99% Occupied Bandwidth & 26 dB Bandwidth.....	23
7.3.	Band Edge Emissions at Antenna Terminal	30
7.4.	Spurious Emissions at Antenna Terminal.....	41
7.5.	Peak to Average Power Ratio (PAPR)	43
7.6.	Frequency stability.....	46
7.7.	Radiated Power (ERP/EIRP)	48
7.8.	Radiated Spurious Emissions.....	53
8.	Measurement equipment	60

1. General information

Client : Samsung Electronics Co., Ltd.
Address : 129, Samsung-ro, Yeongtong-gu, Suwon-si, Gyeonggi-do, 16677, Rep. of Korea
Manufacturer : Samsung Electronics Co., Ltd.
Address : 129, Samsung-ro, Yeongtong-gu, Suwon-si, Gyeonggi-do, 16677, Rep. of Korea
Factory : Samsung Electronics Vietnam Thai Nguyen Co., Ltd
Address : Yen Binh Industrial Park, Dong Tien Ward, Pho Yen Town, Thai Nguyen Province, Vietnam
Laboratory : Eurofins KCTL Co.,Ltd.
Address : 65, Sinwon-ro, Yeongtong-gu, Suwon-si, Gyeonggi-do, 16677, Korea
Accreditations : FCC Site Designation No: KR0040, FCC Site Registration No: 687132
VCCI Registration No. : R-20080, G-20078, C-20059, T-20056
CAB Identifier: KR0040
ISED Number: 8035A
KOLAS No.: KT231

2. Device information

Equipment under test : Tablet PC
Model : SM-X308U
Modulation technique : DFT-s OFDM : PI/2 BPSK, QPSK, 16QAM, 64QAM, 256QAM
CP-OFDM : QPSK, 16QAM, 64QAM, 256QAM
Power source : DC 3.85 V
Antenna specification : Main Antenna 2 : LDS Antenna (NR n48)
Sub Antenna 2 : LDS Antenna (SRS Path3)
Sub Antenna 3 : LDS Antenna (SRS Path2)
Sub Antenna 4 : LDS Antenna (SRS Path1)
Antenna operation : SA/NSA (NR n48)
EN-DC for NSA : 2A-n48, 66A-n48
Frequency range : 5G NR n48 : 3 555.00 MHz ~ 3 694.98 MHz
Bandwidth : 10 MHz, 15 MHz, 20 MHz, 40 MHz
SCS : 30 kHz
Software version : X308U.001
Hardware version : REV1.0
Test device serial No. : Conducted : R32WA0000FY
Radiated : R32W90021BEW, R32W900200M
Operation temperature : 0 °C ~ 35 °C

2.1. Frequency/channel operations

This device contains the following capabilities:

WLAN (11a/b/g/n/ac/ax), Bluetooth (BDR/EDR/BLE), NFC, Digitizer, WCDMA 850/1700/1900,

LTE B2/4/5/7/12/13/14/25/26/30/40/41(PC2/PC3)/48/66/71, ULCA 41C(PC2/PC3)/48C

NR n2/5/12/25/30/41(PC2/PC3)/48/66/71/77(PC2/PC3)/78(PC3), SRS n48/n77(PC2/PC3)/n78(PC3)

5G NR n48

Ch.	Frequency (MHz)
637000	3 555.00
641666	3 624.99
646332	3 694.98

Table 2.1-1. 10M BW

Ch.	Frequency (MHz)
637168	3 557.52
641666	3 624.99
646166	3 692.49

Table 2.1-2. 15M BW

Ch.	Frequency (MHz)
637334	3 560.01
641666	3 624.99
646000	3 690.00

Table 2.1-3. 20M BW

Ch.	Frequency (MHz)
638000	3 570.00
641666	3 624.99
645332	3 679.98

Table 2.1-4. 40M BW



3. Maximum ERP/EIRP power

5G NR n48

Mode	Waveform	Bandwidth (MHz)	Tx frequency (MHz)	Emission designator	EIRP	
					Max. power (dBm)	Max. power (W)
5G NR n48	DFT-s-OFDM	10	3 555.00 ~ 3 694.98	8M69G7D	21.47	0.140
				8M69W7D	20.28	0.107
		15	3 557.52 ~ 3 692.49	13M0G7D	21.34	0.136
				13M0W7D	20.50	0.112
		20	3 624.99 ~ 3 690.00	18M1G7D	20.94	0.124
				18M1W7D	20.00	0.100
		40	3 570.00 ~ 3 679.98	36M3G7D	21.24	0.133
				36M3W7D	20.44	0.111

5G NR n48(SRS1)

Mode	Waveform	Bandwidth (MHz)	Tx frequency (MHz)	EIRP	
				Max. power (dBm)	Max. power (W)
5G NR n48	DFT-s-OFDM	40	3 570.00 ~ 3 679.98	11.08	0.013

5G NR n48(SRS2)

Mode	Waveform	Bandwidth (MHz)	Tx frequency (MHz)	EIRP	
				Max. power (dBm)	Max. power (W)
5G NR n48	DFT-s-OFDM	10	3 555.00 ~ 3 694.98	11.31	0.014

5G NR n48(SRS3)

Mode	Waveform	Bandwidth (MHz)	Tx frequency (MHz)	EIRP	
				Max. power (dBm)	Max. power (W)
5G NR n48	DFT-s-OFDM	40	3 570.00 ~ 3 679.98	14.04	0.025

4. Summary of tests

FCC Part section(s)	Parameter	Test Limit	Test Condition	Test results
2.1046	Conducted Output Power	N/A	Conducted	Pass
2.1049	Occupied Bandwidth & 26 dB Bandwidth	N/A		Pass
2.1051 96.41(e)	Band Edge Emissions at Antenna Terminal	< -13 dBm/MHz at frequencies within 0-B MHz of channel edge < -25 dBm/MHz at frequencies greater than B MHz above and below channel edge		Pass
	Spurious Emissions at Antenna Terminal	< -25 dBm/MHz at frequencies below 3540 MHz and above 3710 MHz < -40 dBm/MHz at frequencies below 3530 MHz and above 3720 MHz		Pass
96.41(e)	Adjacent Channel Leakage Ratio	At least 30 dB		Pass
96.41(g)	Peak to Average Power Ratio	< 13 dB		Pass
2.1055	Frequency stability	Emission must remain in band		Pass
2.1053 96.41(b)	Equivalent Isotropic Radiated Power	23 dBm/10 MHz	Radiated	Pass
2.1053 96.41(e)	Radiated Spurious Emissions	< -40 dBm/MHz at frequencies below 3530 MHz and above 3720 MHz		Pass

Notes:

- The test procedure(s) in this report were performed in accordance as following.
 - ◆ ANSI C63.26-2015
 - ◆ ANSI/TIA-603-E-2016
 - ◆ KDB 971168 D01 v03r01
 - ◆ KDB 971168 D02 v02r02

4.1. Worst case orientation

1. All modes of operation were investigated and the worst case emissions are reported with the EUT positioning, modulations, RB sizes and offsets, and channel bandwidth configurations in the test data.
2. Output power measurements were measured on PI/2 BPSK, QPSK, 16QAM, 64QAM and 256QAM modulation. All tests except for output power were performed with QPSK and 16QAM modulation.
 - Waveform: DFT-s OFDM
 - Modes: NSA/SA [Worst Case: SA]
3. However, the PAPR was evaluated for all waveforms and modulations during pre-test, then all bandwidth was performed for the modulations with the highest result.
 - Worst Modulation: CP-OFDM (QPSK, 256QAM)
4. Additionally, output power and band edge measurement for A-MPR (NS_27) was reported.
5. In the case of radiated spurious emissions, only the worst-case bandwidth results were reported.
6. In case of EN-DC mode, highest EIRP/ERP for stand-alone test case for LTE or 5GNR was configured then the spurious emissions were evaluated for simultaneous transmission.
 - EN-DC modes (Main Ant 1-Main Ant 2): 2A-n48A, 66A-n48A
 - Worst case: 66A-n48A
7. This device supports SRS (sounding reference signal) 1, 2, 3 Mode for n48 band. For each SRS 1, 2 and 3, conducted power and radiated measurement were performed through FTM Mode provided by the client. The worst-case scenario for all measurements is based on the average conducted output power measurement investigation result. SRS 1, 2, 3 the worst-case scenario was radiated tested and reported.
 - SRS Antenna information: SRS 1(Sub4 ANT), SRS 2(Sub3 ANT), SRS 3(Sub2 ANT)
8. EUT was investigated in three orthogonal orientations X, Y and Z. It was determined below as that **X** orientation was worst-case orientation. Therefore, all final radiated testing was performed with the EUT in **X** orientation.
9. All configurations have been performed (Stand-alone, Stand-alone with TA, with accessories).
10. Test Condition
 - The measurement was performed with various configurations then worst results are reported.
 - 1) Radiated measurement

Test Description	Waveform	Modulation	RB size	Test Channel
Equivalent Isotropic Radiated Power	DFT-s OFDM	QPSK, 16QAM	1	Low, Mid, High
Radiated Spurious Emissions		QPSK		

5G NR Band	Bandwidth (MHz)	RB size	RB offset
n48	10, 15, 20, 40	1	0, 1, 19, 22, 26, 36, 53
n48(SRS1)	40	1	53
n48(SRS2)	10	1	22
n48(SRS3)	40	1	1

2) Conducted measurement

Test Description	Waveform	Modulation	RB size	Test Channel
OBW & 26 dB BW	DFT-s OFDM	QPSK, 16QAM	Full	Low, Mid, High
Band Edge		QPSK	1	Low, High
Spurious Emissions			Full	
PAPR	CP OFDM	QPSK, 256QAM	Full	Mid

5G NR Band	Bandwidth (MHz)	RB size	RB offset
n48	10, 15, 20, 40	1	0, 23, 37, 50, 105
		Full	0



5. Measurement uncertainty

The measurement uncertainties shown below were calculated in accordance with the requirements of ANSI C63.4-2014.

All measurement uncertainty values are shown with a coverage factor of $k=2$ to indicated a 95 % level of confidence. The measurement data shown herein meets or exceeds the U_{CISPR} measurement uncertainty values specified in CISPR 16-4-2 and thus, can be compared directly to specified limits to determine compliance.

Parameter	Expanded uncertainty (\pm)	
Conducted RF power	0.9 dB	
Conducted spurious emissions	1.3 dB	
Radiated spurious emissions	Below 1 000 MHz	2.4 dB
	1 000 MHz ~ 18 000 MHz	2.4 dB
	Above 1 8000 MHz	2.6 dB



6. Measurement results explanation example

Frequency (MHz)	Factor(dB)	Frequency (MHz)	Factor(dB)
30	6.10	16 000	10.13
50	6.25	17 000	9.56
100	6.32	18 000	9.97
200	6.33	19 000	9.66
300	6.45	20 000	10.20
400	6.61	21 000	10.56
500	6.99	22 000	9.90
600	7.08	23 000	11.16
700	7.04	24 000	10.48
800	7.03	25 000	11.89
900	6.95	26 000	11.17
1 000	7.01	26 500	11.29
2 000	7.39	27 000	11.37
3 000	7.55	28 000	12.81
4 000	7.94	29 000	13.00
5 000	8.38	30 000	13.30
6 000	8.61	31 000	12.70
7 000	7.88	32 000	12.52
8 000	8.06	33 000	12.63
9 000	8.31	34 000	13.45
10 000	7.98	35 000	13.74
11 000	8.53	36 000	13.78
12 000	8.45	37 000	13.88
13 000	9.45	38 000	14.93
14 000	9.41	39 000	15.79
15 000	9.79	40 000	16.42

Note.

Offset(dB) = RF cable loss(dB) + Divider(dB)

7. Test results

7.1. Conducted output power

Test setup

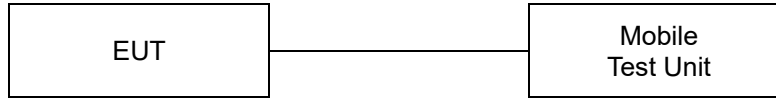

Test procedure

971168 D01 v03r01 – Section 5.2
ANSI C63.26-2015 – Section 5.2.4.2
CFR 47 - Section §2.1046

Test settings

When an average power meter is used to perform RF output power measurements, the fundamental condition that measurement be performed only over durations of active transmissions at maximum output power level applies. Thus, an average power meter can always be used to perform the measurement when the EUT can be configured to transmit continuously.

If the EUT cannot be configured to transmit continuously (i.e., burst duty cycle < 98%), then the following options can be implemented to facilitate measurement of the average power with an average power meter:

- a) A gated average power meter can be used to perform the measurement if the gating parameters can be adjusted such that the power is measured only during active transmission bursts at maximum output power levels.
- b) A conventional average power meter with no signal gating capability can also be used if the measured burst duty cycle is constant (i.e., duty cycle variations are less than or equal to $\pm 2\%$) by performing the measurement over the on/off burst cycles and then correcting (increasing) the measured level by a factor equal to $[10\log(1/\text{duty cycle})]$. See 5.2.4.3.4 for guidance with respect to measuring the transmitter duty cycle.

See item r) of 4.1 for more information regarding power meter functional requirements and limitations, and consult the instrumentation-specific application literature for proper set-up and use.

Test results

Test mode: 5G NR n48 (Maximum Power)

Band	Bandwidth (MHz)	Modulation	Mode	RB Size	RB offset	Maximum Average Power (dBm)		
						637000	641666	646332
						Low	Middle	High
NR n48	10	DFT-s-OFDM	$\pi/2$ BPSK	1	1	22.88	22.62	23.09
				1	12	23.00	22.71	23.25
				1	22	22.86	23.08	22.58
				12	0	22.93	22.76	23.13
				12	6	22.87	22.81	22.79
				12	12	22.84	22.88	22.90
			24	0	22.85	22.76	22.86	
			QPSK	1	1	22.93	22.96	23.10
				1	12	22.95	22.78	23.13
				1	22	22.88	23.08	22.97
				12	0	22.89	22.76	22.85
				12	6	22.93	22.76	22.73
				12	12	22.86	23.03	22.91
			24	0	22.87	22.60	23.03	
		16QAM	1	1	22.97	23.10	23.19	
		64QAM	1	1	21.41	21.14	21.18	
256QAM	1	1	19.37	19.13	19.17			
CP-OFDM	QPSK	1	1	22.39	22.25	22.51		
Band	Bandwidth (MHz)	Modulation	Mode	RB Size	RB offset	Maximum Average Power (dBm)		
						637168	641666	646166
						Low	Middle	High
NR n48	15	DFT-s-OFDM	$\pi/2$ BPSK	1	1	22.89	22.80	22.75
				1	19	22.86	22.85	22.95
				1	36	22.72	22.77	22.61
				18	0	22.88	22.90	22.91
				18	10	22.85	22.68	22.86
				18	20	22.82	22.66	23.04
				36	0	22.83	22.60	22.67
			QPSK	1	1	22.91	22.79	22.70
				1	19	22.85	22.74	23.09
				1	36	22.79	22.73	22.67
				18	0	22.87	23.07	23.05
				18	10	22.86	22.74	23.10
				18	20	22.82	22.55	22.77
				36	0	22.86	23.11	22.68
		16QAM	1	1	22.81	22.93	22.65	
		64QAM	1	1	21.43	21.35	21.55	
256QAM	1	1	19.37	19.46	19.49			
CP-OFDM	QPSK	1	1	22.43	22.22	22.53		

Band	Bandwidth (MHz)	Modulation	Mode	RB Size	RB offset	Maximum Average Power (dBm)		
						637334	641666	646000
						Low	Middle	High
NR n48	20	DFT-s-OFDM	π/2 BPSK	1	1	22.96	22.99	23.19
				1	26	22.87	22.85	22.58
				1	49	22.75	22.95	22.92
				25	0	22.91	22.78	23.16
				25	13	22.90	22.75	22.80
				25	26	22.82	22.59	23.07
				50	0	22.90	22.87	22.82
			QPSK	1	1	22.94	23.06	22.64
				1	26	22.86	23.07	22.76
				1	49	22.69	22.57	22.63
				25	0	22.91	22.61	22.70
				25	13	22.88	23.10	22.70
				25	26	22.75	22.73	22.66
			50	0	22.91	22.84	22.83	
			16QAM	1	1	23.07	22.91	23.18
			64QAM	1	1	21.51	21.41	21.50
			256QAM	1	1	19.34	19.51	19.27
CP-OFDM	QPSK	1	1	22.46	22.65	22.69		
Band	Bandwidth (MHz)	Modulation	Mode	RB Size	RB offset	Maximum Average Power (dBm)		
						638000	641666	645332
						Low	Middle	High
NR n48	40	DFT-s-OFDM	π/2 BPSK	1	1	22.61	22.81	22.54
				1	53	22.73	22.74	23.11
				1	104	22.59	22.60	23.00
				50	0	22.76	22.69	22.73
				50	28	22.67	22.71	22.97
				50	56	22.60	22.69	23.12
				100	0	22.68	22.69	22.95
			QPSK	1	1	22.96	22.76	22.55
				1	53	22.81	22.69	22.98
				1	104	22.56	22.59	22.97
				50	0	22.85	22.77	22.74
				50	28	22.69	22.75	22.99
				50	56	22.58	22.70	23.09
			100	0	22.71	22.71	22.96	
			16QAM	1	1	22.97	22.68	22.75
			64QAM	1	1	21.60	21.30	21.09
			256QAM	1	1	19.27	19.20	19.01
CP-OFDM	QPSK	1	1	22.33	22.30	22.12		

Test mode: 5G NR n48(SRS1)

Band	Bandwidth (MHz)	Modulation	Mode	RB Size	RB offset	Maximum Average Power (dBm)			
						637000	641666	646332	
						Low	Middle	High	
NR n48	10	DFT-s-OFDM	$\pi/2$ BPSK	1	1	11.93	12.35	12.61	
				1	12	11.99	12.36	12.83	
				1	22	12.01	12.10	12.16	
				12	0	11.86	12.30	12.51	
				12	6	11.90	12.25	12.68	
				12	12	11.99	12.21	11.97	
			QPSK	24	0	11.91	12.25	12.68	
				1	1	11.92	12.43	12.58	
				1	12	11.86	12.39	12.68	
				1	22	11.97	12.43	12.17	
				12	0	11.88	12.39	12.55	
				12	6	11.84	12.41	12.71	
			16QAM	12	12	11.94	12.42	11.99	
				24	0	11.86	12.41	12.66	
				1	1	11.95	12.44	12.55	
			CP-OFDM	64QAM	1	1	10.88	11.33	10.51
				256QAM	1	1	8.90	9.34	8.49
				QPSK	1	1	11.93	11.37	11.50
Band	Bandwidth (MHz)	Modulation	Mode	RB Size	RB offset	Maximum Average Power (dBm)			
						637168	641666	646166	
						Low	Middle	High	
NR n48	15	DFT-s-OFDM	$\pi/2$ BPSK	1	1	11.94	12.40	12.59	
				1	19	11.99	12.40	12.78	
				1	36	12.03	12.10	12.20	
				18	0	11.87	12.33	12.53	
				18	10	11.93	12.27	12.71	
				18	20	11.98	12.25	12.04	
			QPSK	36	0	11.85	12.27	12.67	
				1	1	11.95	12.44	12.55	
				1	19	11.83	12.37	12.66	
				1	36	12.03	12.42	12.15	
				18	0	11.95	12.41	12.53	
				18	10	11.89	12.40	12.73	
			16QAM	18	20	11.96	12.43	12.03	
				36	0	11.86	12.42	12.68	
				1	1	11.94	12.39	12.57	
			CP-OFDM	64QAM	1	1	10.84	11.36	10.51
				256QAM	1	1	8.94	9.34	8.51
				QPSK	1	1	11.94	11.37	11.49

Band	Bandwidth (MHz)	Modulation	Mode	RB Size	RB offset	Maximum Average Power (dBm)		
						637334	641666	646000
						Low	Middle	High
NR n48	20	DFT-s-OFDM	π/2 BPSK	1	1	11.97	12.41	12.62
				1	26	11.98	12.40	12.83
				1	49	12.07	12.12	12.19
				25	0	11.94	12.33	12.58
				25	13	11.93	12.28	12.69
				25	26	11.97	12.21	11.98
				50	0	11.87	12.25	12.69
			QPSK	1	1	11.92	12.45	12.62
				1	26	11.84	12.41	12.67
				1	49	12.02	12.38	12.19
				25	0	11.91	12.40	12.55
				25	13	11.86	12.41	12.72
				25	26	11.96	12.40	12.05
				50	0	11.87	12.39	12.65
			16QAM	1	1	11.97	12.46	12.56
			64QAM	1	1	10.91	11.38	10.52
256QAM	1	1	8.95	9.33	8.53			
CP-OFDM	QPSK	1	1	11.89	11.34	11.53		
Band	Bandwidth (MHz)	Modulation	Mode	RB Size	RB offset	Maximum Average Power (dBm)		
						638000	641666	645332
						Low	Middle	High
NR n48	40	DFT-s-OFDM	π/2 BPSK	1	1	12.08	12.50	12.71
				1	53	12.10	12.48	12.92
				1	104	12.14	12.20	12.30
				50	0	12.02	12.42	12.65
				50	28	12.01	12.40	12.83
				50	56	12.08	12.34	12.12
				100	0	12.00	12.37	12.81
			QPSK	1	1	12.05	12.51	12.69
				1	53	11.98	12.37	12.79
				1	104	12.11	12.21	12.30
				50	0	12.03	12.42	12.64
				50	28	12.00	12.40	12.82
				50	56	12.10	12.32	12.12
				100	0	12.01	12.37	12.79
			16QAM	1	1	12.08	12.53	12.70
			64QAM	1	1	10.99	11.45	10.61
256QAM	1	1	9.02	9.44	8.62			
CP-OFDM	QPSK	1	1	12.02	11.48	11.63		

Test mode: 5G NR n48(SRS2)

Band	Bandwidth (MHz)	Modulation	Mode	RB Size	RB offset	Maximum Average Power (dBm)		
						637000	641666	646332
						Low	Middle	High
NR n48	10	DFT-s-OFDM	$\pi/2$ BPSK	1	1	11.41	12.49	12.78
				1	12	11.43	12.60	12.94
				1	22	11.36	12.55	12.98
				12	0	11.35	12.49	12.80
				12	6	11.36	12.51	12.85
				12	12	11.37	12.52	12.92
			24	0	11.35	12.50	12.84	
			QPSK	1	1	11.40	12.50	12.80
				1	12	11.45	12.61	12.95
				1	22	11.40	12.56	12.97
				12	0	11.38	12.51	12.82
				12	6	11.35	12.53	12.87
				12	12	11.38	12.53	12.91
			24	0	11.36	12.51	12.85	
			16QAM	1	1	11.43	12.51	12.78
			64QAM	1	1	10.31	11.00	10.68
			256QAM	1	1	8.32	9.45	8.73
			CP-OFDM	QPSK	1	1	11.34	12.49
Band	Bandwidth (MHz)	Modulation	Mode	RB Size	RB offset	Maximum Average Power (dBm)		
						637168	641666	646166
						Low	Middle	High
NR n48	15	DFT-s-OFDM	$\pi/2$ BPSK	1	1	11.40	12.50	12.50
				1	19	11.38	12.53	12.75
				1	36	11.35	12.52	12.91
				18	0	11.37	12.49	12.58
				18	10	11.34	12.47	12.73
				18	20	11.33	12.51	12.81
			36	0	11.35	12.48	12.71	
			QPSK	1	1	11.39	12.51	12.52
				1	19	11.40	12.52	12.74
				1	36	11.37	12.51	12.90
				18	0	11.35	12.50	12.56
				18	10	11.35	12.48	12.74
				18	20	11.34	12.52	12.81
			36	0	11.36	12.49	12.72	
			16QAM	1	1	11.41	12.49	12.60
			64QAM	1	1	10.29	11.42	11.50
			256QAM	1	1	8.31	9.44	8.53
			CP-OFDM	QPSK	1	1	11.33	12.45

Band	Bandwidth (MHz)	Modulation	Mode	RB Size	RB offset	Maximum Average Power (dBm)		
						637334	641666	646000
						Low	Middle	High
NR n48	20	DFT-s-OFDM	π/2 BPSK	1	1	11.48	12.54	12.38
				1	26	11.47	12.52	12.68
				1	49	11.47	12.57	12.97
				25	0	11.46	12.50	12.46
				25	13	11.44	12.49	12.66
				25	26	11.44	12.50	12.81
			QPSK	50	0	11.46	12.47	12.63
				1	1	11.48	12.55	12.39
				1	26	11.46	12.53	12.69
				1	49	11.45	12.58	12.95
				25	0	11.47	12.51	12.48
				25	13	11.45	12.50	12.65
			16QAM	25	26	11.45	12.49	12.79
				50	0	11.45	12.48	12.64
				1	1	11.49	12.51	12.40
64QAM	1	1	10.38	11.43	11.29			
256QAM	1	1	8.39	9.44	9.31			
CP-OFDM	QPSK	1	1	11.42	11.47	12.35		
Band	Bandwidth (MHz)	Modulation	Mode	RB Size	RB offset	Maximum Average Power (dBm)		
						638000	641666	645332
						Low	Middle	High
NR n48	40	DFT-s-OFDM	π/2 BPSK	1	1	11.67	12.59	12.41
				1	53	11.75	12.64	12.68
				1	104	11.83	12.44	12.16
				50	0	11.63	12.54	12.38
				50	28	11.70	12.53	12.60
				50	56	11.79	12.52	12.94
			QPSK	100	0	11.65	12.54	12.55
				1	1	11.66	12.58	12.41
				1	53	11.76	12.63	12.67
				1	104	11.84	12.46	12.15
				50	0	11.65	12.53	12.39
				50	28	11.72	12.54	12.61
			16QAM	50	56	11.78	12.51	12.92
				100	0	11.64	12.55	12.54
				1	1	11.63	12.59	12.40
			64QAM	1	1	10.53	10.50	11.28
			256QAM	1	1	8.57	8.52	9.29
			CP-OFDM	QPSK	1	1	11.59	11.52

Test mode: 5G NR n48(SRS3)

Band	Bandwidth (MHz)	Modulation	Mode	RB Size	RB offset	Maximum Average Power (dBm)		
						637000	641666	646332
						Low	Middle	High
NR n48	10	DFT-s-OFDM	π/2 BPSK	1	1	16.01	16.55	15.96
				1	12	16.05	16.57	16.19
				1	22	15.97	16.53	16.25
				12	0	15.94	16.50	16.03
				12	6	15.95	16.52	16.11
				12	12	15.88	16.52	16.20
				24	0	15.92	16.50	16.11
			QPSK	1	1	16.02	16.54	15.94
				1	12	15.94	16.55	16.20
				1	22	15.98	16.55	16.24
				12	0	15.92	16.49	16.05
				12	6	15.93	16.53	16.12
				12	12	15.90	16.54	16.23
				24	0	15.91	16.49	16.13
			16QAM	1	1	15.97	16.57	16.03
			64QAM	1	1	14.93	15.00	14.95
			256QAM	1	1	12.92	12.99	12.95
			CP-OFDM	QPSK	1	1	15.96	16.50
Band	Bandwidth (MHz)	Modulation	Mode	RB Size	RB offset	Maximum Average Power (dBm)		
						637168	641666	646166
						Low	Middle	High
NR n48	15	DFT-s-OFDM	π/2 BPSK	1	1	15.97	16.57	15.99
				1	19	16.01	16.61	16.21
				1	36	15.95	16.55	16.28
				18	0	15.95	16.53	16.06
				18	10	15.94	16.54	16.13
				18	20	15.90	16.55	16.21
				36	0	15.93	16.53	16.13
			QPSK	1	1	15.98	16.55	16.01
				1	19	16.00	16.60	16.19
				1	36	15.97	16.53	16.30
				18	0	15.96	16.51	16.07
				18	10	15.93	16.53	16.14
				18	20	15.93	16.57	16.23
				36	0	15.92	16.52	16.15
			16QAM	1	1	16.00	16.58	16.01
			64QAM	1	1	14.92	14.99	14.90
			256QAM	1	1	12.90	12.99	12.92
			CP-OFDM	QPSK	1	1	15.48	16.04

Band	Bandwidth (MHz)	Modulation	Mode	RB Size	RB offset	Maximum Average Power (dBm)		
						637334	641666	646000
						Low	Middle	High
NR n48	20	DFT-s-OFDM	π/2 BPSK	1	1	15.99	16.58	15.86
				1	26	15.92	16.51	16.09
				1	49	15.91	16.49	16.26
				25	0	15.94	16.53	15.94
				25	13	15.92	16.53	16.09
				25	26	15.91	16.52	16.16
				50	0	15.90	16.50	16.07
			QPSK	1	1	15.99	16.54	15.86
				1	26	15.91	16.52	16.10
				1	49	15.90	16.51	16.24
				25	0	15.96	16.51	15.93
				25	13	15.90	16.54	16.10
				25	26	15.91	16.53	16.15
			16QAM	50	0	15.89	16.52	16.09
				1	1	15.98	16.55	15.84
				1	1	14.90	14.98	14.78
64QAM	1	1	12.86	13.00	12.77			
	1	1	15.90	16.04	15.80			
256QAM	1	1	15.90	16.04	15.80			
	1	1	15.90	16.04	15.80			
CP-OFDM	QPSK	1	1	15.90	16.04	15.80		
		1	1	15.90	16.04	15.80		
Band	Bandwidth (MHz)	Modulation	Mode	RB Size	RB offset	Maximum Average Power (dBm)		
						638000	641666	645332
						Low	Middle	High
NR n48	40	DFT-s-OFDM	π/2 BPSK	1	1	15.90	16.63	15.86
				1	53	15.84	16.49	15.93
				1	104	16.01	16.34	16.38
				50	0	15.87	16.57	15.80
				50	28	15.85	16.54	15.94
				50	56	15.97	16.46	16.25
				100	0	15.89	16.50	15.93
			QPSK	1	1	15.89	16.63	15.86
				1	53	15.86	16.50	15.95
				1	104	16.00	16.32	16.41
				50	0	15.89	16.55	15.81
				50	28	15.87	16.53	15.96
				50	56	15.99	16.44	16.24
			16QAM	100	0	15.88	16.51	15.95
				1	1	15.91	16.60	15.85
				1	1	14.82	15.13	14.78
			64QAM	1	1	12.81	13.13	12.79
				1	1	15.86	16.08	15.81
			256QAM	1	1	15.86	16.08	15.81
				1	1	15.86	16.08	15.81
CP-OFDM	QPSK	1	1	15.86	16.08	15.81		
		1	1	15.86	16.08	15.81		

Test mode: 5G NR n48 (A-MPR)

Band	Bandwidth (MHz)	Modulation	Mode	RB Size	RB offset	Maximum Average Power (dBm)		
						637000	641666	646332
						Low	Middle	High
NR n48	10	DFT-s-OFDM	$\pi/2$ BPSK	1	1	22.18	22.77	23.38
				1	12	22.20	22.85	23.37
				1	22	22.14	22.90	23.38
				12	0	22.01	22.67	23.37
				12	6	22.14	22.82	23.36
				12	12	22.04	22.76	23.26
				24	0	22.00	22.70	23.27
			QPSK	1	1	22.16	22.62	23.37
				1	12	22.33	22.92	23.37
				1	22	22.17	22.82	23.33
				12	0	21.56	22.14	23.20
				12	6	22.24	22.80	23.32
				12	12	21.33	22.22	23.17
		16QAM	1	1	20.29	22.07	22.97	
1	1		20.27	20.73	21.49			
1	1		18.07	18.56	19.44			
CP-OFDM	QPSK	1	1	21.07	21.34	22.51		
Band	Bandwidth (MHz)	Modulation	Mode	RB Size	RB offset	Maximum Average Power (dBm)		
						637168	641666	646166
						Low	Middle	High
NR n48	15	DFT-s-OFDM	$\pi/2$ BPSK	1	1	18.56	22.70	23.36
				1	19	22.18	22.82	23.37
				1	36	22.23	22.90	19.82
				18	0	18.53	22.32	23.40
				18	10	22.12	22.81	23.38
				18	20	22.11	22.72	23.32
				36	0	18.54	22.71	19.97
				QPSK	1	1	18.65	22.07
			1		19	22.31	22.91	23.41
			1		36	22.25	22.83	23.35
			18		0	18.70	22.17	23.28
			18		10	22.27	22.80	23.43
			18		20	21.71	22.22	23.10
			16QAM	36	0	18.68	22.17	20.17
				1	1	17.56	22.09	22.95
				1	1	17.33	20.32	21.45
			256QAM	1	1	17.97	18.32	19.62
			CP-OFDM	QPSK	1	1	16.42	21.62

Band	Bandwidth (MHz)	Modulation	Mode	RB Size	RB offset	Maximum Average Power (dBm)		
						637334	641666	646000
						Low	Middle	High
NR n48	20	DFT-s-OFDM	π/2 BPSK	1	1	18.52	22.69	23.40
				1	26	22.16	22.77	23.37
				1	49	22.19	22.90	19.82
				25	0	18.61	22.61	23.45
				25	13	22.20	22.78	23.38
				25	26	22.18	22.81	23.37
				50	0	18.54	22.71	19.95
			QPSK	1	1	18.77	22.64	23.37
				1	26	22.32	22.72	23.38
				1	49	22.33	22.90	20.01
				25	0	18.75	22.09	23.11
				25	13	22.36	22.78	23.41
				25	26	21.75	22.27	23.09
				50	0	16.72	22.19	20.19
			16QAM	1	1	17.61	22.17	22.81
			64QAM	1	1	17.51	20.54	21.35
			256QAM	1	1	18.00	18.41	19.45
CP-OFDM	QPSK	1	1	16.62	21.51	22.42		
Band	Bandwidth (MHz)	Modulation	Mode	RB Size	RB offset	Maximum Average Power (dBm)		
						638000	641666	645332
						Low	Middle	High
NR n48	40	DFT-s-OFDM	π/2 BPSK	1	1	12.12	18.82	12.77
				1	53	22.40	22.84	23.17
				1	104	12.27	19.33	13.12
				50	0	12.15	22.55	17.46
				50	28	12.26	22.81	13.29
				50	56	16.82	22.80	13.41
				100	0	12.22	18.63	13.26
			QPSK	1	1	12.13	18.92	12.97
				1	53	22.46	22.87	23.23
				1	104	12.35	19.42	13.51
				50	0	12.19	21.99	17.65
				50	28	12.26	22.78	13.53
				50	56	16.84	22.29	13.66
				100	0	12.29	18.66	13.49
			16QAM	1	1	11.66	19.07	12.22
			64QAM	1	1	11.52	18.99	12.43
			256QAM	1	1	11.44	18.14	12.37
CP-OFDM	QPSK	1	1	11.04	18.85	11.85		

7.2. 99% Occupied Bandwidth & 26 dB Bandwidth

Test setup

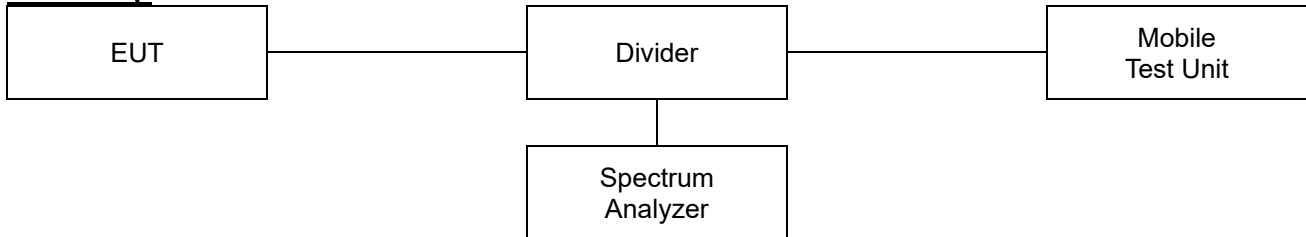

Limit

The occupied bandwidth, that is the frequency bandwidth such that, below its lower and above its upper frequency limits, the mean powers radiated are each equal to 0.5 percent of the total mean power radiated by a given emission shall be measured.

Test procedure

971168 D01 v03r01 – Section 4.2 and 4.3
ANSI C63.26-2015 – Section 5.4.3 and 5.4.4

Test settings

◆ 26dB Bandwidth

- The spectrum analyzer center frequency is set to the nominal EUT channel center frequency. The span range for the spectrum analyzer shall be wide enough to see sufficient roll off of the signal to make the measurement.
- The nominal RBW shall be in the range of 1% to 5% of the anticipated OBW, and the VBW shall be set $\geq 3 \times$ RBW.
- Set the reference level of the instrument as required to prevent the signal amplitude from exceeding the maximum spectrum analyzer input mixer level for linear operation. See guidance provided in 4.2.3.
- The dynamic range of the spectrum analyzer at the selected RBW shall be more than 10 dB below the target “-X dB” requirement, i.e., if the requirement calls for measuring the -26 dB OBW, the spectrum analyzer noise floor at the selected RBW shall be at least 36 dB below the reference level.
- Set spectrum analyzer detection mode to peak, and the trace mode to max hold.
- Determine the reference value by either of the following:
 - Set the EUT to transmit a modulated signal. Allow the trace to stabilize. Set the spectrum analyzer marker to the highest level of the displayed trace (this is the reference value).
 - Set the EUT to transmit an unmodulated carrier. Set the spectrum analyzer marker to the level of the carrier.
- Determine the “-X dB amplitude” as equal to (Reference Value - X). Alternatively, this calculation can be performed on the spectrum analyzer using the delta-marker measurement function.
- If the reference value was determined using an unmodulated carrier, turn the EUT modulation on, then either clear the existing trace or start a new trace on the spectrum analyzer and allow the new trace to stabilize. Otherwise the trace from step f) shall be used for step i).

<p>Eurofins KCTL Co.,Ltd. 65, Sinwon-ro, Yeongtong-gu, Suwon-si, Gyeonggi-do, 16677, Korea TEL: 82-70-5008-1021 FAX: 82-505-299-8311 www.kctl.co.kr</p>	<p>Report No.: KR23-SRF0268-A Page (24) of (60)</p>	
--	---	---

- i) Place two markers, one at the lowest and the other at the highest frequency of the envelope of the spectral display such that each marker is at or slightly below the “-X dB amplitude” determined in step f). If a marker is below this “-X dB amplitude” value it should be as close as possible to this value. The OBW is the positive frequency difference between the two markers.
- j) The spectral envelope can cross the “-X dB amplitude” at multiple points. The lowest or highest frequency shall be selected as the frequencies that are the farthest away from the center frequency at which the spectral envelope crosses the “-X dB amplitude.”
- k) The OBW shall be reported by providing plot(s) of the measuring instrument display, to include markers depicting the relevant frequency and amplitude information (e.g., marker table). The frequency and amplitude axis and scale shall be clearly labeled. Tabular data may be reported in addition to the plot(s).

◆ 99% Occupied Bandwidth

- a) The spectrum analyzer center frequency is set to the nominal EUT channel center frequency. The frequency span for the spectrum analyzer shall be set wide enough to capture all modulation products including the emission skirts (typically a span of $1.5 \times \text{OBW}$ is sufficient).
- b) The nominal IF filter 3 dB bandwidth (RBW) shall be in the range of 1% to 5% of the anticipated OBW, and the VBW shall be set $\geq 3 \times \text{RBW}$.
- c) Set the reference level of the instrument as required to prevent the signal amplitude from exceeding the maximum spectrum analyzer input mixer level for linear operation. See guidance provided in 4.2.3.
- d) Set the detection mode to peak, and the trace mode to max-hold.
- e) If the instrument does not have a 99% OBW function, recover the trace data points and sum directly in linear power terms. Place the recovered amplitude data points, beginning at the lowest frequency, in a running sum until 0.5% of the total is reached. Record that frequency as the lower OBW frequency. Repeat the process until 99.5% of the total is reached and record that frequency as the upper OBW frequency. The 99% power OBW can be determined by computing the difference these two frequencies.
- f) The OBW shall be reported and plot(s) of the measuring instrument display shall be provided with the test report. The frequency and amplitude axis and scale shall be clearly labeled. Tabular data can be reported in addition to the plot(s).

Notes:

1. The EUT was setup to maximum output power with all bandwidth and modulation.

Test results

Test mode: 5G NR n48 DFT-s-OFDM

Test Band	Bandwidth (MHz)	Frequency (MHz)	Test mode	26dB bandwidth (MHz)	99 % bandwidth (MHz)
5G NR n48	10	3555.00	QPSK	10.26	8.67
			16QAM	10.26	8.69
		3624.99	QPSK	10.39	8.69
			16QAM	10.49	8.64
		3694.98	QPSK	10.16	8.64
			16QAM	10.49	8.67
	15	3557.52	QPSK	14.80	12.96
			16QAM	15.02	13.00
		3624.99	QPSK	14.84	12.96
			16QAM	14.91	13.00
		3692.49	QPSK	14.99	13.00
			16QAM	14.76	13.04
	20	3560.01	QPSK	20.18	18.08
			16QAM	20.33	18.08
		3624.99	QPSK	20.33	18.08
			16QAM	20.13	18.08
		3690.00	QPSK	20.28	18.08
			16QAM	20.03	18.13
	40	3570.00	QPSK	39.16	36.06
			16QAM	39.46	36.06
		3624.99	QPSK	39.46	36.26
			16QAM	39.26	36.06
		3679.98	QPSK	39.36	36.16
			16QAM	39.26	36.26

26 dB Bandwidth

Test mode: 5G NR n48 DFT-s-OFDM

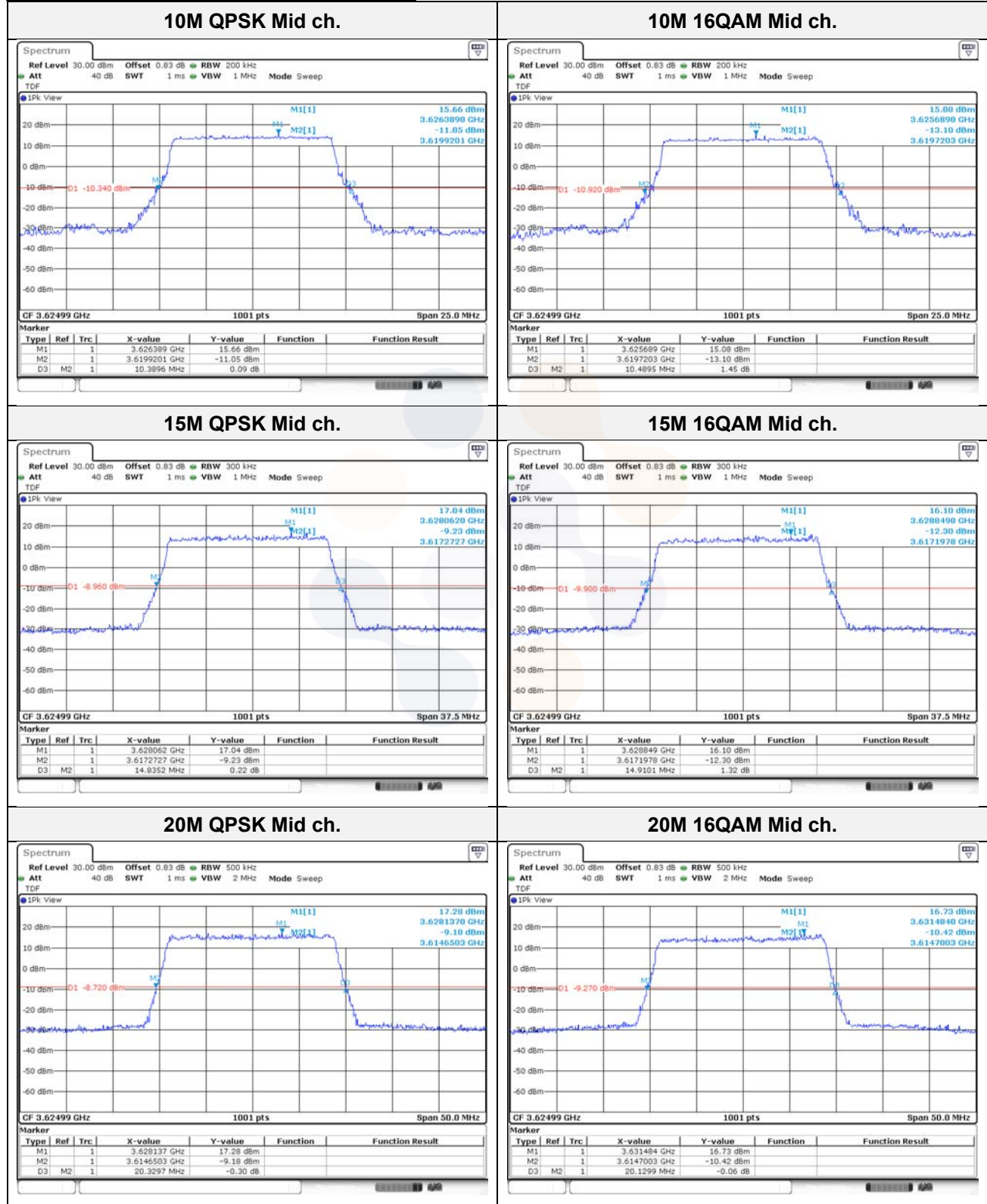

40M QPSK Mid ch.

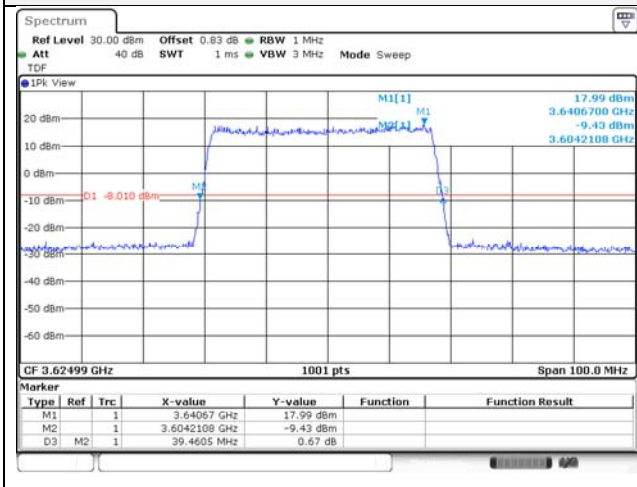

40M 16QAM Mid ch.

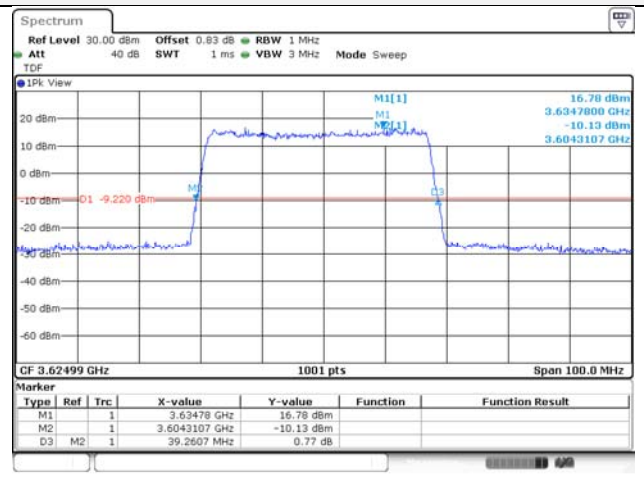

99% Occupied Bandwidth

Test mode: 5G NR n48 DFT-s-OFDM

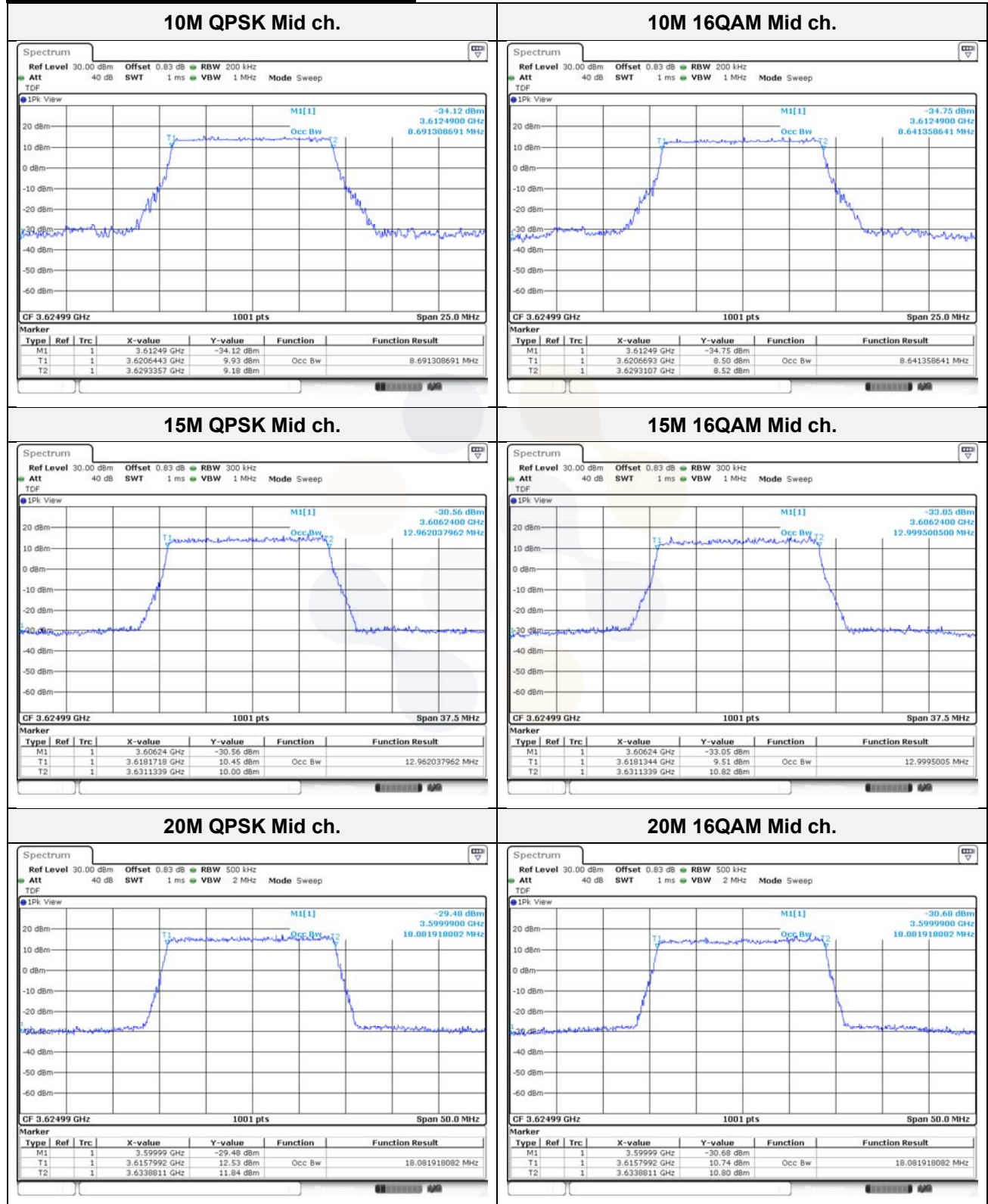

40M QPSK Mid ch.

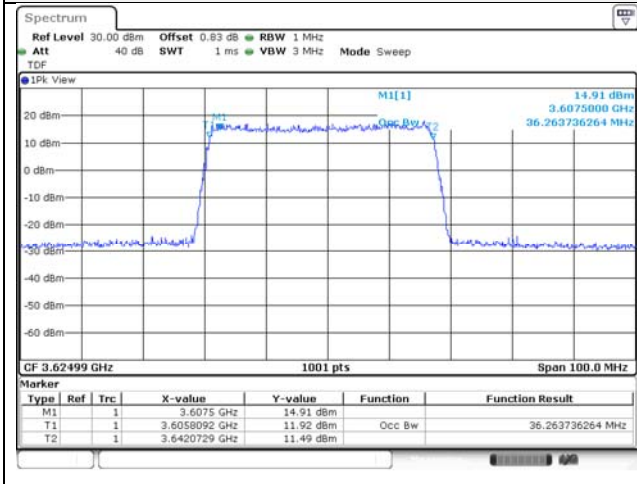

40M 16QAM Mid ch.

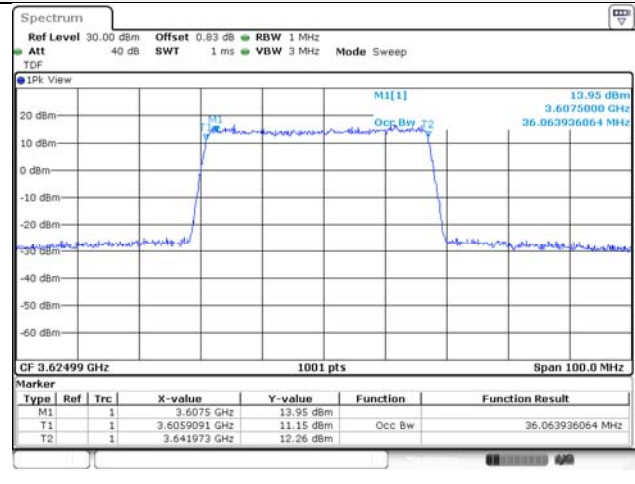

7.3. Band Edge Emissions at Antenna Terminal

Test setup

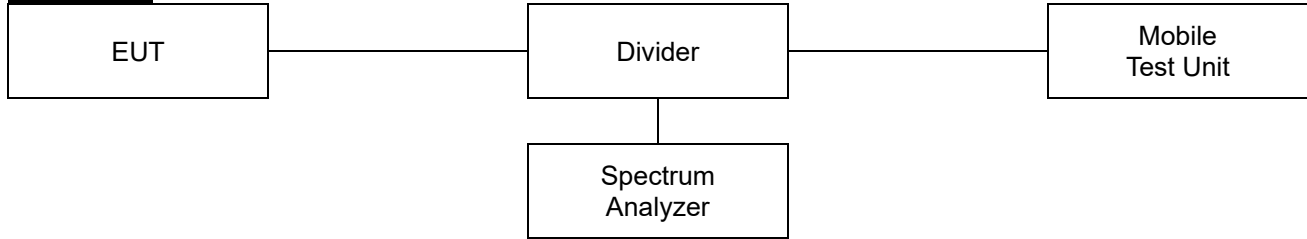

Limit

According to §96.41(e) 3.5 GHz Emissions and Interference Limits

(1) General protection levels

(ii) Except as otherwise specified in paragraph (e)(2) of this section, for channel and frequency assignments made by a CBSD to End User Devices, the conducted power of any End User Device emission outside the fundamental emission (whether in or outside of the authorized band) shall not exceed -13 dBm/MHz within 0 to B megahertz (where B is the bandwidth in megahertz of the assigned channel or multiple contiguous channels of the End User Device) above the upper CBSD-assigned channel edge and within 0 to B megahertz below the lower CBSD-assigned channel edge. At all frequencies greater than B megahertz above the upper CBSD assigned channel edge and less than B megahertz below the lower CBSD-assigned channel edge, the conducted power of any End User Device emission shall not exceed -25 dBm/MHz. Notwithstanding the emission limits in this paragraph, the Adjacent Channel Leakage Ratio for End User Devices shall be at least 30 dB.

(2) Additional protection levels. Notwithstanding paragraph (e)(1) of this section, for CBSDs and End User Devices, the conducted power of emissions below 3540 MHz or above 3710 MHz shall not exceed -25 dBm/MHz, and the conducted power of emissions below 3530 MHz or above 3720 MHz shall not exceed -40 dBm/MHz.

Test procedure

971168 D01 v03r01 - Section 6

ANSI C63.26-2015 – Section 5.7

Test settings

- 1) Start frequency was set to 30 MHz and stop frequency was set to at least 10^{th} the fundamental frequency.
- 2) Span was set large enough so as to capture all out of band emissions near the band edge.
- 3) Set the RBW $> 1\%$ of the emission bandwidth.
- 4) Set the VBW $\geq 3 \times$ RBW.
- 5) Set the number of sweep points $\geq 2 \times$ Span/RBW
- 6) Detector = RMS
- 7) Trace mode = trace average
- 8) Sweep time should be auto for peak detection. For RMS detection the sweep time should be set as follows:
 - a) If the device can be configured to transmit continuously (duty cycle $\geq 98\%$), set the (sweep time) $>$ (number of points in sweep) \times (symbol period) (e.g., by a factor of $10 \times$ symbol period \times number of points) Increasing the sweep time (i.e., slowing the sweep speed) will allow for averaging over multiple symbols.
 - b) If the device cannot transmit continuously (duty cycle $< 98\%$), a gated sweep

- shall be used when possible (i.e., gate triggered such that the analyzer only sweeps when the device is transmitting at full power), set the sweep time $>$ (number of points in sweep) \times (symbol period) but the sweep time shall always be maintained at a value that is less than or equal to the minimum transmission time
- c) If the device cannot be configured to transmit continuously (duty cycle $>$ 98%), and a free-running sweep must be used, set the sweep time so that the averaging is performed over multiple on/off cycles by setting the sweep time $>$ (number of points in sweep) \times (transmitter period) (i.e., the transmit on-time + the off-time). The spectrum analyzer readings shall subsequently be corrected by $[10 \log (1/\text{duty cycle})]$. This assumes that the transmission period and duty cycle is relatively constant (duty cycle variation $\leq \pm 2\%$).
- d) If the device cannot be configured to transmit continuously and a free-running sweep must be used, and if the transmissions exhibit a non-constant duty cycle (duty cycle variations $>$ $\pm 2\%$), set the sweep time so that the averaging is performed over the on-period by setting the sweep time $>$ (symbol period) \times (number of points), while also maintaining the sweep time $<$ (transmitter on-time). The trace mode shall be set to max hold, since not every display point will be averaged only over just the on-time. Thus, multiple sweeps (e.g., 100) in maximum hold are necessary to ensure that the maximum power is measured.
- 9) Allow trace to fully stabilize.

Notes:

1. compliance with these rules is based on the use of measurement instrumentation employing a resolution bandwidth of 1 MHz or greater. however in the 1 MHz bands immediately outside and adjacent to the frequency block a resolution bandwidth of at least one percent of the emission bandwidth of the fundamental emission of the transmitter may be employed. The emission bandwidth is defined as the width of the signal between two points, one below the carrier center frequency and one above the carrier center frequency, outside of which all emissions are attenuated at least 26 dB below the transmitter power.
2. The EUT was setup to maximum output power as its lowest and highest channel with all bandwidth, modulation and RB configurations.
3. 5G NR n48 A-MPR (NS_27) is implemented in this EUT per the A-MPR specification in 3GPP TS 38.101 (Table 6.5.2.3.8-1). Conducted output power verification data are shown in this test report. And also only emission mask test item were performed under A-MPR condition.
4. Duty cycle factor

Period (ms)	On time (ms)	Duty cycle		Duty Cycle Factor (dB)
		(Linear)	(%)	
5.001 563	0.999 375	0.199 8	19.98	6.99

- 1) Duty cycle (Linear) = Ton time / Period
- 2) DCF(Duty cycle factor) = $10\log(1/\text{duty cycle})$
- 3) Offset(dB) = RF cable loss(dB) + Divider(dB) + Duty Cycle Factor(dB)

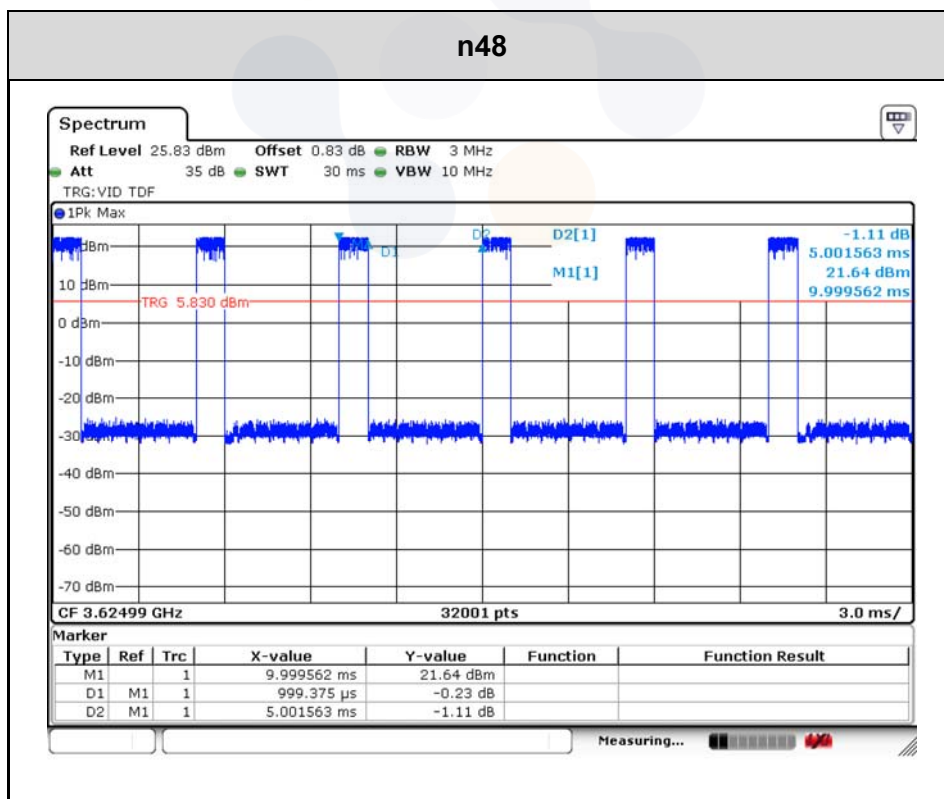

Test results

EMISSION MASK

Test mode: 5G NR n48 DFT-s-OFDM

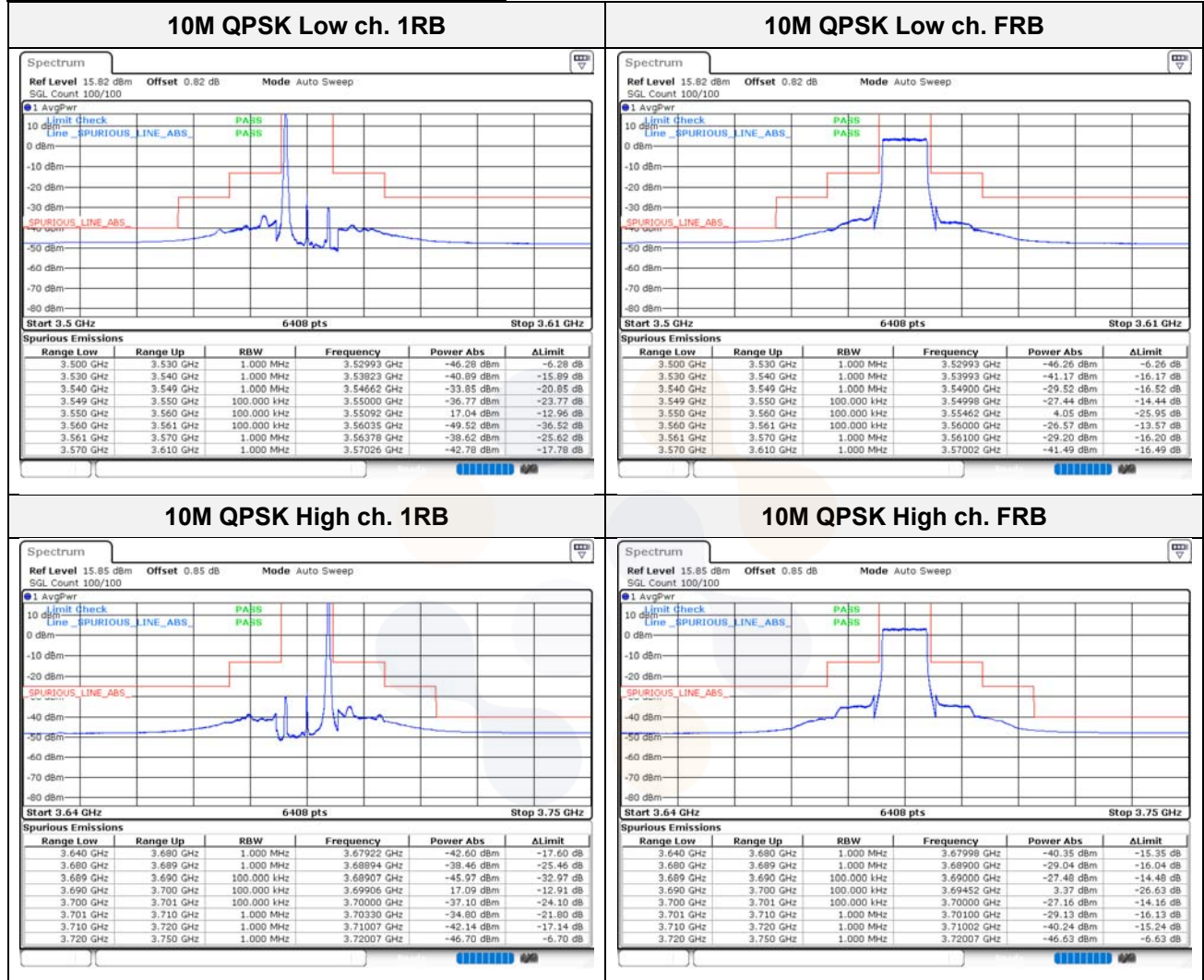

15M QPSK Low ch. 1RB

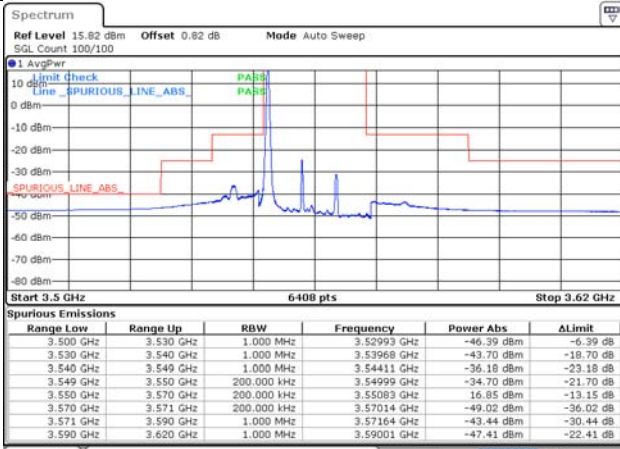

15M QPSK Low ch. FRB

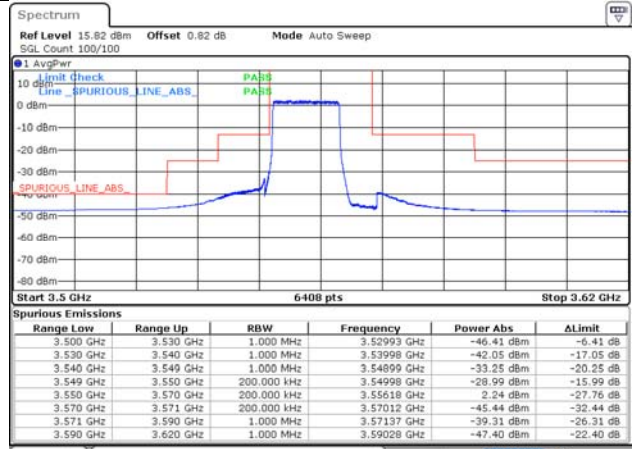

15M QPSK High ch. 1RB

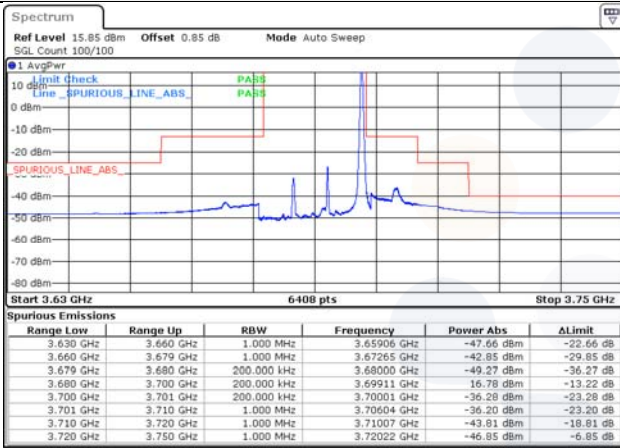

15M QPSK High ch. FRB

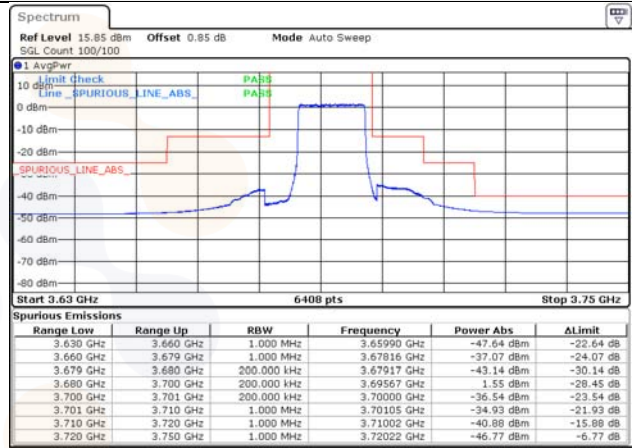

20M QPSK Low ch. 1RB

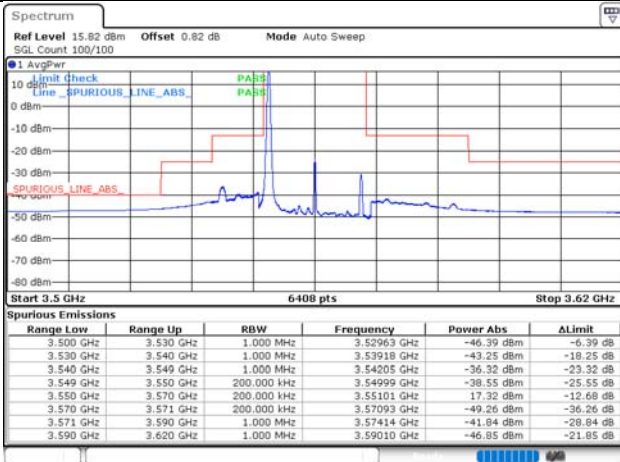

20M QPSK Low ch. FRB

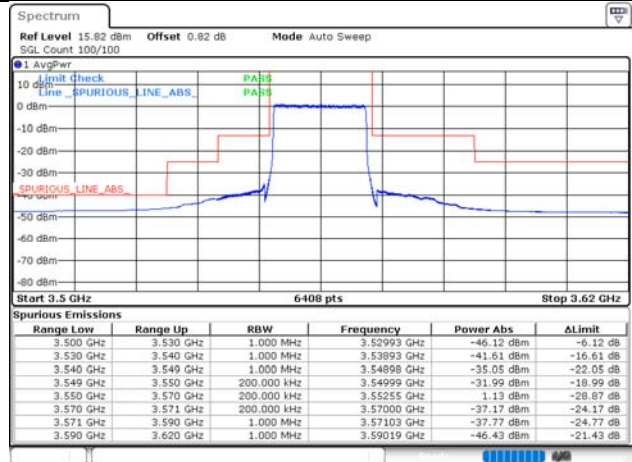

20M QPSK High ch. 1RB

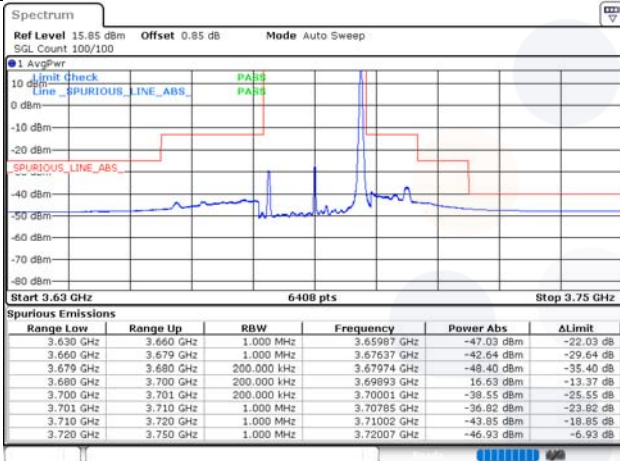

20M QPSK High ch. FRB

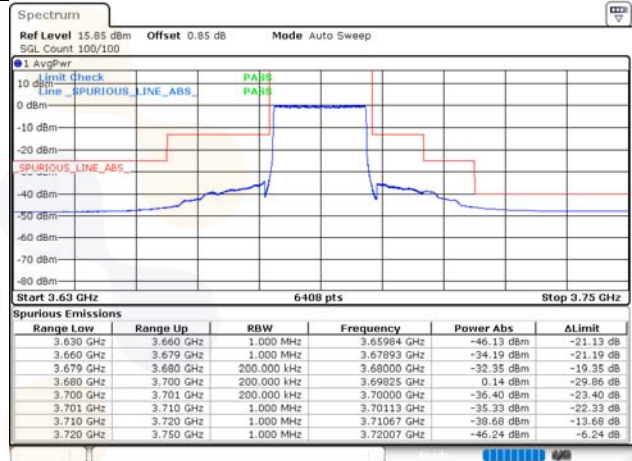

40M QPSK Low ch. 1RB

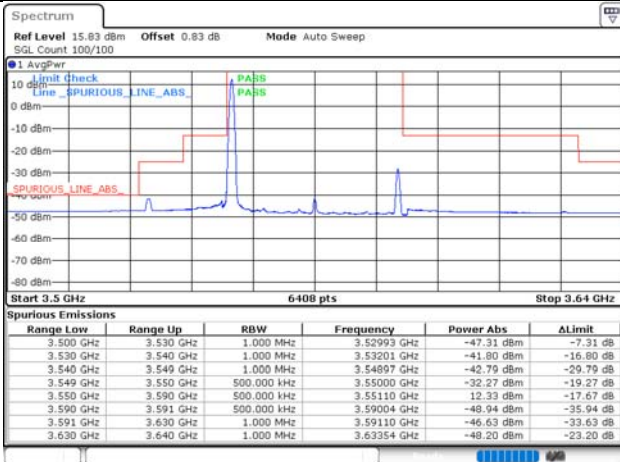

40M QPSK Low ch. FRB

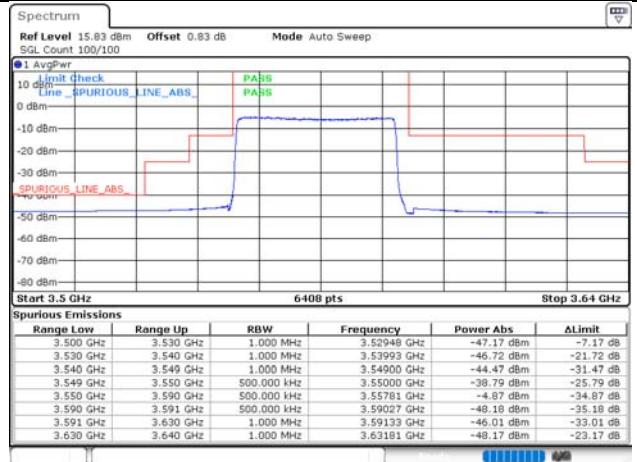

40M QPSK High ch. 1RB

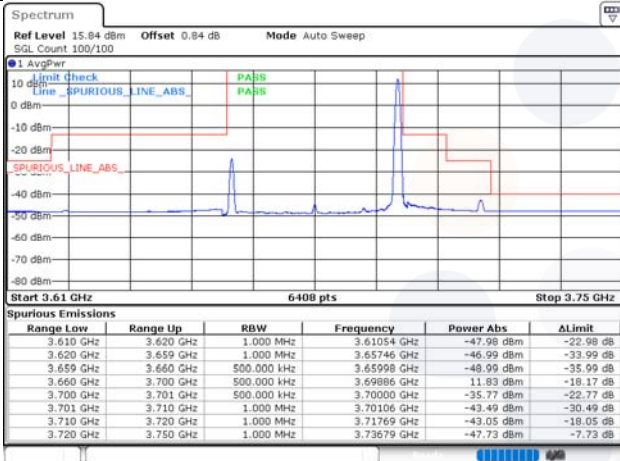

40M QPSK High ch. FRB

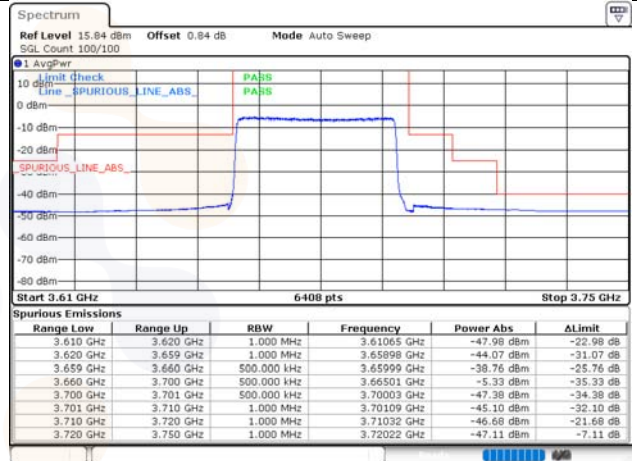

ADJACENT CHANNEL POWER

Test mode: 5G NR n48 DFT-s-OFDM

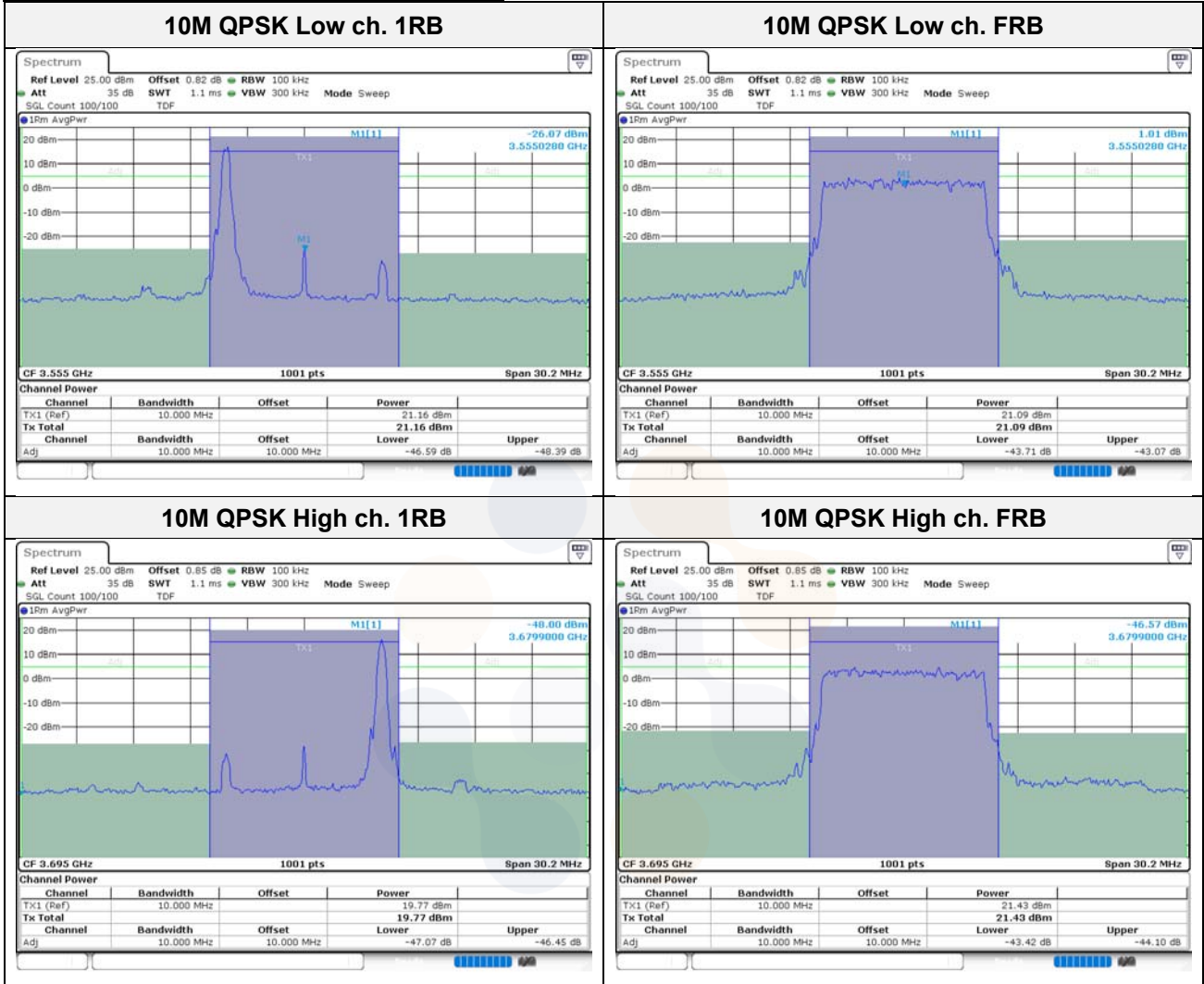

15M QPSK Low ch. 1RB

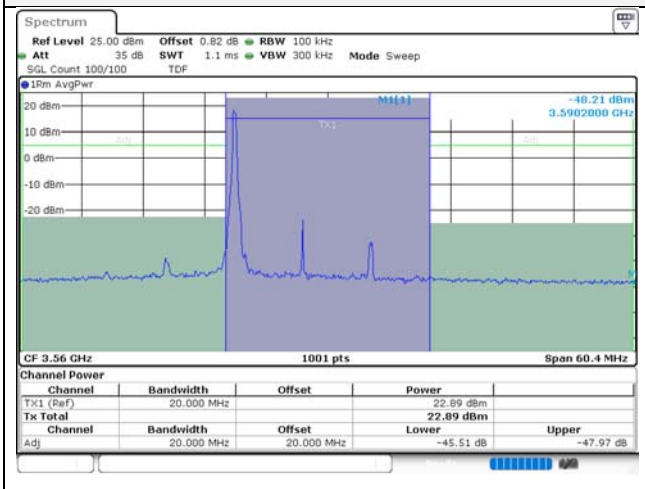

15M QPSK Low ch. FRB

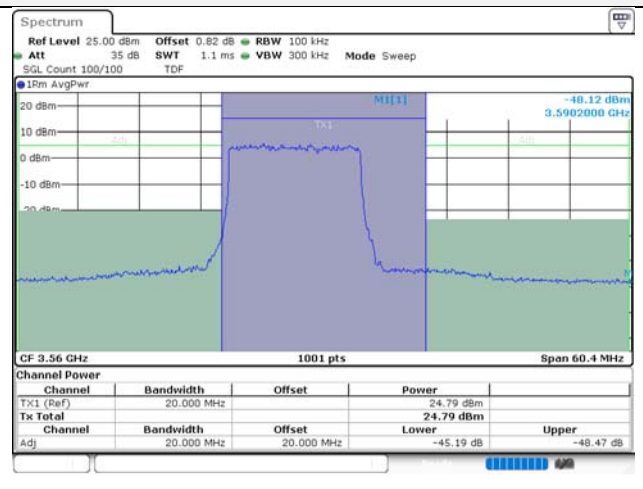

15M QPSK High ch. 1RB

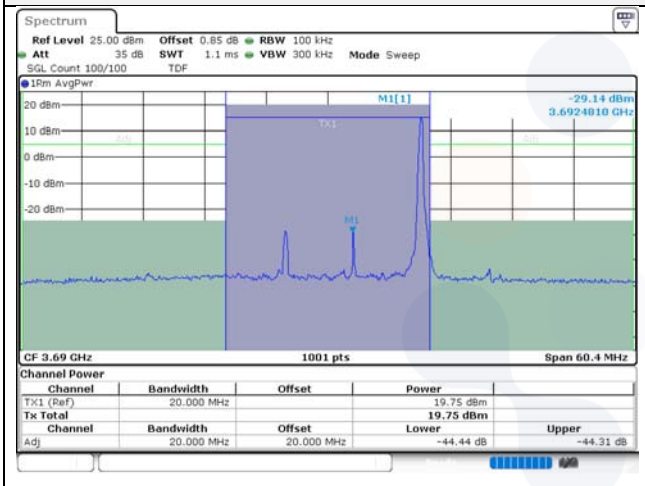

15M QPSK High ch. FRB

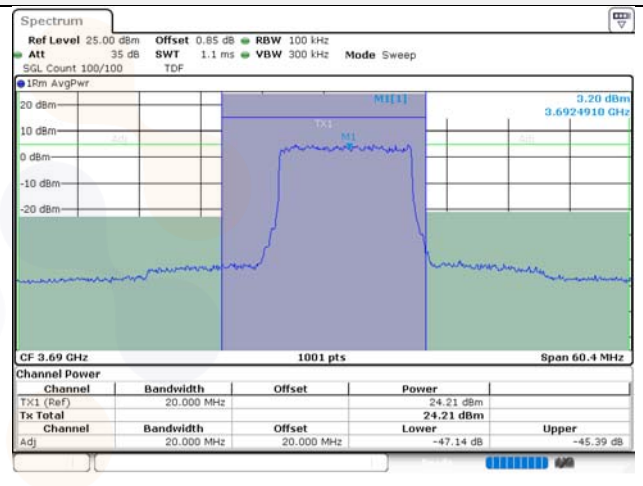

20M QPSK Low ch. 1RB

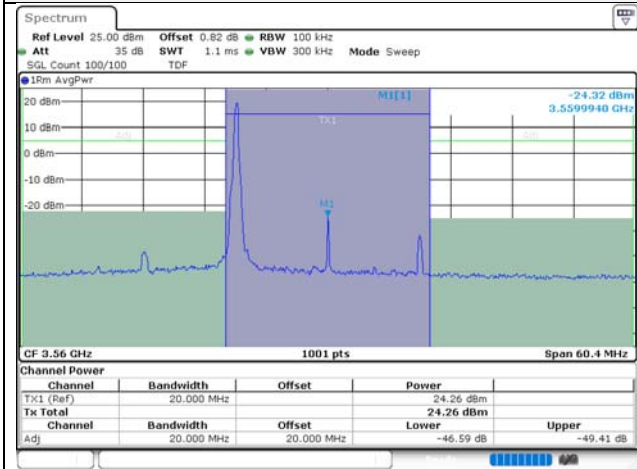

20M QPSK Low ch. FRB

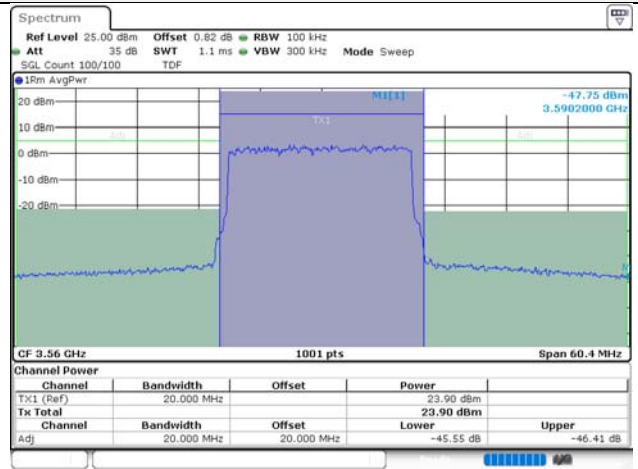

20M QPSK High ch. 1RB

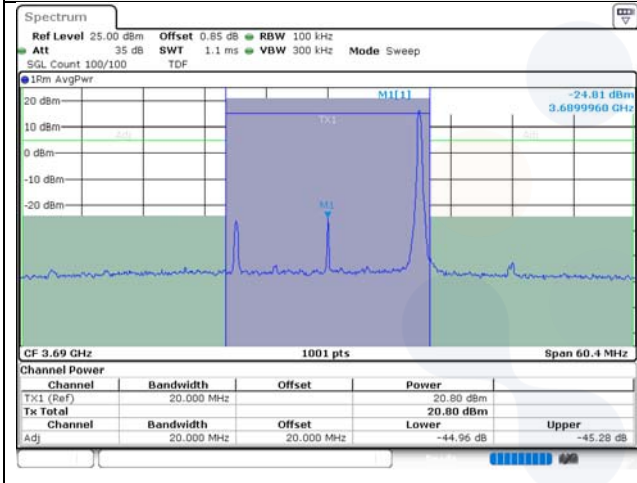

20M QPSK High ch. FRB

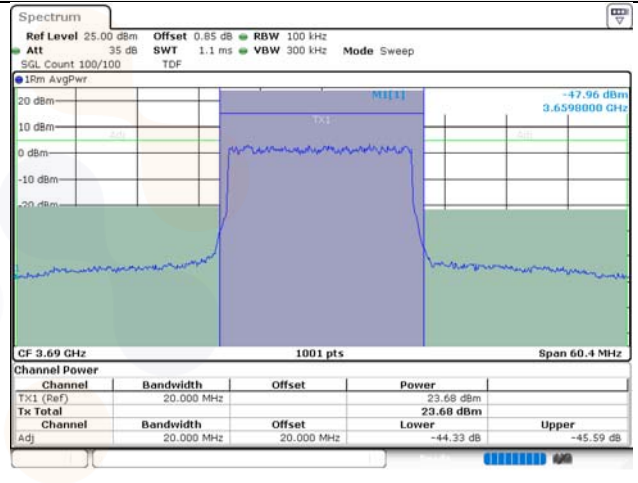

40M QPSK Low ch. 1RB

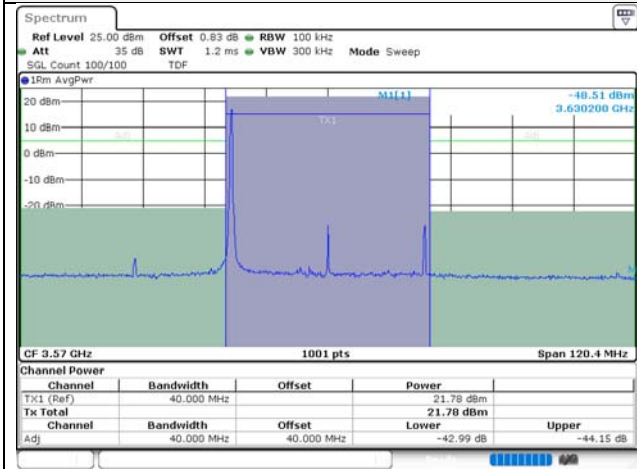

40M QPSK Low ch. FRB

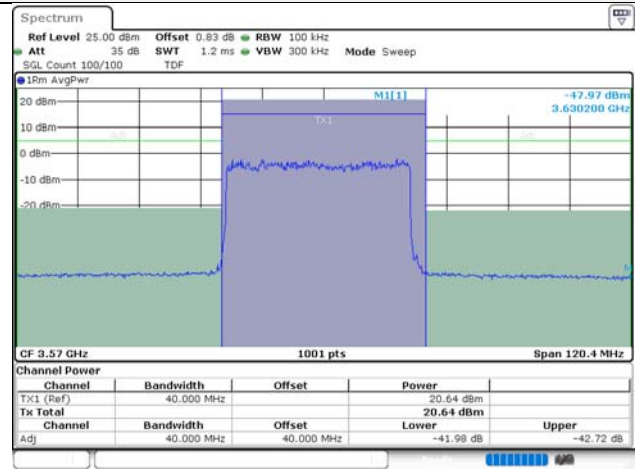

40M QPSK High ch. 1RB

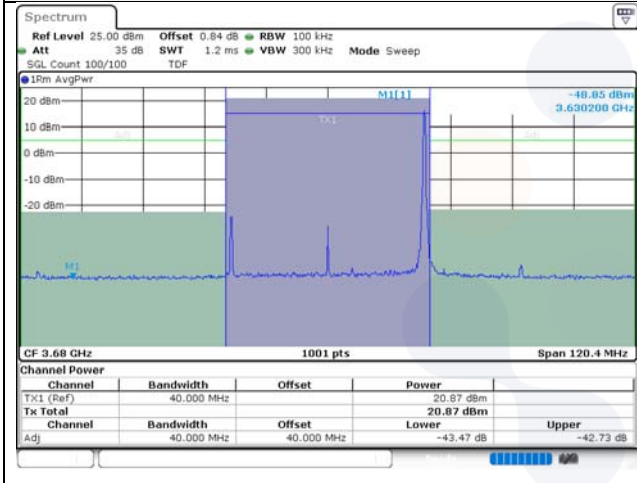

40M QPSK High ch. FRB

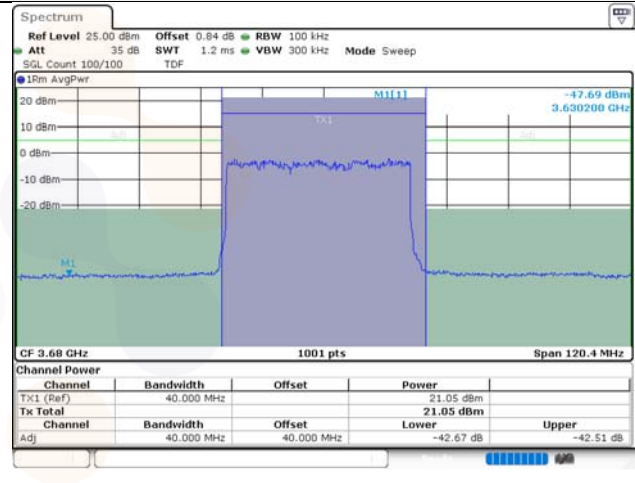

7.4. Spurious Emissions at Antenna Terminal

Test setup

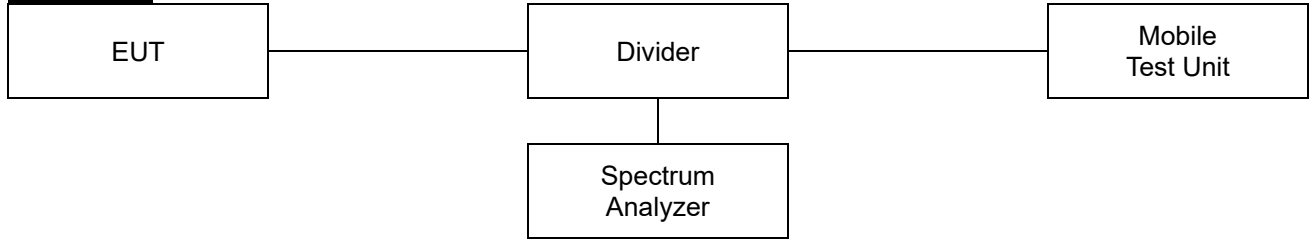

Limit

According to §96.41(e) The conducted power of emissions below 3530 MHz or above 3720 MHz shall not exceed -40dBm/MHz .

Test procedure

971168 D01 v03r01 - Section 6
ANSI 63.26-2015 – Section 5.7

Test settings

- 1) Start frequency was set to 30 MHz and stop frequency was set to at least 10th the fundamental frequency.
- 2) Detector = RMS
- 3) Sweep time = auto couple.
- 4) Trace mode = trace average
- 5) Allow trace to fully stabilize.
- 6) Please see test notes below RBW and VBW settings.

Notes:

1. Per 22.917(b) and RSS-132(5.5), compliance with these provisions is based on the use of measurement instrumentation employing a resolution bandwidth of 100 kHz or greater for frequencies less than 1 GHz and 1 MHz or greater for frequencies greater than 1 GHz.
The emission bandwidth is defined as the width of the signal between two points, one below the carrier center frequency and one above the carrier center frequency, outside of which all emissions are attenuated at least 26 dB below the transmitter power.
2. All modes of operation were investigated and the worst-case configuration results are reported.

Test results

Test mode: 5G NR n48 DFT-s-OFDM

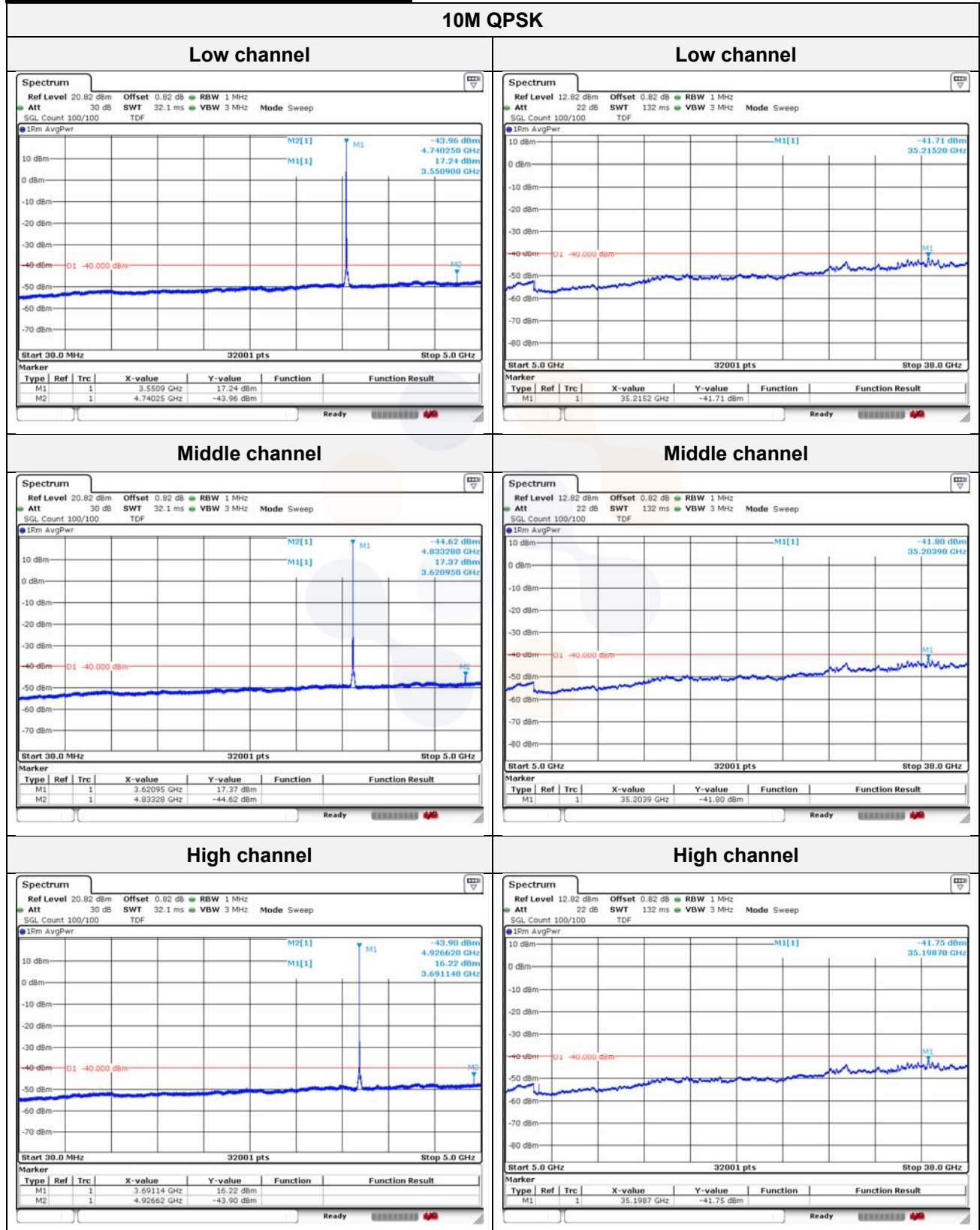

7.5. Peak to Average Power Ratio (PAPR)

Test setup

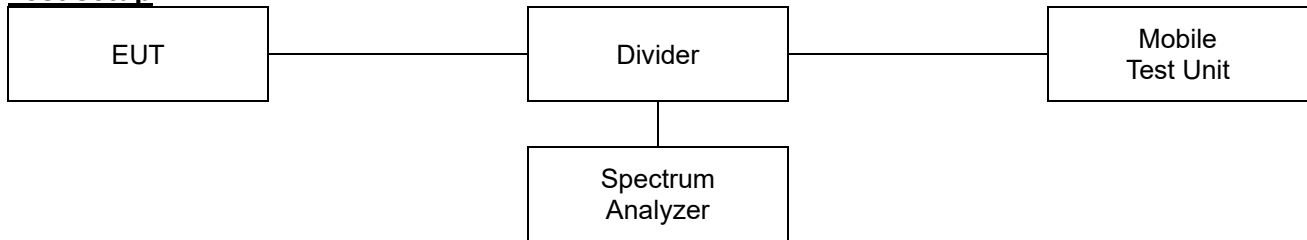

Limit

According to §96.41(g) The peak-to-average power ratio (PAPR) of any CBSD transmitter output power must not exceed 13 dB.

Test procedure

971168 D01 v03r01 - Section 5.7.2
971168 D02 v02r02 – Section VII
ANSI 63.26-2015 – Section 5.2.3.4

Test settings

5.2.3.4 Measurement of peak power in a broadband noise-like signal using CCDF

- 1) Set resolution/measurement bandwidth \geq OBW or specified reference bandwidth
- 2) Set the number of counts to a value that stabilizes the measured CCDF curve.
- 3) Set the measurement interval as follows:
 - a) For continuous transmissions, set to the greater of $[10 \times (\text{number of points in sweep}) \times (\text{transmission symbol period})]$ or 1 ms.
 - b) For burst transmissions, employ an external trigger that is synchronized with the EUT burst timing sequence, or use the internal burst trigger with a trigger level that allows the burst to stabilize. Set the measurement interval to a time that is less than or equal to the burst duration.
 - c) If there are several carriers in a single antenna port, the peak power shall be determined for each individual carrier (by disabling the other carriers while measuring the required carrier) and the total peak power calculated from the sum of the individual carrier peak powers.
- 4) Record the maximum PAPR level associated with a probability of 0.1%

5.2.6 Peak-to-average power ratio

- 1) Use one of the procedures presented in 5.2(ANSI C63.26-2015) to measure the total peak power and record as P_{PK} .
- 2) Use one of the applicable procedure presented 5.2(ANSI C63.26-2015) to measure the total average power and record as PAG. Determine the P.A.P.R from:
- 3) $PAPR(\text{dB}) = PPK(\text{dBm or dBW}) - PAG(\text{dBm or dBW})$

Notes:

1. All modes of operation were investigated and the worst-case configuration results are reported.

Test results

Test mode: 5G NR n48 CP-OFDM

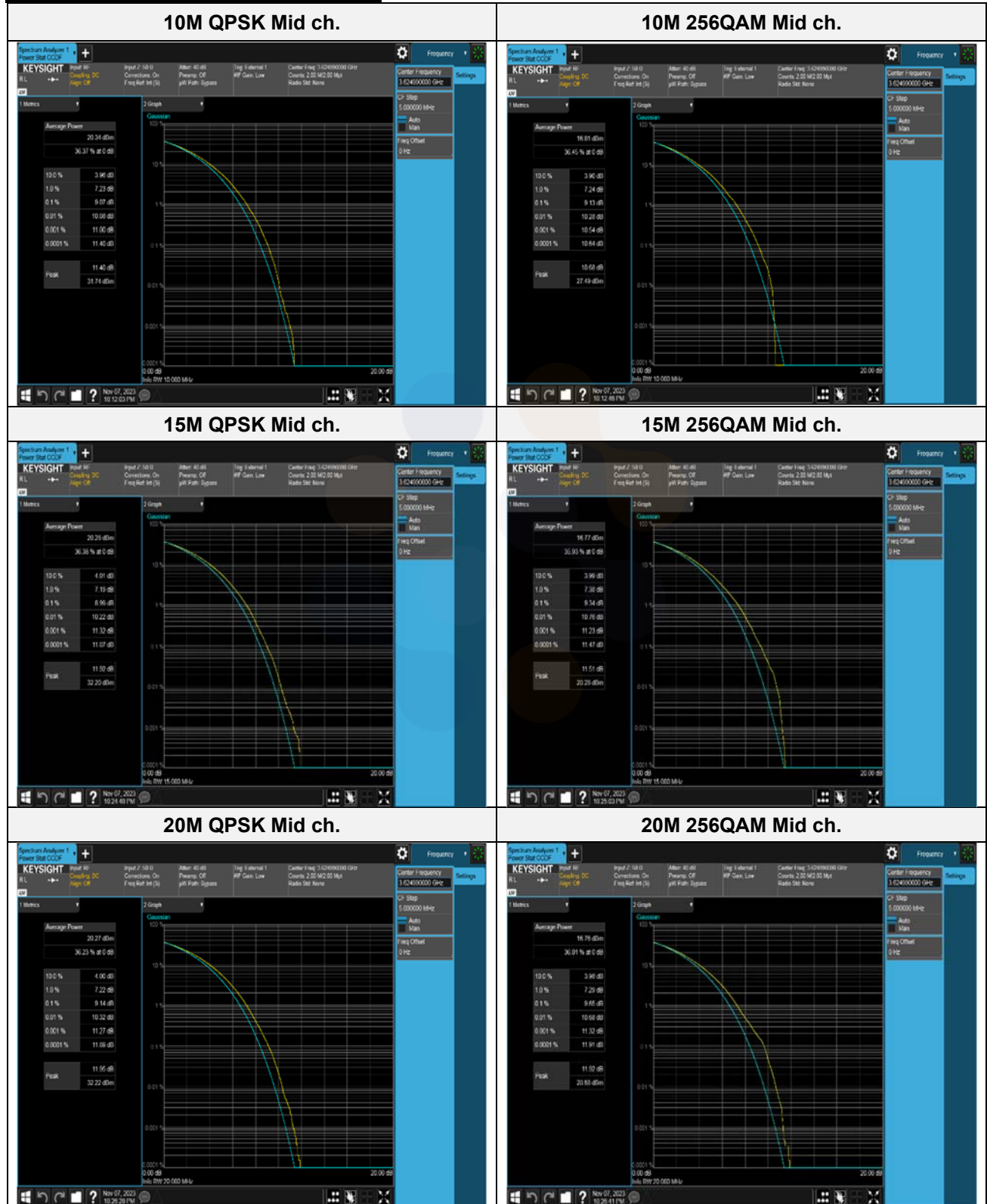

40M QPSK Mid ch.

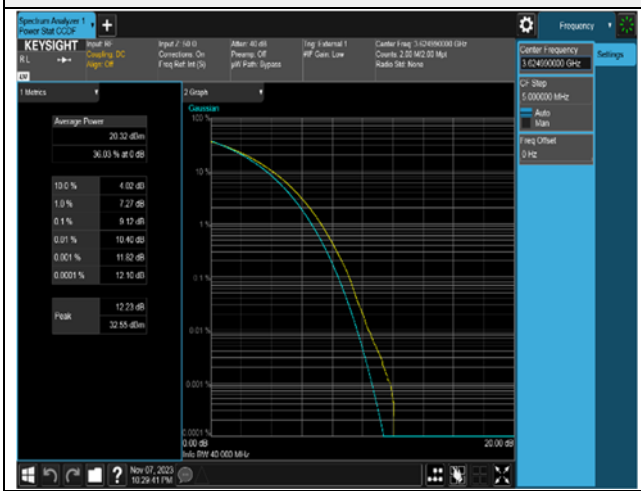

40M 256QAM Mid ch.

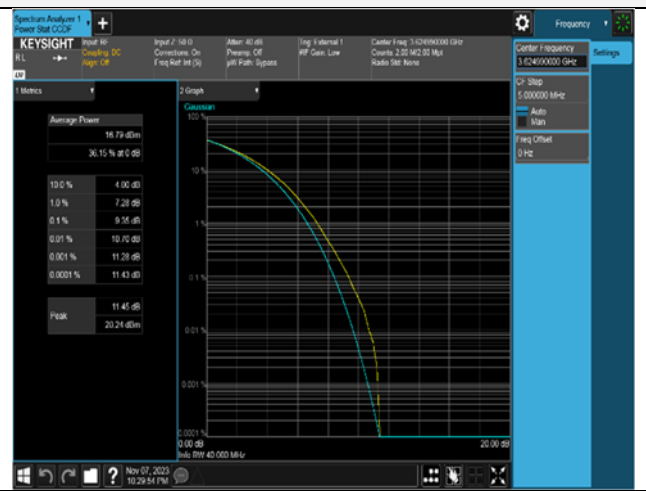

7.6. Frequency stability

Test setup

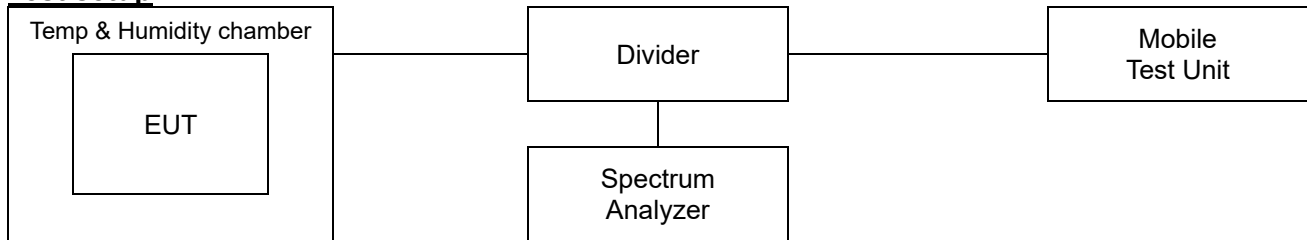

Limit

According to §2.1055(a),

The frequency stability shall be measured with variation of ambient temperature as follows:

- 1) From -30° to $+50^{\circ}$ centigrade for all equipment except that specified in paragraphs (a) (2) and (3) of this section.
- 2) From -20° to $+50^{\circ}$ centigrade for equipment to be licensed for use in the maritime services under part 80 of this chapter, except for class A, B, and S emergency position indicating radio beacons (EPIRBs), and equipment to be licensed for use above 952 MHz at operational fixed stations in all services, stations in the local television transmission service and point-to-point microwave radio service under part 21 of this chapter, equipment licensed for use aboard aircraft in the aviation services under part 87 of this chapter, and equipment authorized for use in the family radio service under part 95 of this chapter.
- 3) From 0° to $+50^{\circ}$ centigrade for equipment to be licensed for use in the radio broadcast Services under part 73 of this chapter.

According to §2.1055(d),

The frequency stability shall be measured with variation of primary supply Voltage as follows:

- 1) Vary primary supply voltage from 85 to 115 percent of the nominal value for other than hand carried battery equipment.
- 2) For hand carried, battery powered equipment, reduce primary supply voltage to the battery operating and point which shall be specified by the manufacturer.
- 3) The supply voltage shall be measured at the input to the cable normally provided with the equipment, or at the power supply terminals if cables are not normally provided. Effects on frequency of transmitter keying (except for broadcast transmitters) and any heating element cycling at the nominal supply voltage and at each extreme also shall be shown.

Test procedure

ANSI 63.26-2015 – Section 5.6

Test settings

- 1) The carrier frequency of the transmitter is measured at room temperature. (20°C to provide a reference)
- 2) The equipment is turned on in a “standby” condition for one minute before applying power to the transmitter. Measurement of the carrier frequency of the transmitter is made within one minute after applying power to the transmitter.
- 3) Frequency measurements are made at 10°C intervals ranging from -30°C to $+50^{\circ}\text{C}$. A period of at least one half-hour is provided to allow stabilization of the equipment at each Temperature level.

Test results

Test mode : 5G NR n48
 Frequency (Hz) : 3 624 000 000
 Channel : 641667
 Bandwidth(MHz) : 5
 Deviation limit : The frequency stability shall be sufficient to ensure that the occupied bandwidth stays within each of the sub-bands when tested at the temperature and supply voltage

Voltage (%)	Power (V)	Temp. (°C)	Frequency (Hz)	Frequency error (Hz)	Deviation	
					(ppm)	(%)
100%	3.85	+23(Ref)	3,623,999,992	-7.70	0.0	0.000000
		-30	3,624,000,002	1.90	0.0	0.000000
		-20	3,624,000,003	2.60	0.0	0.000000
		-10	3,624,000,002	2.20	0.0	0.000000
		0	3,624,000,001	1.30	0.0	0.000000
		+10	3,624,000,001	1.10	0.0	0.000000
		+20	3,623,999,995	-5.50	0.0	0.000000
		+30	3,623,999,995	-4.80	0.0	0.000000
		+40	3,623,999,997	-3.20	0.0	0.000000
		+50	3,623,999,998	-2.03	0.0	0.000000
115%	4.43	+23(Ref)	3,623,999,993	-7.40	0.0	0.000000
End point	3.40	+23(Ref)	3,623,999,996	-3.60	0.0	0.000000

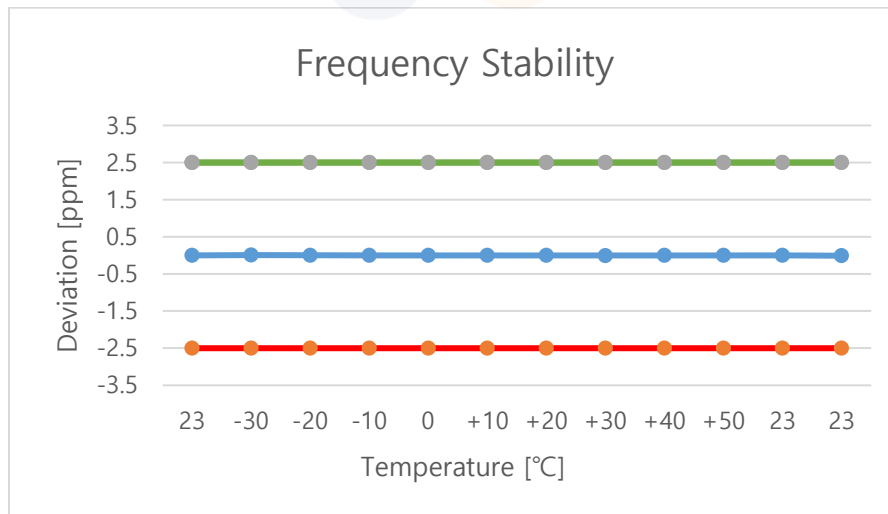

7.7. Radiated Power (ERP/EIRP)

Test setup

The diagram below shows the test setup that is utilized to make the measurements for emission from 30 MHz to 1 GHz emissions.

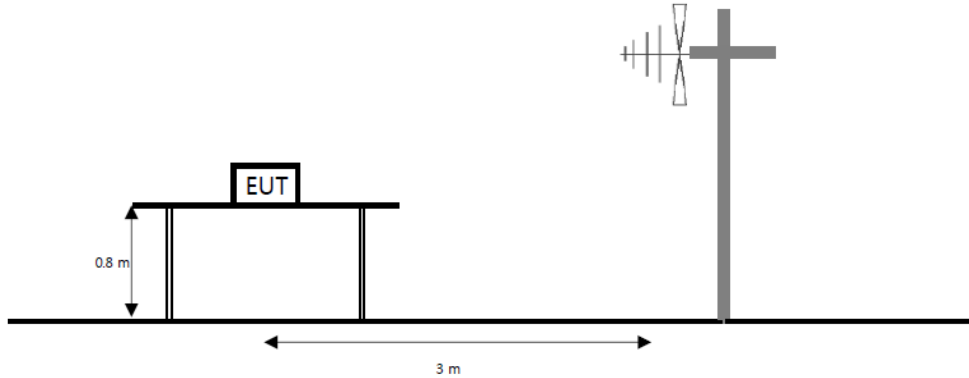

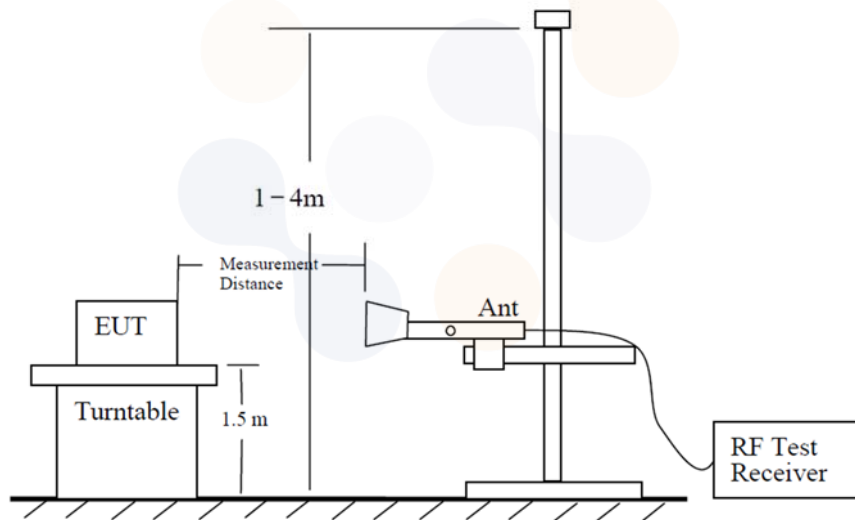

The diagram below shows the test setup that is utilized to make the measurements for emission from 1 GHz to the tenth harmonic of the highest fundamental frequency or to 40 GHz emissions, whichever is lower.

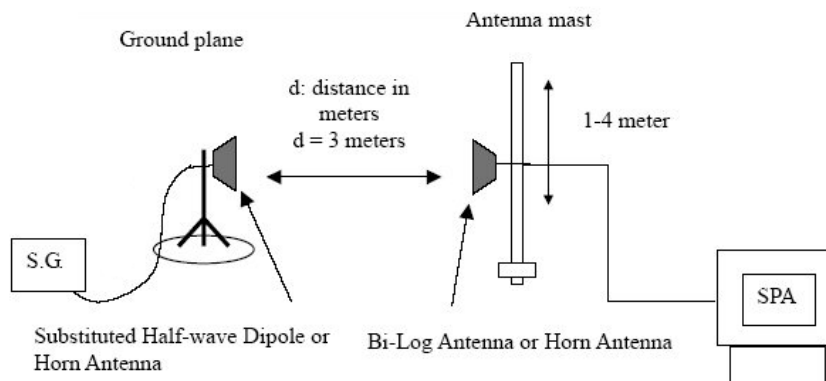

The diagram below shows the test setup for substituted method.



<p>Eurofins KCTL Co.,Ltd. 65, Sinwon-ro, Yeongtong-gu, Suwon-si, Gyeonggi-do, 16677, Korea TEL: 82-70-5008-1021 FAX: 82-505-299-8311 www.kctl.co.kr</p>	<p>Report No.: KR23-SRF0268-A Page (49) of (60)</p>	 
--	---	---

Limit

According to §96.41(b), The maximum effective isotropic radiated power (EIRP) of any CBSD and End User Device shall not exceed 23dBm/MHz.

Test procedure

971168 D01 v03r01 - Section 5.2 and 5.8, 412172 D01 v01r01
ANSI 63.26-2015 – Section 5.2
ANSI/TIA-603-E-2016 - Section 2.2.17

Test settings

- 1) RBW = 1 % to 5 % of the OBW.
- 2) VBW $\geq 3 \times$ RBW.
- 3) SPAN = 2 \times to 3 \times the OBW.
- 4) Number of measurement points in sweep $\geq 2 \times$ span / RBW.
- 5) Sweep time :
 - 1) Auto couple, or
 - 2) $\geq [10 \times (\text{number of points in sweep}) \times (\text{transmission period})]$ for single sweep (automation-compatible) measurement. Transmission period is the on and off time of the transmitter.
- 6) Detector = RMS
- 7) If the EUT can be configured to transmit continuously, then set the trigger to free run.
- 8) If the EUT cannot be configured to transmit continuously, then use a sweep trigger with the level set to enable triggering only on full power bursts and configure the EUT to transmit at full power for the entire duration of each sweep. Verify that the sweep time is less than or equal to the transmission burst duration. Time gating can also be used under similar constraints (i.e., configured such that measurement data is collected only during active full -power transmissions).
- 9) Trace mode = trace averaging (RMS) over 100 sweeps.
- 10) Compute the power by integrating the spectrum across the OBW of the signal using the instrument's band or channel power measurement function, with the band/channel limits set equal to the OBW band edges. If the instrument does not have a band or channel power function, then sum the spectrum levels (in linear power units) at intervals equal to the RBW extending across the entire OBW of the spectrum.
- 11) Allow trace to fully stabilize.

Notes:

1. On a test site, the EUT shall be placed at 80 cm or 1.5 m height on a turn table, and in the position close to normal use as declared by the applicant.
2. The test antenna shall be oriented initially for vertical polarization located 3 m from EUT to correspond to the fundamental frequency of the transmitter.
3. The turntable is rotated through 360°, and the receiving antenna scans in order to determine the Level of the maximized emission.
4. The test antenna shall be raised and lowered again through the specified range of height until the maximum signal level is detected by the measuring receiver.
5. The maximum signal level detected by the measuring receiver shall be noted.
6. The EUT was replaced by half-wave dipole (1 GHz below) or horn antenna (1 GHz above) connected to a signal generator.

The power is calculated by the following formula;

$$P_d(\text{dBm}) = P_g(\text{dBm}) - \text{Cable loss (dB)} + \text{Antenna gain (dB)}$$

Note. P_d is the dipole equivalent power and P_g is the generator output power into the substitution antenna.

7. The test antenna shall be raised and lowered through the specified range of height to ensure that The maximum signal is received.
8. The input signal to the substitution antenna shall be adjusted to the level that produces a level Detected by the measuring corrected for the change of input attenuator setting of the measuring Receiver.
9. The input level to the substitution antenna shall be recorded as power level in dBm, corrected for Any change of input attenuator setting of the measuring receiver.
10. The measurement shall be repeated with the test antenna and the substitution antenna Orientated for horizontal polarization.



Test results

Test mode: 5G NR n48 DFT-s-OFDM

Band width [MHz]	Modulation	Channel	RB Size/ Offset	Pol.	Antenna Gain	C.L	Substitute Level	EIRP	
				[V/H]	[dBi]	[dB]	[dBm]	[dBm]	[W]
10	QPSK	Low	1/22	H	8.40	12.93	26.00	21.47	0.140
		Middle	1/1	H	8.52	12.87	24.39	20.05	0.101
		High	1/22	H	8.65	12.52	24.38	20.51	0.112
	16QAM	Low	1/22	H	8.40	12.93	24.81	20.28	0.107
		Middle	1/22	H	8.52	12.87	23.26	18.92	0.078
		High	1/22	H	8.65	12.52	23.15	19.28	0.085
15	QPSK	Low	1/19	H	8.40	12.93	25.87	21.34	0.136
		Middle	1/19	H	8.52	12.87	24.35	20.01	0.100
		High	1/36	H	8.65	12.61	23.28	19.31	0.085
	16QAM	Low	1/19	H	8.40	12.93	25.03	20.50	0.112
		Middle	1/19	H	8.52	12.87	23.15	18.81	0.076
		High	1/36	H	8.65	12.61	22.41	18.44	0.070
20	QPSK	Low	1/1	H	8.41	12.92	25.45	20.94	0.124
		Middle	1/26	H	8.52	12.87	24.36	20.02	0.100
		High	1/26	H	8.64	12.61	23.46	19.49	0.089
	16QAM	Low	1/1	H	8.41	12.92	24.51	20.00	0.100
		Middle	1/1	H	8.52	12.87	23.41	19.07	0.081
		High	1/26	H	8.64	12.61	22.24	18.27	0.067
40	QPSK	Low	1/1	H	8.43	12.91	25.73	21.24	0.133
		Middle	1/1	H	8.52	12.87	24.21	19.87	0.097
		High	1/1	H	8.62	12.30	22.95	19.27	0.085
	16QAM	Low	1/1	H	8.43	12.91	24.93	20.44	0.111
		Middle	1/1	H	8.52	12.87	23.17	18.83	0.076
		High	1/1	H	8.62	12.30	22.22	18.54	0.071

Test mode: 5G NR n48(SRS1)

Band width [MHz]	Modulation	Channel	RB Size/ Offset	Pol.	Antenna Gain	C.L	Substitute Level	EIRP	
				[V/H]	[dBi]	[dB]	[dBm]	[dBm]	[W]
40	$\pi/2$ BPSK	Low	1/53	H	8.43	12.91	15.57	11.08	0.013
		Middle	1/53	H	8.52	12.87	14.54	10.20	0.010
		High	1/53	H	8.62	12.30	13.92	10.24	0.011

Test mode: 5G NR n48(SRS2)

Band width [MHz]	Modulation	Channel	RB Size/ Offset	Pol.	Antenna Gain	C.L	Substitute Level	EIRP	
				[V/H]	[dBi]	[dB]	[dBm]	[dBm]	[W]
10	$\pi/2$ BPSK	Low	1/22	H	8.40	12.93	15.84	11.31	0.014
		Middle	1/22	H	8.52	12.87	15.45	11.11	0.013
		High	1/22	H	8.65	12.52	14.91	11.04	0.013

Test mode: 5G NR n48(SRS3)

Band width [MHz]	Modulation	Channel	RB Size/ Offset	Pol.	Antenna Gain	C.L	Substitute Level	EIRP	
				[V/H]	[dBi]	[dB]	[dBm]	[dBm]	[W]
40	π/2 BPSK	Low	1/1	H	8.43	12.91	15.91	11.42	0.014
		Middle	1/1	H	8.52	12.87	18.38	14.04	0.025
		High	1/1	H	8.62	12.30	17.28	13.60	0.023

Note.

1. E.R.P & E.I.R.P(dBm) = Substitute Level(dB) + Antenna gain(dBd&dBi) - C.L(Cable loss) (dB)



7.8. Radiated Spurious Emissions

Test setup

The diagram below shows the test setup that is utilized to make the measurements for emission from 30 MHz to 1 GHz emissions.

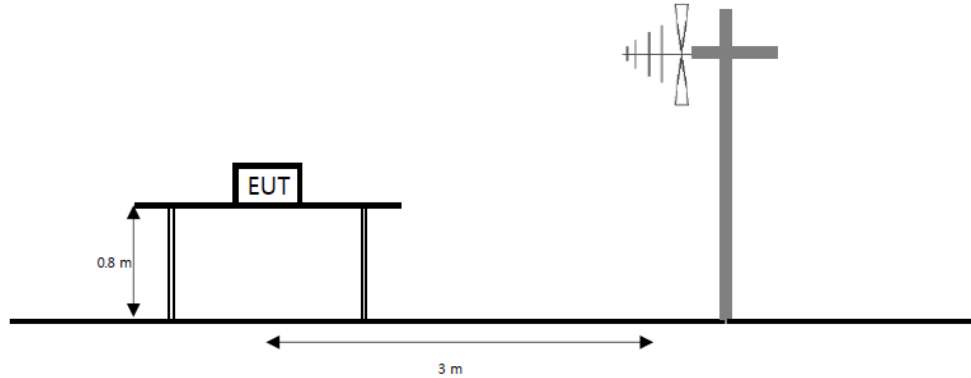

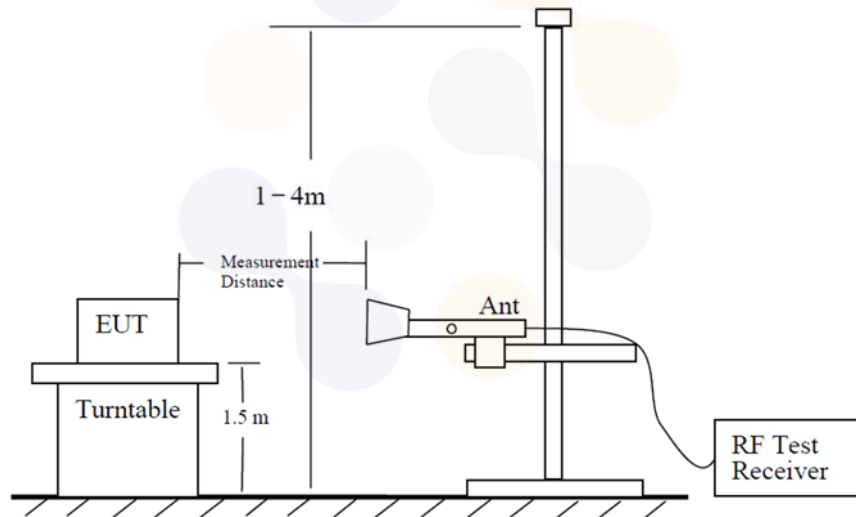

The diagram below shows the test setup that is utilized to make the measurements for emission from 1 GHz to the tenth harmonic of the highest fundamental frequency or to 40 GHz emissions, whichever is lower.

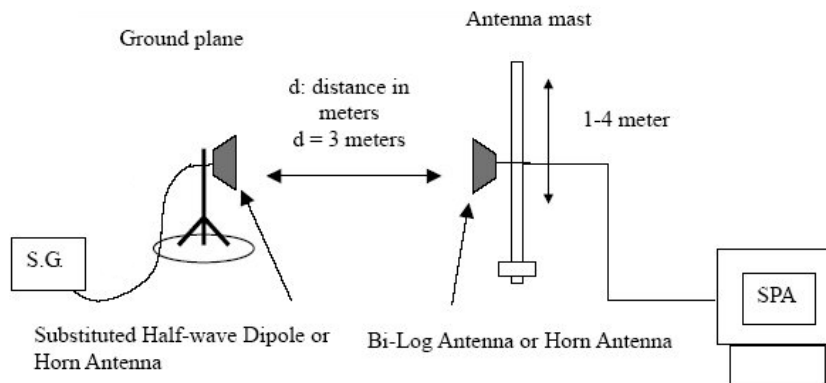

The diagram below shows the test setup for substituted method.



<p>Eurofins KCTL Co.,Ltd. 65, Sinwon-ro, Yeongtong-gu, Suwon-si, Gyeonggi-do, 16677, Korea TEL: 82-70-5008-1021 FAX: 82-505-299-8311 www.kctl.co.kr</p>	<p>Report No.: KR23-SRF0268-A Page (54) of (60)</p>	 
--	---	---

Limit

According to §22.917(a), The conducted power of emissions below 3530 MHz or above 3720 MHz shall not exceed -40dBm/MHz.

Test procedure

971168 D01 v03r01 - Section 6.2

ANSI 63.26-2015 – Section 5.5

ANSI/TIA-603-E-2016 - Section 2.2.12

Test settings

- 1) RBW = 100 kHz for below 1 GHz and 1 MHz for above 1 GHz.
- 2) VBW $\geq 3 \times$ RBW.
- 3) Detector = RMS
- 4) Trace mode = Max hold
- 5) Sweep time = Auto couple
- 6) Number of sweep points $\geq 2 \times$ span / RBW
- 7) Allow trace to fully stabilize.

Notes:

1. On a test site, the EUT shall be placed at 80 cm or 1.5 m height on a turn table, and in the position close to normal use as declared by the applicant.
2. The test antenna shall be oriented initially for vertical polarization located 3 m from EUT to correspond to the fundamental frequency of the transmitter.
3. The turntable is rotated through 360°, and the receiving antenna scans in order to determine the level of the maximized emission.
4. The test antenna shall be raised and lowered again through the specified range of height until the maximum signal level is detected by the measuring receiver.
5. The maximum signal level detected by the measuring receiver shall be noted.
6. The EUT was replaced by half-wave dipole (1 GHz below) or horn antenna (1 GHz above) connected to a signal generator.
7. The test antenna shall be raised and lowered through the specified range of height to ensure that the maximum signal is received.
8. The input signal to the substitution antenna shall be adjusted to the level that produces a level detected by the measuring corrected for the change of input attenuator setting of the measuring receiver.
9. The input level to the substitution antenna shall be recorded as power level in dBm, corrected for any change of input attenuator setting of the measuring receiver.
10. The measurement shall be repeated with the test antenna and the substitution antenna orientated for horizontal polarization.

Test results

Test mode: 5G NR n48 DFT-s-OFDM

Test mode : 5G NR n48
 Frequency(MHz) : 3 555.00
 Channel : 637000
 Bandwidth(MHz) : 10
 RB Size/Offset : 1/22

Mode	Frequency	Pol.	Antenna Gain	Cable loss	Substitute Level	Level	Limit	Margin
	[MHz]	[V/H]	[dBi]	[dB]	[dBm]	[dBm]	[dBm]	[dB]
QPSK	4 739.90	H	9.94	14.85	-41.39	-46.30	-40.00	6.30
	7 120.60	V	11.57	19.11	-45.26	-52.80	-40.00	12.80
	10 678.00	H	13.20	24.27	-38.73	-49.80	-40.00	9.80
	14 239.60	H	14.26	30.02	-35.74	-51.50	-40.00	11.50
	17 800.50	V	14.10	35.99	-32.21	-54.10	-40.00	14.10

Test mode : 5G NR n48
 Frequency(MHz) : 3 624.99
 Channel : 641666
 Bandwidth(MHz) : 10
 RB Size/Offset : 1/22

Mode	Frequency	Pol.	Antenna Gain	Cable loss	Substitute Level	Level	Limit	Margin
	[MHz]	[V/H]	[dBi]	[dB]	[dBm]	[dBm]	[dBm]	[dB]
QPSK	4 833.00	H	10.07	14.62	-41.65	-46.20	-40.00	6.20
	7 237.50	V	11.73	18.85	-45.58	-52.70	-40.00	12.70
	10 863.50	H	13.20	24.68	-36.92	-48.40	-40.00	8.40
	14 480.40	H	14.11	30.13	-35.18	-51.20	-40.00	11.20

Test mode : 5G NR n48
 Frequency(MHz) : 3 694.98
 Channel : 646332
 Bandwidth(MHz) : 10
 RB Size/Offset : 1/22

Mode	Frequency	Pol.	Antenna Gain	Cable loss	Substitute Level	Level	Limit	Margin
	[MHz]	[V/H]	[dBi]	[dB]	[dBm]	[dBm]	[dBm]	[dB]
QPSK	4 926.10	H	10.20	15.32	-41.08	-46.20	-40.00	6.20
	7 404.10	V	11.97	19.60	-45.87	-53.50	-40.00	13.50
	11 095.90	V	13.22	24.60	-38.22	-49.60	-40.00	9.60
	14 805.20	V	14.04	30.27	-34.27	-50.50	-40.00	10.50

Test mode: 5G NR n48(SRS1)

Test mode : 5G NR n48(SRS1)
 Frequency(MHz) : 3 570.00
 Channel : 638000
 Bandwidth(MHz) : 40
 RB Size/Offset : 1/53

Mode	Frequency	Pol.	Antenna Gain	Cable loss	Substitute Level	Level	Limit	Margin
	[MHz]	[V/H]	[dBi]	[dB]	[dBm]	[dBm]	[dBm]	[dB]
QPSK	7 140.20	H	11.60	19.13	-47.67	-55.20	-40.00	15.20
	10 709.50	H	13.20	24.30	-39.40	-50.50	-40.00	10.50
	14 280.20	V	14.23	30.09	-35.04	-50.90	-40.00	10.90
	17 849.50	H	14.10	34.23	-32.47	-52.60	-40.00	12.60

Test mode : 5G NR n48(SRS1)
 Frequency(MHz) : 3 624.99
 Channel : 641666
 Bandwidth(MHz) : 40
 RB Size/Offset : 1/53

Mode	Frequency	Pol.	Antenna Gain	Cable loss	Substitute Level	Level	Limit	Margin
	[MHz]	[V/H]	[dBi]	[dB]	[dBm]	[dBm]	[dBm]	[dB]
QPSK	7 245.20	H	11.74	18.87	-44.77	-51.90	-40.00	11.90
	10 874.00	H	13.20	24.69	-38.41	-49.90	-40.00	9.90
	14 501.40	V	14.10	29.71	-35.09	-50.70	-40.00	10.70
	18 125.24	H	11.30	31.25	-31.95	-51.90	-40.00	11.90

Test mode : 5G NR n48(SRS1)
 Frequency(MHz) : 3 679.98
 Channel : 645332
 Bandwidth(MHz) : 40
 RB Size/Offset : 1/53

Mode	Frequency	Pol.	Antenna Gain	Cable loss	Substitute Level	Level	Limit	Margin
	[MHz]	[V/H]	[dBi]	[dB]	[dBm]	[dBm]	[dBm]	[dB]
QPSK	7 362.80	H	11.91	19.39	-46.22	-53.70	-40.00	13.70
	11 038.50	V	13.21	24.50	-38.71	-50.00	-40.00	10.00
	14 718.40	H	14.06	30.79	-33.37	-50.10	-40.00	10.10
	18 401.66	V	11.30	31.49	-32.01	-52.20	-40.00	12.20

Test mode: 5G NR n48(SRS2)

Test mode : 5G NR n48(SRS2)
 Frequency(MHz) : 3 555.00
 Channel : 637000
 Bandwidth(MHz) : 10
 RB Size/Offset : 1/22

Mode	Frequency	Pol.	Antenna Gain	Cable loss	Substitute Level	Level	Limit	Margin
	[MHz]	[V/H]	[dBi]	[dB]	[dBm]	[dBm]	[dBm]	[dB]
QPSK	7 117.10	V	11.56	19.11	-46.95	-54.50	-40.00	14.50
	10 681.50	H	13.20	24.27	-38.63	-49.70	-40.00	9.70
	14 238.90	H	14.26	30.02	-32.24	-48.00	-40.00	8.00
	17 801.20	V	14.10	35.97	-31.83	-53.70	-40.00	13.70

Test mode : 5G NR n48(SRS2)
 Frequency(MHz) : 3 624.99
 Channel : 641666
 Bandwidth(MHz) : 10
 RB Size/Offset : 1/22

Mode	Frequency	Pol.	Antenna Gain	Cable loss	Substitute Level	Level	Limit	Margin
	[MHz]	[V/H]	[dBi]	[dB]	[dBm]	[dBm]	[dBm]	[dB]
QPSK	7 257.80	H	11.76	18.89	-45.27	-52.40	-40.00	12.40
	10 886.60	V	13.20	24.70	-39.50	-51.00	-40.00	11.00
	14 520.30	H	14.10	29.76	-36.14	-51.80	-40.00	11.80
	18 148.93	V	11.30	31.26	-31.54	-51.50	-40.00	11.50

Test mode : 5G NR n48(SRS2)
 Frequency(MHz) : 3 694.98
 Channel : 646332
 Bandwidth(MHz) : 10
 RB Size/Offset : 1/22

Mode	Frequency	Pol.	Antenna Gain	Cable loss	Substitute Level	Level	Limit	Margin
	[MHz]	[V/H]	[dBi]	[dB]	[dBm]	[dBm]	[dBm]	[dB]
QPSK	7 403.40	H	11.96	19.59	-46.97	-54.60	-40.00	14.60
	11 102.90	H	13.22	24.70	-35.72	-47.20	-40.00	7.20
	14 800.30	H	14.04	30.25	-32.39	-48.60	-40.00	8.60
	18 495.31	H	11.30	31.82	-31.28	-51.80	-40.00	11.80

Test mode: 5G NR n48(SRS3)

Test mode : 5G NR n48(SRS3)
 Frequency(MHz) : 3 570.00
 Channel : 638000
 Bandwidth(MHz) : 40
 RB Size/Offset : 1/1

Mode	Frequency	Pol.	Antenna Gain	Cable loss	Substitute Level	Level	Limit	Margin
	[MHz]	[V/H]	[dBi]	[dB]	[dBm]	[dBm]	[dBm]	[dB]
QPSK	7 100.30	H	11.54	19.09	-43.65	-51.20	-40.00	11.20
	10 647.90	H	13.20	24.23	-37.77	-48.80	-40.00	8.80
	14 203.20	H	14.28	29.97	-34.81	-50.50	-40.00	10.50
	17 750.80	V	14.10	33.81	-33.99	-53.70	-40.00	13.70

Test mode : 5G NR n48(SRS3)
 Frequency(MHz) : 3 624.99
 Channel : 641666
 Bandwidth(MHz) : 10
 RB Size/Offset : 1/1

Mode	Frequency	Pol.	Antenna Gain	Cable loss	Substitute Level	Level	Limit	Margin
	[MHz]	[V/H]	[dBi]	[dB]	[dBm]	[dBm]	[dBm]	[dB]
QPSK	7 211.60	H	11.70	18.79	-46.11	-53.20	-40.00	13.20
	10 815.20	H	13.20	24.64	-38.66	-50.10	-40.00	10.10
	14 420.20	H	14.15	30.05	-35.90	-51.80	-40.00	11.80
	18 024.82	V	11.30	31.34	-31.26	-51.30	-40.00	11.30

Test mode : 5G NR n48(SRS3)
 Frequency(MHz) : 3 679.98
 Channel : 645332
 Bandwidth(MHz) : 40
 RB Size/Offset : 1/1

Mode	Frequency	Pol.	Antenna Gain	Cable loss	Substitute Level	Level	Limit	Margin
	[MHz]	[V/H]	[dBi]	[dB]	[dBm]	[dBm]	[dBm]	[dB]
QPSK	7 321.50	V	11.85	19.32	-46.73	-54.20	-40.00	14.20
	10 978.30	H	13.20	24.87	-38.53	-50.20	-40.00	10.20
	14 640.70	H	14.07	30.68	-34.29	-50.90	-40.00	10.90
	18 300.12	H	11.30	31.66	-32.54	-52.90	-40.00	12.90

Note.

1. E.R.P & E.I.R.P(dB m) = Substitute Level(dB) + Antenna gain(dB) - C.L(Cable loss) (dB)

EN-DC Mode (Worst case) DFT-s-OFDM

Test mode : 66A-n48A
Frequency(MHz) : 3 555.0
Channel : 637000
Bandwidth(MHz) : 20 (LTE), 10 (NR)
RB Size/Offset : 1/99 (LTE), 1/22 (NR)

Mode	Frequency	Pol.	Antenna Gain	Cable loss	Substitute Level	Level	Limit	Margin
	[MHz]	[V/H]	[dBi]	[dB]	[dBm]	[dBm]	[dBm]	[dB]
QPSK	4 739.90	H	9.94	14.85	-43.69	-48.60	-40.00	8.60
	5 336.30	H	10.50	15.96	-43.04	-48.50	-40.00	8.50
	7 119.90	V	11.57	19.11	-44.76	-52.30	-40.00	12.30
	10 679.40	V	13.20	24.27	-38.43	-49.50	-40.00	9.50
	14 238.20	V	14.26	30.02	-34.54	-50.30	-40.00	10.30
	17 799.10	H	14.10	32.09	-36.81	-54.80	-40.00	14.80

Note.

1. E.R.P & E.I.R.P(dBm) = Substitute Level(dB) + Antenna gain(dBd&dBi) - C.L.(Cable loss) (dB)

8. Measurement equipment

Equipment Name	Manufacturer	Model No.	Serial No.	Next Cal. Date
Spectrum Analyzer	R&S	FSVA40	101574	24.03.28
PXA Signal Analyzer	KEYSIGHT	N9040B	US56050101	24.07.03
Vector Signal Generator	R&S	SMBV100A	257566	24.07.04
Signal Generator	R&S	SMB100A	176206	24.01.19
Divider	Marki Microwave, Inc.	PD-0040	D0003	24.07.04
Radio Communication Analyzer	ANRITSU	MT8821C	6201807233	24.01.19
Radio Communication Analyzer	ANRITSU	MT8000A	6261923085	24.06.19
Temp & Humid Chamber	ESPEC CORP.	SH-642	93016978	24.01.19
Bilog Antenna	Teseq GmbH	CBL 6112D	62027	24.11.17**
Bilog Antenna	ETS.LINDGREN	3143B	228420	25.07.20
Horn Antenna	ETS-LINDGREN	3117	251528	24.02.02
Horn Antenna	ETS.LINDGREN	3117	227509	24.07.12
Horn Antenna	ETS-Lindgren	3116	00086635	24.03.20
Horn Antenna	ETS-LINDGREN	3116C	251516	24.02.02
Amplifier	SONOMA INSTRUMENT	310N	421822	24.10.12*
Amplifier	C&K Technologies, Inc.	BZR-00504000-551028-252525	27736	24.07.04
Amplifier	C&K Technologies, Inc.	BZRT-00504000-481055-382525	26299-27735	24.07.04
Spectrum Analyzer	AGILENT	N9040B	US55230151	24.07.03
High Pass Filter	Wainwright Instruments GmbH	WHKX10-900-1000-15000-40SS	11	24.07.04
High Pass Filter	Wainwright Instruments GmbH	WHKX12-2805-3000-18000-40SS	32	24.07.04
High Pass Filter	Wainwright Instruments GmbH	WHNX10-4050-4500-26500-40CC	SN3	24.10.16*
High Pass Filter	QOTANA TECHNOLOGIES	DBHF0508004000A	20070100016	24.07.04
Band Reject Filter	Wainwright Instruments GmbH	WRCQV16-3150-3300-4200-4350-40SS	SN1	24.10.13*
Radio Communication Analyzer	ANRITSU	MT8000A	6262093278	24.04.26
Antenna Mast	innco systems GmbH	MA4640-XP-ET	N/A	-
Controller	innco systems GmbH	CO3000	1175/45850319/P	-

*This equipment was calibrated during the test period, and was used after calibration.

**This equipment was calibrated during the test period, and was used before calibration.

End of test report