





TEST REPORT

Eurofins KCTL Co.,Ltd. 65, Sinwon-ro, Yeongtong-gu, Suwon-si, Gyeonggi-do, 16677, Korea Tel: 82-70-5008-1021 Fax: 82-505-299-8311 www.kctl.co.kr	Report No.: KR23-SEF0209-A Page (1) of (22)	 eurofins KCTL
1. Client		
<ul style="list-style-type: none"> ◦ Name : Samsung Electronics Co., Ltd. ◦ Address : 129, Samsung-ro, Yeongtong-gu, Suwon-si, Gyeonggi-do, 16677, Rep. of Korea ◦ Date of Receipt : 2023-09-05 		
2. Use of Report : -		
3. Name of Product / Model : Tablet PC / SM-X308U		
4. Manufacturer / Country of Origin : Samsung Electronics Co., Ltd. / Vietnam		
5. Date of Test : 2023-11-20 to 2023-11-21		
6. Location of Test : <input checked="" type="checkbox"/> Permanent Testing Lab <input type="checkbox"/> On Site Testing (Address: 65, Sinwon-ro, Yeongtong-gu, Suwon-si, Gyeonggi-do, 16677, Korea)		
7. Test method used : ANSI C63.4:2014, Class B FCC Part 15 Subpart B		
8. FCC ID : A3LSMX308U		
9. Test Results : Refer to the test result in the test report		
Affirmation	Tested by  Name : Dootae Lee (Signature)	Technical Manager  Name : Moonseop Cho (Signature)
2023-12-06		
Eurofins KCTL Co.,Ltd.		
As a test result of the sample which was submitted from the client, this report does not guarantee the whole product quality. This test report should not be used and copied without a written agreement by Eurofins KCTL Co.,Ltd.		

REPORT REVISION HISTORY

Date	Revision	Page No
2023-11-23	Originally issued	-
2023-12-06	Deleted the LTE ULCA 5B Band & Added the LTE 29 Band and NR 29 Band	-

This report shall not be reproduced except in full, without the written approval of Eurofins KCTL Co.,Ltd. This document may be altered or revised by Eurofins KCTL Co.,Ltd. personnel only, and shall be noted in the revision section of the document. Any alteration of this document not carried out by Eurofins KCTL Co.,Ltd. will constitute fraud and shall nullify the document. This test report is a general report that does not use the KOLAS accreditation mark and is not related to KS Q ISO/IEC 17025 and KOLAS accreditation.

General remarks for test reports

Statement concerning the uncertainty of the measurement systems used for the tests

(may be required by the product standard or client)

Internal procedure used for type testing through which traceability of the measuring uncertainty has been established:

Procedure number, issue date and title:

Calculations leading to the reported values are on file with the testing laboratory that conducted the testing.

Statement not required by the standard or client used for type testing

Contents

1. Applicant information	4
2. Laboratory information	5
3. Test system configuration	6
3.1 Operation environment	6
3.2 Measurement Uncertainty	7
4. Description of EUT	9
4.1 General information	9
4.2 Product description	10
4.3 Auxiliary equipments	11
4.4 Test configuration	12
4.5 Operating conditions	13
5. Summary of test results	14
5.1 Summary of EMI emission test results	14
6. Test results	15
6.1 Conducted Emissions	15
6.2 Radiated Emission	18

<p>Eurofins KCTL Co.,Ltd. 65, Sinwon-ro, Yeongtong-gu, Suwon-si, Gyeonggi-do, 16677, Korea Tel: 82-70-5008-1021 Fax: 82-505-299-8311 www.kctl.co.kr</p>	<p>Report No.: KR23-SEF0209-A Page (4) of (22)</p>	<p> KCTL</p>
--	--	--

1. Applicant information

Applicant: Samsung Electronics Co., Ltd.
Address: 129, Samsung-ro, Yeongtong-gu, Suwon-si, Gyeonggi-do,
16677, Rep. of Korea

Manufacturer: Samsung Electronics Co., Ltd.
Address: 129, Samsung-ro, Yeongtong-gu, Suwon-si, Gyeonggi-do,
16677, Rep. of Korea

Factory: Samsung Electronics Vietnam Thai Nguyen Co., Ltd
Address: Yen Binh Industrial Park, Dong Tien Ward, Pho Yen Town,
Thai Nguyen Province, Vietnam

2. Laboratory information

Address

Eurofins KCTL Co.,Ltd. (Suwon Lab.)

65, Sinwon-ro, Yeongtong-gu, Suwon-si, Gyeonggi-do, 16677, Korea

Telephone Number: 82 70 5008 1021

Facsimile Number: 82 505 299 8311

FCC Site Designation No: KR0040

VCCI Registration No.: R-20080, G-20078, C-20059, T-20056

Industry Canada Registration No. : 8035A

KOLAS NO.: KT231

SITE MAP

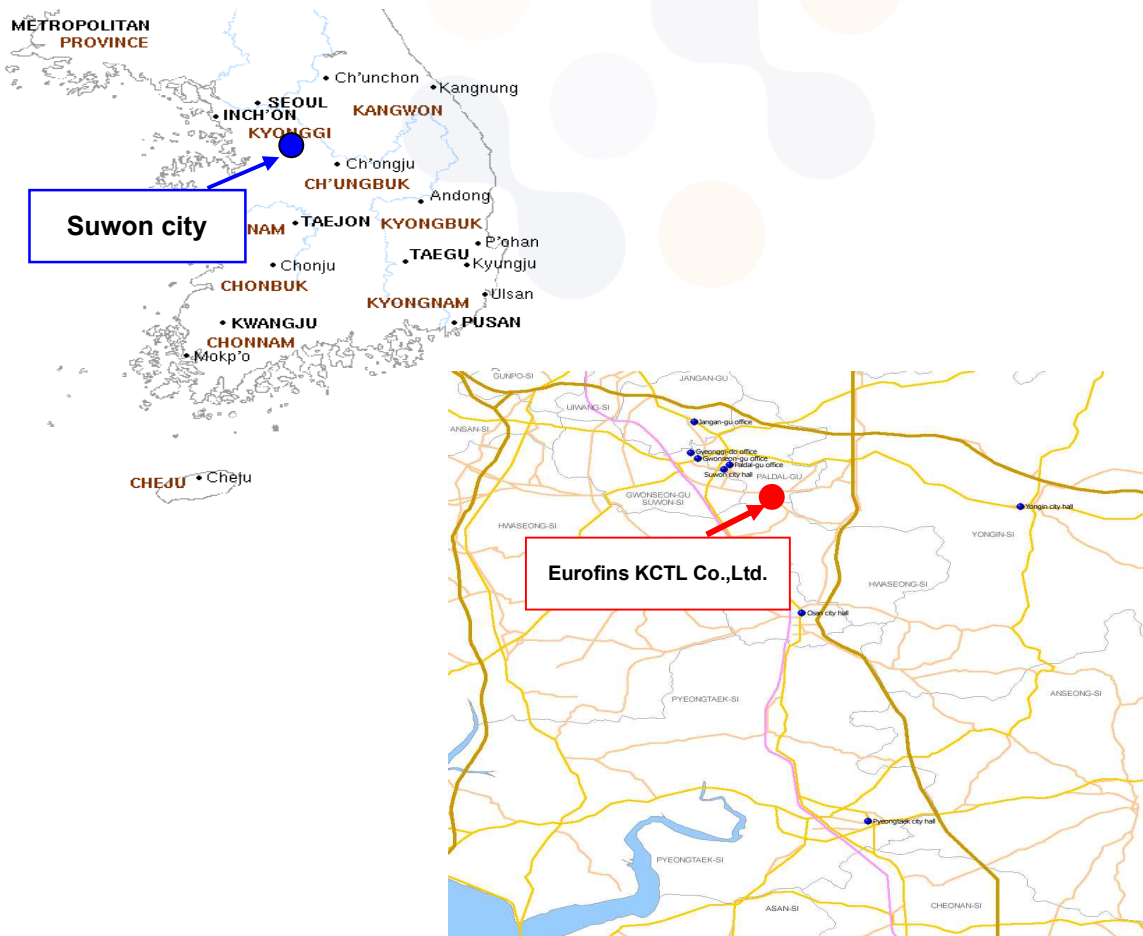

3. Test system configuration

3.1 Operation environment

	Temperature	Humidity	Pressure
Chamber 10 m (RE)	24.3 °C / 24.4 °C	35.3 % R.H. / 35.5 % R.H.	-
Shielded room(CE)	24.1 °C	36.3 % R.H.	-

Test site

These testing items were performed following locations;

Test item	Test site
Conducted Emission	Shielded Room
Radiated Emission	10 m Chamber

3.2 Measurement Uncertainty

All measurements involve certain levels of uncertainties, especially in field of EMC.

The factors contributing to uncertainties are test receiver, cable loss, antenna factor calibration, Antenna directivity, antenna factor variation with height, antenna phase center variation, antenna frequency interpolation, measurement distance variation, site imperfection, mismatch, and system repeatability. Based on CISPR 16-4-2, the measurement uncertainty level with a 95 % confidence level was applied.

Conducted Emission measurement (Confidence level about 95 %, $k = 2$)			
Shielded Room (CE#1)	9 kHz ~ 150 kHz:	3.58 dB	
	150 kHz ~ 30 MHz:	3.16 dB	
Shielded Room (CE#2)	9 kHz ~ 150 kHz:	3.58 dB	
	150 kHz ~ 30 MHz:	3.16 dB	
Radiated Emission measurement (Confidence level about 95 %, $k = 2$)			
10 m Chamber (4F)	30 MHz ~ 300 MHz	3 m:	4.96 dB
		10 m:	4.96 dB
	300 MHz ~ 1 000 MHz	3 m:	4.08 dB
		10 m:	4.06 dB
	1 GHz ~ 6 GHz	3 m:	5.52 dB
	6 GHz ~ 18 GHz	3 m:	6.18 dB
	18 GHz ~ 30 GHz	3 m:	5.00 dB
30 GHz ~ 40 GHz	3 m:	4.50 dB	
10 m Chamber (2F)	30 MHz ~ 300 MHz	3 m:	4.50 dB
		10 m:	4.50 dB
	300 MHz ~ 1 000 MHz	3 m:	3.50 dB
		10 m:	3.48 dB
	1 GHz ~ 6 GHz	3 m:	5.04 dB
6 GHz ~ 18 GHz	3 m:	6.10 dB	

3.3 Measurement Program

These test items were performed by software programs;

Test item	Measurement Program		Used
Conducted Emission	EP5/CE_Ver 5.4.0(TOYO)		☒
Radiated Emission	2F	EP10/RE_Ver 2021.01.000 (TOYO)	☒
	4F	EP5/RE_Ver 5.11.10(TOYO)	



4. Description of EUT

4.1 General information

Declared Hardware Version	REV1.0
Declared Software Version	X308U.001



4.2 Product description

Type of product	Tablet PC
Model name (Basic)	SM-X308U
Model name (Variant)	-
Difference	-
Serial no	-
Testing voltage	120 V, 60 Hz
Input/Output rating	Adapter (EP-TA200) Input: AC 100 V - 240 V, 50-60 Hz, 0.5 A Output: DC 9.0 V, 1.67 A or DC 5.0 V, 2.0 A
Internal clock frequency	Above 108 MHz
RF Frequency	<p>NFC: 13.56 MHz Bluetooth: 2 402 MHz ~ 2 480 MHz WLAN 2.4 GHz: 2 412 MHz ~ 2 462 MHz WLAN 5.0 GHz: 5 180 MHz ~ 5 240 MHz, 5 190 MHz ~ 5 230 MHz, 5 210 MHz, 5 260 MHz ~ 5 320 MHz, 5 270 MHz ~ 5 310 MHz, 5 290 MHz, 5 500 MHz ~ 5 720 MHz, 5 510 MHz ~ 5 710 MHz, 5 530 MHz ~ 5 690 MHz, 5 745 MHz ~ 5 825 MHz, 5 755 MHz ~ 5 795 MHz, 5 775 MHz LTE Band 2: 1 850.7 MHz ~ 1 909.3 MHz LTE Band 4: 1 710.7 MHz ~ 1 754.3 MHz LTE Band 5: 824.7 MHz ~ 848.3 MHz LTE Band 7: 2 502.5 MHz ~ 2 567.5 MHz LTE Band 12: 699.7 MHz ~ 715.3 MHz LTE Band 13: 779.5 MHz ~ 784.5 MHz LTE Band 25: 1 850.7 MHz ~ 1 914.3 MHz LTE Band 26: 824.7 MHz ~ 848.3 MHz LTE Band 29: 717 MHz ~ 728 MHz LTE Band 30: 2 307.5 MHz ~ 2 312.5 MHz LTE Band 40(L): 2 307.5 MHz ~ 2 312.5 MHz LTE Band 40(U): 2 352.5 MHz ~ 2 357.5 MHz LTE Band 41: 2 498.5 MHz ~ 2 687.5 MHz LTE Band 66: 1 710.7 MHz ~ 1 779.3 MHz LTE Band 71: 665.5 MHz ~ 695.5 MHz WCDMA 850: 826.4 MHz ~ 846.6 MHz WCDMA 1700: 1 712.4 MHz ~ 1 752.6 MHz WCDMA 1900: 1 852.4 MHz ~ 1 907.6 MHz NR Band 2: 1 852.5 MHz ~ 1 907.5 MHz NR Band 5: 826.5 MHz ~ 846.5 MHz NR Band 12: 701.5 MHz ~ 713.5 MHz NR Band 25: 1 852.5 MHz ~ 1 912.5 MHz NR Band 29: 717 MHz ~ 728 MHz NR Band 30: 2 307.5 MHz ~ 2 312.5 MHz NR Band 41: 2 501.01 MHz ~ 2 685.00 MHz NR Band 48: 3 555.00 MHz ~ 3 694.98 MHz NR Band 66: 1 712.5 MHz ~ 1 777.5 MHz NR Band 71: 665.5 MHz ~ 695.5 MHz NR Band 77(L): 3 445.01 MHz ~ 3 594.99 MHz NR Band 77(U): 3 705.00 MHz ~ 3 975.00 MHz NR Band 77(IC): 3 455.01 MHz ~ 3 894.99 MHz NR Band 78(L): 3 455.01 MHz ~ 3 544.98 MHz NR Band 78(IC): 3 455.01 MHz ~ 3 795.00 MHz Digitizer: 531.25 kHz ~ 593.75 kHz</p>

	<p>LTE ULCA 41C: 2 499.3 MHz ~ 2 680.0 MHz, 2 506.0 MHz ~ 2 686.7 MHz, 2 501.3 MHz ~ 2 682.5 MHz, 2 503.5 MHz ~ 2 684.7 MHz, 2 501.5 MHz ~ 2 680.0 MHz, 2 506.0 MHz ~ 2 684.5 MHz, 2 503.5 MHz ~ 2 682.5 MHz, 2 503.8 MHz ~ 2 680.0 MHz, 2 506.0 MHz ~ 2 682.2 MHz, 2 506.0 MHz ~ 2 680.0 MHz LTE ULCA 48C: 3 553.3 MHz ~ 3 690.0 MHz, 3 560.0 MHz ~ 3 696.7 MHz, 3 555.5 MHz ~ 3 690.0 MHz, 3 560.0 MHz ~ 3 694.5 MHz, 3 557.8 MHz ~ 3 690.0 MHz, 3 560.0 MHz ~ 3 692.2 MHz, 3 560.0 MHz ~ 3 690.0 MHz</p>
<p>Note</p>	<p>-The following accessories were provided by the manufacturer. 1) Adapter (EP-TA200 / SAMSUNG) 2) USB Cable 3) S-Pen</p>

4.3 Auxiliary equipments

Type	Model / Part #	S/N	Manufacturer	SDoC & FCC ID
USIM Card	-	-	-	-
Micro SD Card (64 GB)	Samsung EVO Plus MB-MB64G	-	SAMSUNG	-
Wideband Radio Communication Tester	CMW500	-	R&S	-
Spiral ANT	PSA 75301R/170	-	Cobham	-

4.4 Test configuration

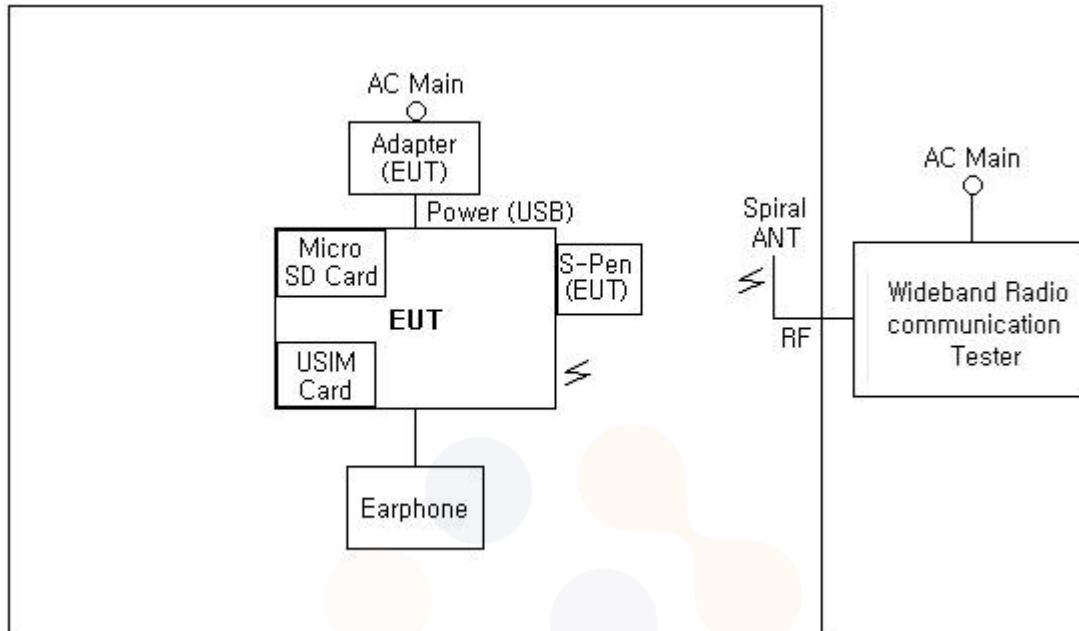

	Start		End		Cable	
	Name	I/O port	Name	I/O port	Length (m)	Spec.
1	EUT	Power (USB)	Adapter (EUT)	-	1.0	Unshield
2		USIM	USIM Card	-	Direct	-
3		Micro SD	Micro SD Card	-	Direct	-
4		-	S-Pen(EUT)	-	Direct	-
5		Audio Out	Earphone	-	1.5	Unshield
6	Adapter (EUT)	Power	AC Main	-	Direct	-
7	Wideband Radio Communication Tester	RF	Spiral ANT	-	2.0	Shield

4.5 Operating conditions

The EUT was configured as normal intended use.

Test mode	Normal operating
Test #1	Charging(w/TA) + Cellular receiver (LTE Band 13_Mid channel)

Note 1. All cellular RX bands operating below 960 MHz, including WCDMA, LTE, 5G NR, ULCA, SRS have been investigated with low/middle/high channels. Among the bands, LTE Band 13_Mid channel is the worst mode.

Note 2. It means this device needs to be tested with 3 orientations (x, y and z) and at least the worst case orientation shall be set for final test.

It was determined that Z orientation was worst-case orientation. Therefore, all final radiated testing was performed with the EUT in Z orientation.

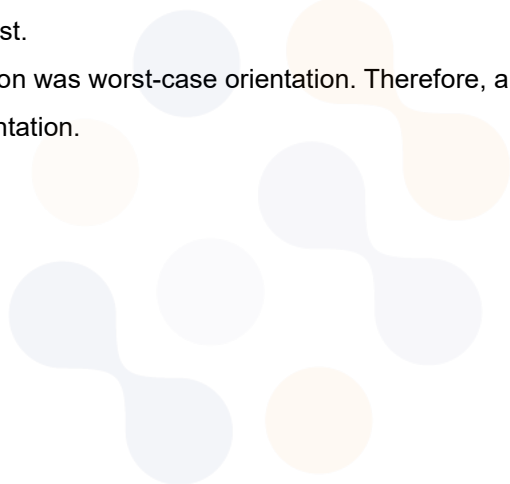

5. Summary of test results

5.1 Summary of EMI emission test results

Applied	Test items	Test method	Result
<input checked="" type="checkbox"/>	Conducted Emission	ANSI C63.4:2014, Class B FCC Part 15 Subpart B	Pass
<input checked="" type="checkbox"/>	Radiated Emission	ANSI C63.4:2014, Class B FCC Part 15 Subpart B	Pass



6. Test results

6.1 Conducted Emissions

Testing voltage	120 V, 60 Hz		
Test facility	Shielded room (CE#1)		
Date	2023-11-20		
Temperature (°C)	24.1 °C	Humidity (% R.H.)	36.3 % R.H.
Remarks	Pass		

6.1.1 Limits of conducted emissions measurement

Frequency [MHz]	Class A (dB(μ V))		Class B (dB(μ V))	
	Quasi-peak	Average	Quasi-peak	Average
0.15 ~ 0.5	79	66	66 ~ 56 ¹⁾	56 ~ 46 ¹⁾
0.5 ~ 5	73	60	56	46
5 ~ 30	73	60	60	50

¹⁾ The limit decreases linearly with the logarithm of frequency

6.1.2 Measurement procedure

The measurements were performed in a shielded room. EUT was setup as shown in photograph and placed on a non-metallic table height of 0.8 m above the reference ground plane. The rear of table was located 0.4 m to the vertical conducted plane. EUT was power through the LISN, which was bonded to the ground plane. The LISN power was filtered. Each EUT power lead, except ground (safety) lead was individually connected through a LISN to input power source. EUT signal cables that hung closer than 0.4 m to the Horizontal metal ground 0.3 m ~ 0.4 m long. The power cord was bundles in the center. All peripheral equipment was powered from a sub LISN. The LISN and ISN were positioned 0.8 m from the EUT. Peak and Average detection were used in preliminary testing and Quasi-peak and Average detections were used at final measurement.

6.1.3 Used equipments

Equipment	Model no.	Serial no.	Makers	Next Cal. Date	Used
EMI TEST RECEIVER	ESCI 3	101408	R&S	2024.08.18	<input checked="" type="checkbox"/>
TWO-LINE V-NETWORK	ENV216	101358	R&S	2024.09.27	<input checked="" type="checkbox"/>
TWO-LINE V-NETWORK	ENV216	101352	R&S	2024.03.28	<input type="checkbox"/>

6.1.4 Conducted emissions measurement result

AC Main

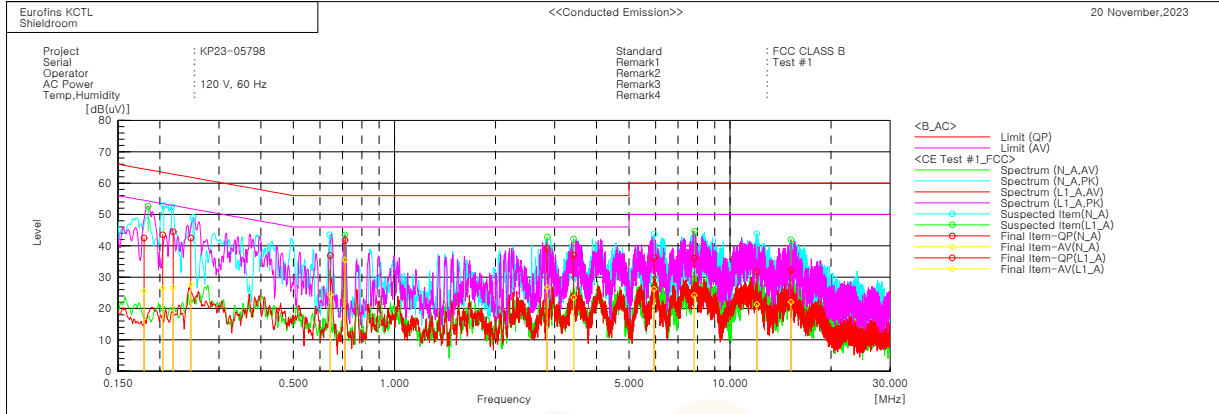

Final Result

--- N_A Phase ---										
No.	Frequency [MHz]	Reading QP [dB(uV)]	Reading CAV [dB(uV)]	c. f [dB]	Result QP [dB(uV)]	Result CAV [dB(uV)]	Limit QP [dB(uV)]	Limit AV [dB(uV)]	Margin QP [dB]	Margin CAV [dB]
1	0.20378	33.5	16.4	10.0	43.5	26.4	63.5	53.5	20.0	27.1
2	0.2191	34.7	16.9	9.8	44.5	26.7	62.9	52.9	18.4	26.2
3	0.24702	32.8	17.9	9.7	42.5	27.6	61.9	51.9	19.4	24.3
4	0.6435	27.0	14.5	9.9	36.9	24.4	56.0	46.0	19.1	21.6
5	5.93726	26.3	16.3	9.9	36.2	26.2	60.0	50.0	23.8	23.8
6	12.01267	21.2	10.8	10.5	31.7	21.3	60.0	50.0	28.3	28.7

--- L1_A Phase ---										
No.	Frequency [MHz]	Reading QP [dB(uV)]	Reading CAV [dB(uV)]	c. f [dB]	Result QP [dB(uV)]	Result CAV [dB(uV)]	Limit QP [dB(uV)]	Limit AV [dB(uV)]	Margin QP [dB]	Margin CAV [dB]
1	0.17951	32.3	15.3	10.2	42.5	25.5	64.5	54.5	22.0	29.0
2	0.712	31.9	25.5	9.9	41.8	35.4	56.0	46.0	14.2	10.6
3	2.85066	29.3	16.9	9.8	39.1	26.7	56.0	46.0	16.9	19.3
4	3.42014	27.2	13.7	9.8	37.0	23.5	56.0	46.0	19.0	22.5
5	7.82991	26.0	14.2	10.0	36.0	24.2	60.0	50.0	24.0	25.8
6	15.18988	21.3	11.3	10.8	32.1	22.1	60.0	50.0	27.9	27.9

6.2 Radiated Emission

Testing voltage		120 V, 60 Hz		
Test facility		10 m Chamber (4F)		
Test distance		3 m		
Date		2023-11-21		
30 MHz ~ 1 GHz	Temperature (°C)	24.3 °C	Humidity (% R.H.)	35.3 % R.H.
1 GHz ~ 30 GHz		24.4 °C		35.5 % R.H.
Remarks		Pass		

6.2.1 Limits of radiated emission measurement

Frequency [MHz]	Class A at 10 m QP(dB(μV/m))		Class B at 3 m QP(dB(μV/m))	
	FCC ¹⁾	ISED (ICES Issue 7)	FCC ¹⁾	ISED (ICES Issue 7)
30-88	39.1	40.0	40.0	40.0
88-216	43.5	43.5	43.5	43.5
216-230	46.4	46.4	46.0	46.0
230-960	46.4	47.0	46.0	47.0
Above 960	49.5	49.5	54.0	54.0

- ¹⁾: Alternative standard: CISPR, Pub. 22

- Test data in this section has been taken against the FCC 15.109(a) or (B) Limit as it is the most stringent limit.

By complying with more restrictive FCC 15.109 Limit compliance with the ICES-003 Issue 7 limit also demonstrated.

6.2.2 Measurement procedure

The test was done at a 10 m chamber with a quasi-peak detector. EUT was placed on a non-metallic table height of 0.8 m above the reference ground plane. Cables were folded back and forth forming a bundle 0.3 m to 0.4 m long and were hanged at a 0.4 m height to the ground plane.

Cables connected to EUT were fixed to cause maximum emission. Test was made with the antenna positioned in both the horizontal and vertical planes of polarization. The measurement antenna was varied in height above the conducting ground plane to obtain the maximum signal strength.

6.2.3 Used equipments

Equipment	Model no.	Serial no.	Makers	Next Cal. Date	Used
EMI TEST RECEIVER	ESCI 7	100872	R&S	2024.01.18	<input checked="" type="checkbox"/>
Bilog Antenna	CBL 6112D	37876	TESEQ	2025.05.25	<input checked="" type="checkbox"/>
AMPLIFIER	310N	293004	SONOMA	2024.08.18	<input checked="" type="checkbox"/>
ATTENUATOR	8491B	MY39270292	AGILENT	-	<input checked="" type="checkbox"/>
Antenna Mast	MA4640-XP-ET	-	Innco Systems	-	<input checked="" type="checkbox"/>
Turn Table	DT3000-2t	-	Innco Systems	-	<input checked="" type="checkbox"/>
DOUBLE RIDGED HORN ANTENNA	3117	00161083	ETS-LINDGREN	2024.01.27	<input checked="" type="checkbox"/>
AMPLIFIER	BBV9718C	00138	SCHWARZBECK	2024.10.13	<input checked="" type="checkbox"/>
Horn Antenna	3116C	00218560	ETS-LINDGREN	2024.03.27	<input checked="" type="checkbox"/>
Amplifier	JS44-18004000-33-8P	2055879	L-3 Narda-MITEQ	2024.03.28	<input checked="" type="checkbox"/>
UXA SIGNAL ANALYZER	N9040B	US55230151	KEYSIGHT	2024.07.03	<input checked="" type="checkbox"/>

6.2.4 Sample calculation

The field strength is calculated adding the antenna Factor, cable loss and, Antenna pad adding, subtracting the amplifier gain from the measured reading.

The sample calculation is as follow:

$$\text{Result} = \text{M.R} + \text{C.F}(\text{A.F} + \text{C.L} + 6 \text{ dB Att} - \text{A.G})$$

M.R = Meter Reading

C.F = Correction Factor

A.F = Antenna Factor

C.L = Cable Loss

A.G = Amplifier Gain

6 dB Att = 6 dB Attenuator

If M.R is 30 dB, A.F 12 dB, C.L 5 dB, 6 dB, A.G 35 dB

The result is $30 + 12 + 5 + 6 - 35 = 18 \text{ dB } (\mu\text{V/m})$

Bilog Antenna and ATTENUATOR (6 dB) were calibrated together.

AV = CAV : Abbreviation of CISPR Average

6.2.5 Radiated emission measurement result

30 MHz ~ 1 GHz

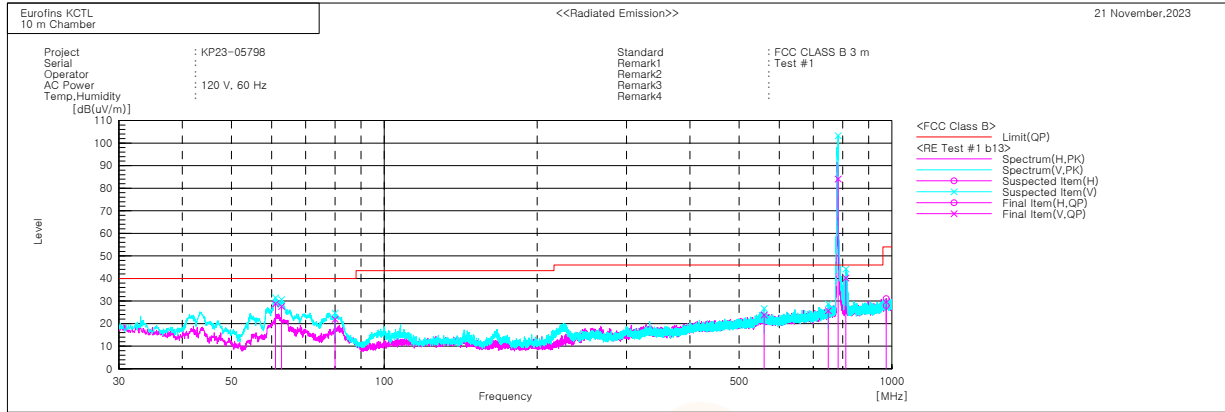

Final Result

No.	Frequency [MHz]	(P)	Reading QP [dB(uV)]	c.f [dB(1/m)]	Result QP [dB(uV/m)]	Limit QP [dB(uV/m)]	Margin QP [dB]	Height [cm]	Angle [deg]
1	61.042	V	45.3	-16.5	28.8	40.0	11.2	100.0	294.8
2	62.739	V	44.1	-16.5	27.6	40.0	12.4	193.0	288.0
3	79.958	V	38.1	-16.2	21.9	40.0	18.1	241.0	47.0
4	559.986	V	20.7	3.1	23.8	46.0	22.2	306.0	183.0
5	749.388	V	18.8	6.9	25.7	46.0	20.3	109.0	224.0
6	783.534	V	76.2	7.9	84.1	46.0	-38.1	383.0	153.0
7	811.520	V	32.2	8.0	40.2	46.0	5.8	122.0	18.0
8	974.536	H	15.8	12.2	28.0	54.0	26.0	400.0	7.0

No. 6 is the fundamental frequency. (783.534 MHz_LTE Band 13)

1 GHz ~ 18 GHz

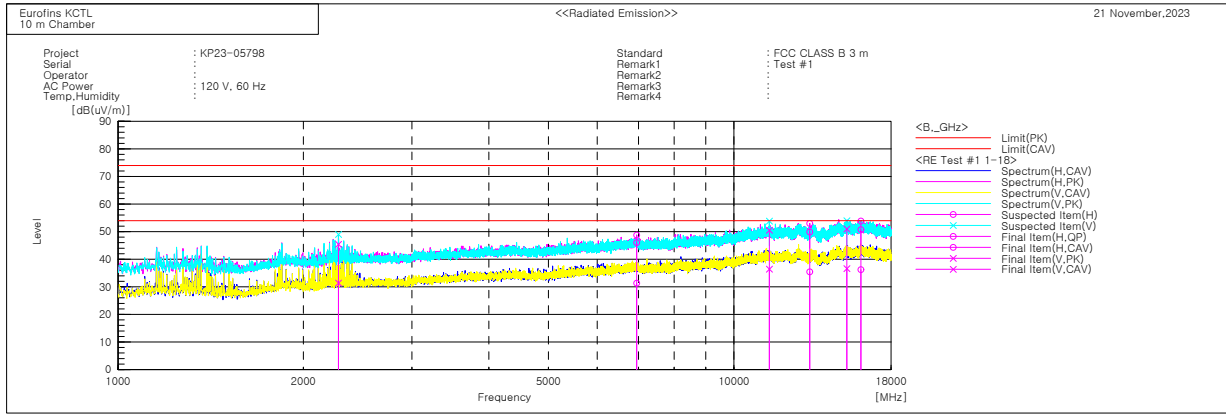

Final Result

No.	Frequency [MHz]	(P)	Reading PK [dB(uV)]	Reading CAV [dB(uV)]	c.f [dB(1/m)]	Result PK [dB(uV/m)]	Result CAV [dB(uV/m)]	Limit PK [dB(uV/m)]	Limit AV [dB(uV/m)]	Margin PK [dB]	Margin CAV [dB]	Height [cm]	Angle [deg]
1	2280.164	V	45.3	31.3	0.1	45.4	31.4	74.0	54.0	28.6	22.6	172.0	144.0
2	6951.997	H	35.0	20.3	11.0	46.0	31.3	74.0	54.0	28.0	22.7	389.0	122.0
3	11418.120	V	35.2	21.1	15.3	50.5	36.4	74.0	54.0	23.5	17.6	307.0	142.0
4	13277.160	H	33.9	19.4	16.0	49.9	35.4	74.0	54.0	24.1	18.6	189.0	13.0
5	15259.450	V	33.8	19.4	17.2	51.0	36.6	74.0	54.0	23.0	17.4	211.0	142.0
6	16078.050	H	33.2	18.7	17.5	50.7	36.2	74.0	54.0	23.3	17.8	107.0	267.0

18 GHz ~ 30 GHz

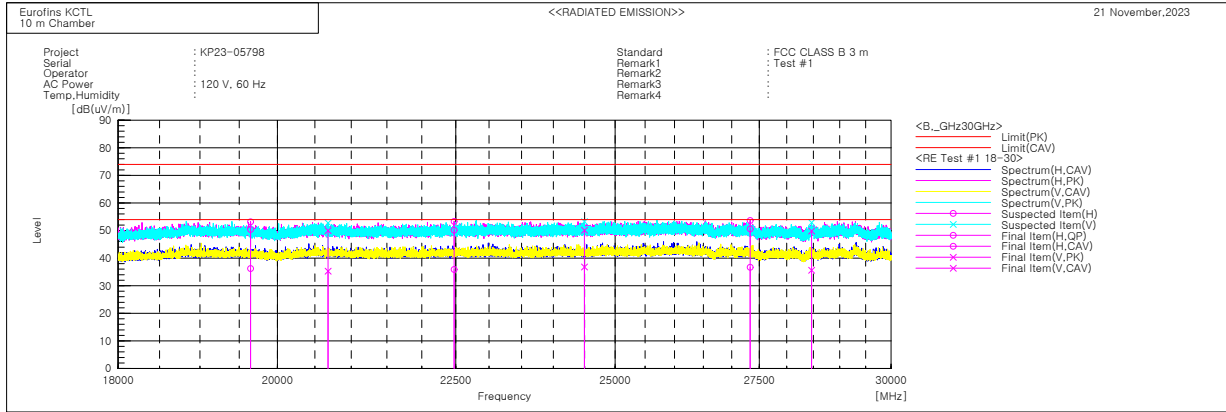

Final Result

No.	Frequency [MHz]	(P)	Reading PK [dB(uV)]	Reading CAV [dB(uV)]	c.f [dB(1/m)]	Result PK [dB(uV/m)]	Result CAV [dB(uV/m)]	Limit PK [dB(uV/m)]	Limit AV [dB(uV/m)]	Margin PK [dB]	Margin CAV [dB]	Height [cm]	Angle [deg]
1	19646.480	H	46.8	32.6	3.6	50.4	36.2	74.0	54.0	23.6	17.8	186.0	88.0
2	20678.530	V	45.4	30.7	4.6	50.0	35.3	74.0	54.0	24.0	18.7	114.0	123.0
3	22475.620	H	44.1	29.8	6.0	50.1	35.9	74.0	54.0	23.9	18.1	307.0	54.0
4	24496.520	V	43.1	29.8	7.0	50.1	36.8	74.0	54.0	23.9	17.2	221.0	11.0
5	27332.270	H	42.5	28.6	8.1	50.6	36.7	74.0	54.0	23.4	17.3	400.0	5.0
6	28466.320	V	42.8	28.5	7.1	49.9	35.6	74.0	54.0	24.1	18.4	294.0	140.0