

SGS

Internal photos of EUT

Internal view of EUT



Top view of Main PCB

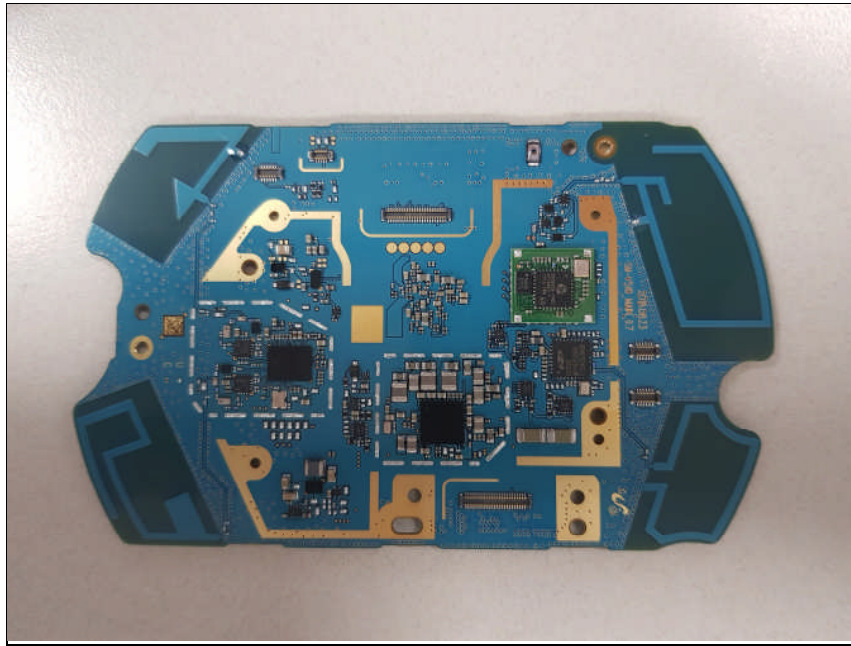

Bottom view of Main PCB

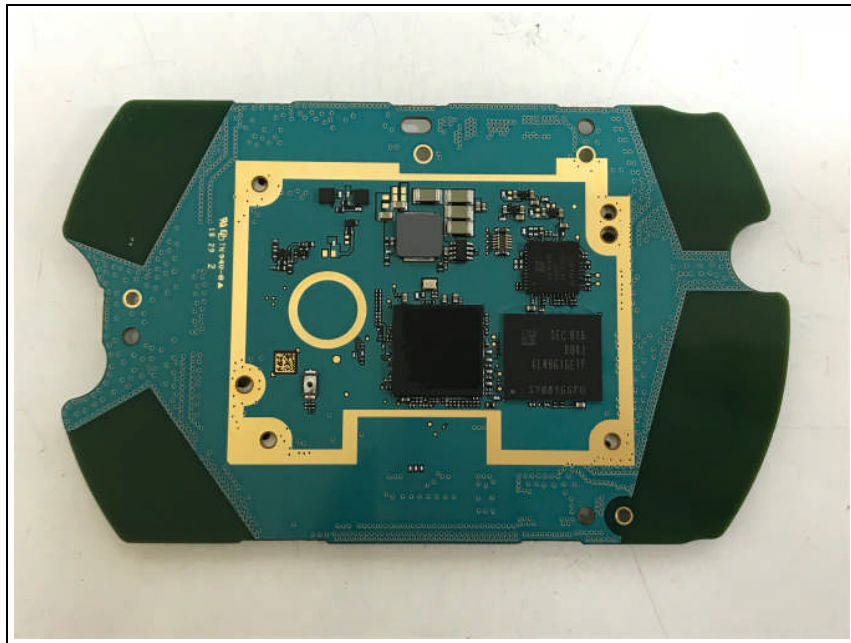

Top view of Sub PCB1

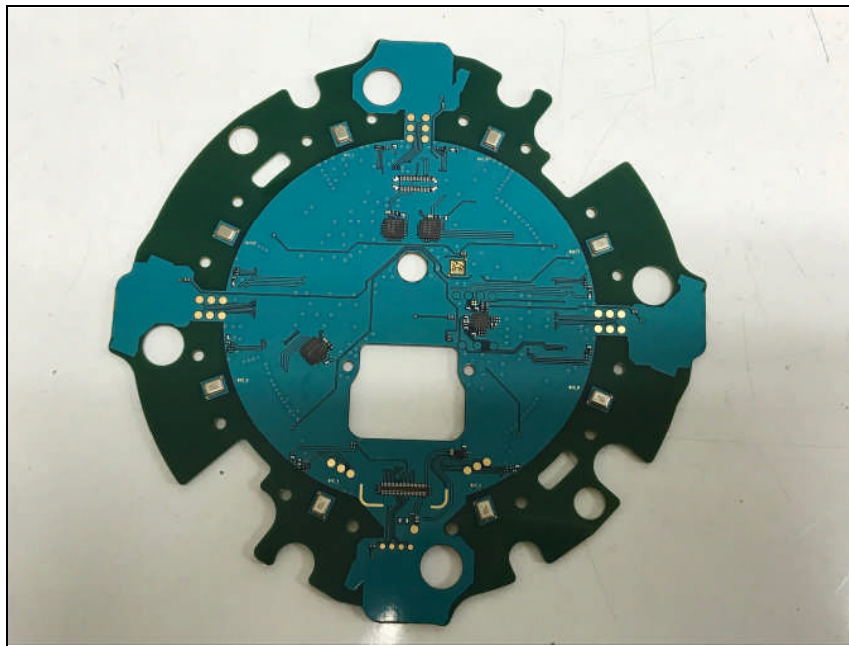

Bottom view of Sub PCB1

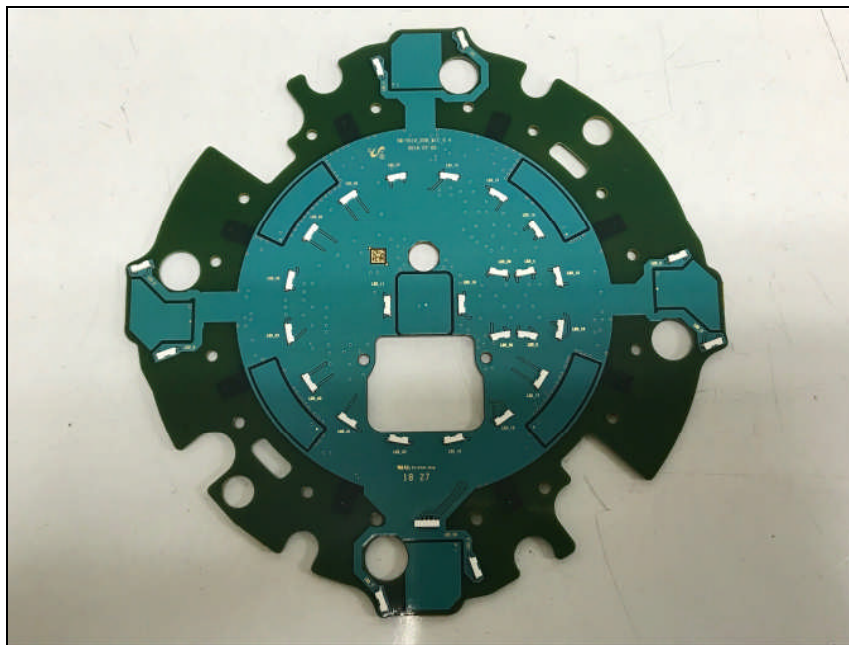

Top view of Sub PCB2

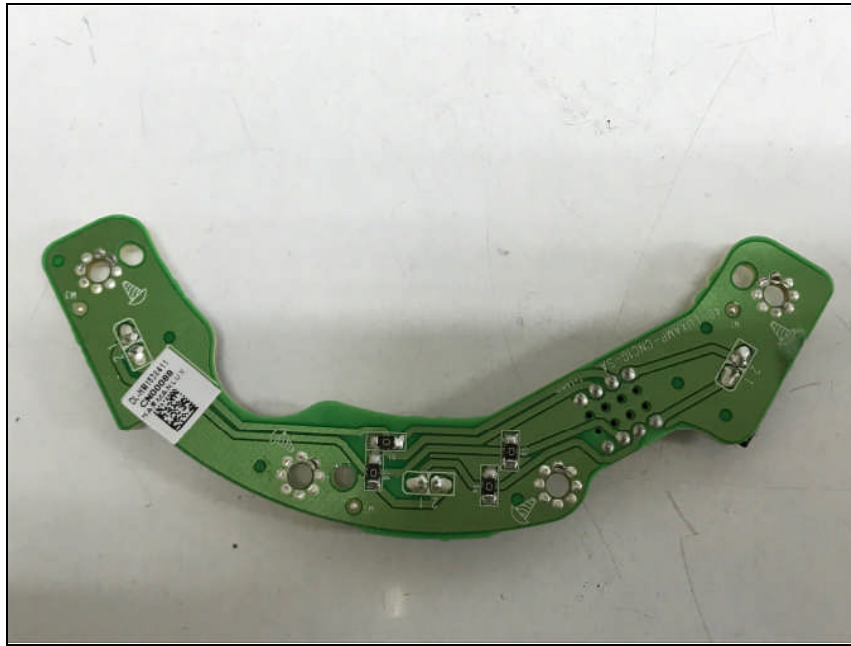

Bottom view of Sub PCB2

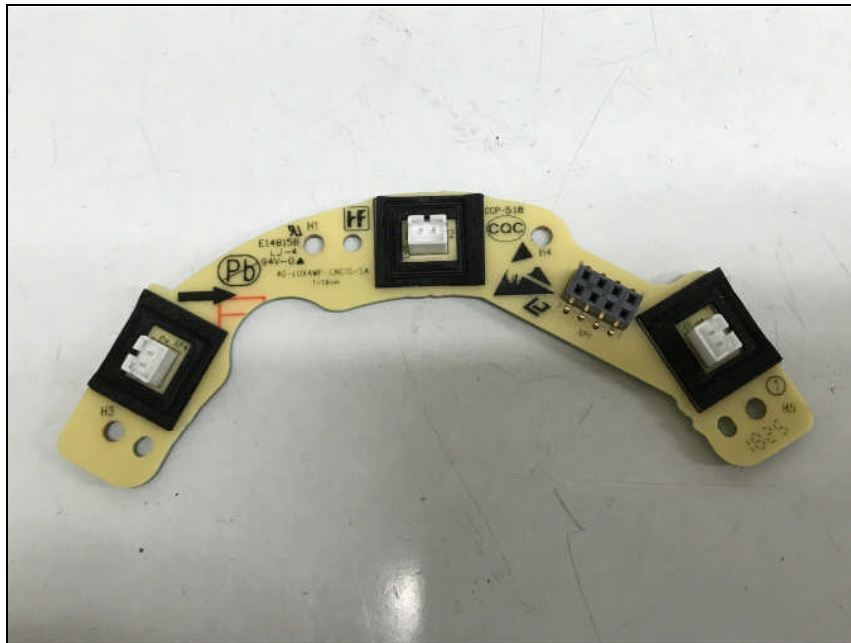

Top view of Sub PCB3

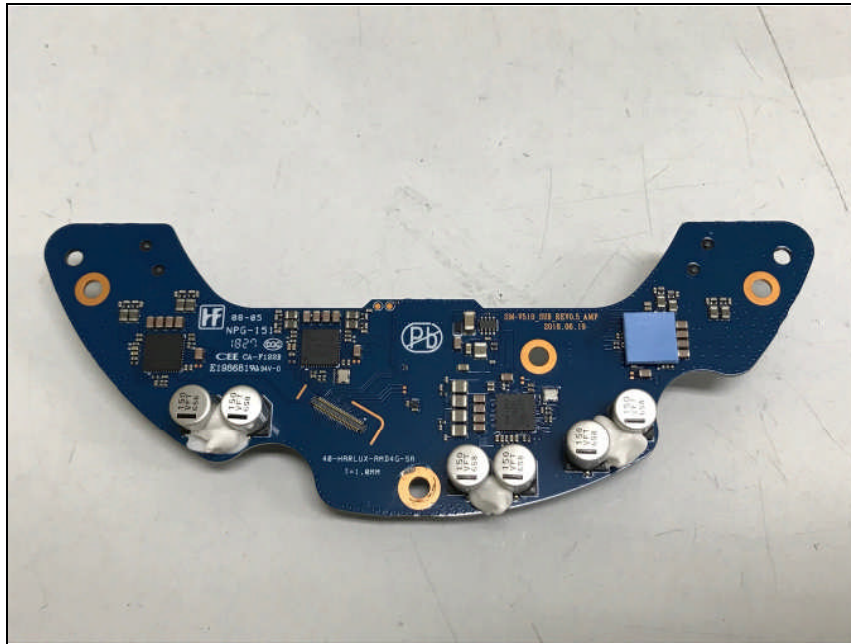

Bottom view of Sub PCB3

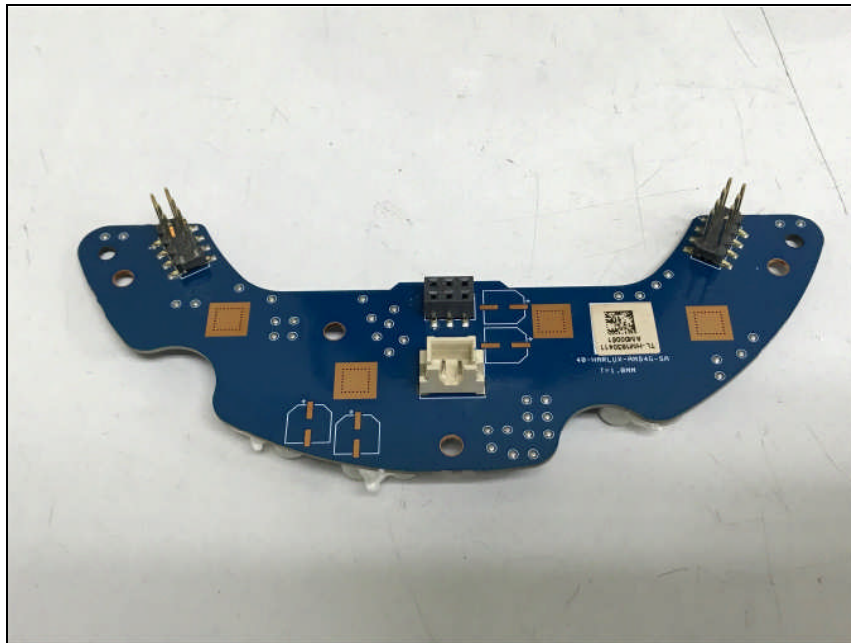

Top view of Sub PCB4

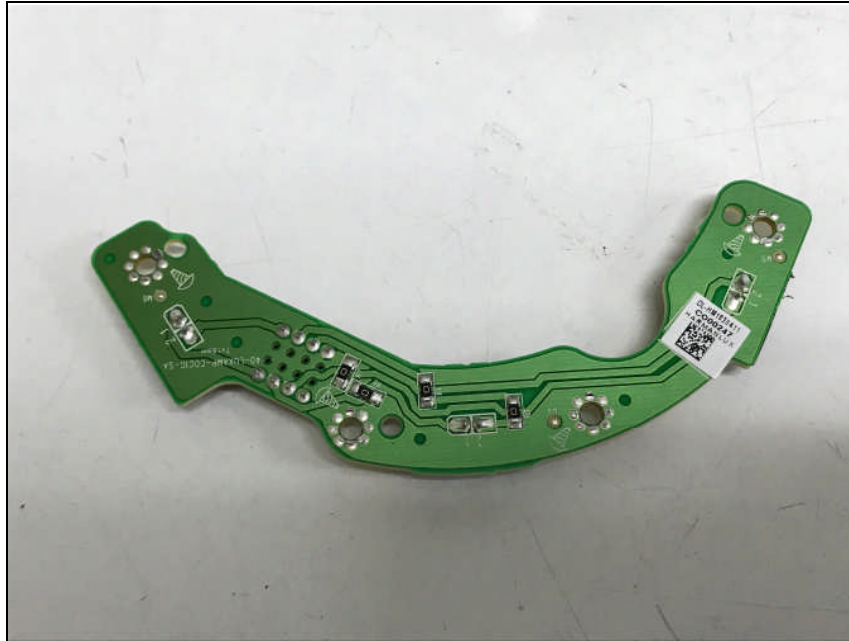

Bottom view of Sub PCB4

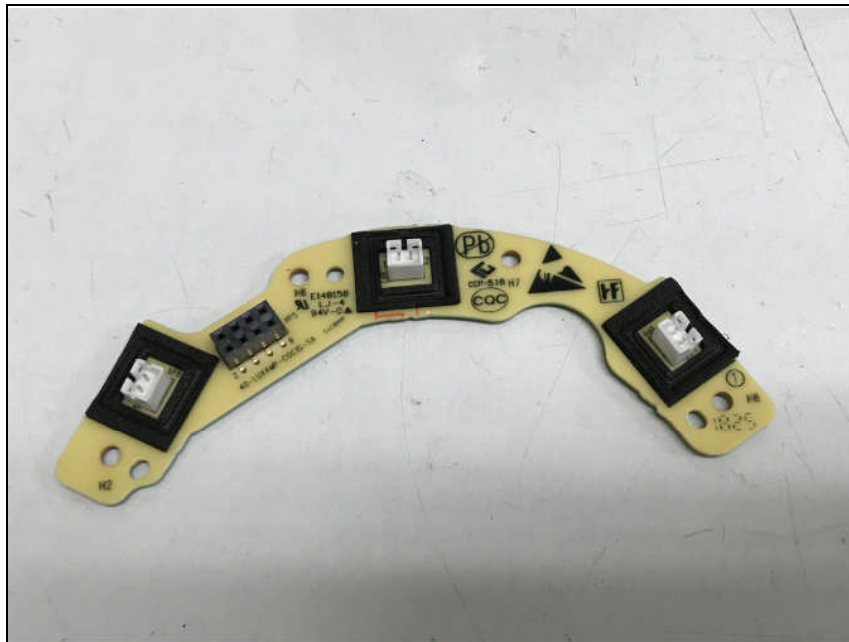

View of Bluetooth module

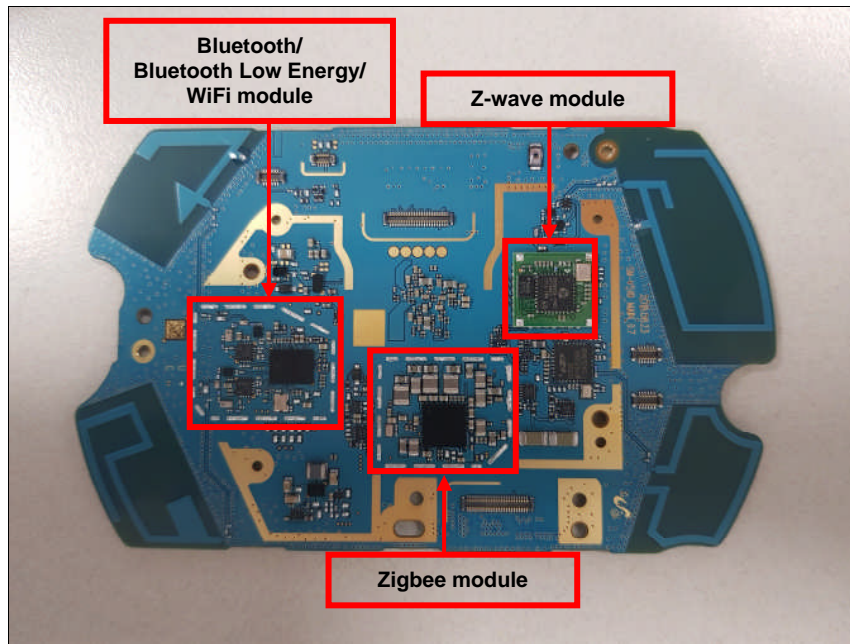

View of antenna (Pattern embedded antenna)

