



PCTEST
 7185 Oakland Mills Road, Columbia, MD 21046 USA
 Tel. +1.410.290.6652 / Fax +1.410.290.6654
 http://www.pctest.com



NEAR-FIELD POWER DENSITY EVALUATION REPORT

Applicant Name

Samsung Electronics Co., Ltd.
 129, Samsung-ro, Maetan dong,
 Yeongtong-gu, Suwon-si
 Gyeonggi-do, 16677, Korea

Date of Testing

06/03/2020 - 07/15/2020

Test Site/Location

PCTEST, Columbia, MD, USA

Document Serial No:

1M2004230075-24-R2.A3L

FCC ID:

A3LSMT978U

APPLICANT:

SAMSUNG ELECTRONICS CO., LTD.

DUT Type:

Portable Tablet

Application Type:

Certification

FCC Rule Part(s):

CFR §2.1093

Model:

SM-T978U

Band & Mode	Tx Frequency	Measured psPD	Reported psPD
	MHz	mW/cm ²	mW/cm ²
5G NR - n261	27500 - 28350	0.660	0.750
5G NR - n260	37000 - 40000	0.692	0.750
Total Exposure Ratio		0.969	
Verdict		PASS	

Note: This revised Test Report (S/N: 1M2004230075-24-R2.A3L) supersedes and replaces the previously issued test report on the same subject device for the same type of testing as indicated. Please discard or destroy the previously issued test report(s) and dispose of it accordingly.

I attest to the accuracy of data. All measurements reported herein were performed by me or were made under my supervision and are correct to the best of my knowledge and belief. I assume full responsibility for the completeness of these measurements and vouch for the qualifications of all persons taking them. Test results reported herein relate only to the item(s) tested.

 Randy Ortanez
 President





FCC ID: A3LSMT978U		NEAR-FIELD POWER DENSITY EVALUATION REPORT		Approved by: Quality Manager
Document S/N: 1M2004230075-24-R2.A3L	Test Dates: 06/03/2020 - 07/15/2020	DUT Type: Portable Tablet	Page 1 of 21	

TABLE OF CONTENTS

1	DEVICE UNDER TEST	3
1.1	Device Overview	3
1.2	Time-Averaging Algorithm for RF Exposure Compliance	3
1.3	Input Power Specifications	4
1.4	DUT Antenna Locations	8
1.5	Simultaneous Transmission Capabilities	9
1.6	Guidance Applied	9
1.7	Bibliography	9
2	MEASUREMENT SYSTEM	10
2.1	Measurement Setup	10
2.2	SPEAG EUmmWV3 Probe / E-Field 5G Probe	10
2.3	Peak Spatially Averaged Power Density Assessment Based on E-field Measurements	11
2.4	Reconstruction Algorithm	11
3	RF EXPOSURE LIMITS FOR POWER DENSITY	12
3.1	Uncontrolled Environment	12
3.2	Controlled Environment	12
3.3	RF Exposure Limits for Frequencies Above 6 GHz	12
4	SYSTEM VERIFICATION	13
4.1	Test System Verification	13
5	POWER DENSITY DATA @ INPUT.POWER.LIMIT	15
5.1	Power Density Results	15
5.2	Power Density Test Notes	17
6	EQUIPMENT LIST	18
7	MEASUREMENT UNCERTAINTIES	19
8	CONCLUSION	20
8.1	Measurement Conclusion	20
9	REFERENCES	21



APPENDIX A: POWER DENSITY TEST PLOTS

APPENDIX B: SYSTEM VERIFICATION PLOTS

APPENDIX C: TOTAL EXPOSURE RATIO

APPENDIX D: DUT ANTENNA DIAGRAM AND TEST SETUP PHOTOGRAPHS

APPENDIX E: PROBE AND VERIFICATION SOURCE CALIBRATION CERTIFICATES

FCC ID: A3LSMT978U	 PCTEST <small>Proud to be part of Samsung</small>	NEAR-FIELD POWER DENSITY EVALUATION REPORT		Approved by: Quality Manager
Document S/N: 1M2004230075-24-R2.A3L	Test Dates: 06/03/2020 - 07/15/2020	DUT Type: Portable Tablet	Page 2 of 21	

1 DEVICE UNDER TEST

1.1 Device Overview

NR FR2 Operations Information						
Form Factor	Portable Handset					
Channel Bandwidths per NR Band	NR Band n261: 50MHz, 100MHz					
Channel Bandwidths per NR Band	NR Band n260: 50MHz, 100MHz					
Channel Numbers and Frequencies	Low		Mid		High	
	Channel	Frequency (MHz)	Channel	Frequency (MHz)	Channel	Frequency (MHz)
NR Band n261: 50MHz BW	2071249	27525.00	2077915	27924.96	2084581	28324.92
NR Band n261: 100MHz BW	2071665	27549.96	2077915	27924.96	2084165	28299.96
NR Band n260: 50MHz BW	2229599	37026.00	2254165	38499.96	2278749	39975.00
NR Band n260: 100MHz BW	2229999	37050.00	2254165	38499.96	2278315	39949.00
Subcarrier Spacing (kHz)	120					
Total Number of Supported Uplink CCs (SISO)	2					
Total Number of Supported Uplink CCs (MIMO)	2 (CP-OFDM only)					
Total Number of Supported DL CCs	8					
Modulations Supported in UL	CP-OFDM: QPSK, 16QAM, 64QAM DFT-s-OFDM: PI/2 BPSK, QPSK, 16QAM, 64QAM					
LTE Anchor Bands (n261)	2, 5, 12, 13, 66					
LTE Anchor Bands (n260)	2, 5, 12, 13, 66					
Duplex Type (mmWave)	TDD					



1.2 Time-Averaging Algorithm for RF Exposure Compliance

The equipment under test (EUT) contains Qualcomm® SDX55M modem supporting 2G/3G/4G/5G NR WWAN 5G technologies and is enabled with Qualcomm® Smart Transmit feature. This feature performs time averaging algorithm in real time to control and manage transmitting power and ensure the time-averaged RF exposure is in compliance with FCC requirements all the time. Refer to Compliance Summary document for detailed description of Qualcomm® Smart Transmit. Note that WLAN operations are not enabled with Smart Transmit.

The Smart Transmit algorithm maintains the time-averaged transmit power, in turn, time-averaged RF exposure of *SAR_{design target}* or *PD_{design target}*, below the predefined time-averaged power limit (i.e., P_{limit} for sub-6 radio, and *input.power.limit* for 5G mmW NR), for each characterized technology and band (see RF Exposure Part 0 Test Report).

Smart Transmit allows the device to transmit at higher power instantaneously when needed, but manages power limiting to maintain time-averaged transmit power to *input.power.limit*.

The purpose of this report (Part 1 test) is to demonstrate that the EUT meets FCC PD limits when transmitting in static transmission scenario at maximum allowable time-averaged power level given by *input.power.limit*.



FCC ID: A3LSMT978U	 PCTEST Proud to be part of 	NEAR-FIELD POWER DENSITY EVALUATION REPORT		Approved by: Quality Manager
Document S/N: 1M2004230075-24-R2.A3L	Test Dates: 06/03/2020 - 07/15/2020	DUT Type: Portable Tablet	Page 3 of 21	

1.3 Input Power Specifications

All power density measurements for this device were performed at the *input.power.limit* given in below tables. Input power is per antenna element and polarization for each antenna module. When input.power.limit is calculated to be above the maximum input power, the device is limited to the maximum input power.



Table 1-1
5G mmWave NR Band n261 Antenna 0

Band	V Beam ID	H Beam ID	input.power.limit (dBm)
n261	0		9.5
n261	2		7.0
n261	3		7.3
n261	4		7.4
n261	8		7.0
n261	9		7.5
n261	12		3.8
n261	13		3.7
n261	14		3.8
n261	15		5.0
n261	16		5.5
n261	22		3.8
n261	23		4.4
n261	24		4.0
n261	25		6.1
n261		128	11.3
n261		130	6.2
n261		131	6.5
n261		132	7.7
n261		136	6.3
n261		137	6.4
n261		140	3.6
n261		141	4.7
n261		142	4.6
n261		143	4.0
n261		144	4.0
n261		150	3.6
n261		151	5.6
n261		152	4.0
n261		153	4.6
n261	0	128	7.2
n261	2	130	4.0
n261	3	131	3.5
n261	4	132	6.1
n261	8	136	3.4
n261	9	137	3.3
n261	12	140	0.9
n261	13	141	0.9
n261	14	142	1.0
n261	15	143	1.2
n261	16	144	0.9
n261	22	150	0.7
n261	23	151	1.5
n261	24	152	0.7
n261	25	153	1.2

FCC ID: A3LSMT978U	 PCTEST <small>Proud to be part of Samsung</small>	NEAR-FIELD POWER DENSITY EVALUATION REPORT		Approved by: Quality Manager
Document S/N: 1M2004230075-24-R2.A3L	Test Dates: 06/03/2020 - 07/15/2020	DUT Type: Portable Tablet	Page 4 of 21	



**Table 1-2
5G mmWave NR Band n261 Antenna 1**

Band	V Beam ID	H Beam ID	input.power.limit (dBm)
n261	1		9.0
n261	5		6.5
n261	6		6.5
n261	7		6.0
n261	10		6.8
n261	11		6.1
n261	17		3.5
n261	18		3.7
n261	19		3.5
n261	20		3.8
n261	21		4.4
n261	26		3.8
n261	27		3.5
n261	28		3.5
n261	29		4.0
n261		129	9.1
n261		133	5.7
n261		134	5.6
n261		135	5.2
n261		138	6.1
n261		139	4.9
n261		145	3.7
n261		146	3.8
n261		147	3.2
n261		148	3.1
n261		149	2.7
n261		154	4.1
n261		155	3.5
n261		156	3.2
n261		157	3.1
n261	1	129	7.7
n261	5	133	1.7
n261	6	134	1.9
n261	7	135	1.4
n261	10	138	2.1
n261	11	139	1.4
n261	17	145	-0.2
n261	18	146	-0.6
n261	19	147	-0.3
n261	20	148	-0.5
n261	21	149	-1.4
n261	26	154	-0.3
n261	27	155	-0.4
n261	28	156	-0.4
n261	29	157	-0.8

FCC ID: A3LSMT978U	 NEAR-FIELD POWER DENSITY EVALUATION REPORT		Approved by: Quality Manager
Document S/N: 1M2004230075-24-R2.A3L	Test Dates: 06/03/2020 - 07/15/2020	DUT Type: Portable Tablet	Page 5 of 21



**Table 1-3
5G mmWave NR Band n260 Antenna 0**

Band	V Beam ID	H Beam ID	input.power.limit (dBm)
n260	0		10.4
n260	2		6.5
n260	3		8.0
n260	4		6.5
n260	8		7.0
n260	9		7.0
n260	12		4.1
n260	13		4.4
n260	14		6.0
n260	15		5.2
n260	16		4.1
n260	22		4.2
n260	23		5.2
n260	24		5.6
n260	25		4.5
n260		128	10.0
n260		130	6.3
n260		131	7.6
n260		132	6.5
n260		136	6.8
n260		137	7.1
n260		140	4.0
n260		141	4.4
n260		142	5.8
n260		143	5.5
n260		144	4.0
n260		150	3.9
n260		151	5.0
n260		152	6.0
n260		153	4.9
n260	0	128	6.9
n260	2	130	2.9
n260	3	131	4.7
n260	4	132	4.4
n260	8	136	3.7
n260	9	137	3.5
n260	12	140	0.7
n260	13	141	1.1
n260	14	142	2.8
n260	15	143	1.8
n260	16	144	0.9
n260	22	150	0.6
n260	23	151	2.0
n260	24	152	2.3
n260	25	153	1.5

FCC ID: A3LSMT978U	 NEAR-FIELD POWER DENSITY EVALUATION REPORT		Approved by: Quality Manager
Document S/N: 1M2004230075-24-R2.A3L	Test Dates: 06/03/2020 - 07/15/2020	DUT Type: Portable Tablet	Page 6 of 21

**Table 1-4
5G mmWave NR Band n260 Antenna 1**

Band	V Beam ID	H Beam ID	input.power.limit (dBm)
n260	1		8.0
n260	5		6.2
n260	6		6.5
n260	7		6.2
n260	10		5.5
n260	11		6.9
n260	17		3.8
n260	18		2.9
n260	19		4.5
n260	20		4.1
n260	21		3.7
n260	26		3.3
n260	27		3.6
n260	28		4.3
n260	29		3.9
n260		129	8.7
n260		133	5.3
n260		134	6.5
n260		135	5.3
n260		138	5.6
n260		139	5.5
n260		145	3.2
n260		146	3.7
n260		147	4.4
n260		148	3.8
n260		149	3.3
n260		154	3.5
n260		155	4.3
n260		156	3.9
n260		157	3.4
n260	1	129	5.2
n260	5	133	2.4
n260	6	134	3.1
n260	7	135	2.4
n260	10	138	3.8
n260	11	139	2.9
n260	17	145	0.1
n260	18	146	-0.1
n260	19	147	0.8
n260	20	148	0.6
n260	21	149	-0.2
n260	26	154	-0.1
n260	27	155	0.8
n260	28	156	0.6
n260	29	157	0.4



FCC ID: A3LSMT978U	 NEAR-FIELD POWER DENSITY EVALUATION REPORT		Approved by: Quality Manager
Document S/N: 1M2004230075-24-R2.A3L	Test Dates: 06/03/2020 - 07/15/2020	DUT Type: Portable Tablet	Page 7 of 21

1.4 DUT Antenna Locations

This device has the follow antenna arrays: 0, 1. Table below indicates the surfaces evaluated for near field power density (part 1) evaluation. Refer to RF Exposure Part 0 Test Report for justification of these worst-surfaces.

**Table 1-5
5G mmWave NR Device Surfaces**

Band	Module	Back	Front	Top	Bottom	Right	Left
n261	0	Yes	No	No	No	Yes	No
n261	1	No	Yes	No	No	Yes	No
n260	0	Yes	No	No	No	Yes	No
n260	1	No	Yes	No	No	Yes	No

FCC ID: A3LSMT978U	 NEAR-FIELD POWER DENSITY EVALUATION REPORT		Approved by: Quality Manager
Document S/N: 1M2004230075-24-R2.A3L	Test Dates: 06/03/2020 - 07/15/2020	DUT Type: Portable Tablet	Page 8 of 21

1.5 Simultaneous Transmission Capabilities

According to FCC KDB Publication 447498 D01v06, transmitters are considered to be operating simultaneously when there is overlapping transmission, with the exception of transmissions during network hand-offs with maximum hand-off duration less than 30 seconds.

This device contains multiple transmitters that may operate simultaneously, and therefore requires a simultaneous transmission analysis according to FCC KDB Publication 447498 D01v06 4.3.2 procedures.

**Table 1-6
5G mmWave NR Simultaneous Tx**

No.	Capable Transmit Configuration	Body
1	LTE + 5G NR	Yes
2	LTE + 5 GHz Wi-Fi Ant 1 + 5G NR	Yes
3	LTE + 5 GHz Wi-Fi Ant 2 + 5G NR	Yes
4	LTE + 2.4 GHz Bluetooth Ant 1 + 5 GHz Wi-Fi Ant 1 + 5G NR	Yes
5	LTE + 2.4 GHz Wi-Fi Ant 2 + 5 GHz Wi-Fi Ant 1 + 5G NR	Yes
6	LTE + 2.4 GHz Bluetooth Ant 2 + 5 GHz Wi-Fi Ant 1 + 5G NR	Yes
7	LTE + 2.4 GHz Wi-Fi MIMO + 5G NR	Yes
8	LTE + 2.4 GHz Bluetooth Ant 1 + 2.4 GHz Wi-Fi Ant 2 + 5G NR	Yes
9	LTE + 2.4 GHz Bluetooth Ant 1 + 5G NR	Yes
10	LTE + 2.4 GHz Bluetooth Ant 2 + 5G NR	Yes
11	LTE + 5 GHz Wi-Fi MIMO + 5G NR	Yes
12	LTE + 2.4 GHz Bluetooth Ant 1 + 5 GHz Wi-Fi MIMO + 5G NR	Yes
13	LTE + 2.4 GHz Bluetooth Ant 2 + 5 GHz Wi-Fi MIMO + 5G NR	Yes
14	LTE + 2.4 GHz Wi-Fi MIMO + 5 GHz Wi-Fi MIMO + 5G NR	Yes
15	LTE + 2.4 GHz Bluetooth Ant 1 + 2.4 GHz Wi-Fi Ant 2 + 5 GHz Wi-Fi MIMO + 5G NR	Yes

NOTE:

1. 5G NR Operations are limited to Non-Standalone (EN-DC) operations only.
2. NR antenna arrays cannot transmit simultaneously.
3. Simultaneous 5G NR FR2 + LTE operations are possible only with 2/5/12/13/66.
4. All non-5G NR licensed modes share the same antenna path and cannot transmit simultaneously.
5. 5G NR bands cannot transmit simultaneously.
6. This device supports time averaging smart transmit algorithm in WWAN. Smart transmit adds directly the time-averaged RF exposure from 4G and time-averaged RF exposure from 5G mmW NR to ensure that the normalized RF exposure from both 4G and 5G mmW NR does not exceed FCC limit.



1.6 Guidance Applied

- November 2017, October 2018, April 2019, November 2019 TCBC Workshop Notes
- SPEAG DASY6 System Handbook (September 2019)
- IEC TR 63170:2018
- FCC KDB 865664 D02 v01r04
- FCC KDB 447498 D01 v02r01

1.7 Bibliography

**Table 1-7
5G mmWave NR Bibliography**

Report Type	Report Serial Number
FCC SAR Evaluation Report (Part 1)	1M2004230075-01-R3.A3L
Power Density Part 0 Report	1M2004230075-23-R1.A3L
RF Exposure Part 2 Test Report	1M2004230075-25-R1.A3L
RF Exposure Compliance Summary Report	1M2004230075-26-R1.A3L
Power Density Simulation Report	Revision B

FCC ID: A3LSMT978U	 PCTEST Proud to be part of 	NEAR-FIELD POWER DENSITY EVALUATION REPORT		Approved by: Quality Manager
Document S/N: 1M2004230075-24-R2.A3L	Test Dates: 06/03/2020 - 07/15/2020	DUT Type: Portable Tablet	Page 9 of 21	

2

MEASUREMENT SYSTEM

2.1 Measurement Setup

Peak spatially averaged power density (psPD) measurements for mmWave frequencies were performed using the DASY6 with cDASY6 5G module. The DASY6 is made by Schmid & Partner Engineering AG (SPEAG) in Zurich, Switzerland and consists of a high precision robotics system (Staubli), robot controller, desktop computer, near-field probe, probe alignment sensor, and the 5G phantom. The robot is a six-axis industrial robot, performing precise movements to position the probe to the location (points) of maximum electromagnetic field (EMF).

2.2 SPEAG EUmWV3 Probe / E-Field 5G Probe

The EUmWV3 probe consists of two dipoles optimally arranged to obtain pseudo-vector information.

Frequency Range	750 MHz – 110 GHz
Dynamic Range	< 20 V/m – 10,000 V/m with PRE-10 (min < 50 V/m – 3,000 V/m)
Position Precision	< 0.2 mm (cDASY6)
Dimensions	Probe Overall Length: 320 mm Probe Body Diameter: 8 mm Probe Tip Length: 23 mm Probe Tip Diameter: Encapsulation 8 mm Distance from Probe Tip to Sensor X Calibration Point: 1.5 mm Distance from Probe Tip to Sensor Y Calibration Point: 1.5 mm
Applications	E-field measurements of 5G devices and other mm-wave transmitters operating above 10 GHz in < 2 mm distance from device (free-space) Power density, H-field and far-field analysis using total field reconstruction
Compatibility	cDASY6 + 5G-Module SW 2.0.2.34

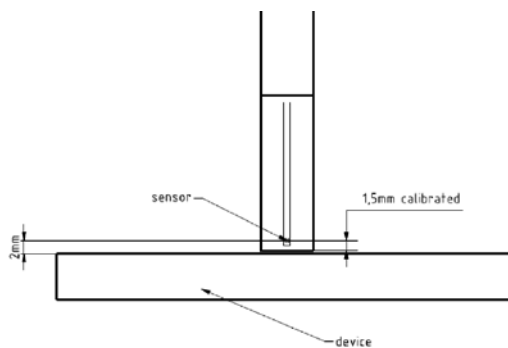
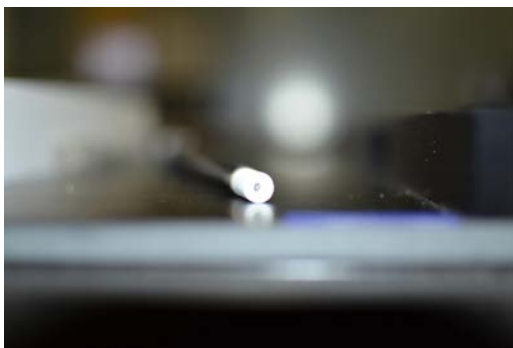





Figure 2-1
EUmWV3 Probe

FCC ID: A3LSMT978U	 PCTEST Proud to be part of 	NEAR-FIELD POWER DENSITY EVALUATION REPORT		Approved by: Quality Manager
Document S/N: 1M2004230075-24-R2.A3L	Test Dates: 06/03/2020 - 07/15/2020	DUT Type: Portable Tablet		Page 10 of 21

2.3 Peak Spatially Averaged Power Density Assessment Based on E-field Measurements

Within a short distance from the transmitting source, power density was determined based on both electric and magnetic fields. Generally, the magnitude and phase of two components of either the E-field or H-field were needed on a sufficiently large surface to fully characterize the total E-field and H-field distributions. Nevertheless, solutions based on direct measurement of E-field and H-field can be used to compute power density. The general measurement approach used for this device was:



- The local E field on the measurement surface was measured at a reference location where the field is well above the noise level. This reference level was used at the end of this procedure to assess output power drift of the DUT during the measurement.
- The electric field on the measurement surface was scanned. Measurements are conducted according to the instructions provided by the measurement system manufacturer. Measurement spatial resolution can depend on the measured field characteristic and measurement methodology used by the system. The planar scan step size was configured at $\lambda/4$.
- For cDASY6, H-field was calculated from the measured E-field using a reconstruction algorithm. As the power density calculation requires knowledge of both amplitude and phase, reconstruction algorithms can also be used to obtain field information from the measured E-field data (e.g. the phase from the amplitude if only the amplitude is measured). H-field and phase data was reconstructed from repeated measurements (three per measurement point) on two measurement planes separated by $\lambda/4$.
- The total Peak spatially averaged power density (psPD) distribution on the evaluation surface is determined per the below equation. The spatial averaging area, A , is specified by the applicable exposure limits or regulatory requirements. A circular shape was used.

$$psPD = \frac{1}{2A_{av}} \iint_{A_{av}} || Re\{E \times H^*\} || dA$$

- The maximum spatial-average on the evaluation surface is the final quantity to determine compliance against applicable limits.
- The local E field reference value, at the same location as step 2, was re-measured after the scan was complete to calculate the power drift. If the drift deviated by more than 5%, the power density test and drift measurements were repeated.

2.4 Reconstruction Algorithm

Computation of the power density in general requires measurement information from the both E-field and H-field amplitudes and phases in the plane of incidence. Reconstruction of these quantities from pseudo-vector E-field measurements is feasible according to the manufacturer, as they are determined via Maxwell's equations. As such, the SPEAG reconstruction approach was based on the Gerchberg-Saxton algorithm, which benefits from the availability of the E-field polarization ellipse information obtained with the EUmmWV3 probe.

FCC ID: A3LSMT978U	 PCTEST Proud to be part of 	NEAR-FIELD POWER DENSITY EVALUATION REPORT		Approved by: Quality Manager
Document S/N: 1M2004230075-24-R2.A3L	Test Dates: 06/03/2020 - 07/15/2020	DUT Type: Portable Tablet	Page 11 of 21	

3.1 Uncontrolled Environment

UNCONTROLLED ENVIRONMENTS are defined as locations where there is the exposure of individuals who have no knowledge or control of their exposure. The general population/uncontrolled exposure limits are applicable to situations in which the general public may be exposed or in which persons who are exposed as a consequence of their employment may not be made fully aware of the potential for exposure or cannot exercise control over their exposure. Members of the general public would come under this category when exposure is not employment-related; for example, in the case of a wireless transmitter that exposes persons in its vicinity.

3.2 Controlled Environment

CONTROLLED ENVIRONMENTS are defined as locations where there is exposure that may be incurred by persons who are aware of the potential for exposure, (i.e. as a result of employment or occupation). In general, occupational/controlled exposure limits are applicable to situations in which persons are exposed as a consequence of their employment, who have been made fully aware of the potential for exposure and can exercise control over their exposure. This exposure category is also applicable when the exposure is of a transient nature due to incidental passage through a location where the exposure levels may be higher than the general population/uncontrolled limits, but the exposed person is fully aware of the potential for exposure and can exercise control over his or her exposure by leaving the area or by some other appropriate means.

3.3 RF Exposure Limits for Frequencies Above 6 GHz



Per §1.1310 (d)(3), the MPE limits are applied for frequencies above 6 GHz. Power Density is expressed in units of W/m^2 or mW/cm^2 .

Peak Spatially Averaged Power Density was evaluated over a circular area of 4 cm^2 per interim FCC Guidance for near-field power density evaluations per October 2018 TCB Workshop notes.

Table 3-1
Human Exposure Limits Specified in FCC 47 CFR §1.1310

Human Exposure to Radiofrequency (RF) Radiation Limits		
Frequency Range [MHz]	Power Density [mW/cm ²]	Average Time [Minutes]
(A) Limits For Occupational / Controlled Environments		
1,500 – 100,000	5.0	6
(B) Limits For General Population / Uncontrolled Environments		
1,500 – 100,000	1.0	30

Note: 1.0 mW/cm^2 is 10 W/m^2

FCC ID: A3LSMT978U	 PCTEST Proud to be part of 	NEAR-FIELD POWER DENSITY EVALUATION REPORT		Approved by: Quality Manager
Document S/N: 1M2004230075-24-R2.A3L	Test Dates: 06/03/2020 - 07/15/2020	DUT Type: Portable Tablet		Page 12 of 21

4 SYSTEM VERIFICATION



4.1 Test System Verification

The system was verified to be within ± 0.66 dB of the power density targets on the calibration certificate according to the test system specification in the user's manual and calibration facility recommendation. The 0.66 dB deviation threshold represents the expanded uncertainty for system performance checks using SPEAG's mmWave verification sources. The same spatial resolution and measurement region used in the source calibration was applied during the system check.

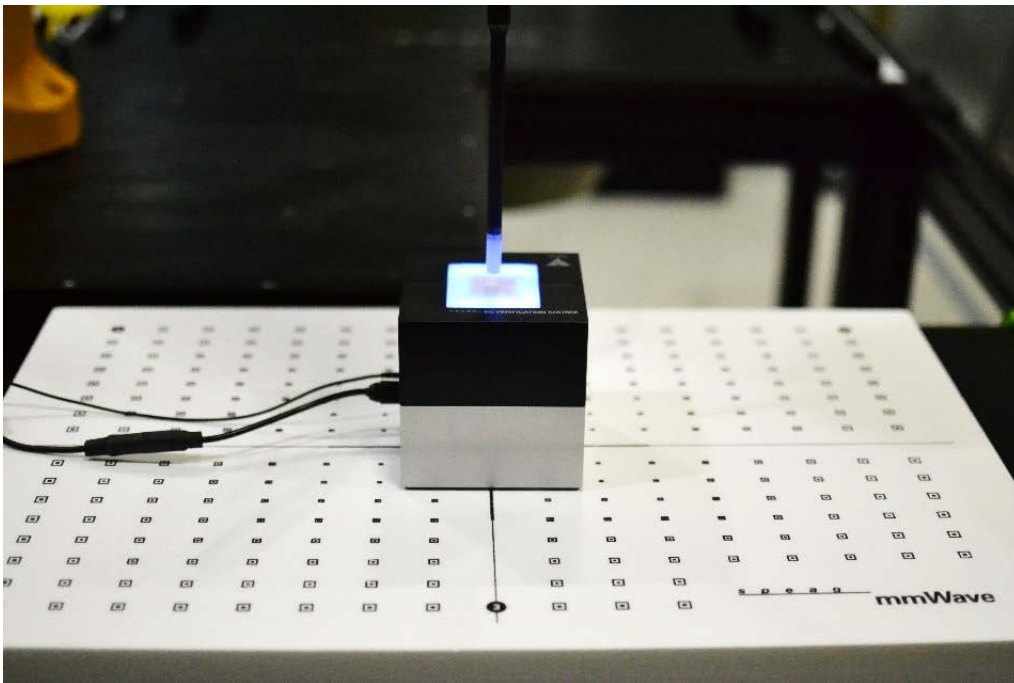
The measured power density distribution of verification source was also confirmed through visual inspection to have no noticeable differences, both spatially (shape) and numerically (level) from the distribution provided by the manufacturer, per November 2017 TCBC Workshop Notes.





**Figure 4-1
System Verification Setup Photo**

FCC ID: A3LSMT978U	 PCTEST <small>Proud to be part of</small> 	NEAR-FIELD POWER DENSITY EVALUATION REPORT	 Approved by: Quality Manager
Document S/N: 1M2004230075-24-R2.A3L	Test Dates: 06/03/2020 - 07/15/2020	DUT Type: Portable Tablet	Page 13 of 21

**Table 4-1
30 GHz Verifications**

System Verification										
Syst.	Freq. (GHz)	Date	Source SN	Probe SN	Normal psPD (W/m ² over 4 cm ²)		Deviation (dB)	Total psPD (W/m ² over 4 cm ²)		Deviation (dB)
					measured	target		measured	target	
R	30	06/03/2020	1035	9407	29.70	32.10	-0.34	30.20	32.50	-0.32
Q	30	06/03/2020	1044	9415	30.10	34.70	-0.62	30.60	35.00	-0.58
R	30	06/04/2020	1035	9407	29.50	32.10	-0.37	30.00	32.50	-0.35
Q	30	06/04/2020	1044	9415	30.60	34.70	-0.55	31.20	35.00	-0.50
Q	30	06/05/2020	1044	9415	30.00	34.70	-0.63	30.60	35.00	-0.58
Q	30	07/14/2020	1035	9415	27.80	32.10	-0.62	28.20	32.50	-0.62
R	30	07/15/2020	1044	9407	31.90	34.70	-0.37	32.40	35.00	-0.34

Note: A **10 mm distance spacing** was used from the reference horn antenna aperture to the probe element. This includes 4.45 mm from the reference antenna horn aperture to the surface of the verification source plus 5.55 mm from the surface to the probe. The SPEAG software requires a setting of "5.55 mm" for the correct set up.

FCC ID: A3LSMT978U	 PCTEST <small>Proud to be part of element</small>	NEAR-FIELD POWER DENSITY EVALUATION REPORT		Approved by: Quality Manager
Document S/N: 1M2004230075-24-R2.A3L	Test Dates: 06/03/2020 - 07/15/2020	DUT Type: Portable Tablet	Page 14 of 21	

5



POWER DENSITY DATA @ INPUT.POWER.LIMIT

5.1 Power Density Results

Power density measurements were performed with DUT transmitting at *input.power.limit* for one single beam for each polarization (H & V) and one beam-pair, for each antenna on each worst-surface.



**Table 5-1
5G mmWave NR Band n261**

MEASUREMENT RESULTS														
Band	Antenna	Frequency	Channel	Beam ID1	Beam ID2	input.power.limit	Signal Type	DUT S/N	Power Drift	Distance	DUT Surface	Normal psPD	Total psPD	Plot #
		MHz		V	H	dBm			dB			mm	mW/cm ²	
n261	0	27549.96	Low	13	-	3.7	CW	05839	0.06	2	Back	0.213	0.408	
n261	0	27549.96	Low	-	150	3.6	CW	05839	0.04	2	Back	0.296	0.548	
n261	0	27549.96	Low	24	152	0.7	CW	05839	-0.07	2	Back	0.603	0.660	A1
n261	1	28299.96	High	27	-	3.5	CW	05953	-0.12	2	Front	0.339	0.389	
n261	1	27549.96	Low	-	149	2.7	CW	05953	-0.07	2	Front	0.260	0.342	
n261	1	27549.96	Low	21	149	-1.4	CW	05953	-0.09	2	Front	0.269	0.396	A2
47 CFR §1.1310 - SAFETY LIMIT Spatial Average Uncontrolled Exposure / General Population								Power Density 1 mW/cm ² averaged over 4 cm ²						

FCC ID: A3LSMT978U	 PCTEST <small>Proud to be part of Samsung</small>	NEAR-FIELD POWER DENSITY EVALUATION REPORT		Approved by: Quality Manager
Document S/N: 1M2004230075-24-R2.A3L	Test Dates: 06/03/2020 - 07/15/2020	DUT Type: Portable Tablet	Page 15 of 21	

**Table 5-2
5G mmWave NR Band n260**



MEASUREMENT RESULTS														
Band	Antenna	Frequency	Channel	Beam ID1	Beam ID2	input.power.limit	Signal Type	DUT S/N	Power Drift	Distance	DUT Surface	Normal psPD	Total psPD	Plot #
		MHz		V	H	dBm			dB			mm	mW/cm ²	
n260	0	39949.00	High	12	-	4.1	CW	05839	-0.01	2	Back	0.479	0.666	
n260	0	39949.00	High	-	150	3.9	CW	05839	0.11	2	Back	0.473	0.692	A3
n260	0	39949.00	High	22	150	0.6	CW	05839	0.01	2	Back	0.138	0.243	
n260	1	38499.96	Mid	18	-	2.9	CW	05953	-0.19	2	Front	0.232	0.310	
n260	1	38499.96	Mid	-	145	3.2	CW	05953	-0.15	2	Front	0.333	0.464	A4
n260	1	38499.96	Mid	21	149	-0.2	CW	05953	0.01	2	Front	0.185	0.242	
47 CFR §1.1310 - SAFETY LIMIT Spatial Average Uncontrolled Exposure / General Population								Power Density 1 mW/cm ² averaged over 4 cm ²						

FCC ID: A3LSMT978U	 Proud to be part of Samsung	NEAR-FIELD POWER DENSITY EVALUATION REPORT		Approved by: Quality Manager
Document S/N: 1M2004230075-24-R2.A3L	Test Dates: 06/03/2020 - 07/15/2020	DUT Type: Portable Tablet	Page 16 of 21	

5.2 Power Density Test Notes

General Notes:

1. The manufacturer has confirmed that the devices tested have the same physical, mechanical and thermal characteristics and are within operational tolerances expected for production units.
2. Batteries are fully charged at the beginning of the measurements. The DUT was connected to a wall charger for some measurements due to the test duration. It was confirmed that the charger plugged into this DUT did not impact the near-field PD test results.
3. Power density was calculated by repeated E-field measurements on two measurement planes separated by $\lambda/4$.
4. DUT was configured to transmit with a manufacturer provided test software to control specific antenna(s), Beam ID(s), and signal type to ensure the test configurations constant for the entire evaluation.
5. This device utilizes power reduction for some WLAN wireless modes and technologies for simultaneous transmission compliance. These mechanisms are assessed in the SAR Test Report.
6. *PD_design_target* of 0.6166 mW/cm² was used with mmW device design related uncertainty of 2.1 dB.
7. *Input.power.limit* parameter for 5G mmW NR radio was calculated in RF Exposure Part 0 test report.
8. This device is enabled with Qualcomm® Smart Transmit feature to control and manage transmitting power in real time and to ensure that the time-averaged RF exposure from WWAN is in compliance with FCC requirements. Per FCC guidance for devices enabled with Qualcomm® Smart Transmit feature, 4G LTE and 5G mmW NR simultaneous transmission scenario does not need to be evaluated under Total Exposure Ratio (TER). The validation of the time-averaging algorithm and compliance under the Tx varying transmission scenario for WWAN technologies are reported in Part 2 report.
9. Per FCC guidance for devices enabled with Qualcomm® Smart Transmit feature, simultaneous transmission analysis is evaluated by combining the exposure from each WWAN and WLAN antenna. 5G mmW NR and WLAN simultaneous transmission scenario is evaluated under the Total Exposure Ratio (TER) in Appendix C.
10. The Beam IDs with one of the highest initial simulated power density for that surface and distance was selected for Part 1 Power Density measurements.
11. The device was configured to transmit CW wave signal for testing. Per FCC guidance for devices enabled with Qualcomm® Smart Transmit feature, additional testing was not required for different modulations (CP-OFDM: QPSK, 16QAM, 64QAM, DFT-s-OFDM: PI/2BPSK, QPSK, 16QAM, 64QAM), RB configurations, component carriers, channel configurations (low channel, mid channel, high channel) since the smart transmit algorithm monitors powers on a per symbol basis, which is independent of these signal characteristics.
12. The device was configured to MIMO configuration with H and V polarization beams transmitting together.



FCC ID: A3LSMT978U	 NEAR-FIELD POWER DENSITY EVALUATION REPORT		Approved by: Quality Manager
Document S/N: 1M2004230075-24-R2.A3L	Test Dates: 06/03/2020 - 07/15/2020	DUT Type: Portable Tablet	Page 17 of 21

**Table 6-1
5G mmWave NR Equipment List**

Manufacturer	Model	Description	Cal Date	Cal Interval	Cal Due	Serial Number
-	WL25-1	Conducted Cable Set (25GHz)	10/30/2019	Annual	10/30/2020	WL25-1
-	WL40-1	Conducted Cable Set (40GHz)	10/30/2019	Annual	10/30/2020	WL40-1
Agilent	N9038A	MXE EMI Receiver	07/17/2019	Annual	07/17/2020	MY51210133
EMCO	3160-09	Small Horn (18 - 26.5GHz)	08/09/2018	Biennial	08/09/2020	135427
Emco	3116	Horn Antenna (18 - 40GHz)	06/07/2018	Triennial	06/07/2021	9203-2178
Rohde & Schwarz	ESU40	EMI Test Receiver (40GHz)	09/23/2019	Annual	09/23/2020	100348
SPEAG	EUmmWV3	EUmmWV3 Probe	02/14/2020	Annual	02/14/2021	9415
SPEAG	EUmmWV3	EUmmWV3 Probe	12/20/2019	Annual	12/10/2020	9407
SPEAG	SM 003 100 AA	30GHz System Verification Ka- Band Source Antenna	05/14/2020	Annual	05/14/2021	1044
SPEAG	SM 003 100 AA	30GHz System Verification Ka- Band Source Antenna	02/12/2020	Annual	02/12/2021	1035
SPEAG	DAE4	Dasy Data Acquisition Electronics	03/12/2020	Annual	03/12/2021	1415.00
SPEAG	DAE4	Dasy Data Acquisition Electronics	02/20/2020	Annual	02/20/2021	1272
Rohde & Schwarz	180-442-KF	Horn (Small)	08/21/2018	Biennial	08/21/2020	U157403-01
Virginia Diodes Inc	SAX252	Spectrum Analyzer Extension Module	09/30/2019	Annual	09/30/2020	SAX252
Virginia Diodes Inc	SAX253	Spectrum Analyzer Extension Module	09/30/2019	Annual	09/30/2020	SAX253
Virginia Diodes Inc	SAX254	Spectrum Analyzer Extension Module	09/30/2019	Annual	09/30/2020	SAX254

Note:



1. Each equipment item was used solely within its respective calibration period.

FCC ID: A3LSMT978U	 NEAR-FIELD POWER DENSITY EVALUATION REPORT		Approved by: Quality Manager
Document S/N: 1M2004230075-24-R2.A3L	Test Dates: 06/03/2020 - 07/15/2020	DUT Type: Portable Tablet	Page 18 of 21

7

MEASUREMENT UNCERTAINTIES



a Uncertainty Component	b	c	d	e	f = b x e/d	g
	Unc. (± dB)	Prob. Dist.	Div.	ci	ui (± dB)	vi
Calibration	0.49	N	1	1.0	0.49	∞
Probe correction	0	R	1.73	1.0	0.00	∞
Frequency Response (BW ≤ 1 GHz)	0.20	R	1.73	1.0	0.12	∞
Sensor cross coupling	0	R	1.73	1.0	0.00	∞
Isotropy	0.50	R	1.73	1.0	0.29	∞
Linearity	0.20	R	1.73	1.0	0.12	∞
Probe Scattering	0	R	1.73	1.0	0	∞
Probe Positioning Offset	0.30	R	1.73	1.0	0.17	∞
Probe Positioning Repeatability	0.04	R	1.73	1.0	0.02	∞
Sensor Mechanical Offset	0	R	1.73	1.0	0	∞
Probe Spatial Resolution	0	R	1.73	1.0	0	∞
Field Impedance Dependence	0	R	1.73	1.0	0	∞
Amplitude and phase drift	0	R	1.73	1.0	0	∞
Amplitude and phase noise	0.04	R	1.73	1.0	0.02	∞
Measurement area truncation	0	R	1.73	1.0	0	∞
Data acquisition	0.03	N	1	1.0	0.03	∞
Sampling	0	R	1.73	1.0	0	∞
Field Reconstruction	0.60	R	1.73	1.0	0.35	∞
Forward Transformation	0	R	1.73	1.0	0	∞
Power Density Scaling	-	R	1.73	1.0	-	∞
Spatial Averaging	0.10	R	1.73	1.0	0.06	∞
System Detection Limit	0.04	R	1.73	1.0	0.02	∞
Test Sample and Environmental Factors						
Probe Coupling with DUT	0	R	1.73	1.0	0	∞
Modulation Response	0.40	R	1.73	1.0	0.23	∞
Integration Time	0	R	1.73	1.0	0	∞
Response Time	0	R	1.73	1.0	0	∞
Device Holder Influence	0.10	R	1.73	1.0	0.06	∞
DUT Alignment	0	R	1.73	1.0	0	∞
RF Ambient Conditions	0.04	R	1.73	1.0	0.02	∞
Ambient Reflections	0.04	R	1.73	1.0	0.02	∞
Immunity / Secondary Reception	0	R	1.73	1.0	0	∞
Drift of the DUT	0.22	R	1.73	1.0	0.13	∞
Combined Standard Uncertainty (k=1)		RSS			0.76	∞
(95% CONFIDENCE LEVEL)	k=2				1.53	

FCC ID: A3LSMT978U	 PCTEST Proud to be part of 	NEAR-FIELD POWER DENSITY EVALUATION REPORT		Approved by: Quality Manager
Document S/N: 1M2004230075-24-R2.A3L	Test Dates: 06/03/2020 - 07/15/2020	DUT Type: Portable Tablet	Page 19 of 21	



8.1 Measurement Conclusion

The power density measurements and total exposure ratio analysis indicate that the DUT complies with the RF radiation exposure limits of the FCC, with respect to all parameters subject to this test. These measurements were taken to simulate the RF effects of RF exposure under worst-case conditions. Precise laboratory measures were taken to assure repeatability of the tests. The results and statements relate only to the item(s) tested.

Please note that the RF Exposure and distribution of electromagnetic energy in the body are very complex phenomena that depend on the mass, shape, and size of the body, the orientation of the body with respect to the field vectors, and the electrical properties of both the body and the environment. Other variables that may play a substantial role in possible biological effects are those that characterize the environment (e.g. ambient temperature, air velocity, relative humidity, and body insulation) and those that characterize the individual (e.g. age, gender, activity level, debilitation, or disease). Because various factors may interact with one another to vary the specific biological outcome of an exposure to electromagnetic fields, any protection guide should consider maximal amplification of biological effects as a result of field-body interactions, environmental conditions, and physiological variables.

FCC ID: A3LSMT978U	 NEAR-FIELD POWER DENSITY EVALUATION REPORT		Approved by: Quality Manager
Document S/N: 1M2004230075-24-R2.A3L	Test Dates: 06/03/2020 - 07/15/2020	DUT Type: Portable Tablet	Page 20 of 21

- [1] ANSI/IEEE C95.1-1992, American National Standard safety levels with respect to human exposure to radio frequency electromagnetic fields, 3kHz to 300GHz, New York: IEEE, Sept. 1992.
- [2] IEC TR 63170:2018, Measurement Procedure for the Evaluation of Power Density Related to Human Exposure to Radiofrequency Fields from Wireless Communication Devices Operating between 6 GHz and 100 GHz
- [3] IEC TR 62630 : 2010, Guidance for Evaluating Exposure from Multiple Electromagnetic Sources
- [4] K. Pokovic, T. Schmid, J. Frohlich, and N. Kuster. Novel Probes and Evaluation Procedures to Assess Field Magnitude and Polarization. IEEE Transactions on Electromagnetic Compatibility 42(2): 240 -244, 2000
- [5] R. W. Gerchberg and W. O. Saxton. A Practical Algorithm for the Determination of Phase from Image and Diffraction Plane Pictures. Optik 35(2): 237 – 246, 1972
- [6] A. P. Anderson and S. Sali. New Possibilities for Phaseless Microwave Diagnostics. Part 1: Error Reduction Techniques. IEE Proceedings H – Microwaves, Antennas and Propagation 132(5): 290 – 298, 1985
- [7] FCC KDB 865664 D02 v01r04: SAR Measurement Requirements for 100 MHz to 6 GHz. Federal Communications Commission – Office of Engineering and Technology, Laboratory Division.
- [8] FCC KDB 447498 D01 v02r01: RF Exposure Procedures and Equipment Authorization Policies for Mobile and Portable Devices. Federal Communications Commission – Office of Engineering and Technology, Laboratory Division.
- [9] November 2017 Telecommunications Certification Body Council (TCBC) Workshop Notes
- [10] October 2018 Telecommunications Certification Body Council (TCBC) Workshop Notes
- [11] April 2019 Telecommunications Certification Body Council (TCBC) Workshop Notes
- [12] November 2019 Telecommunications Certification Body Council (TCBC) Workshop Notes
- [13] SPEAG DASY6 System Handbook (September 2019)

FCC ID: A3LSMT978U	 PCTEST <small>Proud to be part of</small>	NEAR-FIELD POWER DENSITY EVALUATION REPORT	 Approved by: Quality Manager
Document S/N: 1M2004230075-24-R2.A3L	Test Dates: 06/03/2020 - 07/15/2020	DUT Type: Portable Tablet	Page 21 of 21

APPENDIX A: POWER DENSITY TEST PLOTS

PCTEST

Date: 07/14/2020

Antenna 0 Beam 24/152; MIMO; Low Ch.; CW

Device Under Test Properties

DUT	Serial Number	DUT Type
A3LSMT978U	05839	Portable Tablet

Exposure Conditions

Phantom Section	Position	Test Distance [mm]	Band	Frequency [MHz]
5G	BACK	2.00	n261	27550.00

Hardware Setup

Probe, Calibration Date	DAE, Calibration Date
EUMmWV3 - SN9415, 02/14/2020	DAE4 SN1415, 03/12/2020

Software Setup

Software	Software Version
cDASY6 Module mmWave	2.0.2.34

Scans Setup

Scan Type	5G Scan
Grid Extents [mm]	100x100
Grid Steps [lambda]	0.25 x 0.25
Sensor Surface [mm]	2.0

Measurement Results

Scan Type	5G Scan
Avg. Area [cm ²]	4.00
pS _{tot} avg [W/m ²]	6.60
pS _n avg [W/m ²]	6.03
E _{peak} [V/m]	93.3
Power Drift [dB]	-0.07

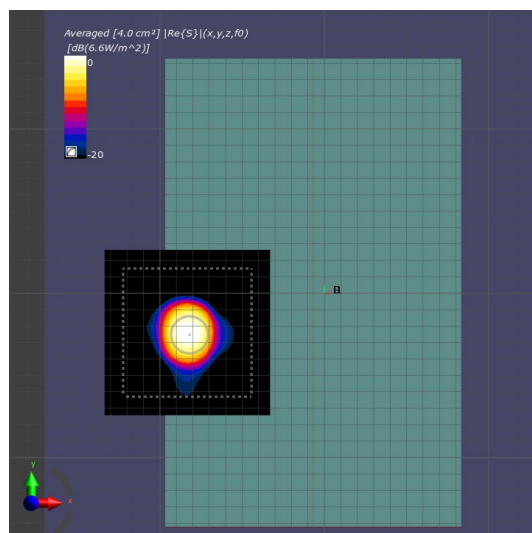

PCTEST

Date: 06/04/2020

Antenna 1 Beam 21/149; MIMO; Low Ch.; CW

Device Under Test Properties

DUT	Serial Number	DUT Type
A3LSMT978U	05953	Portable Tablet

Exposure Conditions

Phantom Section	Position	Test Distance [mm]	Band	Frequency [MHz]
5G	FRONT	2.00	n261	27550.00

Hardware Setup

Probe, Calibration Date	DAE, Calibration Date
EUMmWV3 - SN9407, 12/10/2019	DAE4 SN1272, 02/20/2020

Software Setup

Software	Software Version
cDASY6 Module mmWave	2.0.2.34

Scans Setup

Scan Type	5G Scan
Grid Extents [mm]	80x80
Grid Steps [lambda]	0.25 x 0.25
Sensor Surface [mm]	2.0

Measurement Results

Scan Type	5G Scan
Avg. Area [cm ²]	4.00
pS _{tot} avg [W/m ²]	3.96
pS _n avg [W/m ²]	2.69
E _{peak} [V/m]	75.7
Power Drift [dB]	-0.09

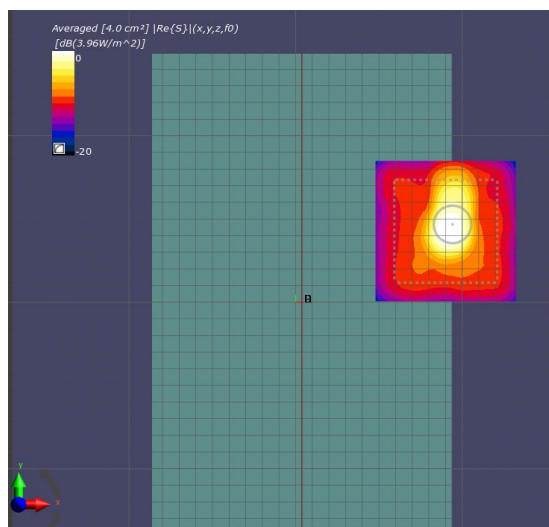

PCTEST

Date: 06/05/2020

Antenna 0 Beam 150; H; High Ch.; CW

Device Under Test Properties

DUT	Serial Number	DUT Type
A3LSMT978U	05839	Portable Tablet

Exposure Conditions

Phantom Section	Position	Test Distance [mm]	Band	Frequency [MHz]
5G	BACK	2.00	n260	39949.00

Hardware Setup

Probe, Calibration Date	DAE, Calibration Date
EUmmWV3 - SN9415, 02/14/2020	DAE4 SN1415, 03/12/2020

Software Setup

Software	Software Version
cDASY6 Module mmWave	2.0.2.34

Scans Setup

Scan Type	5G Scan
Grid Extents [mm]	80x80
Grid Steps [lambda]	0.25 x 0.25
Sensor Surface [mm]	2.0

Measurement Results

Scan Type	5G Scan
Avg. Area [cm ²]	4.00
pS _{tot} avg [W/m ²]	6.92
pS _n avg [W/m ²]	4.73
E _{peak} [V/m]	109
Power Drift [dB]	0.11

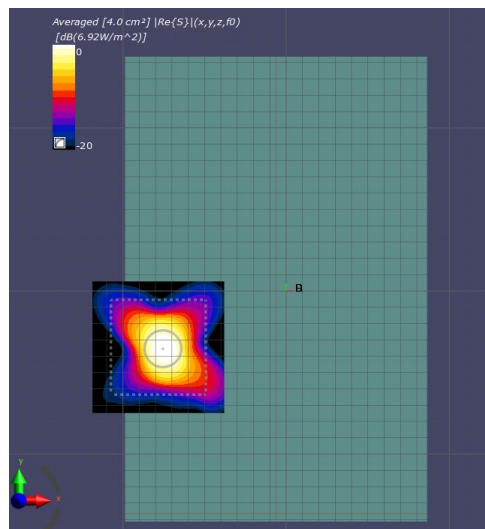

PCTEST

Date: 06/04/2020

Antenna 1 Beam 145; H; Mid Ch.; CW

Device Under Test Properties

DUT	Serial Number	DUT Type
A3LSMT978U	05953	Portable Tablet

Exposure Conditions

Phantom Section	Position	Test Distance [mm]	Band	Frequency [MHz]
5G	FRONT	2.00	n260	38500.00

Hardware Setup

Probe, Calibration Date	DAE, Calibration Date
EUmmWV3 - SN9407, 12/10/2019	DAE4 SN1272, 02/20/2020

Software Setup

Software	Software Version
cDASY6 Module mmWave	2.0.2.34

Scans Setup

Scan Type	5G Scan
Grid Extents [mm]	80x80
Grid Steps [lambda]	0.25 x 0.25
Sensor Surface [mm]	2.0

Measurement Results

Scan Type	5G Scan
Avg. Area [cm ²]	4.00
pS _{tot} avg [W/m ²]	4.64
pS _n avg [W/m ²]	3.33
E _{peak} [V/m]	107
Power Drift [dB]	-0.15

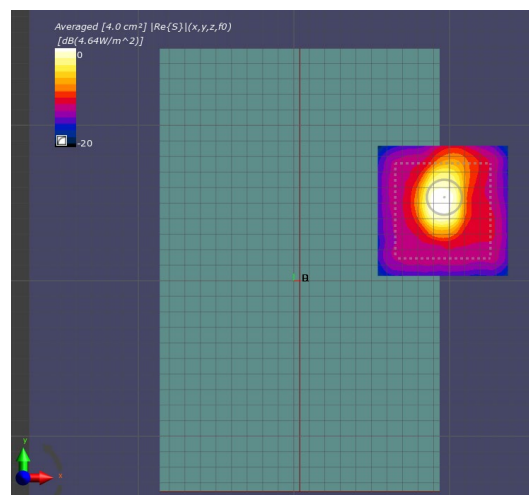

APPENDIX B: POWER DENSITY SYSTEM VERIFICATION PLOTS

PCTEST

Date: 06/04/2020

30 GHz System Verification

Device Under Test Properties

DUT	Serial Number
30 GHz Verification Source	1035

Exposure Conditions

Phantom Section	Position	Test Distance [mm]	Band	Frequency [MHz]
5G	FRONT	5.55	Validation band	30000.0

Hardware Setup

Probe, Calibration Date	DAE, Calibration Date
EUmmWV3 - SN9407, 12/10/2019	DAE4 SN1272, 02/20/2020

Software Setup

Software	Software Version
cDASY6 Module mmWave	2.0.2.34

Scans Setup

Scan Type	5G Scan
Grid Extents [mm]	60.0 x 60.0
Grid Steps [lambda]	0.25 x 0.25
Sensor Surface [mm]	5.55

Measurement Results

Scan Type	5G Scan
Avg. Area [cm ²]	4.00
pS _{tot} avg [W/m ²]	30.0
pS _n avg [W/m ²]	29.5
E _{peak} [V/m]	126
Deviation (dB)	-0.35

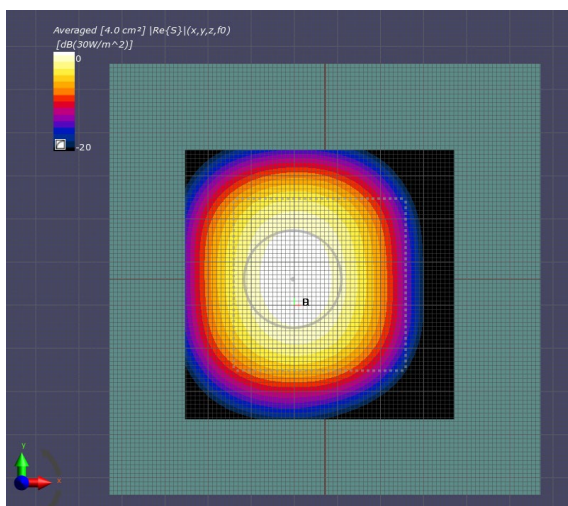

30GHz System Verification

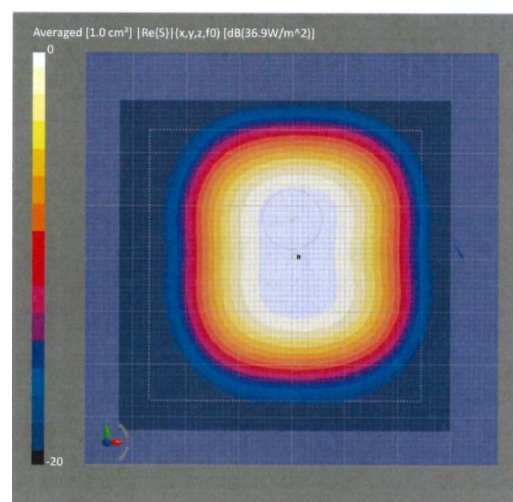

Calibration Certificate

PCTEST

Date: 06/05/2020

30 GHz System Verification

Device Under Test Properties

DUT	Serial Number
30 GHz Verification Source	1044

Exposure Conditions

Phantom Section	Position	Test Distance [mm]	Band	Frequency [MHz]
5G	FRONT	5.55	Validation band	30000.0

Hardware Setup

Probe, Calibration Date	DAE, Calibration Date
EUmmWV3 - SN9415, 02/14/2020	DAE4 SN1415, 03/12/2020

Software Setup

Software	Software Version
cDASY6 Module mmWave	2.0.2.34

Scans Setup

Scan Type	5G Scan
Grid Extents [mm]	60.0 x 60.0
Grid Steps [lambda]	0.25 x 0.25
Sensor Surface [mm]	5.55

Measurement Results

Scan Type	5G Scan
Avg. Area [cm ²]	4.00
pS _{tot} avg [W/m ²]	30.6
pS _n avg [W/m ²]	30.0
E _{peak} [V/m]	127
Deviation (dB)	-0.58

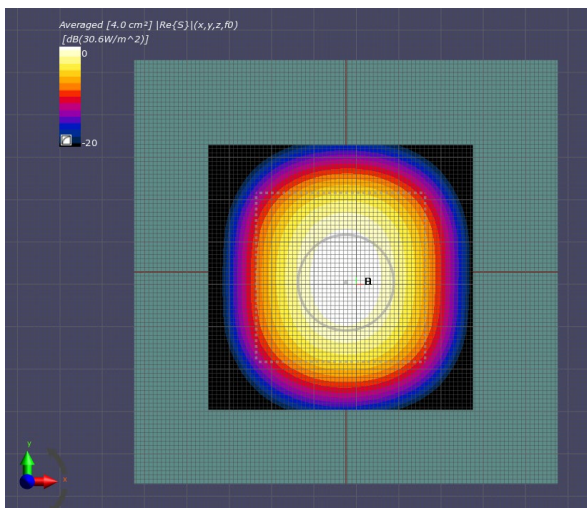

30GHz System Verification

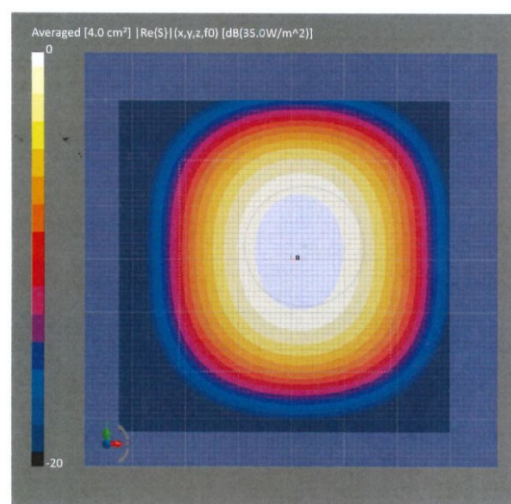

Calibration Certificate

PCTEST

Date: 07/14/2020

30 GHz System Verification

Device Under Test Properties

DUT	Serial Number
30 GHz Verification Source	1035

Exposure Conditions

Phantom Section	Position	Test Distance [mm]	Band	Frequency [MHz]
5G	FRONT	5.55	Validation band	30000.0

Hardware Setup

Probe, Calibration Date	DAE, Calibration Date
EUmmWV3 - SN9415, 02/14/2020	DAE4 SN1415, 03/12/2020

Software Setup

Software	Software Version
cDASY6 Module mmWave	2.0.2.34

Scans Setup

Scan Type	5G Scan
Grid Extents [mm]	60.0 x 60.0
Grid Steps [lambda]	0.25 x 0.25
Sensor Surface [mm]	5.55

Measurement Results

Scan Type	5G Scan
Avg. Area [cm ²]	4.00
pS _{tot} avg [W/m ²]	28.2
pS _n avg [W/m ²]	27.8
E _{peak} [V/m]	123
Deviation (dB)	-0.62

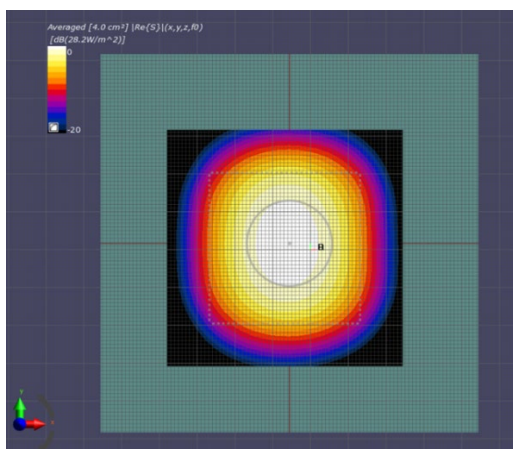

30GHz System Verification

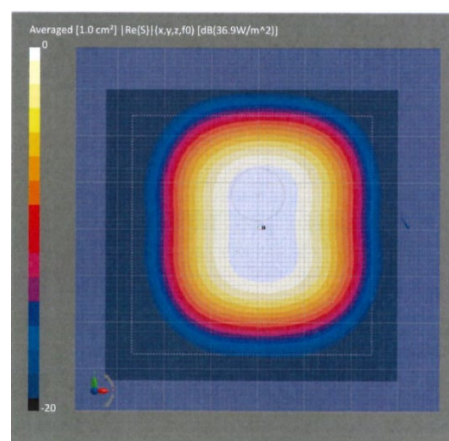

Calibration Certificate

PCTEST

Date: 07/15/2020

30 GHz System Verification

Device Under Test Properties

DUT	Serial Number
30 GHz Verification Source	1044

Exposure Conditions

Phantom Section	Position	Test Distance [mm]	Band	Frequency [MHz]
5G	FRONT	5.55	Validation band	30000.0

Hardware Setup

Probe, Calibration Date	DAE, Calibration Date
EUmmWV3 - SN9407, 12/10/2019	DAE4 SN1272, 02/20/2020

Software Setup

Software	Software Version
cDASY6 Module mmWave	2.0.2.34

Scans Setup

Scan Type	5G Scan
Grid Extents [mm]	60.0 x 60.0
Grid Steps [lambda]	0.25 x 0.25
Sensor Surface [mm]	5.55

Measurement Results

Scan Type	5G Scan
Avg. Area [cm ²]	4.00
pS _{tot} avg [W/m ²]	32.4
pS _n avg [W/m ²]	31.9
E _{peak} [V/m]	131
Deviation (dB)	-0.34

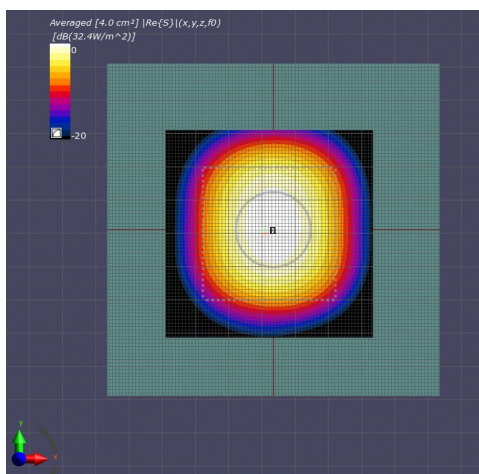

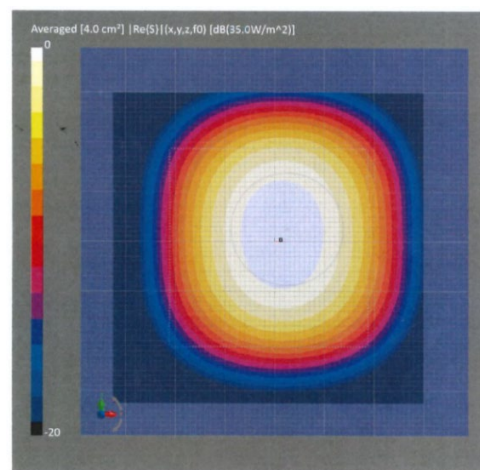

30GHz System Verification



Calibration Certificate

APPENDIX C: TOTAL EXPOSURE RATIO

FCC ID: A3LSMT978U	 PCTEST <small>Proud to be part of </small>	NEAR-FIELD POWER DENSITY EVALUATION REPORT		Approved by: Quality Manager
Test Dates: 06/03/20 – 07/15/20	DUT Type: Portable Tablet	APPENDIX C: Page 1 of 8		

The Total Exposure Ratio (TER) is calculated by combining all SAR measurements and power density measurements after normalizing to their respective limits. The general expression is below.

$$TER = \sum_{a=1}^A \frac{SAR_a}{SAR_a, limit} + \sum_{b=1}^B \frac{psPD_b}{psPD_b, limit} < 1$$

The TER shall be less than unity to ensure compliance with the limits.

$$\sum_{n=1}^N \frac{4G SAR_n}{4G SAR_n, limit} + \sum_{m=1}^M \frac{5G mmW NR psPD_m}{5G mmW NR psPD_m, limit} + \sum_{p=1}^P \frac{WLAN SAR_p}{WLAN SAR_p, limit} < 1$$

Qualcomm® Smart Transmit algorithm for WWAN adds directly the time-averaged RF exposure from 4G and time-averaged RF exposure from 5G mmW NR. Smart Transmit algorithm controls the total RF exposure from both 4G and 5G mmW NR to not exceed FCC limit. Therefore, per FCC guidance, TER does not need to be evaluated directly for the 4G and 5G simultaneous compliance via summation. The following equations are derived later in Appendix C. The validation of the time-averaging algorithm and compliance under the Tx varying transmission scenario for WWAN technologies are reported in Part 2 report. The report SN could be found in Bibliography section.



$$\sum_{n=1}^N \frac{4G SAR_n}{4G SAR_n, limit} + \sum_{p=1}^P \frac{WLAN SAR_p}{WLAN SAR_p, limit} < 1$$

$$\sum_{m=1}^M \frac{5G mmW NR psPD_m}{5G mmW NR psPD_m, limit} + \sum_{p=1}^P \frac{WLAN SAR_p}{WLAN SAR_p, limit} < 1$$

For 5G mmW NR, since there is total design-related uncertainty arising from TxAGC and device-to-device variation, the worst-case RF exposure should be determined by accounting for device uncertainty. Smart Transmit algorithm limits PD exposure to 75% of maximum to provide at least 25% margin allocated for 4G LTE anchor due to the 3 dB reserve power margin used in the device. Therefore, 5G mmW NR RF exposure for this DUT is evaluated by reported psPD calculated as:

$$reported_psPD = 75\% \times PD_design_target + PD_uncertainty = 0.75 mW/cm^2$$

Note that since not all the beams supported by this EUT are measured, *reported_psPD* cannot be computed based on limited *measured psPD* data. Alternatively, since *measured psPD* for all the beams will be $\leq PD_design_target + PD_uncertainty$, *reported_psPD* is computed based on this worst-case PSPD as shown above.

FCC ID: A3LSMT978U	 PCTEST <small>Proud to be part of</small> 	NEAR-FIELD POWER DENSITY EVALUATION REPORT		Approved by: Quality Manager
Test Dates: 06/03/20 – 07/15/20	DUT Type: Portable Tablet	APPENDIX C: Page 2 of 8		

The compliance analysis for simultaneous transmission scenarios of WWAN (4G LTE & 5G mmW NR) with Smart Transmit and 4G & WLAN can be found in two reports indicated in the table below. This appendix demonstrates compliance for the 5G + WLAN scenarios. The report SNs can be found in Bibliography section.

	Simultaneous Scenario	Evaluation Report
1.	4G LTE WWAN + WLAN	FCC SAR Evaluation Report (Part 1)
2.	4G LTE WWAN + 5G mmW NR WWAN	RF Exposure Part 2 Test Report

RF exposure compliance with 5G mmW NR WWAN+WLAN simultaneous transmission scenarios is demonstrated for various radio configurations below.

Note that the above *reported psPD* applies to the worst-case surfaces of the DUT at 2mm evaluation distance.

Worst-case PD on other surfaces of the DUT are calculated from simulated PD data (see Power Density Simulation Report), by multiplying reported psPD with the highest proportion out of all beams and out of all three channels in each band, where the adjustment for each beam/channel is computed as the proportion of “simulated PD on desired surface” to “simulated PD on worst-surface”. For example, to determine worst-case PD on front surface, highest proportion of (simulated PD on front surface)/(simulated PD on worst surface) was determined out of all supported beams and out of all three channels by the DUT in each band.

In some cases, the simulation vs measurement for some surfaces can exceed the device's total uncertainty. In those cases, if the measured psPD > simulated adjusted psPD (assuming a linear congruency of the psPD across surfaces), then 75% of the measured value (based on the 3 dB reserve power margin) should be used towards the simultaneous TX analysis. Table C-1 lists the relevant worst-case reported psPD values based on the additional surfaces and evaluation distances needed to perform the TER analysis. The highest of the adjusted Reported_psPD and Measured Total psPD* 0.75 was chosen for TER analysis and the chosen values are indicated by bolded psPD values.



FCC ID: A3LSMT978U	 PCTEST <small>Proud to be part of </small>	NEAR-FIELD POWER DENSITY EVALUATION REPORT		Approved by: Quality Manager
Test Dates: 06/03/20 – 07/15/20	DUT Type: Portable Tablet	APPENDIX C: Page 3 of 8		

Table C-1
5G mmW NR psPD

<u>NR Band</u>	<u>Surface</u>	<u>Evaluation Distance (mm)</u>	<u>Adjustment Factor due to Simulation</u>	<u>Adjusted Reported psPD (mW/cm²)</u>	<u>Measured Total psPD (mW/cm²)</u>	<u>Measured Total psPD x 0.75 (mW/cm²)</u>	<u>Final Reported psPD (mW/cm²)</u>
n261	Back	2	1.000	0.750	0.660	0.495	0.750
n261	Front	2	1.000	0.750	0.396	0.297	0.750
n261	Top	2	0.416	0.312	-	-	0.312
n261	Bottom	2	0.227	0.170	-	-	0.170
n261	Right	2	0.531	0.398	0.253	0.190	0.398
n261	Left	2	0.161	0.121	-	-	0.121
n260	Back	2	1.000	0.750	0.692	0.519	0.750
n260	Front	2	1.000	0.750	0.464	0.348	0.750
n260	Top	2	0.219	0.164	-	-	0.164
n260	Bottom	2	0.121	0.091	-	-	0.091
n260	Right	2	0.570	0.428	0.378	0.284	0.428
n260	Left	2	0.194	0.145	-	-	0.145

Note: Adjusted factor is (simulated PD on desired exposure plane)/(PD on worst-surface at 2mm evaluation distance) out of all beams and out of all channels. See Power Density Simulation Report.

Table C-2
5G mmW NR psPD – Additional Considerations for Back Side

<u>Module</u>	<u>NR Band</u>	<u>Surface</u>	<u>Evaluation Distance (mm)</u>	<u>Adjustment Factor due to Simulation</u>	<u>Adjusted Reported psPD (mW/cm²)</u>	<u>Measured Total psPD (mW/cm²)</u>	<u>Measured Total psPD x 0.75 (mW/cm²)</u>	<u>Final Reported psPD (mW/cm²)</u>
0	n261	Back	2	1.000	0.750	-	-	0.750
	n260	Back	2	1.000	0.750	-	-	0.750
1	n261	Back	2	0.238	0.179	-	-	0.179
	n260	Back	2	0.083	0.062	-	-	0.062

Note: Adjusted factor is (simulated PD on desired exposure plane)/(PD on worst-surface at 2mm evaluation distance) out of all beams and out of all channels. See Power Density Simulation Report.



FCC ID: A3LSMT978U	 PCTEST <small>Proud to be part of </small>	NEAR-FIELD POWER DENSITY EVALUATION REPORT		Approved by: Quality Manager
Test Dates: 06/03/20 – 07/15/20	DUT Type: Portable Tablet	APPENDIX C: Page 4 of 8		

Table C-3
5G mmW NR Total Exposure Ratio

	psPD	2.4 GHz WLAN Ant2		2.4 GHz WLAN MIMO		Bluetooth Ant 1		Bluetooth Ant 2		5 GHz WLAN Ant1		5 GHz WLAN Ant2		5 GHz WLAN MIMO		psPD + 5 GHz WLAN Ant 1		psPD + 5 GHz WLAN Ant 2		psPD + 2.4 GHz WLAN Ant 1 + 5 GHz WLAN Ant 1		psPD + 2.4 GHz WLAN Ant 2 + 5 GHz WLAN Ant 2		psPD + 2.4 GHz WLAN Ant 1 + 5 GHz WLAN Ant 2		psPD + 2.4 GHz WLAN Ant 1 + 5 GHz WLAN Ant 2 + 5 GHz WLAN MIMO	
		11.0 dBm	21.0 dBm	15.0 dBm	15.0 dBm	7.0 dBm	7.0 dBm	6.0 dBm	6.0 dBm	5.0 dBm	5.0 dBm	5.0 dBm	5.0 dBm	5.0 dBm	5.0 dBm	5.0 dBm	5.0 dBm	5.0 dBm	5.0 dBm	5.0 dBm	5.0 dBm	5.0 dBm	5.0 dBm	5.0 dBm	5.0 dBm	5.0 dBm	5.0 dBm
Applicable Limit	1	1	1	1	1	1	1	1	1	1	1	1	1	1	1	1	1	1	1	1	1	1	1	1	1	1	1
Front Side	Reported Value	0.750	0.750	0.000	0.000	0.000	0.000	0.000	0.000	0.000	0.000	0.000	0.000	0.000	0.000	0.750	0.750	0.750	0.750	0.750	0.750	0.750	0.750	0.750	0.750	0.750	0.750
Top Edge	Reported Value	0.120	0.120	0.000	0.000	0.000	0.000	0.000	0.000	0.000	0.000	0.000	0.000	0.000	0.000	0.120	0.120	0.120	0.120	0.120	0.120	0.120	0.120	0.120	0.120	0.120	0.120
Bottom Edge	Reported Value	0.120	0.120	0.000	0.000	0.000	0.000	0.000	0.000	0.000	0.000	0.000	0.000	0.000	0.000	0.120	0.120	0.120	0.120	0.120	0.120	0.120	0.120	0.120	0.120	0.120	0.120
Right Edge	Reported Value	0.140	0.140	0.000	0.000	0.000	0.000	0.000	0.000	0.000	0.000	0.000	0.000	0.000	0.000	0.140	0.140	0.140	0.140	0.140	0.140	0.140	0.140	0.140	0.140	0.140	0.140
Left Edge	Reported Value	0.140	0.140	0.000	0.000	0.000	0.000	0.000	0.000	0.000	0.000	0.000	0.000	0.000	0.000	0.140	0.140	0.140	0.140	0.140	0.140	0.140	0.140	0.140	0.140	0.140	0.140

Table C-4
5G mmW NR Total Exposure Ratio – Right Edge at 7 mm



	psPD	2.4 GHz WLAN MIMO		5 GHz WLAN MIMO		psPD + 2.4 GHz MIMO + 5 GHz MIMO
		Reported SAR	21.0 dBm	Reported SAR	17.0 dBm	
		W/kg		W/kg		1 + 3 + 8
Applicable Limit	1.0	1.6	1.6	1.6	1.6	1.0
Right Edge	Reported Value	0.428	0.476	0.302		
	Ratio to Limit	0.428	0.298	0.189		0.914

Table C-5
5G mmW NR Total Exposure Ratio- Right Edge at 0 mm

	psPD	2.4 GHz WLAN MIMO		5 GHz WLAN MIMO		psPD + 2.4 GHz MIMO + 5 GHz MIMO
		Reported SAR	11.0 dBm	Reported SAR	9.0 dBm	
		W/kg		W/kg		1 + 3 + 8
Applicable Limit	1.0	1.6	1.6	1.6	1.6	1.0
Right Edge	Reported Value	0.428	0.410	0.455		
	Ratio to Limit	0.428	0.256	0.284		0.969

Table C-6
5G mmW NR Total Exposure Ratio – Additional Considerations for Module 1 Back Side

	psPD	2.4 GHz WLAN Ant2		2.4 GHz WLAN MIMO		Bluetooth Ant 1		Bluetooth Ant 2		5 GHz WLAN Ant1		5 GHz WLAN Ant2		5 GHz WLAN MIMO		psPD + 5 GHz WLAN Ant 1		psPD + 5 GHz WLAN Ant 2		psPD + 2.4 GHz WLAN Ant 1 + 5 GHz WLAN Ant 1		psPD + 2.4 GHz WLAN Ant 2 + 5 GHz WLAN Ant 2		psPD + 2.4 GHz WLAN Ant 1 + 5 GHz WLAN Ant 2		psPD + 2.4 GHz WLAN Ant 1 + 5 GHz WLAN Ant 2 + 5 GHz WLAN MIMO	
		11.0 dBm	21.0 dBm	15.0 dBm	15.0 dBm	7.0 dBm	7.0 dBm	6.0 dBm	6.0 dBm	5.0 dBm	5.0 dBm	5.0 dBm	5.0 dBm	5.0 dBm	5.0 dBm	5.0 dBm	5.0 dBm	5.0 dBm	5.0 dBm	5.0 dBm	5.0 dBm	5.0 dBm	5.0 dBm	5.0 dBm	5.0 dBm	5.0 dBm	5.0 dBm
Applicable Limit	1	1	1	1	1	1	1	1	1	1	1	1	1	1	1	1	1	1	1	1	1	1	1	1	1	1	
Back Side	Reported Value	0.170	0.170	0.000	0.000	0.000	0.000	0.000	0.000	0.000	0.000	0.000	0.000	0.000	0.000	0.170	0.170	0.170	0.170	0.170	0.170	0.170	0.170	0.170	0.170	0.170	0.170

FCC ID: A3LSMT978U	 PCTEST Proud to be part of 	NEAR-FIELD POWER DENSITY EVALUATION REPORT		Approved by: Quality Manager
Test Dates: 06/03/20 – 07/15/20	DUT Type: Portable Tablet	APPENDIX C: Page 5 of 8		

TER for back side with Antenna 0 was excluded due to the spatial separation of the antennas per 248227 Section 6.1 and as described in 80-w2112-4 section G.1.3. In the below plots, it is demonstrated that the -10 dB contours of the SAR distributions have no overlap with the simulated area for power density. It was confirmed that all beams for both n260 and n261 operations are fully contained within the simulated area. Appendix A of the simulation report includes plots for all beams. Additionally, the maximum TER contribution for power density for back side is 75% per the reserve power margin setting of 3 dB. The SAR contribution of TER for BT/WLAN Operations is < 0.9.

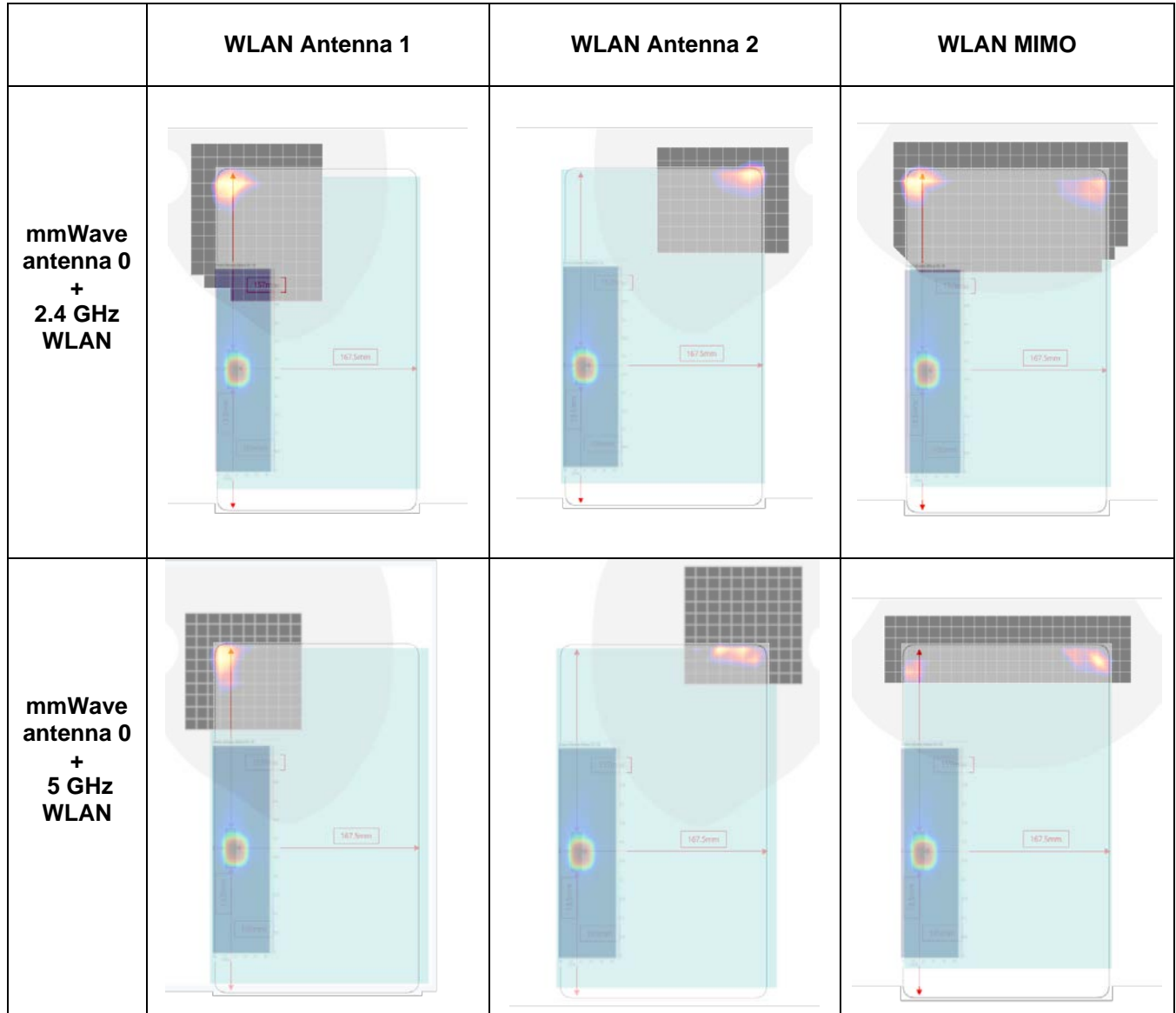





Figure C-1
DUT back side spatial separation of mmWave antenna 0 and WLAN antennas

FCC ID: A3LSMT978U	 PCTEST Proud to be part of 	NEAR-FIELD POWER DENSITY EVALUATION REPORT		Approved by: Quality Manager
Test Dates: 06/03/20 – 07/15/20	DUT Type: Portable Tablet			APPENDIX C: Page 6 of 8

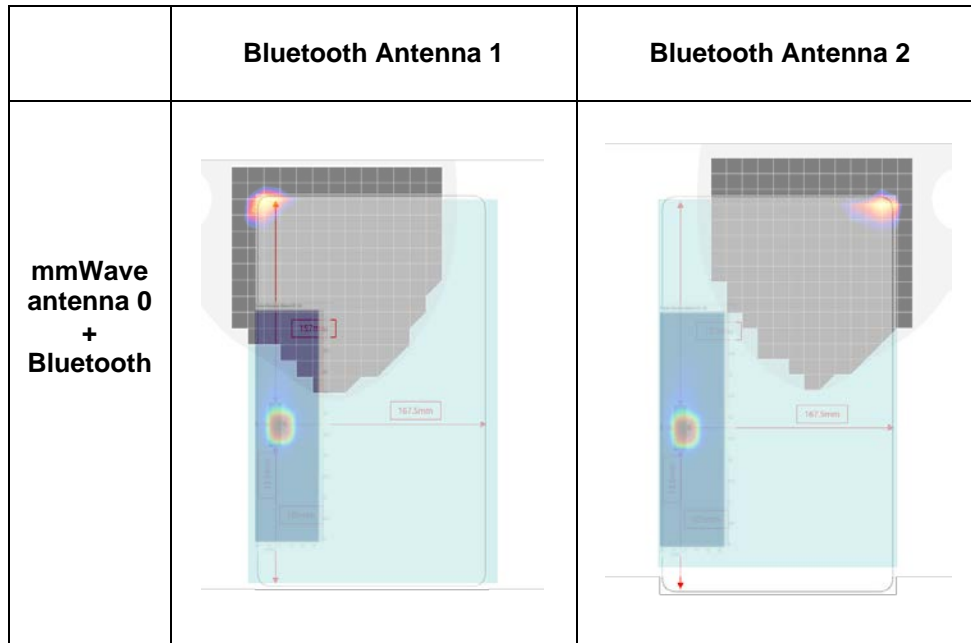

Figure C-2

DUT back side spatial separation of mmWave antenna 0 and Bluetooth antennas

Notes:

1. Worst-case power density results for each test configuration among all antenna arrays and among all supported bands were considered for TER analysis.
2. Back side for module 0 was not considered for TER analysis due to spatial separation of mmwave antenna and WLAN/BT antennas.
3. The worst-case between Adjusted Reported_psPD and Measured Total psPD x 0.75 was chosen for TER analysis. The bolded psPD values in Table C-1 indicate the worst-case Reported psPD used in TER analysis.
4. In WLAN MIMO operations, each antenna transmits at target powers to achieve the MIMO target powers as indicated above.
5. Per FCC guidance, for power density measurements, a test separation distance of 2 mm was used due to probe restraints.
6. Per FCC guidance, the positions that are not required to be evaluated for tablet SAR are not considered for TER analysis.
7. For SAR summation, the highest reported SAR across all test distances was used as the most conservative evaluation for simultaneous transmission analysis for each device edge.

The above numerical summed PD and SAR for all the worst-case simultaneous transmission conditions were below the Total Exposure Ratio. Therefore, the above analysis is sufficient to determine no further test cases are required and that simultaneous transmission is compliant to the FCC RF Exposure Limit.

FCC ID: A3LSMT978U		NEAR-FIELD POWER DENSITY EVALUATION REPORT		Approved by: Quality Manager
Test Dates: 06/03/20 – 07/15/20	DUT Type: Portable Tablet			APPENDIX C: Page 7 of 8

Mathematical Derivation of TER Compliance

$$\text{Total Normalized RFx} = \text{Normalized RFx}_{\text{Time Averaged WWAN}} + \text{Normalized RFx}_{\text{WLAN}} \leq 1.0 \quad (1)$$

Since WWAN Smart Transmit algorithm adds directly the time-averaged RF exposure from 4G and time-averaged RF exposure from 5G mmW NR, per chipset manufacturer's guidance, Normalized RF exposure from 4G and from 5G mmW NR could be assumed as

$$\text{Normalized RFx}_{\text{Time Averaged WWAN}} = \frac{4G \text{ SAR}}{4G \text{ SAR Limit}} + \frac{5G \text{ mmW NR psPD}}{5G \text{ mmW NR psPD Limit}} \leq 1.0 \quad (2)$$

Smart Transmit algorithm assumes that 4G and 5G mmW NR hotspots are co-located and therefore:

$$\text{Time Averaged WWAN} = [x(t) \times A] + [(1-x(t)) \times B] \leq 1.0 \text{ Normalized Limit} \quad (3)$$

$A = \text{Max normalized time-averaged SAR exposure from 4G}$

$B = \text{Max normalized time-averaged PD exposure from 5G mmW NR}$

$x(t) = \text{Ranges between } [0,1]$

$x(t) \times A = \text{Percentage of normalized time-averaged RF exposure from 4G}$

$(1-x(t)) \times B = \text{Remaining percentage of RF exposure contribution from 5G mmW NR}$

Smart Transmit controls "x" in real time such that the sum of these exposures never exceeds 1.0 Normalized Limit. If the equations below (4a, 4b) are proven, then, mathematically equation (5) would be proven.

$$A + \text{norm. SAR from WLAN} \leq 1.0 \text{ normalized limit} \quad (4a)$$

$$B + \text{norm. SAR from WLAN} \leq 1.0 \text{ normalized limit} \quad (4b)$$

$$[x(t) \times A] + [(1-x(t)) \times B] + \text{norm. SAR from WLAN} \leq 1.0 \text{ normalized limit} \quad (5)$$

Without 5G mmW NR, Smart Transmit limits the maximum RF exposure contributed from 4G to 100% normalized exposure. With 5G mmW NR, Smart Transmit limits the maximum RF exposure contributed from 5G mmW NR to 75% normalized exposure to guarantee at least 25% margin allocated to 4G LTE anchor to maintain the link. Therefore,

$$\text{Smart Tx WWAN: } A = \max(\text{normalized SAR exposure from 4G}) \leq 1.0 \text{ normalized limit} \quad (6a)$$

$$\text{Smart Tx WWAN: } B = 0.75 \times \max(\text{normalized PD exposure from 5G mmW NR}) \leq 1.0 \text{ normalized limit} \quad (6b)$$

To demonstrate simultaneous transmission compliance in equation (1), below equations (7a & 7b) obtained by combining equations (4a & 4b) and (6a & 6b), should be proven for simultaneous transmission compliance:

$$\text{Total Normalized RFx} = \text{Normalized SAR}_{4G \text{ WWAN}} + \text{Normalized SAR}_{\text{WLAN}} < 1.0 \quad (7a)$$



$$\text{Total Normalized RFx} = 0.75 \times \text{Normalized psPD}_{5G \text{ mmW NR WWAN}} + \text{Normalized SAR}_{\text{WLAN}} < 1.0 \quad (7b)$$

which are re-written as:

$$\text{Total Normalized RFx} = \frac{4G \text{ SAR}}{4G \text{ SAR Limit}} + \frac{\text{WLAN SAR}}{\text{WLAN SAR Limit}} < 1 \quad (8a)$$

$$\text{Total Normalized RFx} = 0.75 * \frac{5G \text{ mmW NR psPD}}{5G \text{ mmW NR psPD Limit}} + \frac{\text{WLAN SAR}}{\text{WLAN SAR Limit}} < 1 \quad (8b)$$

Analysis for equation (8a) is performed in Section 12 of FCC SAR Evaluation Report (Part 1). Analysis for equation (8b) is performed in this appendix.

FCC ID: A3LSMT978U	 PCTEST <small>Proud to be part of environment</small>	NEAR-FIELD POWER DENSITY EVALUATION REPORT		Approved by: Quality Manager
Test Dates: 06/03/20 – 07/15/20	DUT Type: Portable Tablet	APPENDIX C: Page 8 of 8		

APPENDIX E: EQUIPMENT CALIBRATION CERTIFICATES



Accredited by the Swiss Accreditation Service (SAS)
The Swiss Accreditation Service is one of the signatories to the EA
Multilateral Agreement for the recognition of calibration certificates

Accreditation No.: **SCS 0108**

Client **PC Test**

Certificate No: **EUmmWV3-9415_Feb20**

CALIBRATION CERTIFICATE

Object: **EUmmWV3 - SN:9415**

Calibration procedure(s): **QA CAL-02.v9, QA CAL-25.v7, QA CAL-42.v2**
Calibration procedure for E-field probes optimized for close near field evaluations in air

Calibration date: **February 14, 2020**

*MAB
4/18/20*

This calibration certificate documents the traceability to national standards, which realize the physical units of measurements (SI).
The measurements and the uncertainties with confidence probability are given on the following pages and are part of the certificate.

All calibrations have been conducted in the closed laboratory facility: environment temperature (22 ± 3)°C and humidity < 70%.

Calibration Equipment used (M&TE critical for calibration)

Primary Standards	ID	Cal Date (Certificate No.)	Scheduled Calibration
Power meter NRP	SN: 104778	03-Apr-19 (No. 217-02892/02893)	Apr-20
Power sensor NRP-Z91	SN: 103244	03-Apr-19 (No. 217-02892)	Apr-20
Power sensor NRP-Z91	SN: 103245	03-Apr-19 (No. 217-02893)	Apr-20
Reference 20 dB Attenuator	SN: S5277 (20x)	04-Apr-19 (No. 217-02894)	Apr-20
Reference Probe ER3DV6	SN: 2328	05-Oct-19 (No. ER3-2328_Oct19)	Oct-20
DAE4	SN: 789	27-Dec-19 (No. DAE4-789_Dec19)	Dec-20
Secondary Standards	ID	Check Date (in house)	Scheduled Check
Power meter E4419B	SN: GB41293874	06-Apr-16 (in house check Jun-18)	In house check: Jun-20
Power sensor E4412A	SN: MY41498087	06-Apr-16 (in house check Jun-18)	In house check: Jun-20
Power sensor E4412A	SN: 000110210	06-Apr-16 (in house check Jun-18)	In house check: Jun-20
RF generator HP 8648C	SN: US3642U01700	04-Aug-99 (in house check Jun-18)	In house check: Jun-20
Network Analyzer HP 8753E	SN: US37390585	18-Oct-01 (in house check Oct-19)	In house check: Oct-20

Calibrated by:	Name Jeton Kastrati	Function Laboratory Technician	Signature
Approved by:	Name Katja Pokovic	Technical Manager	

Issued: February 15, 2020

This calibration certificate shall not be reproduced except in full without written approval of the laboratory.



Accredited by the Swiss Accreditation Service (SAS)

Accreditation No.: **SCS 0108**

The Swiss Accreditation Service is one of the signatories to the EA
Multilateral Agreement for the recognition of calibration certificates

Glossary:

NORM _{x,y,z}	sensitivity in free space
DCP	diode compression point
CF	crest factor (1/duty_cycle) of the RF signal
A, B, C, D	modulation dependent linearization parameters
Polarization φ	φ rotation around probe axis
Polarization ϑ	ϑ rotation around an axis that is in the plane normal to probe axis (at measurement center), i.e., $\vartheta = 0$ is normal to probe axis
Connector Angle	information used in DASY system to align probe sensor X to the robot coordinate system
Sensor Angles	sensor deviation from the probe axis, used to calculate the field orientation and polarization
k	is the wave propagation direction

Calibration is Performed According to the Following Standards:

- IEEE Std 1309-2005, "IEEE Standard for calibration of electromagnetic field sensors and probes, excluding antennas, from 9 kHz to 40 GHz", December 2005

Methods Applied and Interpretation of Parameters:

- NORM_{x,y,z}**: Assessed for E-field polarization $\vartheta = 0$ for XY sensors and $\vartheta = 90$ for Z sensor ($f \leq 900$ MHz in TEM-cell; $f > 1800$ MHz: R22 waveguide). For frequencies > 6 GHz, the far field in front of waveguide horn antennas is measured for a set of frequencies in various waveguide bands up to 110 GHz.
- DCP_{x,y,z}**: DCP are numerical linearization parameters assessed based on the data of power sweep with CW signal (no uncertainty required). DCP does not depend on frequency nor media.
- PAR**: PAR is the Peak to Average Ratio that is not calibrated but determined based on the signal characteristics
- The frequency sensor model parameters are determined prior to calibration based on a frequency sweep (sensor model involving resistors R, R_p, inductance L and capacitors C, C_p).
- A_{x,y,z}; B_{x,y,z}; C_{x,y,z}; D_{x,y,z}; VR_{x,y,z}; A, B, C, D** are numerical linearization parameters assessed based on the data of power sweep for specific modulation signal. The parameters do not depend on frequency nor media. VR is the maximum calibration range expressed in RMS voltage across the diode.
- Sensor Offset**: The sensor offset corresponds to the mechanical from the probe tip (on probe axis). No tolerance required.
- Connector Angle**: The angle is assessed using the information gained by determining the NORM_x (no uncertainty required).
- Equivalent Sensor Angle**: The two probe sensors are mounted in the same plane at different angles. The angles are assessed using the information gained by determining the NORM_x (no uncertainty required).
- Spherical isotropy (3D deviation from isotropy)**: in a locally homogeneous field realized using an open waveguide / horn setup.

DASY - Parameters of Probe: EUmmWV3 - SN:9415

Basic Calibration Parameters

	Sensor X	Sensor Y	Unc (k=2)
Norm ($\mu V/(V/m)^2$)	0.02252	0.02610	$\pm 10.1 \%$
DCP (mV) ^B	100.0	113.0	
Equivalent Sensor Angle	-60.2	34.7	

Calibration results for Frequency Response (750 MHz – 110 GHz)

Frequency GHz	Target E-Field V/m	Deviation Sensor X dB	Deviation Sensor Y dB	Unc (k=2) dB
0.75	77.2	0.01	0.12	± 0.43 dB
1.8	140.4	0.09	0.12	± 0.43 dB
2	133.0	0.04	0.07	± 0.43 dB
2.2	124.8	0.04	0.04	± 0.43 dB
2.5	123.0	-0.06	-0.08	± 0.43 dB
3.5	256.2	0.07	-0.02	± 0.43 dB
3.7	249.8	0.12	0.04	± 0.43 dB
6.6	41.8	0.57	0.29	± 0.98 dB
8	48.4	0.12	-0.21	± 0.98 dB
10	54.4	-0.05	-0.01	± 0.98 dB
15	71.5	-0.13	-0.31	± 0.98 dB
18	85.3	0.03	0.23	± 0.98 dB
26.6	96.9	-0.04	0.11	± 0.98 dB
30	92.6	0.12	0.12	± 0.98 dB
35	93.7	-0.40	-0.14	± 0.98 dB
40	91.5	-0.48	-0.49	± 0.98 dB
50	19.6	-0.21	-0.42	± 0.98 dB
55	22.4	0.75	0.21	± 0.98 dB
60	23.0	0.02	-0.01	± 0.98 dB
65	27.4	-0.31	0.05	± 0.98 dB
70	23.9	0.13	0.07	± 0.98 dB
75	20.0	-0.07	0.07	± 0.98 dB
75	14.8	-0.06	-0.08	± 0.98 dB
80	22.5	0.04	0.18	± 0.98 dB
85	22.8	0.01	-0.05	± 0.98 dB
90	23.8	0.03	0.06	± 0.98 dB
92	23.9	-0.09	-0.16	± 0.98 dB
95	20.5	-0.10	-0.17	± 0.98 dB
97	24.4	0.02	-0.07	± 0.98 dB
100	22.6	-0.04	-0.04	± 0.98 dB
105	22.7	-0.08	0.00	± 0.98 dB
110	19.7	0.14	0.14	± 0.98 dB

The reported uncertainty of measurement is stated as the standard uncertainty of measurement multiplied by the coverage factor k=2, which for a normal distribution corresponds to a coverage probability of approximately 95%.

^B Numerical linearization parameter: uncertainty not required.

^E Uncertainty is determined using the max. deviation from linear response applying rectangular distribution and is expressed for the square of the field value.

DASY - Parameters of Probe: EUmmWV3 - SN:9415

Calibration Results for Modulation Response

UID	Communication System Name		A dB	B dB/μV	C	D dB	VR mV	Max dev.	Max Unc ^E (k=2)
0	CW	X	0.00	0.00	1.00	0.00	110.9	± 3.8 %	± 4.7 %
		Y	0.00	0.00	1.00		95.6		
10352-AAA	Pulse Waveform (200Hz, 10%)	X	2.49	60.00	13.67	10.00	6.0	± 1.2 %	± 9.6 %
		Y	2.06	60.00	14.31		6.0		
10353-AAA	Pulse Waveform (200Hz, 20%)	X	1.63	60.00	12.61	6.99	12.0	± 0.8 %	± 9.6 %
		Y	1.36	60.00	13.35		12.0		
10354-AAA	Pulse Waveform (200Hz, 40%)	X	0.92	60.00	11.37	3.98	23.0	± 0.9 %	± 9.6 %
		Y	0.79	60.00	12.22		23.0		
10355-AAA	Pulse Waveform (200Hz, 60%)	X	0.56	60.00	10.42	2.22	27.0	± 0.8 %	± 9.6 %
		Y	0.50	60.00	11.35		27.0		
10387-AAA	QPSK Waveform, 1 MHz	X	1.00	60.00	11.30	1.00	22.0	± 2.1 %	± 9.6 %
		Y	0.99	60.00	11.63		22.0		
10388-AAA	QPSK Waveform, 10 MHz	X	1.26	60.00	11.64	0.00	22.0	± 0.7 %	± 9.6 %
		Y	1.22	60.00	11.83		22.0		
10396-AAA	64-QAM Waveform, 100 kHz	X	2.61	62.98	15.02	3.01	17.0	± 0.6 %	± 9.6 %
		Y	2.18	61.08	14.03		17.0		
10399-AAA	64-QAM Waveform, 40 MHz	X	2.12	60.00	12.25	0.00	19.0	± 0.7 %	± 9.6 %
		Y	2.00	60.00	12.36		19.0		
10414-AAA	WLAN CCDF, 64-QAM, 40MHz	X	3.22	60.00	12.72	0.00	12.0	± 0.9 %	± 9.6 %
		Y	3.01	60.00	12.79		12.0		

Note: For details on all calibrated UID parameters see Appendix

Calibration Results for Linearity Response

Frequency GHz	Target E-Field V/m	Deviation Sensor X dB	Deviation Sensor Y dB	Unc (k=2) dB
0.9	50.0	-0.14	-0.14	± 0.2 dB
0.9	100.0	-0.11	-0.02	± 0.2 dB
0.9	500.0	0.02	0.01	± 0.2 dB
0.9	1000.0	0.05	0.03	± 0.2 dB
0.9	1500.0	0.04	0.03	± 0.2 dB
0.9	2000.0	0.00	0.01	± 0.2 dB

Sensor Frequency Model Parameters (750 MHz – 78 GHz)

	Sensor X	Sensor Y
R (Ω)	41.29	47.24
R _p (Ω)	94.83	89.63
L (nH)	0.03642	0.04028
C (pF)	0.2073	0.2715
C _p (pF)	0.1227	0.1167

Sensor Frequency Model Parameters (55 GHz – 110 GHz)

	Sensor X	Sensor Y
R (Ω)	29.45	32.76
R _p (Ω)	99.11	94.92
L (nH)	0.03900	0.03350
C (pF)	0.1315	0.1918
C _p (pF)	0.1283	0.1320

DASY - Parameters of Probe: EUmmWV3 - SN:9415

Sensor Model Parameters

	C1 fF	C2 fF	α V ⁻¹	T1 ms.V ⁻²	T2 ms.V ⁻¹	T3 ms	T4 V ⁻²	T5 V ⁻¹	T6
X	34.6	259.81	35.60	0.92	5.09	4.98	0.00	1.54	1.01
Y	34.5	242.14	31.75	0.92	4.21	5.00	0.00	1.45	1.01

Other Probe Parameters

Sensor Arrangement	Rectangular
Connector Angle (°)	185.2
Mechanical Surface Detection Mode	enabled
Optical Surface Detection Mode	disabled
Probe Overall Length	320 mm
Probe Body Diameter	8 mm
Tip Length	23 mm
Tip Diameter	8.0 mm
Probe Tip to Sensor X Calibration Point	1.5 mm
Probe Tip to Sensor Y Calibration Point	1.5 mm

Deviation from Isotropy in Air

f = 30, 60 GHz

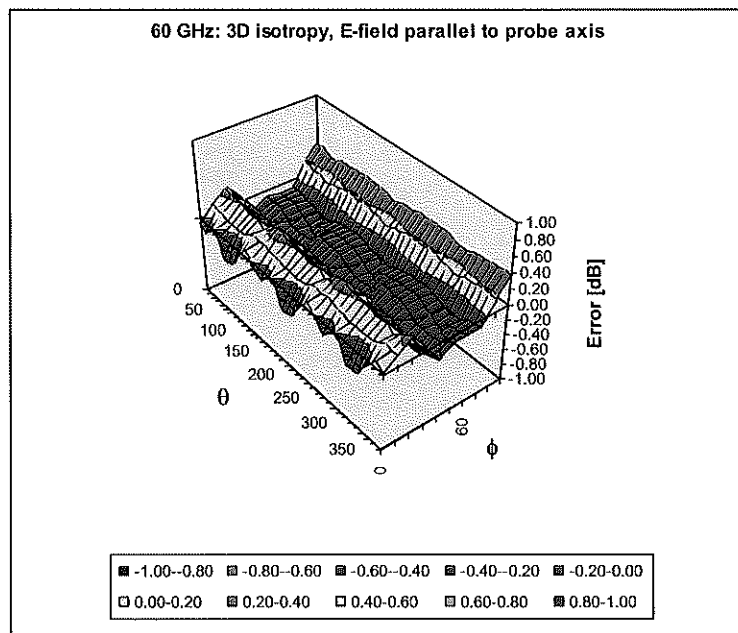
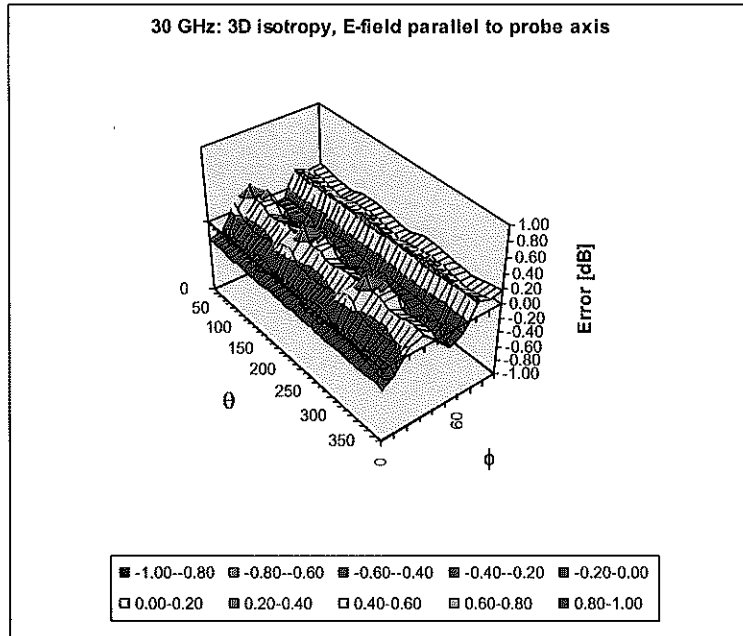

Probe isotropy for E_{tot} : probe rotated $\phi = 0^\circ$ to 360° , tilted from field propagation direction \vec{k}
 Parallel to the field propagation ($\psi = 0^\circ - 90^\circ$) at 30 GHz: deviation within ± 0.34 dB
 Parallel to the field propagation ($\psi = 0^\circ - 90^\circ$) at 60 GHz: deviation within ± 0.37 dB

Appendix: Modulation Calibration Parameters

UID	Rev	Communication System Name	Group	PAR (dB)	Unc ^E (k=2)
0		CW	CW	0.00	± 4.7 %
10010	CAA	SAR Validation (Square, 100ms, 10ms)	Test	10.00	± 9.6 %
10011	CAB	UMTS-FDD (WCDMA)	WCDMA	2.91	± 9.6 %
10012	CAB	IEEE 802.11b WiFi 2.4 GHz (DSSS, 1 Mbps)	WLAN	1.87	± 9.6 %
10013	CAB	IEEE 802.11g WiFi 2.4 GHz (DSSS-OFDM, 6 Mbps)	WLAN	9.46	± 9.6 %
10021	DAC	GSM-FDD (TDMA, GMSK)	GSM	9.39	± 9.6 %
10023	DAC	GPRS-FDD (TDMA, GMSK, TN 0)	GSM	9.57	± 9.6 %
10024	DAC	GPRS-FDD (TDMA, GMSK, TN 0-1)	GSM	6.56	± 9.6 %
10025	DAC	EDGE-FDD (TDMA, 8PSK, TN 0)	GSM	12.62	± 9.6 %
10026	DAC	EDGE-FDD (TDMA, 8PSK, TN 0-1)	GSM	9.55	± 9.6 %
10027	DAC	GPRS-FDD (TDMA, GMSK, TN 0-1-2)	GSM	4.80	± 9.6 %
10028	DAC	GPRS-FDD (TDMA, GMSK, TN 0-1-2-3)	GSM	3.55	± 9.6 %
10029	DAC	EDGE-FDD (TDMA, 8PSK, TN 0-1-2)	GSM	7.78	± 9.6 %
10030	CAA	IEEE 802.15.1 Bluetooth (GFSK, DH1)	Bluetooth	5.30	± 9.6 %
10031	CAA	IEEE 802.15.1 Bluetooth (GFSK, DH3)	Bluetooth	1.87	± 9.6 %
10032	CAA	IEEE 802.15.1 Bluetooth (GFSK, DH5)	Bluetooth	1.16	± 9.6 %
10033	CAA	IEEE 802.15.1 Bluetooth (PI/4-DQPSK, DH1)	Bluetooth	7.74	± 9.6 %
10034	CAA	IEEE 802.15.1 Bluetooth (PI/4-DQPSK, DH3)	Bluetooth	4.53	± 9.6 %
10035	CAA	IEEE 802.15.1 Bluetooth (PI/4-DQPSK, DH5)	Bluetooth	3.83	± 9.6 %
10036	CAA	IEEE 802.15.1 Bluetooth (8-DPSK, DH1)	Bluetooth	8.01	± 9.6 %
10037	CAA	IEEE 802.15.1 Bluetooth (8-DPSK, DH3)	Bluetooth	4.77	± 9.6 %
10038	CAA	IEEE 802.15.1 Bluetooth (8-DPSK, DH5)	Bluetooth	4.10	± 9.6 %
10039	CAB	CDMA2000 (1xRTT, RC1)	CDMA2000	4.57	± 9.6 %
10042	CAB	IS-54 / IS-136 FDD (TDMA/FDM, PI/4-DQPSK, Halfrate)	AMPS	7.78	± 9.6 %
10044	CAA	IS-91/EIA/TIA-553 FDD (FDMA, FM)	AMPS	0.00	± 9.6 %
10048	CAA	DECT (TDD, TDMA/FDM, GFSK, Full Slot, 24)	DECT	13.80	± 9.6 %
10049	CAA	DECT (TDD, TDMA/FDM, GFSK, Double Slot, 12)	DECT	10.79	± 9.6 %
10056	CAA	UMTS-TDD (TD-SCDMA, 1.28 Mcps)	TD-SCDMA	11.01	± 9.6 %
10058	DAC	EDGE-FDD (TDMA, 8PSK, TN 0-1-2-3)	GSM	6.52	± 9.6 %
10059	CAB	IEEE 802.11b WiFi 2.4 GHz (DSSS, 2 Mbps)	WLAN	2.12	± 9.6 %
10060	CAB	IEEE 802.11b WiFi 2.4 GHz (DSSS, 5.5 Mbps)	WLAN	2.83	± 9.6 %
10061	CAB	IEEE 802.11b WiFi 2.4 GHz (DSSS, 11 Mbps)	WLAN	3.60	± 9.6 %
10062	CAC	IEEE 802.11a/h WiFi 5 GHz (OFDM, 6 Mbps)	WLAN	8.68	± 9.6 %
10063	CAC	IEEE 802.11a/h WiFi 5 GHz (OFDM, 9 Mbps)	WLAN	8.63	± 9.6 %
10064	CAC	IEEE 802.11a/h WiFi 5 GHz (OFDM, 12 Mbps)	WLAN	9.09	± 9.6 %
10065	CAC	IEEE 802.11a/h WiFi 5 GHz (OFDM, 18 Mbps)	WLAN	9.00	± 9.6 %
10066	CAC	IEEE 802.11a/h WiFi 5 GHz (OFDM, 24 Mbps)	WLAN	9.38	± 9.6 %
10067	CAC	IEEE 802.11a/h WiFi 5 GHz (OFDM, 36 Mbps)	WLAN	10.12	± 9.6 %
10068	CAC	IEEE 802.11a/h WiFi 5 GHz (OFDM, 48 Mbps)	WLAN	10.24	± 9.6 %
10069	CAC	IEEE 802.11a/h WiFi 5 GHz (OFDM, 54 Mbps)	WLAN	10.56	± 9.6 %
10071	CAB	IEEE 802.11g WiFi 2.4 GHz (DSSS/OFDM, 9 Mbps)	WLAN	9.83	± 9.6 %
10072	CAB	IEEE 802.11g WiFi 2.4 GHz (DSSS/OFDM, 12 Mbps)	WLAN	9.62	± 9.6 %
10073	CAB	IEEE 802.11g WiFi 2.4 GHz (DSSS/OFDM, 18 Mbps)	WLAN	9.94	± 9.6 %
10074	CAB	IEEE 802.11g WiFi 2.4 GHz (DSSS/OFDM, 24 Mbps)	WLAN	10.30	± 9.6 %
10075	CAB	IEEE 802.11g WiFi 2.4 GHz (DSSS/OFDM, 36 Mbps)	WLAN	10.77	± 9.6 %
10076	CAB	IEEE 802.11g WiFi 2.4 GHz (DSSS/OFDM, 48 Mbps)	WLAN	10.94	± 9.6 %
10077	CAB	IEEE 802.11g WiFi 2.4 GHz (DSSS/OFDM, 54 Mbps)	WLAN	11.00	± 9.6 %
10081	CAB	CDMA2000 (1xRTT, RC3)	CDMA2000	3.97	± 9.6 %
10082	CAB	IS-54 / IS-136 FDD (TDMA/FDM, PI/4-DQPSK, Fullrate)	AMPS	4.77	± 9.6 %
10090	DAC	GPRS-FDD (TDMA, GMSK, TN 0-4)	GSM	6.56	± 9.6 %
10097	CAB	UMTS-FDD (HSDPA)	WCDMA	3.98	± 9.6 %
10098	CAB	UMTS-FDD (HSUPA, Subtest 2)	WCDMA	3.98	± 9.6 %
10099	DAC	EDGE-FDD (TDMA, 8PSK, TN 0-4)	GSM	9.55	± 9.6 %
10100	CAE	LTE-FDD (SC-FDMA, 100% RB, 20 MHz, QPSK)	LTE-FDD	5.67	± 9.6 %
10101	CAE	LTE-FDD (SC-FDMA, 100% RB, 20 MHz, 16-QAM)	LTE-FDD	6.42	± 9.6 %
10102	CAE	LTE-FDD (SC-FDMA, 100% RB, 20 MHz, 64-QAM)	LTE-FDD	6.60	± 9.6 %
10103	CAG	LTE-TDD (SC-FDMA, 100% RB, 20 MHz, QPSK)	LTE-TDD	9.29	± 9.6 %
10104	CAG	LTE-TDD (SC-FDMA, 100% RB, 20 MHz, 16-QAM)	LTE-TDD	9.97	± 9.6 %
10105	CAG	LTE-TDD (SC-FDMA, 100% RB, 20 MHz, 64-QAM)	LTE-TDD	10.01	± 9.6 %
10108	CAG	LTE-FDD (SC-FDMA, 100% RB, 10 MHz, QPSK)	LTE-FDD	5.80	± 9.6 %

10109	CAG	LTE-FDD (SC-FDMA, 100% RB, 10 MHz, 16-QAM)	LTE-FDD	6.43	± 9.6 %
10110	CAG	LTE-FDD (SC-FDMA, 100% RB, 5 MHz, QPSK)	LTE-FDD	5.75	± 9.6 %
10111	CAG	LTE-FDD (SC-FDMA, 100% RB, 5 MHz, 16-QAM)	LTE-FDD	6.44	± 9.6 %
10112	CAG	LTE-FDD (SC-FDMA, 100% RB, 10 MHz, 64-QAM)	LTE-FDD	6.59	± 9.6 %
10113	CAG	LTE-FDD (SC-FDMA, 100% RB, 5 MHz, 64-QAM)	LTE-FDD	6.62	± 9.6 %
10114	CAC	IEEE 802.11n (HT Greenfield, 13.5 Mbps, BPSK)	WLAN	8.10	± 9.6 %
10115	CAC	IEEE 802.11n (HT Greenfield, 81 Mbps, 16-QAM)	WLAN	8.46	± 9.6 %
10116	CAC	IEEE 802.11n (HT Greenfield, 135 Mbps, 64-QAM)	WLAN	8.15	± 9.6 %
10117	CAC	IEEE 802.11n (HT Mixed, 13.5 Mbps, BPSK)	WLAN	8.07	± 9.6 %
10118	CAC	IEEE 802.11n (HT Mixed, 81 Mbps, 16-QAM)	WLAN	8.59	± 9.6 %
10119	CAC	IEEE 802.11n (HT Mixed, 135 Mbps, 64-QAM)	WLAN	8.13	± 9.6 %
10140	CAE	LTE-FDD (SC-FDMA, 100% RB, 15 MHz, 16-QAM)	LTE-FDD	6.49	± 9.6 %
10141	CAE	LTE-FDD (SC-FDMA, 100% RB, 15 MHz, 64-QAM)	LTE-FDD	6.53	± 9.6 %
10142	CAE	LTE-FDD (SC-FDMA, 100% RB, 3 MHz, QPSK)	LTE-FDD	5.73	± 9.6 %
10143	CAE	LTE-FDD (SC-FDMA, 100% RB, 3 MHz, 16-QAM)	LTE-FDD	6.35	± 9.6 %
10144	CAE	LTE-FDD (SC-FDMA, 100% RB, 3 MHz, 64-QAM)	LTE-FDD	6.65	± 9.6 %
10145	CAF	LTE-FDD (SC-FDMA, 100% RB, 1.4 MHz, QPSK)	LTE-FDD	5.76	± 9.6 %
10146	CAF	LTE-FDD (SC-FDMA, 100% RB, 1.4 MHz, 16-QAM)	LTE-FDD	6.41	± 9.6 %
10147	CAF	LTE-FDD (SC-FDMA, 100% RB, 1.4 MHz, 64-QAM)	LTE-FDD	6.72	± 9.6 %
10149	CAE	LTE-FDD (SC-FDMA, 50% RB, 20 MHz, 16-QAM)	LTE-FDD	6.42	± 9.6 %
10150	CAE	LTE-FDD (SC-FDMA, 50% RB, 20 MHz, 64-QAM)	LTE-FDD	6.60	± 9.6 %
10151	CAG	LTE-TDD (SC-FDMA, 50% RB, 20 MHz, QPSK)	LTE-TDD	9.28	± 9.6 %
10152	CAG	LTE-TDD (SC-FDMA, 50% RB, 20 MHz, 16-QAM)	LTE-TDD	9.92	± 9.6 %
10153	CAG	LTE-TDD (SC-FDMA, 50% RB, 20 MHz, 64-QAM)	LTE-TDD	10.05	± 9.6 %
10154	CAG	LTE-FDD (SC-FDMA, 50% RB, 10 MHz, QPSK)	LTE-FDD	5.75	± 9.6 %
10155	CAG	LTE-FDD (SC-FDMA, 50% RB, 10 MHz, 16-QAM)	LTE-FDD	6.43	± 9.6 %
10156	CAG	LTE-FDD (SC-FDMA, 50% RB, 5 MHz, QPSK)	LTE-FDD	5.79	± 9.6 %
10157	CAG	LTE-FDD (SC-FDMA, 50% RB, 5 MHz, 16-QAM)	LTE-FDD	6.49	± 9.6 %
10158	CAG	LTE-FDD (SC-FDMA, 50% RB, 10 MHz, 64-QAM)	LTE-FDD	6.62	± 9.6 %
10159	CAG	LTE-FDD (SC-FDMA, 50% RB, 5 MHz, 64-QAM)	LTE-FDD	6.56	± 9.6 %
10160	CAE	LTE-FDD (SC-FDMA, 50% RB, 15 MHz, QPSK)	LTE-FDD	5.82	± 9.6 %
10161	CAE	LTE-FDD (SC-FDMA, 50% RB, 15 MHz, 16-QAM)	LTE-FDD	6.43	± 9.6 %
10162	CAE	LTE-FDD (SC-FDMA, 50% RB, 15 MHz, 64-QAM)	LTE-FDD	6.58	± 9.6 %
10166	CAF	LTE-FDD (SC-FDMA, 50% RB, 1.4 MHz, QPSK)	LTE-FDD	5.46	± 9.6 %
10167	CAF	LTE-FDD (SC-FDMA, 50% RB, 1.4 MHz, 16-QAM)	LTE-FDD	6.21	± 9.6 %
10168	CAF	LTE-FDD (SC-FDMA, 50% RB, 1.4 MHz, 64-QAM)	LTE-FDD	6.79	± 9.6 %
10169	CAE	LTE-FDD (SC-FDMA, 1 RB, 20 MHz, QPSK)	LTE-FDD	5.73	± 9.6 %
10170	CAE	LTE-FDD (SC-FDMA, 1 RB, 20 MHz, 16-QAM)	LTE-FDD	6.52	± 9.6 %
10171	AAE	LTE-FDD (SC-FDMA, 1 RB, 20 MHz, 64-QAM)	LTE-FDD	6.49	± 9.6 %
10172	CAG	LTE-TDD (SC-FDMA, 1 RB, 20 MHz, QPSK)	LTE-TDD	9.21	± 9.6 %
10173	CAG	LTE-TDD (SC-FDMA, 1 RB, 20 MHz, 16-QAM)	LTE-TDD	9.48	± 9.6 %
10174	CAG	LTE-TDD (SC-FDMA, 1 RB, 20 MHz, 64-QAM)	LTE-TDD	10.25	± 9.6 %
10175	CAG	LTE-FDD (SC-FDMA, 1 RB, 10 MHz, QPSK)	LTE-FDD	5.72	± 9.6 %
10176	CAG	LTE-FDD (SC-FDMA, 1 RB, 10 MHz, 16-QAM)	LTE-FDD	6.52	± 9.6 %
10177	CAI	LTE-FDD (SC-FDMA, 1 RB, 5 MHz, QPSK)	LTE-FDD	5.73	± 9.6 %
10178	CAG	LTE-FDD (SC-FDMA, 1 RB, 5 MHz, 16-QAM)	LTE-FDD	6.52	± 9.6 %
10179	CAG	LTE-FDD (SC-FDMA, 1 RB, 10 MHz, 64-QAM)	LTE-FDD	6.50	± 9.6 %
10180	CAG	LTE-FDD (SC-FDMA, 1 RB, 5 MHz, 64-QAM)	LTE-FDD	6.50	± 9.6 %
10181	CAE	LTE-FDD (SC-FDMA, 1 RB, 15 MHz, QPSK)	LTE-FDD	5.72	± 9.6 %
10182	CAE	LTE-FDD (SC-FDMA, 1 RB, 15 MHz, 16-QAM)	LTE-FDD	6.52	± 9.6 %
10183	AAD	LTE-FDD (SC-FDMA, 1 RB, 15 MHz, 64-QAM)	LTE-FDD	6.50	± 9.6 %
10184	CAE	LTE-FDD (SC-FDMA, 1 RB, 3 MHz, QPSK)	LTE-FDD	5.73	± 9.6 %
10185	CAE	LTE-FDD (SC-FDMA, 1 RB, 3 MHz, 16-QAM)	LTE-FDD	6.51	± 9.6 %
10186	AAE	LTE-FDD (SC-FDMA, 1 RB, 3 MHz, 64-QAM)	LTE-FDD	6.50	± 9.6 %
10187	CAF	LTE-FDD (SC-FDMA, 1 RB, 1.4 MHz, QPSK)	LTE-FDD	5.73	± 9.6 %
10188	CAF	LTE-FDD (SC-FDMA, 1 RB, 1.4 MHz, 16-QAM)	LTE-FDD	6.52	± 9.6 %
10189	AAF	LTE-FDD (SC-FDMA, 1 RB, 1.4 MHz, 64-QAM)	LTE-FDD	6.50	± 9.6 %
10193	CAC	IEEE 802.11n (HT Greenfield, 6.5 Mbps, BPSK)	WLAN	8.09	± 9.6 %
10194	CAC	IEEE 802.11n (HT Greenfield, 39 Mbps, 16-QAM)	WLAN	8.12	± 9.6 %
10195	CAC	IEEE 802.11n (HT Greenfield, 65 Mbps, 64-QAM)	WLAN	8.21	± 9.6 %
10196	CAC	IEEE 802.11n (HT Mixed, 6.5 Mbps, BPSK)	WLAN	8.10	± 9.6 %
10197	CAC	IEEE 802.11n (HT Mixed, 39 Mbps, 16-QAM)	WLAN	8.13	± 9.6 %
10198	CAC	IEEE 802.11n (HT Mixed, 65 Mbps, 64-QAM)	WLAN	8.27	± 9.6 %
10219	CAC	IEEE 802.11n (HT Mixed, 7.2 Mbps, BPSK)	WLAN	8.03	± 9.6 %

10220	CAC	IEEE 802.11n (HT Mixed, 43.3 Mbps, 16-QAM)	WLAN	8.13	± 9.6 %
10221	CAC	IEEE 802.11n (HT Mixed, 72.2 Mbps, 64-QAM)	WLAN	8.27	± 9.6 %
10222	CAC	IEEE 802.11n (HT Mixed, 15 Mbps, BPSK)	WLAN	8.06	± 9.6 %
10223	CAC	IEEE 802.11n (HT Mixed, 90 Mbps, 16-QAM)	WLAN	8.48	± 9.6 %
10224	CAC	IEEE 802.11n (HT Mixed, 150 Mbps, 64-QAM)	WLAN	8.08	± 9.6 %
10225	CAB	UMTS-FDD (HSPA+)	WCDMA	5.97	± 9.6 %
10226	CAB	LTE-TDD (SC-FDMA, 1 RB, 1.4 MHz, 16-QAM)	LTE-TDD	9.49	± 9.6 %
10227	CAB	LTE-TDD (SC-FDMA, 1 RB, 1.4 MHz, 64-QAM)	LTE-TDD	10.26	± 9.6 %
10228	CAB	LTE-TDD (SC-FDMA, 1 RB, 1.4 MHz, QPSK)	LTE-TDD	9.22	± 9.6 %
10229	CAD	LTE-TDD (SC-FDMA, 1 RB, 3 MHz, 16-QAM)	LTE-TDD	9.48	± 9.6 %
10230	CAD	LTE-TDD (SC-FDMA, 1 RB, 3 MHz, 64-QAM)	LTE-TDD	10.25	± 9.6 %
10231	CAD	LTE-TDD (SC-FDMA, 1 RB, 3 MHz, QPSK)	LTE-TDD	9.19	± 9.6 %
10232	CAG	LTE-TDD (SC-FDMA, 1 RB, 5 MHz, 16-QAM)	LTE-TDD	9.48	± 9.6 %
10233	CAG	LTE-TDD (SC-FDMA, 1 RB, 5 MHz, 64-QAM)	LTE-TDD	10.25	± 9.6 %
10234	CAG	LTE-TDD (SC-FDMA, 1 RB, 5 MHz, QPSK)	LTE-TDD	9.21	± 9.6 %
10235	CAG	LTE-TDD (SC-FDMA, 1 RB, 10 MHz, 16-QAM)	LTE-TDD	9.48	± 9.6 %
10236	CAG	LTE-TDD (SC-FDMA, 1 RB, 10 MHz, 64-QAM)	LTE-TDD	10.25	± 9.6 %
10237	CAG	LTE-TDD (SC-FDMA, 1 RB, 10 MHz, QPSK)	LTE-TDD	9.21	± 9.6 %
10238	CAF	LTE-TDD (SC-FDMA, 1 RB, 15 MHz, 16-QAM)	LTE-TDD	9.48	± 9.6 %
10239	CAF	LTE-TDD (SC-FDMA, 1 RB, 15 MHz, 64-QAM)	LTE-TDD	10.25	± 9.6 %
10240	CAF	LTE-TDD (SC-FDMA, 1 RB, 15 MHz, QPSK)	LTE-TDD	9.21	± 9.6 %
10241	CAB	LTE-TDD (SC-FDMA, 50% RB, 1.4 MHz, 16-QAM)	LTE-TDD	9.82	± 9.6 %
10242	CAB	LTE-TDD (SC-FDMA, 50% RB, 1.4 MHz, 64-QAM)	LTE-TDD	9.86	± 9.6 %
10243	CAB	LTE-TDD (SC-FDMA, 50% RB, 1.4 MHz, QPSK)	LTE-TDD	9.46	± 9.6 %
10244	CAD	LTE-TDD (SC-FDMA, 50% RB, 3 MHz, 16-QAM)	LTE-TDD	10.06	± 9.6 %
10245	CAD	LTE-TDD (SC-FDMA, 50% RB, 3 MHz, 64-QAM)	LTE-TDD	10.06	± 9.6 %
10246	CAD	LTE-TDD (SC-FDMA, 50% RB, 3 MHz, QPSK)	LTE-TDD	9.30	± 9.6 %
10247	CAG	LTE-TDD (SC-FDMA, 50% RB, 5 MHz, 16-QAM)	LTE-TDD	9.91	± 9.6 %
10248	CAG	LTE-TDD (SC-FDMA, 50% RB, 5 MHz, 64-QAM)	LTE-TDD	10.09	± 9.6 %
10249	CAG	LTE-TDD (SC-FDMA, 50% RB, 5 MHz, QPSK)	LTE-TDD	9.29	± 9.6 %
10250	CAG	LTE-TDD (SC-FDMA, 50% RB, 10 MHz, 16-QAM)	LTE-TDD	9.81	± 9.6 %
10251	CAG	LTE-TDD (SC-FDMA, 50% RB, 10 MHz, 64-QAM)	LTE-TDD	10.17	± 9.6 %
10252	CAG	LTE-TDD (SC-FDMA, 50% RB, 10 MHz, QPSK)	LTE-TDD	9.24	± 9.6 %
10253	CAF	LTE-TDD (SC-FDMA, 50% RB, 15 MHz, 16-QAM)	LTE-TDD	9.90	± 9.6 %
10254	CAF	LTE-TDD (SC-FDMA, 50% RB, 15 MHz, 64-QAM)	LTE-TDD	10.14	± 9.6 %
10255	CAF	LTE-TDD (SC-FDMA, 50% RB, 15 MHz, QPSK)	LTE-TDD	9.20	± 9.6 %
10256	CAB	LTE-TDD (SC-FDMA, 100% RB, 1.4 MHz, 16-QAM)	LTE-TDD	9.96	± 9.6 %
10257	CAB	LTE-TDD (SC-FDMA, 100% RB, 1.4 MHz, 64-QAM)	LTE-TDD	10.08	± 9.6 %
10258	CAB	LTE-TDD (SC-FDMA, 100% RB, 1.4 MHz, QPSK)	LTE-TDD	9.34	± 9.6 %
10259	CAD	LTE-TDD (SC-FDMA, 100% RB, 3 MHz, 16-QAM)	LTE-TDD	9.98	± 9.6 %
10260	CAD	LTE-TDD (SC-FDMA, 100% RB, 3 MHz, 64-QAM)	LTE-TDD	9.97	± 9.6 %
10261	CAD	LTE-TDD (SC-FDMA, 100% RB, 3 MHz, QPSK)	LTE-TDD	9.24	± 9.6 %
10262	CAG	LTE-TDD (SC-FDMA, 100% RB, 5 MHz, 16-QAM)	LTE-TDD	9.83	± 9.6 %
10263	CAG	LTE-TDD (SC-FDMA, 100% RB, 5 MHz, 64-QAM)	LTE-TDD	10.16	± 9.6 %
10264	CAG	LTE-TDD (SC-FDMA, 100% RB, 5 MHz, QPSK)	LTE-TDD	9.23	± 9.6 %
10265	CAG	LTE-TDD (SC-FDMA, 100% RB, 10 MHz, 16-QAM)	LTE-TDD	9.92	± 9.6 %
10266	CAG	LTE-TDD (SC-FDMA, 100% RB, 10 MHz, 64-QAM)	LTE-TDD	10.07	± 9.6 %
10267	CAG	LTE-TDD (SC-FDMA, 100% RB, 10 MHz, QPSK)	LTE-TDD	9.30	± 9.6 %
10268	CAF	LTE-TDD (SC-FDMA, 100% RB, 15 MHz, 16-QAM)	LTE-TDD	10.06	± 9.6 %
10269	CAF	LTE-TDD (SC-FDMA, 100% RB, 15 MHz, 64-QAM)	LTE-TDD	10.13	± 9.6 %
10270	CAF	LTE-TDD (SC-FDMA, 100% RB, 15 MHz, QPSK)	LTE-TDD	9.58	± 9.6 %
10274	CAB	UMTS-FDD (HSUPA, Subtest 5, 3GPP Rel8.10)	WCDMA	4.87	± 9.6 %
10275	CAB	UMTS-FDD (HSUPA, Subtest 5, 3GPP Rel8.4)	WCDMA	3.96	± 9.6 %
10277	CAA	PHS (QPSK)	PHS	11.81	± 9.6 %
10278	CAA	PHS (QPSK, BW 884MHz, Rolloff 0.5)	PHS	11.81	± 9.6 %
10279	CAA	PHS (QPSK, BW 884MHz, Rolloff 0.38)	PHS	12.18	± 9.6 %
10290	AAB	CDMA2000, RC1, SO55, Full Rate	CDMA2000	3.91	± 9.6 %
10291	AAB	CDMA2000, RC3, SO55, Full Rate	CDMA2000	3.46	± 9.6 %
10292	AAB	CDMA2000, RC3, SO32, Full Rate	CDMA2000	3.39	± 9.6 %
10293	AAB	CDMA2000, RC3, SO3, Full Rate	CDMA2000	3.50	± 9.6 %
10295	AAB	CDMA2000, RC1, SO3, 1/8th Rate 25 fr.	CDMA2000	12.49	± 9.6 %
10297	AAD	LTE-FDD (SC-FDMA, 50% RB, 20 MHz, QPSK)	LTE-FDD	5.81	± 9.6 %
10298	AAD	LTE-FDD (SC-FDMA, 50% RB, 3 MHz, QPSK)	LTE-FDD	5.72	± 9.6 %
10299	AAD	LTE-FDD (SC-FDMA, 50% RB, 3 MHz, 16-QAM)	LTE-FDD	6.39	± 9.6 %

10300	AAD	LTE-FDD (SC-FDMA, 50% RB, 3 MHz, 64-QAM)	LTE-FDD	6.60	± 9.6 %
10301	AAA	IEEE 802.16e WiMAX (29:18, 5ms, 10MHz, QPSK, PUSC)	WiMAX	12.03	± 9.6 %
10302	AAA	IEEE 802.16e WiMAX (29:18, 5ms, 10MHz, QPSK, PUSC, 3 CTRL symbols)	WiMAX	12.57	± 9.6 %
10303	AAA	IEEE 802.16e WiMAX (31:15, 5ms, 10MHz, 64QAM, PUSC)	WiMAX	12.52	± 9.6 %
10304	AAA	IEEE 802.16e WiMAX (29:18, 5ms, 10MHz, 64QAM, PUSC)	WiMAX	11.86	± 9.6 %
10305	AAA	IEEE 802.16e WiMAX (31:15, 10ms, 10MHz, 64QAM, PUSC, 15 symbols)	WiMAX	15.24	± 9.6 %
10306	AAA	IEEE 802.16e WiMAX (29:18, 10ms, 10MHz, 64QAM, PUSC, 18 symbols)	WiMAX	14.67	± 9.6 %
10307	AAA	IEEE 802.16e WiMAX (29:18, 10ms, 10MHz, QPSK, PUSC, 18 symbols)	WiMAX	14.49	± 9.6 %
10308	AAA	IEEE 802.16e WiMAX (29:18, 10ms, 10MHz, 16QAM, PUSC)	WiMAX	14.46	± 9.6 %
10309	AAA	IEEE 802.16e WiMAX (29:18, 10ms, 10MHz, 16QAM, AMC 2x3, 18 symbols)	WiMAX	14.58	± 9.6 %
10310	AAA	IEEE 802.16e WiMAX (29:18, 10ms, 10MHz, QPSK, AMC 2x3, 18 symbols)	WiMAX	14.57	± 9.6 %
10311	AAD	LTE-FDD (SC-FDMA, 100% RB, 15 MHz, QPSK)	LTE-FDD	6.06	± 9.6 %
10313	AAA	iDEN 1:3	iDEN	10.51	± 9.6 %
10314	AAA	iDEN 1:6	iDEN	13.48	± 9.6 %
10315	AAB	IEEE 802.11b WiFi 2.4 GHz (DSSS, 1 Mbps, 96pc duty cycle)	WLAN	1.71	± 9.6 %
10316	AAB	IEEE 802.11g WiFi 2.4 GHz (ERP-OFDM, 6 Mbps, 96pc duty cycle)	WLAN	8.36	± 9.6 %
10317	AAC	IEEE 802.11a WiFi 5 GHz (OFDM, 6 Mbps, 96pc duty cycle)	WLAN	8.36	± 9.6 %
10352	AAA	Pulse Waveform (200Hz, 10%)	Generic	10.00	± 9.6 %
10353	AAA	Pulse Waveform (200Hz, 20%)	Generic	6.99	± 9.6 %
10354	AAA	Pulse Waveform (200Hz, 40%)	Generic	3.98	± 9.6 %
10355	AAA	Pulse Waveform (200Hz, 60%)	Generic	2.22	± 9.6 %
10356	AAA	Pulse Waveform (200Hz, 80%)	Generic	0.97	± 9.6 %
10387	AAA	QPSK Waveform, 1 MHz	Generic	5.10	± 9.6 %
10388	AAA	QPSK Waveform, 10 MHz	Generic	5.22	± 9.6 %
10396	AAA	64-QAM Waveform, 100 kHz	Generic	6.27	± 9.6 %
10399	AAA	64-QAM Waveform, 40 MHz	Generic	6.27	± 9.6 %
10400	AAD	IEEE 802.11ac WiFi (20MHz, 64-QAM, 99pc duty cycle)	WLAN	8.37	± 9.6 %
10401	AAD	IEEE 802.11ac WiFi (40MHz, 64-QAM, 99pc duty cycle)	WLAN	8.60	± 9.6 %
10402	AAD	IEEE 802.11ac WiFi (80MHz, 64-QAM, 99pc duty cycle)	WLAN	8.53	± 9.6 %
10403	AAB	CDMA2000 (1xEV-DO, Rev. 0)	CDMA2000	3.76	± 9.6 %
10404	AAB	CDMA2000 (1xEV-DO, Rev. A)	CDMA2000	3.77	± 9.6 %
10406	AAB	CDMA2000, RC3, SO32, SCH0, Full Rate	CDMA2000	5.22	± 9.6 %
10410	AAG	LTE-TDD (SC-FDMA, 1 RB, 10 MHz, QPSK, UL Subframe=2,3,4,7,8,9, Subframe Conf=4)	LTE-TDD	7.82	± 9.6 %
10414	AAA	WLAN CCDF, 64-QAM, 40MHz	Generic	8.54	± 9.6 %
10415	AAA	IEEE 802.11b WiFi 2.4 GHz (DSSS, 1 Mbps, 99pc duty cycle)	WLAN	1.54	± 9.6 %
10416	AAA	IEEE 802.11g WiFi 2.4 GHz (ERP-OFDM, 6 Mbps, 99pc duty cycle)	WLAN	8.23	± 9.6 %
10417	AAB	IEEE 802.11a/h WiFi 5 GHz (OFDM, 6 Mbps, 99pc duty cycle)	WLAN	8.23	± 9.6 %
10418	AAA	IEEE 802.11g WiFi 2.4 GHz (DSSS-OFDM, 6 Mbps, 99pc duty cycle, Long preamble)	WLAN	8.14	± 9.6 %
10419	AAA	IEEE 802.11g WiFi 2.4 GHz (DSSS-OFDM, 6 Mbps, 99pc duty cycle, Short preamble)	WLAN	8.19	± 9.6 %
10422	AAB	IEEE 802.11n (HT Greenfield, 7.2 Mbps, BPSK)	WLAN	8.32	± 9.6 %
10423	AAB	IEEE 802.11n (HT Greenfield, 43.3 Mbps, 16-QAM)	WLAN	8.47	± 9.6 %
10424	AAB	IEEE 802.11n (HT Greenfield, 72.2 Mbps, 64-QAM)	WLAN	8.40	± 9.6 %
10425	AAB	IEEE 802.11n (HT Greenfield, 15 Mbps, BPSK)	WLAN	8.41	± 9.6 %
10426	AAB	IEEE 802.11n (HT Greenfield, 90 Mbps, 16-QAM)	WLAN	8.45	± 9.6 %
10427	AAB	IEEE 802.11n (HT Greenfield, 150 Mbps, 64-QAM)	WLAN	8.41	± 9.6 %
10430	AAD	LTE-FDD (OFDMA, 5 MHz, E-TM 3.1)	LTE-FDD	8.28	± 9.6 %
10431	AAD	LTE-FDD (OFDMA, 10 MHz, E-TM 3.1)	LTE-FDD	8.38	± 9.6 %
10432	AAC	LTE-FDD (OFDMA, 15 MHz, E-TM 3.1)	LTE-FDD	8.34	± 9.6 %
10433	AAC	LTE-FDD (OFDMA, 20 MHz, E-TM 3.1)	LTE-FDD	8.34	± 9.6 %
10434	AAA	W-CDMA (BS Test Model 1, 64 DPCH)	WCDMA	8.60	± 9.6 %
10435	AAF	LTE-TDD (SC-FDMA, 1 RB, 20 MHz, QPSK, UL Subframe=2,3,4,7,8,9)	LTE-TDD	7.82	± 9.6 %
10447	AAD	LTE-FDD (OFDMA, 5 MHz, E-TM 3.1, Clipping 44%)	LTE-FDD	7.56	± 9.6 %
10448	AAD	LTE-FDD (OFDMA, 10 MHz, E-TM 3.1, Clippin 44%)	LTE-FDD	7.53	± 9.6 %
10449	AAC	LTE-FDD (OFDMA, 15 MHz, E-TM 3.1, Clipping 44%)	LTE-FDD	7.51	± 9.6 %

10450	AAC	LTE-FDD (OFDMA, 20 MHz, E-TM 3.1, Clipping 44%)	LTE-FDD	7.48	± 9.6 %
10451	AAA	W-CDMA (BS Test Model 1, 64 DPCH, Clipping 44%)	WCDMA	7.59	± 9.6 %
10453	AAD	Validation (Square, 10ms, 1ms)	Test	10.00	± 9.6 %
10456	AAB	IEEE 802.11ac WiFi (160MHz, 64-QAM, 99pc duty cycle)	WLAN	8.63	± 9.6 %
10457	AAA	UMTS-FDD (DC-HSDPA)	WCDMA	6.62	± 9.6 %
10458	AAA	CDMA2000 (1xEV-DO, Rev. B, 2 carriers)	CDMA2000	6.55	± 9.6 %
10459	AAA	CDMA2000 (1xEV-DO, Rev. B, 3 carriers)	CDMA2000	8.25	± 9.6 %
10460	AAA	UMTS-FDD (WCDMA, AMR)	WCDMA	2.39	± 9.6 %
10461	AAB	LTE-TDD (SC-FDMA, 1 RB, 1.4 MHz, QPSK, UL Subframe=2,3,4,7,8,9)	LTE-TDD	7.82	± 9.6 %
10462	AAB	LTE-TDD (SC-FDMA, 1 RB, 1.4 MHz, 16-QAM, UL Subframe=2,3,4,7,8,9)	LTE-TDD	8.30	± 9.6 %
10463	AAB	LTE-TDD (SC-FDMA, 1 RB, 1.4 MHz, 64-QAM, UL Subframe=2,3,4,7,8,9)	LTE-TDD	8.56	± 9.6 %
10464	AAC	LTE-TDD (SC-FDMA, 1 RB, 3 MHz, QPSK, UL Subframe=2,3,4,7,8,9)	LTE-TDD	7.82	± 9.6 %
10465	AAC	LTE-TDD (SC-FDMA, 1 RB, 3 MHz, 16-QAM, UL Subframe=2,3,4,7,8,9)	LTE-TDD	8.32	± 9.6 %
10466	AAC	LTE-TDD (SC-FDMA, 1 RB, 3 MHz, 64-QAM, UL Subframe=2,3,4,7,8,9)	LTE-TDD	8.57	± 9.6 %
10467	AAF	LTE-TDD (SC-FDMA, 1 RB, 5 MHz, QPSK, UL Subframe=2,3,4,7,8,9)	LTE-TDD	7.82	± 9.6 %
10468	AAF	LTE-TDD (SC-FDMA, 1 RB, 5 MHz, 16-QAM, UL Subframe=2,3,4,7,8,9)	LTE-TDD	8.32	± 9.6 %
10469	AAF	LTE-TDD (SC-FDMA, 1 RB, 5 MHz, 64-QAM, UL Subframe=2,3,4,7,8,9)	LTE-TDD	8.56	± 9.6 %
10470	AAF	LTE-TDD (SC-FDMA, 1 RB, 10 MHz, QPSK, UL Subframe=2,3,4,7,8,9)	LTE-TDD	7.82	± 9.6 %
10471	AAF	LTE-TDD (SC-FDMA, 1 RB, 10 MHz, 16-QAM, UL Subframe=2,3,4,7,8,9)	LTE-TDD	8.32	± 9.6 %
10472	AAF	LTE-TDD (SC-FDMA, 1 RB, 10 MHz, 64-QAM, UL Subframe=2,3,4,7,8,9)	LTE-TDD	8.57	± 9.6 %
10473	AAE	LTE-TDD (SC-FDMA, 1 RB, 15 MHz, QPSK, UL Subframe=2,3,4,7,8,9)	LTE-TDD	7.82	± 9.6 %
10474	AAE	LTE-TDD (SC-FDMA, 1 RB, 15 MHz, 16-QAM, UL Subframe=2,3,4,7,8,9)	LTE-TDD	8.32	± 9.6 %
10475	AAE	LTE-TDD (SC-FDMA, 1 RB, 15 MHz, 64-QAM, UL Subframe=2,3,4,7,8,9)	LTE-TDD	8.57	± 9.6 %
10477	AAF	LTE-TDD (SC-FDMA, 1 RB, 20 MHz, 16-QAM, UL Subframe=2,3,4,7,8,9)	LTE-TDD	8.32	± 9.6 %
10478	AAF	LTE-TDD (SC-FDMA, 1 RB, 20 MHz, 64-QAM, UL Subframe=2,3,4,7,8,9)	LTE-TDD	8.57	± 9.6 %
10479	AAB	LTE-TDD (SC-FDMA, 50% RB, 1.4 MHz, QPSK, UL Subframe=2,3,4,7,8,9)	LTE-TDD	7.74	± 9.6 %
10480	AAB	LTE-TDD (SC-FDMA, 50% RB, 1.4 MHz, 16-QAM, UL Subframe=2,3,4,7,8,9)	LTE-TDD	8.18	± 9.6 %
10481	AAB	LTE-TDD (SC-FDMA, 50% RB, 1.4 MHz, 64-QAM, UL Subframe=2,3,4,7,8,9)	LTE-TDD	8.45	± 9.6 %
10482	AAC	LTE-TDD (SC-FDMA, 50% RB, 3 MHz, QPSK, UL Subframe=2,3,4,7,8,9)	LTE-TDD	7.71	± 9.6 %
10483	AAC	LTE-TDD (SC-FDMA, 50% RB, 3 MHz, 16-QAM, UL Subframe=2,3,4,7,8,9)	LTE-TDD	8.39	± 9.6 %
10484	AAC	LTE-TDD (SC-FDMA, 50% RB, 3 MHz, 64-QAM, UL Subframe=2,3,4,7,8,9)	LTE-TDD	8.47	± 9.6 %
10485	AAF	LTE-TDD (SC-FDMA, 50% RB, 5 MHz, QPSK, UL Subframe=2,3,4,7,8,9)	LTE-TDD	7.59	± 9.6 %
10486	AAF	LTE-TDD (SC-FDMA, 50% RB, 5 MHz, 16-QAM, UL Subframe=2,3,4,7,8,9)	LTE-TDD	8.38	± 9.6 %
10487	AAF	LTE-TDD (SC-FDMA, 50% RB, 5 MHz, 64-QAM, UL Subframe=2,3,4,7,8,9)	LTE-TDD	8.60	± 9.6 %
10488	AAF	LTE-TDD (SC-FDMA, 50% RB, 10 MHz, QPSK, UL Subframe=2,3,4,7,8,9)	LTE-TDD	7.70	± 9.6 %
10489	AAF	LTE-TDD (SC-FDMA, 50% RB, 10 MHz, 16-QAM, UL Subframe=2,3,4,7,8,9)	LTE-TDD	8.31	± 9.6 %
10490	AAF	LTE-TDD (SC-FDMA, 50% RB, 10 MHz, 64-QAM, UL Subframe=2,3,4,7,8,9)	LTE-TDD	8.54	± 9.6 %

10491	AAE	LTE-TDD (SC-FDMA, 50% RB, 15 MHz, QPSK, UL Subframe=2,3,4,7,8,9)	LTE-TDD	7.74	± 9.6 %
10492	AAE	LTE-TDD (SC-FDMA, 50% RB, 15 MHz, 16-QAM, UL Subframe=2,3,4,7,8,9)	LTE-TDD	8.41	± 9.6 %
10493	AAE	LTE-TDD (SC-FDMA, 50% RB, 15 MHz, 64-QAM, UL Subframe=2,3,4,7,8,9)	LTE-TDD	8.55	± 9.6 %
10494	AAF	LTE-TDD (SC-FDMA, 50% RB, 20 MHz, QPSK, UL Subframe=2,3,4,7,8,9)	LTE-TDD	7.74	± 9.6 %
10495	AAF	LTE-TDD (SC-FDMA, 50% RB, 20 MHz, 16-QAM, UL Subframe=2,3,4,7,8,9)	LTE-TDD	8.37	± 9.6 %
10496	AAF	LTE-TDD (SC-FDMA, 50% RB, 20 MHz, 64-QAM, UL Subframe=2,3,4,7,8,9)	LTE-TDD	8.54	± 9.6 %
10497	AAB	LTE-TDD (SC-FDMA, 100% RB, 1.4 MHz, QPSK, UL Subframe=2,3,4,7,8,9)	LTE-TDD	7.67	± 9.6 %
10498	AAB	LTE-TDD (SC-FDMA, 100% RB, 1.4 MHz, 16-QAM, UL Subframe=2,3,4,7,8,9)	LTE-TDD	8.40	± 9.6 %
10499	AAB	LTE-TDD (SC-FDMA, 100% RB, 1.4 MHz, 64-QAM, UL Subframe=2,3,4,7,8,9)	LTE-TDD	8.68	± 9.6 %
10500	AAC	LTE-TDD (SC-FDMA, 100% RB, 3 MHz, QPSK, UL Subframe=2,3,4,7,8,9)	LTE-TDD	7.67	± 9.6 %
10501	AAC	LTE-TDD (SC-FDMA, 100% RB, 3 MHz, 16-QAM, UL Subframe=2,3,4,7,8,9)	LTE-TDD	8.44	± 9.6 %
10502	AAC	LTE-TDD (SC-FDMA, 100% RB, 3 MHz, 64-QAM, UL Subframe=2,3,4,7,8,9)	LTE-TDD	8.52	± 9.6 %
10503	AAF	LTE-TDD (SC-FDMA, 100% RB, 5 MHz, QPSK, UL Subframe=2,3,4,7,8,9)	LTE-TDD	7.72	± 9.6 %
10504	AAF	LTE-TDD (SC-FDMA, 100% RB, 5 MHz, 16-QAM, UL Subframe=2,3,4,7,8,9)	LTE-TDD	8.31	± 9.6 %
10505	AAF	LTE-TDD (SC-FDMA, 100% RB, 5 MHz, 64-QAM, UL Subframe=2,3,4,7,8,9)	LTE-TDD	8.54	± 9.6 %
10506	AAF	LTE-TDD (SC-FDMA, 100% RB, 10 MHz, QPSK, UL Subframe=2,3,4,7,8,9)	LTE-TDD	7.74	± 9.6 %
10507	AAF	LTE-TDD (SC-FDMA, 100% RB, 10 MHz, 16-QAM, UL Subframe=2,3,4,7,8,9)	LTE-TDD	8.36	± 9.6 %
10508	AAF	LTE-TDD (SC-FDMA, 100% RB, 10 MHz, 64-QAM, UL Subframe=2,3,4,7,8,9)	LTE-TDD	8.55	± 9.6 %
10509	AAE	LTE-TDD (SC-FDMA, 100% RB, 15 MHz, QPSK, UL Subframe=2,3,4,7,8,9)	LTE-TDD	7.99	± 9.6 %
10510	AAE	LTE-TDD (SC-FDMA, 100% RB, 15 MHz, 16-QAM, UL Subframe=2,3,4,7,8,9)	LTE-TDD	8.49	± 9.6 %
10511	AAE	LTE-TDD (SC-FDMA, 100% RB, 15 MHz, 64-QAM, UL Subframe=2,3,4,7,8,9)	LTE-TDD	8.51	± 9.6 %
10512	AAF	LTE-TDD (SC-FDMA, 100% RB, 20 MHz, QPSK, UL Subframe=2,3,4,7,8,9)	LTE-TDD	7.74	± 9.6 %
10513	AAF	LTE-TDD (SC-FDMA, 100% RB, 20 MHz, 16-QAM, UL Subframe=2,3,4,7,8,9)	LTE-TDD	8.42	± 9.6 %
10514	AAF	LTE-TDD (SC-FDMA, 100% RB, 20 MHz, 64-QAM, UL Subframe=2,3,4,7,8,9)	LTE-TDD	8.45	± 9.6 %
10515	AAA	IEEE 802.11b WiFi 2.4 GHz (DSSS, 2 Mbps, 99pc duty cycle)	WLAN	1.58	± 9.6 %
10516	AAA	IEEE 802.11b WiFi 2.4 GHz (DSSS, 5.5 Mbps, 99pc duty cycle)	WLAN	1.57	± 9.6 %
10517	AAA	IEEE 802.11b WiFi 2.4 GHz (DSSS, 11 Mbps, 99pc duty cycle)	WLAN	1.58	± 9.6 %
10518	AAB	IEEE 802.11a/h WiFi 5 GHz (OFDM, 9 Mbps, 99pc duty cycle)	WLAN	8.23	± 9.6 %
10519	AAB	IEEE 802.11a/h WiFi 5 GHz (OFDM, 12 Mbps, 99pc duty cycle)	WLAN	8.39	± 9.6 %
10520	AAB	IEEE 802.11a/h WiFi 5 GHz (OFDM, 18 Mbps, 99pc duty cycle)	WLAN	8.12	± 9.6 %
10521	AAB	IEEE 802.11a/h WiFi 5 GHz (OFDM, 24 Mbps, 99pc duty cycle)	WLAN	7.97	± 9.6 %
10522	AAB	IEEE 802.11a/h WiFi 5 GHz (OFDM, 36 Mbps, 99pc duty cycle)	WLAN	8.45	± 9.6 %
10523	AAB	IEEE 802.11a/h WiFi 5 GHz (OFDM, 48 Mbps, 99pc duty cycle)	WLAN	8.08	± 9.6 %
10524	AAB	IEEE 802.11a/h WiFi 5 GHz (OFDM, 54 Mbps, 99pc duty cycle)	WLAN	8.27	± 9.6 %
10525	AAB	IEEE 802.11ac WiFi (20MHz, MCS0, 99pc duty cycle)	WLAN	8.36	± 9.6 %
10526	AAB	IEEE 802.11ac WiFi (20MHz, MCS1, 99pc duty cycle)	WLAN	8.42	± 9.6 %
10527	AAB	IEEE 802.11ac WiFi (20MHz, MCS2, 99pc duty cycle)	WLAN	8.21	± 9.6 %
10528	AAB	IEEE 802.11ac WiFi (20MHz, MCS3, 99pc duty cycle)	WLAN	8.36	± 9.6 %
10529	AAB	IEEE 802.11ac WiFi (20MHz, MCS4, 99pc duty cycle)	WLAN	8.36	± 9.6 %
10531	AAB	IEEE 802.11ac WiFi (20MHz, MCS6, 99pc duty cycle)	WLAN	8.43	± 9.6 %
10532	AAB	IEEE 802.11ac WiFi (20MHz, MCS7, 99pc duty cycle)	WLAN	8.29	± 9.6 %
10533	AAB	IEEE 802.11ac WiFi (20MHz, MCS8, 99pc duty cycle)	WLAN	8.38	± 9.6 %

10534	AAB	IEEE 802.11ac WiFi (40MHz, MCS0, 99pc duty cycle)	WLAN	8.45	± 9.6 %
10535	AAB	IEEE 802.11ac WiFi (40MHz, MCS1, 99pc duty cycle)	WLAN	8.45	± 9.6 %
10536	AAB	IEEE 802.11ac WiFi (40MHz, MCS2, 99pc duty cycle)	WLAN	8.32	± 9.6 %
10537	AAB	IEEE 802.11ac WiFi (40MHz, MCS3, 99pc duty cycle)	WLAN	8.44	± 9.6 %
10538	AAB	IEEE 802.11ac WiFi (40MHz, MCS4, 99pc duty cycle)	WLAN	8.54	± 9.6 %
10540	AAB	IEEE 802.11ac WiFi (40MHz, MCS6, 99pc duty cycle)	WLAN	8.39	± 9.6 %
10541	AAB	IEEE 802.11ac WiFi (40MHz, MCS7, 99pc duty cycle)	WLAN	8.46	± 9.6 %
10542	AAB	IEEE 802.11ac WiFi (40MHz, MCS8, 99pc duty cycle)	WLAN	8.65	± 9.6 %
10543	AAB	IEEE 802.11ac WiFi (40MHz, MCS9, 99pc duty cycle)	WLAN	8.65	± 9.6 %
10544	AAB	IEEE 802.11ac WiFi (80MHz, MCS0, 99pc duty cycle)	WLAN	8.47	± 9.6 %
10545	AAB	IEEE 802.11ac WiFi (80MHz, MCS1, 99pc duty cycle)	WLAN	8.55	± 9.6 %
10546	AAB	IEEE 802.11ac WiFi (80MHz, MCS2, 99pc duty cycle)	WLAN	8.35	± 9.6 %
10547	AAB	IEEE 802.11ac WiFi (80MHz, MCS3, 99pc duty cycle)	WLAN	8.49	± 9.6 %
10548	AAB	IEEE 802.11ac WiFi (80MHz, MCS4, 99pc duty cycle)	WLAN	8.37	± 9.6 %
10550	AAB	IEEE 802.11ac WiFi (80MHz, MCS6, 99pc duty cycle)	WLAN	8.38	± 9.6 %
10551	AAB	IEEE 802.11ac WiFi (80MHz, MCS7, 99pc duty cycle)	WLAN	8.50	± 9.6 %
10552	AAB	IEEE 802.11ac WiFi (80MHz, MCS8, 99pc duty cycle)	WLAN	8.42	± 9.6 %
10553	AAB	IEEE 802.11ac WiFi (80MHz, MCS9, 99pc duty cycle)	WLAN	8.45	± 9.6 %
10554	AAC	IEEE 802.11ac WiFi (160MHz, MCS0, 99pc duty cycle)	WLAN	8.48	± 9.6 %
10555	AAC	IEEE 802.11ac WiFi (160MHz, MCS1, 99pc duty cycle)	WLAN	8.47	± 9.6 %
10556	AAC	IEEE 802.11ac WiFi (160MHz, MCS2, 99pc duty cycle)	WLAN	8.50	± 9.6 %
10557	AAC	IEEE 802.11ac WiFi (160MHz, MCS3, 99pc duty cycle)	WLAN	8.52	± 9.6 %
10558	AAC	IEEE 802.11ac WiFi (160MHz, MCS4, 99pc duty cycle)	WLAN	8.61	± 9.6 %
10560	AAC	IEEE 802.11ac WiFi (160MHz, MCS6, 99pc duty cycle)	WLAN	8.73	± 9.6 %
10561	AAC	IEEE 802.11ac WiFi (160MHz, MCS7, 99pc duty cycle)	WLAN	8.56	± 9.6 %
10562	AAC	IEEE 802.11ac WiFi (160MHz, MCS8, 99pc duty cycle)	WLAN	8.69	± 9.6 %
10563	AAC	IEEE 802.11ac WiFi (160MHz, MCS9, 99pc duty cycle)	WLAN	8.77	± 9.6 %
10564	AAA	IEEE 802.11g WiFi 2.4 GHz (DSSS-OFDM, 9 Mbps, 99pc duty cycle)	WLAN	8.25	± 9.6 %
10565	AAA	IEEE 802.11g WiFi 2.4 GHz (DSSS-OFDM, 12 Mbps, 99pc duty cycle)	WLAN	8.45	± 9.6 %
10566	AAA	IEEE 802.11g WiFi 2.4 GHz (DSSS-OFDM, 18 Mbps, 99pc duty cycle)	WLAN	8.13	± 9.6 %
10567	AAA	IEEE 802.11g WiFi 2.4 GHz (DSSS-OFDM, 24 Mbps, 99pc duty cycle)	WLAN	8.00	± 9.6 %
10568	AAA	IEEE 802.11g WiFi 2.4 GHz (DSSS-OFDM, 36 Mbps, 99pc duty cycle)	WLAN	8.37	± 9.6 %
10569	AAA	IEEE 802.11g WiFi 2.4 GHz (DSSS-OFDM, 48 Mbps, 99pc duty cycle)	WLAN	8.10	± 9.6 %
10570	AAA	IEEE 802.11g WiFi 2.4 GHz (DSSS-OFDM, 54 Mbps, 99pc duty cycle)	WLAN	8.30	± 9.6 %
10571	AAA	IEEE 802.11b WiFi 2.4 GHz (DSSS, 1 Mbps, 90pc duty cycle)	WLAN	1.99	± 9.6 %
10572	AAA	IEEE 802.11b WiFi 2.4 GHz (DSSS, 2 Mbps, 90pc duty cycle)	WLAN	1.99	± 9.6 %
10573	AAA	IEEE 802.11b WiFi 2.4 GHz (DSSS, 5.5 Mbps, 90pc duty cycle)	WLAN	1.98	± 9.6 %
10574	AAA	IEEE 802.11b WiFi 2.4 GHz (DSSS, 11 Mbps, 90pc duty cycle)	WLAN	1.98	± 9.6 %
10575	AAA	IEEE 802.11g WiFi 2.4 GHz (DSSS-OFDM, 6 Mbps, 90pc duty cycle)	WLAN	8.59	± 9.6 %
10576	AAA	IEEE 802.11g WiFi 2.4 GHz (DSSS-OFDM, 9 Mbps, 90pc duty cycle)	WLAN	8.60	± 9.6 %
10577	AAA	IEEE 802.11g WiFi 2.4 GHz (DSSS-OFDM, 12 Mbps, 90pc duty cycle)	WLAN	8.70	± 9.6 %
10578	AAA	IEEE 802.11g WiFi 2.4 GHz (DSSS-OFDM, 18 Mbps, 90pc duty cycle)	WLAN	8.49	± 9.6 %
10579	AAA	IEEE 802.11g WiFi 2.4 GHz (DSSS-OFDM, 24 Mbps, 90pc duty cycle)	WLAN	8.36	± 9.6 %
10580	AAA	IEEE 802.11g WiFi 2.4 GHz (DSSS-OFDM, 36 Mbps, 90pc duty cycle)	WLAN	8.76	± 9.6 %
10581	AAA	IEEE 802.11g WiFi 2.4 GHz (DSSS-OFDM, 48 Mbps, 90pc duty cycle)	WLAN	8.35	± 9.6 %
10582	AAA	IEEE 802.11g WiFi 2.4 GHz (DSSS-OFDM, 54 Mbps, 90pc duty cycle)	WLAN	8.67	± 9.6 %
10583	AAB	IEEE 802.11a/h WiFi 5 GHz (OFDM, 6 Mbps, 90pc duty cycle)	WLAN	8.59	± 9.6 %
10584	AAB	IEEE 802.11a/h WiFi 5 GHz (OFDM, 9 Mbps, 90pc duty cycle)	WLAN	8.60	± 9.6 %
10585	AAB	IEEE 802.11a/h WiFi 5 GHz (OFDM, 12 Mbps, 90pc duty cycle)	WLAN	8.70	± 9.6 %
10586	AAB	IEEE 802.11a/h WiFi 5 GHz (OFDM, 18 Mbps, 90pc duty cycle)	WLAN	8.49	± 9.6 %

10587	AAB	IEEE 802.11a/h WiFi 5 GHz (OFDM, 24 Mbps, 90pc duty cycle)	WLAN	8.36	± 9.6 %
10588	AAB	IEEE 802.11a/h WiFi 5 GHz (OFDM, 36 Mbps, 90pc duty cycle)	WLAN	8.76	± 9.6 %
10589	AAB	IEEE 802.11a/h WiFi 5 GHz (OFDM, 48 Mbps, 90pc duty cycle)	WLAN	8.35	± 9.6 %
10590	AAB	IEEE 802.11a/h WiFi 5 GHz (OFDM, 54 Mbps, 90pc duty cycle)	WLAN	8.67	± 9.6 %
10591	AAB	IEEE 802.11n (HT Mixed, 20MHz, MCS0, 90pc duty cycle)	WLAN	8.63	± 9.6 %
10592	AAB	IEEE 802.11n (HT Mixed, 20MHz, MCS1, 90pc duty cycle)	WLAN	8.79	± 9.6 %
10593	AAB	IEEE 802.11n (HT Mixed, 20MHz, MCS2, 90pc duty cycle)	WLAN	8.64	± 9.6 %
10594	AAB	IEEE 802.11n (HT Mixed, 20MHz, MCS3, 90pc duty cycle)	WLAN	8.74	± 9.6 %
10595	AAB	IEEE 802.11n (HT Mixed, 20MHz, MCS4, 90pc duty cycle)	WLAN	8.74	± 9.6 %
10596	AAB	IEEE 802.11n (HT Mixed, 20MHz, MCS5, 90pc duty cycle)	WLAN	8.71	± 9.6 %
10597	AAB	IEEE 802.11n (HT Mixed, 20MHz, MCS6, 90pc duty cycle)	WLAN	8.72	± 9.6 %
10598	AAB	IEEE 802.11n (HT Mixed, 20MHz, MCS7, 90pc duty cycle)	WLAN	8.50	± 9.6 %
10599	AAB	IEEE 802.11n (HT Mixed, 40MHz, MCS0, 90pc duty cycle)	WLAN	8.79	± 9.6 %
10600	AAB	IEEE 802.11n (HT Mixed, 40MHz, MCS1, 90pc duty cycle)	WLAN	8.88	± 9.6 %
10601	AAB	IEEE 802.11n (HT Mixed, 40MHz, MCS2, 90pc duty cycle)	WLAN	8.82	± 9.6 %
10602	AAB	IEEE 802.11n (HT Mixed, 40MHz, MCS3, 90pc duty cycle)	WLAN	8.94	± 9.6 %
10603	AAB	IEEE 802.11n (HT Mixed, 40MHz, MCS4, 90pc duty cycle)	WLAN	9.03	± 9.6 %
10604	AAB	IEEE 802.11n (HT Mixed, 40MHz, MCS5, 90pc duty cycle)	WLAN	8.76	± 9.6 %
10605	AAB	IEEE 802.11n (HT Mixed, 40MHz, MCS6, 90pc duty cycle)	WLAN	8.97	± 9.6 %
10606	AAB	IEEE 802.11n (HT Mixed, 40MHz, MCS7, 90pc duty cycle)	WLAN	8.82	± 9.6 %
10607	AAB	IEEE 802.11ac WiFi (20MHz, MCS0, 90pc duty cycle)	WLAN	8.64	± 9.6 %
10608	AAB	IEEE 802.11ac WiFi (20MHz, MCS1, 90pc duty cycle)	WLAN	8.77	± 9.6 %
10609	AAB	IEEE 802.11ac WiFi (20MHz, MCS2, 90pc duty cycle)	WLAN	8.57	± 9.6 %
10610	AAB	IEEE 802.11ac WiFi (20MHz, MCS3, 90pc duty cycle)	WLAN	8.78	± 9.6 %
10611	AAB	IEEE 802.11ac WiFi (20MHz, MCS4, 90pc duty cycle)	WLAN	8.70	± 9.6 %
10612	AAB	IEEE 802.11ac WiFi (20MHz, MCS5, 90pc duty cycle)	WLAN	8.77	± 9.6 %
10613	AAB	IEEE 802.11ac WiFi (20MHz, MCS6, 90pc duty cycle)	WLAN	8.94	± 9.6 %
10614	AAB	IEEE 802.11ac WiFi (20MHz, MCS7, 90pc duty cycle)	WLAN	8.59	± 9.6 %
10615	AAB	IEEE 802.11ac WiFi (20MHz, MCS8, 90pc duty cycle)	WLAN	8.82	± 9.6 %
10616	AAB	IEEE 802.11ac WiFi (40MHz, MCS0, 90pc duty cycle)	WLAN	8.82	± 9.6 %
10617	AAB	IEEE 802.11ac WiFi (40MHz, MCS1, 90pc duty cycle)	WLAN	8.81	± 9.6 %
10618	AAB	IEEE 802.11ac WiFi (40MHz, MCS2, 90pc duty cycle)	WLAN	8.58	± 9.6 %
10619	AAB	IEEE 802.11ac WiFi (40MHz, MCS3, 90pc duty cycle)	WLAN	8.86	± 9.6 %
10620	AAB	IEEE 802.11ac WiFi (40MHz, MCS4, 90pc duty cycle)	WLAN	8.87	± 9.6 %
10621	AAB	IEEE 802.11ac WiFi (40MHz, MCS5, 90pc duty cycle)	WLAN	8.77	± 9.6 %
10622	AAB	IEEE 802.11ac WiFi (40MHz, MCS6, 90pc duty cycle)	WLAN	8.68	± 9.6 %
10623	AAB	IEEE 802.11ac WiFi (40MHz, MCS7, 90pc duty cycle)	WLAN	8.82	± 9.6 %
10624	AAB	IEEE 802.11ac WiFi (40MHz, MCS8, 90pc duty cycle)	WLAN	8.96	± 9.6 %
10625	AAB	IEEE 802.11ac WiFi (40MHz, MCS9, 90pc duty cycle)	WLAN	8.96	± 9.6 %
10626	AAB	IEEE 802.11ac WiFi (80MHz, MCS0, 90pc duty cycle)	WLAN	8.83	± 9.6 %
10627	AAB	IEEE 802.11ac WiFi (80MHz, MCS1, 90pc duty cycle)	WLAN	8.88	± 9.6 %
10628	AAB	IEEE 802.11ac WiFi (80MHz, MCS2, 90pc duty cycle)	WLAN	8.71	± 9.6 %
10629	AAB	IEEE 802.11ac WiFi (80MHz, MCS3, 90pc duty cycle)	WLAN	8.85	± 9.6 %
10630	AAB	IEEE 802.11ac WiFi (80MHz, MCS4, 90pc duty cycle)	WLAN	8.72	± 9.6 %
10631	AAB	IEEE 802.11ac WiFi (80MHz, MCS5, 90pc duty cycle)	WLAN	8.81	± 9.6 %
10632	AAB	IEEE 802.11ac WiFi (80MHz, MCS6, 90pc duty cycle)	WLAN	8.74	± 9.6 %
10633	AAB	IEEE 802.11ac WiFi (80MHz, MCS7, 90pc duty cycle)	WLAN	8.83	± 9.6 %
10634	AAB	IEEE 802.11ac WiFi (80MHz, MCS8, 90pc duty cycle)	WLAN	8.80	± 9.6 %
10635	AAB	IEEE 802.11ac WiFi (80MHz, MCS9, 90pc duty cycle)	WLAN	8.81	± 9.6 %
10636	AAC	IEEE 802.11ac WiFi (160MHz, MCS0, 90pc duty cycle)	WLAN	8.83	± 9.6 %
10637	AAC	IEEE 802.11ac WiFi (160MHz, MCS1, 90pc duty cycle)	WLAN	8.79	± 9.6 %
10638	AAC	IEEE 802.11ac WiFi (160MHz, MCS2, 90pc duty cycle)	WLAN	8.86	± 9.6 %
10639	AAC	IEEE 802.11ac WiFi (160MHz, MCS3, 90pc duty cycle)	WLAN	8.85	± 9.6 %
10640	AAC	IEEE 802.11ac WiFi (160MHz, MCS4, 90pc duty cycle)	WLAN	8.98	± 9.6 %
10641	AAC	IEEE 802.11ac WiFi (160MHz, MCS5, 90pc duty cycle)	WLAN	9.06	± 9.6 %
10642	AAC	IEEE 802.11ac WiFi (160MHz, MCS6, 90pc duty cycle)	WLAN	9.06	± 9.6 %
10643	AAC	IEEE 802.11ac WiFi (160MHz, MCS7, 90pc duty cycle)	WLAN	8.89	± 9.6 %
10644	AAC	IEEE 802.11ac WiFi (160MHz, MCS8, 90pc duty cycle)	WLAN	9.05	± 9.6 %
10645	AAC	IEEE 802.11ac WiFi (160MHz, MCS9, 90pc duty cycle)	WLAN	9.11	± 9.6 %
10646	AAG	LTE-TDD (SC-FDMA, 1 RB, 5 MHz, QPSK, UL Subframe=2,7)	LTE-TDD	11.96	± 9.6 %
10647	AAF	LTE-TDD (SC-FDMA, 1 RB, 20 MHz, QPSK, UL Subframe=2,7)	LTE-TDD	11.96	± 9.6 %
10648	AAA	CDMA2000 (1x Advanced)	CDMA2000	3.45	± 9.6 %
10652	AAE	LTE-TDD (OFDMA, 5 MHz, E-TM 3.1, Clipping 44%)	LTE-TDD	6.91	± 9.6 %
10653	AAE	LTE-TDD (OFDMA, 10 MHz, E-TM 3.1, Clipping 44%)	LTE-TDD	7.42	± 9.6 %

10654	AAD	LTE-TDD (OFDMA, 15 MHz, E-TM 3.1, Clipping 44%)	LTE-TDD	6.96	± 9.6 %
10655	AAE	LTE-TDD (OFDMA, 20 MHz, E-TM 3.1, Clipping 44%)	LTE-TDD	7.21	± 9.6 %
10658	AAA	Pulse Waveform (200Hz, 10%)	Test	10.00	± 9.6 %
10659	AAA	Pulse Waveform (200Hz, 20%)	Test	6.99	± 9.6 %
10660	AAA	Pulse Waveform (200Hz, 40%)	Test	3.98	± 9.6 %
10661	AAA	Pulse Waveform (200Hz, 60%)	Test	2.22	± 9.6 %
10662	AAA	Pulse Waveform (200Hz, 80%)	Test	0.97	± 9.6 %
10670	AAA	Bluetooth Low Energy	Bluetooth	2.19	± 9.6 %
10671	AAA	IEEE 802.11ax (20MHz, MCS0, 90pc duty cycle)	WLAN	9.09	± 9.6 %
10672	AAA	IEEE 802.11ax (20MHz, MCS1, 90pc duty cycle)	WLAN	8.57	± 9.6 %
10673	AAA	IEEE 802.11ax (20MHz, MCS2, 90pc duty cycle)	WLAN	8.78	± 9.6 %
10674	AAA	IEEE 802.11ax (20MHz, MCS3, 90pc duty cycle)	WLAN	8.74	± 9.6 %
10675	AAA	IEEE 802.11ax (20MHz, MCS4, 90pc duty cycle)	WLAN	8.90	± 9.6 %
10676	AAA	IEEE 802.11ax (20MHz, MCS5, 90pc duty cycle)	WLAN	8.77	± 9.6 %
10677	AAA	IEEE 802.11ax (20MHz, MCS6, 90pc duty cycle)	WLAN	8.73	± 9.6 %
10678	AAA	IEEE 802.11ax (20MHz, MCS7, 90pc duty cycle)	WLAN	8.78	± 9.6 %
10679	AAA	IEEE 802.11ax (20MHz, MCS8, 90pc duty cycle)	WLAN	8.89	± 9.6 %
10680	AAA	IEEE 802.11ax (20MHz, MCS9, 90pc duty cycle)	WLAN	8.80	± 9.6 %
10681	AAA	IEEE 802.11ax (20MHz, MCS10, 90pc duty cycle)	WLAN	8.62	± 9.6 %
10682	AAA	IEEE 802.11ax (20MHz, MCS11, 90pc duty cycle)	WLAN	8.83	± 9.6 %
10683	AAA	IEEE 802.11ax (20MHz, MCS0, 99pc duty cycle)	WLAN	8.42	± 9.6 %
10684	AAA	IEEE 802.11ax (20MHz, MCS1, 99pc duty cycle)	WLAN	8.26	± 9.6 %
10685	AAA	IEEE 802.11ax (20MHz, MCS2, 99pc duty cycle)	WLAN	8.33	± 9.6 %
10686	AAA	IEEE 802.11ax (20MHz, MCS3, 99pc duty cycle)	WLAN	8.28	± 9.6 %
10687	AAA	IEEE 802.11ax (20MHz, MCS4, 99pc duty cycle)	WLAN	8.45	± 9.6 %
10688	AAA	IEEE 802.11ax (20MHz, MCS5, 99pc duty cycle)	WLAN	8.29	± 9.6 %
10689	AAA	IEEE 802.11ax (20MHz, MCS6, 99pc duty cycle)	WLAN	8.55	± 9.6 %
10690	AAA	IEEE 802.11ax (20MHz, MCS7, 99pc duty cycle)	WLAN	8.29	± 9.6 %
10691	AAA	IEEE 802.11ax (20MHz, MCS8, 99pc duty cycle)	WLAN	8.25	± 9.6 %
10692	AAA	IEEE 802.11ax (20MHz, MCS9, 99pc duty cycle)	WLAN	8.29	± 9.6 %
10693	AAA	IEEE 802.11ax (20MHz, MCS10, 99pc duty cycle)	WLAN	8.25	± 9.6 %
10694	AAA	IEEE 802.11ax (20MHz, MCS11, 99pc duty cycle)	WLAN	8.57	± 9.6 %
10695	AAA	IEEE 802.11ax (40MHz, MCS0, 90pc duty cycle)	WLAN	8.78	± 9.6 %
10696	AAA	IEEE 802.11ax (40MHz, MCS1, 90pc duty cycle)	WLAN	8.91	± 9.6 %
10697	AAA	IEEE 802.11ax (40MHz, MCS2, 90pc duty cycle)	WLAN	8.61	± 9.6 %
10698	AAA	IEEE 802.11ax (40MHz, MCS3, 90pc duty cycle)	WLAN	8.89	± 9.6 %
10699	AAA	IEEE 802.11ax (40MHz, MCS4, 90pc duty cycle)	WLAN	8.82	± 9.6 %
10700	AAA	IEEE 802.11ax (40MHz, MCS5, 90pc duty cycle)	WLAN	8.73	± 9.6 %
10701	AAA	IEEE 802.11ax (40MHz, MCS6, 90pc duty cycle)	WLAN	8.86	± 9.6 %
10702	AAA	IEEE 802.11ax (40MHz, MCS7, 90pc duty cycle)	WLAN	8.70	± 9.6 %
10703	AAA	IEEE 802.11ax (40MHz, MCS8, 90pc duty cycle)	WLAN	8.82	± 9.6 %
10704	AAA	IEEE 802.11ax (40MHz, MCS9, 90pc duty cycle)	WLAN	8.56	± 9.6 %
10705	AAA	IEEE 802.11ax (40MHz, MCS10, 90pc duty cycle)	WLAN	8.69	± 9.6 %
10706	AAA	IEEE 802.11ax (40MHz, MCS11, 90pc duty cycle)	WLAN	8.66	± 9.6 %
10707	AAA	IEEE 802.11ax (40MHz, MCS0, 99pc duty cycle)	WLAN	8.32	± 9.6 %
10708	AAA	IEEE 802.11ax (40MHz, MCS1, 99pc duty cycle)	WLAN	8.55	± 9.6 %
10709	AAA	IEEE 802.11ax (40MHz, MCS2, 99pc duty cycle)	WLAN	8.33	± 9.6 %
10710	AAA	IEEE 802.11ax (40MHz, MCS3, 99pc duty cycle)	WLAN	8.29	± 9.6 %
10711	AAA	IEEE 802.11ax (40MHz, MCS4, 99pc duty cycle)	WLAN	8.39	± 9.6 %
10712	AAA	IEEE 802.11ax (40MHz, MCS5, 99pc duty cycle)	WLAN	8.67	± 9.6 %
10713	AAA	IEEE 802.11ax (40MHz, MCS6, 99pc duty cycle)	WLAN	8.33	± 9.6 %
10714	AAA	IEEE 802.11ax (40MHz, MCS7, 99pc duty cycle)	WLAN	8.26	± 9.6 %
10715	AAA	IEEE 802.11ax (40MHz, MCS8, 99pc duty cycle)	WLAN	8.45	± 9.6 %
10716	AAA	IEEE 802.11ax (40MHz, MCS9, 99pc duty cycle)	WLAN	8.30	± 9.6 %
10717	AAA	IEEE 802.11ax (40MHz, MCS10, 99pc duty cycle)	WLAN	8.48	± 9.6 %
10718	AAA	IEEE 802.11ax (40MHz, MCS11, 99pc duty cycle)	WLAN	8.24	± 9.6 %
10719	AAA	IEEE 802.11ax (80MHz, MCS0, 90pc duty cycle)	WLAN	8.81	± 9.6 %
10720	AAA	IEEE 802.11ax (80MHz, MCS1, 90pc duty cycle)	WLAN	8.87	± 9.6 %
10721	AAA	IEEE 802.11ax (80MHz, MCS2, 90pc duty cycle)	WLAN	8.76	± 9.6 %
10722	AAA	IEEE 802.11ax (80MHz, MCS3, 90pc duty cycle)	WLAN	8.55	± 9.6 %
10723	AAA	IEEE 802.11ax (80MHz, MCS4, 90pc duty cycle)	WLAN	8.70	± 9.6 %
10724	AAA	IEEE 802.11ax (80MHz, MCS5, 90pc duty cycle)	WLAN	8.90	± 9.6 %
10725	AAA	IEEE 802.11ax (80MHz, MCS6, 90pc duty cycle)	WLAN	8.74	± 9.6 %
10726	AAA	IEEE 802.11ax (80MHz, MCS7, 90pc duty cycle)	WLAN	8.72	± 9.6 %

10727	AAA	IEEE 802.11ax (80MHz, MCS8, 90pc duty cycle)	WLAN	8.66	± 9.6 %
10728	AAA	IEEE 802.11ax (80MHz, MCS9, 90pc duty cycle)	WLAN	8.65	± 9.6 %
10729	AAA	IEEE 802.11ax (80MHz, MCS10, 90pc duty cycle)	WLAN	8.64	± 9.6 %
10730	AAA	IEEE 802.11ax (80MHz, MCS11, 90pc duty cycle)	WLAN	8.67	± 9.6 %
10731	AAA	IEEE 802.11ax (80MHz, MCS0, 99pc duty cycle)	WLAN	8.42	± 9.6 %
10732	AAA	IEEE 802.11ax (80MHz, MCS1, 99pc duty cycle)	WLAN	8.46	± 9.6 %
10733	AAA	IEEE 802.11ax (80MHz, MCS2, 99pc duty cycle)	WLAN	8.40	± 9.6 %
10734	AAA	IEEE 802.11ax (80MHz, MCS3, 99pc duty cycle)	WLAN	8.25	± 9.6 %
10735	AAA	IEEE 802.11ax (80MHz, MCS4, 99pc duty cycle)	WLAN	8.33	± 9.6 %
10736	AAA	IEEE 802.11ax (80MHz, MCS5, 99pc duty cycle)	WLAN	8.27	± 9.6 %
10737	AAA	IEEE 802.11ax (80MHz, MCS6, 99pc duty cycle)	WLAN	8.36	± 9.6 %
10738	AAA	IEEE 802.11ax (80MHz, MCS7, 99pc duty cycle)	WLAN	8.42	± 9.6 %
10739	AAA	IEEE 802.11ax (80MHz, MCS8, 99pc duty cycle)	WLAN	8.29	± 9.6 %
10740	AAA	IEEE 802.11ax (80MHz, MCS9, 99pc duty cycle)	WLAN	8.48	± 9.6 %
10741	AAA	IEEE 802.11ax (80MHz, MCS10, 99pc duty cycle)	WLAN	8.40	± 9.6 %
10742	AAA	IEEE 802.11ax (80MHz, MCS11, 99pc duty cycle)	WLAN	8.43	± 9.6 %
10743	AAA	IEEE 802.11ax (160MHz, MCS0, 90pc duty cycle)	WLAN	8.94	± 9.6 %
10744	AAA	IEEE 802.11ax (160MHz, MCS1, 90pc duty cycle)	WLAN	9.16	± 9.6 %
10745	AAA	IEEE 802.11ax (160MHz, MCS2, 90pc duty cycle)	WLAN	8.93	± 9.6 %
10746	AAA	IEEE 802.11ax (160MHz, MCS3, 90pc duty cycle)	WLAN	9.11	± 9.6 %
10747	AAA	IEEE 802.11ax (160MHz, MCS4, 90pc duty cycle)	WLAN	9.04	± 9.6 %
10748	AAA	IEEE 802.11ax (160MHz, MCS5, 90pc duty cycle)	WLAN	8.93	± 9.6 %
10749	AAA	IEEE 802.11ax (160MHz, MCS6, 90pc duty cycle)	WLAN	8.90	± 9.6 %
10750	AAA	IEEE 802.11ax (160MHz, MCS7, 90pc duty cycle)	WLAN	8.79	± 9.6 %
10751	AAA	IEEE 802.11ax (160MHz, MCS8, 90pc duty cycle)	WLAN	8.82	± 9.6 %
10752	AAA	IEEE 802.11ax (160MHz, MCS9, 90pc duty cycle)	WLAN	8.81	± 9.6 %
10753	AAA	IEEE 802.11ax (160MHz, MCS10, 90pc duty cycle)	WLAN	9.00	± 9.6 %
10754	AAA	IEEE 802.11ax (160MHz, MCS11, 90pc duty cycle)	WLAN	8.94	± 9.6 %
10755	AAA	IEEE 802.11ax (160MHz, MCS0, 99pc duty cycle)	WLAN	8.64	± 9.6 %
10756	AAA	IEEE 802.11ax (160MHz, MCS1, 99pc duty cycle)	WLAN	8.77	± 9.6 %
10757	AAA	IEEE 802.11ax (160MHz, MCS2, 99pc duty cycle)	WLAN	8.77	± 9.6 %
10758	AAA	IEEE 802.11ax (160MHz, MCS3, 99pc duty cycle)	WLAN	8.69	± 9.6 %
10759	AAA	IEEE 802.11ax (160MHz, MCS4, 99pc duty cycle)	WLAN	8.58	± 9.6 %
10760	AAA	IEEE 802.11ax (160MHz, MCS5, 99pc duty cycle)	WLAN	8.49	± 9.6 %
10761	AAA	IEEE 802.11ax (160MHz, MCS6, 99pc duty cycle)	WLAN	8.58	± 9.6 %
10762	AAA	IEEE 802.11ax (160MHz, MCS7, 99pc duty cycle)	WLAN	8.49	± 9.6 %
10763	AAA	IEEE 802.11ax (160MHz, MCS8, 99pc duty cycle)	WLAN	8.53	± 9.6 %
10764	AAA	IEEE 802.11ax (160MHz, MCS9, 99pc duty cycle)	WLAN	8.54	± 9.6 %
10765	AAA	IEEE 802.11ax (160MHz, MCS10, 99pc duty cycle)	WLAN	8.54	± 9.6 %
10766	AAA	IEEE 802.11ax (160MHz, MCS11, 99pc duty cycle)	WLAN	8.51	± 9.6 %
10767	AAB	5G NR (CP-OFDM, 1 RB, 5 MHz, QPSK, 15 kHz)	5G NR FR1 TDD	7.99	± 9.6 %
10768	AAB	5G NR (CP-OFDM, 1 RB, 10 MHz, QPSK, 15 kHz)	5G NR FR1 TDD	8.01	± 9.6 %
10769	AAB	5G NR (CP-OFDM, 1 RB, 15 MHz, QPSK, 15 kHz)	5G NR FR1 TDD	8.01	± 9.6 %
10770	AAB	5G NR (CP-OFDM, 1 RB, 20 MHz, QPSK, 15 kHz)	5G NR FR1 TDD	8.02	± 9.6 %
10771	AAB	5G NR (CP-OFDM, 1 RB, 25 MHz, QPSK, 15 kHz)	5G NR FR1 TDD	8.02	± 9.6 %
10772	AAB	5G NR (CP-OFDM, 1 RB, 30 MHz, QPSK, 15 kHz)	5G NR FR1 TDD	8.23	± 9.6 %
10773	AAB	5G NR (CP-OFDM, 1 RB, 40 MHz, QPSK, 15 kHz)	5G NR FR1 TDD	8.03	± 9.6 %
10774	AAB	5G NR (CP-OFDM, 1 RB, 50 MHz, QPSK, 15 kHz)	5G NR FR1 TDD	8.02	± 9.6 %
10776	AAB	5G NR (CP-OFDM, 50% RB, 10 MHz, QPSK, 15 kHz)	5G NR FR1 TDD	8.30	± 9.6 %
10778	AAB	5G NR (CP-OFDM, 50% RB, 20 MHz, QPSK, 15 kHz)	5G NR FR1 TDD	8.34	± 9.6 %
10780	AAB	5G NR (CP-OFDM, 50% RB, 30 MHz, QPSK, 15 kHz)	5G NR FR1 TDD	8.38	± 9.6 %
10781	AAB	5G NR (CP-OFDM, 50% RB, 40 MHz, QPSK, 15 kHz)	5G NR FR1 TDD	8.38	± 9.6 %

10782	AAB	5G NR (CP-OFDM, 50% RB, 50 MHz, QPSK, 15 kHz)	5G NR FR1 TDD	8.43	± 9.6 %
10783	AAB	5G NR (CP-OFDM, 100% RB, 5 MHz, QPSK, 15 kHz)	5G NR FR1 TDD	8.31	± 9.6 %
10784	AAB	5G NR (CP-OFDM, 100% RB, 10 MHz, QPSK, 15 kHz)	5G NR FR1 TDD	8.29	± 9.6 %
10785	AAB	5G NR (CP-OFDM, 100% RB, 15 MHz, QPSK, 15 kHz)	5G NR FR1 TDD	8.40	± 9.6 %
10786	AAB	5G NR (CP-OFDM, 100% RB, 20 MHz, QPSK, 15 kHz)	5G NR FR1 TDD	8.35	± 9.6 %
10787	AAB	5G NR (CP-OFDM, 100% RB, 25 MHz, QPSK, 15 kHz)	5G NR FR1 TDD	8.44	± 9.6 %
10788	AAB	5G NR (CP-OFDM, 100% RB, 30 MHz, QPSK, 15 kHz)	5G NR FR1 TDD	8.39	± 9.6 %
10789	AAB	5G NR (CP-OFDM, 100% RB, 40 MHz, QPSK, 15 kHz)	5G NR FR1 TDD	8.37	± 9.6 %
10790	AAB	5G NR (CP-OFDM, 100% RB, 50 MHz, QPSK, 15 kHz)	5G NR FR1 TDD	8.39	± 9.6 %
10791	AAB	5G NR (CP-OFDM, 1 RB, 5 MHz, QPSK, 30 kHz)	5G NR FR1 TDD	7.83	± 9.6 %
10792	AAB	5G NR (CP-OFDM, 1 RB, 10 MHz, QPSK, 30 kHz)	5G NR FR1 TDD	7.92	± 9.6 %
10793	AAB	5G NR (CP-OFDM, 1 RB, 15 MHz, QPSK, 30 kHz)	5G NR FR1 TDD	7.95	± 9.6 %
10794	AAB	5G NR (CP-OFDM, 1 RB, 20 MHz, QPSK, 30 kHz)	5G NR FR1 TDD	7.82	± 9.6 %
10795	AAB	5G NR (CP-OFDM, 1 RB, 25 MHz, QPSK, 30 kHz)	5G NR FR1 TDD	7.84	± 9.6 %
10796	AAB	5G NR (CP-OFDM, 1 RB, 30 MHz, QPSK, 30 kHz)	5G NR FR1 TDD	7.82	± 9.6 %
10797	AAB	5G NR (CP-OFDM, 1 RB, 40 MHz, QPSK, 30 kHz)	5G NR FR1 TDD	8.01	± 9.6 %
10798	AAB	5G NR (CP-OFDM, 1 RB, 50 MHz, QPSK, 30 kHz)	5G NR FR1 TDD	7.89	± 9.6 %
10799	AAB	5G NR (CP-OFDM, 1 RB, 60 MHz, QPSK, 30 kHz)	5G NR FR1 TDD	7.93	± 9.6 %
10801	AAB	5G NR (CP-OFDM, 1 RB, 80 MHz, QPSK, 30 kHz)	5G NR FR1 TDD	7.89	± 9.6 %
10802	AAB	5G NR (CP-OFDM, 1 RB, 90 MHz, QPSK, 30 kHz)	5G NR FR1 TDD	7.87	± 9.6 %
10803	AAB	5G NR (CP-OFDM, 1 RB, 100 MHz, QPSK, 30 kHz)	5G NR FR1 TDD	7.93	± 9.6 %
10805	AAB	5G NR (CP-OFDM, 50% RB, 10 MHz, QPSK, 30 kHz)	5G NR FR1 TDD	8.34	± 9.6 %
10806	AAB	5G NR (CP-OFDM, 50% RB, 15 MHz, QPSK, 30 kHz)	5G NR FR1 TDD	8.37	± 9.6 %
10809	AAB	5G NR (CP-OFDM, 50% RB, 30 MHz, QPSK, 30 kHz)	5G NR FR1 TDD	8.34	± 9.6 %
10810	AAB	5G NR (CP-OFDM, 50% RB, 40 MHz, QPSK, 30 kHz)	5G NR FR1 TDD	8.34	± 9.6 %
10812	AAB	5G NR (CP-OFDM, 50% RB, 60 MHz, QPSK, 30 kHz)	5G NR FR1 TDD	8.35	± 9.6 %
10817	AAB	5G NR (CP-OFDM, 100% RB, 5 MHz, QPSK, 30 kHz)	5G NR FR1 TDD	8.35	± 9.6 %
10818	AAB	5G NR (CP-OFDM, 100% RB, 10 MHz, QPSK, 30 kHz)	5G NR FR1 TDD	8.34	± 9.6 %
10819	AAB	5G NR (CP-OFDM, 100% RB, 15 MHz, QPSK, 30 kHz)	5G NR FR1 TDD	8.33	± 9.6 %
10820	AAB	5G NR (CP-OFDM, 100% RB, 20 MHz, QPSK, 30 kHz)	5G NR FR1 TDD	8.30	± 9.6 %
10821	AAB	5G NR (CP-OFDM, 100% RB, 25 MHz, QPSK, 30 kHz)	5G NR FR1 TDD	8.41	± 9.6 %
10822	AAB	5G NR (CP-OFDM, 100% RB, 30 MHz, QPSK, 30 kHz)	5G NR FR1 TDD	8.41	± 9.6 %
10823	AAB	5G NR (CP-OFDM, 100% RB, 40 MHz, QPSK, 30 kHz)	5G NR FR1 TDD	8.36	± 9.6 %

10824	AAB	5G NR (CP-OFDM, 100% RB, 50 MHz, QPSK, 30 kHz)	5G NR FR1 TDD	8.39	± 9.6 %
10825	AAB	5G NR (CP-OFDM, 100% RB, 60 MHz, QPSK, 30 kHz)	5G NR FR1 TDD	8.41	± 9.6 %
10827	AAB	5G NR (CP-OFDM, 100% RB, 80 MHz, QPSK, 30 kHz)	5G NR FR1 TDD	8.42	± 9.6 %
10828	AAB	5G NR (CP-OFDM, 100% RB, 90 MHz, QPSK, 30 kHz)	5G NR FR1 TDD	8.43	± 9.6 %
10829	AAB	5G NR (CP-OFDM, 100% RB, 100 MHz, QPSK, 30 kHz)	5G NR FR1 TDD	8.40	± 9.6 %
10830	AAB	5G NR (CP-OFDM, 1 RB, 10 MHz, QPSK, 60 kHz)	5G NR FR1 TDD	7.63	± 9.6 %
10831	AAB	5G NR (CP-OFDM, 1 RB, 15 MHz, QPSK, 60 kHz)	5G NR FR1 TDD	7.73	± 9.6 %
10832	AAB	5G NR (CP-OFDM, 1 RB, 20 MHz, QPSK, 60 kHz)	5G NR FR1 TDD	7.74	± 9.6 %
10833	AAB	5G NR (CP-OFDM, 1 RB, 25 MHz, QPSK, 60 kHz)	5G NR FR1 TDD	7.70	± 9.6 %
10834	AAB	5G NR (CP-OFDM, 1 RB, 30 MHz, QPSK, 60 kHz)	5G NR FR1 TDD	7.75	± 9.6 %
10835	AAB	5G NR (CP-OFDM, 1 RB, 40 MHz, QPSK, 60 kHz)	5G NR FR1 TDD	7.70	± 9.6 %
10836	AAB	5G NR (CP-OFDM, 1 RB, 50 MHz, QPSK, 60 kHz)	5G NR FR1 TDD	7.66	± 9.6 %
10837	AAB	5G NR (CP-OFDM, 1 RB, 60 MHz, QPSK, 60 kHz)	5G NR FR1 TDD	7.68	± 9.6 %
10839	AAB	5G NR (CP-OFDM, 1 RB, 80 MHz, QPSK, 60 kHz)	5G NR FR1 TDD	7.70	± 9.6 %
10840	AAB	5G NR (CP-OFDM, 1 RB, 90 MHz, QPSK, 60 kHz)	5G NR FR1 TDD	7.67	± 9.6 %
10841	AAB	5G NR (CP-OFDM, 1 RB, 100 MHz, QPSK, 60 kHz)	5G NR FR1 TDD	7.71	± 9.6 %
10843	AAB	5G NR (CP-OFDM, 50% RB, 15 MHz, QPSK, 60 kHz)	5G NR FR1 TDD	8.49	± 9.6 %
10844	AAB	5G NR (CP-OFDM, 50% RB, 20 MHz, QPSK, 60 kHz)	5G NR FR1 TDD	8.34	± 9.6 %
10846	AAB	5G NR (CP-OFDM, 50% RB, 30 MHz, QPSK, 60 kHz)	5G NR FR1 TDD	8.41	± 9.6 %
10854	AAB	5G NR (CP-OFDM, 100% RB, 10 MHz, QPSK, 60 kHz)	5G NR FR1 TDD	8.34	± 9.6 %
10855	AAB	5G NR (CP-OFDM, 100% RB, 15 MHz, QPSK, 60 kHz)	5G NR FR1 TDD	8.36	± 9.6 %
10856	AAB	5G NR (CP-OFDM, 100% RB, 20 MHz, QPSK, 60 kHz)	5G NR FR1 TDD	8.37	± 9.6 %
10857	AAB	5G NR (CP-OFDM, 100% RB, 25 MHz, QPSK, 60 kHz)	5G NR FR1 TDD	8.35	± 9.6 %
10858	AAB	5G NR (CP-OFDM, 100% RB, 30 MHz, QPSK, 60 kHz)	5G NR FR1 TDD	8.36	± 9.6 %
10859	AAB	5G NR (CP-OFDM, 100% RB, 40 MHz, QPSK, 60 kHz)	5G NR FR1 TDD	8.34	± 9.6 %
10860	AAB	5G NR (CP-OFDM, 100% RB, 50 MHz, QPSK, 60 kHz)	5G NR FR1 TDD	8.41	± 9.6 %
10861	AAB	5G NR (CP-OFDM, 100% RB, 60 MHz, QPSK, 60 kHz)	5G NR FR1 TDD	8.40	± 9.6 %
10863	AAB	5G NR (CP-OFDM, 100% RB, 80 MHz, QPSK, 60 kHz)	5G NR FR1 TDD	8.41	± 9.6 %
10864	AAB	5G NR (CP-OFDM, 100% RB, 90 MHz, QPSK, 60 kHz)	5G NR FR1 TDD	8.37	± 9.6 %
10865	AAB	5G NR (CP-OFDM, 100% RB, 100 MHz, QPSK, 60 kHz)	5G NR FR1 TDD	8.41	± 9.6 %
10866	AAB	5G NR (DFT-s-OFDM, 1 RB, 100 MHz, QPSK, 30 kHz)	5G NR FR1 TDD	5.68	± 9.6 %
10868	AAB	5G NR (DFT-s-OFDM, 100% RB, 100 MHz, QPSK, 30 kHz)	5G NR FR1 TDD	5.89	± 9.6 %
10869	AAC	5G NR (DFT-s-OFDM, 1 RB, 100 MHz, QPSK, 120 kHz)	5G NR FR2 TDD	5.75	± 9.6 %

10870	AAC	5G NR (DFT-s-OFDM, 100% RB, 100 MHz, QPSK, 120 kHz)	5G NR FR2 TDD	5.86	± 9.6 %
10871	AAC	5G NR (DFT-s-OFDM, 1 RB, 100 MHz, 16QAM, 120 kHz)	5G NR FR2 TDD	5.75	± 9.6 %
10872	AAC	5G NR (DFT-s-OFDM, 100% RB, 100 MHz, 16QAM, 120 kHz)	5G NR FR2 TDD	6.52	± 9.6 %
10873	AAC	5G NR (DFT-s-OFDM, 1 RB, 100 MHz, 64QAM, 120 kHz)	5G NR FR2 TDD	6.61	± 9.6 %
10874	AAC	5G NR (DFT-s-OFDM, 100% RB, 100 MHz, 64QAM, 120 kHz)	5G NR FR2 TDD	6.65	± 9.6 %
10875	AAC	5G NR (CP-OFDM, 1 RB, 100 MHz, QPSK, 120 kHz)	5G NR FR2 TDD	7.78	± 9.6 %
10876	AAC	5G NR (CP-OFDM, 100% RB, 100 MHz, QPSK, 120 kHz)	5G NR FR2 TDD	8.39	± 9.6 %
10877	AAC	5G NR (CP-OFDM, 1 RB, 100 MHz, 16QAM, 120 kHz)	5G NR FR2 TDD	7.95	± 9.6 %
10878	AAC	5G NR (CP-OFDM, 100% RB, 100 MHz, 16QAM, 120 kHz)	5G NR FR2 TDD	8.41	± 9.6 %
10879	AAC	5G NR (CP-OFDM, 1 RB, 100 MHz, 64QAM, 120 kHz)	5G NR FR2 TDD	8.12	± 9.6 %
10880	AAC	5G NR (CP-OFDM, 100% RB, 100 MHz, 64QAM, 120 kHz)	5G NR FR2 TDD	8.38	± 9.6 %
10881	AAC	5G NR (DFT-s-OFDM, 1 RB, 50 MHz, QPSK, 120 kHz)	5G NR FR2 TDD	5.75	± 9.6 %
10882	AAC	5G NR (DFT-s-OFDM, 100% RB, 50 MHz, QPSK, 120 kHz)	5G NR FR2 TDD	5.96	± 9.6 %
10883	AAC	5G NR (DFT-s-OFDM, 1 RB, 50 MHz, 16QAM, 120 kHz)	5G NR FR2 TDD	6.57	± 9.6 %
10884	AAC	5G NR (DFT-s-OFDM, 100% RB, 50 MHz, 16QAM, 120 kHz)	5G NR FR2 TDD	6.53	± 9.6 %
10885	AAC	5G NR (DFT-s-OFDM, 1 RB, 50 MHz, 64QAM, 120 kHz)	5G NR FR2 TDD	6.61	± 9.6 %
10886	AAC	5G NR (DFT-s-OFDM, 100% RB, 50 MHz, 64QAM, 120 kHz)	5G NR FR2 TDD	6.65	± 9.6 %
10887	AAC	5G NR (CP-OFDM, 1 RB, 50 MHz, QPSK, 120 kHz)	5G NR FR2 TDD	7.78	± 9.6 %
10888	AAC	5G NR (CP-OFDM, 100% RB, 50 MHz, QPSK, 120 kHz)	5G NR FR2 TDD	8.35	± 9.6 %
10889	AAC	5G NR (CP-OFDM, 1 RB, 50 MHz, 16QAM, 120 kHz)	5G NR FR2 TDD	8.02	± 9.6 %
10890	AAC	5G NR (CP-OFDM, 100% RB, 50 MHz, 16QAM, 120 kHz)	5G NR FR2 TDD	8.40	± 9.6 %
10891	AAC	5G NR (CP-OFDM, 1 RB, 50 MHz, 64QAM, 120 kHz)	5G NR FR2 TDD	8.13	± 9.6 %
10892	AAC	5G NR (CP-OFDM, 100% RB, 50 MHz, 64QAM, 120 kHz)	5G NR FR2 TDD	8.41	± 9.6 %

^E Uncertainty is determined using the max. deviation from linear response applying rectangular distribution and is expressed for the square of the field value.



Accredited by the Swiss Accreditation Service (SAS)
The Swiss Accreditation Service is one of the signatories to the EA
Multilateral Agreement for the recognition of calibration certificates

Accreditation No.: **SCS 0108**

Client **PC Test**

Certificate No: **EUmmWV3-9407_Dec19**

CALIBRATION CERTIFICATE

Object: **EUmmWV3 - SN:9407**

Calibration procedure(s): **QA CAL-02.v9, QA CAL-25.v7, QA CAL-42.v2**
Calibration procedure for E-field probes optimized for close near field evaluations in air

Calibration date: **December 10, 2019**

*MAS
4/10/20*

This calibration certificate documents the traceability to national standards, which realize the physical units of measurements (SI). The measurements and the uncertainties with confidence probability are given on the following pages and are part of the certificate.

All calibrations have been conducted in the closed laboratory facility: environment temperature (22 ± 3)°C and humidity < 70%.

Calibration Equipment used (M&TE critical for calibration)

Primary Standards	ID	Cal Date (Certificate No.)	Scheduled Calibration
Power meter NRP	SN: 104778	03-Apr-19 (No. 217-02892/02893)	Apr-20
Power sensor NRP-Z91	SN: 103244	03-Apr-19 (No. 217-02892)	Apr-20
Power sensor NRP-Z91	SN: 103245	03-Apr-19 (No. 217-02893)	Apr-20
Reference 20 dB Attenuator	SN: S5277 (20x)	04-Apr-19 (No. 217-02894)	Apr-20
Reference Probe ER3DV6	SN: 2328	05-Oct-19 (No. ER3-2328_Oct19)	Oct-20
DAE4	SN: 789	14-Jan-19 (No. DAE4-789_Jan19)	Jan-20
Secondary Standards	ID	Check Date (in house)	Scheduled Check
Power meter E4419B	SN: GB41293874	06-Apr-16 (in house check Jun-18)	In house check: Jun-20
Power sensor E4412A	SN: MY41498087	06-Apr-16 (in house check Jun-18)	In house check: Jun-20
Power sensor E4412A	SN: 000110210	06-Apr-16 (in house check Jun-18)	In house check: Jun-20
RF generator HP 8648C	SN: US3642U01700	04-Aug-99 (in house check Jun-18)	In house check: Jun-20
Network Analyzer HP 8753E	SN: US37390585	18-Oct-01 (in house check Oct-19)	In house check: Oct-20

	Name	Function	Signature
Calibrated by:	Jeton Kastrati	Laboratory Technician	
Approved by:	Katja Pokovic	Technical Manager	

Issued: December 17, 2019

This calibration certificate shall not be reproduced except in full without written approval of the laboratory.



Accredited by the Swiss Accreditation Service (SAS)

Accreditation No.: **SCS 0108**

The Swiss Accreditation Service is one of the signatories to the EA Multilateral Agreement for the recognition of calibration certificates

Glossary:

NORM _{x,y,z}	sensitivity in free space
DCP	diode compression point
CF	crest factor (1/duty_cycle) of the RF signal
A, B, C, D	modulation dependent linearization parameters
Polarization φ	φ rotation around probe axis
Polarization ϑ	ϑ rotation around an axis that is in the plane normal to probe axis (at measurement center), i.e., $\vartheta = 0$ is normal to probe axis
Connector Angle	information used in DASY system to align probe sensor X to the robot coordinate system
Sensor Angles	sensor deviation from the probe axis, used to calculate the field orientation and polarization
k	is the wave propagation direction

Calibration is Performed According to the Following Standards:

- a) IEEE Std 1309-2005, "IEEE Standard for calibration of electromagnetic field sensors and probes, excluding antennas, from 9 kHz to 40 GHz", December 2005

Methods Applied and Interpretation of Parameters:

- *NORM_{x,y,z}*: Assessed for E-field polarization $\vartheta = 0$ for XY sensors and $\vartheta = 90$ for Z sensor ($f \leq 900$ MHz in TEM-cell; $f > 1800$ MHz: R22 waveguide). For frequencies > 6 GHz, the far field in front of waveguide horn antennas is measured for a set of frequencies in various waveguide bands up to 110 GHz.
- *DCP_{x,y,z}*: DCP are numerical linearization parameters assessed based on the data of power sweep with CW signal (no uncertainty required). DCP does not depend on frequency nor media.
- *PAR*: PAR is the Peak to Average Ratio that is not calibrated but determined based on the signal characteristics
- The frequency sensor model parameters are determined prior to calibration based on a frequency sweep (sensor model involving resistors R, R_p, inductance L and capacitors C, C_p).
- *A_{x,y,z}; B_{x,y,z}; C_{x,y,z}; D_{x,y,z}; VR_{x,y,z}*: A, B, C, D are numerical linearization parameters assessed based on the data of power sweep for specific modulation signal. The parameters do not depend on frequency nor media. VR is the maximum calibration range expressed in RMS voltage across the diode.
- *Sensor Offset*: The sensor offset corresponds to the mechanical from the probe tip (on probe axis). No tolerance required.
- *Connector Angle*: The angle is assessed using the information gained by determining the *NORM_x* (no uncertainty required).
- *Equivalent Sensor Angle*: The two probe sensors are mounted in the same plane at different angles. The angles are assessed using the information gained by determining the *NORM_x* (no uncertainty required).
- *Spherical isotropy (3D deviation from isotropy)*: in a locally homogeneous field realized using an open waveguide / horn setup.

DASY - Parameters of Probe: EUmmWV3 - SN:9407

Basic Calibration Parameters

	Sensor X	Sensor Y	Unc (k=2)
Norm ($\mu\text{V}/(\text{V}/\text{m})^2$)	0.02290	0.02745	$\pm 10.1 \%$
DCP (mV) ^B	102.0	113.0	
Equivalent Sensor Angle	-58.6	31.2	

Calibration results for Frequency Response (750 MHz – 110 GHz)

Frequency GHz	Target E-Field V/m	Deviation Sensor X dB	Deviation Sensor Y dB	Unc (k=2) dB
0.75	77.2	-0.15	0.33	± 0.43 dB
1.8	140.4	0.13	0.23	± 0.43 dB
2	133.0	0.07	0.13	± 0.43 dB
2.2	124.8	0.05	0.04	± 0.43 dB
2.5	123.0	-0.07	-0.19	± 0.43 dB
3.5	256.2	0.02	-0.32	± 0.43 dB
3.7	249.8	0.08	-0.30	± 0.43 dB
6.6	41.8	0.47	0.49	± 0.98 dB
8	48.4	-0.03	-0.20	± 0.98 dB
10	54.4	-0.04	0.00	± 0.98 dB
15	71.5	0.36	-0.21	± 0.98 dB
18	85.3	-0.36	0.03	± 0.98 dB
26.6	96.9	-0.14	0.03	± 0.98 dB
30	92.6	0.12	0.08	± 0.98 dB
35	93.7	-0.37	-0.21	± 0.98 dB
40	91.5	-0.62	-0.59	± 0.98 dB
50	19.6	-0.07	0.01	± 0.98 dB
55	22.4	0.68	0.42	± 0.98 dB
60	23.0	0.06	0.02	± 0.98 dB
65	27.4	-0.38	-0.09	± 0.98 dB
70	23.9	-0.15	-0.23	± 0.98 dB
75	20.0	-0.09	-0.06	± 0.98 dB
75	14.8	0.10	0.21	± 0.98 dB
80	22.5	0.38	0.35	± 0.98 dB
85	22.8	0.13	0.09	± 0.98 dB
90	23.8	-0.03	0.04	± 0.98 dB
92	23.9	0.12	-0.08	± 0.98 dB
95	20.5	-0.03	-0.19	± 0.98 dB
97	24.4	-0.06	-0.15	± 0.98 dB
100	22.6	0.09	-0.07	± 0.98 dB
105	22.7	-0.08	0.00	± 0.98 dB
110	19.7	0.08	0.23	± 0.98 dB

The reported uncertainty of measurement is stated as the standard uncertainty of measurement multiplied by the coverage factor k=2, which for a normal distribution corresponds to a coverage probability of approximately 95%.

^B Numerical linearization parameter: uncertainty not required.

^E Uncertainty is determined using the max. deviation from linear response applying rectangular distribution and is expressed for the square of the field value.

DASY - Parameters of Probe: EUmmWV3 - SN:9407

Calibration Results for Modulation Response

UID	Communication System Name		A dB	B dB/√μV	C	D dB	VR mV	Max dev.	Max Unc ^E (k=2)
0	CW	X	0.00	0.00	1.00	0.00	109.4	± 2.7 %	± 4.7 %
		Y	0.00	0.00	1.00		86.2		
10352-AAA	Pulse Waveform (200Hz, 10%)	X	2.12	60.00	13.39	10.00	6.0	± 1.3 %	± 9.6 %
		Y	1.41	60.00	14.71		6.0		
10353-AAA	Pulse Waveform (200Hz, 20%)	X	1.37	60.00	12.36	6.99	12.0	± 0.8 %	± 9.6 %
		Y	0.94	60.00	13.81		12.0		
10354-AAA	Pulse Waveform (200Hz, 40%)	X	0.78	60.00	11.17	3.98	23.0	± 1.0 %	± 9.6 %
		Y	0.56	60.00	12.74		23.0		
10355-AAA	Pulse Waveform (200Hz, 60%)	X	0.48	60.00	10.18	2.22	27.0	± 0.9 %	± 9.6 %
		Y	0.38	60.00	11.82		27.0		
10387-AAA	QPSK Waveform, 1 MHz	X	1.19	117.15	13.96	0.00	22.0	± 1.1 %	± 9.6 %
		Y	3.79	84.56	1.83		22.0		
10388-AAA	QPSK Waveform, 10 MHz	X	1.27	60.00	11.50	0.00	22.0	± 0.6 %	± 9.6 %
		Y	1.17	60.00	11.99		22.0		
10396-AAA	64-QAM Waveform, 100 kHz	X	1.93	60.00	13.68	3.01	17.0	± 0.6 %	± 9.6 %
		Y	1.90	60.00	13.43		17.0		
10399-AAA	64-QAM Waveform, 40 MHz	X	2.13	60.00	12.16	0.00	19.0	± 0.7 %	± 9.6 %
		Y	1.93	60.00	12.50		19.0		
10414-AAA	WLAN CCDF, 64-QAM, 40MHz	X	3.20	60.00	12.63	0.00	12.0	± 0.8 %	± 9.6 %
		Y	2.86	60.00	12.92		12.0		

Note: For details on all calibrated UID parameters see Appendix

Calibration Results for Linearity Response

Frequency GHz	Target E-Field V/m	Deviation Sensor X dB	Deviation Sensor Y dB	Unc (k=2) dB
0.9	50.0	0.10	-0.02	± 0.2 dB
0.9	100.0	0.01	0.02	± 0.2 dB
0.9	500.0	0.00	-0.02	± 0.2 dB
0.9	1000.0	0.03	0.01	± 0.2 dB
0.9	1500.0	0.00	0.00	± 0.2 dB
0.9	2000.0	-0.04	0.01	± 0.2 dB

Sensor Frequency Model Parameters (750 MHz – 78 GHz)

	Sensor X	Sensor Y
R (Ω)	47.82	49.82
R _p (Ω)	92.12	88.50
L (nH)	0.03674	0.04042
C (pF)	0.2744	0.2956
C _p (pF)	0.1087	0.1004

Sensor Frequency Model Parameters (55 GHz – 110 GHz)

	Sensor X	Sensor Y
R (Ω)	34.05	43.37
R _p (Ω)	97.85	91.31
L (nH)	0.03646	0.02927
C (pF)	0.1587	0.3237
C _p (pF)	0.1222	0.1221

DASY - Parameters of Probe: EUmmWV3 - SN:9407

Sensor Model Parameters

	C1 fF	C2 fF	α V ⁻¹	T1 ms.V ⁻²	T2 ms.V ⁻¹	T3 ms	T4 V ⁻²	T5 V ⁻¹	T6
X	28.4	213.34	35.57	0.92	3.76	4.99	0.00	1.13	1.01
Y	28.5	198.32	31.35	0.92	2.68	5.01	0.00	1.20	1.00

Other Probe Parameters

Sensor Arrangement	Rectangular
Connector Angle (°)	201.2
Mechanical Surface Detection Mode	enabled
Optical Surface Detection Mode	disabled
Probe Overall Length	320 mm
Probe Body Diameter	8 mm
Tip Length	23 mm
Tip Diameter	8.0 mm
Probe Tip to Sensor X Calibration Point	1.5 mm
Probe Tip to Sensor Y Calibration Point	1.5 mm

Deviation from Isotropy in Air

f = 30, 60 GHz

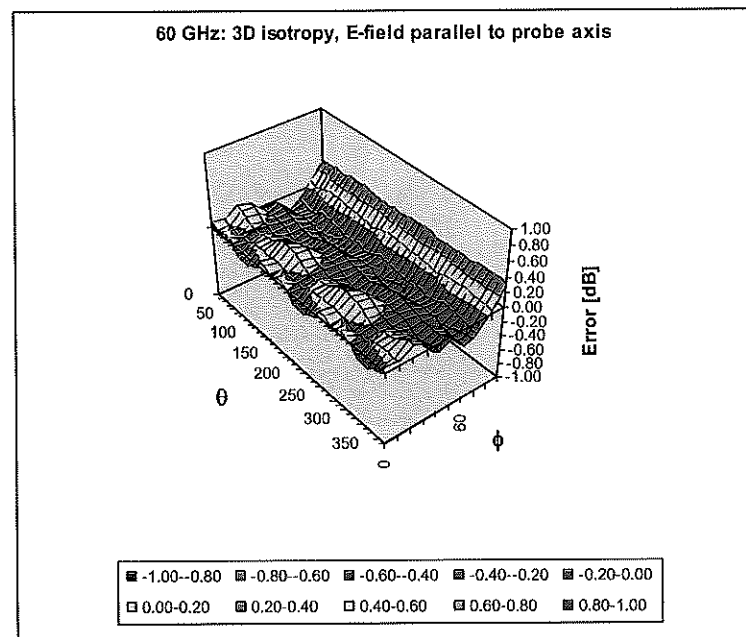
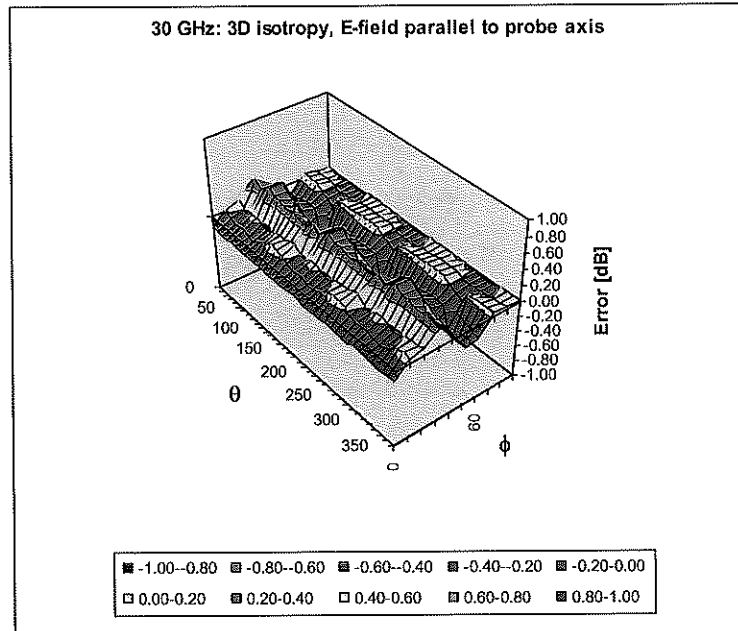

Probe isotropy for E_{tot} : probe rotated $\phi = 0^\circ$ to 360° , tilted from field propagation direction \vec{k}
 Parallel to the field propagation ($\psi = 0^\circ - 90^\circ$) at 30 GHz: deviation within ± 0.39 dB
 Parallel to the field propagation ($\psi = 0^\circ - 90^\circ$) at 60 GHz: deviation within ± 0.30 dB

Appendix: Modulation Calibration Parameters

UID	Rev	Communication System Name	Group	PAR (dB)	Unc ^F (k=2)
0		CW	CW	0.00	± 4.7 %
10010	CAA	SAR Validation (Square, 100ms, 10ms)	Test	10.00	± 9.6 %
10011	CAB	UMTS-FDD (WCDMA)	WCDMA	2.91	± 9.6 %
10012	CAB	IEEE 802.11b WiFi 2.4 GHz (DSSS, 1 Mbps)	WLAN	1.87	± 9.6 %
10013	CAB	IEEE 802.11g WiFi 2.4 GHz (DSSS-OFDM, 6 Mbps)	WLAN	9.46	± 9.6 %
10021	DAC	GSM-FDD (TDMA, GMSK)	GSM	9.39	± 9.6 %
10023	DAC	GPRS-FDD (TDMA, GMSK, TN 0)	GSM	9.57	± 9.6 %
10024	DAC	GPRS-FDD (TDMA, GMSK, TN 0-1)	GSM	6.56	± 9.6 %
10025	DAC	EDGE-FDD (TDMA, 8PSK, TN 0)	GSM	12.62	± 9.6 %
10026	DAC	EDGE-FDD (TDMA, 8PSK, TN 0-1)	GSM	9.55	± 9.6 %
10027	DAC	GPRS-FDD (TDMA, GMSK, TN 0-1-2)	GSM	4.80	± 9.6 %
10028	DAC	GPRS-FDD (TDMA, GMSK, TN 0-1-2-3)	GSM	3.55	± 9.6 %
10029	DAC	EDGE-FDD (TDMA, 8PSK, TN 0-1-2)	GSM	7.78	± 9.6 %
10030	CAA	IEEE 802.15.1 Bluetooth (GFSK, DH1)	Bluetooth	5.30	± 9.6 %
10031	CAA	IEEE 802.15.1 Bluetooth (GFSK, DH3)	Bluetooth	1.87	± 9.6 %
10032	CAA	IEEE 802.15.1 Bluetooth (GFSK, DH5)	Bluetooth	1.16	± 9.6 %
10033	CAA	IEEE 802.15.1 Bluetooth (PI/4-DQPSK, DH1)	Bluetooth	7.74	± 9.6 %
10034	CAA	IEEE 802.15.1 Bluetooth (PI/4-DQPSK, DH3)	Bluetooth	4.53	± 9.6 %
10035	CAA	IEEE 802.15.1 Bluetooth (PI/4-DQPSK, DH5)	Bluetooth	3.83	± 9.6 %
10036	CAA	IEEE 802.15.1 Bluetooth (8-DPSK, DH1)	Bluetooth	8.01	± 9.6 %
10037	CAA	IEEE 802.15.1 Bluetooth (8-DPSK, DH3)	Bluetooth	4.77	± 9.6 %
10038	CAA	IEEE 802.15.1 Bluetooth (8-DPSK, DH5)	Bluetooth	4.10	± 9.6 %
10039	CAB	CDMA2000 (1xRTT, RC1)	CDMA2000	4.57	± 9.6 %
10042	CAB	IS-54 / IS-136 FDD (TDMA/FDM, PI/4-DQPSK, Halfrate)	AMPS	7.78	± 9.6 %
10044	CAA	IS-91/EIA/TIA-553 FDD (FDMA, FM)	AMPS	0.00	± 9.6 %
10048	CAA	DECT (TDD, TDMA/FDM, GFSK, Full Slot, 24)	DECT	13.80	± 9.6 %
10049	CAA	DECT (TDD, TDMA/FDM, GFSK, Double Slot, 12)	DECT	10.79	± 9.6 %
10056	CAA	UMTS-TDD (TD-SCDMA, 1.28 Mcps)	TD-SCDMA	11.01	± 9.6 %
10058	DAC	EDGE-FDD (TDMA, 8PSK, TN 0-1-2-3)	GSM	6.52	± 9.6 %
10059	CAB	IEEE 802.11b WiFi 2.4 GHz (DSSS, 2 Mbps)	WLAN	2.12	± 9.6 %
10060	CAB	IEEE 802.11b WiFi 2.4 GHz (DSSS, 5.5 Mbps)	WLAN	2.83	± 9.6 %
10061	CAB	IEEE 802.11b WiFi 2.4 GHz (DSSS, 11 Mbps)	WLAN	3.60	± 9.6 %
10062	CAC	IEEE 802.11a/h WiFi 5 GHz (OFDM, 6 Mbps)	WLAN	8.68	± 9.6 %
10063	CAC	IEEE 802.11a/h WiFi 5 GHz (OFDM, 9 Mbps)	WLAN	8.63	± 9.6 %
10064	CAC	IEEE 802.11a/h WiFi 5 GHz (OFDM, 12 Mbps)	WLAN	9.09	± 9.6 %
10065	CAC	IEEE 802.11a/h WiFi 5 GHz (OFDM, 18 Mbps)	WLAN	9.00	± 9.6 %
10066	CAC	IEEE 802.11a/h WiFi 5 GHz (OFDM, 24 Mbps)	WLAN	9.38	± 9.6 %
10067	CAC	IEEE 802.11a/h WiFi 5 GHz (OFDM, 36 Mbps)	WLAN	10.12	± 9.6 %
10068	CAC	IEEE 802.11a/h WiFi 5 GHz (OFDM, 48 Mbps)	WLAN	10.24	± 9.6 %
10069	CAC	IEEE 802.11a/h WiFi 5 GHz (OFDM, 54 Mbps)	WLAN	10.56	± 9.6 %
10071	CAB	IEEE 802.11g WiFi 2.4 GHz (DSSS/OFDM, 9 Mbps)	WLAN	9.83	± 9.6 %
10072	CAB	IEEE 802.11g WiFi 2.4 GHz (DSSS/OFDM, 12 Mbps)	WLAN	9.62	± 9.6 %
10073	CAB	IEEE 802.11g WiFi 2.4 GHz (DSSS/OFDM, 18 Mbps)	WLAN	9.94	± 9.6 %
10074	CAB	IEEE 802.11g WiFi 2.4 GHz (DSSS/OFDM, 24 Mbps)	WLAN	10.30	± 9.6 %
10075	CAB	IEEE 802.11g WiFi 2.4 GHz (DSSS/OFDM, 36 Mbps)	WLAN	10.77	± 9.6 %
10076	CAB	IEEE 802.11g WiFi 2.4 GHz (DSSS/OFDM, 48 Mbps)	WLAN	10.94	± 9.6 %
10077	CAB	IEEE 802.11g WiFi 2.4 GHz (DSSS/OFDM, 54 Mbps)	WLAN	11.00	± 9.6 %
10081	CAB	CDMA2000 (1xRTT, RC3)	CDMA2000	3.97	± 9.6 %
10082	CAB	IS-54 / IS-136 FDD (TDMA/FDM, PI/4-DQPSK, Fullrate)	AMPS	4.77	± 9.6 %
10090	DAC	GPRS-FDD (TDMA, GMSK, TN 0-4)	GSM	6.56	± 9.6 %
10097	CAB	UMTS-FDD (HSDPA)	WCDMA	3.98	± 9.6 %
10098	CAB	UMTS-FDD (HSUPA, Subtest 2)	WCDMA	3.98	± 9.6 %
10099	DAC	EDGE-FDD (TDMA, 8PSK, TN 0-4)	GSM	9.55	± 9.6 %
10100	CAE	LTE-FDD (SC-FDMA, 100% RB, 20 MHz, QPSK)	LTE-FDD	5.67	± 9.6 %
10101	CAE	LTE-FDD (SC-FDMA, 100% RB, 20 MHz, 16-QAM)	LTE-FDD	6.42	± 9.6 %
10102	CAE	LTE-FDD (SC-FDMA, 100% RB, 20 MHz, 64-QAM)	LTE-FDD	6.60	± 9.6 %
10103	CAG	LTE-TDD (SC-FDMA, 100% RB, 20 MHz, QPSK)	LTE-TDD	9.29	± 9.6 %
10104	CAG	LTE-TDD (SC-FDMA, 100% RB, 20 MHz, 16-QAM)	LTE-TDD	9.97	± 9.6 %
10105	CAG	LTE-TDD (SC-FDMA, 100% RB, 20 MHz, 64-QAM)	LTE-TDD	10.01	± 9.6 %
10108	CAG	LTE-FDD (SC-FDMA, 100% RB, 10 MHz, QPSK)	LTE-FDD	5.80	± 9.6 %

10109	CAG	LTE-FDD (SC-FDMA, 100% RB, 10 MHz, 16-QAM)	LTE-FDD	6.43	± 9.6 %
10110	CAG	LTE-FDD (SC-FDMA, 100% RB, 5 MHz, QPSK)	LTE-FDD	5.75	± 9.6 %
10111	CAG	LTE-FDD (SC-FDMA, 100% RB, 5 MHz, 16-QAM)	LTE-FDD	6.44	± 9.6 %
10112	CAG	LTE-FDD (SC-FDMA, 100% RB, 10 MHz, 64-QAM)	LTE-FDD	6.59	± 9.6 %
10113	CAG	LTE-FDD (SC-FDMA, 100% RB, 5 MHz, 64-QAM)	LTE-FDD	6.62	± 9.6 %
10114	CAC	IEEE 802.11n (HT Greenfield, 13.5 Mbps, BPSK)	WLAN	8.10	± 9.6 %
10115	CAC	IEEE 802.11n (HT Greenfield, 81 Mbps, 16-QAM)	WLAN	8.46	± 9.6 %
10116	CAC	IEEE 802.11n (HT Greenfield, 135 Mbps, 64-QAM)	WLAN	8.15	± 9.6 %
10117	CAC	IEEE 802.11n (HT Mixed, 13.5 Mbps, BPSK)	WLAN	8.07	± 9.6 %
10118	CAC	IEEE 802.11n (HT Mixed, 81 Mbps, 16-QAM)	WLAN	8.59	± 9.6 %
10119	CAC	IEEE 802.11n (HT Mixed, 135 Mbps, 64-QAM)	WLAN	8.13	± 9.6 %
10140	CAE	LTE-FDD (SC-FDMA, 100% RB, 15 MHz, 16-QAM)	LTE-FDD	6.49	± 9.6 %
10141	CAE	LTE-FDD (SC-FDMA, 100% RB, 15 MHz, 64-QAM)	LTE-FDD	6.53	± 9.6 %
10142	CAE	LTE-FDD (SC-FDMA, 100% RB, 3 MHz, QPSK)	LTE-FDD	5.73	± 9.6 %
10143	CAE	LTE-FDD (SC-FDMA, 100% RB, 3 MHz, 16-QAM)	LTE-FDD	6.35	± 9.6 %
10144	CAE	LTE-FDD (SC-FDMA, 100% RB, 3 MHz, 64-QAM)	LTE-FDD	6.65	± 9.6 %
10145	CAF	LTE-FDD (SC-FDMA, 100% RB, 1.4 MHz, QPSK)	LTE-FDD	5.76	± 9.6 %
10146	CAF	LTE-FDD (SC-FDMA, 100% RB, 1.4 MHz, 16-QAM)	LTE-FDD	6.41	± 9.6 %
10147	CAF	LTE-FDD (SC-FDMA, 100% RB, 1.4 MHz, 64-QAM)	LTE-FDD	6.72	± 9.6 %
10149	CAE	LTE-FDD (SC-FDMA, 50% RB, 20 MHz, 16-QAM)	LTE-FDD	6.42	± 9.6 %
10150	CAE	LTE-FDD (SC-FDMA, 50% RB, 20 MHz, 64-QAM)	LTE-FDD	6.60	± 9.6 %
10151	CAG	LTE-TDD (SC-FDMA, 50% RB, 20 MHz, QPSK)	LTE-TDD	9.28	± 9.6 %
10152	CAG	LTE-TDD (SC-FDMA, 50% RB, 20 MHz, 16-QAM)	LTE-TDD	9.92	± 9.6 %
10153	CAG	LTE-TDD (SC-FDMA, 50% RB, 20 MHz, 64-QAM)	LTE-TDD	10.05	± 9.6 %
10154	CAG	LTE-FDD (SC-FDMA, 50% RB, 10 MHz, QPSK)	LTE-FDD	5.75	± 9.6 %
10155	CAG	LTE-FDD (SC-FDMA, 50% RB, 10 MHz, 16-QAM)	LTE-FDD	6.43	± 9.6 %
10156	CAG	LTE-FDD (SC-FDMA, 50% RB, 5 MHz, QPSK)	LTE-FDD	5.79	± 9.6 %
10157	CAG	LTE-FDD (SC-FDMA, 50% RB, 5 MHz, 16-QAM)	LTE-FDD	6.49	± 9.6 %
10158	CAG	LTE-FDD (SC-FDMA, 50% RB, 10 MHz, 64-QAM)	LTE-FDD	6.62	± 9.6 %
10159	CAG	LTE-FDD (SC-FDMA, 50% RB, 5 MHz, 64-QAM)	LTE-FDD	6.56	± 9.6 %
10160	CAE	LTE-FDD (SC-FDMA, 50% RB, 15 MHz, QPSK)	LTE-FDD	5.82	± 9.6 %
10161	CAE	LTE-FDD (SC-FDMA, 50% RB, 15 MHz, 16-QAM)	LTE-FDD	6.43	± 9.6 %
10162	CAE	LTE-FDD (SC-FDMA, 50% RB, 15 MHz, 64-QAM)	LTE-FDD	6.58	± 9.6 %
10166	CAF	LTE-FDD (SC-FDMA, 50% RB, 1.4 MHz, QPSK)	LTE-FDD	5.46	± 9.6 %
10167	CAF	LTE-FDD (SC-FDMA, 50% RB, 1.4 MHz, 16-QAM)	LTE-FDD	6.21	± 9.6 %
10168	CAF	LTE-FDD (SC-FDMA, 50% RB, 1.4 MHz, 64-QAM)	LTE-FDD	6.79	± 9.6 %
10169	CAE	LTE-FDD (SC-FDMA, 1 RB, 20 MHz, QPSK)	LTE-FDD	5.73	± 9.6 %
10170	CAE	LTE-FDD (SC-FDMA, 1 RB, 20 MHz, 16-QAM)	LTE-FDD	6.52	± 9.6 %
10171	AAE	LTE-FDD (SC-FDMA, 1 RB, 20 MHz, 64-QAM)	LTE-FDD	6.49	± 9.6 %
10172	CAG	LTE-TDD (SC-FDMA, 1 RB, 20 MHz, QPSK)	LTE-TDD	9.21	± 9.6 %
10173	CAG	LTE-TDD (SC-FDMA, 1 RB, 20 MHz, 16-QAM)	LTE-TDD	9.48	± 9.6 %
10174	CAG	LTE-TDD (SC-FDMA, 1 RB, 20 MHz, 64-QAM)	LTE-TDD	10.25	± 9.6 %
10175	CAG	LTE-FDD (SC-FDMA, 1 RB, 10 MHz, QPSK)	LTE-FDD	5.72	± 9.6 %
10176	CAG	LTE-FDD (SC-FDMA, 1 RB, 10 MHz, 16-QAM)	LTE-FDD	6.52	± 9.6 %
10177	CAI	LTE-FDD (SC-FDMA, 1 RB, 5 MHz, QPSK)	LTE-FDD	5.73	± 9.6 %
10178	CAG	LTE-FDD (SC-FDMA, 1 RB, 5 MHz, 16-QAM)	LTE-FDD	6.52	± 9.6 %
10179	CAG	LTE-FDD (SC-FDMA, 1 RB, 10 MHz, 64-QAM)	LTE-FDD	6.50	± 9.6 %
10180	CAG	LTE-FDD (SC-FDMA, 1 RB, 5 MHz, 64-QAM)	LTE-FDD	6.50	± 9.6 %
10181	CAE	LTE-FDD (SC-FDMA, 1 RB, 15 MHz, QPSK)	LTE-FDD	5.72	± 9.6 %
10182	CAE	LTE-FDD (SC-FDMA, 1 RB, 15 MHz, 16-QAM)	LTE-FDD	6.52	± 9.6 %
10183	AAE	LTE-FDD (SC-FDMA, 1 RB, 15 MHz, 64-QAM)	LTE-FDD	6.50	± 9.6 %
10184	CAE	LTE-FDD (SC-FDMA, 1 RB, 3 MHz, QPSK)	LTE-FDD	5.73	± 9.6 %
10185	CAE	LTE-FDD (SC-FDMA, 1 RB, 3 MHz, 16-QAM)	LTE-FDD	6.51	± 9.6 %
10186	AAE	LTE-FDD (SC-FDMA, 1 RB, 3 MHz, 64-QAM)	LTE-FDD	6.50	± 9.6 %
10187	CAF	LTE-FDD (SC-FDMA, 1 RB, 1.4 MHz, QPSK)	LTE-FDD	5.73	± 9.6 %
10188	CAF	LTE-FDD (SC-FDMA, 1 RB, 1.4 MHz, 16-QAM)	LTE-FDD	6.52	± 9.6 %
10189	AAF	LTE-FDD (SC-FDMA, 1 RB, 1.4 MHz, 64-QAM)	LTE-FDD	6.50	± 9.6 %
10193	CAC	IEEE 802.11n (HT Greenfield, 6.5 Mbps, BPSK)	WLAN	8.09	± 9.6 %
10194	CAC	IEEE 802.11n (HT Greenfield, 39 Mbps, 16-QAM)	WLAN	8.12	± 9.6 %
10195	CAC	IEEE 802.11n (HT Greenfield, 65 Mbps, 64-QAM)	WLAN	8.21	± 9.6 %
10196	CAC	IEEE 802.11n (HT Mixed, 6.5 Mbps, BPSK)	WLAN	8.10	± 9.6 %
10197	CAC	IEEE 802.11n (HT Mixed, 39 Mbps, 16-QAM)	WLAN	8.13	± 9.6 %
10198	CAC	IEEE 802.11n (HT Mixed, 65 Mbps, 64-QAM)	WLAN	8.27	± 9.6 %
10219	CAC	IEEE 802.11n (HT Mixed, 7.2 Mbps, BPSK)	WLAN	8.03	± 9.6 %

10220	CAC	IEEE 802.11n (HT Mixed, 43.3 Mbps, 16-QAM)	WLAN	8.13	± 9.6 %
10221	CAC	IEEE 802.11n (HT Mixed, 72.2 Mbps, 64-QAM)	WLAN	8.27	± 9.6 %
10222	CAC	IEEE 802.11n (HT Mixed, 15 Mbps, BPSK)	WLAN	8.06	± 9.6 %
10223	CAC	IEEE 802.11n (HT Mixed, 90 Mbps, 16-QAM)	WLAN	8.48	± 9.6 %
10224	CAC	IEEE 802.11n (HT Mixed, 150 Mbps, 64-QAM)	WLAN	8.08	± 9.6 %
10225	CAB	UMTS-FDD (HSPA+)	WCDMA	5.97	± 9.6 %
10226	CAB	LTE-TDD (SC-FDMA, 1 RB, 1.4 MHz, 16-QAM)	LTE-TDD	9.49	± 9.6 %
10227	CAB	LTE-TDD (SC-FDMA, 1 RB, 1.4 MHz, 64-QAM)	LTE-TDD	10.26	± 9.6 %
10228	CAB	LTE-TDD (SC-FDMA, 1 RB, 1.4 MHz, QPSK)	LTE-TDD	9.22	± 9.6 %
10229	CAD	LTE-TDD (SC-FDMA, 1 RB, 3 MHz, 16-QAM)	LTE-TDD	9.48	± 9.6 %
10230	CAD	LTE-TDD (SC-FDMA, 1 RB, 3 MHz, 64-QAM)	LTE-TDD	10.25	± 9.6 %
10231	CAD	LTE-TDD (SC-FDMA, 1 RB, 3 MHz, QPSK)	LTE-TDD	9.19	± 9.6 %
10232	CAG	LTE-TDD (SC-FDMA, 1 RB, 5 MHz, 16-QAM)	LTE-TDD	9.48	± 9.6 %
10233	CAG	LTE-TDD (SC-FDMA, 1 RB, 5 MHz, 64-QAM)	LTE-TDD	10.25	± 9.6 %
10234	CAG	LTE-TDD (SC-FDMA, 1 RB, 5 MHz, QPSK)	LTE-TDD	9.21	± 9.6 %
10235	CAG	LTE-TDD (SC-FDMA, 1 RB, 10 MHz, 16-QAM)	LTE-TDD	9.48	± 9.6 %
10236	CAG	LTE-TDD (SC-FDMA, 1 RB, 10 MHz, 64-QAM)	LTE-TDD	10.25	± 9.6 %
10237	CAG	LTE-TDD (SC-FDMA, 1 RB, 10 MHz, QPSK)	LTE-TDD	9.21	± 9.6 %
10238	CAF	LTE-TDD (SC-FDMA, 1 RB, 15 MHz, 16-QAM)	LTE-TDD	9.48	± 9.6 %
10239	CAF	LTE-TDD (SC-FDMA, 1 RB, 15 MHz, 64-QAM)	LTE-TDD	10.25	± 9.6 %
10240	CAF	LTE-TDD (SC-FDMA, 1 RB, 15 MHz, QPSK)	LTE-TDD	9.21	± 9.6 %
10241	CAB	LTE-TDD (SC-FDMA, 50% RB, 1.4 MHz, 16-QAM)	LTE-TDD	9.82	± 9.6 %
10242	CAB	LTE-TDD (SC-FDMA, 50% RB, 1.4 MHz, 64-QAM)	LTE-TDD	9.86	± 9.6 %
10243	CAB	LTE-TDD (SC-FDMA, 50% RB, 1.4 MHz, QPSK)	LTE-TDD	9.46	± 9.6 %
10244	CAD	LTE-TDD (SC-FDMA, 50% RB, 3 MHz, 16-QAM)	LTE-TDD	10.06	± 9.6 %
10245	CAD	LTE-TDD (SC-FDMA, 50% RB, 3 MHz, 64-QAM)	LTE-TDD	10.06	± 9.6 %
10246	CAD	LTE-TDD (SC-FDMA, 50% RB, 3 MHz, QPSK)	LTE-TDD	9.30	± 9.6 %
10247	CAG	LTE-TDD (SC-FDMA, 50% RB, 5 MHz, 16-QAM)	LTE-TDD	9.91	± 9.6 %
10248	CAG	LTE-TDD (SC-FDMA, 50% RB, 5 MHz, 64-QAM)	LTE-TDD	10.09	± 9.6 %
10249	CAG	LTE-TDD (SC-FDMA, 50% RB, 5 MHz, QPSK)	LTE-TDD	9.29	± 9.6 %
10250	CAG	LTE-TDD (SC-FDMA, 50% RB, 10 MHz, 16-QAM)	LTE-TDD	9.81	± 9.6 %
10251	CAG	LTE-TDD (SC-FDMA, 50% RB, 10 MHz, 64-QAM)	LTE-TDD	10.17	± 9.6 %
10252	CAG	LTE-TDD (SC-FDMA, 50% RB, 10 MHz, QPSK)	LTE-TDD	9.24	± 9.6 %
10253	CAF	LTE-TDD (SC-FDMA, 50% RB, 15 MHz, 16-QAM)	LTE-TDD	9.90	± 9.6 %
10254	CAF	LTE-TDD (SC-FDMA, 50% RB, 15 MHz, 64-QAM)	LTE-TDD	10.14	± 9.6 %
10255	CAF	LTE-TDD (SC-FDMA, 50% RB, 15 MHz, QPSK)	LTE-TDD	9.20	± 9.6 %
10256	CAB	LTE-TDD (SC-FDMA, 100% RB, 1.4 MHz, 16-QAM)	LTE-TDD	9.96	± 9.6 %
10257	CAB	LTE-TDD (SC-FDMA, 100% RB, 1.4 MHz, 64-QAM)	LTE-TDD	10.08	± 9.6 %
10258	CAB	LTE-TDD (SC-FDMA, 100% RB, 1.4 MHz, QPSK)	LTE-TDD	9.34	± 9.6 %
10259	CAD	LTE-TDD (SC-FDMA, 100% RB, 3 MHz, 16-QAM)	LTE-TDD	9.98	± 9.6 %
10260	CAD	LTE-TDD (SC-FDMA, 100% RB, 3 MHz, 64-QAM)	LTE-TDD	9.97	± 9.6 %
10261	CAD	LTE-TDD (SC-FDMA, 100% RB, 3 MHz, QPSK)	LTE-TDD	9.24	± 9.6 %
10262	CAG	LTE-TDD (SC-FDMA, 100% RB, 5 MHz, 16-QAM)	LTE-TDD	9.83	± 9.6 %
10263	CAG	LTE-TDD (SC-FDMA, 100% RB, 5 MHz, 64-QAM)	LTE-TDD	10.16	± 9.6 %
10264	CAG	LTE-TDD (SC-FDMA, 100% RB, 5 MHz, QPSK)	LTE-TDD	9.23	± 9.6 %
10265	CAG	LTE-TDD (SC-FDMA, 100% RB, 10 MHz, 16-QAM)	LTE-TDD	9.92	± 9.6 %
10266	CAG	LTE-TDD (SC-FDMA, 100% RB, 10 MHz, 64-QAM)	LTE-TDD	10.07	± 9.6 %
10267	CAG	LTE-TDD (SC-FDMA, 100% RB, 10 MHz, QPSK)	LTE-TDD	9.30	± 9.6 %
10268	CAF	LTE-TDD (SC-FDMA, 100% RB, 15 MHz, 16-QAM)	LTE-TDD	10.06	± 9.6 %
10269	CAF	LTE-TDD (SC-FDMA, 100% RB, 15 MHz, 64-QAM)	LTE-TDD	10.13	± 9.6 %
10270	CAF	LTE-TDD (SC-FDMA, 100% RB, 15 MHz, QPSK)	LTE-TDD	9.58	± 9.6 %
10274	CAB	UMTS-FDD (HSUPA, Subtest 5, 3GPP Rel8.10)	WCDMA	4.87	± 9.6 %
10275	CAB	UMTS-FDD (HSUPA, Subtest 5, 3GPP Rel8.4)	WCDMA	3.96	± 9.6 %
10277	CAA	PHS (QPSK)	PHS	11.81	± 9.6 %
10278	CAA	PHS (QPSK, BW 884MHz, Rolloff 0.5)	PHS	11.81	± 9.6 %
10279	CAA	PHS (QPSK, BW 884MHz, Rolloff 0.38)	PHS	12.18	± 9.6 %
10290	AAB	CDMA2000, RC1, SO55, Full Rate	CDMA2000	3.91	± 9.6 %
10291	AAB	CDMA2000, RC3, SO55, Full Rate	CDMA2000	3.46	± 9.6 %
10292	AAB	CDMA2000, RC3, SO32, Full Rate	CDMA2000	3.39	± 9.6 %
10293	AAB	CDMA2000, RC3, SO3, Full Rate	CDMA2000	3.50	± 9.6 %
10295	AAB	CDMA2000, RC1, SO3, 1/8th Rate 25 fr.	CDMA2000	12.49	± 9.6 %
10297	AAD	LTE-FDD (SC-FDMA, 50% RB, 20 MHz, QPSK)	LTE-FDD	5.81	± 9.6 %
10298	AAD	LTE-FDD (SC-FDMA, 50% RB, 3 MHz, QPSK)	LTE-FDD	5.72	± 9.6 %
10299	AAD	LTE-FDD (SC-FDMA, 50% RB, 3 MHz, 16-QAM)	LTE-FDD	6.39	± 9.6 %

10300	AAD	LTE-FDD (SC-FDMA, 50% RB, 3 MHz, 64-QAM)	LTE-FDD	6.60	± 9.6 %
10301	AAA	IEEE 802.16e WiMAX (29:18, 5ms, 10MHz, QPSK, PUSC)	WiMAX	12.03	± 9.6 %
10302	AAA	IEEE 802.16e WiMAX (29:18, 5ms, 10MHz, QPSK, PUSC, 3 CTRL symbols)	WiMAX	12.57	± 9.6 %
10303	AAA	IEEE 802.16e WiMAX (31:15, 5ms, 10MHz, 64QAM, PUSC)	WiMAX	12.52	± 9.6 %
10304	AAA	IEEE 802.16e WiMAX (29:18, 5ms, 10MHz, 64QAM, PUSC)	WiMAX	11.86	± 9.6 %
10305	AAA	IEEE 802.16e WiMAX (31:15, 10ms, 10MHz, 64QAM, PUSC, 15 symbols)	WiMAX	15.24	± 9.6 %
10306	AAA	IEEE 802.16e WiMAX (29:18, 10ms, 10MHz, 64QAM, PUSC, 18 symbols)	WiMAX	14.67	± 9.6 %
10307	AAA	IEEE 802.16e WiMAX (29:18, 10ms, 10MHz, QPSK, PUSC, 18 symbols)	WiMAX	14.49	± 9.6 %
10308	AAA	IEEE 802.16e WiMAX (29:18, 10ms, 10MHz, 16QAM, PUSC)	WiMAX	14.46	± 9.6 %
10309	AAA	IEEE 802.16e WiMAX (29:18, 10ms, 10MHz, 16QAM, AMC 2x3, 18 symbols)	WiMAX	14.58	± 9.6 %
10310	AAA	IEEE 802.16e WiMAX (29:18, 10ms, 10MHz, QPSK, AMC 2x3, 18 symbols)	WiMAX	14.57	± 9.6 %
10311	AAD	LTE-FDD (SC-FDMA, 100% RB, 15 MHz, QPSK)	LTE-FDD	6.06	± 9.6 %
10313	AAA	IDEN 1:3	IDEN	10.51	± 9.6 %
10314	AAA	IDEN 1:6	IDEN	13.48	± 9.6 %
10315	AAB	IEEE 802.11b WiFi 2.4 GHz (DSSS, 1 Mbps, 96pc duty cycle)	WLAN	1.71	± 9.6 %
10316	AAB	IEEE 802.11g WiFi 2.4 GHz (ERP-OFDM, 6 Mbps, 96pc duty cycle)	WLAN	8.36	± 9.6 %
10317	AAC	IEEE 802.11a WiFi 5 GHz (OFDM, 6 Mbps, 96pc duty cycle)	WLAN	8.36	± 9.6 %
10352	AAA	Pulse Waveform (200Hz, 10%)	Generic	10.00	± 9.6 %
10353	AAA	Pulse Waveform (200Hz, 20%)	Generic	6.99	± 9.6 %
10354	AAA	Pulse Waveform (200Hz, 40%)	Generic	3.98	± 9.6 %
10355	AAA	Pulse Waveform (200Hz, 60%)	Generic	2.22	± 9.6 %
10356	AAA	Pulse Waveform (200Hz, 80%)	Generic	0.97	± 9.6 %
10387	AAA	QPSK Waveform, 1 MHz	Generic	5.10	± 9.6 %
10388	AAA	QPSK Waveform, 10 MHz	Generic	5.22	± 9.6 %
10396	AAA	64-QAM Waveform, 100 kHz	Generic	6.27	± 9.6 %
10399	AAA	64-QAM Waveform, 40 MHz	Generic	6.27	± 9.6 %
10400	AAD	IEEE 802.11ac WiFi (20MHz, 64-QAM, 99pc duty cycle)	WLAN	8.37	± 9.6 %
10401	AAD	IEEE 802.11ac WiFi (40MHz, 64-QAM, 99pc duty cycle)	WLAN	8.60	± 9.6 %
10402	AAD	IEEE 802.11ac WiFi (80MHz, 64-QAM, 99pc duty cycle)	WLAN	8.53	± 9.6 %
10403	AAB	CDMA2000 (1xEV-DO, Rev. 0)	CDMA2000	3.76	± 9.6 %
10404	AAB	CDMA2000 (1xEV-DO, Rev. A)	CDMA2000	3.77	± 9.6 %
10406	AAB	CDMA2000, RC3, SO32, SCH0, Full Rate	CDMA2000	5.22	± 9.6 %
10410	AAG	LTE-TDD (SC-FDMA, 1 RB, 10 MHz, QPSK, UL Subframe=2,3,4,7,8,9, Subframe Conf=4)	LTE-TDD	7.82	± 9.6 %
10414	AAA	WLAN CCDF, 64-QAM, 40MHz	Generic	8.54	± 9.6 %
10415	AAA	IEEE 802.11b WiFi 2.4 GHz (DSSS, 1 Mbps, 99pc duty cycle)	WLAN	1.54	± 9.6 %
10416	AAA	IEEE 802.11g WiFi 2.4 GHz (ERP-OFDM, 6 Mbps, 99pc duty cycle)	WLAN	8.23	± 9.6 %
10417	AAB	IEEE 802.11a/h WiFi 5 GHz (OFDM, 6 Mbps, 99pc duty cycle)	WLAN	8.23	± 9.6 %
10418	AAA	IEEE 802.11g WiFi 2.4 GHz (DSSS-OFDM, 6 Mbps, 99pc duty cycle, Long preamble)	WLAN	8.14	± 9.6 %
10419	AAA	IEEE 802.11g WiFi 2.4 GHz (DSSS-OFDM, 6 Mbps, 99pc duty cycle, Short preamble)	WLAN	8.19	± 9.6 %
10422	AAB	IEEE 802.11n (HT Greenfield, 7.2 Mbps, BPSK)	WLAN	8.32	± 9.6 %
10423	AAB	IEEE 802.11n (HT Greenfield, 43.3 Mbps, 16-QAM)	WLAN	8.47	± 9.6 %
10424	AAB	IEEE 802.11n (HT Greenfield, 72.2 Mbps, 64-QAM)	WLAN	8.40	± 9.6 %
10425	AAB	IEEE 802.11n (HT Greenfield, 15 Mbps, BPSK)	WLAN	8.41	± 9.6 %
10426	AAB	IEEE 802.11n (HT Greenfield, 90 Mbps, 16-QAM)	WLAN	8.45	± 9.6 %
10427	AAB	IEEE 802.11n (HT Greenfield, 150 Mbps, 64-QAM)	WLAN	8.41	± 9.6 %
10430	AAD	LTE-FDD (OFDMA, 5 MHz, E-TM 3.1)	LTE-FDD	8.28	± 9.6 %
10431	AAD	LTE-FDD (OFDMA, 10 MHz, E-TM 3.1)	LTE-FDD	8.38	± 9.6 %
10432	AAC	LTE-FDD (OFDMA, 15 MHz, E-TM 3.1)	LTE-FDD	8.34	± 9.6 %
10433	AAC	LTE-FDD (OFDMA, 20 MHz, E-TM 3.1)	LTE-FDD	8.34	± 9.6 %
10434	AAA	W-CDMA (BS Test Model 1, 64 DPCH)	WCDMA	8.60	± 9.6 %
10435	AAF	LTE-TDD (SC-FDMA, 1 RB, 20 MHz, QPSK, UL Subframe=2,3,4,7,8,9)	LTE-TDD	7.82	± 9.6 %
10447	AAD	LTE-FDD (OFDMA, 5 MHz, E-TM 3.1, Clipping 44%)	LTE-FDD	7.56	± 9.6 %
10448	AAD	LTE-FDD (OFDMA, 10 MHz, E-TM 3.1, Clipping 44%)	LTE-FDD	7.53	± 9.6 %
10449	AAC	LTE-FDD (OFDMA, 15 MHz, E-TM 3.1, Clipping 44%)	LTE-FDD	7.51	± 9.6 %
10450	AAC	LTE-FDD (OFDMA, 20 MHz, E-TM 3.1, Clipping 44%)	LTE-FDD	7.48	± 9.6 %

10451	AAA	W-CDMA (BS Test Model 1, 64 DPCH, Clipping 44%)	WCDMA	7.59	± 9.6 %
10456	AAB	IEEE 802.11ac WiFi (160MHz, 64-QAM, 99pc duty cycle)	WLAN	8.63	± 9.6 %
10457	AAA	UMTS-FDD (DC-HSDPA)	WCDMA	6.62	± 9.6 %
10458	AAA	CDMA2000 (1xEV-DO, Rev. B, 2 carriers)	CDMA2000	6.55	± 9.6 %
10459	AAA	CDMA2000 (1xEV-DO, Rev. B, 3 carriers)	CDMA2000	8.25	± 9.6 %
10460	AAA	UMTS-FDD (WCDMA, AMR)	WCDMA	2.39	± 9.6 %
10461	AAB	LTE-TDD (SC-FDMA, 1 RB, 1.4 MHz, QPSK, UL Subframe=2,3,4,7,8,9)	LTE-TDD	7.82	± 9.6 %
10462	AAB	LTE-TDD (SC-FDMA, 1 RB, 1.4 MHz, 16-QAM, UL Subframe=2,3,4,7,8,9)	LTE-TDD	8.30	± 9.6 %
10463	AAB	LTE-TDD (SC-FDMA, 1 RB, 1.4 MHz, 64-QAM, UL Subframe=2,3,4,7,8,9)	LTE-TDD	8.56	± 9.6 %
10464	AAC	LTE-TDD (SC-FDMA, 1 RB, 3 MHz, QPSK, UL Subframe=2,3,4,7,8,9)	LTE-TDD	7.82	± 9.6 %
10465	AAC	LTE-TDD (SC-FDMA, 1 RB, 3 MHz, 16-QAM, UL Subframe=2,3,4,7,8,9)	LTE-TDD	8.32	± 9.6 %
10466	AAC	LTE-TDD (SC-FDMA, 1 RB, 3 MHz, 64-QAM, UL Subframe=2,3,4,7,8,9)	LTE-TDD	8.57	± 9.6 %
10467	AAF	LTE-TDD (SC-FDMA, 1 RB, 5 MHz, QPSK, UL Subframe=2,3,4,7,8,9)	LTE-TDD	7.82	± 9.6 %
10468	AAF	LTE-TDD (SC-FDMA, 1 RB, 5 MHz, 16-QAM, UL Subframe=2,3,4,7,8,9)	LTE-TDD	8.32	± 9.6 %
10469	AAF	LTE-TDD (SC-FDMA, 1 RB, 5 MHz, 64-QAM, UL Subframe=2,3,4,7,8,9)	LTE-TDD	8.56	± 9.6 %
10470	AAF	LTE-TDD (SC-FDMA, 1 RB, 10 MHz, QPSK, UL Subframe=2,3,4,7,8,9)	LTE-TDD	7.82	± 9.6 %
10471	AAF	LTE-TDD (SC-FDMA, 1 RB, 10 MHz, 16-QAM, UL Subframe=2,3,4,7,8,9)	LTE-TDD	8.32	± 9.6 %
10472	AAF	LTE-TDD (SC-FDMA, 1 RB, 10 MHz, 64-QAM, UL Subframe=2,3,4,7,8,9)	LTE-TDD	8.57	± 9.6 %
10473	AAE	LTE-TDD (SC-FDMA, 1 RB, 15 MHz, QPSK, UL Subframe=2,3,4,7,8,9)	LTE-TDD	7.82	± 9.6 %
10474	AAE	LTE-TDD (SC-FDMA, 1 RB, 15 MHz, 16-QAM, UL Subframe=2,3,4,7,8,9)	LTE-TDD	8.32	± 9.6 %
10475	AAE	LTE-TDD (SC-FDMA, 1 RB, 15 MHz, 64-QAM, UL Subframe=2,3,4,7,8,9)	LTE-TDD	8.57	± 9.6 %
10477	AAF	LTE-TDD (SC-FDMA, 1 RB, 20 MHz, 16-QAM, UL Subframe=2,3,4,7,8,9)	LTE-TDD	8.32	± 9.6 %
10478	AAF	LTE-TDD (SC-FDMA, 1 RB, 20 MHz, 64-QAM, UL Subframe=2,3,4,7,8,9)	LTE-TDD	8.57	± 9.6 %
10479	AAB	LTE-TDD (SC-FDMA, 50% RB, 1.4 MHz, QPSK, UL Subframe=2,3,4,7,8,9)	LTE-TDD	7.74	± 9.6 %
10480	AAB	LTE-TDD (SC-FDMA, 50% RB, 1.4 MHz, 16-QAM, UL Subframe=2,3,4,7,8,9)	LTE-TDD	8.18	± 9.6 %
10481	AAB	LTE-TDD (SC-FDMA, 50% RB, 1.4 MHz, 64-QAM, UL Subframe=2,3,4,7,8,9)	LTE-TDD	8.45	± 9.6 %
10482	AAC	LTE-TDD (SC-FDMA, 50% RB, 3 MHz, QPSK, UL Subframe=2,3,4,7,8,9)	LTE-TDD	7.71	± 9.6 %
10483	AAC	LTE-TDD (SC-FDMA, 50% RB, 3 MHz, 16-QAM, UL Subframe=2,3,4,7,8,9)	LTE-TDD	8.39	± 9.6 %
10484	AAC	LTE-TDD (SC-FDMA, 50% RB, 3 MHz, 64-QAM, UL Subframe=2,3,4,7,8,9)	LTE-TDD	8.47	± 9.6 %
10485	AAF	LTE-TDD (SC-FDMA, 50% RB, 5 MHz, QPSK, UL Subframe=2,3,4,7,8,9)	LTE-TDD	7.59	± 9.6 %
10486	AAF	LTE-TDD (SC-FDMA, 50% RB, 5 MHz, 16-QAM, UL Subframe=2,3,4,7,8,9)	LTE-TDD	8.38	± 9.6 %
10487	AAF	LTE-TDD (SC-FDMA, 50% RB, 5 MHz, 64-QAM, UL Subframe=2,3,4,7,8,9)	LTE-TDD	8.60	± 9.6 %
10488	AAF	LTE-TDD (SC-FDMA, 50% RB, 10 MHz, QPSK, UL Subframe=2,3,4,7,8,9)	LTE-TDD	7.70	± 9.6 %
10489	AAF	LTE-TDD (SC-FDMA, 50% RB, 10 MHz, 16-QAM, UL Subframe=2,3,4,7,8,9)	LTE-TDD	8.31	± 9.6 %
10490	AAF	LTE-TDD (SC-FDMA, 50% RB, 10 MHz, 64-QAM, UL Subframe=2,3,4,7,8,9)	LTE-TDD	8.54	± 9.6 %
10491	AAE	LTE-TDD (SC-FDMA, 50% RB, 15 MHz, QPSK, UL Subframe=2,3,4,7,8,9)	LTE-TDD	7.74	± 9.6 %

10492	AAE	LTE-TDD (SC-FDMA, 50% RB, 15 MHz, 16-QAM, UL Subframe=2,3,4,7,8,9)	LTE-TDD	8.41	± 9.6 %
10493	AAE	LTE-TDD (SC-FDMA, 50% RB, 15 MHz, 64-QAM, UL Subframe=2,3,4,7,8,9)	LTE-TDD	8.55	± 9.6 %
10494	AAF	LTE-TDD (SC-FDMA, 50% RB, 20 MHz, QPSK, UL Subframe=2,3,4,7,8,9)	LTE-TDD	7.74	± 9.6 %
10495	AAF	LTE-TDD (SC-FDMA, 50% RB, 20 MHz, 16-QAM, UL Subframe=2,3,4,7,8,9)	LTE-TDD	8.37	± 9.6 %
10496	AAF	LTE-TDD (SC-FDMA, 50% RB, 20 MHz, 64-QAM, UL Subframe=2,3,4,7,8,9)	LTE-TDD	8.54	± 9.6 %
10497	AAB	LTE-TDD (SC-FDMA, 100% RB, 1.4 MHz, QPSK, UL Subframe=2,3,4,7,8,9)	LTE-TDD	7.67	± 9.6 %
10498	AAB	LTE-TDD (SC-FDMA, 100% RB, 1.4 MHz, 16-QAM, UL Subframe=2,3,4,7,8,9)	LTE-TDD	8.40	± 9.6 %
10499	AAB	LTE-TDD (SC-FDMA, 100% RB, 1.4 MHz, 64-QAM, UL Subframe=2,3,4,7,8,9)	LTE-TDD	8.68	± 9.6 %
10500	AAC	LTE-TDD (SC-FDMA, 100% RB, 3 MHz, QPSK, UL Subframe=2,3,4,7,8,9)	LTE-TDD	7.67	± 9.6 %
10501	AAC	LTE-TDD (SC-FDMA, 100% RB, 3 MHz, 16-QAM, UL Subframe=2,3,4,7,8,9)	LTE-TDD	8.44	± 9.6 %
10502	AAC	LTE-TDD (SC-FDMA, 100% RB, 3 MHz, 64-QAM, UL Subframe=2,3,4,7,8,9)	LTE-TDD	8.52	± 9.6 %
10503	AAF	LTE-TDD (SC-FDMA, 100% RB, 5 MHz, QPSK, UL Subframe=2,3,4,7,8,9)	LTE-TDD	7.72	± 9.6 %
10504	AAF	LTE-TDD (SC-FDMA, 100% RB, 5 MHz, 16-QAM, UL Subframe=2,3,4,7,8,9)	LTE-TDD	8.31	± 9.6 %
10505	AAF	LTE-TDD (SC-FDMA, 100% RB, 5 MHz, 64-QAM, UL Subframe=2,3,4,7,8,9)	LTE-TDD	8.54	± 9.6 %
10506	AAF	LTE-TDD (SC-FDMA, 100% RB, 10 MHz, QPSK, UL Subframe=2,3,4,7,8,9)	LTE-TDD	7.74	± 9.6 %
10507	AAF	LTE-TDD (SC-FDMA, 100% RB, 10 MHz, 16-QAM, UL Subframe=2,3,4,7,8,9)	LTE-TDD	8.36	± 9.6 %
10508	AAF	LTE-TDD (SC-FDMA, 100% RB, 10 MHz, 64-QAM, UL Subframe=2,3,4,7,8,9)	LTE-TDD	8.55	± 9.6 %
10509	AAE	LTE-TDD (SC-FDMA, 100% RB, 15 MHz, QPSK, UL Subframe=2,3,4,7,8,9)	LTE-TDD	7.99	± 9.6 %
10510	AAE	LTE-TDD (SC-FDMA, 100% RB, 15 MHz, 16-QAM, UL Subframe=2,3,4,7,8,9)	LTE-TDD	8.49	± 9.6 %
10511	AAE	LTE-TDD (SC-FDMA, 100% RB, 15 MHz, 64-QAM, UL Subframe=2,3,4,7,8,9)	LTE-TDD	8.51	± 9.6 %
10512	AAF	LTE-TDD (SC-FDMA, 100% RB, 20 MHz, QPSK, UL Subframe=2,3,4,7,8,9)	LTE-TDD	7.74	± 9.6 %
10513	AAF	LTE-TDD (SC-FDMA, 100% RB, 20 MHz, 16-QAM, UL Subframe=2,3,4,7,8,9)	LTE-TDD	8.42	± 9.6 %
10514	AAF	LTE-TDD (SC-FDMA, 100% RB, 20 MHz, 64-QAM, UL Subframe=2,3,4,7,8,9)	LTE-TDD	8.45	± 9.6 %
10515	AAA	IEEE 802.11b WiFi 2.4 GHz (DSSS, 2 Mbps, 99pc duty cycle)	WLAN	1.58	± 9.6 %
10516	AAA	IEEE 802.11b WiFi 2.4 GHz (DSSS, 5.5 Mbps, 99pc duty cycle)	WLAN	1.57	± 9.6 %
10517	AAA	IEEE 802.11b WiFi 2.4 GHz (DSSS, 11 Mbps, 99pc duty cycle)	WLAN	1.58	± 9.6 %
10518	AAB	IEEE 802.11a/h WiFi 5 GHz (OFDM, 9 Mbps, 99pc duty cycle)	WLAN	8.23	± 9.6 %
10519	AAB	IEEE 802.11a/h WiFi 5 GHz (OFDM, 12 Mbps, 99pc duty cycle)	WLAN	8.39	± 9.6 %
10520	AAB	IEEE 802.11a/h WiFi 5 GHz (OFDM, 18 Mbps, 99pc duty cycle)	WLAN	8.12	± 9.6 %
10521	AAB	IEEE 802.11a/h WiFi 5 GHz (OFDM, 24 Mbps, 99pc duty cycle)	WLAN	7.97	± 9.6 %
10522	AAB	IEEE 802.11a/h WiFi 5 GHz (OFDM, 36 Mbps, 99pc duty cycle)	WLAN	8.45	± 9.6 %
10523	AAB	IEEE 802.11a/h WiFi 5 GHz (OFDM, 48 Mbps, 99pc duty cycle)	WLAN	8.08	± 9.6 %
10524	AAB	IEEE 802.11a/h WiFi 5 GHz (OFDM, 54 Mbps, 99pc duty cycle)	WLAN	8.27	± 9.6 %
10525	AAB	IEEE 802.11ac WiFi (20MHz, MCS0, 99pc duty cycle)	WLAN	8.36	± 9.6 %
10526	AAB	IEEE 802.11ac WiFi (20MHz, MCS1, 99pc duty cycle)	WLAN	8.42	± 9.6 %
10527	AAB	IEEE 802.11ac WiFi (20MHz, MCS2, 99pc duty cycle)	WLAN	8.21	± 9.6 %
10528	AAB	IEEE 802.11ac WiFi (20MHz, MCS3, 99pc duty cycle)	WLAN	8.36	± 9.6 %
10529	AAB	IEEE 802.11ac WiFi (20MHz, MCS4, 99pc duty cycle)	WLAN	8.36	± 9.6 %
10531	AAB	IEEE 802.11ac WiFi (20MHz, MCS6, 99pc duty cycle)	WLAN	8.43	± 9.6 %
10532	AAB	IEEE 802.11ac WiFi (20MHz, MCS7, 99pc duty cycle)	WLAN	8.29	± 9.6 %
10533	AAB	IEEE 802.11ac WiFi (20MHz, MCS8, 99pc duty cycle)	WLAN	8.38	± 9.6 %
10534	AAB	IEEE 802.11ac WiFi (40MHz, MCS0, 99pc duty cycle)	WLAN	8.45	± 9.6 %

10535	AAB	IEEE 802.11ac WiFi (40MHz, MCS1, 99pc duty cycle)	WLAN	8.45	± 9.6 %
10536	AAB	IEEE 802.11ac WiFi (40MHz, MCS2, 99pc duty cycle)	WLAN	8.32	± 9.6 %
10537	AAB	IEEE 802.11ac WiFi (40MHz, MCS3, 99pc duty cycle)	WLAN	8.44	± 9.6 %
10538	AAB	IEEE 802.11ac WiFi (40MHz, MCS4, 99pc duty cycle)	WLAN	8.54	± 9.6 %
10540	AAB	IEEE 802.11ac WiFi (40MHz, MCS6, 99pc duty cycle)	WLAN	8.39	± 9.6 %
10541	AAB	IEEE 802.11ac WiFi (40MHz, MCS7, 99pc duty cycle)	WLAN	8.46	± 9.6 %
10542	AAB	IEEE 802.11ac WiFi (40MHz, MCS8, 99pc duty cycle)	WLAN	8.65	± 9.6 %
10543	AAB	IEEE 802.11ac WiFi (40MHz, MCS9, 99pc duty cycle)	WLAN	8.65	± 9.6 %
10544	AAB	IEEE 802.11ac WiFi (80MHz, MCS0, 99pc duty cycle)	WLAN	8.47	± 9.6 %
10545	AAB	IEEE 802.11ac WiFi (80MHz, MCS1, 99pc duty cycle)	WLAN	8.55	± 9.6 %
10546	AAB	IEEE 802.11ac WiFi (80MHz, MCS2, 99pc duty cycle)	WLAN	8.35	± 9.6 %
10547	AAB	IEEE 802.11ac WiFi (80MHz, MCS3, 99pc duty cycle)	WLAN	8.49	± 9.6 %
10548	AAB	IEEE 802.11ac WiFi (80MHz, MCS4, 99pc duty cycle)	WLAN	8.37	± 9.6 %
10550	AAB	IEEE 802.11ac WiFi (80MHz, MCS6, 99pc duty cycle)	WLAN	8.38	± 9.6 %
10551	AAB	IEEE 802.11ac WiFi (80MHz, MCS7, 99pc duty cycle)	WLAN	8.50	± 9.6 %
10552	AAB	IEEE 802.11ac WiFi (80MHz, MCS8, 99pc duty cycle)	WLAN	8.42	± 9.6 %
10553	AAB	IEEE 802.11ac WiFi (80MHz, MCS9, 99pc duty cycle)	WLAN	8.45	± 9.6 %
10554	AAC	IEEE 802.11ac WiFi (160MHz, MCS0, 99pc duty cycle)	WLAN	8.48	± 9.6 %
10555	AAC	IEEE 802.11ac WiFi (160MHz, MCS1, 99pc duty cycle)	WLAN	8.47	± 9.6 %
10556	AAC	IEEE 802.11ac WiFi (160MHz, MCS2, 99pc duty cycle)	WLAN	8.50	± 9.6 %
10557	AAC	IEEE 802.11ac WiFi (160MHz, MCS3, 99pc duty cycle)	WLAN	8.52	± 9.6 %
10558	AAC	IEEE 802.11ac WiFi (160MHz, MCS4, 99pc duty cycle)	WLAN	8.61	± 9.6 %
10560	AAC	IEEE 802.11ac WiFi (160MHz, MCS6, 99pc duty cycle)	WLAN	8.73	± 9.6 %
10561	AAC	IEEE 802.11ac WiFi (160MHz, MCS7, 99pc duty cycle)	WLAN	8.56	± 9.6 %
10562	AAC	IEEE 802.11ac WiFi (160MHz, MCS8, 99pc duty cycle)	WLAN	8.69	± 9.6 %
10563	AAC	IEEE 802.11ac WiFi (160MHz, MCS9, 99pc duty cycle)	WLAN	8.77	± 9.6 %
10564	AAA	IEEE 802.11g WiFi 2.4 GHz (DSSS-OFDM, 9 Mbps, 99pc duty cycle)	WLAN	8.25	± 9.6 %
10565	AAA	IEEE 802.11g WiFi 2.4 GHz (DSSS-OFDM, 12 Mbps, 99pc duty cycle)	WLAN	8.45	± 9.6 %
10566	AAA	IEEE 802.11g WiFi 2.4 GHz (DSSS-OFDM, 18 Mbps, 99pc duty cycle)	WLAN	8.13	± 9.6 %
10567	AAA	IEEE 802.11g WiFi 2.4 GHz (DSSS-OFDM, 24 Mbps, 99pc duty cycle)	WLAN	8.00	± 9.6 %
10568	AAA	IEEE 802.11g WiFi 2.4 GHz (DSSS-OFDM, 36 Mbps, 99pc duty cycle)	WLAN	8.37	± 9.6 %
10569	AAA	IEEE 802.11g WiFi 2.4 GHz (DSSS-OFDM, 48 Mbps, 99pc duty cycle)	WLAN	8.10	± 9.6 %
10570	AAA	IEEE 802.11g WiFi 2.4 GHz (DSSS-OFDM, 54 Mbps, 99pc duty cycle)	WLAN	8.30	± 9.6 %
10571	AAA	IEEE 802.11b WiFi 2.4 GHz (DSSS, 1 Mbps, 90pc duty cycle)	WLAN	1.99	± 9.6 %
10572	AAA	IEEE 802.11b WiFi 2.4 GHz (DSSS, 2 Mbps, 90pc duty cycle)	WLAN	1.99	± 9.6 %
10573	AAA	IEEE 802.11b WiFi 2.4 GHz (DSSS, 5.5 Mbps, 90pc duty cycle)	WLAN	1.98	± 9.6 %
10574	AAA	IEEE 802.11b WiFi 2.4 GHz (DSSS, 11 Mbps, 90pc duty cycle)	WLAN	1.98	± 9.6 %
10575	AAA	IEEE 802.11g WiFi 2.4 GHz (DSSS-OFDM, 6 Mbps, 90pc duty cycle)	WLAN	8.59	± 9.6 %
10576	AAA	IEEE 802.11g WiFi 2.4 GHz (DSSS-OFDM, 9 Mbps, 90pc duty cycle)	WLAN	8.60	± 9.6 %
10577	AAA	IEEE 802.11g WiFi 2.4 GHz (DSSS-OFDM, 12 Mbps, 90pc duty cycle)	WLAN	8.70	± 9.6 %
10578	AAA	IEEE 802.11g WiFi 2.4 GHz (DSSS-OFDM, 18 Mbps, 90pc duty cycle)	WLAN	8.49	± 9.6 %
10579	AAA	IEEE 802.11g WiFi 2.4 GHz (DSSS-OFDM, 24 Mbps, 90pc duty cycle)	WLAN	8.36	± 9.6 %
10580	AAA	IEEE 802.11g WiFi 2.4 GHz (DSSS-OFDM, 36 Mbps, 90pc duty cycle)	WLAN	8.76	± 9.6 %
10581	AAA	IEEE 802.11g WiFi 2.4 GHz (DSSS-OFDM, 48 Mbps, 90pc duty cycle)	WLAN	8.35	± 9.6 %
10582	AAA	IEEE 802.11g WiFi 2.4 GHz (DSSS-OFDM, 54 Mbps, 90pc duty cycle)	WLAN	8.67	± 9.6 %
10583	AAB	IEEE 802.11a/h WiFi 5 GHz (OFDM, 6 Mbps, 90pc duty cycle)	WLAN	8.59	± 9.6 %
10584	AAB	IEEE 802.11a/h WiFi 5 GHz (OFDM, 9 Mbps, 90pc duty cycle)	WLAN	8.60	± 9.6 %
10585	AAB	IEEE 802.11a/h WiFi 5 GHz (OFDM, 12 Mbps, 90pc duty cycle)	WLAN	8.70	± 9.6 %
10586	AAB	IEEE 802.11a/h WiFi 5 GHz (OFDM, 18 Mbps, 90pc duty cycle)	WLAN	8.49	± 9.6 %
10587	AAB	IEEE 802.11a/h WiFi 5 GHz (OFDM, 24 Mbps, 90pc duty cycle)	WLAN	8.36	± 9.6 %

10588	AAB	IEEE 802.11a/h WiFi 5 GHz (OFDM, 36 Mbps, 90pc duty cycle)	WLAN	8.76	± 9.6 %
10589	AAB	IEEE 802.11a/h WiFi 5 GHz (OFDM, 48 Mbps, 90pc duty cycle)	WLAN	8.35	± 9.6 %
10590	AAB	IEEE 802.11a/h WiFi 5 GHz (OFDM, 54 Mbps, 90pc duty cycle)	WLAN	8.67	± 9.6 %
10591	AAB	IEEE 802.11n (HT Mixed, 20MHz, MCS0, 90pc duty cycle)	WLAN	8.63	± 9.6 %
10592	AAB	IEEE 802.11n (HT Mixed, 20MHz, MCS1, 90pc duty cycle)	WLAN	8.79	± 9.6 %
10593	AAB	IEEE 802.11n (HT Mixed, 20MHz, MCS2, 90pc duty cycle)	WLAN	8.64	± 9.6 %
10594	AAB	IEEE 802.11n (HT Mixed, 20MHz, MCS3, 90pc duty cycle)	WLAN	8.74	± 9.6 %
10595	AAB	IEEE 802.11n (HT Mixed, 20MHz, MCS4, 90pc duty cycle)	WLAN	8.74	± 9.6 %
10596	AAB	IEEE 802.11n (HT Mixed, 20MHz, MCS5, 90pc duty cycle)	WLAN	8.71	± 9.6 %
10597	AAB	IEEE 802.11n (HT Mixed, 20MHz, MCS6, 90pc duty cycle)	WLAN	8.72	± 9.6 %
10598	AAB	IEEE 802.11n (HT Mixed, 20MHz, MCS7, 90pc duty cycle)	WLAN	8.50	± 9.6 %
10599	AAB	IEEE 802.11n (HT Mixed, 40MHz, MCS0, 90pc duty cycle)	WLAN	8.79	± 9.6 %
10600	AAB	IEEE 802.11n (HT Mixed, 40MHz, MCS1, 90pc duty cycle)	WLAN	8.88	± 9.6 %
10601	AAB	IEEE 802.11n (HT Mixed, 40MHz, MCS2, 90pc duty cycle)	WLAN	8.82	± 9.6 %
10602	AAB	IEEE 802.11n (HT Mixed, 40MHz, MCS3, 90pc duty cycle)	WLAN	8.94	± 9.6 %
10603	AAB	IEEE 802.11n (HT Mixed, 40MHz, MCS4, 90pc duty cycle)	WLAN	9.03	± 9.6 %
10604	AAB	IEEE 802.11n (HT Mixed, 40MHz, MCS5, 90pc duty cycle)	WLAN	8.76	± 9.6 %
10605	AAB	IEEE 802.11n (HT Mixed, 40MHz, MCS6, 90pc duty cycle)	WLAN	8.97	± 9.6 %
10606	AAB	IEEE 802.11n (HT Mixed, 40MHz, MCS7, 90pc duty cycle)	WLAN	8.82	± 9.6 %
10607	AAB	IEEE 802.11ac WiFi (20MHz, MCS0, 90pc duty cycle)	WLAN	8.64	± 9.6 %
10608	AAB	IEEE 802.11ac WiFi (20MHz, MCS1, 90pc duty cycle)	WLAN	8.77	± 9.6 %
10609	AAB	IEEE 802.11ac WiFi (20MHz, MCS2, 90pc duty cycle)	WLAN	8.57	± 9.6 %
10610	AAB	IEEE 802.11ac WiFi (20MHz, MCS3, 90pc duty cycle)	WLAN	8.78	± 9.6 %
10611	AAB	IEEE 802.11ac WiFi (20MHz, MCS4, 90pc duty cycle)	WLAN	8.70	± 9.6 %
10612	AAB	IEEE 802.11ac WiFi (20MHz, MCS5, 90pc duty cycle)	WLAN	8.77	± 9.6 %
10613	AAB	IEEE 802.11ac WiFi (20MHz, MCS6, 90pc duty cycle)	WLAN	8.94	± 9.6 %
10614	AAB	IEEE 802.11ac WiFi (20MHz, MCS7, 90pc duty cycle)	WLAN	8.59	± 9.6 %
10615	AAB	IEEE 802.11ac WiFi (20MHz, MCS8, 90pc duty cycle)	WLAN	8.82	± 9.6 %
10616	AAB	IEEE 802.11ac WiFi (40MHz, MCS0, 90pc duty cycle)	WLAN	8.82	± 9.6 %
10617	AAB	IEEE 802.11ac WiFi (40MHz, MCS1, 90pc duty cycle)	WLAN	8.81	± 9.6 %
10618	AAB	IEEE 802.11ac WiFi (40MHz, MCS2, 90pc duty cycle)	WLAN	8.58	± 9.6 %
10619	AAB	IEEE 802.11ac WiFi (40MHz, MCS3, 90pc duty cycle)	WLAN	8.86	± 9.6 %
10620	AAB	IEEE 802.11ac WiFi (40MHz, MCS4, 90pc duty cycle)	WLAN	8.87	± 9.6 %
10621	AAB	IEEE 802.11ac WiFi (40MHz, MCS5, 90pc duty cycle)	WLAN	8.77	± 9.6 %
10622	AAB	IEEE 802.11ac WiFi (40MHz, MCS6, 90pc duty cycle)	WLAN	8.68	± 9.6 %
10623	AAB	IEEE 802.11ac WiFi (40MHz, MCS7, 90pc duty cycle)	WLAN	8.82	± 9.6 %
10624	AAB	IEEE 802.11ac WiFi (40MHz, MCS8, 90pc duty cycle)	WLAN	8.96	± 9.6 %
10625	AAB	IEEE 802.11ac WiFi (40MHz, MCS9, 90pc duty cycle)	WLAN	8.96	± 9.6 %
10626	AAB	IEEE 802.11ac WiFi (80MHz, MCS0, 90pc duty cycle)	WLAN	8.83	± 9.6 %
10627	AAB	IEEE 802.11ac WiFi (80MHz, MCS1, 90pc duty cycle)	WLAN	8.88	± 9.6 %
10628	AAB	IEEE 802.11ac WiFi (80MHz, MCS2, 90pc duty cycle)	WLAN	8.71	± 9.6 %
10629	AAB	IEEE 802.11ac WiFi (80MHz, MCS3, 90pc duty cycle)	WLAN	8.85	± 9.6 %
10630	AAB	IEEE 802.11ac WiFi (80MHz, MCS4, 90pc duty cycle)	WLAN	8.72	± 9.6 %
10631	AAB	IEEE 802.11ac WiFi (80MHz, MCS5, 90pc duty cycle)	WLAN	8.81	± 9.6 %
10632	AAB	IEEE 802.11ac WiFi (80MHz, MCS6, 90pc duty cycle)	WLAN	8.74	± 9.6 %
10633	AAB	IEEE 802.11ac WiFi (80MHz, MCS7, 90pc duty cycle)	WLAN	8.83	± 9.6 %
10634	AAB	IEEE 802.11ac WiFi (80MHz, MCS8, 90pc duty cycle)	WLAN	8.80	± 9.6 %
10635	AAB	IEEE 802.11ac WiFi (80MHz, MCS9, 90pc duty cycle)	WLAN	8.81	± 9.6 %
10636	AAC	IEEE 802.11ac WiFi (160MHz, MCS0, 90pc duty cycle)	WLAN	8.83	± 9.6 %
10637	AAC	IEEE 802.11ac WiFi (160MHz, MCS1, 90pc duty cycle)	WLAN	8.79	± 9.6 %
10638	AAC	IEEE 802.11ac WiFi (160MHz, MCS2, 90pc duty cycle)	WLAN	8.86	± 9.6 %
10639	AAC	IEEE 802.11ac WiFi (160MHz, MCS3, 90pc duty cycle)	WLAN	8.85	± 9.6 %
10640	AAC	IEEE 802.11ac WiFi (160MHz, MCS4, 90pc duty cycle)	WLAN	8.98	± 9.6 %
10641	AAC	IEEE 802.11ac WiFi (160MHz, MCS5, 90pc duty cycle)	WLAN	9.06	± 9.6 %
10642	AAC	IEEE 802.11ac WiFi (160MHz, MCS6, 90pc duty cycle)	WLAN	9.06	± 9.6 %
10643	AAC	IEEE 802.11ac WiFi (160MHz, MCS7, 90pc duty cycle)	WLAN	8.89	± 9.6 %
10644	AAC	IEEE 802.11ac WiFi (160MHz, MCS8, 90pc duty cycle)	WLAN	9.05	± 9.6 %
10645	AAC	IEEE 802.11ac WiFi (160MHz, MCS9, 90pc duty cycle)	WLAN	9.11	± 9.6 %
10646	AAG	LTE-TDD (SC-FDMA, 1 RB, 5 MHz, QPSK, UL Subframe=2,7)	LTE-TDD	11.96	± 9.6 %
10647	AAF	LTE-TDD (SC-FDMA, 1 RB, 20 MHz, QPSK, UL Subframe=2,7)	LTE-TDD	11.96	± 9.6 %
10648	AAA	CDMA2000 (1x Advanced)	CDMA2000	3.45	± 9.6 %
10652	AAE	LTE-TDD (OFDMA, 5 MHz, E-TM 3.1, Clipping 44%)	LTE-TDD	6.91	± 9.6 %
10653	AAE	LTE-TDD (OFDMA, 10 MHz, E-TM 3.1, Clipping 44%)	LTE-TDD	7.42	± 9.6 %
10654	AAD	LTE-TDD (OFDMA, 15 MHz, E-TM 3.1, Clipping 44%)	LTE-TDD	6.96	± 9.6 %

10655	AAE	LTE-TDD (OFDMA, 20 MHz, E-TM 3.1, Clipping 44%)	LTE-TDD	7.21	± 9.6 %
10658	AAA	Pulse Waveform (200Hz, 10%)	Test	10.00	± 9.6 %
10659	AAA	Pulse Waveform (200Hz, 20%)	Test	6.99	± 9.6 %
10660	AAA	Pulse Waveform (200Hz, 40%)	Test	3.98	± 9.6 %
10661	AAA	Pulse Waveform (200Hz, 60%)	Test	2.22	± 9.6 %
10662	AAA	Pulse Waveform (200Hz, 80%)	Test	0.97	± 9.6 %
10670	AAA	Bluetooth Low Energy	Bluetooth	2.19	± 9.6 %
10671	AAA	IEEE 802.11ax (20MHz, MCS0, 90pc duty cycle)	WLAN	9.09	± 9.6 %
10672	AAA	IEEE 802.11ax (20MHz, MCS1, 90pc duty cycle)	WLAN	8.57	± 9.6 %
10673	AAA	IEEE 802.11ax (20MHz, MCS2, 90pc duty cycle)	WLAN	8.78	± 9.6 %
10674	AAA	IEEE 802.11ax (20MHz, MCS3, 90pc duty cycle)	WLAN	8.74	± 9.6 %
10675	AAA	IEEE 802.11ax (20MHz, MCS4, 90pc duty cycle)	WLAN	8.90	± 9.6 %
10676	AAA	IEEE 802.11ax (20MHz, MCS5, 90pc duty cycle)	WLAN	8.77	± 9.6 %
10677	AAA	IEEE 802.11ax (20MHz, MCS6, 90pc duty cycle)	WLAN	8.73	± 9.6 %
10678	AAA	IEEE 802.11ax (20MHz, MCS7, 90pc duty cycle)	WLAN	8.78	± 9.6 %
10679	AAA	IEEE 802.11ax (20MHz, MCS8, 90pc duty cycle)	WLAN	8.89	± 9.6 %
10680	AAA	IEEE 802.11ax (20MHz, MCS9, 90pc duty cycle)	WLAN	8.80	± 9.6 %
10681	AAA	IEEE 802.11ax (20MHz, MCS10, 90pc duty cycle)	WLAN	8.62	± 9.6 %
10682	AAA	IEEE 802.11ax (20MHz, MCS11, 90pc duty cycle)	WLAN	8.83	± 9.6 %
10683	AAA	IEEE 802.11ax (20MHz, MCS0, 99pc duty cycle)	WLAN	8.42	± 9.6 %
10684	AAA	IEEE 802.11ax (20MHz, MCS1, 99pc duty cycle)	WLAN	8.26	± 9.6 %
10685	AAA	IEEE 802.11ax (20MHz, MCS2, 99pc duty cycle)	WLAN	8.33	± 9.6 %
10686	AAA	IEEE 802.11ax (20MHz, MCS3, 99pc duty cycle)	WLAN	8.28	± 9.6 %
10687	AAA	IEEE 802.11ax (20MHz, MCS4, 99pc duty cycle)	WLAN	8.45	± 9.6 %
10688	AAA	IEEE 802.11ax (20MHz, MCS5, 99pc duty cycle)	WLAN	8.29	± 9.6 %
10689	AAA	IEEE 802.11ax (20MHz, MCS6, 99pc duty cycle)	WLAN	8.55	± 9.6 %
10690	AAA	IEEE 802.11ax (20MHz, MCS7, 99pc duty cycle)	WLAN	8.29	± 9.6 %
10691	AAA	IEEE 802.11ax (20MHz, MCS8, 99pc duty cycle)	WLAN	8.25	± 9.6 %
10692	AAA	IEEE 802.11ax (20MHz, MCS9, 99pc duty cycle)	WLAN	8.29	± 9.6 %
10693	AAA	IEEE 802.11ax (20MHz, MCS10, 99pc duty cycle)	WLAN	8.25	± 9.6 %
10694	AAA	IEEE 802.11ax (20MHz, MCS11, 99pc duty cycle)	WLAN	8.57	± 9.6 %
10695	AAA	IEEE 802.11ax (40MHz, MCS0, 90pc duty cycle)	WLAN	8.78	± 9.6 %
10696	AAA	IEEE 802.11ax (40MHz, MCS1, 90pc duty cycle)	WLAN	8.91	± 9.6 %
10697	AAA	IEEE 802.11ax (40MHz, MCS2, 90pc duty cycle)	WLAN	8.61	± 9.6 %
10698	AAA	IEEE 802.11ax (40MHz, MCS3, 90pc duty cycle)	WLAN	8.89	± 9.6 %
10699	AAA	IEEE 802.11ax (40MHz, MCS4, 90pc duty cycle)	WLAN	8.82	± 9.6 %
10700	AAA	IEEE 802.11ax (40MHz, MCS5, 90pc duty cycle)	WLAN	8.73	± 9.6 %
10701	AAA	IEEE 802.11ax (40MHz, MCS6, 90pc duty cycle)	WLAN	8.86	± 9.6 %
10702	AAA	IEEE 802.11ax (40MHz, MCS7, 90pc duty cycle)	WLAN	8.70	± 9.6 %
10703	AAA	IEEE 802.11ax (40MHz, MCS8, 90pc duty cycle)	WLAN	8.82	± 9.6 %
10704	AAA	IEEE 802.11ax (40MHz, MCS9, 90pc duty cycle)	WLAN	8.56	± 9.6 %
10705	AAA	IEEE 802.11ax (40MHz, MCS10, 90pc duty cycle)	WLAN	8.69	± 9.6 %
10706	AAA	IEEE 802.11ax (40MHz, MCS11, 90pc duty cycle)	WLAN	8.66	± 9.6 %
10707	AAA	IEEE 802.11ax (40MHz, MCS0, 99pc duty cycle)	WLAN	8.32	± 9.6 %
10708	AAA	IEEE 802.11ax (40MHz, MCS1, 99pc duty cycle)	WLAN	8.55	± 9.6 %
10709	AAA	IEEE 802.11ax (40MHz, MCS2, 99pc duty cycle)	WLAN	8.33	± 9.6 %
10710	AAA	IEEE 802.11ax (40MHz, MCS3, 99pc duty cycle)	WLAN	8.29	± 9.6 %
10711	AAA	IEEE 802.11ax (40MHz, MCS4, 99pc duty cycle)	WLAN	8.39	± 9.6 %
10712	AAA	IEEE 802.11ax (40MHz, MCS5, 99pc duty cycle)	WLAN	8.67	± 9.6 %
10713	AAA	IEEE 802.11ax (40MHz, MCS6, 99pc duty cycle)	WLAN	8.33	± 9.6 %
10714	AAA	IEEE 802.11ax (40MHz, MCS7, 99pc duty cycle)	WLAN	8.26	± 9.6 %
10715	AAA	IEEE 802.11ax (40MHz, MCS8, 99pc duty cycle)	WLAN	8.45	± 9.6 %
10716	AAA	IEEE 802.11ax (40MHz, MCS9, 99pc duty cycle)	WLAN	8.30	± 9.6 %
10717	AAA	IEEE 802.11ax (40MHz, MCS10, 99pc duty cycle)	WLAN	8.48	± 9.6 %
10718	AAA	IEEE 802.11ax (40MHz, MCS11, 99pc duty cycle)	WLAN	8.24	± 9.6 %
10719	AAA	IEEE 802.11ax (80MHz, MCS0, 90pc duty cycle)	WLAN	8.81	± 9.6 %
10720	AAA	IEEE 802.11ax (80MHz, MCS1, 90pc duty cycle)	WLAN	8.87	± 9.6 %
10721	AAA	IEEE 802.11ax (80MHz, MCS2, 90pc duty cycle)	WLAN	8.76	± 9.6 %
10722	AAA	IEEE 802.11ax (80MHz, MCS3, 90pc duty cycle)	WLAN	8.55	± 9.6 %
10723	AAA	IEEE 802.11ax (80MHz, MCS4, 90pc duty cycle)	WLAN	8.70	± 9.6 %
10724	AAA	IEEE 802.11ax (80MHz, MCS5, 90pc duty cycle)	WLAN	8.90	± 9.6 %
10725	AAA	IEEE 802.11ax (80MHz, MCS6, 90pc duty cycle)	WLAN	8.74	± 9.6 %
10726	AAA	IEEE 802.11ax (80MHz, MCS7, 90pc duty cycle)	WLAN	8.72	± 9.6 %
10727	AAA	IEEE 802.11ax (80MHz, MCS8, 90pc duty cycle)	WLAN	8.66	± 9.6 %

10728	AAA	IEEE 802.11ax (80MHz, MCS9, 90pc duty cycle)	WLAN	8.65	± 9.6 %
10729	AAA	IEEE 802.11ax (80MHz, MCS10, 90pc duty cycle)	WLAN	8.64	± 9.6 %
10730	AAA	IEEE 802.11ax (80MHz, MCS11, 90pc duty cycle)	WLAN	8.67	± 9.6 %
10731	AAA	IEEE 802.11ax (80MHz, MCS0, 99pc duty cycle)	WLAN	8.42	± 9.6 %
10732	AAA	IEEE 802.11ax (80MHz, MCS1, 99pc duty cycle)	WLAN	8.46	± 9.6 %
10733	AAA	IEEE 802.11ax (80MHz, MCS2, 99pc duty cycle)	WLAN	8.40	± 9.6 %
10734	AAA	IEEE 802.11ax (80MHz, MCS3, 99pc duty cycle)	WLAN	8.25	± 9.6 %
10735	AAA	IEEE 802.11ax (80MHz, MCS4, 99pc duty cycle)	WLAN	8.33	± 9.6 %
10736	AAA	IEEE 802.11ax (80MHz, MCS5, 99pc duty cycle)	WLAN	8.27	± 9.6 %
10737	AAA	IEEE 802.11ax (80MHz, MCS6, 99pc duty cycle)	WLAN	8.36	± 9.6 %
10738	AAA	IEEE 802.11ax (80MHz, MCS7, 99pc duty cycle)	WLAN	8.42	± 9.6 %
10739	AAA	IEEE 802.11ax (80MHz, MCS8, 99pc duty cycle)	WLAN	8.29	± 9.6 %
10740	AAA	IEEE 802.11ax (80MHz, MCS9, 99pc duty cycle)	WLAN	8.48	± 9.6 %
10741	AAA	IEEE 802.11ax (80MHz, MCS10, 99pc duty cycle)	WLAN	8.40	± 9.6 %
10742	AAA	IEEE 802.11ax (80MHz, MCS11, 99pc duty cycle)	WLAN	8.43	± 9.6 %
10743	AAA	IEEE 802.11ax (160MHz, MCS0, 90pc duty cycle)	WLAN	8.94	± 9.6 %
10744	AAA	IEEE 802.11ax (160MHz, MCS1, 90pc duty cycle)	WLAN	9.16	± 9.6 %
10745	AAA	IEEE 802.11ax (160MHz, MCS2, 90pc duty cycle)	WLAN	8.93	± 9.6 %
10746	AAA	IEEE 802.11ax (160MHz, MCS3, 90pc duty cycle)	WLAN	9.11	± 9.6 %
10747	AAA	IEEE 802.11ax (160MHz, MCS4, 90pc duty cycle)	WLAN	9.04	± 9.6 %
10748	AAA	IEEE 802.11ax (160MHz, MCS5, 90pc duty cycle)	WLAN	8.93	± 9.6 %
10749	AAA	IEEE 802.11ax (160MHz, MCS6, 90pc duty cycle)	WLAN	8.90	± 9.6 %
10750	AAA	IEEE 802.11ax (160MHz, MCS7, 90pc duty cycle)	WLAN	8.79	± 9.6 %
10751	AAA	IEEE 802.11ax (160MHz, MCS8, 90pc duty cycle)	WLAN	8.82	± 9.6 %
10752	AAA	IEEE 802.11ax (160MHz, MCS9, 90pc duty cycle)	WLAN	8.81	± 9.6 %
10753	AAA	IEEE 802.11ax (160MHz, MCS10, 90pc duty cycle)	WLAN	9.00	± 9.6 %
10754	AAA	IEEE 802.11ax (160MHz, MCS11, 90pc duty cycle)	WLAN	8.94	± 9.6 %
10755	AAA	IEEE 802.11ax (160MHz, MCS0, 99pc duty cycle)	WLAN	8.64	± 9.6 %
10756	AAA	IEEE 802.11ax (160MHz, MCS1, 99pc duty cycle)	WLAN	8.77	± 9.6 %
10757	AAA	IEEE 802.11ax (160MHz, MCS2, 99pc duty cycle)	WLAN	8.77	± 9.6 %
10758	AAA	IEEE 802.11ax (160MHz, MCS3, 99pc duty cycle)	WLAN	8.69	± 9.6 %
10759	AAA	IEEE 802.11ax (160MHz, MCS4, 99pc duty cycle)	WLAN	8.58	± 9.6 %
10760	AAA	IEEE 802.11ax (160MHz, MCS5, 99pc duty cycle)	WLAN	8.49	± 9.6 %
10761	AAA	IEEE 802.11ax (160MHz, MCS6, 99pc duty cycle)	WLAN	8.58	± 9.6 %
10762	AAA	IEEE 802.11ax (160MHz, MCS7, 99pc duty cycle)	WLAN	8.49	± 9.6 %
10763	AAA	IEEE 802.11ax (160MHz, MCS8, 99pc duty cycle)	WLAN	8.53	± 9.6 %
10764	AAA	IEEE 802.11ax (160MHz, MCS9, 99pc duty cycle)	WLAN	8.54	± 9.6 %
10765	AAA	IEEE 802.11ax (160MHz, MCS10, 99pc duty cycle)	WLAN	8.54	± 9.6 %
10766	AAA	IEEE 802.11ax (160MHz, MCS11, 99pc duty cycle)	WLAN	8.51	± 9.6 %
10767	AAA	5G NR (CP-OFDM, 1 RB, 5 MHz, QPSK, 15 kHz)	5G NR FR1 TDD	7.99	± 9.6 %
10768	AAA	5G NR (CP-OFDM, 1 RB, 10 MHz, QPSK, 15 kHz)	5G NR FR1 TDD	8.01	± 9.6 %
10769	AAA	5G NR (CP-OFDM, 1 RB, 15 MHz, QPSK, 15 kHz)	5G NR FR1 TDD	8.01	± 9.6 %
10770	AAA	5G NR (CP-OFDM, 1 RB, 20 MHz, QPSK, 15 kHz)	5G NR FR1 TDD	8.02	± 9.6 %
10771	AAA	5G NR (CP-OFDM, 1 RB, 25 MHz, QPSK, 15 kHz)	5G NR FR1 TDD	8.02	± 9.6 %
10772	AAA	5G NR (CP-OFDM, 1 RB, 30 MHz, QPSK, 15 kHz)	5G NR FR1 TDD	8.23	± 9.6 %
10773	AAA	5G NR (CP-OFDM, 1 RB, 40 MHz, QPSK, 15 kHz)	5G NR FR1 TDD	8.03	± 9.6 %
10774	AAA	5G NR (CP-OFDM, 1 RB, 50 MHz, QPSK, 15 kHz)	5G NR FR1 TDD	8.02	± 9.6 %
10776	AAA	5G NR (CP-OFDM, 50% RB, 10 MHz, QPSK, 15 kHz)	5G NR FR1 TDD	8.30	± 9.6 %
10778	AAA	5G NR (CP-OFDM, 50% RB, 20 MHz, QPSK, 15 kHz)	5G NR FR1 TDD	8.34	± 9.6 %
10780	AAA	5G NR (CP-OFDM, 50% RB, 30 MHz, QPSK, 15 kHz)	5G NR FR1 TDD	8.38	± 9.6 %
10781	AAA	5G NR (CP-OFDM, 50% RB, 40 MHz, QPSK, 15 kHz)	5G NR FR1 TDD	8.38	± 9.6 %
10782	AAA	5G NR (CP-OFDM, 50% RB, 50 MHz, QPSK, 15 kHz)	5G NR FR1 TDD	8.43	± 9.6 %

10783	AAA	5G NR (CP-OFDM, 100% RB, 5 MHz, QPSK, 15 kHz)	5G NR FR1 TDD	8.31	± 9.6 %
10784	AAA	5G NR (CP-OFDM, 100% RB, 10 MHz, QPSK, 15 kHz)	5G NR FR1 TDD	8.29	± 9.6 %
10785	AAA	5G NR (CP-OFDM, 100% RB, 15 MHz, QPSK, 15 kHz)	5G NR FR1 TDD	8.40	± 9.6 %
10786	AAA	5G NR (CP-OFDM, 100% RB, 20 MHz, QPSK, 15 kHz)	5G NR FR1 TDD	8.35	± 9.6 %
10787	AAA	5G NR (CP-OFDM, 100% RB, 25 MHz, QPSK, 15 kHz)	5G NR FR1 TDD	8.44	± 9.6 %
10788	AAA	5G NR (CP-OFDM, 100% RB, 30 MHz, QPSK, 15 kHz)	5G NR FR1 TDD	8.39	± 9.6 %
10789	AAA	5G NR (CP-OFDM, 100% RB, 40 MHz, QPSK, 15 kHz)	5G NR FR1 TDD	8.37	± 9.6 %
10790	AAA	5G NR (CP-OFDM, 100% RB, 50 MHz, QPSK, 15 kHz)	5G NR FR1 TDD	8.39	± 9.6 %
10791	AAA	5G NR (CP-OFDM, 1 RB, 5 MHz, QPSK, 30 kHz)	5G NR FR1 TDD	7.83	± 9.6 %
10792	AAA	5G NR (CP-OFDM, 1 RB, 10 MHz, QPSK, 30 kHz)	5G NR FR1 TDD	7.92	± 9.6 %
10793	AAA	5G NR (CP-OFDM, 1 RB, 15 MHz, QPSK, 30 kHz)	5G NR FR1 TDD	7.95	± 9.6 %
10794	AAA	5G NR (CP-OFDM, 1 RB, 20 MHz, QPSK, 30 kHz)	5G NR FR1 TDD	7.82	± 9.6 %
10795	AAA	5G NR (CP-OFDM, 1 RB, 25 MHz, QPSK, 30 kHz)	5G NR FR1 TDD	7.84	± 9.6 %
10796	AAA	5G NR (CP-OFDM, 1 RB, 30 MHz, QPSK, 30 kHz)	5G NR FR1 TDD	7.82	± 9.6 %
10797	AAA	5G NR (CP-OFDM, 1 RB, 40 MHz, QPSK, 30 kHz)	5G NR FR1 TDD	8.01	± 9.6 %
10798	AAA	5G NR (CP-OFDM, 1 RB, 50 MHz, QPSK, 30 kHz)	5G NR FR1 TDD	7.89	± 9.6 %
10799	AAA	5G NR (CP-OFDM, 1 RB, 60 MHz, QPSK, 30 kHz)	5G NR FR1 TDD	7.93	± 9.6 %
10801	AAA	5G NR (CP-OFDM, 1 RB, 80 MHz, QPSK, 30 kHz)	5G NR FR1 TDD	7.89	± 9.6 %
10802	AAA	5G NR (CP-OFDM, 1 RB, 90 MHz, QPSK, 30 kHz)	5G NR FR1 TDD	7.87	± 9.6 %
10803	AAA	5G NR (CP-OFDM, 1 RB, 100 MHz, QPSK, 30 kHz)	5G NR FR1 TDD	7.93	± 9.6 %
10805	AAA	5G NR (CP-OFDM, 50% RB, 10 MHz, QPSK, 30 kHz)	5G NR FR1 TDD	8.34	± 9.6 %
10806	AAA	5G NR (CP-OFDM, 50% RB, 15 MHz, QPSK, 30 kHz)	5G NR FR1 TDD	8.37	± 9.6 %
10809	AAA	5G NR (CP-OFDM, 50% RB, 30 MHz, QPSK, 30 kHz)	5G NR FR1 TDD	8.34	± 9.6 %
10810	AAA	5G NR (CP-OFDM, 50% RB, 40 MHz, QPSK, 30 kHz)	5G NR FR1 TDD	8.34	± 9.6 %
10812	AAA	5G NR (CP-OFDM, 50% RB, 60 MHz, QPSK, 30 kHz)	5G NR FR1 TDD	8.35	± 9.6 %
10817	AAA	5G NR (CP-OFDM, 100% RB, 5 MHz, QPSK, 30 kHz)	5G NR FR1 TDD	8.35	± 9.6 %
10818	AAA	5G NR (CP-OFDM, 100% RB, 10 MHz, QPSK, 30 kHz)	5G NR FR1 TDD	8.34	± 9.6 %
10819	AAA	5G NR (CP-OFDM, 100% RB, 15 MHz, QPSK, 30 kHz)	5G NR FR1 TDD	8.33	± 9.6 %
10820	AAA	5G NR (CP-OFDM, 100% RB, 20 MHz, QPSK, 30 kHz)	5G NR FR1 TDD	8.30	± 9.6 %
10821	AAA	5G NR (CP-OFDM, 100% RB, 25 MHz, QPSK, 30 kHz)	5G NR FR1 TDD	8.41	± 9.6 %
10822	AAA	5G NR (CP-OFDM, 100% RB, 30 MHz, QPSK, 30 kHz)	5G NR FR1 TDD	8.41	± 9.6 %
10823	AAA	5G NR (CP-OFDM, 100% RB, 40 MHz, QPSK, 30 kHz)	5G NR FR1 TDD	8.36	± 9.6 %
10824	AAA	5G NR (CP-OFDM, 100% RB, 50 MHz, QPSK, 30 kHz)	5G NR FR1 TDD	8.39	± 9.6 %

10825	AAA	5G NR (CP-OFDM, 100% RB, 60 MHz, QPSK, 30 kHz)	5G NR FR1 TDD	8.41	± 9.6 %
10827	AAA	5G NR (CP-OFDM, 100% RB, 80 MHz, QPSK, 30 kHz)	5G NR FR1 TDD	8.42	± 9.6 %
10828	AAA	5G NR (CP-OFDM, 100% RB, 90 MHz, QPSK, 30 kHz)	5G NR FR1 TDD	8.43	± 9.6 %
10829	AAA	5G NR (CP-OFDM, 100% RB, 100 MHz, QPSK, 30 kHz)	5G NR FR1 TDD	8.40	± 9.6 %
10830	AAA	5G NR (CP-OFDM, 1 RB, 10 MHz, QPSK, 60 kHz)	5G NR FR1 TDD	7.63	± 9.6 %
10831	AAA	5G NR (CP-OFDM, 1 RB, 15 MHz, QPSK, 60 kHz)	5G NR FR1 TDD	7.73	± 9.6 %
10832	AAA	5G NR (CP-OFDM, 1 RB, 20 MHz, QPSK, 60 kHz)	5G NR FR1 TDD	7.74	± 9.6 %
10833	AAA	5G NR (CP-OFDM, 1 RB, 25 MHz, QPSK, 60 kHz)	5G NR FR1 TDD	7.70	± 9.6 %
10834	AAA	5G NR (CP-OFDM, 1 RB, 30 MHz, QPSK, 60 kHz)	5G NR FR1 TDD	7.75	± 9.6 %
10835	AAA	5G NR (CP-OFDM, 1 RB, 40 MHz, QPSK, 60 kHz)	5G NR FR1 TDD	7.70	± 9.6 %
10836	AAA	5G NR (CP-OFDM, 1 RB, 50 MHz, QPSK, 60 kHz)	5G NR FR1 TDD	7.66	± 9.6 %
10837	AAA	5G NR (CP-OFDM, 1 RB, 60 MHz, QPSK, 60 kHz)	5G NR FR1 TDD	7.68	± 9.6 %
10839	AAA	5G NR (CP-OFDM, 1 RB, 80 MHz, QPSK, 60 kHz)	5G NR FR1 TDD	7.70	± 9.6 %
10840	AAA	5G NR (CP-OFDM, 1 RB, 90 MHz, QPSK, 60 kHz)	5G NR FR1 TDD	7.67	± 9.6 %
10841	AAA	5G NR (CP-OFDM, 1 RB, 100 MHz, QPSK, 60 kHz)	5G NR FR1 TDD	7.71	± 9.6 %
10843	AAA	5G NR (CP-OFDM, 50% RB, 15 MHz, QPSK, 60 kHz)	5G NR FR1 TDD	8.49	± 9.6 %
10844	AAA	5G NR (CP-OFDM, 50% RB, 20 MHz, QPSK, 60 kHz)	5G NR FR1 TDD	8.34	± 9.6 %
10846	AAA	5G NR (CP-OFDM, 50% RB, 30 MHz, QPSK, 60 kHz)	5G NR FR1 TDD	8.41	± 9.6 %
10854	AAA	5G NR (CP-OFDM, 100% RB, 10 MHz, QPSK, 60 kHz)	5G NR FR1 TDD	8.34	± 9.6 %
10855	AAA	5G NR (CP-OFDM, 100% RB, 15 MHz, QPSK, 60 kHz)	5G NR FR1 TDD	8.36	± 9.6 %
10856	AAA	5G NR (CP-OFDM, 100% RB, 20 MHz, QPSK, 60 kHz)	5G NR FR1 TDD	8.37	± 9.6 %
10857	AAA	5G NR (CP-OFDM, 100% RB, 25 MHz, QPSK, 60 kHz)	5G NR FR1 TDD	8.35	± 9.6 %
10858	AAA	5G NR (CP-OFDM, 100% RB, 30 MHz, QPSK, 60 kHz)	5G NR FR1 TDD	8.36	± 9.6 %
10859	AAA	5G NR (CP-OFDM, 100% RB, 40 MHz, QPSK, 60 kHz)	5G NR FR1 TDD	8.34	± 9.6 %
10860	AAA	5G NR (CP-OFDM, 100% RB, 50 MHz, QPSK, 60 kHz)	5G NR FR1 TDD	8.41	± 9.6 %
10861	AAA	5G NR (CP-OFDM, 100% RB, 60 MHz, QPSK, 60 kHz)	5G NR FR1 TDD	8.40	± 9.6 %
10863	AAA	5G NR (CP-OFDM, 100% RB, 80 MHz, QPSK, 60 kHz)	5G NR FR1 TDD	8.41	± 9.6 %
10864	AAA	5G NR (CP-OFDM, 100% RB, 90 MHz, QPSK, 60 kHz)	5G NR FR1 TDD	8.37	± 9.6 %
10865	AAA	5G NR (CP-OFDM, 100% RB, 100 MHz, QPSK, 60 kHz)	5G NR FR1 TDD	8.41	± 9.6 %
10866	AAA	5G NR (DFT-s-OFDM, 1 RB, 100 MHz, QPSK, 30 kHz)	5G NR FR1 TDD	5.68	± 9.6 %
10868	AAA	5G NR (DFT-s-OFDM, 100% RB, 100 MHz, QPSK, 30 kHz)	5G NR FR1 TDD	5.89	± 9.6 %
10869	AAA	5G NR (DFT-s-OFDM, 1 RB, 100 MHz, QPSK, 120 kHz)	5G NR FR2 TDD	5.75	± 9.6 %
10870	AAA	5G NR (DFT-s-OFDM, 100% RB, 100 MHz, QPSK, 120 kHz)	5G NR FR2 TDD	5.86	± 9.6 %

10871	AAA	5G NR (DFT-s-OFDM, 1 RB, 100 MHz, 16QAM, 120 kHz)	5G NR FR2 TDD	5.75	± 9.6 %
10872	AAA	5G NR (DFT-s-OFDM, 100% RB, 100 MHz, 16QAM, 120 kHz)	5G NR FR2 TDD	6.52	± 9.6 %
10873	AAA	5G NR (DFT-s-OFDM, 1 RB, 100 MHz, 64QAM, 120 kHz)	5G NR FR2 TDD	6.61	± 9.6 %
10874	AAA	5G NR (DFT-s-OFDM, 100% RB, 100 MHz, 64QAM, 120 kHz)	5G NR FR2 TDD	6.65	± 9.6 %
10875	AAA	5G NR (CP-OFDM, 1 RB, 100 MHz, QPSK, 120 kHz)	5G NR FR2 TDD	7.78	± 9.6 %
10876	AAA	5G NR (CP-OFDM, 100% RB, 100 MHz, QPSK, 120 kHz)	5G NR FR2 TDD	8.39	± 9.6 %
10877	AAA	5G NR (CP-OFDM, 1 RB, 100 MHz, 16QAM, 120 kHz)	5G NR FR2 TDD	7.95	± 9.6 %
10878	AAA	5G NR (CP-OFDM, 100% RB, 100 MHz, 16QAM, 120 kHz)	5G NR FR2 TDD	8.41	± 9.6 %
10879	AAA	5G NR (CP-OFDM, 1 RB, 100 MHz, 64QAM, 120 kHz)	5G NR FR2 TDD	8.12	± 9.6 %
10880	AAA	5G NR (CP-OFDM, 100% RB, 100 MHz, 64QAM, 120 kHz)	5G NR FR2 TDD	8.38	± 9.6 %
10881	AAA	5G NR (DFT-s-OFDM, 1 RB, 50 MHz, QPSK, 120 kHz)	5G NR FR2 TDD	5.75	± 9.6 %
10882	AAA	5G NR (DFT-s-OFDM, 100% RB, 50 MHz, QPSK, 120 kHz)	5G NR FR2 TDD	5.96	± 9.6 %
10883	AAA	5G NR (DFT-s-OFDM, 1 RB, 50 MHz, 16QAM, 120 kHz)	5G NR FR2 TDD	6.57	± 9.6 %
10884	AAA	5G NR (DFT-s-OFDM, 100% RB, 50 MHz, 16QAM, 120 kHz)	5G NR FR2 TDD	6.53	± 9.6 %
10885	AAA	5G NR (DFT-s-OFDM, 1 RB, 50 MHz, 64QAM, 120 kHz)	5G NR FR2 TDD	6.61	± 9.6 %
10886	AAA	5G NR (DFT-s-OFDM, 100% RB, 50 MHz, 64QAM, 120 kHz)	5G NR FR2 TDD	6.65	± 9.6 %
10887	AAA	5G NR (CP-OFDM, 1 RB, 50 MHz, QPSK, 120 kHz)	5G NR FR2 TDD	7.78	± 9.6 %
10888	AAA	5G NR (CP-OFDM, 100% RB, 50 MHz, QPSK, 120 kHz)	5G NR FR2 TDD	8.35	± 9.6 %
10889	AAA	5G NR (CP-OFDM, 1 RB, 50 MHz, 16QAM, 120 kHz)	5G NR FR2 TDD	8.02	± 9.6 %
10890	AAA	5G NR (CP-OFDM, 100% RB, 50 MHz, 16QAM, 120 kHz)	5G NR FR2 TDD	8.40	± 9.6 %
10891	AAA	5G NR (CP-OFDM, 1 RB, 50 MHz, 64QAM, 120 kHz)	5G NR FR2 TDD	8.13	± 9.6 %
10892	AAA	5G NR (CP-OFDM, 100% RB, 50 MHz, 64QAM, 120 kHz)	5G NR FR2 TDD	8.41	± 9.6 %

^E Uncertainty is determined using the max. deviation from linear response applying rectangular distribution and is expressed for the square of the field value.



Accredited by the Swiss Accreditation Service (SAS)
The Swiss Accreditation Service is one of the signatories to the EA
Multilateral Agreement for the recognition of calibration certificates

Accreditation No.: **SCS 0108**

Client **PC Test**

Certificate No: **5G-Veri30-1035_Feb20**

CALIBRATION CERTIFICATE

Object: **5G Verification Source 30 GHz - SN: 1035**

Calibration procedure(s): **QA CAL-45.v2
Calibration procedure for sources in air above 6 GHz**

Calibration date: **February 12, 2020**

*MAS
4/8/20*

This calibration certificate documents the traceability to national standards, which realize the physical units of measurements (SI).
The measurements and the uncertainties with confidence probability are given on the following pages and are part of the certificate.

All calibrations have been conducted in the closed laboratory facility: environment temperature (22 ± 3)°C and humidity < 70%.

Calibration Equipment used (M&TE critical for calibration)

Primary Standards	ID #	Cal Date (Certificate No.)	Scheduled Calibration
Reference Probe EUmmWV3	SN: 9374	31-Dec-19 (No. EUmmWV3-9374_Dec19)	Dec-20
DAE4ip	SN: 1602	01-Oct-19 (No. DAE4ip-1602_Oct19)	Oct-20
Secondary Standards	ID #	Check Date (in house)	Scheduled Check

Calibrated by:	Name Jeton Kastrati	Function Laboratory Technician	Signature
Approved by:	Name Katja Pokovic	Technical Manager	

Issued: February 18, 2020

This calibration certificate shall not be reproduced except in full without written approval of the laboratory.



Accredited by the Swiss Accreditation Service (SAS)

The Swiss Accreditation Service is one of the signatories to the EA Multilateral Agreement for the recognition of calibration certificates

Accreditation No.: **SCS 0108**

Glossary

CW Continuous wave

Calibration is Performed According to the Following Standards

- Internal procedure QA CAL-45-5Gsources
- IEC TR 63170 ED1, "Measurement procedure for the evaluation of power density related to human exposure to radio frequency fields from wireless communication devices operating between 6 GHz and 100 GHz", January 2018

Methods Applied and Interpretation of Parameters

- *Coordinate System:* z-axis in the waveguide horn boresight, x-axis is in the direction of the E-field, y-axis normal to the others in the field scanning plane parallel to the horn flare and horn flange.
- *Measurement Conditions:* (1) 10 GHz: The forward power to the horn antenna is measured prior and after the measurement with a power sensor. During the measurements, the horn is directly connected to the cable and the antenna ohmic and mismatch losses are determined by far-field measurements. (2) 30, 45, 60 and 90 GHz: The verification sources are switched on for at least 30 minutes. Absorbers are used around the probe cub and at the ceiling to minimize reflections.
- *Horn Positioning:* The waveguide horn is mounted vertically on the flange of the waveguide source to allow vertical positioning of the EUmmW probe during the scan. The plane is parallel to the phantom surface. Probe distance is verified using mechanical gauges positioned on the flare of the horn.
- *E- field distribution:* E field is measured in two x-y-plane (10mm, 10mm + $\lambda/4$) with a vectorial E-field probe. The E-field value stated as calibration value represents the E-field-maxima and the averaged (1cm² and 4cm²) power density values at 10mm in front of the horn.
- *Field polarization:* Above the open horn, linear polarization of the field is expected. This is verified graphically in the field representation.

Calibrated Quantity

- Local peak E-field (V/m) and peak values of the total and normal component of the poynting vector $|\text{Re}\{S\}|$ and $n \cdot \text{Re}\{S\}$ averaged over the surface area of 1 cm² ($pS_{\text{tot,avg}1\text{cm}^2}$ and $pS_{\text{n,avg}1\text{cm}^2}$) and 4cm² ($pS_{\text{tot,avg}4\text{cm}^2}$ and $pS_{\text{n,avg}4\text{cm}^2}$) at the nominal operational frequency of the verification source.

The reported uncertainty of measurement is stated as the standard uncertainty of measurement multiplied by the coverage factor $k=2$, which for a normal distribution corresponds to a coverage probability of approximately 95%.

Measurement Conditions

DASY system configuration, as far as not given on page 1.

DASY Version	cDASY6 Module mmWave	V2.0
Phantom	5G Phantom	
Distance Horn Aperture - plane	10 mm	
XY Scan Resolution	dx, dy = 2.5 mm	
Number of measured planes	2 (10mm, 10mm + $\lambda/4$)	
Frequency	30 GHz \pm 10 MHz	

Calibration Parameters, 30 GHz

Distance Horn Aperture to Measured Plane	<i>Prad</i> ¹ (mW)	Max E-field (V/m)	Uncertainty (k = 2)	Avg Power Density n.Re{S}, Re{S} (W/m ²)		Uncertainty (k = 2)
				1 cm ²	4 cm ²	
10 mm	29.0	126	1.27 dB	36.5, 36.9	32.1, 32.5	1.28 dB

¹ derived from far-field data

DASY Report

Measurement Report for 5G Verification Source 30 GHz, UID 0 -, Channel 30000 (30000.0MHz)

Device under Test Properties

Name, Manufacturer	Dimensions [mm]	IMEI	DUT Type
5G Verification Source 30 GHz	100.0 x 100.0 x 100.0	SN: 1035	-

Exposure Conditions

Phantom Section	Position, Test Distance [mm]	Band	Group,	Frequency [MHz], Channel Number	Conversion Factor
5G -	5.55 mm	Validation band	CW	30000.0, 30000	1.0

Hardware Setup

Phantom	Medium	Probe, Calibration Date	DAE, Calibration Date
mmWave Phantom - 1002	Air	EUmmWV3 - SN9374_F1-78GHz, 2019-12-31	DAE4ip Sn1602, 2019-10-01

Scan Setup

	5G Scan
Grid Extents [mm]	60.0 x 60.0
Grid Steps [lambda]	0.25 x 0.25
Sensor Surface [mm]	5.55
MAIA	MAIA not used

Measurement Results

	5G Scan
Date	2020-02-12, 08:14
Avg. Area [cm ²]	1.00
p _{Stot} avg [W/m ²]	36.9
p _{Sn} avg [W/m ²]	36.5
E _{peak} [V/m]	126
Power Drift [dB]	-0.05

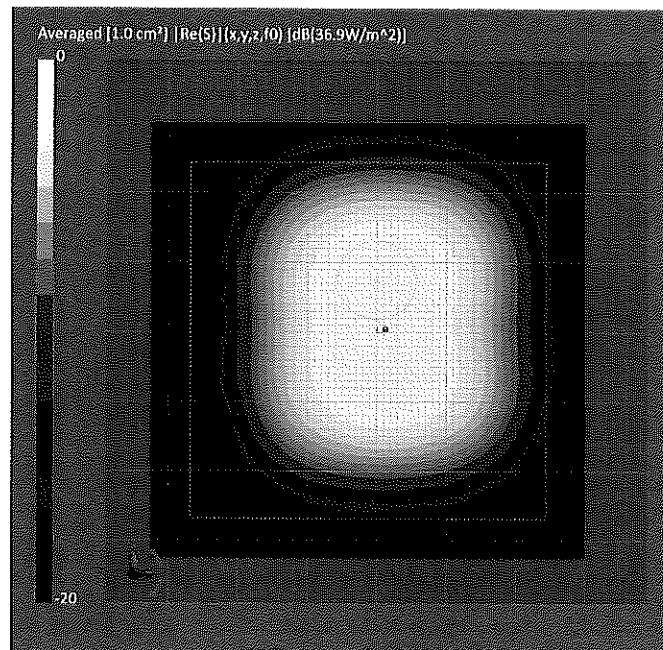



Accredited by the Swiss Accreditation Service (SAS)
The Swiss Accreditation Service is one of the signatories to the EA
Multilateral Agreement for the recognition of calibration certificates

Accreditation No.: **SCS 0108**

Client **PC Test**

Certificate No: **5G-Veri30-1044_May20**

CALIBRATION CERTIFICATE

Object: **5G Verification Source 30 GHz - SN: 1044**

Calibration procedure(s): **QA CAL-45.v3
Calibration procedure for sources in air above 6 GHz**

Calibration date: **May 14, 2020**

*MAB
6/2/20*

This calibration certificate documents the traceability to national standards, which realize the physical units of measurements (SI).
The measurements and the uncertainties with confidence probability are given on the following pages and are part of the certificate.

All calibrations have been conducted in the closed laboratory facility: environment temperature (22 ± 3)°C and humidity < 70%.

Calibration Equipment used (M&TE critical for calibration)

Primary Standards	ID #	Cal Date (Certificate No.)	Scheduled Calibration
Reference Probe EUmmWV3	SN: 9374	31-Dec-19 (No. EUmmWV3-9374_Dec19)	Dec-20
DAE4ip	SN: 1602	01-Oct-19 (No. DAE4ip-1602_Oct19)	Oct-20

Secondary Standards	ID #	Check Date (in house)	Scheduled Check

Calibrated by:	Name Leif Klysner	Function Laboratory Technician	Signature <i>Leif Klysner</i>
Approved by:	Name Katja Pokovic	Technical Manager	<i>Katja Pokovic</i>

Issued: May 18, 2020

This calibration certificate shall not be reproduced except in full without written approval of the laboratory.



Accredited by the Swiss Accreditation Service (SAS)
The Swiss Accreditation Service is one of the signatories to the EA
Multilateral Agreement for the recognition of calibration certificates

Accreditation No.: **SCS 0108**

Glossary

CW Continuous wave

Calibration is Performed According to the Following Standards

- Internal procedure QA CAL-45-5Gsources
- IEC TR 63170 ED1, "Measurement procedure for the evaluation of power density related to human exposure to radio frequency fields from wireless communication devices operating between 6 GHz and 100 GHz", January 2018

Methods Applied and Interpretation of Parameters

- *Coordinate System:* z-axis in the waveguide horn boresight, x-axis is in the direction of the E-field, y-axis normal to the others in the field scanning plane parallel to the horn flare and horn flange.
- *Measurement Conditions:* (1) 10 GHz: The forward power to the horn antenna is measured prior and after the measurement with a power sensor. During the measurements, the horn is directly connected to the cable and the antenna ohmic and mismatch losses are determined by far-field measurements. (2) 30, 45, 60 and 90 GHz: The verification sources are switched on for at least 30 minutes. Absorbers are used around the probe cub and at the ceiling to minimize reflections.
- *Horn Positioning:* The waveguide horn is mounted vertically on the flange of the waveguide source to allow vertical positioning of the EUmmW probe during the scan. The plane is parallel to the phantom surface. Probe distance is verified using mechanical gauges positioned on the flare of the horn.
- *E- field distribution:* E field is measured in two x-y-plane (10mm, 10mm + $\lambda/4$) with a vectorial E-field probe. The E-field value stated as calibration value represents the E-field-maxima and the averaged (1cm² and 4cm²) power density values at 10mm in front of the horn.
- *Field polarization:* Above the open horn, linear polarization of the field is expected. This is verified graphically in the field representation.

Calibrated Quantity

- Local peak E-field (V/m) and peak values of the total and normal component of the poynting vector $|\text{Re}\{S\}|$ and $n \cdot \text{Re}\{S\}$ averaged over the surface area of 1 cm² ($pS_{\text{tot}avg1\text{cm}^2}$ and $pS_{navg1\text{cm}^2}$) and 4cm² ($pS_{\text{tot}avg4\text{cm}^2}$ and $pS_{navg4\text{cm}^2}$) at the nominal operational frequency of the verification source.

The reported uncertainty of measurement is stated as the standard uncertainty of measurement multiplied by the coverage factor $k=2$, which for a normal distribution corresponds to a coverage probability of approximately 95%.

Measurement Conditions

DASY system configuration, as far as not given on page 1.

DASY Version	cDASY6 Module mmWave	V2.0
Phantom	5G Phantom	
Distance Horn Aperture - plane	10 mm	
XY Scan Resolution	dx, dy = 2.5 mm	
Number of measured planes	2 (10mm, 10mm + $\lambda/4$)	
Frequency	30 GHz \pm 10 MHz	

Calibration Parameters, 30 GHz

Distance Horn Aperture to Measured Plane	<i>Prad</i> ¹ (mW)	Max E-field (V/m)	Uncertainty (k = 2)	Avg Power Density n.Re{S}, Re{S} (W/m ²)		Uncertainty (k = 2)
				1 cm ²	4 cm ²	
10 mm	32.5	131	1.27 dB	39.3, 39.8	34.7, 35.0	1.28 dB

¹ derived from far-field data

DASY Report

Measurement Report for 5G Verification Source 30 GHz, UID 0 -, Channel 30000 (30000.0MHz)

Device under Test Properties

Name, Manufacturer	Dimensions [mm]	IMEI	DUT Type
5G Verification Source 30 GHz	100.0 x 100.0 x 100.0	SN: 1044	-

Exposure Conditions

Phantom Section	Position, Test Distance [mm]	Band	Group,	Frequency [MHz], Channel Number	Conversion Factor
5G -	5.55 mm	Validation band	CW	30000.0, 30000	1.0

Hardware Setup

Phantom	Medium	Probe, Calibration Date	DAE, Calibration Date
mmWave Phantom - 1002	Air	EUmmWV3 - SN9374_F1-78GHz, 2019-12-31	DAE4ip Sn1602, 2019-10-01

Scan Setup

	5G Scan
Grid Extents [mm]	60.0 x 60.0
Grid Steps [lambda]	0.25 x 0.25
Sensor Surface [mm]	5.55
MAIA	MAIA not used

Measurement Results

	5G Scan
Date	2020-05-14, 16:40
Avg. Area [cm ²]	1.00
pS _{tot} avg [W/m ²]	39.8
pS _n avg [W/m ²]	39.3
E _{peak} [V/m]	131
Power Drift [dB]	-0.02

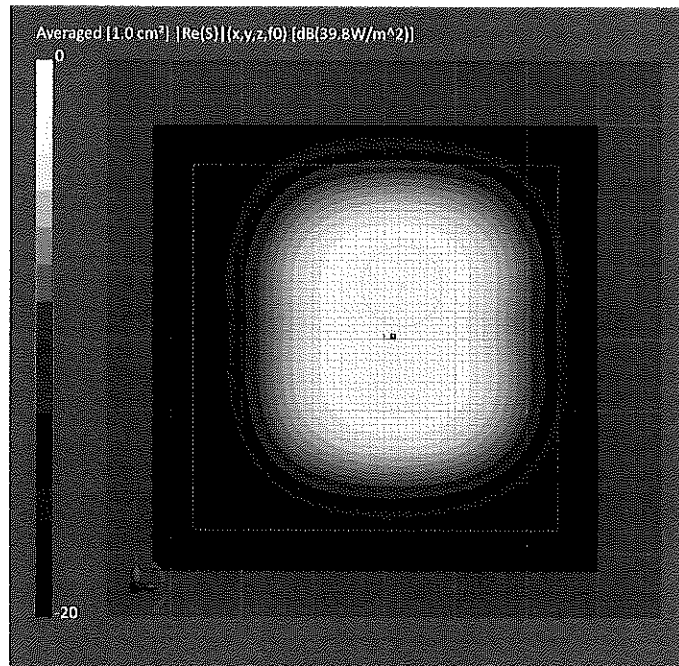

DASY Report

Measurement Report for 5G Verification Source 30 GHz, UID 0 -, Channel 30000 (30000.0MHz)

Device under Test Properties

Name, Manufacturer	Dimensions [mm]	IMEI	DUT Type
5G Verification Source 30 GHz	100.0 x 100.0 x 100.0	SN: 1044	-

Exposure Conditions

Phantom Section	Position, Test Distance [mm]	Band	Group,	Frequency [MHz], Channel Number	Conversion Factor
5G -	5.55 mm	Validation band	CW	30000.0, 30000	1.0

Hardware Setup

Phantom	Medium	Probe, Calibration Date	DAE, Calibration Date
mmWave Phantom - 1002	Air	EUmmWV3 - SN9374_F1-78GHz, 2019-12-31	DAE4ip Sn1602, 2019-10-01

Scan Setup

	5G Scan
Grid Extents [mm]	60.0 x 60.0
Grid Steps [lambda]	0.25 x 0.25
Sensor Surface [mm]	5.55
MAIA	MAIA not used

Measurement Results

	5G Scan
Date	2020-05-14, 16:40
Avg. Area [cm ²]	4.00
pS _{tot} avg [W/m ²]	35.0
pS _n avg [W/m ²]	34.7
E _{peak} [V/m]	131
Power Drift [dB]	-0.02

