

FCC Test Report (Part 24)

Report No.: RF200519C01-1

FCC ID: A3LSMT975

Test Model: SM-T975

Received Date: May 11, 2020

Test Date: May 11 ~ Jun. 30, 2020

Issued Date: Jun. 30, 2020

Applicant: SAMSUNG ELECTRONICS CO. LTD.

Address: 129 Samsung-ro, Yeongtong-gu, Suwon-Si Gyeonggi-do 16677 Korea
(Republic Of)

Issued By: Bureau Veritas Consumer Products Services (H.K.) Ltd., Taoyuan Branch
Lin Kou Laboratories

Lab Address: No. 47-2, 14th Ling, Chia Pau Vil., Lin Kou Dist., New Taipei City, Taiwan

Test Location: No.19, Hwa Ya 2nd Rd., Wen Hwa Vil., Kwei Shan Dist., Taoyuan City
33383, Taiwan

FCC Registration / 788550 / TW0003

Designation Number:



This report is for your exclusive use. Any copying or replication of this report to or for any other person or entity, or use of our name or trademark, is permitted only with our prior written permission. This report sets forth our findings solely with respect to the test samples identified herein. The results set forth in this report are not indicative or representative of the quality or characteristics of the lot from which a test sample was taken or any similar or identical product unless specifically and expressly noted. Our report includes all of the tests requested by you and the results thereof based upon the information that you provided to us. You have 60 days from date of issuance of this report to notify us of any material error or omission caused by our negligence, provided, however, that such notice shall be in writing and shall specifically address the issue you wish to raise. A failure to raise such issue within the prescribed time shall constitute your unqualified acceptance of the completeness of this report, the tests conducted and the correctness of the report contents. Unless specifically mentioned, the uncertainty of measurement has been explicitly taken into account to declare the compliance or non-compliance to the specification. This report should not be used by the client to claim any endorsement by TAF.

Table of Contents

Release Control Record	4
1 Certificate of Conformity	5
2 Summary of Test Results	6
2.1 Measurement Uncertainty.....	6
2.2 Test Site and Instruments.....	7
3 General Information	8
3.1 General Description of EUT.....	8
3.2 Configuration of System under Test.....	10
3.2.1 Description of Support Units.....	10
3.3 Test Mode Applicability and Tested Channel Detail.....	11
3.4 EUT Operating Conditions.....	19
3.5 General Description of Applied Standards and References.....	19
4 Test Types and Results	20
4.1 Output Power Measurement.....	20
4.1.1 Limits of Output Power Measurement.....	20
4.1.2 Test Procedures.....	20
4.1.3 Test Setup.....	21
4.1.4 Test Results.....	22
4.2 Modulation Characteristics Measurement.....	48
4.2.1 Limits of Modulation Characteristics.....	48
4.2.2 Test Procedure.....	48
4.2.3 Test Setup.....	48
4.2.4 Test Results.....	49
4.3 Frequency Stability Measurement.....	53
4.3.1 Limits of Frequency Stability Measurement.....	53
4.3.2 Test Procedure.....	53
4.3.3 Conducted Setup.....	53
4.3.4 Test Results.....	54
4.4 Occupied Bandwidth Measurement.....	69
4.4.1 Test Procedure.....	69
4.4.2 Test Setup.....	69
4.4.3 Test Result.....	70
4.5 Band Edge Measurement.....	82
4.5.1 Limits of Band Edge Measurement.....	82
4.5.2 Test Setup.....	82
4.5.3 Test Procedures.....	82
4.5.4 Test Results.....	83
4.6 Peak to Average Ratio.....	97
4.6.1 Limits of Peak to Average Ratio Measurement.....	97
4.6.2 Test Setup.....	97
4.6.3 Test Procedures.....	97
4.6.4 Test Results.....	98
4.7 Conducted Spurious Emissions.....	104
4.7.1 Limits of Conducted Spurious Emissions Measurement.....	104
4.7.2 Test Setup.....	104
4.7.3 Test Procedure.....	104
4.7.4 Test Results.....	105
4.8 Radiated Emission Measurement.....	123
4.8.1 Limits of Radiated Emission Measurement.....	123
4.8.2 Test Procedure.....	123
4.8.3 Deviation from Test Standard.....	123
4.8.4 Test Setup.....	124
4.8.5 Test Results.....	125

5	Pictures of Test Arrangements.....	149
	Appendix – Information of the Testing Laboratories	150

Release Control Record

Issue No.	Description	Date Issued
RF200519C01-1	Original release	Jun. 30, 2020

1 Certificate of Conformity

Product: Tablet

Brand: Samsung

Test Model: SM-T975

Sample Status: Engineering Sample

Applicant: SAMSUNG ELECTRONICS CO. LTD.

Test Date: May 11 ~ Jun. 30, 2020

Standards: FCC Part 24, Subpart E

The above equipment has been tested by **Bureau Veritas Consumer Products Services (H.K.) Ltd., Taoyuan Branch**, and found compliance with the requirement of the above standards. The test record, data evaluation & Equipment Under Test (EUT) configurations represented herein are true and accurate accounts of the measurements of the sample's RF characteristics under the conditions specified in this report.

Prepared by :

Polly Chien / Specialist

Date:

Jun. 30, 2020

Approved by :

Bruce Chen / Senior Project Engineer

Date:

Jun. 30, 2020

2 Summary of Test Results

Applied Standard: FCC Part 24 & Part 2			
FCC Clause	Test Item	Result	Remarks
2.1046 24.232	Effective radiated power	Pass	Meet the requirement of limit.
2.1046 24.232(d)	Peak To Average Ratio	Pass	Meet the requirement of limit.
2.1047	Modulation Characteristics	Pass	Meet the requirement of limit.
2.1055 24.235	Frequency Stability	Pass	Meet the requirement of limit.
2.1049 24.238	Occupied Bandwidth	Pass	Meet the requirement of limit.
24.238	Band Edge Measurements	Pass	Meet the requirement of limit.
2.1051 24.238	Conducted Spurious Emissions	Pass	Meet the requirement of limit.
2.1053 24.238	Radiated Spurious Emissions	Pass	Meet the requirement of limit. Minimum passing margin is -36.0dB at 87.23MHz.

Note:

Determining compliance based on the results of the compliance measurement, not taking into account measurement instrumentation uncertainty.

2.1 Measurement Uncertainty

Where relevant, the following measurement uncertainty levels have been estimated for tests performed on the EUT as specified in CISPR 16-4-2:

Measurement	Frequency	Expanded Uncertainty (k=2) (\pm)
Radiated Emissions up to 1 GHz	9kHz ~ 30MHz	3.04 dB
	30MHz ~ 200MHz	3.59 dB
	200MHz ~ 1000MHz	3.60 dB
Radiated Emissions above 1 GHz	1GHz ~ 20GHz	2.29 dB
	18GHz ~ 40GHz	2.29 dB

2.2 Test Site and Instruments

Description & Manufacturer	Model No.	Serial No.	Cal. Date	Cal. Due
Test Receiver KEYSIGHT	N9038A	MY55420137	Apr. 16, 2020	Apr. 15, 2021
Spectrum Analyzer ROHDE & SCHWARZ	FSP40	100039	Jun. 12, 2019	Jun. 11, 2020
			Jun. 12, 2020	Jun. 11, 2021
Spectrum Analyzer ROHDE & SCHWARZ	FSW43	101582	Mar. 31, 2020	Mar. 30, 2021
BILOG Antenna SCHWARZBECK	VULB9168	9168-160	Nov. 07, 2019	Nov. 06, 2020
HORN Antenna SCHWARZBECK	BBHA 9120 D	9120D-1169	Nov. 24, 2019	Nov. 23, 2020
HORN Antenna SCHWARZBECK	BBHA 9170	BBHA9170241	Nov. 24, 2019	Nov. 23, 2020
Horn Antenna ETS	3117	00034128	Nov. 24, 2019	Nov. 23, 2020
Loop Antenna TESEQ	HLA 6121	45745	Jul. 01, 2019	Jun. 30, 2020
Preamplifier Agilent (Below 1GHz)	8447D	2944A10638	Jul. 11, 2019	Jul. 10, 2020
Preamplifier Agilent (Above 1GHz)	8449B	3008A02367	Feb. 18, 2020	Feb. 17, 2021
RF signal cable HUBER+SUHNER&EMCI	SUCOFLEX 104 & EMC104-SM-SM80 00	CABLE-CH9-02 (248780+171006)	Jan. 18, 2020	Jan. 17, 2021
RF signal cable HUBER+SUHNER	SUCOFLEX 104	CABLE-CH9-(250795/4)	Jul. 11, 2019	Jul. 10, 2020
RF signal cable Woken	8D-FB	Cable-CH9-01	Jul. 30, 2019	Jul. 29, 2020
Software BV ADT	ADT_Radiated_ V7.6.15.9.5	NA	NA	NA
Antenna Tower EMCO	2070/2080	512.835.4684	NA	NA
Turn Table EMCO	2087-2.03	NA	NA	NA
Antenna Tower & Turn BV ADT	AT100	AT93021705	NA	NA
Turn Table BV ADT	TT100	TT93021705	NA	NA
Turn Table Controller BV ADT	SC100	SC93021705	NA	NA
Boresight Antenna Fixture	BAF-02	5	NA	NA
Standard Temperature And Humidity Chamber TERCHY	HRM-120RF	931022	Dec. 12, 2019	Dec. 11, 2020
JFW 20dB attenuation	50HF-020-SMA	NA	NA	NA
DC Power Supply Keysight	U8002A	MY56330015	NA	NA
Radio Communication Analyzer Anritsu	MT8821C	6201462755	Feb. 13, 2020	Feb. 12, 2021
Radio Communication Analyzer Anritsu	MT8820C	6201010284	Dec. 25, 2019	Dec. 24, 2020
Digital Multimeter Fluke	87-III	70360742	Jun. 27, 2019	Jun. 26, 2020
			Jun. 23, 2020	Jun. 22, 2021
MXG Vector signal generator Agilent	N5182B	MY53050430	Nov. 25, 2019	Nov. 24, 2020

Note: 1. The calibration interval of the above test instruments is 12 months and the calibrations are traceable to NML/ROC and NIST/USA.

2. The test was performed in HwaYa Chamber 9.

3 General Information

3.1 General Description of EUT

Product	Tablet	
Brand	Samsung	
Test Model	SM-T975	
Sample Status	Engineering Sample	
Power Supply Rating	5.0 or 9.0 Vdc (Adapter) 3.4Vdc (Battery)	
Modulation Type	PCS, GPRS: GMSK EDGE: 8PSK WCDMA: BPSK, QPSK HSDPA: BPSK HSUPA: QPSK LTE: QPSK, 16QAM, 64QAM	
Operating Frequency	PCS/GPRS/EDGE	1850.2~1909.8MHz
	WCDMA Band 2	1852.4~1907.6MHz
	LTE Band 2 (Channel Bandwidth 1.4MHz)	1850.7~1909.3MHz
	LTE Band 2 (Channel Bandwidth 3MHz)	1851.5~1908.5MHz
	LTE Band 2 (Channel Bandwidth 5MHz)	1852.5~1907.5MHz
	LTE Band 2 (Channel Bandwidth 10MHz)	1855.0~1905.0MHz
	LTE Band 2 (Channel Bandwidth 15MHz)	1857.5~1902.5MHz
	LTE Band 2 (Channel Bandwidth 20MHz)	1860.0~1900.0MHz
	LTE Band 25 (Channel Bandwidth: 1.4MHz)	1850.7~1914.3MHz
	LTE Band 25 (Channel Bandwidth: 3MHz)	1851.5~1913.5MHz
	LTE Band 25 (Channel Bandwidth: 5MHz)	1852.5~1912.5MHz
	LTE Band 25 (Channel Bandwidth: 10MHz)	1855.0~1910.0MHz
	LTE Band 25 (Channel Bandwidth: 15MHz)	1857.5~1907.5MHz
	LTE Band 25 (Channel Bandwidth: 20MHz)	1860.0~1905.0MHz

Max. EIRP Power	PCS/GPRS	436.516mW (26.4dBm)		
	EDGE	213.796mW (23.3dBm)		
	WCDMA Band 2	165.959mW (22.2dBm)		
		QPSK	16QAM	64QAM
	LTE Band 2 (Channel Bandwidth 1.4MHz)	63.096mW (18.0dBm)	50.119mW (17.0dBm)	44.668mW (16.5dBm)
	LTE Band 2 (Channel Bandwidth 3MHz)	74.131mW (18.7dBm)	57.544mW (17.6dBm)	51.286mW (17.1dBm)
	LTE Band 2 (Channel Bandwidth 5MHz)	72.444mW (18.6dBm)	56.234mW (17.5dBm)	52.481mW (17.2dBm)
	LTE Band 2 (Channel Bandwidth 10MHz)	74.131mW (18.7dBm)	60.256mW (17.8dBm)	54.954mW (17.4dBm)
	LTE Band 2 (Channel Bandwidth 15MHz)	61.660mW (17.9dBm)	47.863mW (16.8dBm)	43.652mW (16.4dBm)
	LTE Band 2 (Channel Bandwidth 20MHz)	70.795mW (18.5dBm)	54.954mW (17.4dBm)	47.863mW (16.8dBm)
	LTE Band 25 (Channel Bandwidth: 1.4MHz)	63.096mW (18.0dBm)	51.286mW (17.1dBm)	39.811mW (16.0dBm)
	LTE Band 25 (Channel Bandwidth: 3MHz)	64.565mW (18.1dBm)	47.863mW (16.8dBm)	42.658mW (16.3dBm)
	LTE Band 25 (Channel Bandwidth: 5MHz)	58.884mW (17.7dBm)	47.863mW (16.8dBm)	41.687mW (16.2dBm)
	LTE Band 25 (Channel Bandwidth: 10MHz)	63.096mW (18.0dBm)	48.978mW (16.9dBm)	43.652mW (16.4dBm)
	LTE Band 25 (Channel Bandwidth: 15MHz)	64.565mW (18.1dBm)	50.119mW (17.0dBm)	45.709mW (16.6dBm)
	LTE Band 25 (Channel Bandwidth: 20MHz)	66.069mW (18.2dBm)	51.286mW (17.1dBm)	46.774mW (16.7dBm)
Emission Designator	PCS/GPRS	246KGXW		
	EDGE	245KG7W		
	WCDMA Band 2	4M16F9W		
		QPSK	16QAM	64QAM
	LTE Band 2 (Channel Bandwidth 1.4MHz)	1M09G7D	1M09D7W	1M09D7W
	LTE Band 2 (Channel Bandwidth 3MHz)	2M70G7D	2M69D7W	2M70D7W
	LTE Band 2 (Channel Bandwidth 5MHz)	4M49G7D	4M49D7W	4M50D7W
	LTE Band 2 (Channel Bandwidth 10MHz)	8M96G7D	8M96D7W	8M96D7W
	LTE Band 2 (Channel Bandwidth 15MHz)	13M5G7D	13M4D7W	13M4D7W
	LTE Band 2 (Channel Bandwidth 20MHz)	17M9G7D	17M9D7W	17M9D7W
	LTE Band 25 (Channel Bandwidth: 1.4MHz)	1M09G7D	1M09D7W	1M09D7W
	LTE Band 25 (Channel Bandwidth: 3MHz)	2M70G7D	2M70D7W	2M70D7W
	LTE Band 25 (Channel Bandwidth: 5MHz)	4M49G7D	4M49D7W	4M49D7W
	LTE Band 25 (Channel Bandwidth: 10MHz)	8M96G7D	8M96D7W	8M95D7W
	LTE Band 25 (Channel Bandwidth: 15MHz)	13M5G7D	13M4D7W	13M4D7W
	LTE Band 25 (Channel Bandwidth: 20MHz)	17M9G7D	17M9D7W	17M9D7W
Antenna Type	Refer to Note as below			
Antenna Connector	Refer to Note as below			
Accessory Device	Refer to Note as below			
Cable Supplied	Refer to Note as below			

Note:

1. The EUT uses following antennas.

Antenna Type	Antenna Connector	Band	Frequency (MHz)	Antenna Gain (dBi)
Metal Antenna	C-clip	LTE Band 2, LTE Band 25, WCDMA Band 2, PCS 1900	1850	-5.42
			1880	-5.48
			1915	-5.30
			1930	-5.37
			1960	-4.47
			1995	-4.43

*The above Antenna information is declared by manufacturer and for more detailed features description, please refer to the manufacturer's specifications, the laboratory shall not be held responsible.

2. The EUT uses following accessory devices.

Accessories	Brand	Model	Manufacturer	Specification
Earphone	Samsung	EHS64	Samsung	3.5mm
S-pen	Samsung	EJ-PT870	Samsung	Bluetooth
Keyboard	Samsung	EF-DT970	Samsung	N/A
Cable	Samsung	EP-DG930M	Samsung	A to C type, shielded, 1.0m
Adapter	Samsung	EP-TA200	Samsung	I/P: 100-240Vac, 50-60Hz, 0.5A O/P: 9.0Vdc, 1.67A or 5.0Vdc, 2.0A
Battery	Samsung	EB-BT975ABY	Samsung	Rating: 3.86Vdc, 9800mAh, 37.83Wh

3.2 Configuration of System under Test

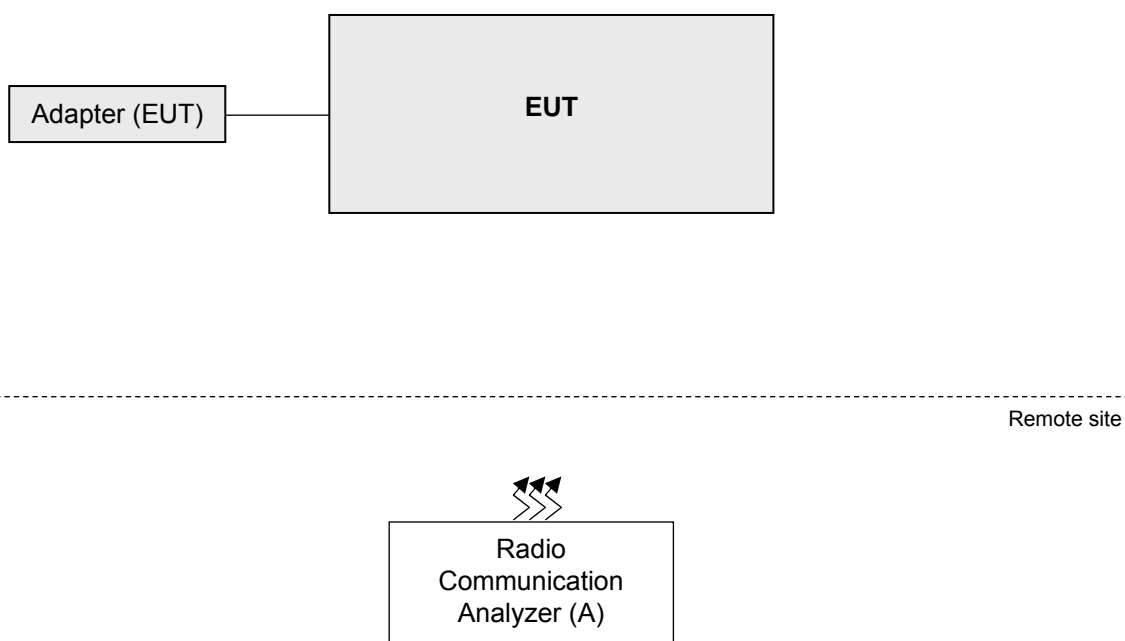

3.2.1 Description of Support Units

The EUT has been tested as an independent unit together with other necessary accessories or support units. The following support units or accessories were used to form a representative test configuration during the tests.

ID	Product	Brand	Model No.	Serial No.	FCC ID	Remarks
A.	Radio Communication Analyzer	Anritsu	MT8821C	6261806803	NA	-

Note:

1. All power cords of the above support units are non-shielded (1.8m).
2. Item A acted as a communication partner to transfer data.

3.3 Test Mode Applicability and Tested Channel Detail

Pre-Scan has been conducted to determine the worst-case mode from all possible combinations between available modulations, data rates, XYZ axis and antenna ports. The worst case was found when positioned on Y-plane (for all test except radiated emission below 1GHz) and X-plane (For radiated emission below 1GHz). Following channel(s) was (were) selected for the final test as listed below:

PCS Mode

EUT Configure Mode	Test Item	Available Channel	Tested Channel	Mode
-	EIRP	512 to 810	512(1850.2MHz), 661(1880.0MHz), 810(1909.8MHz)	PCS, EDGE
-	Modulation characteristics	512 to 810	661(1880.0MHz)	PCS, GPRS, EDGE
-	Frequency Stability	512 to 810	512(1850.2MHz), 810(1909.8MHz)	PCS
-	Occupied Bandwidth	512 to 810	512(1850.2MHz), 661(1880.0MHz), 810(1909.8MHz)	PCS, GPRS, EDGE
-	Band Edge	512 to 810	512(1850.2MHz), 810(1909.8MHz)	PCS, GPRS, EDGE
-	Peak To Average Ratio	512 to 810	512(1850.2MHz), 661(1880.0MHz), 810(1909.8MHz)	PCS, GPRS, EDGE
-	Conducted Emission	512 to 810	512(1850.2MHz), 661(1880.0MHz), 810(1909.8MHz)	PCS, GPRS, EDGE
-	Radiated Emission Below 1GHz	512 to 810	661(1880.0MHz)	PCS
-	Radiated Emission Above 1GHz	512 to 810	512(1850.2MHz), 661(1880.0MHz), 810(1909.8MHz)	PCS

Note:

1. For radiated emission below 1GHz, select the worst radiated emission (above 1GHz) channel for final testing.
2. According EIRP power test, pre-tested PCS, EDGE modulation type and found PCS was the worst. For radiated emission test, pre-tested PCS, EDGE modulation type and found PCS was the worst, therefore chosen for the final test.

WCDMA Band 2

EUT Configure Mode	Test Item	Available Channel	Tested Channel	Mode
-	EIRP	9262 to 9538	9262 (1852.4MHz), 9400 (1880.0MHz), 9538 (1907.6MHz)	WCDMA
-	Modulation Characteristics	9262 to 9538	9400 (1880.0MHz)	WCDMA, HSDPA, HSUPA
-	Frequency Stability	9262 to 9538	9262 (1852.4MHz), 9538 (1907.6MHz)	WCDMA
-	Occupied Bandwidth	9262 to 9538	9262 (1852.4MHz), 9400 (1880.0MHz), 9538 (1907.6MHz)	WCDMA, HSDPA, HSUPA
-	Band Edge	9262 to 9538	9262 (1852.4MHz), 9538 (1907.6MHz)	WCDMA, HSDPA, HSUPA
-	Peak To Average Ratio	9262 to 9538	9262 (1852.4MHz), 9400 (1880.0MHz), 9538 (1907.6MHz)	WCDMA, HSDPA, HSUPA
-	Conducted Emission	9262 to 9538	9262 (1852.4MHz), 9400 (1880.0MHz), 9538 (1907.6MHz)	WCDMA, HSDPA, HSUPA
-	Radiated Emission Below 1GHz	9262 to 9538	9262 (1852.4MHz)	WCDMA
-	Radiated Emission Above 1GHz	9262 to 9538	9262 (1852.4MHz), 9400 (1880.0MHz), 9538 (1907.6MHz)	WCDMA

Note: For radiated emission below 1GHz, select the worst radiated emission (above 1GHz) channel for final testing.

LTE Band 2

EUT Configure Mode	Test item	Available channel	Tested Channel	Channel Bandwidth	Modulation	Mode
-	EIRP	18607 to 19193	18607 (1850.70MHz), 18900 (1880.00MHz), 19193 (1909.30MHz)	1.4MHz	QPSK / 16QAM / 64QAM	3 RB / 0 RB Offset
		18615 to 19185	18615 (1851.50MHz), 18900 (1880.00MHz), 19185 (1908.50MHz)	3MHz	QPSK / 16QAM / 64QAM	1 RB / 0 RB Offset
		18625 to 19175	18625 (1852.50MHz), 18900 (1880.00MHz), 19175 (1907.50MHz)	5MHz	QPSK / 16QAM / 64QAM	1 RB / 0 RB Offset
		18650 to 19150	18650 (1855.00MHz), 18900 (1880.00MHz), 19150 (1905.00MHz)	10MHz	QPSK / 16QAM / 64QAM	1 RB / 0 RB Offset
		18675 to 19125	18675 (1857.50MHz), 18900 (1880.00MHz), 19125 (1902.50MHz)	15MHz	QPSK / 16QAM / 64QAM	1 RB / 0 RB Offset
		18700 to 19100	18700 (1860.00MHz), 18900 (1880.00MHz), 19100 (1900.00MHz)	20MHz	QPSK / 16QAM / 64QAM	1 RB / 0 RB Offset
-	Modulation Characteristics	18700 to 19100	18900 (1880.00MHz)	20MHz	QPSK / 16QAM / 64QAM	100 RB / 0 RB Offset
-	Frequency Stability	18607 to 19193	18607 (1850.70MHz), 19193 (1909.30MHz)	1.4MHz	QPSK	6 RB / 0 RB Offset
		18615 to 19185	18615 (1851.50MHz), 19185 (1908.50MHz)	3MHz	QPSK	15 RB / 0 RB Offset
		18625 to 19175	18625 (1852.50MHz), 19175 (1907.50MHz)	5MHz	QPSK	25 RB / 0 RB Offset
		18650 to 19150	18650 (1855.00MHz), 19150 (1905.00MHz)	10MHz	QPSK	50 RB / 0 RB Offset
		18675 to 19125	18675 (1857.50MHz), 19125 (1902.50MHz)	15MHz	QPSK	75 RB / 0 RB Offset
		18700 to 19100	18700 (1860.00MHz), 19100 (1900.00MHz)	20MHz	QPSK	100 RB / 0 RB Offset

EUT Configure Mode	Test item	Available channel	Tested Channel	Channel Bandwidth	Modulation	Mode
-	Occupied Bandwidth	18607 to 19193	18607 (1850.70MHz), 18900 (1880.00MHz), 19193 (1909.30MHz)	1.4MHz	QPSK / 16QAM / 64QAM	6 RB / 0 RB Offset
		18615 to 19185	18615 (1851.50MHz), 18900 (1880.00MHz), 19185 (1908.50MHz)	3MHz	QPSK / 16QAM / 64QAM	15 RB / 0 RB Offset
		18625 to 19175	18625 (1852.50MHz), 18900 (1880.00MHz), 19175 (1907.50MHz)	5MHz	QPSK / 16QAM / 64QAM	25 RB / 0 RB Offset
		18650 to 19150	18650 (1855.00MHz), 18900 (1880.00MHz), 19150 (1905.00MHz)	10MHz	QPSK / 16QAM / 64QAM	50 RB / 0 RB Offset
		18675 to 19125	18675 (1857.50MHz), 18900 (1880.00MHz), 19125 (1902.50MHz)	15MHz	QPSK / 16QAM / 64QAM	75 RB / 0 RB Offset
		18700 to 19100	18700 (1860.00MHz), 18900 (1880.00MHz), 19100 (1900.00MHz)	20MHz	QPSK / 16QAM / 64QAM	100 RB / 0 RB Offset
-	Band Edge	18607 to 19193	18607 (1850.70MHz), 19193 (1909.30MHz)	1.4MHz	QPSK	1 RB / 0 RB Offset 1 RB / 5 RB Offset 6 RB / 0 RB Offset
		18615 to 19185	18615 (1851.50MHz), 19185 (1908.50MHz)	3MHz	QPSK	1 RB / 0 RB Offset 1 RB / 14 RB Offset 15 RB / 0 RB Offset
		18625 to 19175	18625 (1852.50MHz), 19175 (1907.50MHz)	5MHz	QPSK	1 RB / 0 RB Offset 1 RB / 24 RB Offset 25 RB / 0 RB Offset
		18650 to 19150	18650 (1855.00MHz), 19150 (1905.00MHz)	10MHz	QPSK	1 RB / 0 RB Offset 1 RB / 49 RB Offset 50 RB / 0 RB Offset
		18675 to 19125	18675 (1857.50MHz), 19125 (1902.50MHz)	15MHz	QPSK	1 RB / 0 RB Offset 1 RB / 74 RB Offset 75 RB / 0 RB Offset
		18700 to 19100	18700 (1860.00MHz), 19100 (1900.00MHz)	20MHz	QPSK	1 RB / 0 RB Offset 1 RB / 99 RB Offset 100 RB / 0 RB Offset
-	Peak to Average Ratio	18607 to 19193	18607 (1850.70MHz), 18900 (1880.00MHz), 19193 (1909.30MHz)	1.4MHz	QPSK / 16QAM / 64QAM	3 RB / 0 RB Offset
		18615 to 19185	18615 (1851.50MHz), 18900 (1880.00MHz), 19185 (1908.50MHz)	3MHz	QPSK / 16QAM / 64QAM	1 RB / 0 RB Offset
		18625 to 19175	18625 (1852.50MHz), 18900 (1880.00MHz), 19175 (1907.50MHz)	5MHz	QPSK / 16QAM / 64QAM	1 RB / 0 RB Offset
		18650 to 19150	18650 (1855.00MHz), 18900 (1880.00MHz), 19150 (1905.00MHz)	10MHz	QPSK / 16QAM / 64QAM	1 RB / 0 RB Offset
		18675 to 19125	18675 (1857.50MHz), 18900 (1880.00MHz), 19125 (1902.50MHz)	15MHz	QPSK / 16QAM / 64QAM	1 RB / 0 RB Offset
		18700 to 19100	18700 (1860.00MHz), 18900 (1880.00MHz), 19100 (1900.00MHz)	20MHz	QPSK / 16QAM / 64QAM	1 RB / 0 RB Offset

EUT Configure Mode	Test item	Available channel	Tested Channel	Channel Bandwidth	Modulation	Mode
-	Conducted Emission	18607 to 19193	18607 (1850.70MHz), 18900 (1880.00MHz), 19193 (1909.30MHz)	1.4MHz	QPSK	3 RB / 0 RB Offset
		18615 to 19185	18615 (1851.50MHz), 18900 (1880.00MHz), 19185 (1908.50MHz)	3MHz	QPSK	1 RB / 0 RB Offset
		18625 to 19175	18625 (1852.50MHz), 18900 (1880.00MHz), 19175 (1907.50MHz)	5MHz	QPSK	1 RB / 0 RB Offset
		18650 to 19150	18650 (1855.00MHz), 18900 (1880.00MHz), 19150 (1905.00MHz)	10MHz	QPSK	1 RB / 0 RB Offset
		18675 to 19125	18675 (1857.50MHz), 18900 (1880.00MHz), 19125 (1902.50MHz)	15MHz	QPSK	1 RB / 0 RB Offset
		18700 to 19100	18700 (1860.00MHz), 18900 (1880.00MHz), 19100 (1900.00MHz)	20MHz	QPSK	1 RB / 0 RB Offset
-	Radiated Emission Below 1GHz	18607 to 19193	19193 (1909.30MHz)	1.4MHz	QPSK	3 RB / 0 RB Offset
-	Radiated Emission Above 1GHz	18607 to 19193	18607 (1850.70MHz), 18900 (1880.00MHz), 19193 (1909.30MHz)	1.4MHz	QPSK	3 RB / 0 RB Offset
		18625 to 19175	18625 (1852.50MHz), 18900 (1880.00MHz), 19175 (1907.50MHz)	5MHz	QPSK	1 RB / 0 RB Offset
		18700 to 19100	18700 (1860.00MHz), 18900 (1880.00MHz), 19100 (1900.00MHz)	20MHz	QPSK	1 RB / 0 RB Offset

Note:

1. For radiated emission below 1GHz, select the worst radiated emission (above 1GHz) channel for final testing.
2. For radiated emission above 1GHz, according to 3GPP 36.521 Section 6.6.3.1.4, choose the lowest, 5MHz & highest channel bandwidth for final test.
3. The conducted output power for QPSK, 16QAM and 64QAM, measured value of QPSK is higher than 16QAM and 64QAM mode. Therefore, only EIRP, occupied bandwidth and Peak to average ratio items had been tested under QPSK, 16QAM and 64QAM modes, the other test items were performed under QPSK mode only.

LTE Band 25

EUT Configure Mode	Test item	Available channel	Tested Channel	Channel Bandwidth	Modulation	Mode
-	EIRP	26047 to 26683	26047 (1850.7MHz), 26365 (1882.5MHz), 26683 (1914.3MHz)	1.4MHz	QPSK / 16QAM / 64QAM	3 RB / 1 RB Offset
		26055 to 26675	26055 (1851.5MHz), 26365 (1882.5MHz), 26675 (1913.5MHz)	3MHz	QPSK / 16QAM / 64QAM	1 RB / 7 RB Offset
		26065 to 26665	26065 (1852.5MHz), 26365 (1882.5MHz), 26665 (1912.5MHz)	5MHz	QPSK / 16QAM / 64QAM	1 RB / 0 RB Offset
		26090 to 26640	26090 (1855.0MHz), 26365 (1882.5MHz), 26640 (1910.0MHz)	10MHz	QPSK / 16QAM / 64QAM	1 RB / 0 RB Offset
		26115 to 26615	26115 (1857.5MHz), 26365 (1882.5MHz), 26615 (1907.5MHz)	15MHz	QPSK / 16QAM / 64QAM	1 RB / 0 RB Offset
		26140 to 26590	26140 (1860.0MHz), 26365 (1882.5MHz), 26590 (1905.0MHz)	20MHz	QPSK / 16QAM / 64QAM	1 RB / 0 RB Offset
-	Modulation Characteristics	26065 to 26665	26365 (1882.5MHz)	20MHz	QPSK / 16QAM / 64QAM	100 RB / 0 RB Offset
-	Frequency Stability	26047 to 26683	26047 (1850.7MHz), 26683 (1914.3MHz)	1.4MHz	QPSK	6 RB / 0 RB Offset
		26055 to 26675	26055 (1851.5MHz), 26675 (1913.5MHz)	3MHz	QPSK	15 RB / 0 RB Offset
		26065 to 26665	26065 (1852.5MHz), 26665 (1912.5MHz)	5MHz	QPSK	25 RB / 0 RB Offset
		26090 to 26640	26090 (1855.0MHz), 26640 (1910.0MHz)	10MHz	QPSK	50 RB / 0 RB Offset
		26115 to 26615	26115 (1857.5MHz), 26615 (1907.5MHz)	15MHz	QPSK	75 RB / 0 RB Offset
		26140 to 26590	26140 (1860.0MHz), 26590 (1905.0MHz)	20MHz	QPSK	100 RB / 0 RB Offset
-	Occupied Bandwidth	26047 to 26683	26047 (1850.7MHz), 26365 (1882.5MHz), 26683 (1914.3MHz)	1.4MHz	QPSK / 16QAM / 64QAM	6 RB / 0 RB Offset
		26055 to 26675	26055 (1851.5MHz), 26365 (1882.5MHz), 26675 (1913.5MHz)	3MHz	QPSK / 16QAM / 64QAM	15 RB / 0 RB Offset
		26065 to 26665	26065 (1852.5MHz), 26365 (1882.5MHz), 26665 (1912.5MHz)	5MHz	QPSK / 16QAM / 64QAM	25 RB / 0 RB Offset
		26090 to 26640	26090 (1855.0MHz), 26365 (1882.5MHz), 26640 (1910.0MHz)	10MHz	QPSK / 16QAM / 64QAM	50 RB / 0 RB Offset
		26115 to 26615	26115 (1857.5MHz), 26365 (1882.5MHz), 26615 (1907.5MHz)	15MHz	QPSK / 16QAM / 64QAM	75 RB / 0 RB Offset
		26140 to 26590	26140 (1860.0MHz), 26365 (1882.5MHz), 26590 (1905.0MHz)	20MHz	QPSK / 16QAM / 64QAM	100 RB / 0 RB Offset

EUT Configure Mode	Test item	Available channel	Tested Channel	Channel Bandwidth	Modulation	Mode
-	Band Edge	26047 to 26683	26047 (1850.7MHz), 26683 (1914.3MHz)	1.4MHz	QPSK	1 RB / 0 RB Offset 1 RB / 5 RB Offset 6 RB / 0 RB Offset
		26055 to 26675	26055 (1851.5MHz), 26675 (1913.5MHz)	3MHz	QPSK	1 RB / 0 RB Offset 1 RB / 14 RB Offset 15 RB / 0 RB Offset
		26065 to 26665	26065 (1852.5MHz), 26665 (1912.5MHz)	5MHz	QPSK	1 RB / 0 RB Offset 1 RB / 24 RB Offset 25 RB / 0 RB Offset
		26090 to 26640	26090 (1855.0MHz), 26640 (1910.0MHz)	10MHz	QPSK	1 RB / 0 RB Offset 1 RB / 49 RB Offset 50 RB / 0 RB Offset
		26115 to 26615	26115 (1857.5MHz), 26615 (1907.5MHz)	15MHz	QPSK	1 RB / 0 RB Offset 1 RB / 74 RB Offset 75 RB / 0 RB Offset
		26140 to 26590	26140 (1860.0MHz), 26590 (1905.0MHz)	20MHz	QPSK	1 RB / 0 RB Offset 1 RB / 99 RB Offset 100 RB / 0 RB Offset
-	Peak to Average Ratio	26047 to 26683	26047 (1850.7MHz), 26365 (1882.5MHz), 26683 (1914.3MHz)	1.4MHz	QPSK / 16QAM / 64QAM	3 RB / 1 RB Offset
		26055 to 26675	26055 (1851.5MHz), 26365 (1882.5MHz), 26675 (1913.5MHz)	3MHz	QPSK / 16QAM / 64QAM	1 RB / 7 RB Offset
		26065 to 26665	26065 (1852.5MHz), 26365 (1882.5MHz), 26665 (1912.5MHz)	5MHz	QPSK / 16QAM / 64QAM	1 RB / 0 RB Offset
		26090 to 26640	26090 (1855.0MHz), 26365 (1882.5MHz), 26640 (1910.0MHz)	10MHz	QPSK / 16QAM / 64QAM	1 RB / 0 RB Offset
		26115 to 26615	26115 (1857.5MHz), 26365 (1882.5MHz), 26615 (1907.5MHz)	15MHz	QPSK / 16QAM / 64QAM	1 RB / 0 RB Offset
		26140 to 26590	26140 (1860.0MHz), 26365 (1882.5MHz), 26590 (1905.0MHz)	20MHz	QPSK / 16QAM / 64QAM	1 RB / 0 RB Offset
-	Conducted Emission	26047 to 26683	26047 (1850.7MHz), 26365 (1882.5MHz), 26683 (1914.3MHz)	1.4MHz	QPSK	3 RB / 1 RB Offset
		26055 to 26675	26055 (1851.5MHz), 26365 (1882.5MHz), 26675 (1913.5MHz)	3MHz	QPSK	1 RB / 7 RB Offset
		26065 to 26665	26065 (1852.5MHz), 26365 (1882.5MHz), 26665 (1912.5MHz)	5MHz	QPSK	1 RB / 0 RB Offset
		26090 to 26640	26090 (1855.0MHz), 26365 (1882.5MHz), 26640 (1910.0MHz)	10MHz	QPSK	1 RB / 0 RB Offset
		26115 to 26615	26115 (1857.5MHz), 26365 (1882.5MHz), 26615 (1907.5MHz)	15MHz	QPSK	1 RB / 0 RB Offset
		26140 to 26590	26140 (1860.0MHz), 26365 (1882.5MHz), 26590 (1905.0MHz)	20MHz	QPSK	1 RB / 0 RB Offset
-	Radiated Emission Below 1GHz	26140 to 26590	26365 (1882.5MHz)	20MHz	QPSK	1 RB / 0 RB Offset
-	Radiated Emission Above 1GHz	26047 to 26683	26047 (1850.7MHz), 26365 (1882.5MHz), 26683 (1914.3MHz)	1.4MHz	QPSK	3 RB / 1 RB Offset
		26065 to 26665	26065 (1852.5MHz), 26365 (1882.5MHz), 26665 (1912.5MHz)	5MHz	QPSK	1 RB / 0 RB Offset
		26140 to 26590	26140 (1860.0MHz), 26365 (1882.5MHz), 26590 (1905.0MHz)	20MHz	QPSK	1 RB / 0 RB Offset

Note:

1. For radiated emission below 1GHz, low, mid and high channels were pre-tested in chamber. Mid channel was the worst case for all final tests.
2. The conducted output power for QPSK, 16QAM and 64QAM, measured value of QPSK is higher than 16QAM mode. Therefore, Occupied bandwidth and Peak to average ratio items were tested under QPSK, 16QAM and 64QAM modes, and the other test items were tested under QPSK mode only.

Test Condition:

Test Item	Environmental Conditions	Input Power	Tested By
EIRP	25deg. C, 70%RH	120Vac, 60Hz	James Yang
Modulation Characteristics	24deg. C, 64%RH	120Vac, 60Hz	James Yang
Frequency Stability	24deg. C, 64%RH	3.28Vdc	James Yang
Occupied Bandwidth	24deg. C, 64%RH	120Vac, 60Hz	James Yang
Band Edge	24deg. C, 64%RH	120Vac, 60Hz	James Yang
Peak To Average Ratio	24deg. C, 64%RH	120Vac, 60Hz	James Yang
Conducted Emission	24deg. C, 64%RH	120Vac, 60Hz	James Yang
Radiated Emission	22deg. C, 66%RH	120Vac, 60Hz	Greg Lin, Han Wu

3.4 EUT Operating Conditions

The EUT makes a call to the communication simulator. The communication simulator station system controlled a EUT to export maximum output power under transmission mode and specific channel frequency

3.5 General Description of Applied Standards and References

The EUT is a RF Product. According to the specifications of the manufacturer, it must comply with the requirements of the following standards and References:

Test Standard:

FCC 47 CFR Part 2
FCC 47 CFR Part 24
ANSI/TIA/EIA-603-E 2016
ANSI 63.26-2015

All test items have been performed and recorded as per the above standards.

References Test Guidance:

KDB 971168 D01 Power Meas License Digital Systems v03r01

All test items have been performed as a reference to the above KDB test guidance.

4 Test Types and Results

4.1 Output Power Measurement

4.1.1 Limits of Output Power Measurement

Mobile / Portable station are limited to 2 watts e.r.p.

4.1.2 Test Procedures

EIRP / ERP Measurement:

- a. All measurements were done at low, middle and high operational frequency range. RBW is 1MHz for PCS/GPRS/EDGE, 5MHz for WCDMA mode and 5MHz, 10MHz, 15MHz, 20MHz for LTE mode, and VBW $\geq 3 \times$ RBW.
- b. Substitution method is used for E.I.R.P measurement. In the semi-anechoic chamber, EUT placed on the 0.8m(below or equal 1GHz) and/or 1.5m(above 1GHz) height of Turn Table, rotated the table around 360 degrees to search the maximum radiation power and receiver antenna shall be rotated vertical and horizontal polarization and moved height from 1m to 4m to find the maximum polar radiated power. The "Read Value" is the spectrum reading the maximum power value.
- c. The substitution horn antenna is substituted for EUT at the same position and signals generator export the CW signal to the substitution antenna via a TX cable. Rotated the Turn Table and moved receiving antenna to find the maximum radiation power. Adjust output power level of S.G to get a Value of spectrum reading equal to "Read Value" of step b. Record the power level of S.G
- d. EIRP = Output power level of S.G – TX cable loss + Antenna gain of substitution horn.E.R.P power can be calculated form E.I.R.P power by subtracting the gain of dipole, E.R.P power = E.I.R.P power - 2.15dBi.

Where:

$$\text{ERP/EIRP} = P_{\text{Meas}} + G_T - L_C$$

P_{Meas} : Measure transmitter output power.

G_T : Gain of the transmitting antenna.

L_C : signal attenuation in the connecting cable between the transmitter and antenna.

Conducted Power Measurement:

The EUT was set up for the maximum power with PCS, WCDMA and LTE link data modulation and link up with simulator. Set the EUT to transmit under low, middle and high channel and record the power level shown on simulator.

4.1.3 Test Setup

EIRP / ERP Measurement:

For radiated emission 30MHz to 1GHz

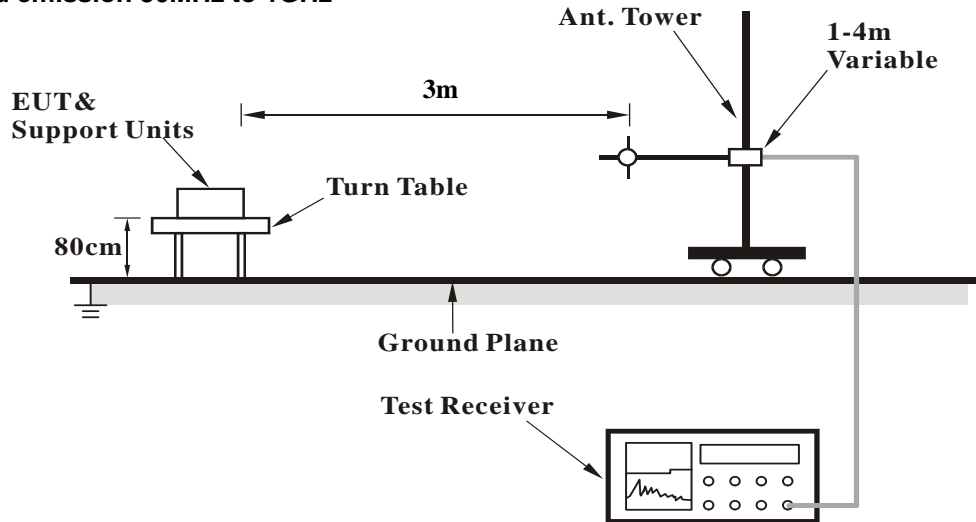

For radiated emission above 1GHz

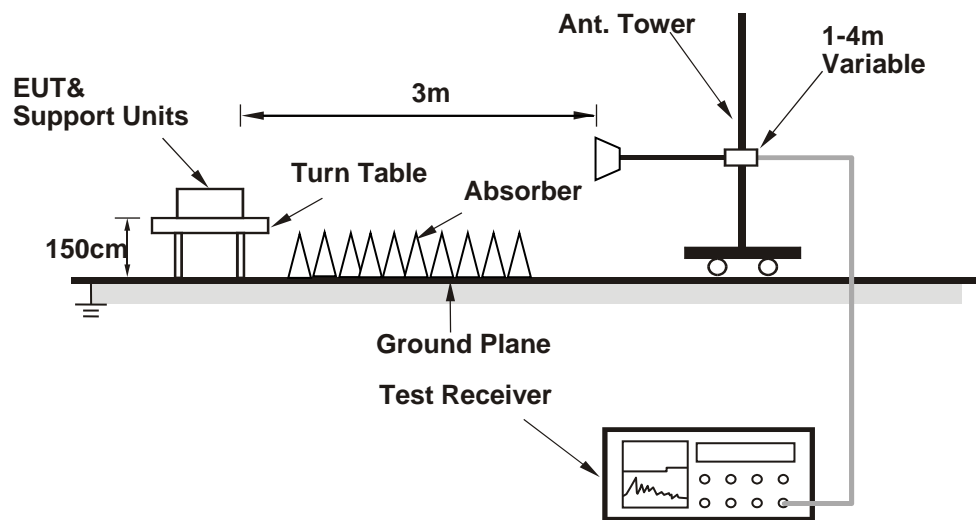

For the actual test configuration, please refer to the attached file (Test Setup Photo).

Conducted Power Measurement:



For the actual test configuration, please refer to the attached file (Test Setup Photo).

4.1.4 Test Results

Conducted Output Power (dBm)

Band	PCS1900		
Channel	512	661	810
Frequency	1850.2	1880	1909.8
PCS	29.60	29.79	29.59
GPRS 1Tx Slot	29.50	29.68	29.49
GPRS 2Tx Slot	28.42	28.60	28.41
GPRS 3Tx Slot	26.73	26.91	26.72
GPRS 4Tx Slot	24.82	25.00	24.81
EDGE 1Tx Slot (MCS9)	25.86	26.04	25.85
EDGE 2Tx Slot (MCS9)	24.30	24.48	24.29
EDGE 3Tx Slot (MCS9)	21.81	21.99	21.80
EDGE 4Tx Slot (MCS9)	21.28	21.46	21.27

Band	WCDMA II		
Channel	9262	9400	9538
Frequency	1852.4	1880	1907.6
RMC 12.2K	23.32	23.35	23.37
HSDPA Subtest-1	22.31	22.36	22.42
HSDPA Subtest-2	22.33	22.38	22.43
HSDPA Subtest-3	21.85	21.89	21.89
HSDPA Subtest-4	21.86	21.87	21.91
DC-HSDPA Subtest-1	22.26	22.31	22.37
DC-HSDPA Subtest-2	22.29	22.33	22.38
DC-HSDPA Subtest-3	21.80	21.85	21.86
DC-HSDPA Subtest-4	21.81	21.82	21.86
HSUPA Subtest-1	22.28	22.35	22.37
HSUPA Subtest-2	20.25	20.36	20.38
HSUPA Subtest-3	21.31	21.35	21.37
HSUPA Subtest-4	20.28	20.33	20.35
HSUPA Subtest-5	22.31	22.41	22.42

LTE Band 2						
BW	MCS Index	RB Size	RB Offset	Low	Mid	High
		Channel		18607	18900	19193
		Frequency (MHz)		1850.7	1880	1909.3
1.4M	QPSK	1	0	22.98	22.83	22.97
		1	2	22.90	22.85	22.73
		1	5	22.92	22.92	22.79
		3	0	22.90	22.99	23.01
		3	1	22.96	22.90	22.86
		3	3	22.87	22.98	22.79
		6	0	21.89	21.96	21.97
	16QAM	1	0	21.86	21.96	21.85
		1	2	21.96	21.94	21.82
		1	5	21.90	21.85	21.76
		3	0	21.85	21.92	21.82
		3	1	21.84	21.81	21.86
		3	3	21.93	21.98	21.90
		6	0	20.89	21.00	20.81
	64QAM	1	0	21.04	21.06	20.97
		1	2	20.97	20.95	21.01
		1	5	20.95	21.05	20.91
		3	0	20.97	20.91	20.92
		3	1	20.92	21.00	20.96
		3	3	20.87	20.82	20.85
		6	0	19.90	19.94	19.89

LTE Band 2						
BW	MCS Index	Channel		18615	18900	19185
		Frequency (MHz)		1851.5	1880	1908.5
3M	QPSK	1	0	22.99	22.89	22.93
		1	7	22.86	22.85	22.84
		1	14	22.86	22.78	22.85
		8	0	21.92	21.97	21.94
		8	3	21.99	21.97	22.00
		8	7	21.82	21.88	21.84
		15	0	21.94	21.98	21.93
	16QAM	1	0	22.00	21.97	21.94
		1	7	21.88	21.89	21.80
		1	14	21.91	21.87	21.85
		8	0	20.89	20.82	20.88
		8	3	20.80	20.94	20.75
		8	7	20.85	20.81	20.72
		15	0	20.83	20.84	20.73
	64QAM	1	0	20.95	20.96	20.81
		1	7	20.85	20.98	20.85
		1	14	20.86	20.87	20.86
		8	0	19.90	19.97	19.91
		8	3	20.00	19.87	19.91
		8	7	19.97	19.90	19.77
		15	0	19.80	19.94	19.82

LTE Band 2						
BW	MCS Index	Channel		18625	18900	19175
		Frequency (MHz)		1852.5	1880	1907.5
5M	QPSK	1	0	22.94	22.88	22.69
		1	12	22.74	22.82	22.86
		1	24	22.70	22.88	22.71
		12	0	21.90	22.07	21.88
		12	6	21.96	21.97	21.67
		12	13	21.83	22.03	21.68
		25	0	22.00	21.97	21.82
	16QAM	1	0	21.94	21.90	21.83
		1	12	21.96	21.85	21.90
		1	24	21.98	21.84	21.76
		12	0	20.85	20.92	20.85
		12	6	20.86	20.91	20.76
		12	13	20.78	20.84	20.75
		25	0	20.90	20.81	20.78
	64QAM	1	0	20.91	21.05	20.96
		1	12	21.05	21.04	20.93
		1	24	20.84	21.09	20.87
		12	0	19.89	19.94	19.92
		12	6	19.85	20.00	19.98
		12	13	19.95	19.87	19.84
		25	0	19.81	19.85	19.81

LTE Band 2						
BW	MCS Index	Channel		18650	18900	19150
		Frequency (MHz)		1855	1880	1905
10M	QPSK	1	0	22.87	22.80	22.89
		1	24	22.73	22.94	22.77
		1	49	22.77	22.81	22.79
		25	0	21.93	22.03	21.82
		25	12	21.91	22.01	21.84
		25	25	21.86	22.01	21.88
		50	0	21.96	21.92	21.89
	16QAM	1	0	21.90	21.92	21.90
		1	24	21.79	21.91	21.84
		1	49	21.74	21.84	21.86
		25	0	20.87	20.80	20.85
		25	12	20.86	20.82	20.79
		25	25	20.81	20.81	20.77
		50	0	20.87	20.92	20.84
	64QAM	1	0	21.02	21.00	20.90
		1	24	20.99	21.05	20.96
		1	49	20.89	21.05	20.78
		25	0	19.90	19.92	19.86
		25	12	19.95	19.97	19.94
		25	25	19.79	19.86	19.89
		50	0	20.02	19.96	19.90

LTE Band 2						
BW	MCS Index	Channel		18675	18900	19125
		Frequency (MHz)		1857.5	1880	1902.5
15M	QPSK	1	0	22.98	22.98	22.93
		1	37	22.96	22.91	22.91
		1	74	22.90	22.97	22.85
		36	0	22.00	22.02	21.95
		36	19	22.05	22.08	21.93
		36	39	21.92	21.98	21.92
		75	0	21.98	22.05	21.89
	16QAM	1	0	21.96	22.01	21.97
		1	37	21.92	21.94	21.92
		1	74	21.92	21.96	21.86
		36	0	20.97	21.03	20.86
		36	19	20.90	21.00	20.85
		36	39	20.89	20.88	20.91
		75	0	20.94	20.94	20.93
	64QAM	1	0	20.99	21.11	20.98
		1	37	20.99	21.05	20.97
		1	74	21.00	21.01	20.93
		36	0	20.00	20.05	19.98
		36	19	20.04	19.98	19.98
		36	39	19.93	20.05	19.97
		75	0	19.97	19.97	19.93

LTE Band 2						
BW	MCS Index	Channel		18700	18900	19100
		Frequency (MHz)		1860	1880	1900
20M	QPSK	1	0	23.02	23.05	22.98
		1	50	22.96	22.99	22.92
		1	99	22.95	22.98	22.91
		50	0	22.08	22.11	22.04
		50	25	22.05	22.08	22.01
		50	50	22.02	22.05	21.98
		100	0	22.03	22.06	21.99
	16QAM	1	0	22.05	22.08	22.01
		1	50	21.99	22.02	21.95
		1	99	21.98	22.01	21.94
		50	0	21.00	21.03	20.96
		50	25	20.98	21.01	20.94
		50	50	20.95	20.98	20.91
		100	0	20.99	21.02	20.95
	64QAM	1	0	21.09	21.12	21.05
		1	50	21.08	21.11	21.04
		1	99	21.06	21.09	21.02
		50	0	20.06	20.09	20.02
		50	25	20.05	20.08	20.01
		50	50	20.02	20.05	19.98
		100	0	20.03	20.06	19.99

LTE Band 25						
BW	MCS Index	RB Size	RB Offset	Low	Mid	High
		Channel		26047	26365	26683
		Frequency (MHz)		1850.7	1882.5	1914.3
1.4M	QPSK	1	0	22.91	23.05	23.06
		1	2	22.91	23.08	22.88
		1	5	22.91	22.97	23.03
		3	0	23.07	23.11	22.98
		3	1	23.02	23.17	23.01
		3	3	23.02	23.07	23.02
		6	0	22.06	22.11	21.96
	16QAM	1	0	22.08	22.27	22.10
		1	2	22.19	22.21	22.18
		1	5	22.08	22.23	22.22
		3	0	22.03	22.06	22.09
		3	1	22.00	22.14	22.03
		3	3	22.02	22.11	22.04
		6	0	20.90	21.00	21.05
	64QAM	1	0	21.13	21.26	21.17
		1	2	21.13	21.22	21.18
		1	5	21.13	21.12	21.12
		3	0	21.08	21.25	21.19
		3	1	20.98	21.27	21.16
		3	3	21.05	21.19	20.98
		6	0	19.92	19.99	20.00

LTE Band 25						
BW	MCS Index	Channel		26055	26365	26675
		Frequency (MHz)		1851.5	1882.5	1913.5
3M	QPSK	1	0	22.93	23.00	22.94
		1	7	22.89	23.03	23.03
		1	14	22.91	22.89	22.96
		8	0	22.03	22.25	22.11
		8	3	21.98	22.03	22.05
		8	7	21.94	22.13	22.03
		15	0	22.03	21.99	22.03
	16QAM	1	0	22.09	22.32	22.26
		1	7	22.25	22.26	22.17
		1	14	22.17	22.21	22.15
		8	0	20.92	21.08	21.06
		8	3	21.05	20.98	21.03
		8	7	20.96	21.13	21.04
		15	0	20.90	20.94	21.06
	64QAM	1	0	21.11	21.30	21.27
		1	7	21.15	21.27	21.12
		1	14	21.10	21.11	20.96
		8	0	20.19	20.16	20.20
		8	3	20.14	20.24	20.14
		8	7	20.16	20.13	20.00
		15	0	20.03	20.12	20.10

LTE Band 25						
BW	MCS Index	Channel		26065	26365	26665
		Frequency (MHz)		1852.5	1882.5	1912.5
5M	QPSK	1	0	22.96	23.05	23.06
		1	12	23.02	22.97	22.95
		1	24	22.87	23.02	22.88
		12	0	22.02	22.11	21.98
		12	6	22.12	22.10	21.99
		12	13	21.96	22.10	21.87
		25	0	21.93	22.18	22.04
	16QAM	1	0	22.18	22.26	22.30
		1	12	22.16	22.25	22.21
		1	24	22.13	22.31	22.17
		12	0	21.00	21.11	21.12
		12	6	20.98	21.12	20.95
		12	13	21.00	21.16	20.97
		25	0	20.96	20.99	20.96
	64QAM	1	0	21.13	21.35	21.32
		1	12	21.12	21.09	21.06
		1	24	20.97	21.25	21.01
		12	0	20.04	20.14	20.16
		12	6	20.18	20.15	20.13
		12	13	20.03	20.23	20.06
		25	0	19.96	20.02	20.04

LTE Band 25						
BW	MCS Index	Channel		26090	26365	26640
		Frequency (MHz)		1855	1882.5	1910
10M	QPSK	1	0	22.91	23.11	23.07
		1	24	23.00	22.98	23.02
		1	49	22.93	22.93	22.93
		25	0	22.07	22.15	22.01
		25	12	22.09	22.22	22.13
		25	25	22.09	22.11	21.95
		50	0	22.08	22.12	22.08
	16QAM	1	0	22.25	22.25	22.14
		1	24	22.16	22.20	22.08
		1	49	22.03	22.30	22.08
		25	0	20.94	21.11	20.98
		25	12	20.98	21.06	21.06
		25	25	20.97	21.11	20.96
		50	0	20.94	21.05	21.01
	64QAM	1	0	21.11	21.36	21.30
		1	24	21.20	21.26	21.17
		1	49	21.05	21.18	21.04
		25	0	20.17	20.17	20.20
		25	12	20.09	20.22	20.09
		25	25	19.99	20.27	20.03
		50	0	19.95	20.13	19.93

LTE Band 25						
BW	MCS Index	Channel		26115	26365	26615
		Frequency (MHz)		1857.5	1882.5	1907.5
15M	QPSK	1	0	23.07	23.21	23.07
		1	37	22.96	23.07	23.02
		1	74	23.02	23.11	23.05
		36	0	22.17	22.25	22.13
		36	19	22.05	22.18	22.16
		36	39	22.06	22.18	22.13
		75	0	22.05	22.13	22.11
	16QAM	1	0	22.25	22.29	22.28
		1	37	22.21	22.35	22.24
		1	74	22.23	22.24	22.20
		36	0	21.11	21.15	21.05
		36	19	21.03	21.13	21.09
		36	39	21.00	21.10	21.09
		75	0	20.99	21.11	21.05
	64QAM	1	0	21.25	21.33	21.31
		1	37	21.16	21.26	21.21
		1	74	21.06	21.18	21.11
		36	0	20.17	20.26	20.20
		36	19	20.13	20.30	20.16
		36	39	20.13	20.25	20.14
		75	0	20.06	20.16	20.12

LTE Band 25						
BW	MCS Index	Channel		26140	26365	26590
		Frequency (MHz)		1860	1882.5	1905
20M	QPSK	1	0	23.11	23.21	23.14
		1	50	23.06	23.16	23.09
		1	99	23.03	23.13	23.06
		50	0	22.17	22.27	22.20
		50	25	22.15	22.25	22.18
		50	50	22.11	22.21	22.14
		100	0	22.09	22.19	22.12
	16QAM	1	0	22.29	22.39	22.32
		1	50	22.26	22.36	22.29
		1	99	22.24	22.34	22.27
		50	0	21.12	21.22	21.15
		50	25	21.11	21.21	21.14
		50	50	21.09	21.19	21.12
		100	0	21.07	21.17	21.10
	64QAM	1	0	21.31	21.41	21.34
		1	50	21.23	21.33	21.26
		1	99	21.16	21.26	21.19
		50	0	20.23	20.33	20.26
		50	25	20.21	20.31	20.24
		50	50	20.19	20.29	20.22
		100	0	20.11	20.21	20.14

EIRP Power (dBm)

PCS Mode

MODE		TX channel 512, 611, 810					
Antenna Polarity & Test Distance: Horizontal at 3 M							
No.	Freq. (MHz)	Reading (dBm)	S.G Power Value (dBm)	Correction Factor (dB)	EIRP (dBm)	Limit (dBm)	Margin (dB)
1	1850.20	-19.4	20.8	0.1	20.9	33.0	-12.1
2	1880.00	-19.0	21.5	0.0	21.5	33.0	-11.5
3	1909.80	-19.7	20.9	-0.1	20.8	33.0	-12.2
Antenna Polarity & Test Distance: Vertical at 3 M							
No.	Freq. (MHz)	Reading (dBm)	S.G Power Value (dBm)	Correction Factor (dB)	EIRP (dBm)	Limit (dBm)	Margin (dB)
1	1850.20	-14.5	25.9	0.1	26.0	33.0	-7.0
2	1880.00	-14.2	26.4	0.0	26.4	33.0	-6.6
3	1909.80	-14.6	26.2	-0.1	26.1	33.0	-6.9

Note: EIRP (dBm) = S.G Power Value (dBm) + Correction Factor (dB).

EDGE Mode

MODE		TX channel 512, 611, 810					
Antenna Polarity & Test Distance: Horizontal at 3 M							
No.	Freq. (MHz)	Reading (dBm)	S.G Power Value (dBm)	Correction Factor (dB)	EIRP (dBm)	Limit (dBm)	Margin (dB)
1	1850.20	-22.5	17.7	0.1	17.8	33.0	-15.2
2	1880.00	-22.2	18.3	0.0	18.3	33.0	-14.7
3	1909.80	-23.0	17.6	-0.1	17.5	33.0	-15.5
Antenna Polarity & Test Distance: Vertical at 3 M							
No.	Freq. (MHz)	Reading (dBm)	S.G Power Value (dBm)	Correction Factor (dB)	EIRP (dBm)	Limit (dBm)	Margin (dB)
1	1850.20	-17.5	22.9	0.1	23.0	33.0	-10.0
2	1880.00	-17.3	23.3	0.0	23.3	33.0	-9.7
3	1909.80	-17.6	23.2	-0.1	23.1	33.0	-9.9

Note: EIRP (dBm) = S.G Power Value (dBm) + Correction Factor (dB).

WCDMA Band 2

MODE		TX channel 9262, 9400, 9538					
Antenna Polarity & Test Distance: Horizontal at 3 M							
No.	Freq. (MHz)	Reading (dBm)	S.G Power Value (dBm)	Correction Factor (dB)	EIRP (dBm)	Limit (dBm)	Margin (dB)
1	1852.40	-22.6	17.6	0.1	17.7	33.0	-15.3
2	1880.00	-22.6	17.9	0.0	17.9	33.0	-15.1
3	1907.60	-23.2	17.5	-0.1	17.4	33.0	-15.6
Antenna Polarity & Test Distance: Vertical at 3 M							
No.	Freq. (MHz)	Reading (dBm)	S.G Power Value (dBm)	Correction Factor (dB)	EIRP (dBm)	Limit (dBm)	Margin (dB)
1	1852.40	-18.7	21.7	0.1	21.8	33.0	-11.2
2	1880.00	-18.4	22.2	0.0	22.2	33.0	-10.8
3	1907.60	-19.1	21.7	-0.1	21.6	33.0	-11.4

Note: EIRP (dBm) = S.G Power Value (dBm) + Correction Factor (dB).

Modulation Type: QPSK

LTE Band 2, Channel Bandwidth 1.4MHz

MODE		TX channel 18607, 18900, 19193					
Antenna Polarity & Test Distance: Horizontal at 3 M							
No.	Freq. (MHz)	Reading (dBm)	S.G Power Value (dBm)	Correction Factor (dB)	EIRP (dBm)	Limit (dBm)	Margin (dB)
1	1850.70	-29.5	10.7	0.1	10.8	33.0	-22.2
2	1880.00	-30.0	10.5	0.0	10.5	33.0	-22.5
3	1909.30	-29.2	11.5	-0.1	11.4	33.0	-21.6
Antenna Polarity & Test Distance: Vertical at 3 M							
No.	Freq. (MHz)	Reading (dBm)	S.G Power Value (dBm)	Correction Factor (dB)	EIRP (dBm)	Limit (dBm)	Margin (dB)
1	1850.70	-22.5	17.9	0.1	18.0	33.0	-15.0
2	1880.00	-22.7	17.9	0.0	17.9	33.0	-15.1
3	1909.30	-22.9	17.9	-0.1	17.8	33.0	-15.2

Note: EIRP (dBm) = S.G Power Value (dBm) + Correction Factor (dB).

LTE Band 2, Channel Bandwidth 3MHz

MODE		TX channel 18615, 18900, 19185					
Antenna Polarity & Test Distance: Horizontal at 3 M							
No.	Freq. (MHz)	Reading (dBm)	S.G Power Value (dBm)	Correction Factor (dB)	EIRP (dBm)	Limit (dBm)	Margin (dB)
1	1851.50	-29.5	10.7	0.1	10.8	33.0	-22.2
2	1880.00	-29.7	10.8	0.0	10.8	33.0	-22.2
3	1908.50	-30.0	10.7	-0.1	10.6	33.0	-22.4
Antenna Polarity & Test Distance: Vertical at 3 M							
No.	Freq. (MHz)	Reading (dBm)	S.G Power Value (dBm)	Correction Factor (dB)	EIRP (dBm)	Limit (dBm)	Margin (dB)
1	1851.50	-21.8	18.6	0.1	18.7	33.0	-14.3
2	1880.00	-22.2	18.4	0.0	18.4	33.0	-14.6
3	1908.50	-22.8	18.0	-0.1	17.9	33.0	-15.1

Note: EIRP (dBm) = S.G Power Value (dBm) + Correction Factor (dB).

LTE Band 2, Channel Bandwidth 5MHz

MODE		TX channel 18625, 18900, 19175					
Antenna Polarity & Test Distance: Horizontal at 3 M							
No.	Freq. (MHz)	Reading (dBm)	S.G Power Value (dBm)	Correction Factor (dB)	EIRP (dBm)	Limit (dBm)	Margin (dB)
1	1852.50	-29.2	11.0	0.1	11.1	33.0	-21.9
2	1880.00	-29.3	11.2	0.0	11.2	33.0	-21.8
3	1907.50	-29.4	11.3	-0.1	11.2	33.0	-21.8
Antenna Polarity & Test Distance: Vertical at 3 M							
No.	Freq. (MHz)	Reading (dBm)	S.G Power Value (dBm)	Correction Factor (dB)	EIRP (dBm)	Limit (dBm)	Margin (dB)
1	1852.50	-22.2	18.2	0.1	18.3	33.0	-14.7
2	1880.00	-22.0	18.6	0.0	18.6	33.0	-14.4
3	1907.50	-22.7	18.1	-0.1	18.0	33.0	-15.0

Note: EIRP (dBm) = S.G Power Value (dBm) + Correction Factor (dB).

LTE Band 2, Channel Bandwidth 10MHz

MODE		TX channel 18650, 18900, 19150					
Antenna Polarity & Test Distance: Horizontal at 3 M							
No.	Freq. (MHz)	Reading (dBm)	S.G Power Value (dBm)	Correction Factor (dB)	EIRP (dBm)	Limit (dBm)	Margin (dB)
1	1855.00	-29.5	10.8	0.0	10.8	33.0	-22.2
2	1880.00	-29.4	11.1	0.0	11.1	33.0	-21.9
3	1905.00	-29.3	11.4	-0.1	11.3	33.0	-21.7
Antenna Polarity & Test Distance: Vertical at 3 M							
No.	Freq. (MHz)	Reading (dBm)	S.G Power Value (dBm)	Correction Factor (dB)	EIRP (dBm)	Limit (dBm)	Margin (dB)
1	1855.00	-22.1	18.4	0.0	18.4	33.0	-14.6
2	1880.00	-21.9	18.7	0.0	18.7	33.0	-14.3
3	1905.00	-22.1	18.7	-0.1	18.6	33.0	-14.4

Note: EIRP (dBm) = S.G Power Value (dBm) + Correction Factor (dB).

LTE Band 2, Channel Bandwidth 15MHz

MODE		TX channel 18675, 18900, 19125					
Antenna Polarity & Test Distance: Horizontal at 3 M							
No.	Freq. (MHz)	Reading (dBm)	S.G Power Value (dBm)	Correction Factor (dB)	EIRP (dBm)	Limit (dBm)	Margin (dB)
1	1857.50	-29.7	10.6	0.0	10.6	33.0	-22.4
2	1880.00	-29.5	11.0	0.0	11.0	33.0	-22.0
3	1902.50	-29.2	11.5	-0.1	11.4	33.0	-21.6
Antenna Polarity & Test Distance: Vertical at 3 M							
No.	Freq. (MHz)	Reading (dBm)	S.G Power Value (dBm)	Correction Factor (dB)	EIRP (dBm)	Limit (dBm)	Margin (dB)
1	1857.50	-22.7	17.8	0.0	17.8	33.0	-15.2
2	1880.00	-22.7	17.9	0.0	17.9	33.0	-15.1
3	1902.50	-22.8	18.0	-0.1	17.9	33.0	-15.1

Note: EIRP (dBm) = S.G Power Value (dBm) + Correction Factor (dB).

LTE Band 2, Channel Bandwidth 20MHz

MODE		TX channel 18700, 18900, 19100					
Antenna Polarity & Test Distance: Horizontal at 3 M							
No.	Freq. (MHz)	Reading (dBm)	S.G Power Value (dBm)	Correction Factor (dB)	EIRP (dBm)	Limit (dBm)	Margin (dB)
1	1860.00	-29.4	10.9	0.0	10.9	33.0	-22.1
2	1880.00	-29.1	11.4	0.0	11.4	33.0	-21.6
3	1900.00	-29.6	11.1	-0.1	11.0	33.0	-22.0
Antenna Polarity & Test Distance: Vertical at 3 M							
No.	Freq. (MHz)	Reading (dBm)	S.G Power Value (dBm)	Correction Factor (dB)	EIRP (dBm)	Limit (dBm)	Margin (dB)
1	1860.00	-22.7	17.8	0.0	17.8	33.0	-15.2
2	1880.00	-22.1	18.5	0.0	18.5	33.0	-14.5
3	1900.00	-22.9	17.9	-0.1	17.8	33.0	-15.2

Note: EIRP (dBm) = S.G Power Value (dBm) + Correction Factor (dB).

Modulation Type: 16QAM

LTE Band 2, Channel Bandwidth 1.4MHz

MODE		TX channel 18607, 18900, 19193					
Antenna Polarity & Test Distance: Horizontal at 3 M							
No.	Freq. (MHz)	Reading (dBm)	S.G Power Value (dBm)	Correction Factor (dB)	EIRP (dBm)	Limit (dBm)	Margin (dB)
1	1850.70	-30.7	9.5	0.1	9.6	33.0	-23.4
2	1880.00	-31.0	9.5	0.0	9.5	33.0	-23.5
3	1909.30	-30.1	10.6	-0.1	10.5	33.0	-22.5
Antenna Polarity & Test Distance: Vertical at 3 M							
No.	Freq. (MHz)	Reading (dBm)	S.G Power Value (dBm)	Correction Factor (dB)	EIRP (dBm)	Limit (dBm)	Margin (dB)
1	1850.70	-23.5	16.9	0.1	17.0	33.0	-16.0
2	1880.00	-23.6	17.0	0.0	17.0	33.0	-16.0
3	1909.30	-24.0	16.8	-0.1	16.7	33.0	-16.3

Note: EIRP (dBm) = S.G Power Value (dBm) + Correction Factor (dB).

LTE Band 2, Channel Bandwidth 3MHz

MODE		TX channel 18615, 18900, 19185					
Antenna Polarity & Test Distance: Horizontal at 3 M							
No.	Freq. (MHz)	Reading (dBm)	S.G Power Value (dBm)	Correction Factor (dB)	EIRP (dBm)	Limit (dBm)	Margin (dB)
1	1851.50	-30.4	9.8	0.1	9.9	33.0	-23.1
2	1880.00	-30.7	9.8	0.0	9.8	33.0	-23.2
3	1908.50	-31.1	9.6	-0.1	9.5	33.0	-23.5
Antenna Polarity & Test Distance: Vertical at 3 M							
No.	Freq. (MHz)	Reading (dBm)	S.G Power Value (dBm)	Correction Factor (dB)	EIRP (dBm)	Limit (dBm)	Margin (dB)
1	1851.50	-23.0	17.4	0.1	17.5	33.0	-15.5
2	1880.00	-23.0	17.6	0.0	17.6	33.0	-15.4
3	1908.50	-23.8	17.0	-0.1	16.9	33.0	-16.1

Note: EIRP (dBm) = S.G Power Value (dBm) + Correction Factor (dB).

LTE Band 2, Channel Bandwidth 5MHz

MODE		TX channel 18625, 18900, 19175					
Antenna Polarity & Test Distance: Horizontal at 3 M							
No.	Freq. (MHz)	Reading (dBm)	S.G Power Value (dBm)	Correction Factor (dB)	EIRP (dBm)	Limit (dBm)	Margin (dB)
1	1852.50	-30.1	10.1	0.1	10.2	33.0	-22.8
2	1880.00	-30.2	10.3	0.0	10.3	33.0	-22.7
3	1907.50	-30.5	10.2	-0.1	10.1	33.0	-22.9
Antenna Polarity & Test Distance: Vertical at 3 M							
No.	Freq. (MHz)	Reading (dBm)	S.G Power Value (dBm)	Correction Factor (dB)	EIRP (dBm)	Limit (dBm)	Margin (dB)
1	1852.50	-23.0	17.4	0.1	17.5	33.0	-15.5
2	1880.00	-23.2	17.4	0.0	17.4	33.0	-15.6
3	1907.50	-23.6	17.2	-0.1	17.1	33.0	-15.9

Note: EIRP (dBm) = S.G Power Value (dBm) + Correction Factor (dB).

LTE Band 2, Channel Bandwidth 10MHz

MODE		TX channel 18650, 18900, 19150					
Antenna Polarity & Test Distance: Horizontal at 3 M							
No.	Freq. (MHz)	Reading (dBm)	S.G Power Value (dBm)	Correction Factor (dB)	EIRP (dBm)	Limit (dBm)	Margin (dB)
1	1855.00	-30.5	9.8	0.0	9.8	33.0	-23.2
2	1880.00	-30.4	10.1	0.0	10.1	33.0	-22.9
3	1905.00	-30.4	10.3	-0.1	10.2	33.0	-22.8
Antenna Polarity & Test Distance: Vertical at 3 M							
No.	Freq. (MHz)	Reading (dBm)	S.G Power Value (dBm)	Correction Factor (dB)	EIRP (dBm)	Limit (dBm)	Margin (dB)
1	1855.00	-23.0	17.5	0.0	17.5	33.0	-15.5
2	1880.00	-22.8	17.8	0.0	17.8	33.0	-15.2
3	1905.00	-22.9	17.9	-0.1	17.8	33.0	-15.2

Note: EIRP (dBm) = S.G Power Value (dBm) + Correction Factor (dB).

LTE Band 2, Channel Bandwidth 15MHz

MODE		TX channel 18675, 18900, 19125					
Antenna Polarity & Test Distance: Horizontal at 3 M							
No.	Freq. (MHz)	Reading (dBm)	S.G Power Value (dBm)	Correction Factor (dB)	EIRP (dBm)	Limit (dBm)	Margin (dB)
1	1857.50	-30.7	9.6	0.0	9.6	33.0	-23.4
2	1880.00	-30.3	10.2	0.0	10.2	33.0	-22.8
3	1902.50	-30.4	10.3	-0.1	10.2	33.0	-22.8
Antenna Polarity & Test Distance: Vertical at 3 M							
No.	Freq. (MHz)	Reading (dBm)	S.G Power Value (dBm)	Correction Factor (dB)	EIRP (dBm)	Limit (dBm)	Margin (dB)
1	1857.50	-23.7	16.8	0.0	16.8	33.0	-16.2
2	1880.00	-23.8	16.8	0.0	16.8	33.0	-16.2
3	1902.50	-23.9	16.9	-0.1	16.8	33.0	-16.2

Note: EIRP (dBm) = S.G Power Value (dBm) + Correction Factor (dB).

LTE Band 2, Channel Bandwidth 20MHz

MODE		TX channel 18700, 18900, 19100					
Antenna Polarity & Test Distance: Horizontal at 3 M							
No.	Freq. (MHz)	Reading (dBm)	S.G Power Value (dBm)	Correction Factor (dB)	EIRP (dBm)	Limit (dBm)	Margin (dB)
1	1860.00	-30.5	9.8	0.0	9.8	33.0	-23.2
2	1880.00	-30.1	10.4	0.0	10.4	33.0	-22.6
3	1900.00	-30.6	10.1	-0.1	10.0	33.0	-23.0
Antenna Polarity & Test Distance: Vertical at 3 M							
No.	Freq. (MHz)	Reading (dBm)	S.G Power Value (dBm)	Correction Factor (dB)	EIRP (dBm)	Limit (dBm)	Margin (dB)
1	1860.00	-23.6	16.9	0.0	16.9	33.0	-16.1
2	1880.00	-23.2	17.4	0.0	17.4	33.0	-15.6
3	1900.00	-23.9	16.9	-0.1	16.8	33.0	-16.2

Note: EIRP (dBm) = S.G Power Value (dBm) + Correction Factor (dB).

Modulation Type: 64QAM

LTE Band 2, Channel Bandwidth 1.4MHz

MODE		TX channel 18607, 18900, 19193					
Antenna Polarity & Test Distance: Horizontal at 3 M							
No.	Freq. (MHz)	Reading (dBm)	S.G Power Value (dBm)	Correction Factor (dB)	EIRP (dBm)	Limit (dBm)	Margin (dB)
1	1850.70	-31.3	8.9	0.1	9.0	33.0	-24.0
2	1880.00	-31.4	9.1	0.0	9.1	33.0	-23.9
3	1909.30	-30.7	10.0	-0.1	9.9	33.0	-23.1
Antenna Polarity & Test Distance: Vertical at 3 M							
No.	Freq. (MHz)	Reading (dBm)	S.G Power Value (dBm)	Correction Factor (dB)	EIRP (dBm)	Limit (dBm)	Margin (dB)
1	1850.70	-24.0	16.4	0.1	16.5	33.0	-16.5
2	1880.00	-24.1	16.5	0.0	16.5	33.0	-16.5
3	1909.30	-24.4	16.4	-0.1	16.3	33.0	-16.7

Note: EIRP (dBm) = S.G Power Value (dBm) + Correction Factor (dB).

LTE Band 2, Channel Bandwidth 3MHz

MODE		TX channel 18615, 18900, 19185					
Antenna Polarity & Test Distance: Horizontal at 3 M							
No.	Freq. (MHz)	Reading (dBm)	S.G Power Value (dBm)	Correction Factor (dB)	EIRP (dBm)	Limit (dBm)	Margin (dB)
1	1851.50	-31.0	9.2	0.1	9.3	33.0	-23.7
2	1880.00	-31.3	9.2	0.0	9.2	33.0	-23.8
3	1908.50	-31.6	9.1	-0.1	9.0	33.0	-24.0
Antenna Polarity & Test Distance: Vertical at 3 M							
No.	Freq. (MHz)	Reading (dBm)	S.G Power Value (dBm)	Correction Factor (dB)	EIRP (dBm)	Limit (dBm)	Margin (dB)
1	1851.50	-23.4	17.0	0.1	17.1	33.0	-15.9
2	1880.00	-23.6	17.0	0.0	17.0	33.0	-16.0
3	1908.50	-24.3	16.5	-0.1	16.4	33.0	-16.6

Note: EIRP (dBm) = S.G Power Value (dBm) + Correction Factor (dB).

LTE Band 2, Channel Bandwidth 5MHz

MODE		TX channel 18625, 18900, 19175					
Antenna Polarity & Test Distance: Horizontal at 3 M							
No.	Freq. (MHz)	Reading (dBm)	S.G Power Value (dBm)	Correction Factor (dB)	EIRP (dBm)	Limit (dBm)	Margin (dB)
1	1852.50	-30.7	9.5	0.1	9.6	33.0	-23.4
2	1880.00	-30.6	9.9	0.0	9.9	33.0	-23.1
3	1907.50	-31.0	9.7	-0.1	9.6	33.0	-23.4
Antenna Polarity & Test Distance: Vertical at 3 M							
No.	Freq. (MHz)	Reading (dBm)	S.G Power Value (dBm)	Correction Factor (dB)	EIRP (dBm)	Limit (dBm)	Margin (dB)
1	1852.50	-23.6	16.8	0.1	16.9	33.0	-16.1
2	1880.00	-23.4	17.2	0.0	17.2	33.0	-15.8
3	1907.50	-23.9	16.9	-0.1	16.8	33.0	-16.2

Note: EIRP (dBm) = S.G Power Value (dBm) + Correction Factor (dB).

LTE Band 2, Channel Bandwidth 10MHz

MODE		TX channel 18650, 18900, 19150					
Antenna Polarity & Test Distance: Horizontal at 3 M							
No.	Freq. (MHz)	Reading (dBm)	S.G Power Value (dBm)	Correction Factor (dB)	EIRP (dBm)	Limit (dBm)	Margin (dB)
1	1855.00	-31.1	9.2	0.0	9.2	33.0	-23.8
2	1880.00	-30.9	9.6	0.0	9.6	33.0	-23.4
3	1905.00	-30.9	9.8	-0.1	9.7	33.0	-23.3
Antenna Polarity & Test Distance: Vertical at 3 M							
No.	Freq. (MHz)	Reading (dBm)	S.G Power Value (dBm)	Correction Factor (dB)	EIRP (dBm)	Limit (dBm)	Margin (dB)
1	1855.00	-23.6	16.9	0.0	16.9	33.0	-16.1
2	1880.00	-23.2	17.4	0.0	17.4	33.0	-15.6
3	1905.00	-23.5	17.3	-0.1	17.2	33.0	-15.8

Note: EIRP (dBm) = S.G Power Value (dBm) + Correction Factor (dB).

LTE Band 2, Channel Bandwidth 15MHz

MODE		TX channel 18675, 18900, 19125					
Antenna Polarity & Test Distance: Horizontal at 3 M							
No.	Freq. (MHz)	Reading (dBm)	S.G Power Value (dBm)	Correction Factor (dB)	EIRP (dBm)	Limit (dBm)	Margin (dB)
1	1857.50	-31.3	9.0	0.0	9.0	33.0	-24.0
2	1880.00	-30.7	9.8	0.0	9.8	33.0	-23.2
3	1902.50	-30.9	9.8	-0.1	9.7	33.0	-23.3
Antenna Polarity & Test Distance: Vertical at 3 M							
No.	Freq. (MHz)	Reading (dBm)	S.G Power Value (dBm)	Correction Factor (dB)	EIRP (dBm)	Limit (dBm)	Margin (dB)
1	1857.50	-24.2	16.3	0.0	16.3	33.0	-16.7
2	1880.00	-24.2	16.4	0.0	16.4	33.0	-16.6
3	1902.50	-24.4	16.4	-0.1	16.3	33.0	-16.7

Note: EIRP (dBm) = S.G Power Value (dBm) + Correction Factor (dB).

LTE Band 2, Channel Bandwidth 20MHz

MODE		TX channel 18700, 18900, 19100					
Antenna Polarity & Test Distance: Horizontal at 3 M							
No.	Freq. (MHz)	Reading (dBm)	S.G Power Value (dBm)	Correction Factor (dB)	EIRP (dBm)	Limit (dBm)	Margin (dB)
1	1860.00	-30.9	9.4	0.0	9.4	33.0	-23.6
2	1880.00	-30.7	9.8	0.0	9.8	33.0	-23.2
3	1900.00	-31.2	9.5	-0.1	9.4	33.0	-23.6
Antenna Polarity & Test Distance: Vertical at 3 M							
No.	Freq. (MHz)	Reading (dBm)	S.G Power Value (dBm)	Correction Factor (dB)	EIRP (dBm)	Limit (dBm)	Margin (dB)
1	1860.00	-24.0	16.5	0.0	16.5	33.0	-16.5
2	1880.00	-23.8	16.8	0.0	16.8	33.0	-16.2
3	1900.00	-24.4	16.4	-0.1	16.3	33.0	-16.7

Note: EIRP (dBm) = S.G Power Value (dBm) + Correction Factor (dB).

Modulation Type: QPSK

LTE Band 25, Channel Bandwidth 1.4MHz

MODE		TX channel 26047, 26365, 26683					
Antenna Polarity & Test Distance: Horizontal at 3 M							
No.	Freq. (MHz)	Reading (dBm)	S.G Power Value (dBm)	Correction Factor (dB)	EIRP (dBm)	Limit (dBm)	Margin (dB)
1	1850.70	-27.6	12.6	0.1	12.7	33.0	-20.3
2	1882.50	-28.2	12.3	0.0	12.3	33.0	-20.7
3	1914.30	-28.0	12.6	-0.1	12.5	33.0	-20.5
Antenna Polarity & Test Distance: Vertical at 3 M							
No.	Freq. (MHz)	Reading (dBm)	S.G Power Value (dBm)	Correction Factor (dB)	EIRP (dBm)	Limit (dBm)	Margin (dB)
1	1850.70	-23.0	17.4	0.1	17.5	33.0	-15.5
2	1882.50	-23.4	17.2	0.0	17.2	33.0	-15.8
3	1914.30	-22.7	18.1	-0.1	18.0	33.0	-15.0

Note: EIRP (dBm) = S.G Power Value (dBm) + Correction Factor (dB).

LTE Band 25, Channel Bandwidth 3MHz

MODE		TX channel 26055, 26365, 26675					
Antenna Polarity & Test Distance: Horizontal at 3 M							
No.	Freq. (MHz)	Reading (dBm)	S.G Power Value (dBm)	Correction Factor (dB)	EIRP (dBm)	Limit (dBm)	Margin (dB)
1	1851.50	-27.8	12.4	0.1	12.5	33.0	-20.5
2	1882.50	-27.8	12.7	0.0	12.7	33.0	-20.3
3	1913.50	-28.0	12.6	-0.1	12.5	33.0	-20.5
Antenna Polarity & Test Distance: Vertical at 3 M							
No.	Freq. (MHz)	Reading (dBm)	S.G Power Value (dBm)	Correction Factor (dB)	EIRP (dBm)	Limit (dBm)	Margin (dB)
1	1851.50	-22.4	18.0	0.1	18.1	33.0	-14.9
2	1882.50	-23.0	17.6	0.0	17.6	33.0	-15.4
3	1913.50	-23.1	17.7	-0.1	17.6	33.0	-15.4

Note: EIRP (dBm) = S.G Power Value (dBm) + Correction Factor (dB).

LTE Band 25, Channel Bandwidth 5MHz

MODE		TX channel 26065, 26365, 26665					
Antenna Polarity & Test Distance: Horizontal at 3 M							
No.	Freq. (MHz)	Reading (dBm)	S.G Power Value (dBm)	Correction Factor (dB)	EIRP (dBm)	Limit (dBm)	Margin (dB)
1	1852.50	-28.1	12.1	0.1	12.2	33.0	-20.8
2	1882.50	-28.2	12.3	0.0	12.3	33.0	-20.7
3	1912.50	-28.1	12.5	-0.1	12.4	33.0	-20.6
Antenna Polarity & Test Distance: Vertical at 3 M							
No.	Freq. (MHz)	Reading (dBm)	S.G Power Value (dBm)	Correction Factor (dB)	EIRP (dBm)	Limit (dBm)	Margin (dB)
1	1852.50	-22.8	17.6	0.1	17.7	33.0	-15.3
2	1882.50	-23.0	17.6	0.0	17.6	33.0	-15.4
3	1912.50	-23.0	17.8	-0.1	17.7	33.0	-15.3

Note: EIRP (dBm) = S.G Power Value (dBm) + Correction Factor (dB).

LTE Band 25, Channel Bandwidth 10MHz

MODE		TX channel 26090, 26365, 26640					
Antenna Polarity & Test Distance: Horizontal at 3 M							
No.	Freq. (MHz)	Reading (dBm)	S.G Power Value (dBm)	Correction Factor (dB)	EIRP (dBm)	Limit (dBm)	Margin (dB)
1	1855.00	-27.8	12.5	0.0	12.5	33.0	-20.5
2	1882.50	-28.2	12.3	0.0	12.3	33.0	-20.7
3	1910.00	-27.6	13.0	-0.1	12.9	33.0	-20.1
Antenna Polarity & Test Distance: Vertical at 3 M							
No.	Freq. (MHz)	Reading (dBm)	S.G Power Value (dBm)	Correction Factor (dB)	EIRP (dBm)	Limit (dBm)	Margin (dB)
1	1855.00	-22.5	18.0	0.0	18.0	33.0	-15.0
2	1882.50	-23.1	17.5	0.0	17.5	33.0	-15.5
3	1910.00	-23.2	17.6	-0.1	17.5	33.0	-15.5

Note: EIRP (dBm) = S.G Power Value (dBm) + Correction Factor (dB).

LTE Band 25, Channel Bandwidth 15MHz

MODE		TX channel 26115, 26365, 26615					
Antenna Polarity & Test Distance: Horizontal at 3 M							
No.	Freq. (MHz)	Reading (dBm)	S.G Power Value (dBm)	Correction Factor (dB)	EIRP (dBm)	Limit (dBm)	Margin (dB)
1	1857.50	-27.7	12.6	0.0	12.6	33.0	-20.4
2	1882.50	-27.5	13.0	0.0	13.0	33.0	-20.0
3	1907.50	-28.5	12.2	-0.1	12.1	33.0	-20.9
Antenna Polarity & Test Distance: Vertical at 3 M							
No.	Freq. (MHz)	Reading (dBm)	S.G Power Value (dBm)	Correction Factor (dB)	EIRP (dBm)	Limit (dBm)	Margin (dB)
1	1857.50	-22.4	18.1	0.0	18.1	33.0	-14.9
2	1882.50	-22.7	17.9	0.0	17.9	33.0	-15.1
3	1907.50	-22.9	17.9	-0.1	17.8	33.0	-15.2

Note: EIRP (dBm) = S.G Power Value (dBm) + Correction Factor (dB).

LTE Band 25, Channel Bandwidth 20MHz

MODE		TX channel 26140, 26365, 26590					
Antenna Polarity & Test Distance: Horizontal at 3 M							
No.	Freq. (MHz)	Reading (dBm)	S.G Power Value (dBm)	Correction Factor (dB)	EIRP (dBm)	Limit (dBm)	Margin (dB)
1	1860.00	-27.3	13.0	0.0	13.0	33.0	-20.0
2	1882.50	-28.1	12.4	0.0	12.4	33.0	-20.6
3	1905.00	-28.0	12.7	-0.1	12.6	33.0	-20.4
Antenna Polarity & Test Distance: Vertical at 3 M							
No.	Freq. (MHz)	Reading (dBm)	S.G Power Value (dBm)	Correction Factor (dB)	EIRP (dBm)	Limit (dBm)	Margin (dB)
1	1860.00	-22.5	18.0	0.0	18.0	33.0	-15.0
2	1882.50	-22.4	18.2	0.0	18.2	33.0	-14.8
3	1905.00	-23.0	17.8	-0.1	17.7	33.0	-15.3

Note: EIRP (dBm) = S.G Power Value (dBm) + Correction Factor (dB).

Modulation Type: 16QAM

LTE Band 25, Channel Bandwidth 1.4MHz

MODE		TX channel 26047, 26365, 26683					
Antenna Polarity & Test Distance: Horizontal at 3 M							
No.	Freq. (MHz)	Reading (dBm)	S.G Power Value (dBm)	Correction Factor (dB)	EIRP (dBm)	Limit (dBm)	Margin (dB)
1	1850.70	-28.5	11.7	0.1	11.8	33.0	-21.2
2	1882.50	-29.3	11.2	0.0	11.2	33.0	-21.8
3	1914.30	-29.2	11.4	-0.1	11.3	33.0	-21.7
Antenna Polarity & Test Distance: Vertical at 3 M							
No.	Freq. (MHz)	Reading (dBm)	S.G Power Value (dBm)	Correction Factor (dB)	EIRP (dBm)	Limit (dBm)	Margin (dB)
1	1850.70	-24.1	16.3	0.1	16.4	33.0	-16.6
2	1882.50	-24.4	16.2	0.0	16.2	33.0	-16.8
3	1914.30	-23.6	17.2	-0.1	17.1	33.0	-15.9

Note: EIRP (dBm) = S.G Power Value (dBm) + Correction Factor (dB).

LTE Band 25, Channel Bandwidth 3MHz

MODE		TX channel 26055, 26365, 26675					
Antenna Polarity & Test Distance: Horizontal at 3 M							
No.	Freq. (MHz)	Reading (dBm)	S.G Power Value (dBm)	Correction Factor (dB)	EIRP (dBm)	Limit (dBm)	Margin (dB)
1	1851.50	-28.7	11.5	0.1	11.6	33.0	-21.4
2	1882.50	-28.9	11.6	0.0	11.6	33.0	-21.4
3	1913.50	-28.9	11.7	-0.1	11.6	33.0	-21.4
Antenna Polarity & Test Distance: Vertical at 3 M							
No.	Freq. (MHz)	Reading (dBm)	S.G Power Value (dBm)	Correction Factor (dB)	EIRP (dBm)	Limit (dBm)	Margin (dB)
1	1851.50	-23.7	16.7	0.1	16.8	33.0	-16.2
2	1882.50	-23.9	16.7	0.0	16.7	33.0	-16.3
3	1913.50	-24.2	16.6	-0.1	16.5	33.0	-16.5

Note: EIRP (dBm) = S.G Power Value (dBm) + Correction Factor (dB).

LTE Band 25, Channel Bandwidth 5MHz

MODE		TX channel 26065, 26365, 26665					
Antenna Polarity & Test Distance: Horizontal at 3 M							
No.	Freq. (MHz)	Reading (dBm)	S.G Power Value (dBm)	Correction Factor (dB)	EIRP (dBm)	Limit (dBm)	Margin (dB)
1	1852.50	-29.2	11.0	0.1	11.1	33.0	-21.9
2	1882.50	-29.2	11.3	0.0	11.3	33.0	-21.7
3	1912.50	-29.1	11.5	-0.1	11.4	33.0	-21.6
Antenna Polarity & Test Distance: Vertical at 3 M							
No.	Freq. (MHz)	Reading (dBm)	S.G Power Value (dBm)	Correction Factor (dB)	EIRP (dBm)	Limit (dBm)	Margin (dB)
1	1852.50	-23.8	16.6	0.1	16.7	33.0	-16.3
2	1882.50	-24.1	16.5	0.0	16.5	33.0	-16.5
3	1912.50	-23.9	16.9	-0.1	16.8	33.0	-16.2

Note: EIRP (dBm) = S.G Power Value (dBm) + Correction Factor (dB).

LTE Band 25, Channel Bandwidth 10MHz

MODE		TX channel 26090, 26365, 26640					
Antenna Polarity & Test Distance: Horizontal at 3 M							
No.	Freq. (MHz)	Reading (dBm)	S.G Power Value (dBm)	Correction Factor (dB)	EIRP (dBm)	Limit (dBm)	Margin (dB)
1	1855.00	-28.9	11.4	0.0	11.4	33.0	-21.6
2	1882.50	-29.2	11.3	0.0	11.3	33.0	-21.7
3	1910.00	-28.5	12.1	-0.1	12.0	33.0	-21.0
Antenna Polarity & Test Distance: Vertical at 3 M							
No.	Freq. (MHz)	Reading (dBm)	S.G Power Value (dBm)	Correction Factor (dB)	EIRP (dBm)	Limit (dBm)	Margin (dB)
1	1855.00	-23.6	16.9	0.0	16.9	33.0	-16.1
2	1882.50	-24.2	16.4	0.0	16.4	33.0	-16.6
3	1910.00	-24.0	16.8	-0.1	16.7	33.0	-16.3

Note: EIRP (dBm) = S.G Power Value (dBm) + Correction Factor (dB).

LTE Band 25, Channel Bandwidth 15MHz

MODE		TX channel 26115, 26365, 26615					
Antenna Polarity & Test Distance: Horizontal at 3 M							
No.	Freq. (MHz)	Reading (dBm)	S.G Power Value (dBm)	Correction Factor (dB)	EIRP (dBm)	Limit (dBm)	Margin (dB)
1	1857.50	-28.7	11.6	0.0	11.6	33.0	-21.4
2	1882.50	-28.7	11.8	0.0	11.8	33.0	-21.2
3	1907.50	-29.5	11.2	-0.1	11.1	33.0	-21.9
Antenna Polarity & Test Distance: Vertical at 3 M							
No.	Freq. (MHz)	Reading (dBm)	S.G Power Value (dBm)	Correction Factor (dB)	EIRP (dBm)	Limit (dBm)	Margin (dB)
1	1857.50	-23.5	17.0	0.0	17.0	33.0	-16.0
2	1882.50	-23.7	16.9	0.0	16.9	33.0	-16.1
3	1907.50	-24.1	16.7	-0.1	16.6	33.0	-16.4

Note: EIRP (dBm) = S.G Power Value (dBm) + Correction Factor (dB).

LTE Band 25, Channel Bandwidth 20MHz

MODE		TX channel 26140, 26365, 26590					
Antenna Polarity & Test Distance: Horizontal at 3 M							
No.	Freq. (MHz)	Reading (dBm)	S.G Power Value (dBm)	Correction Factor (dB)	EIRP (dBm)	Limit (dBm)	Margin (dB)
1	1860.00	-28.1	12.2	0.0	12.2	33.0	-20.8
2	1882.50	-29.0	11.5	0.0	11.5	33.0	-21.5
3	1905.00	-29.0	11.7	-0.1	11.6	33.0	-21.4
Antenna Polarity & Test Distance: Vertical at 3 M							
No.	Freq. (MHz)	Reading (dBm)	S.G Power Value (dBm)	Correction Factor (dB)	EIRP (dBm)	Limit (dBm)	Margin (dB)
1	1860.00	-23.6	16.9	0.0	16.9	33.0	-16.1
2	1882.50	-23.5	17.1	0.0	17.1	33.0	-15.9
3	1905.00	-24.1	16.7	-0.1	16.6	33.0	-16.4

Note: EIRP (dBm) = S.G Power Value (dBm) + Correction Factor (dB).

Modulation Type: 64QAM

LTE Band 25, Channel Bandwidth 1.4MHz

MODE		TX channel 26047, 26365, 26683					
Antenna Polarity & Test Distance: Horizontal at 3 M							
No.	Freq. (MHz)	Reading (dBm)	S.G Power Value (dBm)	Correction Factor (dB)	EIRP (dBm)	Limit (dBm)	Margin (dB)
1	1850.70	-28.9	11.3	0.1	11.4	33.0	-21.6
2	1882.50	-29.9	10.6	0.0	10.6	33.0	-22.4
3	1914.30	-29.7	10.9	-0.1	10.8	33.0	-22.2
Antenna Polarity & Test Distance: Vertical at 3 M							
No.	Freq. (MHz)	Reading (dBm)	S.G Power Value (dBm)	Correction Factor (dB)	EIRP (dBm)	Limit (dBm)	Margin (dB)
1	1850.70	-24.5	15.9	0.1	16.0	33.0	-17.0
2	1882.50	-25.0	15.6	0.0	15.6	33.0	-17.4
3	1914.30	-25.2	15.6	-0.1	15.5	33.0	-17.5

Note: EIRP (dBm) = S.G Power Value (dBm) + Correction Factor (dB).

LTE Band 25, Channel Bandwidth 3MHz

MODE		TX channel 26055, 26365, 26675					
Antenna Polarity & Test Distance: Horizontal at 3 M							
No.	Freq. (MHz)	Reading (dBm)	S.G Power Value (dBm)	Correction Factor (dB)	EIRP (dBm)	Limit (dBm)	Margin (dB)
1	1851.50	-29.3	10.9	0.1	11.0	33.0	-22.0
2	1882.50	-29.4	11.1	0.0	11.1	33.0	-21.9
3	1913.50	-29.3	11.3	-0.1	11.2	33.0	-21.8
Antenna Polarity & Test Distance: Vertical at 3 M							
No.	Freq. (MHz)	Reading (dBm)	S.G Power Value (dBm)	Correction Factor (dB)	EIRP (dBm)	Limit (dBm)	Margin (dB)
1	1851.50	-24.2	16.2	0.1	16.3	33.0	-16.7
2	1882.50	-24.5	16.1	0.0	16.1	33.0	-16.9
3	1913.50	-24.6	16.2	-0.1	16.1	33.0	-16.9

Note: EIRP (dBm) = S.G Power Value (dBm) + Correction Factor (dB).

LTE Band 25, Channel Bandwidth 5MHz

MODE		TX channel 26065, 26365, 26665					
Antenna Polarity & Test Distance: Horizontal at 3 M							
No.	Freq. (MHz)	Reading (dBm)	S.G Power Value (dBm)	Correction Factor (dB)	EIRP (dBm)	Limit (dBm)	Margin (dB)
1	1852.50	-29.7	10.5	0.1	10.6	33.0	-22.4
2	1882.50	-29.8	10.7	0.0	10.7	33.0	-22.3
3	1912.50	-29.6	11.0	-0.1	10.9	33.0	-22.1
Antenna Polarity & Test Distance: Vertical at 3 M							
No.	Freq. (MHz)	Reading (dBm)	S.G Power Value (dBm)	Correction Factor (dB)	EIRP (dBm)	Limit (dBm)	Margin (dB)
1	1852.50	-24.3	16.1	0.1	16.2	33.0	-16.8
2	1882.50	-24.5	16.1	0.0	16.1	33.0	-16.9
3	1912.50	-24.5	16.3	-0.1	16.2	33.0	-16.8

Note: EIRP (dBm) = S.G Power Value (dBm) + Correction Factor (dB).

LTE Band 25, Channel Bandwidth 10MHz

MODE		TX channel 26090, 26365, 26640					
Antenna Polarity & Test Distance: Horizontal at 3 M							
No.	Freq. (MHz)	Reading (dBm)	S.G Power Value (dBm)	Correction Factor (dB)	EIRP (dBm)	Limit (dBm)	Margin (dB)
1	1855.00	-29.3	11.0	0.0	11.0	33.0	-22.0
2	1882.50	-29.8	10.7	0.0	10.7	33.0	-22.3
3	1910.00	-29.0	11.6	-0.1	11.5	33.0	-21.5
Antenna Polarity & Test Distance: Vertical at 3 M							
No.	Freq. (MHz)	Reading (dBm)	S.G Power Value (dBm)	Correction Factor (dB)	EIRP (dBm)	Limit (dBm)	Margin (dB)
1	1855.00	-24.1	16.4	0.0	16.4	33.0	-16.6
2	1882.50	-24.6	16.0	0.0	16.0	33.0	-17.0
3	1910.00	-24.5	16.3	-0.1	16.2	33.0	-16.8

Note: EIRP (dBm) = S.G Power Value (dBm) + Correction Factor (dB).

LTE Band 25, Channel Bandwidth 15MHz

MODE		TX channel 26115, 26365, 26615					
Antenna Polarity & Test Distance: Horizontal at 3 M							
No.	Freq. (MHz)	Reading (dBm)	S.G Power Value (dBm)	Correction Factor (dB)	EIRP (dBm)	Limit (dBm)	Margin (dB)
1	1857.50	-29.2	11.1	0.0	11.1	33.0	-21.9
2	1882.50	-29.2	11.3	0.0	11.3	33.0	-21.7
3	1907.50	-30.0	10.7	-0.1	10.6	33.0	-22.4
Antenna Polarity & Test Distance: Vertical at 3 M							
No.	Freq. (MHz)	Reading (dBm)	S.G Power Value (dBm)	Correction Factor (dB)	EIRP (dBm)	Limit (dBm)	Margin (dB)
1	1857.50	-23.9	16.6	0.0	16.6	33.0	-16.4
2	1882.50	-24.2	16.4	0.0	16.4	33.0	-16.6
3	1907.50	-24.6	16.2	-0.1	16.1	33.0	-16.9

Note: EIRP (dBm) = S.G Power Value (dBm) + Correction Factor (dB).

LTE Band 25, Channel Bandwidth 20MHz

MODE		TX channel 26140, 26365, 26590					
Antenna Polarity & Test Distance: Horizontal at 3 M							
No.	Freq. (MHz)	Reading (dBm)	S.G Power Value (dBm)	Correction Factor (dB)	EIRP (dBm)	Limit (dBm)	Margin (dB)
1	1860.00	-28.7	11.6	0.0	11.6	33.0	-21.4
2	1882.50	-29.6	10.9	0.0	10.9	33.0	-22.1
3	1905.00	-29.4	11.3	-0.1	11.2	33.0	-21.8
Antenna Polarity & Test Distance: Vertical at 3 M							
No.	Freq. (MHz)	Reading (dBm)	S.G Power Value (dBm)	Correction Factor (dB)	EIRP (dBm)	Limit (dBm)	Margin (dB)
1	1860.00	-24.2	16.3	0.0	16.3	33.0	-16.7
2	1882.50	-23.9	16.7	0.0	16.7	33.0	-16.3
3	1905.00	-24.7	16.1	-0.1	16.0	33.0	-17.0

Note: EIRP (dBm) = S.G Power Value (dBm) + Correction Factor (dB).

4.2 Modulation Characteristics Measurement

4.2.1 Limits of Modulation Characteristics

N/A

4.2.2 Test Procedure

Connect the EUT to Communication Simulator via the antenna connector, The frequency band is set as EUT supported Modulation and Channels, the EUT output is matched with 50 ohm load, the waveform quality and constellation of the EUT was tested.

4.2.3 Test Setup



4.2.4 Test Results

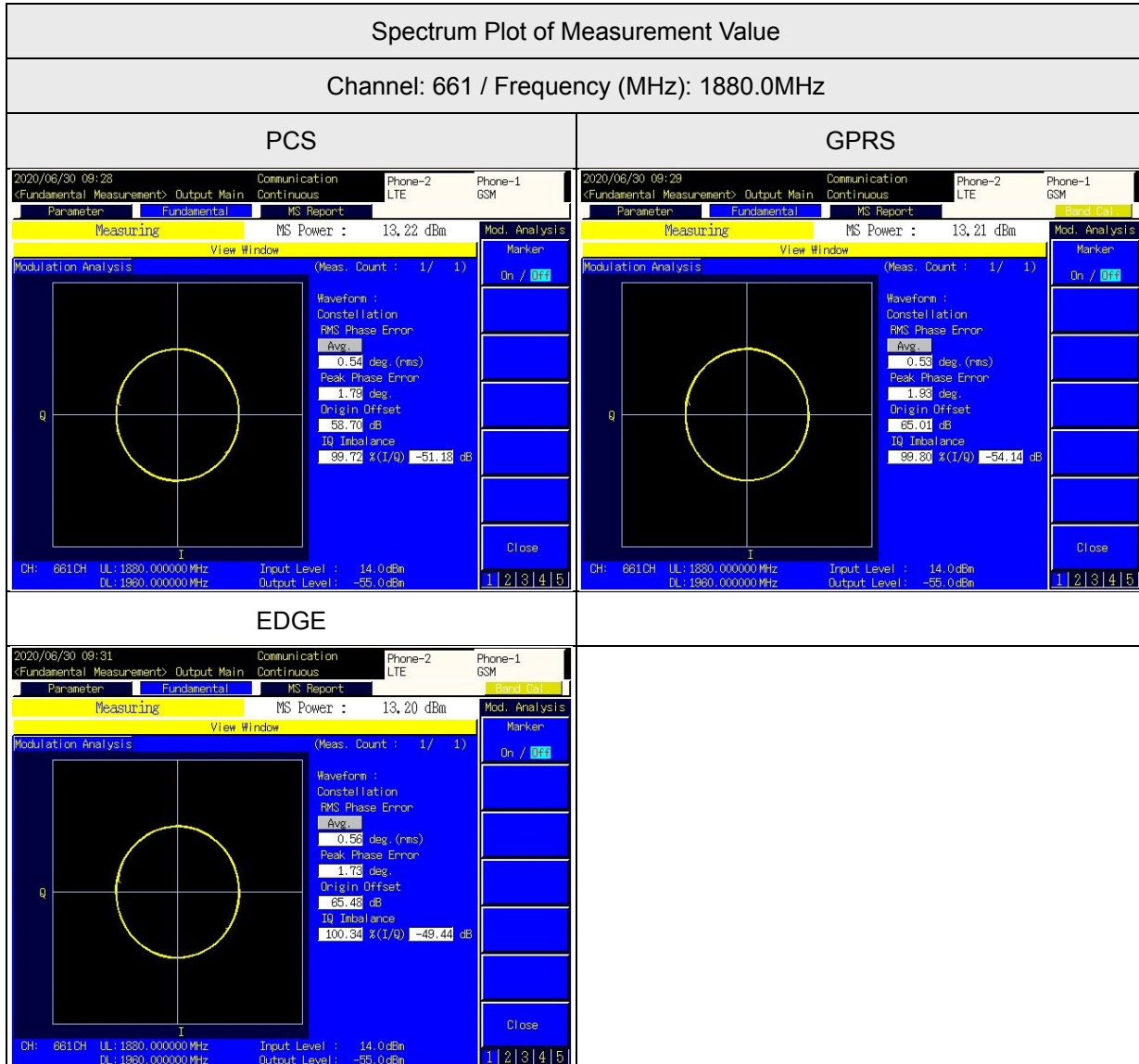

WCDMA Band 2

Spectrum Plot of Measurement Value

Channel: 9400 / Frequency (MHz): 1880.0MHz

WCDMA

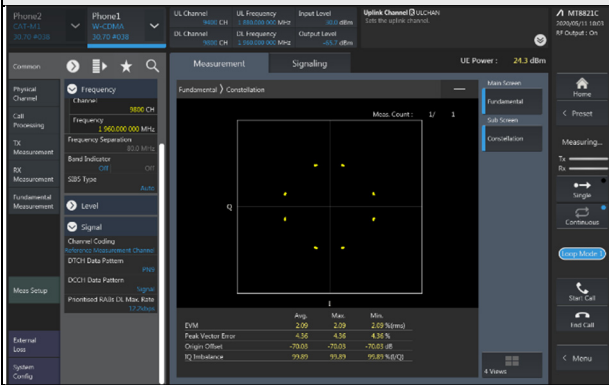

HSDPA

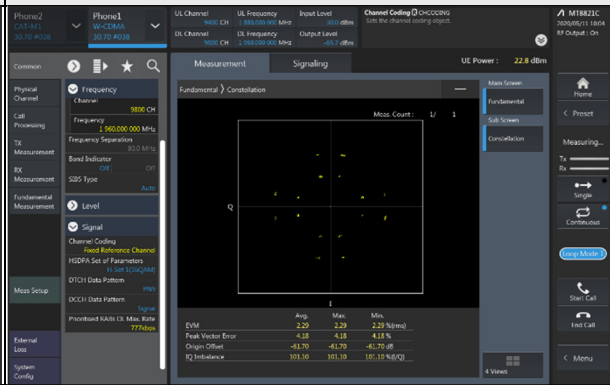

HSUPA

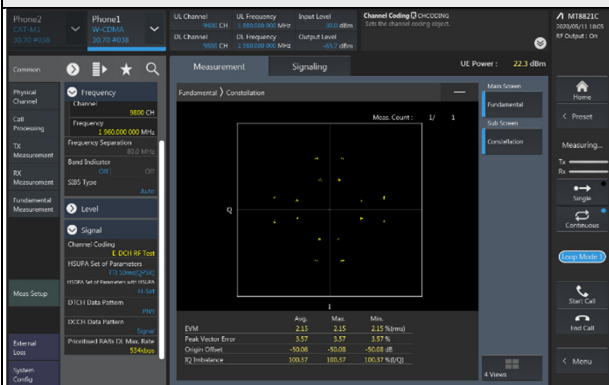

LTE Band 2

Spectrum Plot of Measurement Value

Channel: 18900 / Frequency (MHz): 1880.0MHz

QPSK

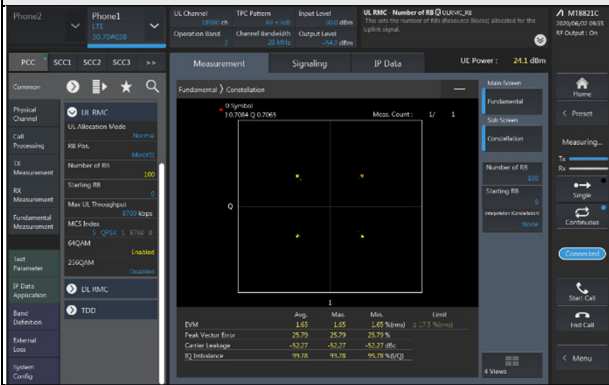

16QAM

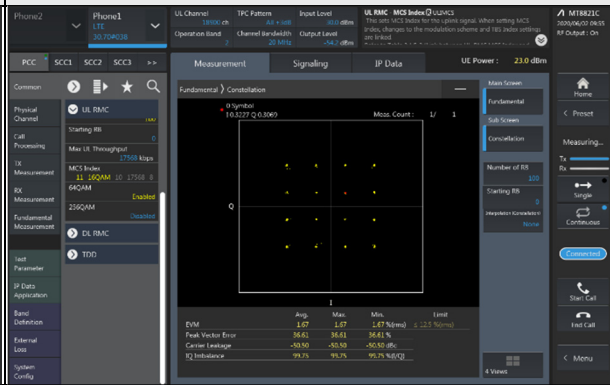

64QAM

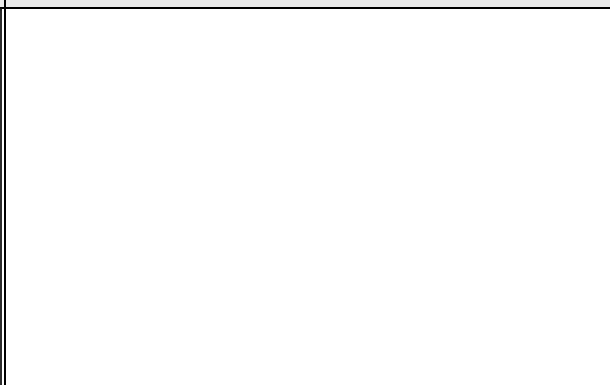
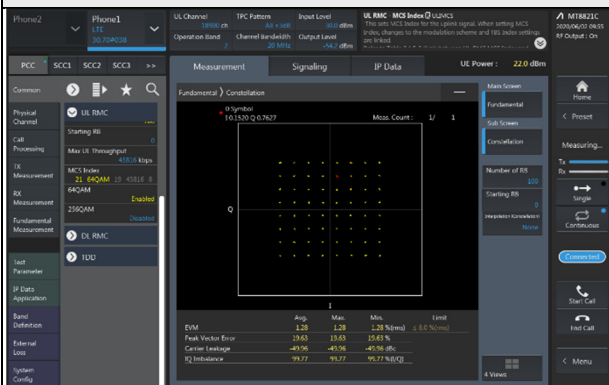

4.3 Frequency Stability Measurement

4.3.1 Limits of Frequency Stability Measurement

The frequency stability shall be sufficient to ensure that the fundamental emission stays within the authorized frequency block.

4.3.2 Test Procedure

- a. Device is placed at the oven room. The oven room could control the temperatures and humidity. Power warm up is at least 15 min and power applied should perform before recording frequency error.
- b. EUT is connected the external power supply to control the DC input power. The test voltage range is from minimum to maximum working voltage. Each step shall be record the frequency error rate.
- c. The temperature range step is 10 degrees in this test items. All temperature levels shall be hold the ± 0.5 °C during the measurement testing. The each temperature step shall be at least 0.5 hours, consider the EUT could be test under the stability condition.

Note: The frequency error was recorded frequency error from the communication simulator.

4.3.3 Conducted Setup

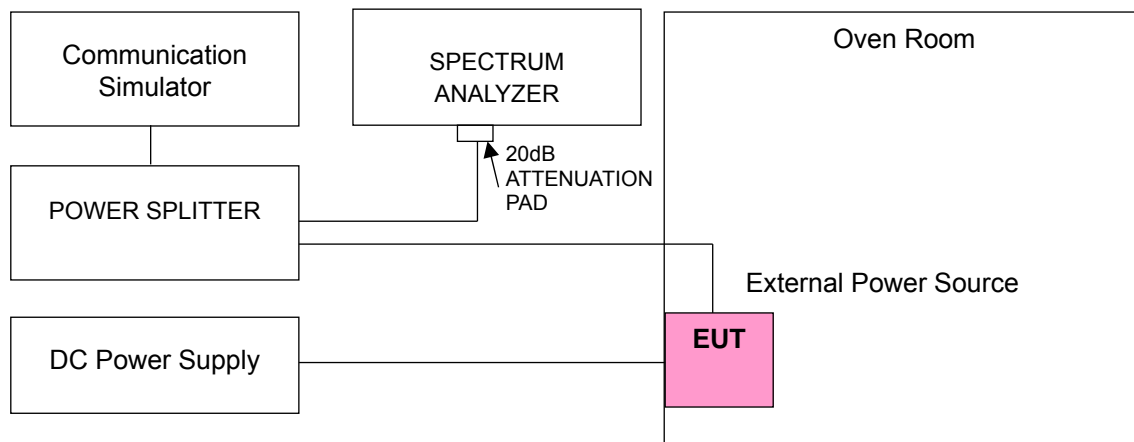

4.3.4 Test Results

Frequency Error vs. Voltage

Voltage (Volts)	PCS 1900			
	Low Channel		High Channel	
	Frequency (MHz)	Frequency Error (ppm)	Frequency (MHz)	Frequency Error (ppm)
3.86	1850.200003	0.002	1909.800002	0.001
3.28	1850.200004	0.002	1909.800004	0.002
4.44	1850.200003	0.002	1909.800004	0.002

Note: The applicant defined the normal working voltage is from 3.28Vdc to 4.44Vdc.

Frequency Error vs. Temperature

Temp. (°C)	PCS 1900			
	Low Channel		High Channel	
	Frequency (MHz)	Frequency Error (ppm)	Frequency (MHz)	Frequency Error (ppm)
-30	1850.200001	0.001	1909.800002	0.001
-20	1850.200003	0.002	1909.800002	0.001
-10	1850.200003	0.001	1909.800002	0.001
0	1850.200002	0.001	1909.800004	0.002
10	1850.200002	0.001	1909.800002	0.001
20	1850.199997	-0.002	1909.799996	-0.002
30	1850.199996	-0.002	1909.799999	-0.001
40	1850.199998	-0.001	1909.799998	-0.001
50	1850.199997	-0.001	1909.799999	-0.001

Frequency Error vs. Voltage

Voltage (Volts)	EDGE 1900			
	Low Channel		High Channel	
	Frequency (MHz)	Frequency Error (ppm)	Frequency (MHz)	Frequency Error (ppm)
3.86	1850.200003	0.001	1909.800002	0.001
3.28	1850.200002	0.001	1909.800002	0.001
4.44	1850.200001	0.001	1909.800003	0.002

Note: The applicant defined the normal working voltage is from 3.28Vdc to 4.44Vdc.

Frequency Error vs. Temperature

Temp. (°C)	EDGE 1900			
	Low Channel		High Channel	
	Frequency (MHz)	Frequency Error (ppm)	Frequency (MHz)	Frequency Error (ppm)
-30	1850.200002	0.001	1909.800002	0.001
-20	1850.200003	0.002	1909.800002	0.001
-10	1850.200002	0.001	1909.800002	0.001
0	1850.200004	0.002	1909.800001	0.001
10	1850.200002	0.001	1909.800001	0.001
20	1850.199998	-0.001	1909.799999	-0.001
30	1850.199997	-0.002	1909.799998	-0.001
40	1850.199998	-0.001	1909.799997	-0.001
50	1850.199998	-0.001	1909.799998	-0.001

Frequency Error vs. Voltage

Voltage (Volts)	WCDMA Band 2			
	Low Channel		High Channel	
	Frequency (MHz)	Frequency Error (ppm)	Frequency (MHz)	Frequency Error (ppm)
3.86	1852.400001	0.001	1907.600003	0.001
3.28	1852.400001	0.001	1907.600003	0.002
4.44	1852.400004	0.002	1907.600001	0.001

Note: The applicant defined the normal working voltage is from 3.28Vdc to 4.44Vdc.

Frequency Error vs. Temperature

Temp. (°C)	WCDMA Band 2			
	Low Channel		High Channel	
	Frequency (MHz)	Frequency Error (ppm)	Frequency (MHz)	Frequency Error (ppm)
-30	1852.400002	0.001	1907.600002	0.001
-20	1852.400002	0.001	1907.600004	0.002
-10	1852.400002	0.001	1907.600003	0.002
0	1852.400003	0.001	1907.600003	0.002
10	1852.400001	0.001	1907.600001	0.001
20	1852.399997	-0.002	1907.599999	-0.001
30	1852.399998	-0.001	1907.599997	-0.001
40	1852.399998	-0.001	1907.599997	-0.002
50	1852.399998	-0.001	1907.599998	-0.001

Frequency Error vs. Voltage

Voltage (Volts)	LTE Band 2			
	Channel Bandwidth: 1.4 MHz			
	Low Channel		High Channel	
	Frequency (MHz)	Frequency Error (ppm)	Frequency (MHz)	Frequency Error (ppm)
3.86	1850.700004	0.002	1909.300000	0.002
3.28	1850.700003	0.001	1909.300001	0.001
4.44	1850.700002	0.001	1909.300003	0.002

Note: The applicant defined the normal working voltage is from 3.28Vdc to 4.44Vdc.

Frequency Error vs. Temperature

Temp. (°C)	LTE Band 2			
	Channel Bandwidth: 1.4 MHz			
	Low Channel		High Channel	
	Frequency (MHz)	Frequency Error (ppm)	Frequency (MHz)	Frequency Error (ppm)
-30	1850.700003	0.002	1909.300003	0.001
-20	1850.700004	0.002	1909.300002	0.001
-10	1850.700002	0.001	1909.300004	0.002
0	1850.700001	0.001	1909.300003	0.001
10	1850.700003	0.002	1909.300003	0.002
20	1850.699998	-0.001	1909.299998	-0.001
30	1850.699997	-0.002	1909.299998	-0.001
40	1850.699996	-0.002	1909.299997	-0.001
50	1850.699998	-0.001	1909.299998	-0.001

Frequency Error vs. Voltage

Voltage (Volts)	LTE Band 2			
	Channel Bandwidth: 3 MHz			
	Low Channel		High Channel	
	Frequency (MHz)	Frequency Error (ppm)	Frequency (MHz)	Frequency Error (ppm)
3.86	1851.500003	0.001	1908.500003	0.002
3.28	1851.500002	0.001	1908.500003	0.002
4.44	1851.500002	0.001	1908.500004	0.002

Note: The applicant defined the normal working voltage is from 3.28Vdc to 4.44Vdc.

Frequency Error vs. Temperature

Temp. (°C)	LTE Band 2			
	Channel Bandwidth: 3 MHz			
	Low Channel		High Channel	
	Frequency (MHz)	Frequency Error (ppm)	Frequency (MHz)	Frequency Error (ppm)
-30	1851.500004	0.002	1908.500004	0.002
-20	1851.500002	0.001	1908.500004	0.002
-10	1851.500003	0.002	1908.500001	0.001
0	1851.500002	0.001	1908.500004	0.002
10	1851.500003	0.002	1908.500002	0.001
20	1851.499996	-0.002	1908.499996	-0.002
30	1851.499997	-0.002	1908.499997	-0.002
40	1851.499997	-0.002	1908.499996	-0.002
50	1851.499998	-0.001	1908.499998	-0.001

Frequency Error vs. Voltage

Voltage (Volts)	LTE Band 2			
	Channel Bandwidth: 5 MHz			
	Low Channel		High Channel	
	Frequency (MHz)	Frequency Error (ppm)	Frequency (MHz)	Frequency Error (ppm)
3.86	1852.500003	0.002	1907.500003	0.002
3.28	1852.500002	0.001	1907.500001	0.001
4.44	1852.500001	0.001	1907.500002	0.001

Note: The applicant defined the normal working voltage is from 3.28Vdc to 4.44Vdc.

Frequency Error vs. Temperature

Temp. (°C)	LTE Band 2			
	Channel Bandwidth: 5 MHz			
	Low Channel		High Channel	
	Frequency (MHz)	Frequency Error (ppm)	Frequency (MHz)	Frequency Error (ppm)
-30	1852.500003	0.002	1907.500002	0.001
-20	1852.500002	0.001	1907.500004	0.002
-10	1852.500002	0.001	1907.500002	0.001
0	1852.500003	0.002	1907.500001	0.001
10	1852.500002	0.001	1907.500004	0.002
20	1852.499998	-0.001	1907.499997	-0.002
30	1852.499997	-0.002	1907.499997	-0.002
40	1852.499996	-0.002	1907.499998	-0.001
50	1852.499998	-0.001	1907.499999	-0.001

Frequency Error vs. Voltage

Voltage (Volts)	LTE Band 2			
	Channel Bandwidth: 10 MHz			
	Low Channel		High Channel	
	Frequency (MHz)	Frequency Error (ppm)	Frequency (MHz)	Frequency Error (ppm)
3.86	1855.000002	0.001	1905.000004	0.002
3.28	1855.000001	0.001	1905.000002	0.001
4.44	1855.000001	0.001	1905.000002	0.001

Note: The applicant defined the normal working voltage is from 3.28Vdc to 4.44Vdc.

Frequency Error vs. Temperature

Temp. (°C)	LTE Band 2			
	Channel Bandwidth: 10 MHz			
	Low Channel		High Channel	
	Frequency (MHz)	Frequency Error (ppm)	Frequency (MHz)	Frequency Error (ppm)
-30	1855.000004	0.002	1905.000003	0.002
-20	1855.000003	0.001	1905.000001	0.001
-10	1855.000004	0.002	1905.000003	0.002
0	1855.000002	0.001	1905.000004	0.002
10	1855.000003	0.001	1905.000004	0.002
20	1854.999996	-0.002	1904.999999	-0.001
30	1854.999999	-0.001	1904.999998	-0.001
40	1854.999997	-0.002	1904.999996	-0.002
50	1854.999997	-0.002	1904.999998	-0.001

Frequency Error vs. Voltage

Voltage (Volts)	LTE Band 2			
	Channel Bandwidth: 15 MHz			
	Low Channel		High Channel	
	Frequency (MHz)	Frequency Error (ppm)	Frequency (MHz)	Frequency Error (ppm)
3.86	1857.500004	0.002	1902.500003	0.002
3.28	1857.500002	0.001	1902.500002	0.001
4.44	1857.500003	0.002	1902.500002	0.001

Note: The applicant defined the normal working voltage is from 3.28Vdc to 4.44Vdc.

Frequency Error vs. Temperature

Temp. (°C)	LTE Band 2			
	Channel Bandwidth: 15 MHz			
	Low Channel		High Channel	
	Frequency (MHz)	Frequency Error (ppm)	Frequency (MHz)	Frequency Error (ppm)
-30	1857.500003	0.002	1902.500004	0.002
-20	1857.500001	0.001	1902.500002	0.001
-10	1857.500001	0.001	1902.500002	0.001
0	1857.500002	0.001	1902.500002	0.001
10	1857.500004	0.002	1902.500002	0.001
20	1857.499998	-0.001	1902.499999	-0.001
30	1857.499996	-0.002	1902.499998	-0.001
40	1857.499999	-0.001	1902.499996	-0.002
50	1857.499996	-0.002	1902.499998	-0.001

Frequency Error vs. Voltage

Voltage (Volts)	LTE Band 2			
	Channel Bandwidth: 20 MHz			
	Low Channel		High Channel	
	Frequency (MHz)	Frequency Error (ppm)	Frequency (MHz)	Frequency Error (ppm)
3.86	1860.000002	0.001	1900.000004	0.002
3.28	1860.000002	0.001	1900.000003	0.001
4.44	1860.000002	0.001	1900.000004	0.002

Note: The applicant defined the normal working voltage is from 3.28Vdc to 4.44Vdc.

Frequency Error vs. Temperature

Temp. (°C)	LTE Band 2			
	Channel Bandwidth: 20 MHz			
	Low Channel		High Channel	
	Frequency (MHz)	Frequency Error (ppm)	Frequency (MHz)	Frequency Error (ppm)
-30	1860.000004	0.002	1900.000003	0.002
-20	1860.000004	0.002	1900.000002	0.001
-10	1860.000001	0.001	1900.000002	0.001
0	1860.000003	0.002	1900.000001	0.001
10	1860.000002	0.001	1900.000004	0.002
20	1859.999999	-0.001	1899.999998	-0.001
30	1859.999997	-0.002	1899.999998	-0.001
40	1859.999996	-0.002	1899.999998	-0.001
50	1859.999997	-0.002	1899.999997	-0.001

Frequency Error vs. Voltage

Voltage (Volts)	LTE Band 25			
	Channel Bandwidth: 1.4 MHz			
	Low Channel		High Channel	
	Frequency (MHz)	Frequency Error (ppm)	Frequency (MHz)	Frequency Error (ppm)
3.86	1850.700001	0.001	1914.300003	0.001
3.28	1850.700003	0.002	1914.300004	0.002
4.44	1850.700003	0.002	1914.300001	0.001

Note: The applicant defined the normal working voltage is from 3.28Vdc to 4.44Vdc.

Frequency Error vs. Temperature

Temp. (°C)	LTE Band 25			
	Channel Bandwidth: 1.4 MHz			
	Low Channel		High Channel	
	Frequency (MHz)	Frequency Error (ppm)	Frequency (MHz)	Frequency Error (ppm)
-30	1850.700003	0.002	1914.300002	0.001
-20	1850.700003	0.002	1914.300001	0.001
-10	1850.700002	0.001	1914.300002	0.001
0	1850.700001	0.001	1914.300002	0.001
10	1850.700004	0.002	1914.300004	0.002
20	1850.699998	-0.001	1914.299998	-0.001
30	1850.699997	-0.002	1914.299998	-0.001
40	1850.699996	-0.002	1914.299998	-0.001
50	1850.699999	-0.001	1914.299998	-0.001

Frequency Error vs. Voltage

Voltage (Volts)	LTE Band 25			
	Channel Bandwidth: 3 MHz			
	Low Channel		High Channel	
	Frequency (MHz)	Frequency Error (ppm)	Frequency (MHz)	Frequency Error (ppm)
3.86	1851.500004	0.002	1913.500003	0.001
3.28	1851.500003	0.002	1913.500003	0.001
4.44	1851.500003	0.002	1913.500002	0.001

Note: The applicant defined the normal working voltage is from 3.28Vdc to 4.44Vdc.

Frequency Error vs. Temperature

Temp. (°C)	LTE Band 25			
	Channel Bandwidth: 3 MHz			
	Low Channel		High Channel	
	Frequency (MHz)	Frequency Error (ppm)	Frequency (MHz)	Frequency Error (ppm)
-30	1851.500002	0.001	1913.500003	0.001
-20	1851.500001	0.001	1913.500004	0.002
-10	1851.500002	0.001	1913.500003	0.002
0	1851.500003	0.002	1913.500002	0.001
10	1851.500002	0.001	1913.500003	0.002
20	1851.499996	-0.002	1913.499996	-0.002
30	1851.499997	-0.002	1913.499997	-0.002
40	1851.499998	-0.001	1913.499998	-0.001
50	1851.499998	-0.001	1913.499997	-0.002

Frequency Error vs. Voltage

Voltage (Volts)	LTE Band 25			
	Channel Bandwidth: 5 MHz			
	Low Channel		High Channel	
	Frequency (MHz)	Frequency Error (ppm)	Frequency (MHz)	Frequency Error (ppm)
3.86	1852.500004	0.002	1912.500003	0.002
3.28	1852.500004	0.002	1912.500002	0.001
4.44	1852.500004	0.002	1912.500004	0.002

Note: The applicant defined the normal working voltage is from 3.28Vdc to 4.44Vdc.

Frequency Error vs. Temperature

Temp. (°C)	LTE Band 25			
	Channel Bandwidth: 5 MHz			
	Low Channel		High Channel	
	Frequency (MHz)	Frequency Error (ppm)	Frequency (MHz)	Frequency Error (ppm)
-30	1852.500001	0.001	1912.500003	0.002
-20	1852.500003	0.002	1912.500003	0.001
-10	1852.500003	0.002	1912.500004	0.002
0	1852.500003	0.002	1912.500002	0.001
10	1852.500004	0.002	1912.500003	0.002
20	1852.499998	-0.001	1912.499999	-0.001
30	1852.499997	-0.002	1912.499998	-0.001
40	1852.499997	-0.002	1912.499999	-0.001
50	1852.499997	-0.002	1912.499998	-0.001

Frequency Error vs. Voltage

Voltage (Volts)	LTE Band 25			
	Channel Bandwidth: 10 MHz			
	Low Channel		High Channel	
	Frequency (MHz)	Frequency Error (ppm)	Frequency (MHz)	Frequency Error (ppm)
3.86	1855.000003	0.002	1910.000002	0.001
3.28	1855.000002	0.001	1910.000002	0.001
4.44	1855.000002	0.001	1910.000002	0.001

Note: The applicant defined the normal working voltage is from 3.28Vdc to 4.44Vdc.

Frequency Error vs. Temperature

Temp. (°C)	LTE Band 25			
	Channel Bandwidth: 10 MHz			
	Low Channel		High Channel	
	Frequency (MHz)	Frequency Error (ppm)	Frequency (MHz)	Frequency Error (ppm)
-30	1855.000003	0.001	1910.000002	0.001
-20	1855.000003	0.002	1910.000003	0.002
-10	1855.000004	0.002	1910.000002	0.001
0	1855.000004	0.002	1910.000003	0.001
10	1855.000004	0.002	1910.000003	0.002
20	1854.999998	-0.001	1909.999997	-0.002
30	1854.999998	-0.001	1909.999997	-0.002
40	1854.999998	-0.001	1909.999999	-0.001
50	1854.999999	-0.001	1909.999998	-0.001

Frequency Error vs. Voltage

Voltage (Volts)	LTE Band 25			
	Channel Bandwidth: 15 MHz			
	Low Channel		High Channel	
	Frequency (MHz)	Frequency Error (ppm)	Frequency (MHz)	Frequency Error (ppm)
3.86	1857.500002	0.001	1907.500004	0.002
3.28	1857.500003	0.002	1907.500003	0.001
4.44	1857.500004	0.002	1907.500004	0.002

Note: The applicant defined the normal working voltage is from 3.28Vdc to 4.44Vdc.

Frequency Error vs. Temperature

Temp. (°C)	LTE Band 25			
	Channel Bandwidth: 15 MHz			
	Low Channel		High Channel	
	Frequency (MHz)	Frequency Error (ppm)	Frequency (MHz)	Frequency Error (ppm)
-30	1857.500003	0.002	1907.500001	0.001
-20	1857.500002	0.001	1907.500002	0.001
-10	1857.500003	0.002	1907.500003	0.002
0	1857.500003	0.002	1907.500004	0.002
10	1857.500001	0.001	1907.500002	0.001
20	1857.499997	-0.001	1907.499996	-0.002
30	1857.499997	-0.002	1907.499997	-0.002
40	1857.499998	-0.001	1907.499997	-0.002
50	1857.499997	-0.002	1907.499996	-0.002

Frequency Error vs. Voltage

Voltage (Volts)	LTE Band 25			
	Channel Bandwidth: 20 MHz			
	Low Channel		High Channel	
	Frequency (MHz)	Frequency Error (ppm)	Frequency (MHz)	Frequency Error (ppm)
3.86	1860.000003	0.002	1905.000002	0.001
3.28	1860.000002	0.001	1905.000002	0.001
4.44	1860.000002	0.001	1905.000003	0.002

Note: The applicant defined the normal working voltage is from 3.28Vdc to 4.44Vdc.

Frequency Error vs. Temperature

Temp. (°C)	LTE Band 25			
	Channel Bandwidth: 20 MHz			
	Low Channel		High Channel	
	Frequency (MHz)	Frequency Error (ppm)	Frequency (MHz)	Frequency Error (ppm)
-30	1860.000001	0.001	1905.000004	0.002
-20	1860.000003	0.002	1905.000002	0.001
-10	1860.000004	0.002	1905.000002	0.001
0	1860.000003	0.002	1905.000003	0.002
10	1860.000003	0.002	1905.000003	0.001
20	1859.999997	-0.002	1904.999997	-0.002
30	1859.999999	-0.001	1904.999998	-0.001
40	1859.999997	-0.002	1904.999998	-0.001
50	1859.999997	-0.001	1904.999998	-0.001

4.4 Occupied Bandwidth Measurement

4.4.1 Test Procedure

The EUT makes a call to the communication simulator. All measurements were done at low, middle and high operational frequency range. The communication simulator station system controlled a EUT to export maximum output power under transmission mode and specific channel frequency. Use OBW measurement function of Spectrum analyzer to measure 99 % occupied bandwidth.

4.4.2 Test Setup

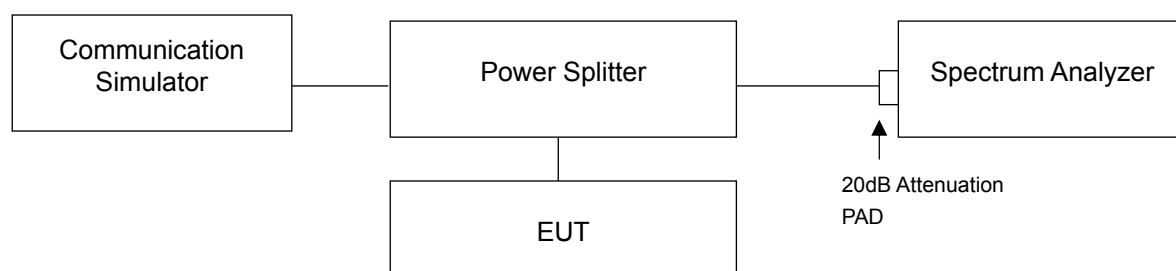

4.4.3 Test Result

Occupied Bandwidth

Channel	Frequency (MHz)	99% Occupied Bandwidth (kHz)		
		PCS	GPRS	EDGE
512	1850.2	244.81	244.28	243.50
661	1880.0	244.14	244.16	243.43
810	1909.8	243.15	246.06	244.94

Spectrum Plot of Worst Value

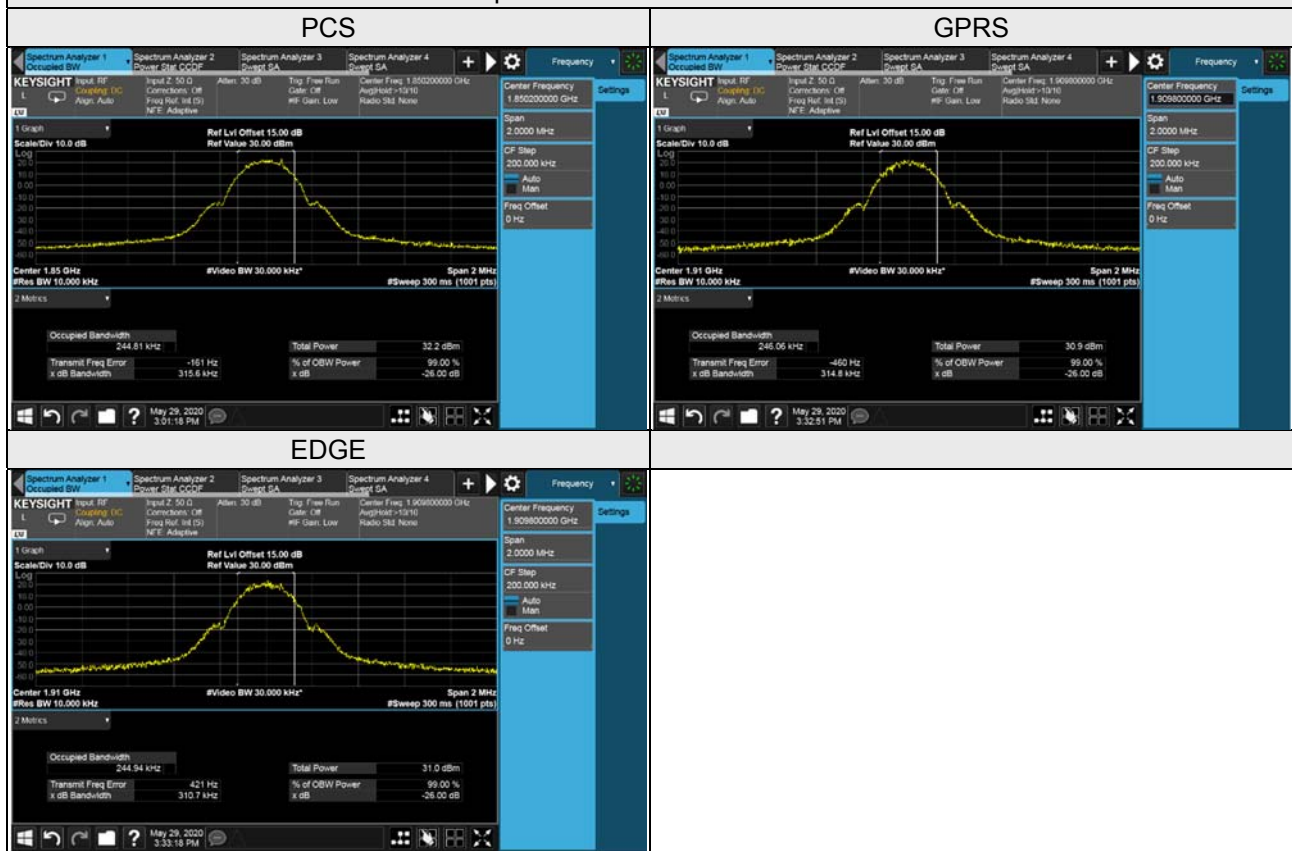

Occupied Bandwidth

WCDMA Band 2					
Channel	Frequency (MHz)	99% Occupied Bandwidth (MHz)			
		WCDMA	HSDPA	HSUPA	
9262	1852.4	4.16	4.15	4.15	
9400	1880.0	4.15	4.15	4.15	
9538	1907.6	4.15	4.15	4.15	

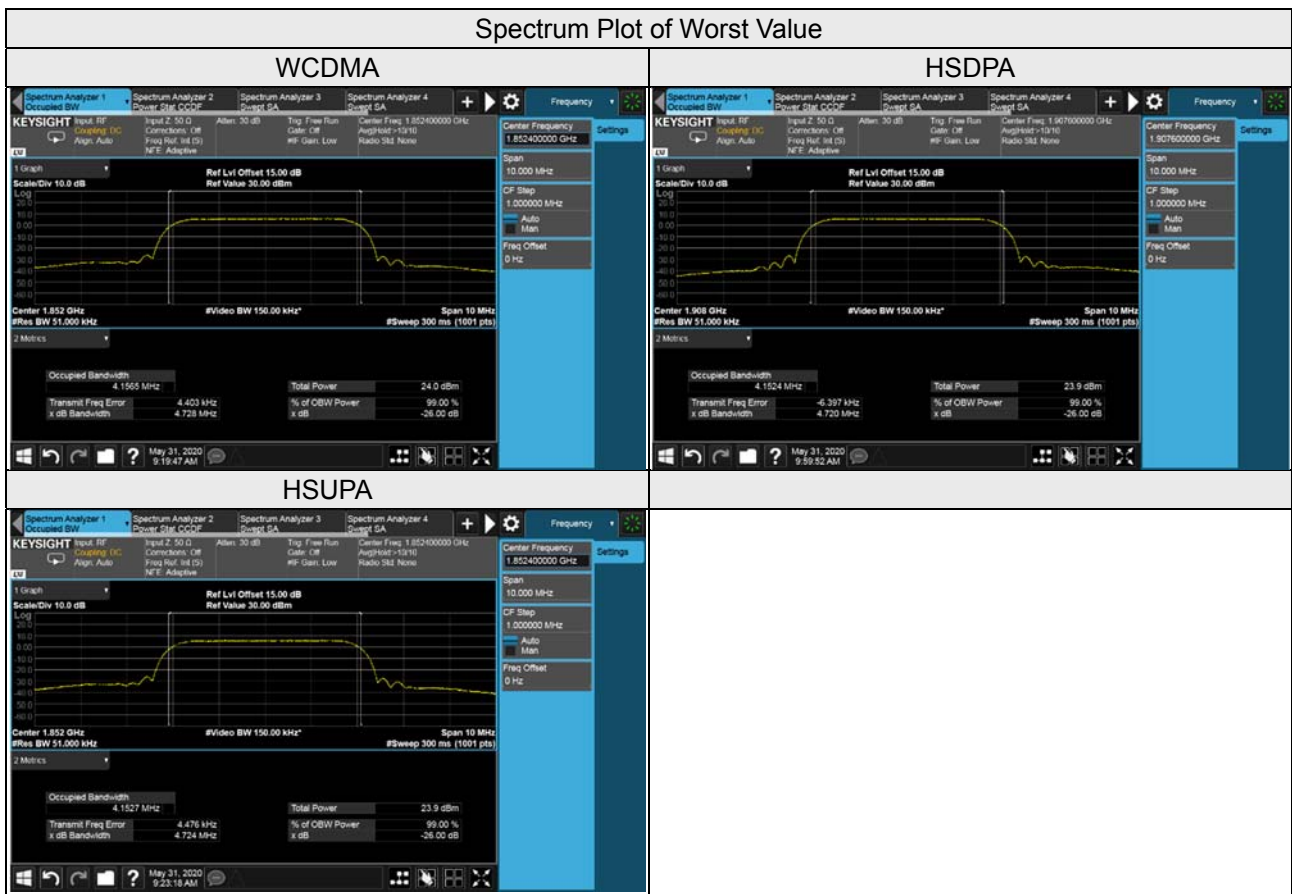

LTE Band 2, Channel Bandwidth 1.4MHz				
Channel	Frequency (MHz)	99% Occupied Bandwidth (MHz)		
		QPSK	16QAM	64QAM
18607	1850.7	1.09	1.09	1.09
18900	1880.0	1.09	1.09	1.09
19193	1909.3	1.09	1.09	1.09

LTE Band 2, Channel Bandwidth 3MHz				
Channel	Frequency (MHz)	99% Occupied Bandwidth (MHz)		
		QPSK	16QAM	64QAM
18615	1851.5	2.70	2.69	2.70
18900	1880.0	2.70	2.69	2.70
19185	1908.5	2.70	2.69	2.70

LTE Band 2, Channel Bandwidth 5MHz				
Channel	Frequency (MHz)	99% Occupied Bandwidth (MHz)		
		QPSK	16QAM	64QAM
18625	1852.5	4.49	4.49	4.49
18900	1880.0	4.49	4.49	4.50
19175	1907.5	4.49	4.49	4.49

LTE Band 2, Channel Bandwidth 10MHz				
Channel	Frequency (MHz)	99% Occupied Bandwidth (MHz)		
		QPSK	16QAM	64QAM
18650	1855.0	8.96	8.96	8.96
18900	1880.0	8.96	8.96	8.96
19150	1905.0	8.95	8.96	8.96

LTE Band 2, Channel Bandwidth 15MHz				
Channel	Frequency (MHz)	99% Occupied Bandwidth (MHz)		
		QPSK	16QAM	64QAM
18675	1857.5	13.45	13.44	13.43
18900	1880.0	13.46	13.44	13.44
19125	1902.5	13.45	13.44	13.44

LTE Band 2, Channel Bandwidth 20MHz				
Channel	Frequency (MHz)	99% Occupied Bandwidth (MHz)		
		QPSK	16QAM	64QAM
18700	1860.0	17.91	17.93	17.91
18900	1880.0	17.91	17.93	17.93
19100	1900.0	17.91	17.93	17.93

Spectrum Plot of Worst Value

1.4MHz / 16QAM

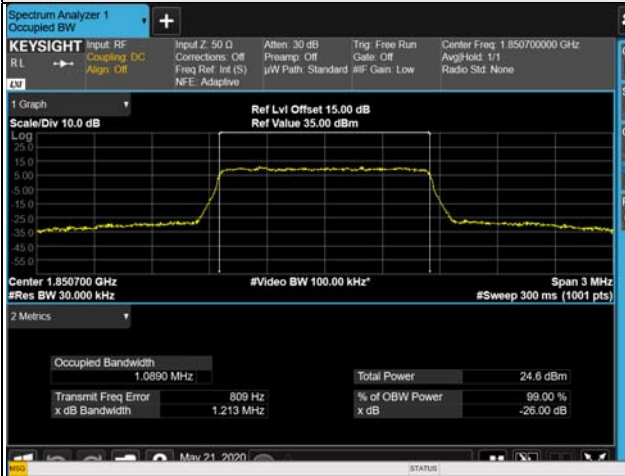

3MHz / QPSK



5MHz / 64QAM

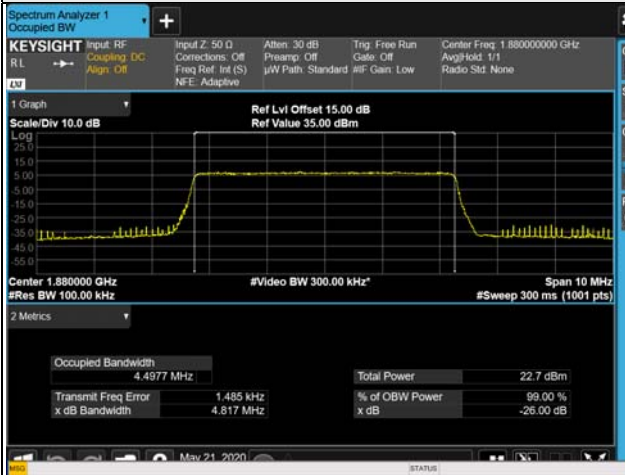

10MHz / 64QAM

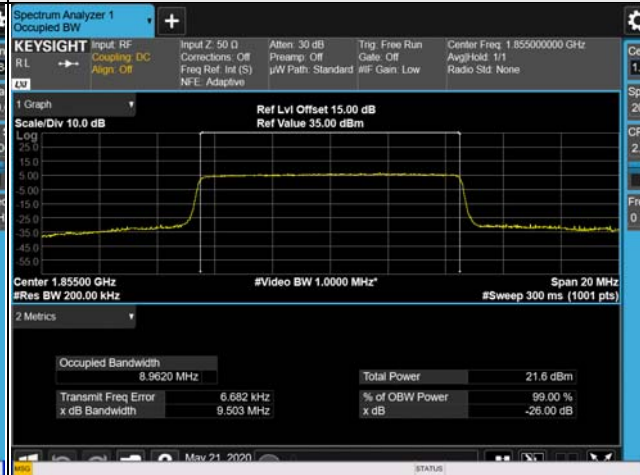

15MHz / QPSK

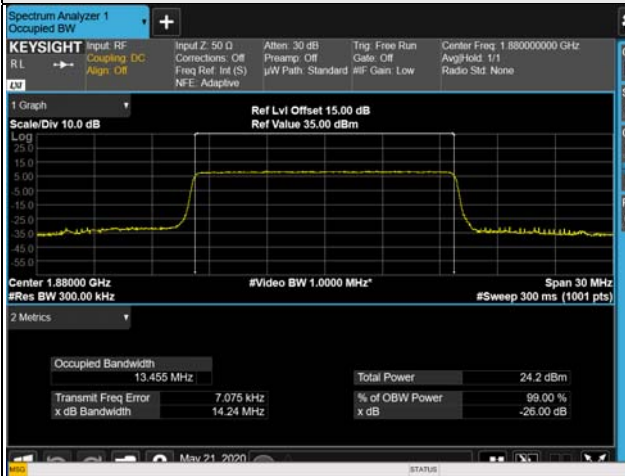

20MHz / 16QAM



LTE Band 25, Channel Bandwidth 1.4MHz				
Channel	Frequency (MHz)	99% Occupied Bandwidth (MHz)		
		QPSK	16QAM	64QAM
26047	1850.7	1.09	1.09	1.09
26365	1882.5	1.09	1.09	1.09
26683	1914.3	1.09	1.09	1.09

LTE Band 25, Channel Bandwidth 3MHz				
Channel	Frequency (MHz)	99% Occupied Bandwidth (MHz)		
		QPSK	16QAM	64QAM
26055	1851.5	2.70	2.70	2.70
26365	1882.5	2.70	2.69	2.70
26675	1913.5	2.70	2.70	2.70

LTE Band 25, Channel Bandwidth 5MHz				
Channel	Frequency (MHz)	99% Occupied Bandwidth (MHz)		
		QPSK	16QAM	64QAM
26065	1852.5	4.49	4.49	4.49
26365	1882.5	4.49	4.49	4.49
26665	1912.5	4.49	4.49	4.49

LTE Band 25, Channel Bandwidth 10MHz				
Channel	Frequency (MHz)	99% Occupied Bandwidth (MHz)		
		QPSK	16QAM	64QAM
26090	1855.0	8.96	8.96	8.95
26365	1882.5	8.96	8.95	8.95
26640	1910.0	8.95	8.95	8.95

LTE Band 25, Channel Bandwidth 15MHz				
Channel	Frequency (MHz)	99% Occupied Bandwidth (MHz)		
		QPSK	16QAM	64QAM
26115	1857.5	13.46	13.44	13.44
26365	1882.5	13.45	13.44	13.43
26615	1907.5	13.45	13.44	13.43

LTE Band 25, Channel Bandwidth 20MHz				
Channel	Frequency (MHz)	99% Occupied Bandwidth (MHz)		
		QPSK	16QAM	64QAM
26140	1860.0	17.92	17.93	17.92
26365	1882.5	17.92	17.93	17.92
26590	1905.0	17.90	17.92	17.92

Spectrum Plot of Worst Value

1.4MHz / 16QAM

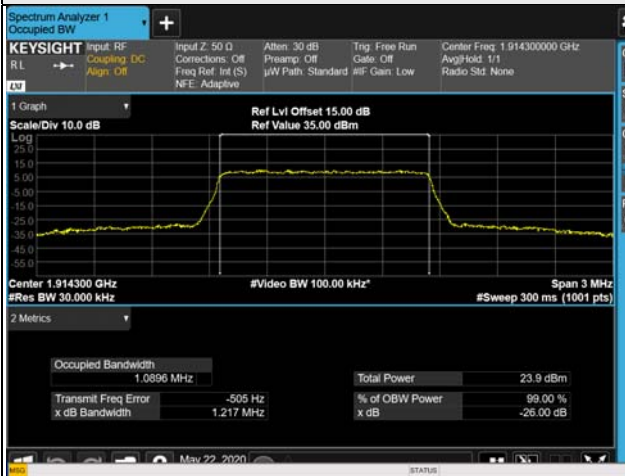

3MHz / 64QAM



5MHz / 64QAM

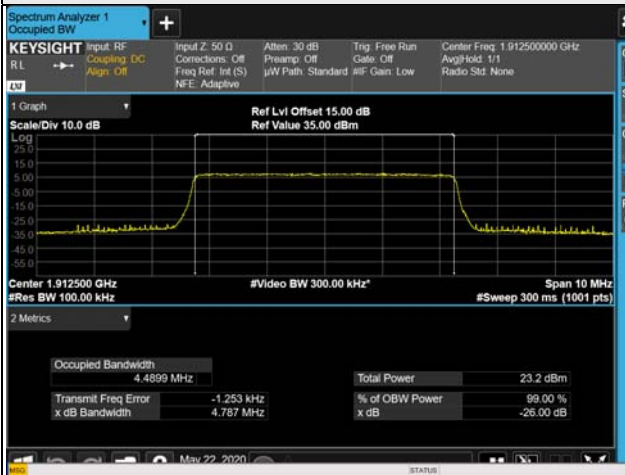

10MHz / 16QAM



15MHz / QPSK

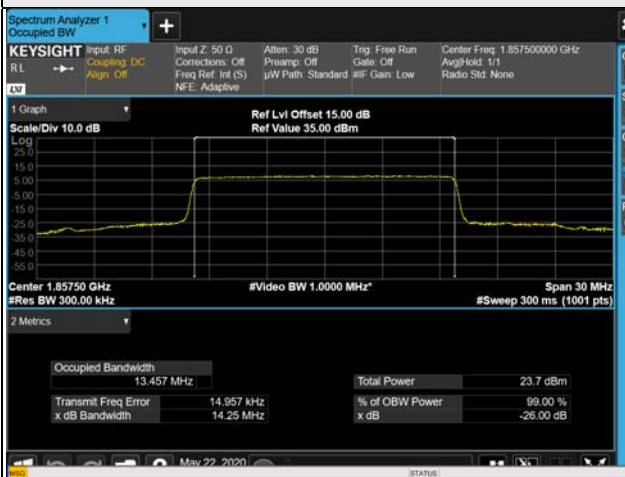

20MHz / 16QAM



26dB Bandwidth

Channel	Frequency (MHz)	26dBc Bandwidth (MHz)		
		PCS	GPRS	EDGE
512	1850.2	315.60	316.90	312.40
661	1880.0	312.10	310.20	313.70
810	1909.8	313.90	314.80	310.70

Spectrum Plot of Worst Value

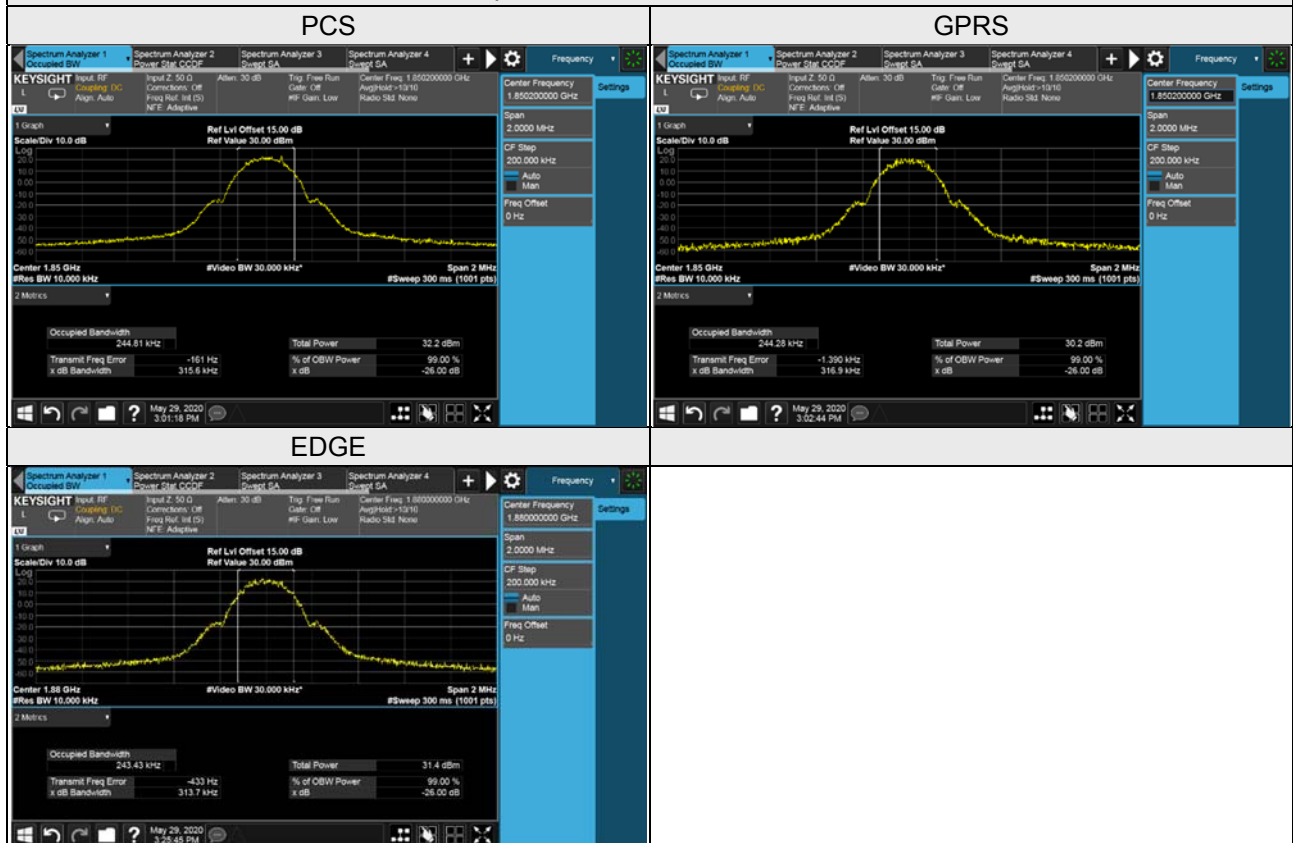

26dB Bandwidth

WCDMA Band 2				
Channel	Frequency (MHz)	26dBc Bandwidth (MHz)		
		WCDMA	HSDPA	HSUPA
9262	1852.4	4.73	4.73	4.72
9400	1880.0	4.72	4.72	4.72
9538	1907.6	4.72	4.72	4.73

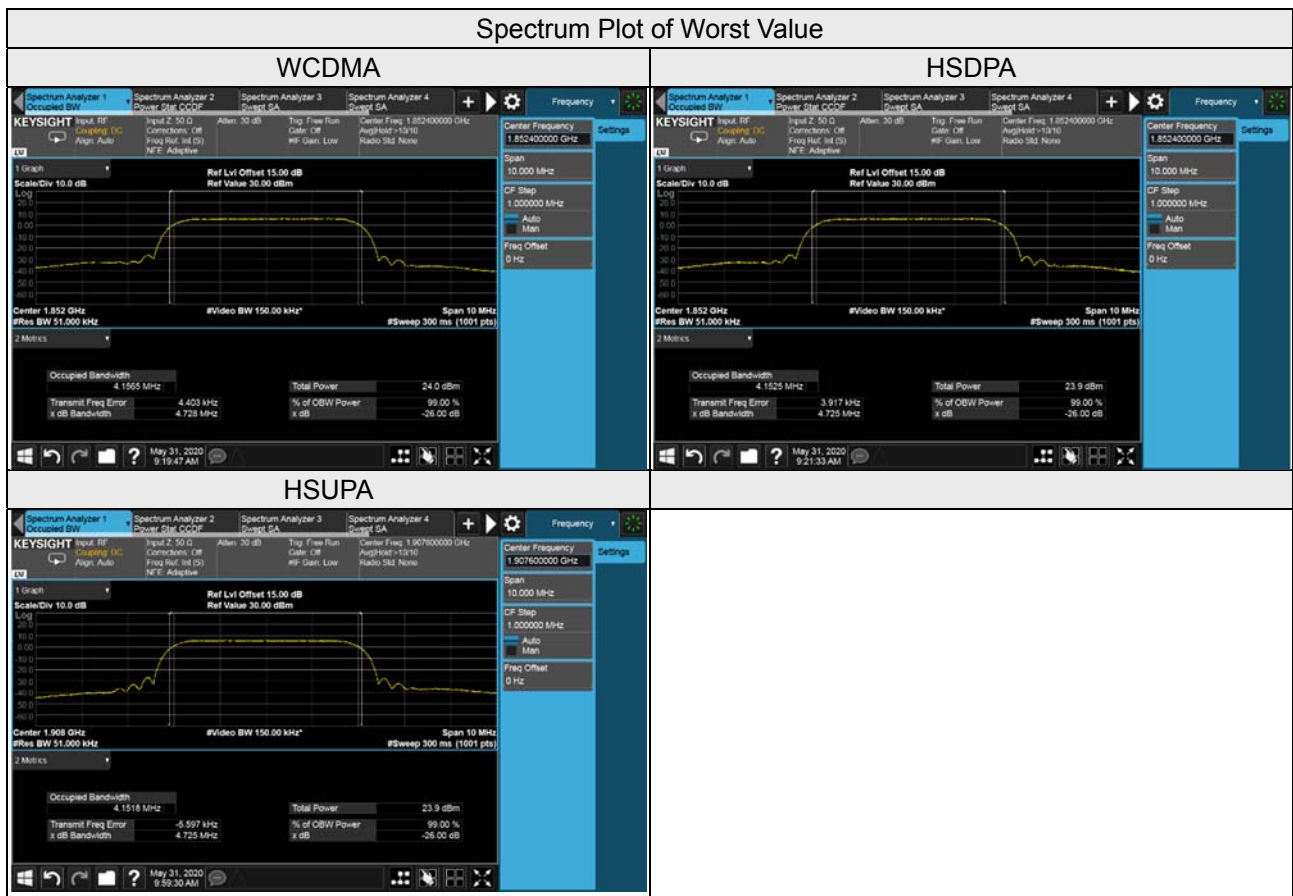

LTE Band 2, Channel Bandwidth 1.4MHz				
Channel	Frequency (MHz)	26dBc Bandwidth (MHz)		
		QPSK	16QAM	64QAM
18607	1850.7	1.21	1.21	1.22
18900	1880.0	1.22	1.21	1.22
19193	1909.3	1.21	1.21	1.22

LTE Band 2, Channel Bandwidth 3MHz				
Channel	Frequency (MHz)	26dBc Bandwidth (MHz)		
		QPSK	16QAM	64QAM
18615	1851.5	2.92	2.92	2.90
18900	1880.0	2.92	2.93	2.90
19185	1908.5	2.91	2.93	2.89

LTE Band 2, Channel Bandwidth 5MHz				
Channel	Frequency (MHz)	26dBc Bandwidth (MHz)		
		QPSK	16QAM	64QAM
18625	1852.5	4.81	4.79	4.83
18900	1880.0	4.78	4.79	4.82
19175	1907.5	4.81	4.79	4.82

LTE Band 2, Channel Bandwidth 10MHz				
Channel	Frequency (MHz)	26dBc Bandwidth (MHz)		
		QPSK	16QAM	64QAM
18650	1855.0	9.51	9.51	9.50
18900	1880.0	9.50	9.52	9.51
19150	1905.0	9.50	9.52	9.52

LTE Band 2, Channel Bandwidth 15MHz				
Channel	Frequency (MHz)	26dBc Bandwidth (MHz)		
		QPSK	16QAM	64QAM
18675	1857.5	14.28	14.26	14.24
18900	1880.0	14.24	14.24	14.24
19125	1902.5	14.24	14.24	14.23

LTE Band 2, Channel Bandwidth 20MHz				
Channel	Frequency (MHz)	26dBc Bandwidth (MHz)		
		QPSK	16QAM	64QAM
18700	1860.0	19.03	19.03	19.02
18900	1880.0	19.01	19.02	19.03
19100	1900.0	19.02	19.03	19.02

Spectrum Plot of Worst Value

1.4MHz / 64QAM

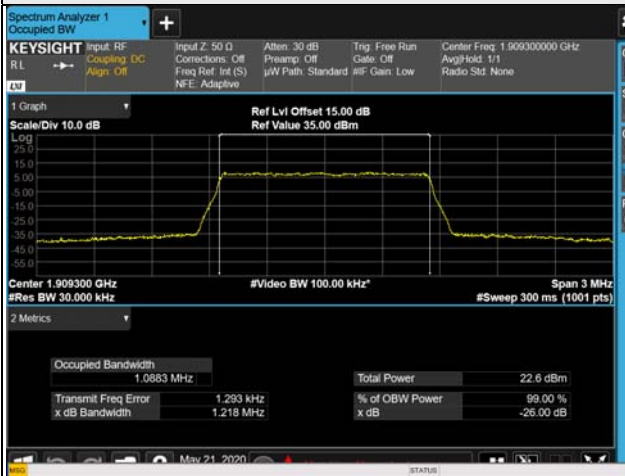

3MHz / 16QAM

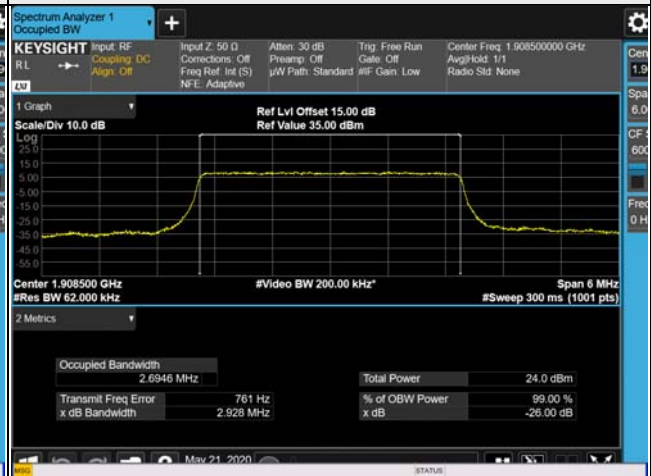

5MHz / 64QAM

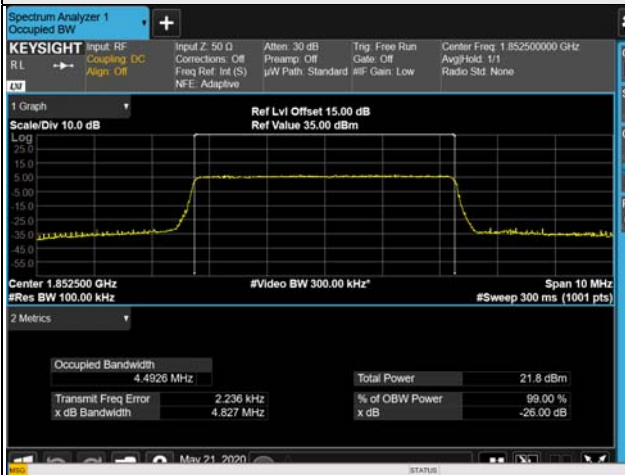

10MHz / 16QAM

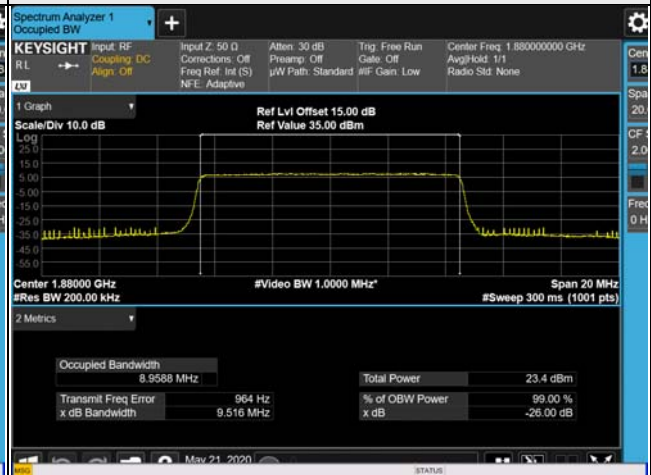

15MHz / QPSK

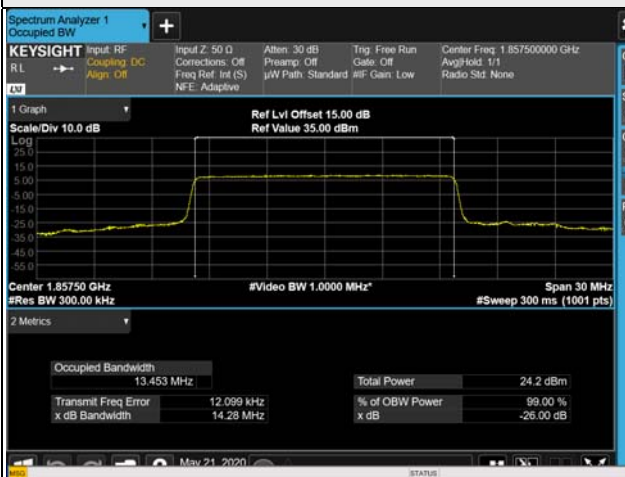

20MHz / 64QAM



LTE Band 25, Channel Bandwidth 1.4MHz				
Channel	Frequency (MHz)	26dBc Bandwidth (MHz)		
		QPSK	16QAM	64QAM
26047	1850.7	1.21	1.21	1.22
26365	1882.5	1.22	1.21	1.22
26683	1914.3	1.22	1.22	1.22

LTE Band 25, Channel Bandwidth 3MHz				
Channel	Frequency (MHz)	26dBc Bandwidth (MHz)		
		QPSK	16QAM	64QAM
26055	1851.5	2.92	2.93	2.94
26365	1882.5	2.91	2.93	2.93
26675	1913.5	2.93	2.92	2.91

LTE Band 25, Channel Bandwidth 5MHz				
Channel	Frequency (MHz)	26dBc Bandwidth (MHz)		
		QPSK	16QAM	64QAM
26065	1852.5	4.80	4.80	4.80
26365	1882.5	4.79	4.79	4.80
26665	1912.5	4.80	4.80	4.79

LTE Band 25, Channel Bandwidth 10MHz				
Channel	Frequency (MHz)	26dBc Bandwidth (MHz)		
		QPSK	16QAM	64QAM
26090	1855.0	9.52	9.52	9.51
26365	1882.5	9.49	9.51	9.51
26640	1910.0	9.50	9.51	9.51

LTE Band 25, Channel Bandwidth 15MHz				
Channel	Frequency (MHz)	26dBc Bandwidth (MHz)		
		QPSK	16QAM	64QAM
26115	1857.5	14.25	14.26	14.25
26365	1882.5	14.23	14.25	14.22
26615	1907.5	14.25	14.24	14.24

LTE Band 25, Channel Bandwidth 20MHz				
Channel	Frequency (MHz)	26dBc Bandwidth (MHz)		
		QPSK	16QAM	64QAM
26140	1860.0	19.04	19.03	19.07
26365	1882.5	19.02	19.02	19.02
26590	1905.0	19.01	19.03	19.01

Spectrum Plot of Worst Value

1.4MHz / 64QAM



3MHz / 64QAM



5MHz / 64QAM



10MHz / 16QAM



15MHz / 16QAM



20MHz / 64QAM

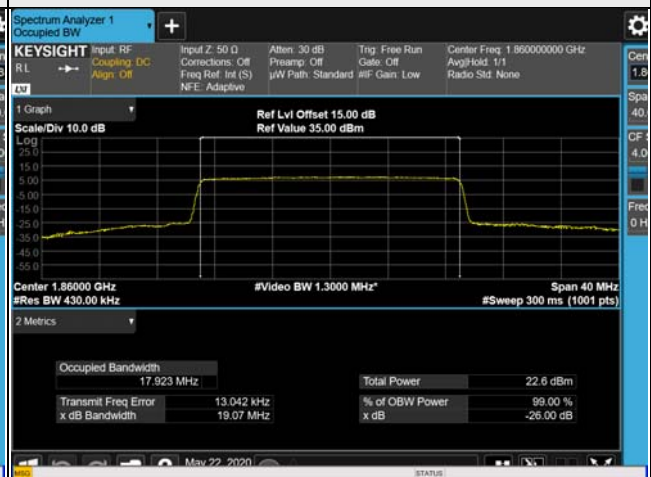

4.5 Band Edge Measurement

4.5.1 Limits of Band Edge Measurement

Power of any emission outside of the authorized operating frequency ranges must be attenuated below the transmitting power (P) by a factor of at least $43 + 10 \log(P)$ dB. In the 1 MHz bands immediately outside and adjacent to the frequency block a resolution bandwidth of at least one percent of the emission bandwidth of the fundamental emission of the transmitter may be employed.

4.5.2 Test Setup

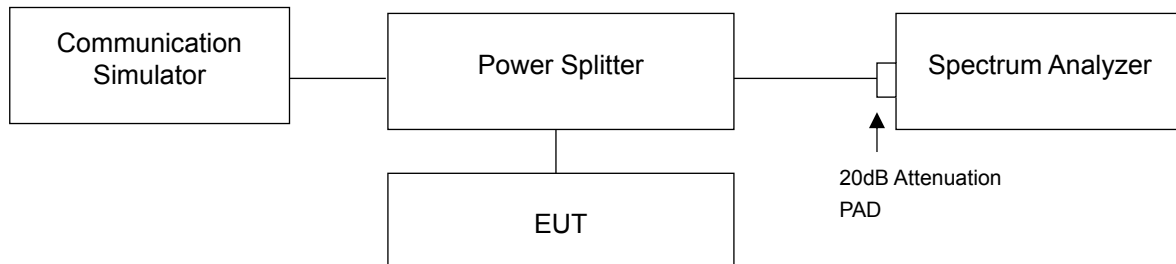

4.5.3 Test Procedures

- a. All measurements were done at low and high operational frequency range.
- b. The center frequency of spectrum is the band edge frequency and span is 1MHz. RB of the spectrum is 10kHz and VB of the spectrum is 30kHz (PCS / GPRS / EDGE).
- c. The center frequency of spectrum is the band edge frequency and span is 5MHz. RB of the spectrum is 100kHz and VB of the spectrum is 300kHz (WCDMA / HSDPA / HSUPA).
- d. The center frequency of spectrum is the band edge frequency and span is 1MHz. RB of the spectrum is 30kHz and VB of the spectrum is 100kHz (LTE Channel Bandwidth 1.4MHz).
- e. The center frequency of spectrum is the band edge frequency and span is 1MHz. RB of the spectrum is 30kHz and VB of the spectrum is 100kHz (LTE Channel Bandwidth 3MHz).
- f. The center frequency of spectrum is the band edge frequency and span is 1MHz. RB of the spectrum is 51kHz and VB of the spectrum is 160kHz (LTE Channel Bandwidth 5MHz).
- g. The center frequency of spectrum is the band edge frequency and span is 1MHz. RB of the spectrum is 100kHz and VB of the spectrum is 300kHz (LTE Channel Bandwidth 10MHz).
- h. The center frequency of spectrum is the band edge frequency and span is 1MHz. RB of the spectrum is 150kHz and VB of the spectrum is 470kHz (LTE Channel Bandwidth 15MHz).
- i. The center frequency of spectrum is the band edge frequency and span is 1MHz. RB of the spectrum is 200kHz and VB of the spectrum is 1MHz (LTE Channel Bandwidth 20MHz).
- j. Record the max trace plot into the test report.

4.5.4 Test Results

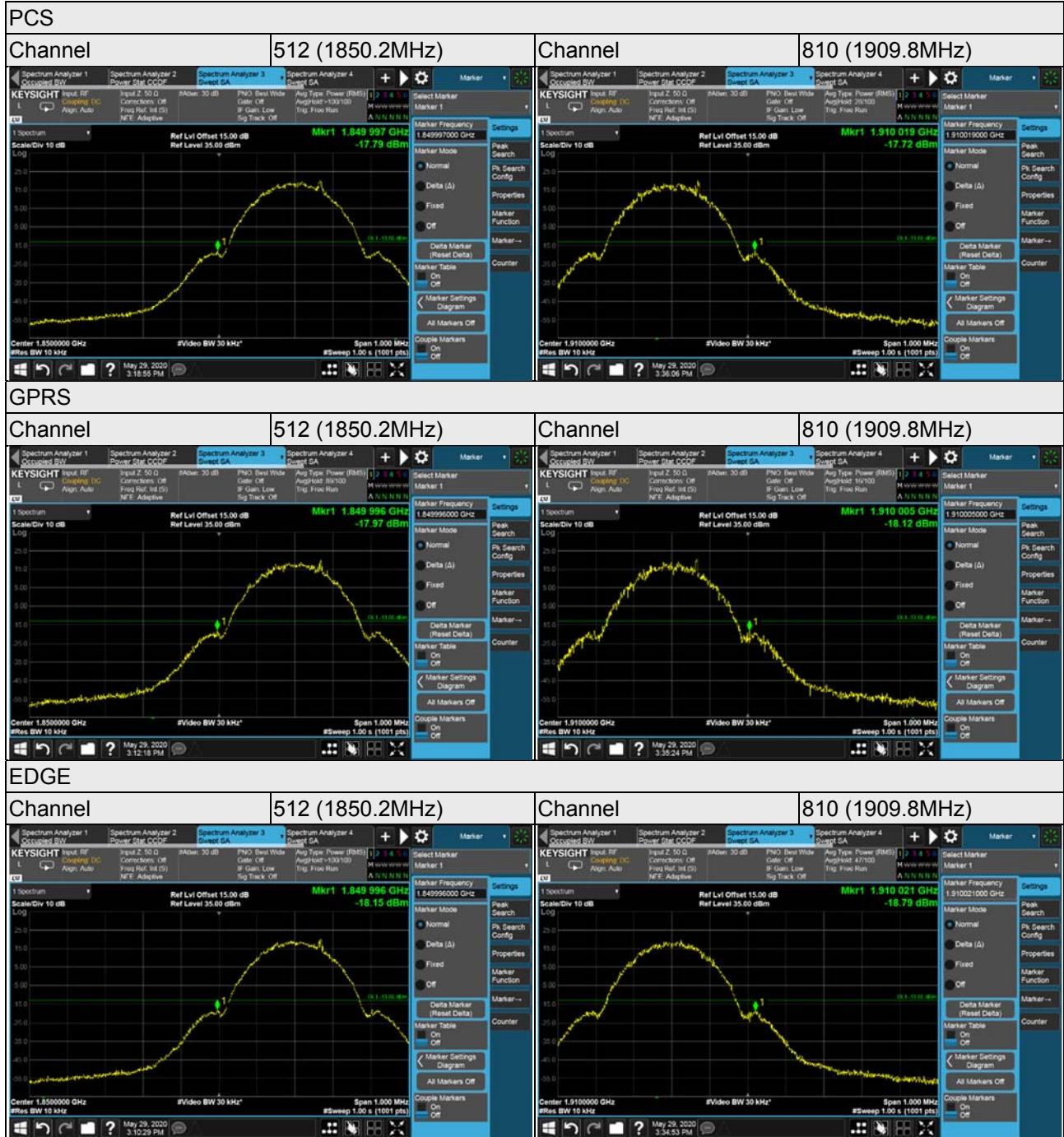

WCDMA

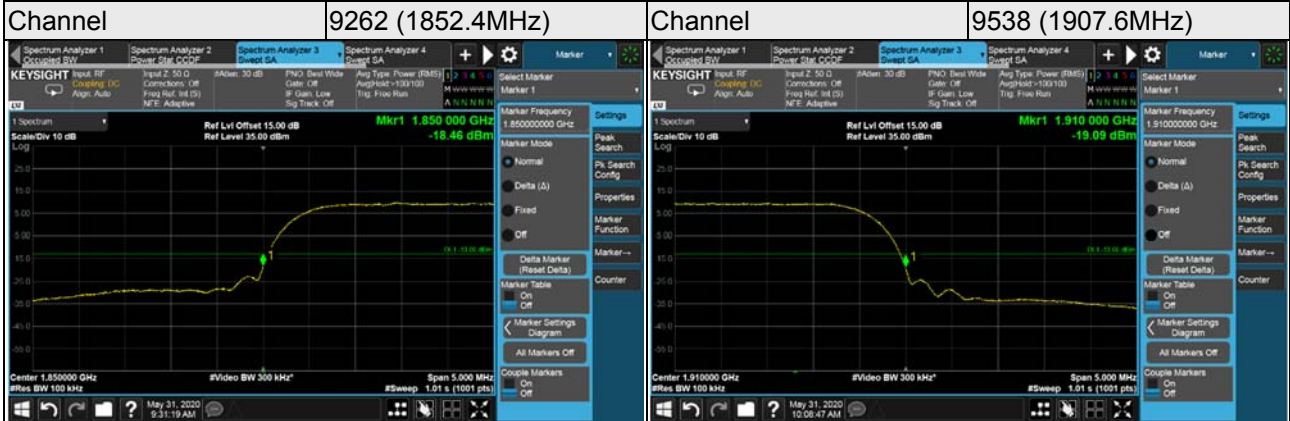

HSDPA



HSUPA

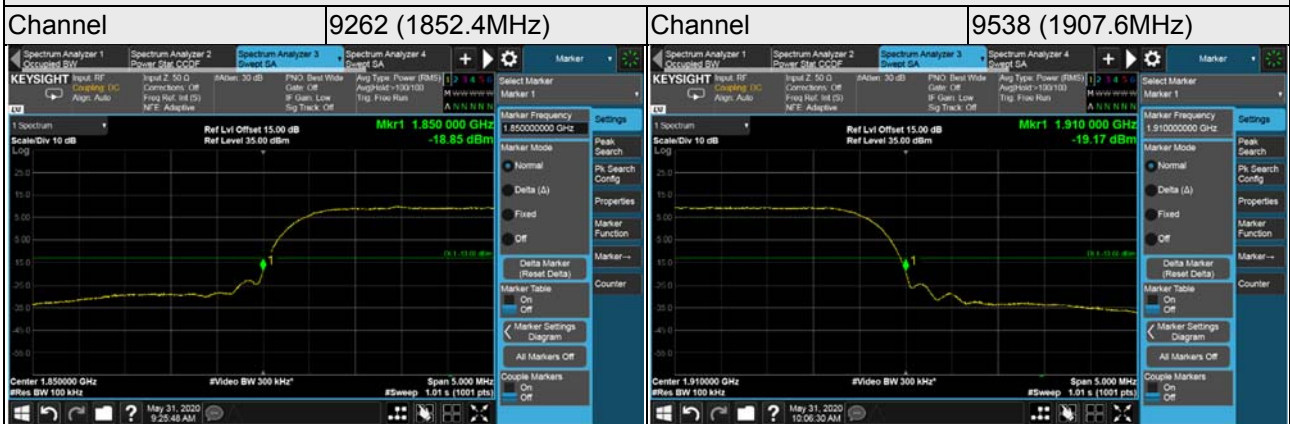

LTE Band 2, Channel Bandwidth 1.4MHz

Channel 18607
(1850.70MHz)

QPSK

1 RB / 0 RB Offset

Channel 19193
(1909.30MHz)

QPSK

1 RB / 5 RB Offset

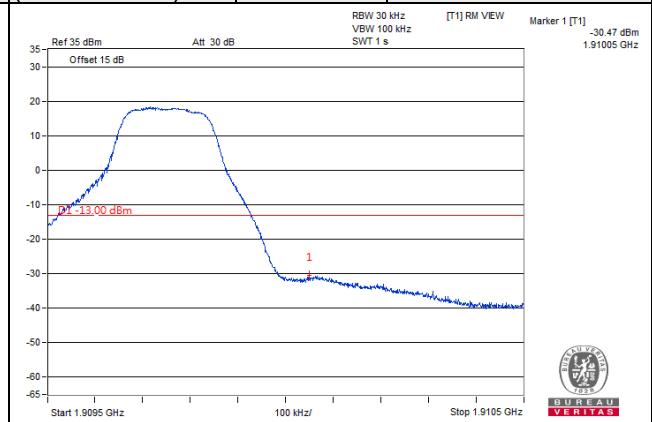
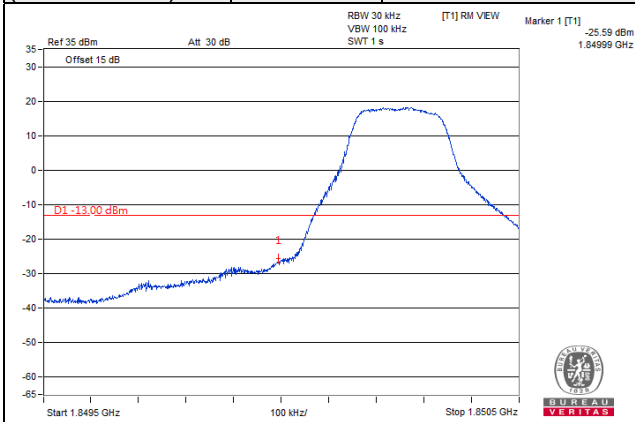

Channel 18607
(1850.70MHz)

QPSK

6 RB / 0 RB Offset

Channel 19193
(1909.30MHz)

QPSK

6 RB / 0 RB Offset

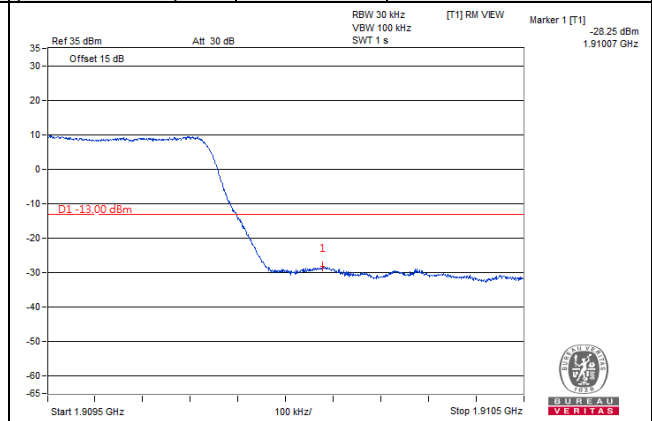
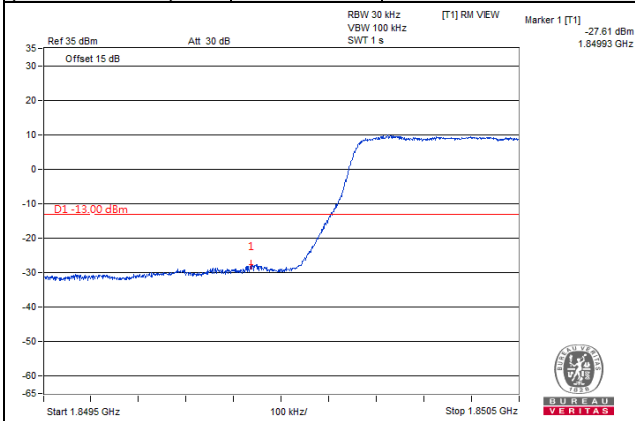

LTE Band 2, Channel Bandwidth 3MHz

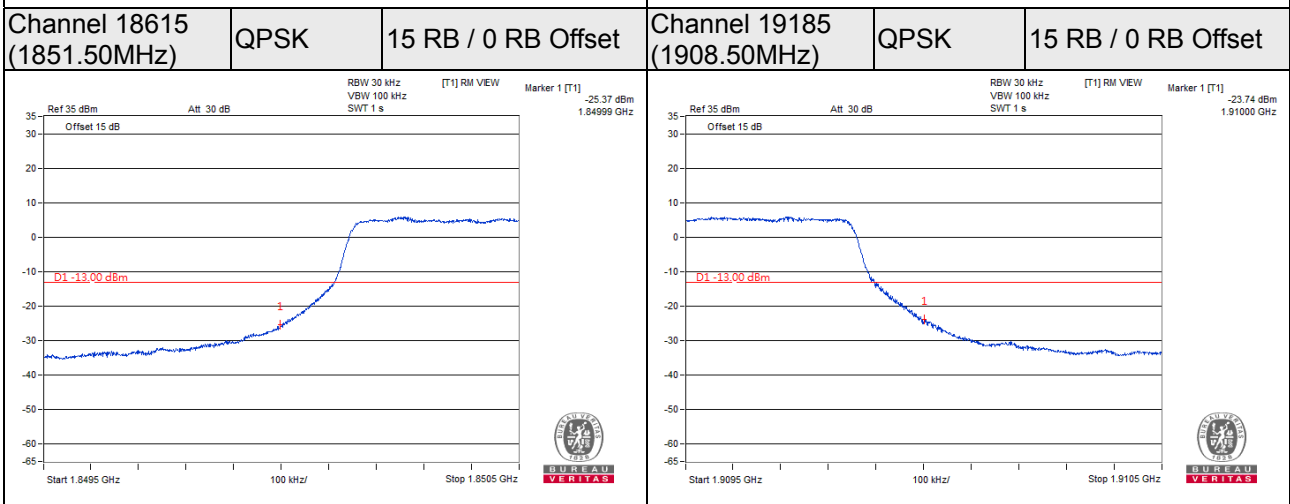
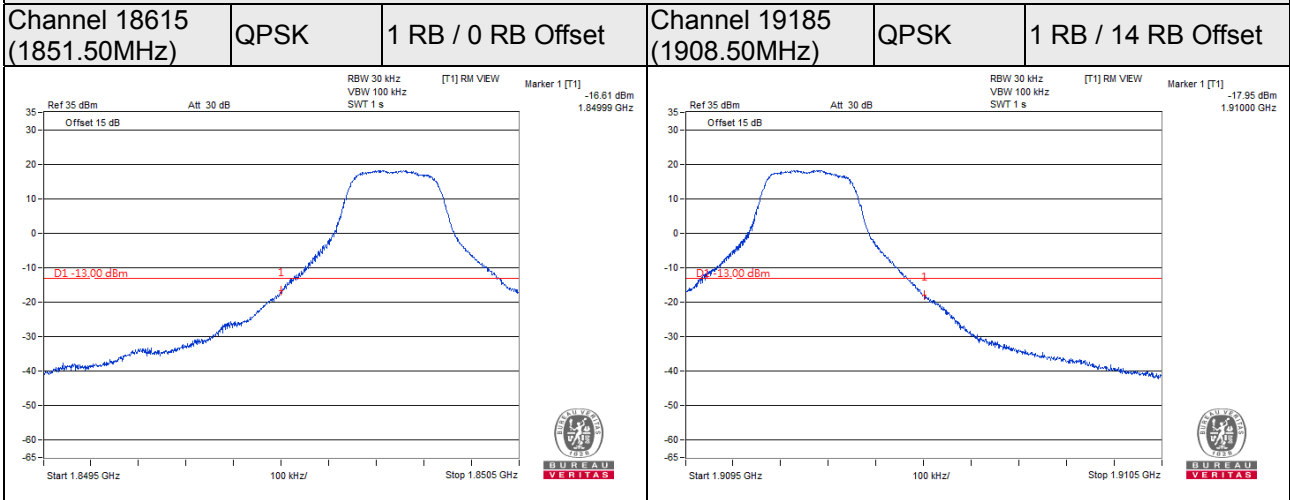

LTE Band 2, Channel Bandwidth 5MHz

Channel 18625 (1852.50MHz)	QPSK	1 RB / 0 RB Offset	Channel 19175 (1907.50MHz)	QPSK	1 RB / 24 RB Offset
---------------------------------------	-------------	---------------------------	---------------------------------------	-------------	----------------------------

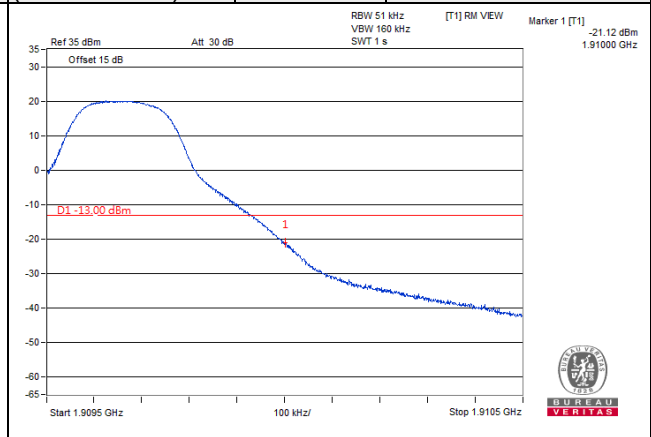
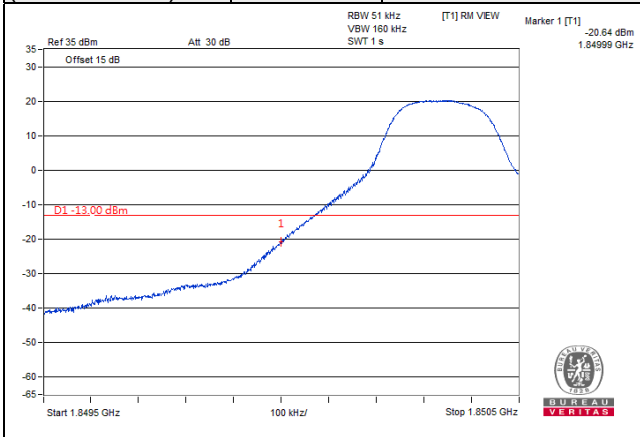

Channel 18625 (1852.50MHz)	QPSK	25 RB / 0 RB Offset	Channel 19175 (1907.50MHz)	QPSK	25 RB / 0 RB Offset
---------------------------------------	-------------	----------------------------	---------------------------------------	-------------	----------------------------

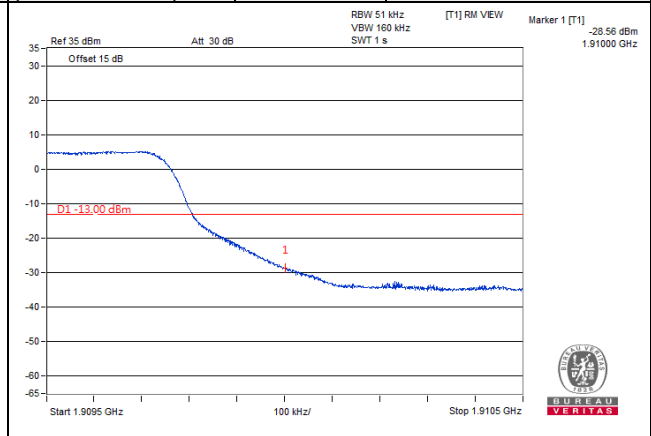
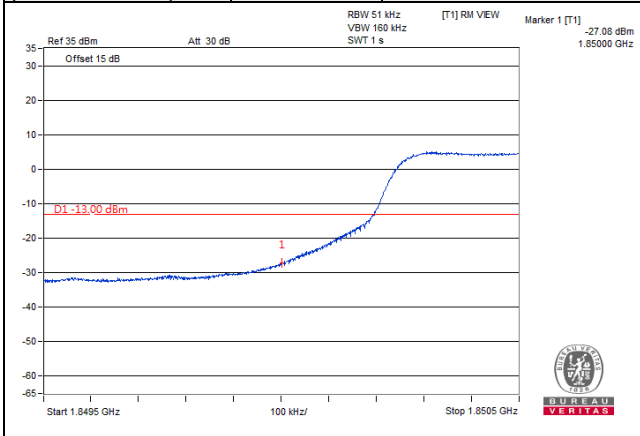

LTE Band 2, Channel Bandwidth 10MHz

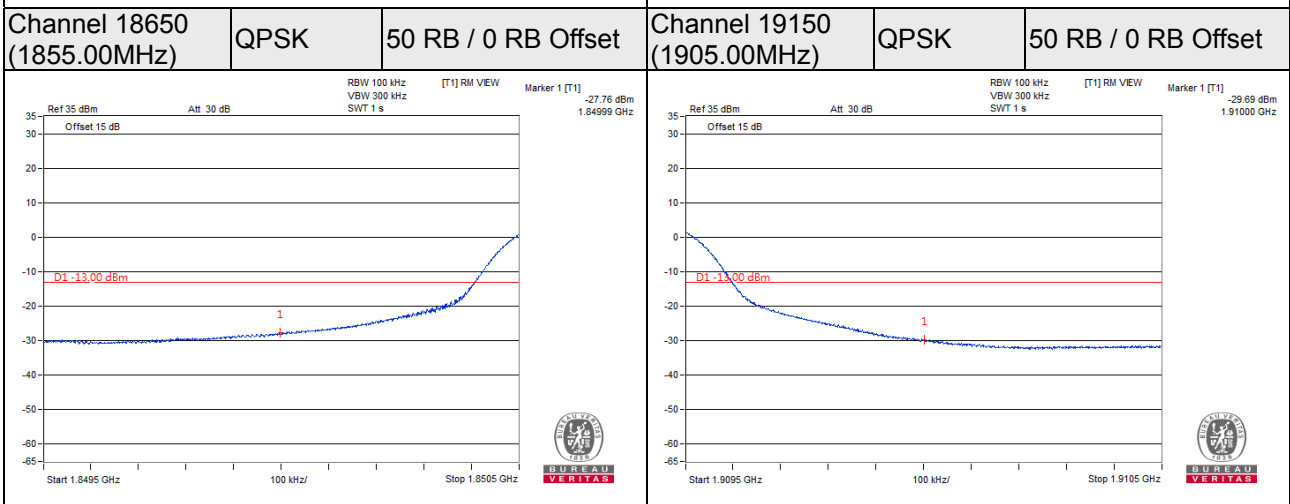
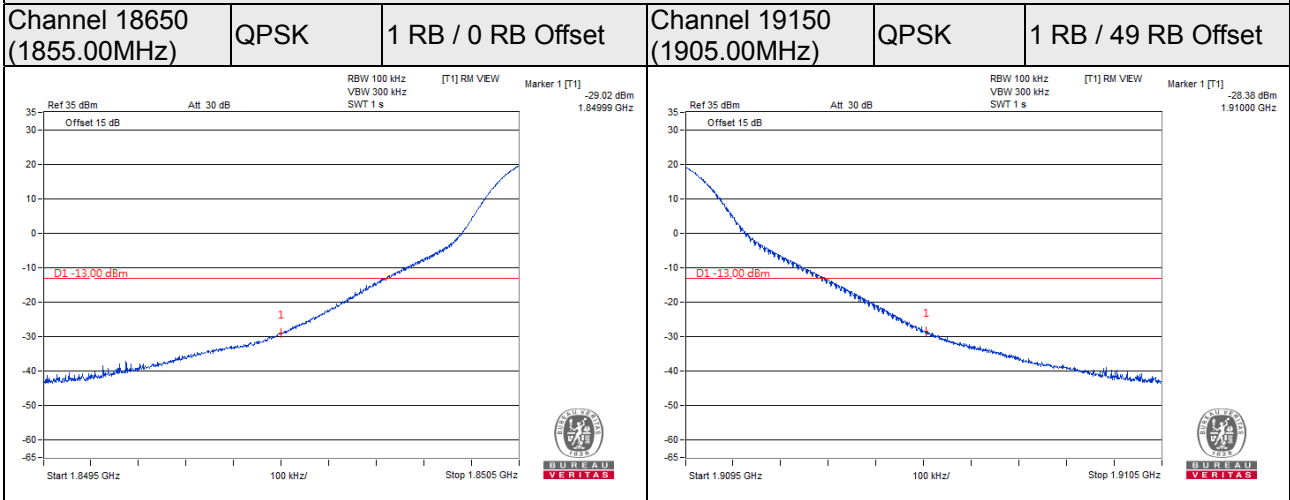

LTE Band 2, Channel Bandwidth 15MHz

Channel 18675 (1857.50MHz)	QPSK	1 RB / 0 RB Offset	Channel 19125 (1902.50MHz)	QPSK	1 RB / 74 RB Offset
-------------------------------	------	--------------------	-------------------------------	------	---------------------

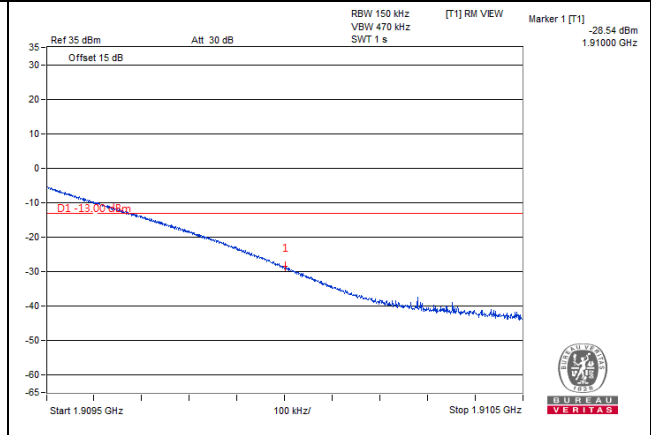
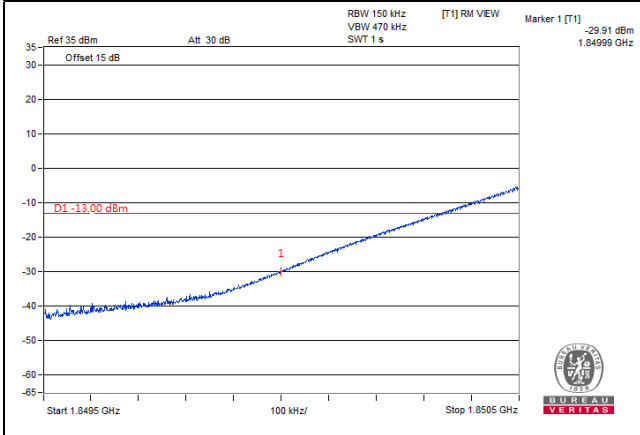

Channel 18675 (1857.50MHz)	QPSK	75 RB / 0 RB Offset	Channel 19125 (1902.50MHz)	QPSK	75 RB / 0 RB Offset
-------------------------------	------	---------------------	-------------------------------	------	---------------------

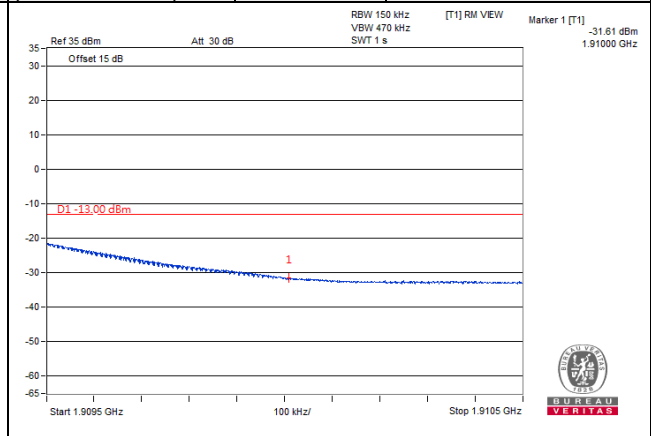
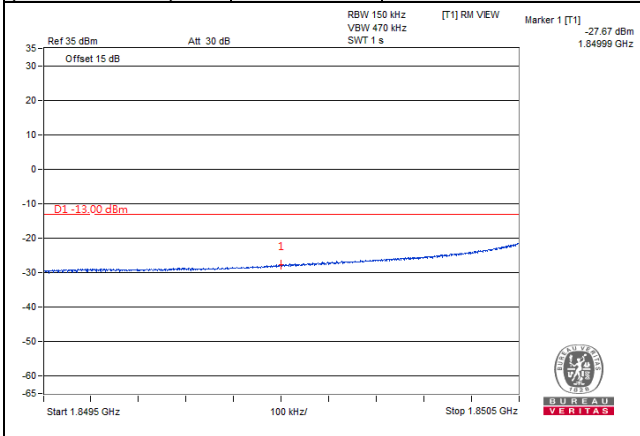

LTE Band 2, Channel Bandwidth 20MHz

Channel 18700 (1860.00MHz)	QPSK	1 RB / 0 RB Offset	Channel 19100 (1900.00 MHz)	QPSK	1 RB / 99 RB Offset
---------------------------------------	-------------	---------------------------	--	-------------	----------------------------

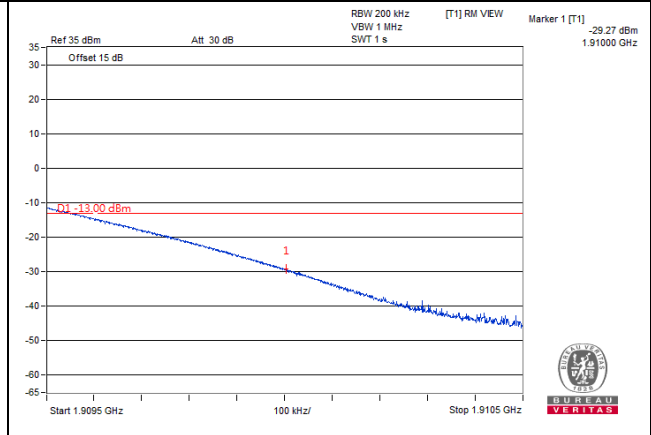
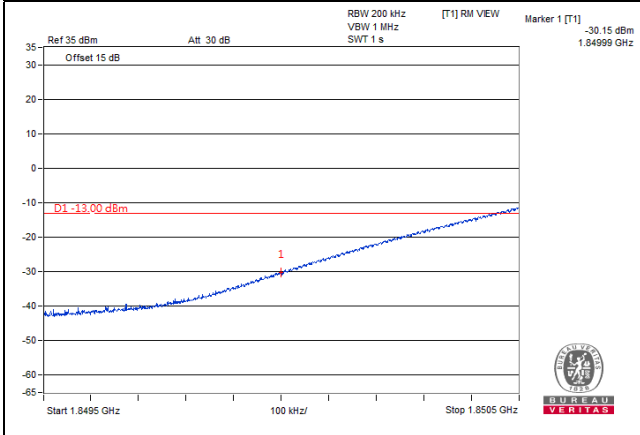

Channel 18700 (1860.00MHz)	QPSK	100 RB / 0 RB Offset	Channel 19100 (1900.00 MHz)	QPSK	100 RB / 0 RB Offset
---------------------------------------	-------------	-----------------------------	--	-------------	-----------------------------

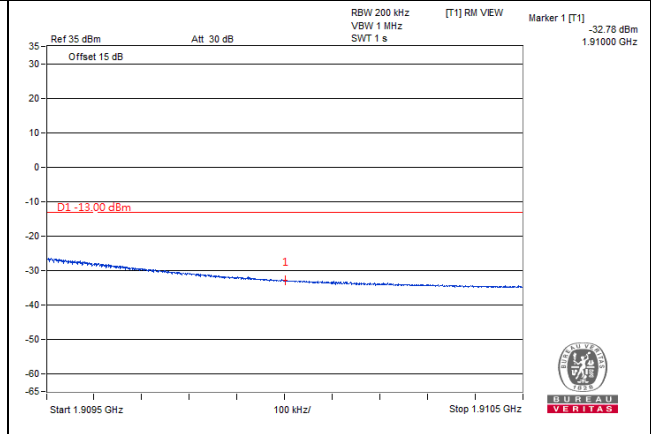
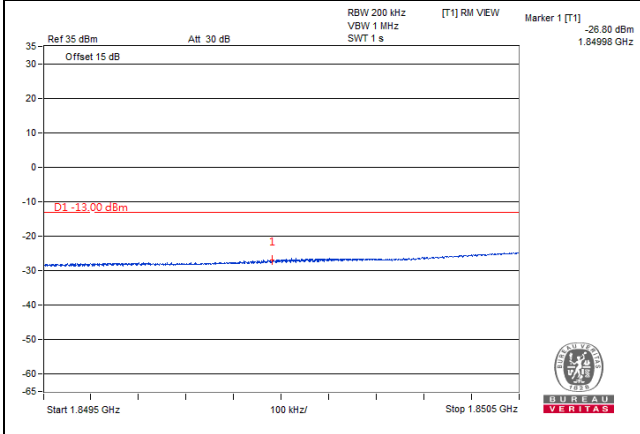

LTE Band 25, Channel Bandwidth 1.4MHz

Channel 26047
(1850.7MHz)

QPSK

1 RB / 0 RB Offset

Channel 26683
(1914.3MHz)

QPSK

1 RB / 5 RB Offset

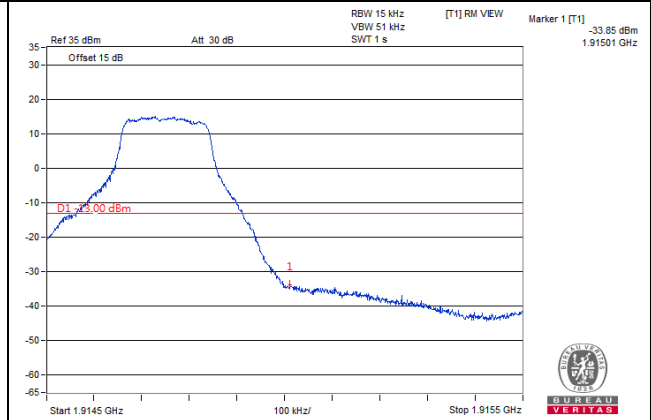
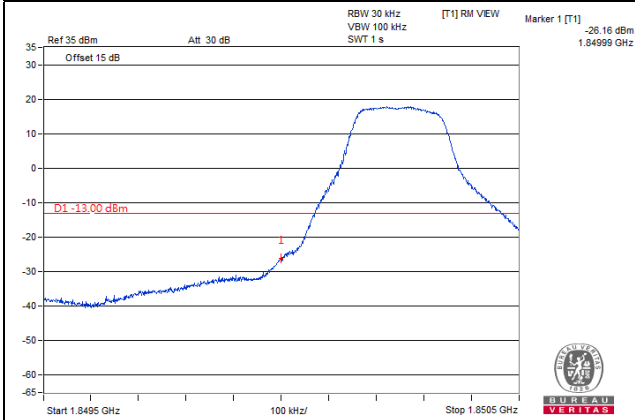

Channel 26047
(1850.7MHz)

QPSK

6 RB / 0 RB Offset

Channel 26683
(1914.3MHz)

QPSK

6 RB / 0 RB Offset

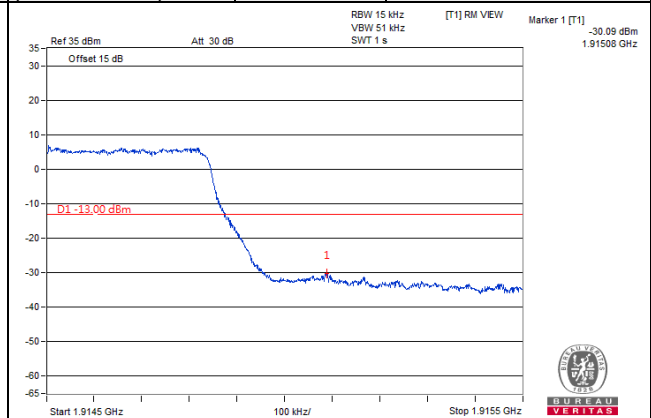
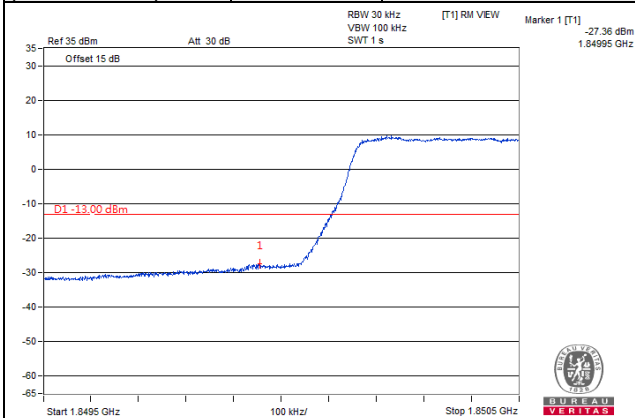

LTE Band 25, Channel Bandwidth 3MHz

Channel 26055 (1851.5MHz)	QPSK	1 RB / 0 RB Offset	Channel 26675 (1913.5MHz)	QPSK	1 RB / 14 RB Offset
------------------------------	------	--------------------	------------------------------	------	---------------------

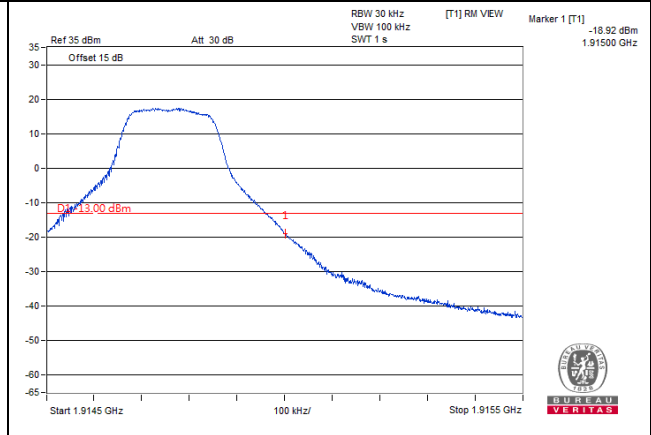
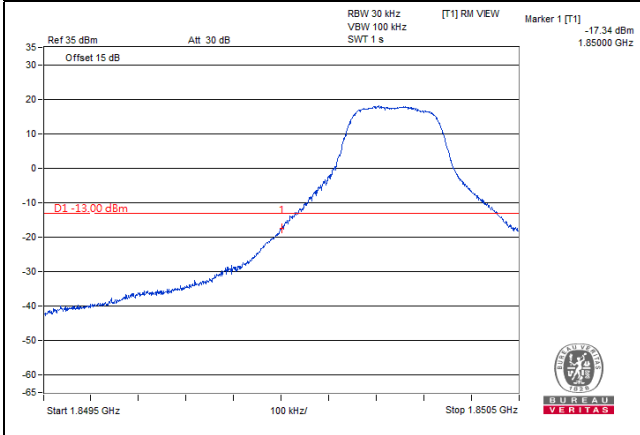

Channel 26055 (1851.5MHz)	QPSK	15 RB / 0 RB Offset	Channel 26675 (1913.5MHz)	QPSK	15 RB / 0 RB Offset
------------------------------	------	---------------------	------------------------------	------	---------------------

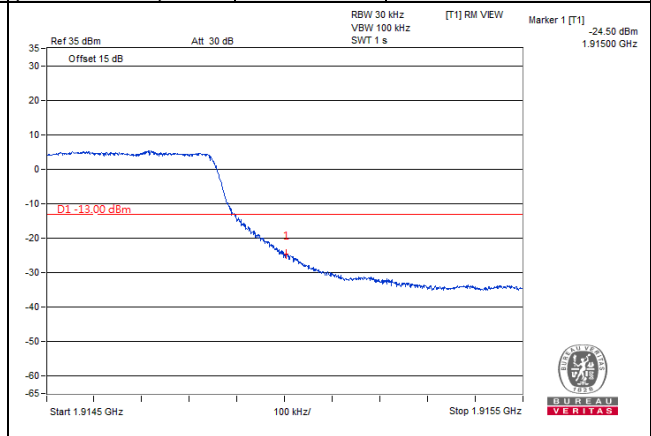
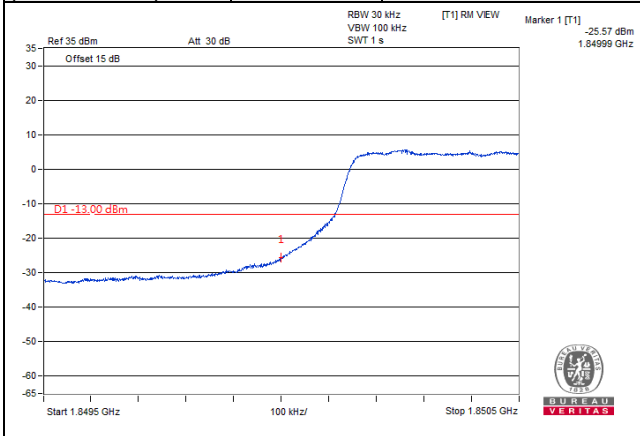

LTE Band 25, Channel Bandwidth 5MHz

Channel 26065 (1852.5MHz)	QPSK	1 RB / 0 RB Offset	Channel 26665 (1912.5MHz)	QPSK	1 RB / 24 RB Offset
------------------------------	------	--------------------	------------------------------	------	---------------------

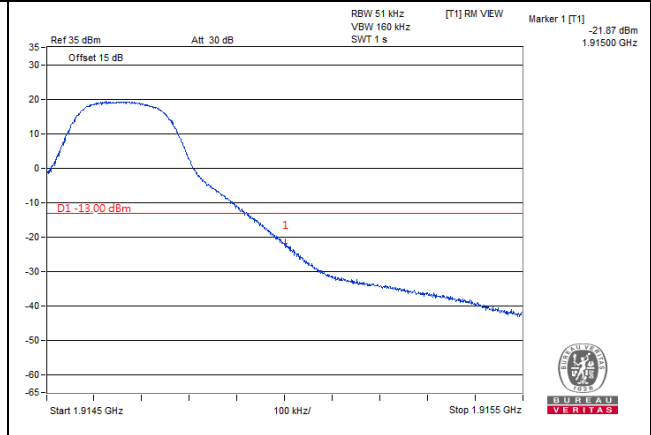
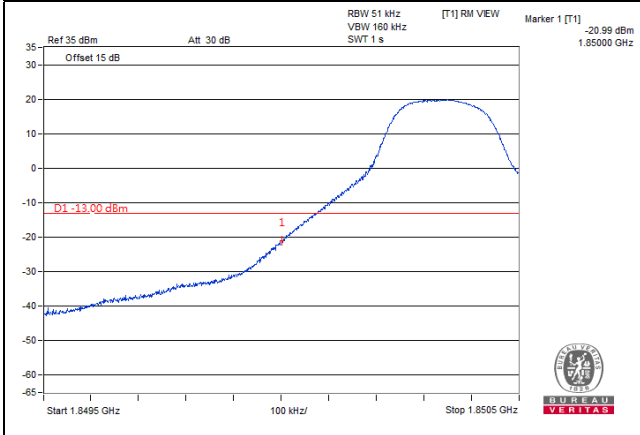

Channel 26065 (1852.5MHz)	QPSK	25 RB / 0 RB Offset	Channel 26665 (1912.5MHz)	QPSK	25 RB / 0 RB Offset
------------------------------	------	---------------------	------------------------------	------	---------------------

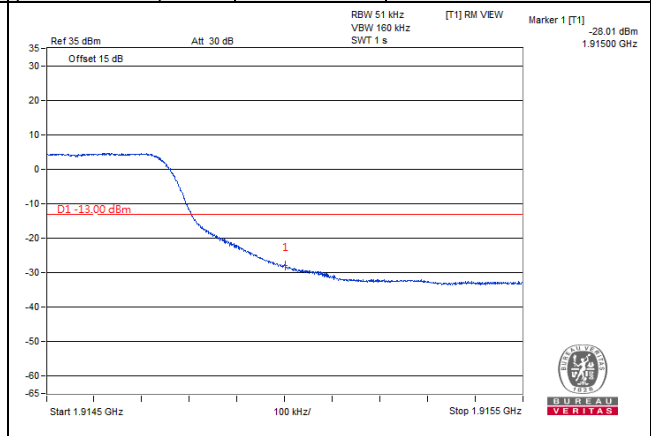
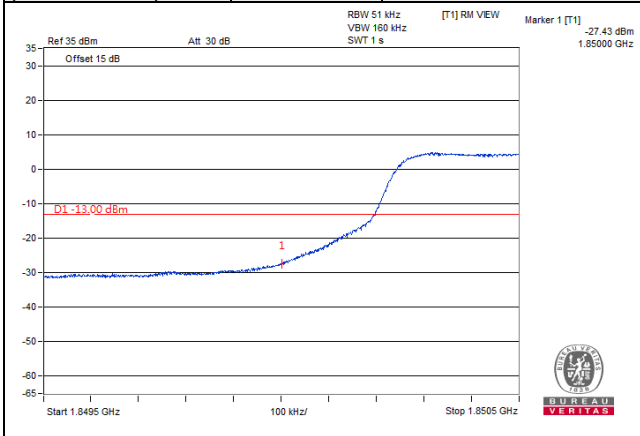

LTE Band 25, Channel Bandwidth 10MHz

Channel 26090
(1855.0MHz)

QPSK

1 RB / 0 RB Offset

Channel 26640
(1910.0MHz)

QPSK

1 RB / 49 RB Offset

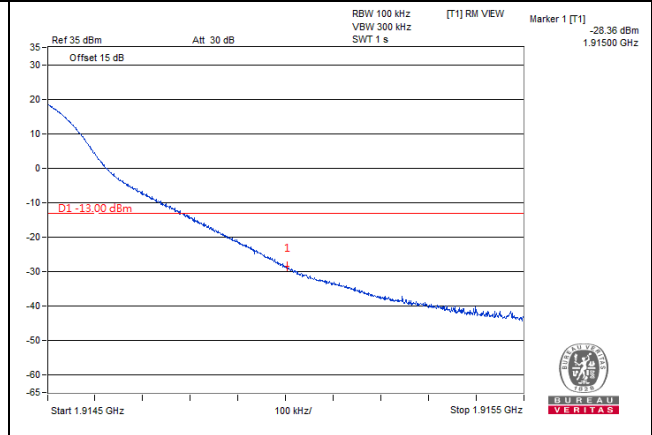
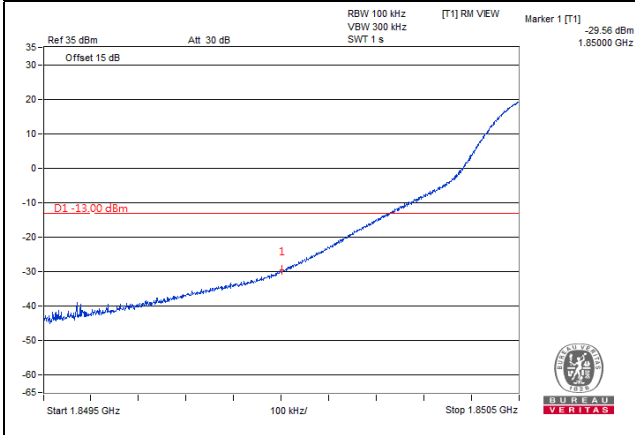

Channel 26090
(1855.0MHz)

QPSK

50 RB / 0 RB Offset

Channel 26640
(1910.0MHz)

QPSK

50 RB / 0 RB Offset

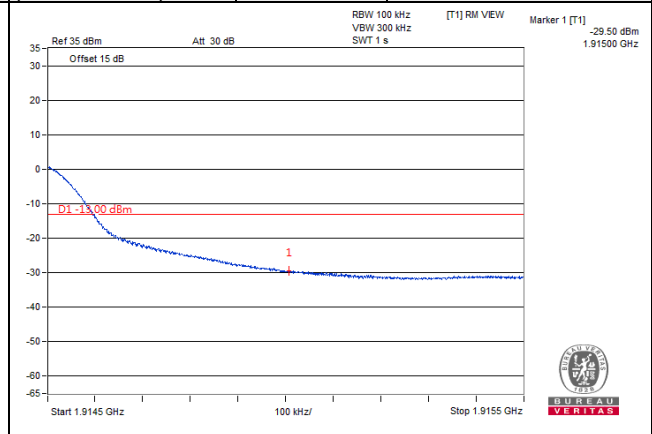
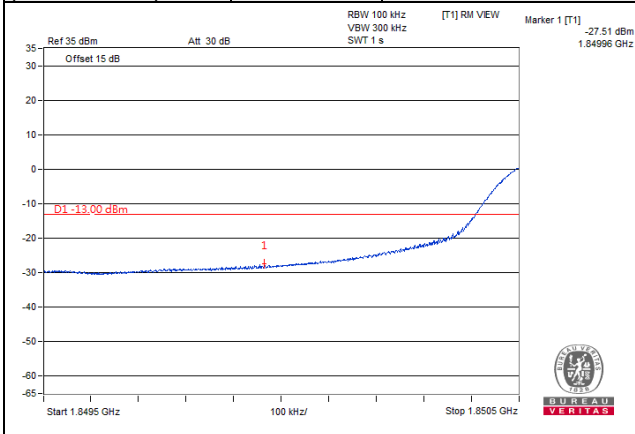

LTE Band 25, Channel Bandwidth 15MHz

Channel 26115
(1857.5MHz)

QPSK

1 RB / 0 RB Offset

Channel 26615
(1907.5MHz)

QPSK

1 RB / 74 RB Offset

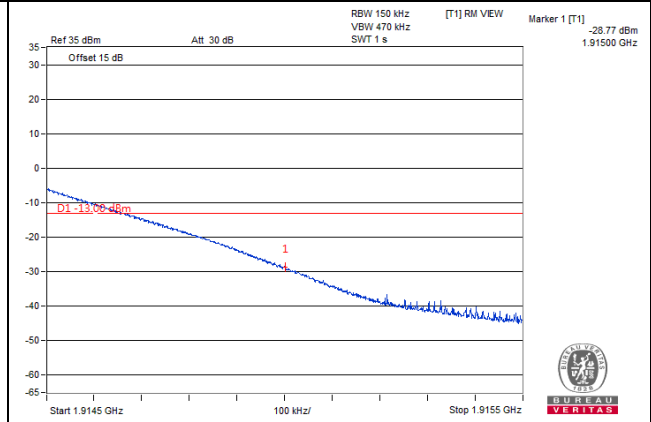
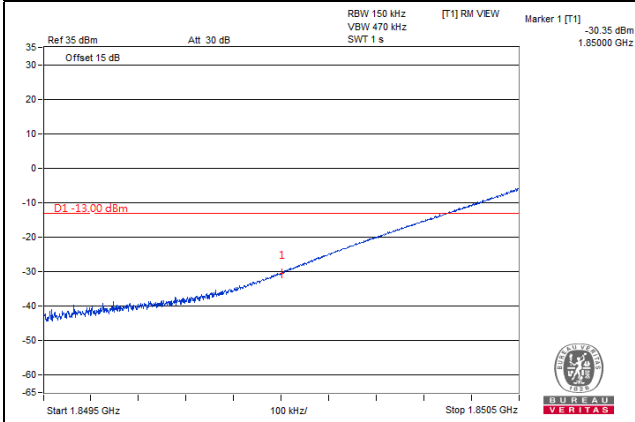

Channel 26115
(1857.5MHz)

QPSK

75 RB / 0 RB Offset

Channel 26615
(1907.5MHz)

QPSK

75 RB / 0 RB Offset

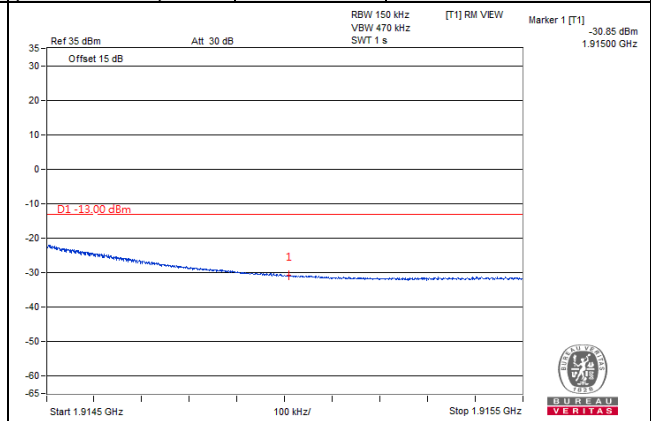
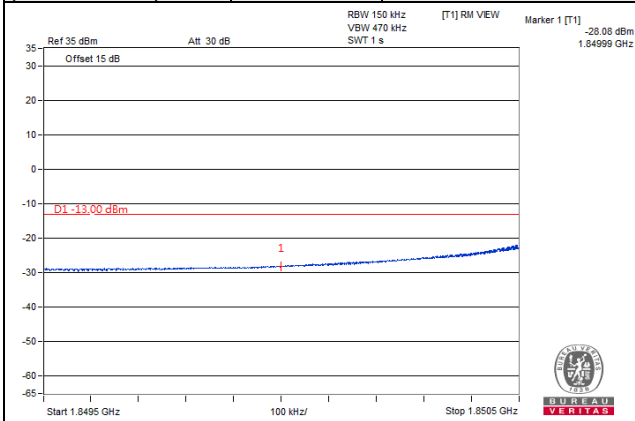

LTE Band 25, Channel Bandwidth 20MHz

Channel 26140 (1860.0MHz)	QPSK	1 RB / 0 RB Offset	Channel 26590 (1905.0MHz)	QPSK	1 RB / 99 RB Offset
------------------------------	------	--------------------	------------------------------	------	---------------------

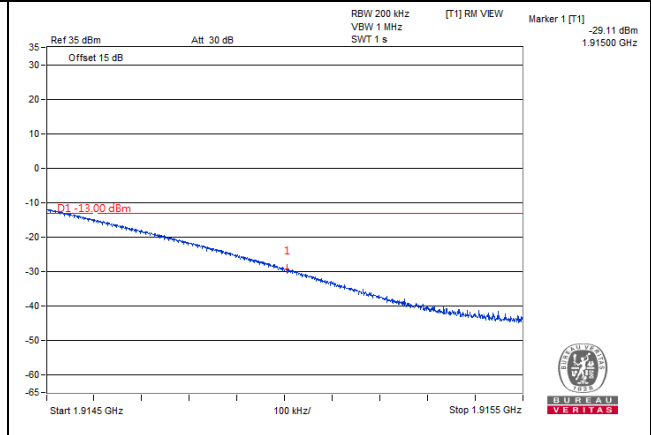
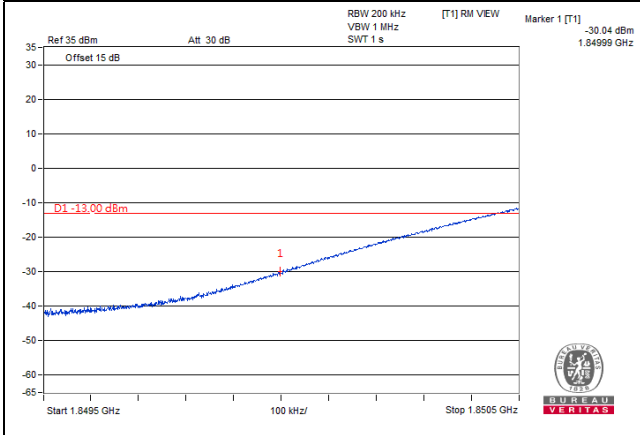

Channel 26140 (1860.0MHz)	QPSK	100 RB / 0 RB Offset	Channel 26590 (1905.0MHz)	QPSK	100 RB / 0 RB Offset
------------------------------	------	----------------------	------------------------------	------	----------------------

