

**SAMSUNG**

# USER MANUAL

SM-T870    SM-T970  
SM-T875    SM-T975  
              SM-T976B

# Table of Contents

## Basics

- 4 Read me first
- 6 Device overheating situations and solutions
- 9 Device layout and functions
- 16 Battery
- 18 SIM or USIM card (nano-SIM card) (SM-T875, SM-T975, SM-T976B)
- 20 Memory card (microSD card)
- 22 Turning the device on and off
- 23 Initial setup
- 24 Samsung account
- 25 Transferring data from your previous device (Smart Switch)
- 27 Understanding the screen
- 38 Notification panel
- 40 Screen capture and screen record
- 42 Entering text

## Apps and features

- 45 Installing or uninstalling apps
- 47 S Pen features
- 62 Bixby
- 66 Bixby Vision
- 68 Bixby Routines
- 71 Phone

- 76 Contacts
- 80 Messages
- 83 Internet
- 85 Camera
- 99 Gallery
- 105 AR Zone
- 113 Multi window
- 115 Samsung Daily
- 116 Samsung Members
- 116 Samsung Notes
- 121 PENUP
- 125 Calendar
- 126 Reminder
- 128 Samsung Flow
- 129 Voice Recorder
- 131 My Files
- 131 Clock
- 133 Calculator
- 133 Game Launcher
- 134 Game Booster
- 136 Samsung Kids
- 137 SmartThings
- 141 Sharing content
- 144 Music Share
- 145 Daily Board
- 148 Samsung DeX
- 154 Google apps

## Settings

- 156 Introduction
  - 156 Connections
    - 157 Wi-Fi
    - 159 Bluetooth
    - 160 Data saver (SM-T875, SM-T975, SM-T976B)
    - 161 Mobile data only apps (SM-T875, SM-T975, SM-T976B)
    - 161 Mobile Hotspot and Tethering (SM-T875, SM-T975, SM-T976B)
    - 163 More connection settings
  - 164 Sounds and vibration
    - 165 Dolby Atmos (surround sound)
    - 165 Separate app sound
  - 165 Notifications
    - 166 App icon badges
  - 166 Display
    - 167 Dark mode settings
    - 168 Motion smoothness
    - 168 Blue light filter (SM-T970, SM-T976B)
    - 168 Changing the screen mode or adjusting the display colour
    - 170 Font size and style
    - 170 Screensaver
  - 170 Wallpaper
  - 171 Lock screen
    - 171 Smart Lock
  - 172 Biometrics and security
    - 173 Face recognition
    - 176 Fingerprint recognition
    - 180 Samsung Pass
    - 183 Secure Folder
    - 187 Secure Wi-Fi (SM-T870, SM-T875, SM-T970, SM-T976B)
  - 188 Privacy
  - 189 Location
  - 189 Accounts and backup
    - 190 Users
    - 192 Samsung Cloud
  - 193 Google
  - 194 Advanced features
    - 195 Motions and gestures
  - 196 Digital Wellbeing and parental controls
    - 196 Digital Wellbeing
  - 197 Device care
    - 197 Optimising your device
  - 198 Battery
  - 199 Storage
  - 199 Memory
  - 199 Security
- 199 Apps
  - 200 General management
  - 201 Accessibility
  - 201 Software update
  - 202 Tips and user manual
  - 202 About tablet

## Appendix

- 203 Troubleshooting
- 209 Removing the battery

# Basics

## Read me first

Please read this manual before using the device to ensure safe and proper use.

- Descriptions are based on the device's default settings.
- Some content may differ from your device depending on the region, service provider, model specifications, or device's software.
- Content (high quality content) that requires high CPU and RAM usage will affect the overall performance of the device. Apps related to the content may not work properly depending on the device's specifications and the environment that it is used in.
- Samsung is not liable for performance issues caused by apps supplied by providers other than Samsung.
- Samsung is not liable for performance issues or incompatibilities caused by edited registry settings or modified operating system software. Attempting to customise the operating system may cause the device or apps to work improperly.
- Software, sound sources, wallpapers, images, and other media provided with this device are licensed for limited use. Extracting and using these materials for commercial or other purposes is an infringement of copyright laws. Users are entirely responsible for illegal use of media.
- You may incur additional charges for data services, such as messaging, uploading and downloading, auto-syncing, or using location services depending on your data plan. For large data transfers, it is recommended to use the Wi-Fi feature. (SM-T875, SM-T975, SM-T976B)
- Default apps that come with the device are subject to updates and may no longer be supported without prior notice. If you have questions about an app provided with the device, contact a Samsung Service Centre. For user-installed apps, contact service providers.
- Modifying the device's operating system or installing softwares from unofficial sources may result in device malfunctions and data corruption or loss. These actions are violations of your Samsung licence agreement and will void your warranty.

- Depending on the region or service provider, a screen protector is attached for protection during production and distribution. Damage to the attached screen protector is not covered by the warranty.
- You can see the touchscreen clearly even in strong outdoor sunlight by automatically adjusting the contrast range based on the surrounding environment. Due to the nature of the product, displaying fixed graphics for extended periods may result in afterimages (screen burn-in) or ghosting.
  - It is recommended not to use fixed graphics on part or all of the touchscreen for extended periods and turn off the touchscreen when not using the device.
  - You can set the touchscreen to turn off automatically when you are not using it. Launch the **Settings** app, tap **Display** → **Screen timeout**, and then select the length of time you want the device to wait before turning off the touchscreen.
  - To set the touchscreen to automatically adjust its brightness based on the surrounding environment, launch the **Settings** app, tap **Display**, and then tap the **Adaptive brightness** switch to activate it.
- Depending on the region or model, some devices are required to receive approval from the Federal Communications Commission (FCC).

If your device is approved by the FCC, you can view the FCC ID of the device. To view the FCC ID, launch the **Settings** app and tap **About tablet** → **Status**. If your device does not have an FCC ID, it means that the device has not been authorised for sale in the U.S. or its territories and may only be brought to the U.S. for the owner’s personal use.

- Depending on the region, you can view the regulatory information on the device. To view the information, launch the **Settings** app and tap **About tablet** → **Regulatory information**.

## Instructional icons



**Warning:** situations that could cause injury to yourself or others



**Caution:** situations that could cause damage to your device or other equipment



**Notice:** notes, usage tips, or additional information

## Device overheating situations and solutions

### When the device heats up while charging the battery

While charging, the device and the charger may become hot. During wireless charging or fast charging, the device may feel hotter to the touch. This does not affect the device's lifespan or performance and is in the device's normal range of operation. If the battery becomes too hot, the charger may stop charging.

#### Do the following when the device heats up:

- Disconnect the charger from the device and close any running apps. Wait for the device to cool down and then begin charging the device again.
- If the lower part of the device overheats, it could be because the connected USB cable is damaged. Replace the damaged USB cable with a new Samsung-approved one.
- When using a wireless charger, do not place foreign materials, such as metal objects, magnets, and magnetic stripe cards, between the device and the wireless charger.



The wireless charging or fast charging feature is only available on supported models.

### When the device heats up during use

When you use features or apps that require more power or use them for extended periods, your device may temporarily heat up due to increased battery consumption. Close any running apps and do not use the device for a while.

The following are examples of situations in which the device may overheat. Depending on the functions and apps you use, these examples may not apply to your model.

- During the initial setup after purchase or when restoring data
- When downloading large files

- When using apps that require more power or using apps for extended periods
  - When playing high-quality games for extended periods
  - When recording videos for extended periods
  - When streaming videos while using the maximum brightness setting
  - When connecting to a TV
- While multitasking (or, when running many apps in the background)
  - When using Multi window
  - When updating or installing apps while recording videos
  - When downloading large files during a video call
  - When recording videos while using a navigation app
- When using large amount of data for syncing with the cloud, email, or other accounts
- When using a navigation app in a car while the device is placed in direct sunlight
- When using the mobile hotspot and tethering feature
- When using the device in areas with weak signals or no reception
- When charging the battery with a damaged USB cable
- When the device's multipurpose jack is damaged or exposed to foreign materials, such as liquid, dust, metal powder, and pencil lead
- When you are roaming

### **Do the following when the device heats up:**

- Keep the device updated with the latest software.
- Conflicts between running apps may cause the device to heat up. Restart the device.
- Deactivate the Wi-Fi, GPS, and Bluetooth features when not using them.
- Close apps that increase battery consumption or that run in the background when not in use.
- Delete unnecessary files or unused apps.
- Decrease the screen brightness.
- If the device overheats or feels hot for a prolonged period, do not use it for a while. If the device continues to overheat, contact a Samsung Service Centre.

## Precautions for device overheating

If you begin to feel uncomfortable due to the device overheating, stop using the device.

When the device heats up, the features and performance may be limited or the device may turn off to cool down. The feature is only available on supported models.

- If the device overheats and reaches a certain temperature, a warning message will appear to prevent device failure, skin irritations and damages, and battery leakage. To lower the device's temperature, the screen brightness and the performance speed will be limited and battery charging will stop. Running apps will be closed and all calling and other features will be limited, except for emergency calls, until the device cools down.
- If the second message appears due to a further increase of the device's temperature, the device will turn off. Do not use the device until the device's temperature drops below the specified level. If the second warning message appears during an emergency call, the call will not be disconnected by a forced shut down.

## Precautions for operating environment

Your device may heat up due to the environment in the following conditions. Use caution to avoid shortening the battery's lifespan, damaging the device, or causing a fire.

- Do not store your device in very cold or very hot temperatures.
- Do not expose your device to direct sunlight for extended periods.
- Do not use or store your device for extended periods in very hot areas, such as inside a car in the summertime.
- Do not place the device in any areas that may overheat, such as on an electric heating mat.
- Do not store your device near or in heaters, microwaves, hot cooking equipment, or high pressure containers.
- Do not use a cable whose covering is peeled off or damaged, and do not use any charger or battery that is damaged or malfunctioning.



# Device layout and functions

## Package contents

Refer to the quick start guide for package contents.



- The items supplied with the device and any available accessories may vary depending on the region or service provider.
- The supplied items are designed only for this device and may not be compatible with other devices.
- Appearances and specifications are subject to change without prior notice.
- You can purchase additional accessories from your local Samsung retailer. Make sure they are compatible with the device before purchase.
- Use only Samsung-approved accessories. Using unapproved accessories may cause the performance problems and malfunctions that are not covered by the warranty.
- Availability of all accessories is subject to change depending entirely on manufacturing companies. For more information about available accessories, refer to the Samsung website.
- The earphones (USB Type-C) that support digital output can be used with the device. However, the device may not be compatible with earphones that use a different audio output method or were made by a different manufacturer.

## Device layout

### ► SM-T870, SM-T875:

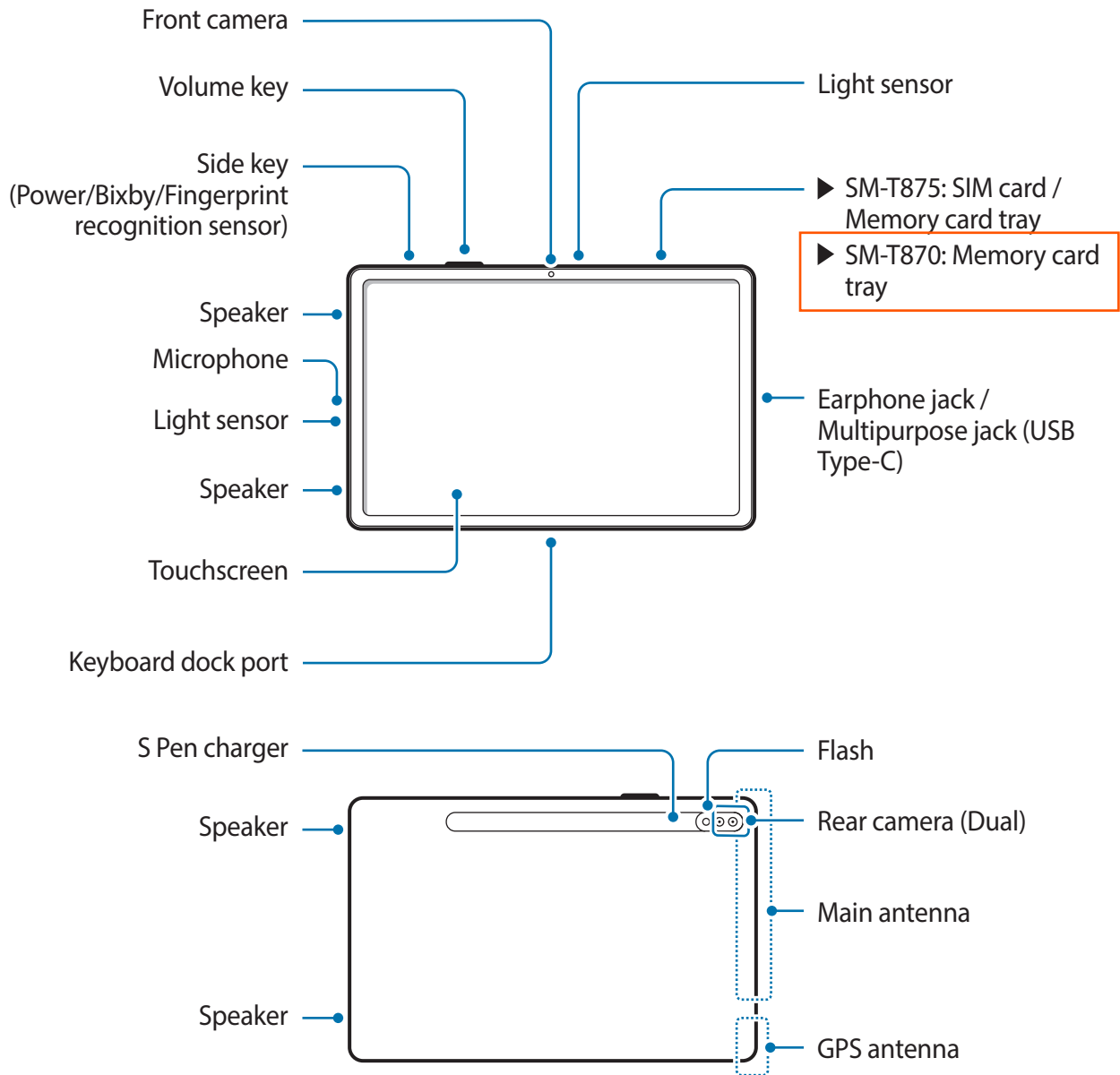

► **SM-T970, SM-T975, SM-T976B:**

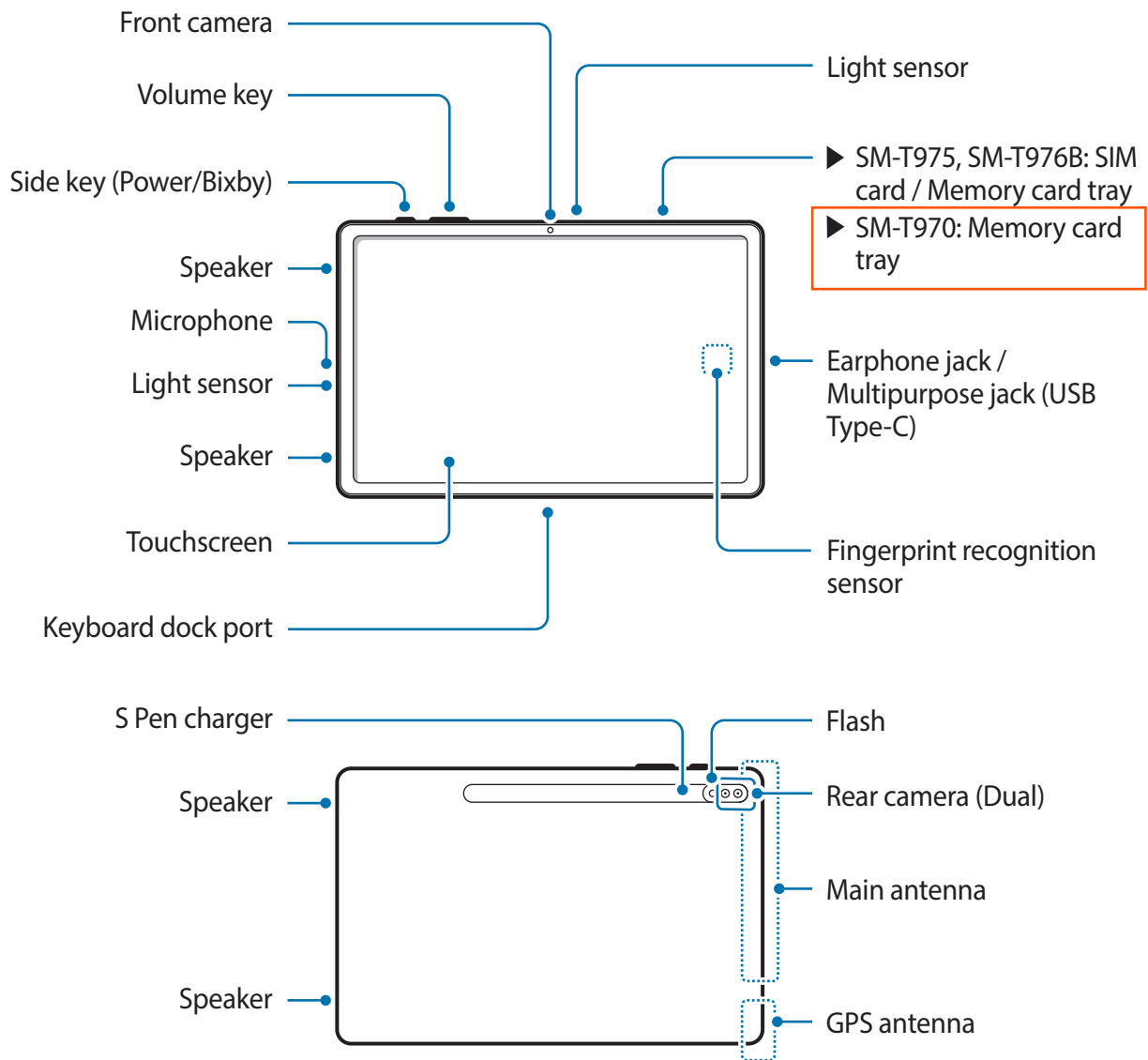

- Your device contains magnets, which may affect medical devices, such as pacemakers or implantable cardioverter defibrillators. If you are using any of these medical devices, keep your device a safe distance from them and consult with your physician before you use the device.
- Keep a safe distance between your device and objects that are affected by magnets. Objects such as credit cards, passbooks, access cards, boarding passes, or parking passes may be damaged or disabled by the magnets in the device.



- When using the speakers, such as when playing media files, do not place the device close to your ears.
- Be careful not to expose the camera lens to a strong light source, such as direct sunlight. If the camera lens is exposed to a strong light source, such as direct sunlight, the camera image sensor may be damaged. A damaged image sensor is irreparable and will cause dots or spots in pictures.
- If you use the device with its glass or acrylic body broken, there may be a risk of injury. Use the device only after it has been repaired at a Samsung Service Centre.
- If dust or foreign materials enter the microphone, speaker, or receiver, or if the microphone is covered, the device's sound may become quiet or certain features may not work. If you attempt to remove the dust or foreign materials with a sharp object, the device may be damaged and its appearance may be affected.



- Connectivity problems and battery drain may occur in the following situations:
  - If you attach metallic stickers on the antenna area of the device
  - If you attach a device cover made with metallic material to the device
  - If you cover the device's antenna area with your hands or other objects while using certain features, such as calls or the mobile data connection (SM-T875, SM-T975, SM-T976B)
- Using a Samsung-approved screen protector is recommended. Unapproved screen protectors may cause the sensors to malfunction.
- Do not cover the light sensor area with screen accessories, such as a screen protector or stickers. Doing so may cause the sensor to malfunction.
- Do not allow water to contact the touchscreen. The touchscreen may malfunction in humid conditions or when exposed to water.

## Hard keys

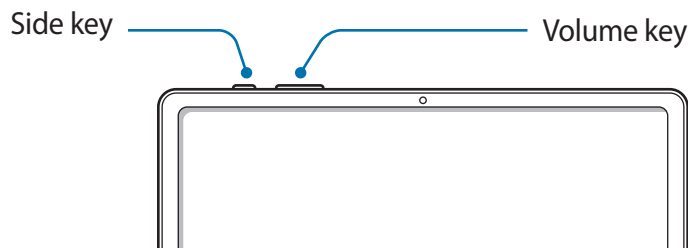

Key	Function
Side key	<ul style="list-style-type: none"> <li>• When the device is off, press and hold to turn it on.</li> <li>• Press to turn on or lock the screen.</li> <li>• Press and hold to start a conversation with Bixby. Refer to <a href="#">Using Bixby</a> for more information.</li> <li>• Press twice or press and hold to launch the app or feature you set.</li> </ul>
Volume key	<ul style="list-style-type: none"> <li>• Press to adjust the device volume.</li> </ul>
Side key + Volume Down key	<ul style="list-style-type: none"> <li>• Press simultaneously to capture a screenshot.</li> <li>• Press and hold simultaneously to turn off the device.</li> </ul>

## Setting the Side key

Select an app or feature to launch by pressing the Side key twice or pressing and holding the Side key.

Launch the **Settings** app, tap **Advanced features** → **Side key**, and then select an option you want.

## Soft buttons

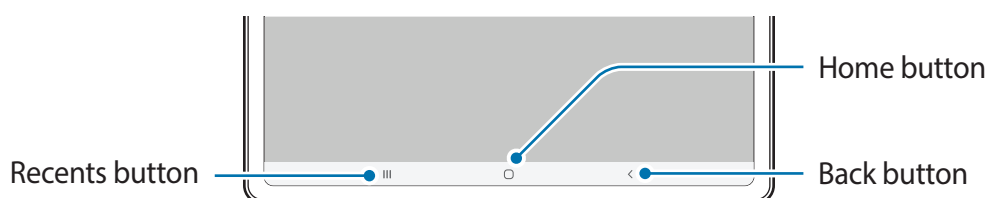

When you turn on the screen, the soft buttons will appear at the bottom of the screen. The soft buttons are set to the Recents button, Home button, and Back button by default. Refer to [Navigation bar \(soft buttons\)](#) for more information.

## S Pen

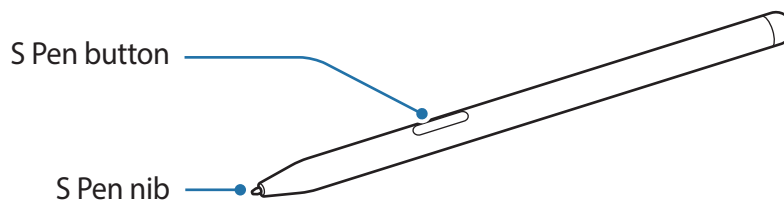

Name	Functions
S Pen nib	<ul style="list-style-type: none"> <li>• Use the S Pen to write, draw, or perform touch actions on the screen.</li> <li>• Hover the S Pen over items on the screen to access additional S Pen features, such as the Air view feature.</li> </ul>
S Pen button	<ul style="list-style-type: none"> <li>• Press and hold the S Pen button to launch the preset app. If you press the button once or twice while using apps, the device will perform certain features. Refer to <a href="#">Air actions</a> for more information.</li> <li>• Hover the S Pen over the screen and press the S Pen button to display the Air command features.</li> <li>• While pressing and holding the S Pen button, drag the S Pen over items to select them.</li> </ul>



- Do not bend or apply excessive pressure with the S Pen while using it. The S Pen may be damaged or the nib may be deformed.
- Do not hard press on the screen with the S Pen. The pen nib may be deformed.



- If you use the S Pen at sharp angles on the screen, the device may not recognise the S Pen actions.
- If the S Pen is not working properly, take it to a Samsung Service Centre.

## Charging the S Pen

The S Pen must be charged before you can control apps remotely by using the S Pen button. When the S Pen and the S Pen charger are properly aligned, charging will begin.

If the Air action feature is deactivated, the S Pen is only charged while the device is being charged.

▶ **SM-T870, SM-T875:**

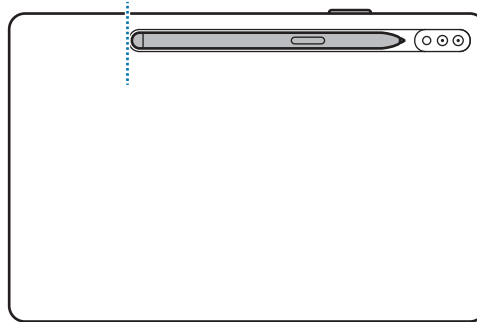

▶ **SM-T970, SM-T975, SM-T976B:**

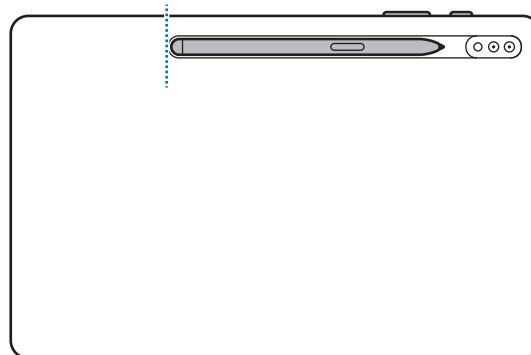

- If magnets are around the device, the S Pen may not be able to properly perform some actions, such as charging or tapping the touchscreen.
- Even if the S Pen has been fully discharged, you can use other S Pen features, such as tapping the touchscreen or the Air command features.
- If the device and the S Pen are not attached like in the image, the S Pen may not be charged. Attach the S Pen by aligning the top of the S Pen to the end of the S Pen strip as shown in the image.
- If you use the device on the floor with the S Pen attached to the S Pen charger, it may scratch the S Pen.

# Battery

## Charging the battery

Charge the battery before using it for the first time or when it has been unused for extended periods.



Use only Samsung-approved battery, charger, and cable specifically designed for your device. Incompatible battery, charger, and cable can cause serious injuries or damage to your device.



- Connecting the charger improperly may cause serious damage to the device. Any damage caused by misuse is not covered by the warranty.
- Use only USB Type-C cable supplied with the device. The device may be damaged if you use Micro USB cable.

- When the device's battery is discharged, it must be charged using the supplied charger. Otherwise, the device may not charge properly.



To save energy, unplug the charger when not in use. The charger does not have a power switch, so you must unplug the charger from the electric socket when not in use to avoid wasting power. The charger should remain close to the electric socket and easily accessible while charging.

- 1 Connect the USB cable to the USB power adaptor.
- 2 Plug the USB cable into the device's multipurpose jack.

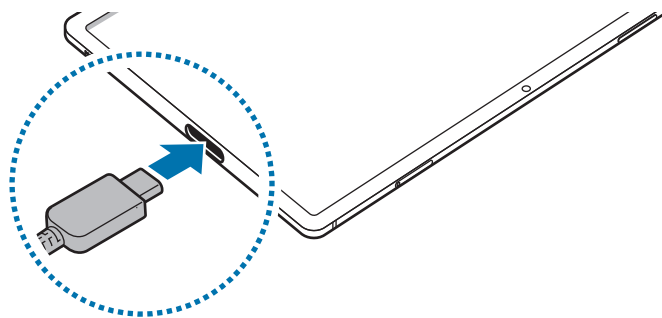

- 3 Plug the USB power adaptor into an electric socket.
- 4 After fully charging, disconnect the charger from the device. Then, unplug the charger from the electric socket.



## Reducing the battery consumption

Your device provides various options that help you conserve battery power.

- Optimise the device using the device care feature.
- When you are not using the device, turn off the screen by pressing the Side key.
- Activate power saving mode.
- Close unnecessary apps.
- Deactivate the Bluetooth feature when not in use.
- Deactivate auto-syncing of apps that need to be synced.
- Decrease the backlight time.
- Decrease the screen brightness.

## Battery charging tips and precautions

- When the battery power is low, the battery icon appears empty.
- If the battery is completely discharged, the device cannot be turned on immediately when the charger is connected. Allow a depleted battery to charge for a few minutes before turning on the device.
- If you use multiple apps at once, network apps, or apps that need a connection to another device, the battery will drain quickly. To avoid losing power during a data transfer, always use these apps after fully charging the battery.
- Using a power source other than the charger, such as a computer, may result in a slower charging speed due to a lower electric current.
- The device can be used while it is charging, but it may take longer to fully charge the battery.
- If the device receives an unstable power supply while charging, the touchscreen may not function. If this happens, unplug the charger from the device.
- While charging, the device and the charger may heat up. This is normal and should not affect the device's lifespan or performance. If the battery gets hotter than usual, the charger may stop charging. If this occurs during wireless charging, disconnect the device from the charger to let it cool down, then charge the device again later.
- If you charge the device while the multipurpose jack is wet, the device may be damaged. Thoroughly dry the multipurpose jack before charging the device.
- If the device is not charging properly, take the device and the charger to a Samsung Service Centre.

## Fast charging

The device has a built-in fast charging feature. You can charge the battery more quickly while the device or its screen is turned off.

### Increasing the charging speed

To increase the charging speed, turn the device or its screen off when you charge the battery.

If the fast charging feature is not activated, launch the **Settings** app, tap **Device care** → **Battery** → **Charging**, and then tap the **Fast charging** switch to activate it.



- While charging, you cannot activate or deactivate this feature.
- You cannot use the built-in fast charging feature when you charge the battery using a standard battery charger.
- If the device heats up or the ambient air temperature rises, the charging speed may decrease automatically. This is a normal operating condition to prevent damage to the device.

## SIM or USIM card (nano-SIM card) (SM-T875, SM-T975, SM-T976B)

### Installing the SIM or USIM card

Insert the SIM or USIM card provided by the mobile telephone service provider.



- Use only a nano-SIM card.
- Use caution not to lose or let others use the SIM or USIM card. Samsung is not responsible for any damages or inconveniences caused by lost or stolen cards.



Some services that require a network connection may not be available depending on the service provider.

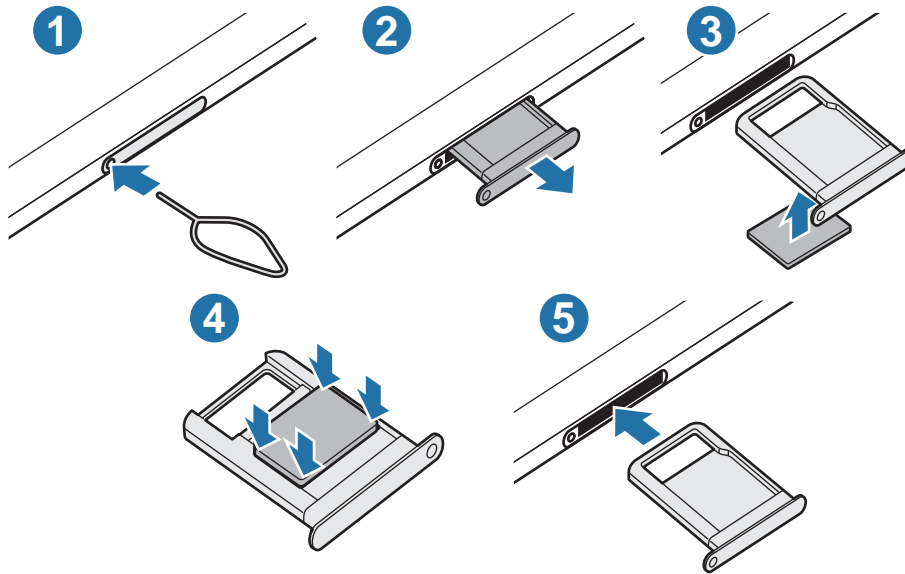

1 Insert the ejection pin into the hole on the tray to loosen the tray.

 Ensure that the ejection pin is perpendicular to the hole. Otherwise, the device may be damaged.

2 Pull out the tray gently from the tray slot.

3 Place the SIM or USIM card on the tray with the gold-coloured contacts facing upwards.

4 Gently press the SIM or USIM card into the tray to secure it.

 If the card is not fixed firmly into the tray, the SIM card may leave or fall out of the tray.



5 Insert the tray back into the tray slot.

 • If you insert the tray into your device while the tray is wet, your device may be damaged. Always make sure the tray is dry.  
• Fully insert the tray into the tray slot to prevent liquid from entering your device.

## Memory card (microSD card)

### Installing a memory card

Your device's memory card capacity may vary from other models and some memory cards may not be compatible with your device depending on the memory card manufacturer and type. To view your device's maximum memory card capacity, refer to the Samsung website.

- 
  - Some memory cards may not be fully compatible with the device. Using an incompatible card may damage the device or the memory card, or corrupt the data stored in it.
  - Use caution to insert the memory card right-side up.
- 
  - The device supports the FAT and the exFAT file systems for memory cards. When inserting a card formatted in a different file system, the device will ask to reformat the card or will not recognise the card. To use the memory card, you must format it. If your device cannot format or recognise the memory card, contact the memory card manufacturer or a Samsung Service Centre.
  - Frequent writing and erasing of data shortens the lifespan of memory cards.
  - When inserting a memory card into the device, the memory card's file directory appears in the **My Files** → **SD card** folder.

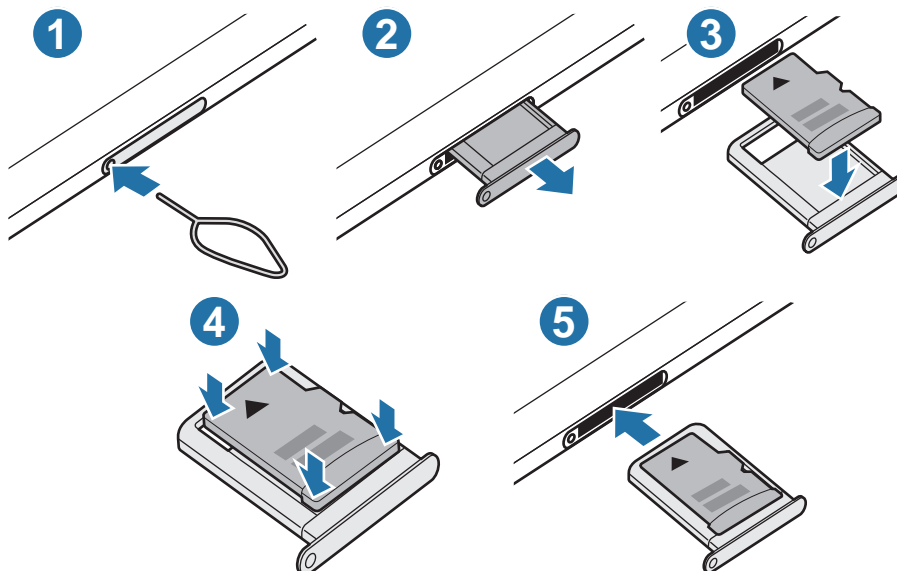

1 Insert the ejection pin into the hole on the tray to loosen the tray.

 Ensure that the ejection pin is perpendicular to the hole. Otherwise, the device may be damaged.

2 Pull out the tray gently from the tray slot.

 When you remove the tray from the device, the mobile data connection will be disabled. (SM-T875, SM-T975, SM-T976B)

3 Place a memory card on the tray with the gold-coloured contacts facing downwards.

4 Gently press the memory card into the tray to secure it.

 If the card is not fixed firmly into the tray, the memory card may leave or fall out of the tray.

5 Insert the tray back into the tray slot.

 • If you insert the tray into your device while the tray is wet, your device may be damaged. Always make sure the tray is dry.  
• Fully insert the tray into the tray slot to prevent liquid from entering your device.

## Removing the memory card

Before removing the memory card, first unmount it for safe removal.

Launch the **Settings** app and tap **Device care** → **Storage** → **Advanced** → **SD card** → **Unmount**.

 Do not remove external storage, such as a memory card or USB storage, while the device is transferring or accessing information, or right after transferring data. Doing so can cause data to be corrupted or lost or cause damage to the external storage or device. Samsung is not responsible for losses, including loss of data, resulting from the misuse of external storage devices.

## Formatting the memory card

A memory card formatted on a computer may not be compatible with the device. Format the memory card on the device.

Launch the **Settings** app and tap **Device care** → **Storage** → **Advanced** → **SD card** → **Format**.



Before formatting the memory card, remember to make backup copies of all important data stored in the memory card. The manufacturer's warranty does not cover loss of data resulting from user actions.

## Turning the device on and off



Follow all posted warnings and directions from authorised personnel in areas where the use of wireless devices is restricted, such as aeroplanes and hospitals.

### Turning the device on

Press and hold the Side key for a few seconds to turn on the device.

When you turn on your device for the first time or after performing a data reset, follow the on-screen instructions to set up your device.

### Turning the device off

- 1 To turn off the device, press and hold the Side key and the Volume Down key simultaneously. Alternatively, open the notification panel and tap .

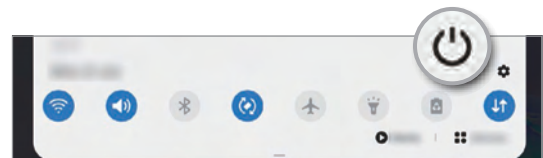
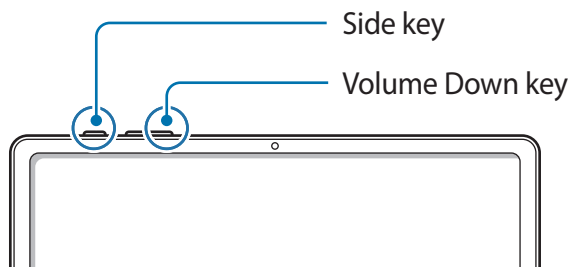

## 2 Tap **Power off**.

To restart the device, tap **Restart**.



You can set the device to turn off when you press and hold the Side key. Launch the **Settings** app, tap **Advanced features** → **Side key**, and then tap **Power off menu** under **Press and hold**.

## Forcing restart

If your device is frozen and unresponsive, press and hold the Side key and the Volume Down key simultaneously for more than 7 seconds to restart it.

## Initial setup

When you turn on your device for the first time or after performing a data reset, follow the on-screen instructions to set up your device.

- 1 Press and hold the Side key for a few seconds to turn on the device.
- 2 Select your preferred device language and select .
- 3 Follow the on-screen instructions to complete the setup.

The Home screen will appear.



If you do not connect to a Wi-Fi network, you may not be able to set up some device features during the initial setup.

## Samsung account

Your Samsung account is an integrated account service that allows you to use a variety of Samsung services provided by mobile devices, TVs, and the Samsung website.

To check the list of services that can be used with your Samsung account, visit [account.samsung.com](https://account.samsung.com). For more information on Samsung accounts, launch the **Settings** app and tap **Accounts and backup** → **Accounts** → **Samsung account** →  → **Help**.

### Creating a Samsung account

If you do not have a Samsung account, you should create one.

**1** Launch the **Settings** app and tap **Accounts and backup** → **Accounts** → **Add account** → **Samsung account**.

Alternatively, launch the **Settings** app and tap .

**2** Tap **Create account**.

**3** Follow the on-screen instructions to complete creating your account.

### Signing in to your Samsung account

If you already have a Samsung account, sign in to your Samsung account.

**1** Launch the **Settings** app and tap **Accounts and backup** → **Accounts** → **Add account** → **Samsung account**.

Alternatively, launch the **Settings** app and tap .

**2** Enter your Samsung account ID and password and tap **Sign in**.

**3** Follow the on-screen instructions to complete signing in to your Samsung account.

### Finding your ID and resetting your password

If you forget your Samsung account ID or password, tap **Find ID** or **Reset password** on the Samsung account sign-in screen. You can find your ID or reset your password after you enter the required information.



## Removing your Samsung account

When you remove your Samsung account from the device, your data, such as contacts or events, will also be removed.

- 1 Launch the **Settings** app and tap **Accounts and backup** → **Accounts**.
- 2 Tap **Samsung account** → **Personal info** →  → **Sign out**.
- 3 Tap **Sign out**, enter your Samsung account password, and then tap **OK**.

## Transferring data from your previous device (Smart Switch)

You can use Smart Switch to transfer data from your previous device to your new device.

Launch the **Settings** app and tap **Accounts and backup** → **Smart Switch**.



- This feature may not be supported on some devices or computers.
- Limitations apply. Visit [www.samsung.com/smartswitch](http://www.samsung.com/smartswitch) for details. Samsung takes copyright seriously. Only transfer content that you own or have the right to transfer.

## Transferring data wirelessly

Transfer data from your previous device to your device wirelessly via Wi-Fi Direct.

- 1 On the previous device, launch **Smart Switch**.  
If you do not have the app, download it from **Galaxy Store** or **Play Store**.
- 2 On your device, launch the **Settings** app and tap **Accounts and backup** → **Smart Switch**.
- 3 Place the devices near each other.
- 4 On the previous device, tap **Send data** → **Wireless**.
- 5 On the previous device, tap **Allow**.

- 6 On your device, select an item to bring and tap **Transfer**.
- 7 Follow the on-screen instructions to transfer data from your previous device.  
After the data is done transferring, you can view a list of the transferred data on your device.

## Backing up and restoring data using external storage

Transfer data using external storage, such as a microSD card.

- 1 Back up data from your previous device to external storage.
- 2 Insert or connect the external storage device to your device.
- 3 On your device, launch the **Settings** app and tap **Accounts and backup** → **Smart Switch** →  → **Restore**.
- 4 Follow the on-screen instructions to transfer data from external storage.

## Transferring backup data from a computer

Transfer data between your device and a computer. You must download the Smart Switch computer version app from [www.samsung.com/smartswitch](http://www.samsung.com/smartswitch). Back up data from your previous device to a computer and import the data to your device.

- 1 On the computer, visit [www.samsung.com/smartswitch](http://www.samsung.com/smartswitch) to download Smart Switch.
- 2 On the computer, launch Smart Switch.



If your previous device is not a Samsung device, back up data to a computer using a program provided by the device's manufacturer. Then, skip to the fifth step.

- 3 Connect your previous device to the computer using the device's USB cable.
- 4 On the computer, follow the on-screen instructions to back up data from the device.  
Then, disconnect your previous device from the computer.
- 5 Connect your device to the computer using the USB cable.
- 6 On the computer, follow the on-screen instructions to transfer data to your device.

# Understanding the screen

## Controlling the touchscreen



- Do not allow the touchscreen to come into contact with other electrical devices. Electrostatic discharges can cause the touchscreen to malfunction.
- To avoid damaging the touchscreen, do not tap it with anything sharp or apply excessive pressure to it with your fingertips.
- It is recommended not to use fixed graphics on part or all of the touchscreen for extended periods. Doing so may result in afterimages (screen burn-in) or ghosting.



- The device may not recognise touch inputs close to the edges of the screen, which are outside of the touch input area.
- It is recommended to use fingers or the S Pen when you use the touchscreen.

## Tapping

Tap the screen.

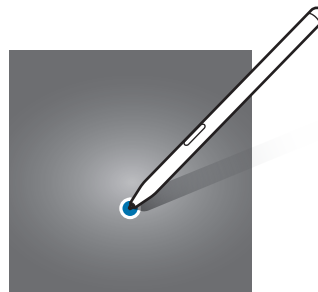
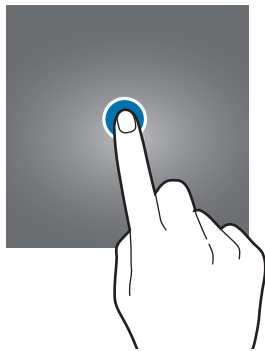

## Tapping and holding

Tap and hold the screen for approximately 2 seconds.

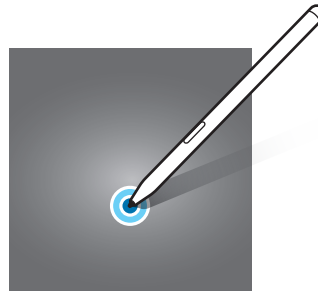
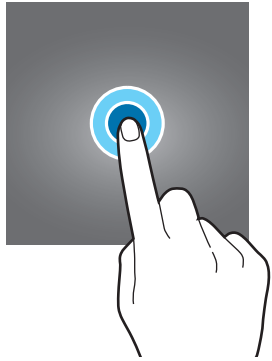

## Dragging

Tap and hold an item and drag it to the target position.

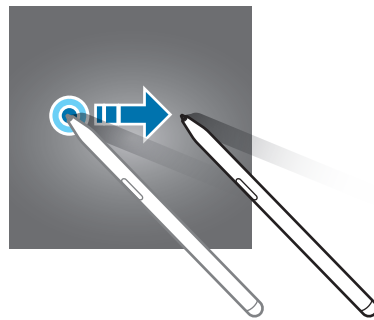
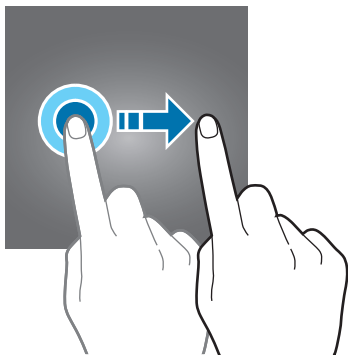

## Double-tapping

Double-tap the screen.

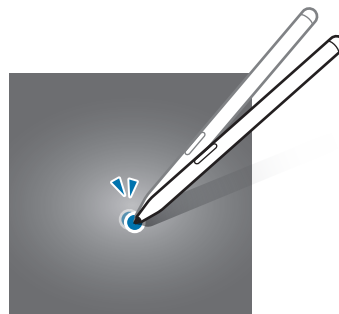
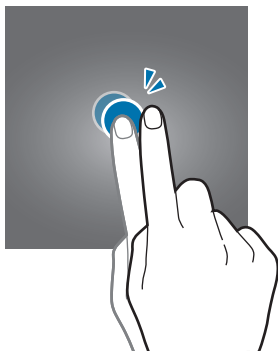

## Swiping

Swipe upwards, downwards, to the left, or to the right.

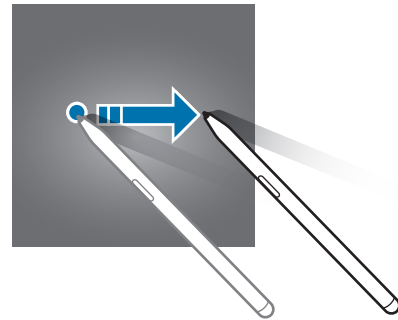
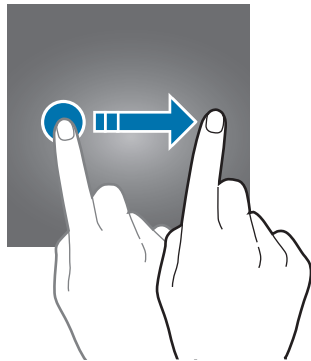

## Spreading and pinching

Spread two fingers apart or pinch on the screen.

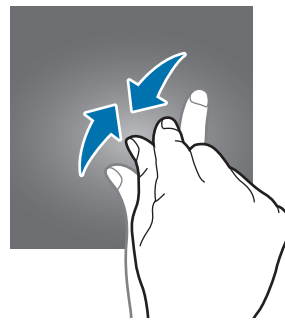
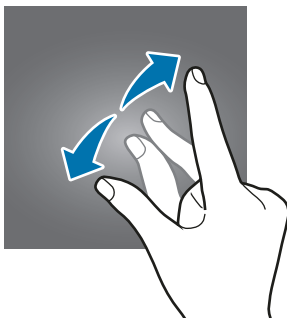

## Navigation bar (soft buttons)

When you turn on the screen, the soft buttons will appear on the navigation bar at the bottom of the screen. The soft buttons are set to the Recents button, Home button, and Back button by default. The functions of the buttons can change according to the app currently being used or usage environment.



Button	Function
Recents	<ul style="list-style-type: none"> <li>• Tap to open the list of recent apps.</li> </ul>
○ Home	<ul style="list-style-type: none"> <li>• Tap to return to the Home screen.</li> <li>• Tap and hold to launch the <b>Google Assistant</b> app.</li> </ul>
< Back	<ul style="list-style-type: none"> <li>• Tap to return to the previous screen.</li> </ul>

## Hiding the navigation bar

View files or use apps on a wider screen by hiding the navigation bar.

Launch the **Settings** app, tap **Display** → **Navigation bar**, and then tap **Full screen gestures** under **Navigation type**. The navigation bar will be hidden and the gesture hints will appear. Tap **More options** and select an option you want.

- **Swipe from bottom:** The gesture hints will appear where the soft buttons are located. To use the soft buttons, drag the gesture hint of the desired button upwards.
- **Swipe from sides and bottom:**
  - Swipe up from the bottom of the screen to move to the Home screen.
  - Swipe up and hold to view the list of recent apps.
  - Swipe inward from either side of the screen to return to the previous screen.
  - Swipe inward from one of the bottom corners to launch the **Google Assistant** app.

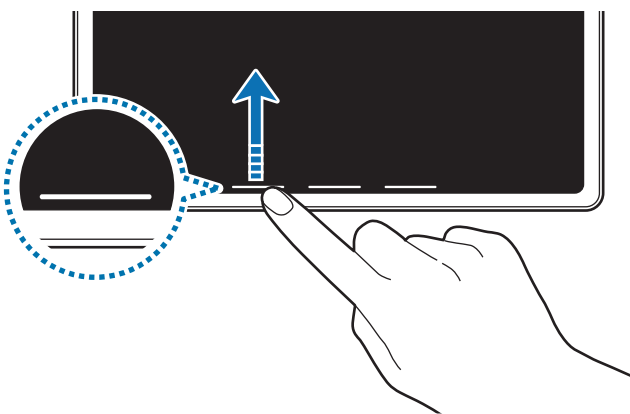

Swipe from bottom

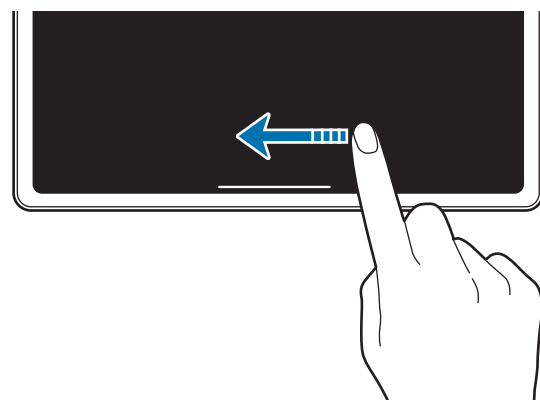

Swipe from sides and bottom

If you want to hide the gesture hints at the bottom of the screen, tap the **Gesture hints** switch to deactivate it.

## Home screen and Apps screen

The Home screen is the starting point for accessing all of the device's features. It displays widgets, shortcuts to apps, and more.

The Apps screen displays icons for all apps, including newly installed apps.



The screen may appear differently depending on the region or service provider.

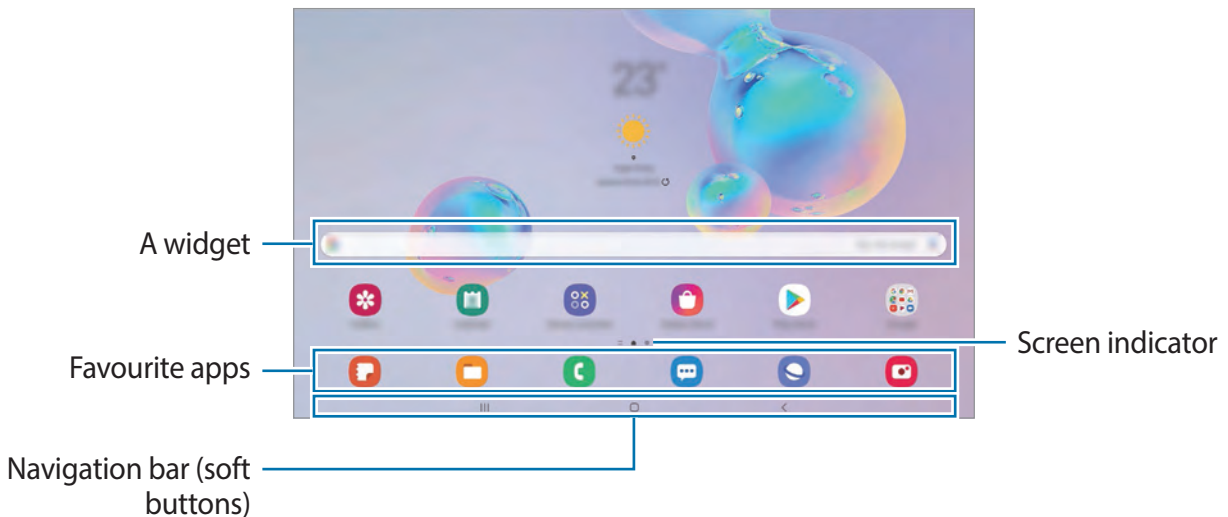

## Switching between Home and Apps screens

On the Home screen, swipe upwards or downwards to open the Apps screen.

To return to the Home screen, swipe upwards or downwards on the Apps screen.

Alternatively, tap the Home button or the Back button.

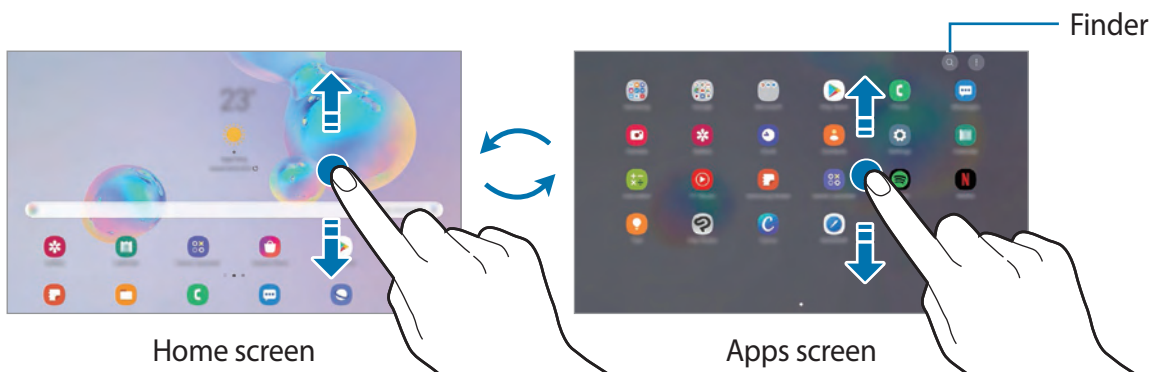



If you add the Apps button on the Home screen, you can open the Apps screen by tapping the button. On the Home screen, tap and hold an empty area, tap **Home screen settings**, and then tap the **Apps button** switch to activate it. The Apps button will be added at the bottom of the Home screen.



## Launching Finder

Search for content on the device quickly.

- 1 On the Apps screen, tap . Alternatively, open the notification panel, swipe downwards, and then tap .

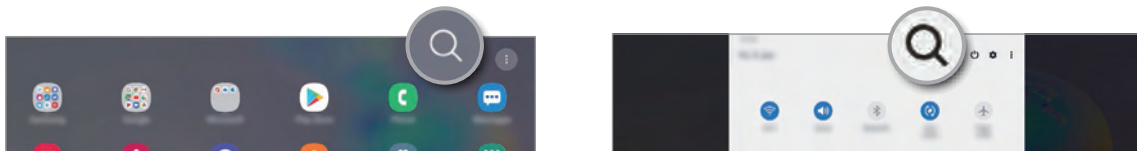

- 2 Enter a keyword.

Apps and content on your device will be searched.

If you tap  on the keyboard, you can search for more content.

## Moving items

Tap and hold an item, and then drag it to a new location. To move the item to another panel, drag it to the side of the screen.

To add a shortcut to an app on the Home screen, tap and hold an item on the Apps screen, and then tap **Add to Home**. A shortcut to the app will be added on the Home screen.

You can also move frequently used apps to the shortcuts area at the bottom of the Home screen.



## Creating folders

Create folders and gather similar apps to quickly access and launch apps.

On the Home screen or the Apps screen, tap and hold an app, and then drag it over another app.

A new folder containing the selected apps will be created. Tap **Folder name** and enter a folder name.

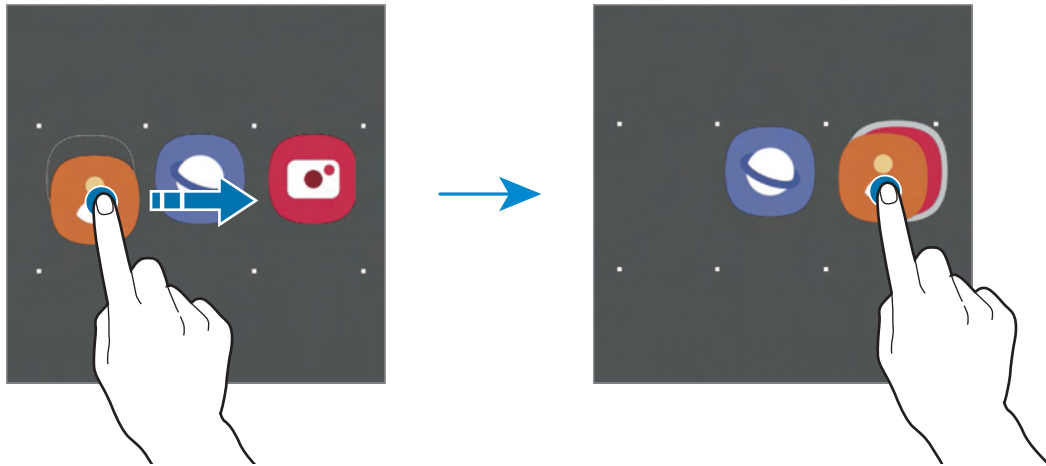

- **Adding more apps**

Tap **+** on the folder. Tick the apps to add and tap **Done**. You can also add an app by dragging it to the folder.

- **Moving apps from a folder**

Tap and hold an app to drag it to a new location.

- **Deleting a folder**

Tap and hold a folder, and then tap **Delete folder**. Only the folder will be deleted. The folder's apps will be relocated to the Apps screen.

## Editing the Home screen

On the Home screen, tap and hold an empty area, or pinch your fingers together to access the editing options. You can set the wallpaper, add widgets, and more. You can also add, delete, or rearrange Home screen panels.

- Adding panels: Swipe to the left, and then tap  $\oplus$ .
- Moving panels: Tap and hold a panel preview, and then drag it to a new location.
- Deleting panels: Tap  $\text{🗑}$  on the panel.

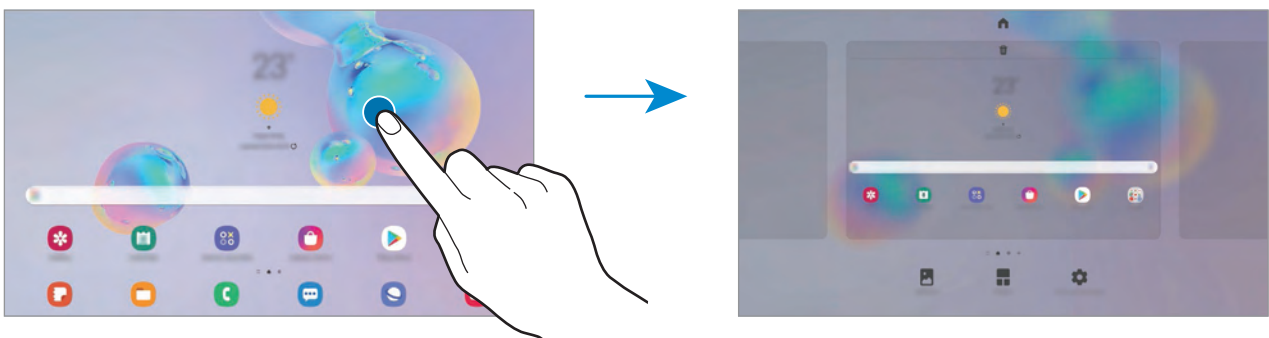

- **Wallpapers:** Change the wallpaper settings for the Home screen and the locked screen.
- **Widgets:** Widgets are small apps that launch specific app functions to provide information and convenient access on your Home screen. Tap and hold a widget, and then drag it to the Home screen. The widget will be added on the Home screen.
- **Home screen settings:** Configure settings for the Home screen, such as the screen grid or layout.

## Displaying all apps on the Home screen

Without using a separate Apps screen, you can set the device to display all apps on the Home screen. On the Home screen, tap and hold an empty area, and then tap **Home screen settings** → **Home screen layout** → **Home screen only** → **Apply**.

You can now access all your apps by swiping to the left on the Home screen.







## Indicator icons

Indicator icons appear on the status bar at the top of the screen. The icons listed in the table below are most common.



- The status bar may not appear at the top of the screen in some apps. To display the status bar, drag down from the top of the screen.
- Some indicator icons appear only when you open the notification panel.
- The indicator icons may appear differently depending on the service provider or model.

Icon	Meaning
	No signal
	Signal strength
	Roaming (outside of normal service area)
	GPRS network connected
	EDGE network connected
	UMTS network connected
	HSDPA network connected
	HSPA+ network connected
	LTE network connected
	Wi-Fi connected
	Bluetooth feature activated
	S Pen connected
	S Pen disconnected
	S Pen battery power level
	Location services being used
	Call in progress
	Missed call
	New text or multimedia message
	Alarm activated

Icon	Meaning
	Mute mode activated
	Vibration mode activated
	Flight mode activated
	Error occurred or caution required
	Battery charging
	Battery power level

## Edge panels

You can quickly access your favourite apps and features from the Edge panels.

Drag the Edge panel handle towards the centre of the screen.

If the Edge panel handle is not visible, launch the **Settings** app, tap **Display** → **Edge screen**, and then tap the **Edge panels** switch to activate it.

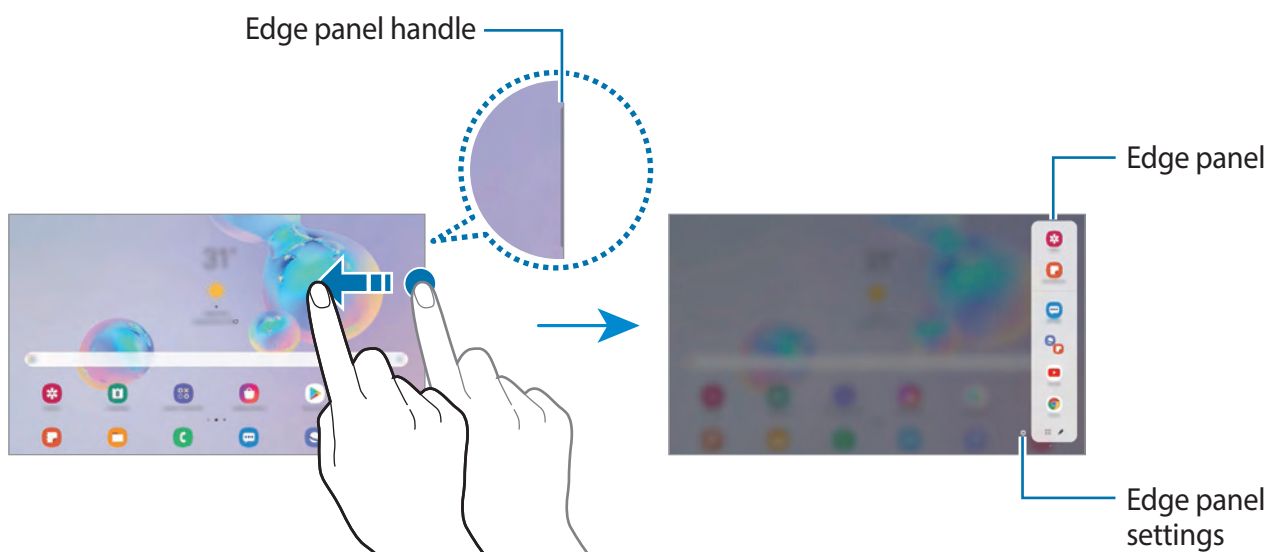

## Lock screen

Pressing the Side key turns off the screen and locks it. Also, the screen turns off and automatically locks if the device is not used for a specified period.

To unlock the screen, swipe in any direction when the screen turns on.

If the screen is off, press the Side key to turn on the screen. Alternatively, double-tap the screen.



Locked screen

## Changing the screen lock method

To change the screen lock method, launch the **Settings** app, tap **Lock screen** → **Screen lock type**, and then select a method.

When you set a pattern, PIN, password, or your biometric data for the screen lock method, you can protect your personal information by preventing others from accessing your device. After setting the screen lock method, the device will require an unlock code whenever unlocking it.

- **Swipe:** Swipe in any direction on the screen to unlock it.
- **Pattern:** Draw a pattern with four or more dots to unlock the screen.
- **PIN:** Enter a PIN with at least four numbers to unlock the screen.
- **Password:** Enter a password with at least four characters, numbers, or symbols to unlock the screen.
- **None:** Do not set a screen lock method.
- **Face:** Register your face to unlock the screen. Refer to [Face recognition](#) for more information.

- **Fingerprints:** Register your fingerprints to unlock the screen. Refer to [Fingerprint recognition](#) for more information.



You can set your device to perform a factory data reset if you enter the unlock code incorrectly several times in a row and reach the attempt limit. Launch the **Settings** app, tap **Lock screen** → **Secure lock settings**, unlock the screen using the preset screen lock method, and then tap the **Auto factory reset** switch to activate it.

## Notification panel

When you receive new notifications, indicator icons appear on the status bar. To see more information about the icons, open the notification panel and view the details.

To open the notification panel, drag the status bar downwards. To close the notification panel, swipe upwards on the screen.

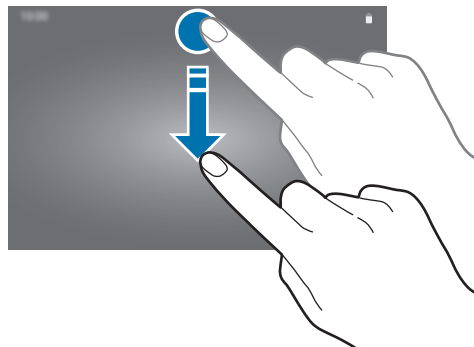

You can use the following functions on the notification panel.

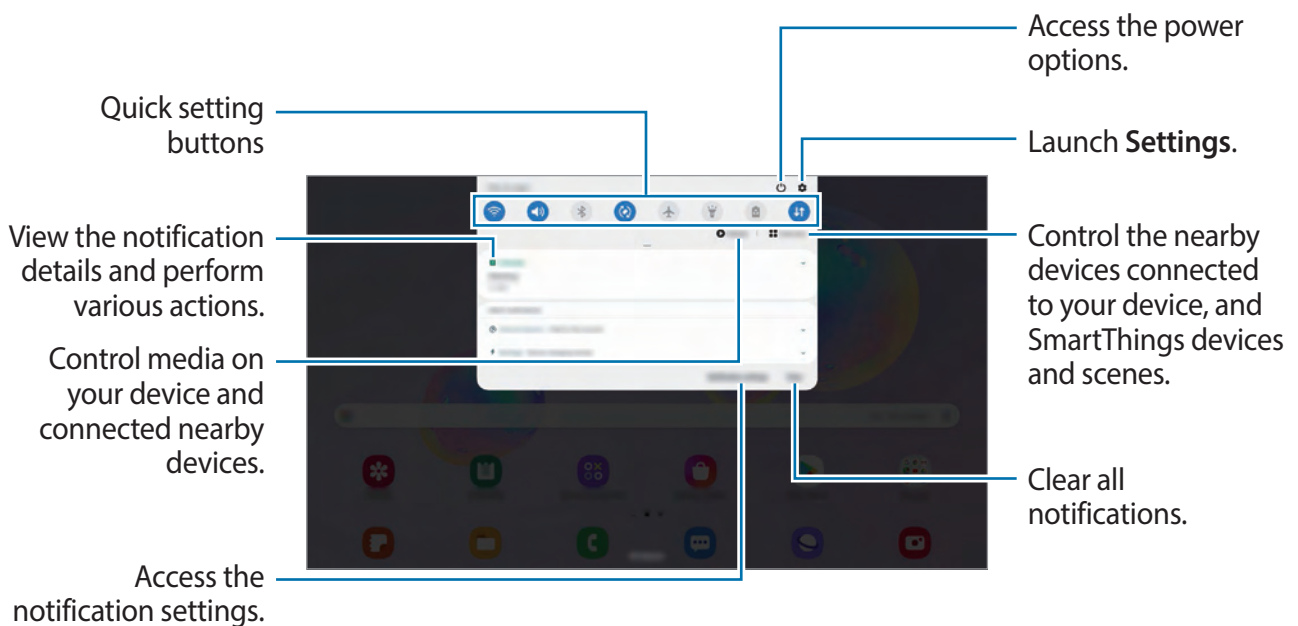

## Using quick setting buttons

Tap quick setting buttons to activate certain features. Swipe downwards on the notification panel to view more buttons.

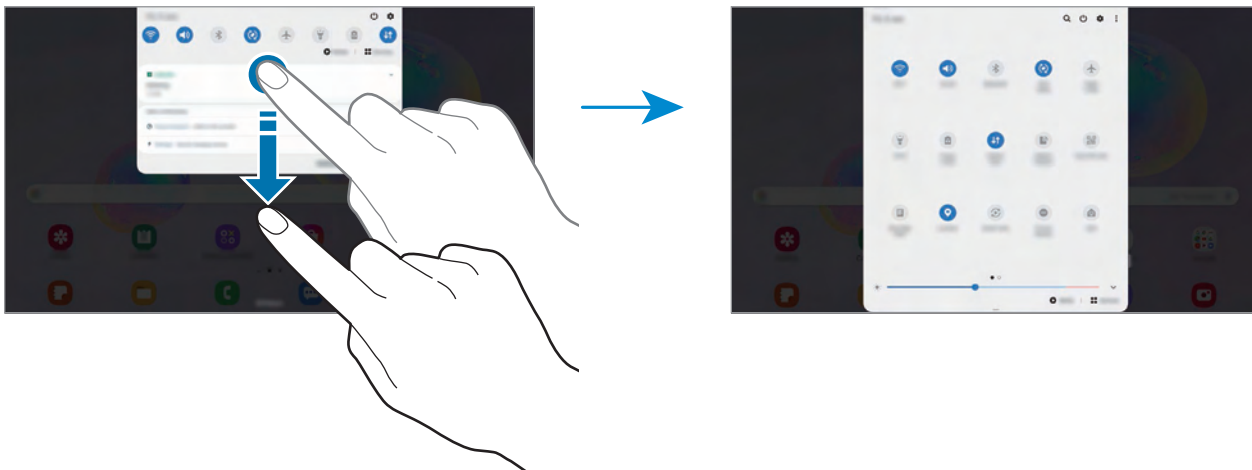

To change feature settings, tap the text under each button. To view more detailed settings, tap and hold a button.

To rearrange buttons, tap  → **Button order**, tap and hold a button, and then drag it to another location.

## Controlling media playback

Take control of music or video playback easily using the Media feature without launching related apps. You can also continue the playback on another device.

- 1 Open the notification panel and tap **Media**.
- 2 Tap the icons on the controller to control the playback.  
To continue the playback on another device, tap  and select a device you want.

# Screen capture and screen record

## Screen capture

Capture a screenshot while using the device and write on, draw on, crop, or share the captured screen. You can capture the current screen and scrollable area.

### How to capture a screenshot

Use the following methods to capture a screenshot. You can view the captured screenshots in **Gallery**.

**Method 1)** Key capture: Press the Side key and the Volume Down key simultaneously.

**Method 2)** Swipe capture: Swipe your hand to the left or right across the screen. (SM-T970, SM-T975, SM-T976B)



**Method 3)** Air command capture: Hover the S Pen over the screen and press the S Pen button to open the Air command panel, and then, tap **Screen write**. Refer to [Screen write](#) for more information.





- It is not possible to capture a screenshot while using some apps and features.
- If capturing a screenshot by swiping is not activated, launch the **Settings** app, tap **Advanced features** → **Motions and gestures**, and then tap the **Palm swipe to capture** switch to activate it. (SM-T970, SM-T975, SM-T976B)

After capturing a screenshot, use the following options on the toolbar at the bottom of the screen:



- : Capture the current content and the hidden content on an elongated page, such as a webpage. When you tap , the screen will automatically scroll down and more content will be captured.
- : Write or draw on the screenshot or crop a portion from the screenshot. You can view the cropped area in **Gallery**.







- **#**: Add tags to the screenshot. To search for screenshots by tag, tap  at the top of the Apps screen. You can view the tags list and easily search for the screenshot you want.
- : Share the screenshot with others.



If the options are not visible on the captured screen, launch the **Settings** app, tap **Advanced features** → **Screenshots and screen recorder**, and then tap the **Screenshot toolbar** switch to activate it.

## Screen record

Record the screen while using your device.

- 1 Open the notification panel, swipe downwards, and then tap  (**Screen recorder**) to activate it.
- 2 Select a sound setting and tap **Start recording**.  
After a countdown, recording will start.
  - To write or draw on the screen, tap .
  - To show the S Pen pointer on the screen, tap .
  - To record the screen with a video overlay of yourself, tap .
- 3 When you are finished recording the video, tap .  
You can view the video in **Gallery**.



To change the screen recorder settings, launch the **Settings** app and tap **Advanced features** → **Screenshots and screen recorder** → **Screen recorder settings**.

# Entering text

## Keyboard layout

A keyboard appears automatically when you enter text to send emails, create notes, and more.



Text entry is not supported in some languages. To enter text, you must change the input language to one of the supported languages.

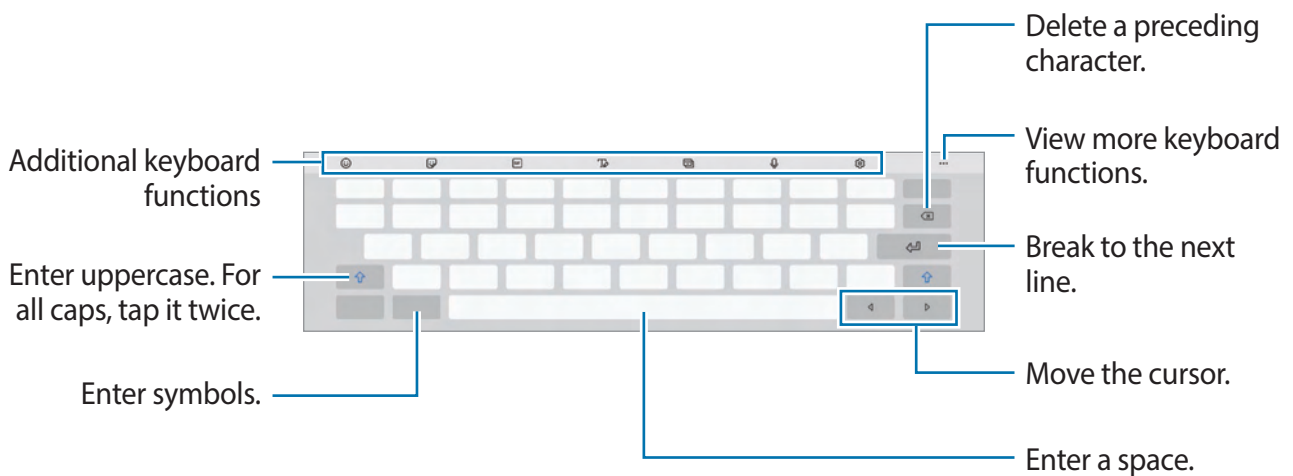

## Changing the input language

Tap  → **Languages and types** → **Manage input languages** and select the languages to use. When you select two or more languages, you can switch between the input languages by swiping to the left or right on the space key.

## Changing the keyboard

On the navigation bar, tap  to change the keyboard.



To change the keyboard type, tap  → **Languages and types**, select a language, and then select the keyboard type you want.







If the keyboard button  does not appear on the navigation bar, launch the **Settings** app, tap **General management** → **Language and input** → **On-screen keyboard**, and then tap the **Show Keyboard button** switch to activate it.









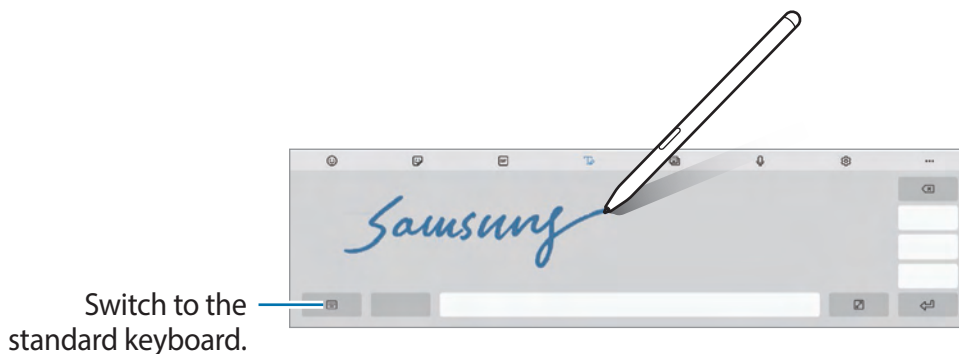









## Additional keyboard functions





Some features may not be available depending on the region or service provider.

-  : Enter emoticons.
-  : Enter stickers. You can also enter My Emoji stickers that look like you. Refer to [Using your emoji stickers in chats](#) for more information.
-  : Attach animated GIFs.
-  : Switch to handwriting mode.





-  : Change the keyboard mode.
-  : Enter text by voice.
-  : Change the keyboard settings.
-  →  : Search for content and enter it.
-  →  : Translate text and enter it.
-  →  : Enter your personal information registered to Samsung Pass.
-  →  : Share video links.
-  →  : Add an item from the clipboard.
-  →  : Open the text editing panel.
-  →  : Change the keyboard size.
-  →  : Enter stickers.

## Copying and pasting

- 1 Tap and hold over text.
- 2 Drag  or  to select the desired text, or tap **Select all** to select all text.
- 3 Tap **Copy** or **Cut**.  
The selected text is copied to the clipboard.
- 4 Tap and hold where the text is to be inserted and tap **Paste**.  
To paste text that you have previously copied, tap **Clipboard** and select the text.

## Dictionary

Look up definitions for words while using certain features, such as when browsing webpages.

- 1 Tap and hold over a word that you want to look up.
- 2 Tap **Dictionary** on the options list.  
If a dictionary is not preinstalled on the device, tap **Move to Manage dictionaries**, tap  next to a dictionary, and then tap **Install** to download it.
- 3 View the definition in the dictionary pop-up window.  
To switch to the full screen view, tap . Tap the definition on the screen to view more definitions. In the detailed view, tap  to add the word to your favourite words list or tap **Search Web** to use the word as a search term.

# Apps and features

## Installing or uninstalling apps

### Galaxy Store

Purchase and download apps. You can download apps that are specialised for Samsung Galaxy devices.

Launch the **Galaxy Store** app.



This app may not be available depending on the region or service provider.

### Installing apps

Browse apps by category or tap **Q** to search for a keyword.

Select an app to view information about it. To download free apps, tap **Install**. To purchase and download apps where charges apply, tap the price and follow the on-screen instructions.



To change the auto update settings, tap **≡** → **⚙** → **Auto update apps**, and then select an option.

### Play Store

Purchase and download apps.

Launch the **Play Store** app.

### Installing apps

Browse apps by category or search for apps by keyword.

Select an app to view information about it. To download free apps, tap **Install**. To purchase and download apps where charges apply, tap the price and follow the on-screen instructions.



To change the auto update settings, tap **≡** → **Settings** → **Auto-update apps**, and then select an option.

## Managing apps

### Uninstalling or disabling apps

Tap and hold an app and select an option.

- **Uninstall:** Uninstall downloaded apps.
- **Disable:** Disable selected default apps that cannot be uninstalled from the device.



Some apps may not support this feature.

### Enabling apps

Launch the **Settings** app, tap **Apps** → ▼ → **Disabled**, select an app, and then tap **Enable**.

### Setting app permissions

For some apps to operate properly, they may need permission to access or use information on your device.

To view your app permission settings, launch the **Settings** app and tap **Apps**. Select an app and tap **Permissions**. You can view the app's permissions list and change its permissions.

To view or change app permission settings by permission category, launch the **Settings** app and tap **Apps** → ⋮ → **Permission manager**. Select an item and select an app.



If you do not grant permissions to apps, the basic features of the apps may not function properly.

## S Pen features



### Air actions

Control apps remotely by using the S Pen connected to your device via Bluetooth Low Energy (BLE).

For example, you can quickly launch apps, such as the camera app, by pressing and holding the S Pen button. Also, while using the camera app, you can take a photo by pressing the button once. While playing music, you can turn the volume up if you lift the S Pen up while pressing and holding the S Pen button and turn the volume down if you lower it.

Launch the **Settings** app, tap **Advanced features** → **S Pen** → **Air actions**, and then tap the switch to activate the feature.



- The S Pen must be charged before you can use the Air action feature. Refer to [Charging the S Pen](#) for more information.
- When you detach the S Pen from the S Pen charger, the  icon will appear on the status bar. If the S Pen is discharged or far from the device, or if there are obstacles or there is external interference between the S Pen and the device, the S Pen will be disconnected from the device and the icon will turn grey (). To use the Air action feature again, connect the S Pen with the device by reattaching the S Pen to the S Pen charger.

### Taking photos with the S Pen

Even though you take photos with your device placing for a distance, you can easily take photos by pressing the S Pen button without setting a timer.

- 1 Launch the **Camera** app.
- 2 Press the S Pen button once to take a photo.
  - To change the shooting mode, move the S Pen to the left or right while pressing and holding the S Pen button.
  - To switch between cameras, press the S Pen button twice.

## Changing apps or features to use

Change the app, feature, or actions you want to use with the S Pen feature.

To change the app to launch, open the Air actions setting screen, tap **Hold down Pen button to**, and then select an app or feature.

To change actions for each app, open the Air actions setting screen and select an app under **App actions**. You can change actions by tapping items.

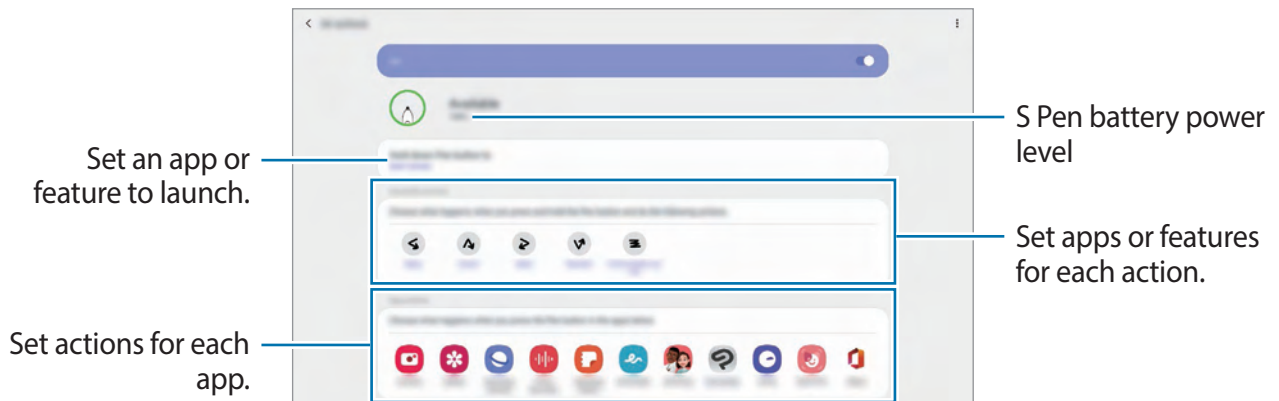

## Connecting another S Pen

Before using S Pen features with another S Pen, such as Air action, you must connect the S Pen to your device.

- 1 Attach the S Pen to the S Pen charger.
- 2 Open the notification panel, tap  (S Pen air actions), and then tap again to reactivate it.





### 3 Tap **Connect new S Pen**.

S Pen will be connected. You may experience a brief delay before it finishes connecting.



- You can only connect Samsung-approved S Pens that support Bluetooth Low Energy (BLE).
- Do not detach the S Pen from the device when it is being connected. Doing so will interrupt the process.
- If it fails to connect or you want to use the previous S Pen, reconnect it with the method shown above.

## Resetting your S Pen

If the S Pen has connection problems or the S Pen disconnects often, reset the S Pen and connect it again.

Attach the S Pen to the S Pen charger. Then, open the Air action setting screen and tap  → **Reset S Pen**.

## S Pen pointer

Use your S Pen as a pointer.

While pressing and holding the S Pen button, shake your S Pen to activate the S Pen pointer feature. If you are using this feature for the first time, tap **Get started** and follow the on-screen instructions to calibrate your S Pen. When the calibration is finished, the laser pointer will appear on the screen.

- Moving the pointer: Move your S Pen while pressing the S Pen button.
- Selecting an item: Point at an item with the pointer and press the S Pen button.
- Scrolling the screen: Press and hold the S Pen button to activate scroll mode and move your S Pen up or down while pressing the S Pen button.
- Spotlighting a part: Press the S Pen button twice and hold to activate spotlight mode and move your S Pen while pressing the S Pen button.

To deactivate spotlight mode, press the S Pen button twice and hold it.

To deactivate the S Pen pointer feature, shake your S Pen while pressing the S Pen button.



To configure settings, such as the pointer speed, launch the **Settings** app and tap **Advanced features** → **S Pen** → **S Pen pointer**.

## Air command

Air command is a menu that provides S Pen features and quick access to frequently used apps.

To open the Air command panel, hover the S Pen over the screen and press the S Pen button. You can also tap the Air command icon with the S Pen.

Drag upwards or downwards on the Air command panel and select a function or app you want.



When the screen is off or locked with a screen lock method, removing the S Pen will not open the Air command panel.

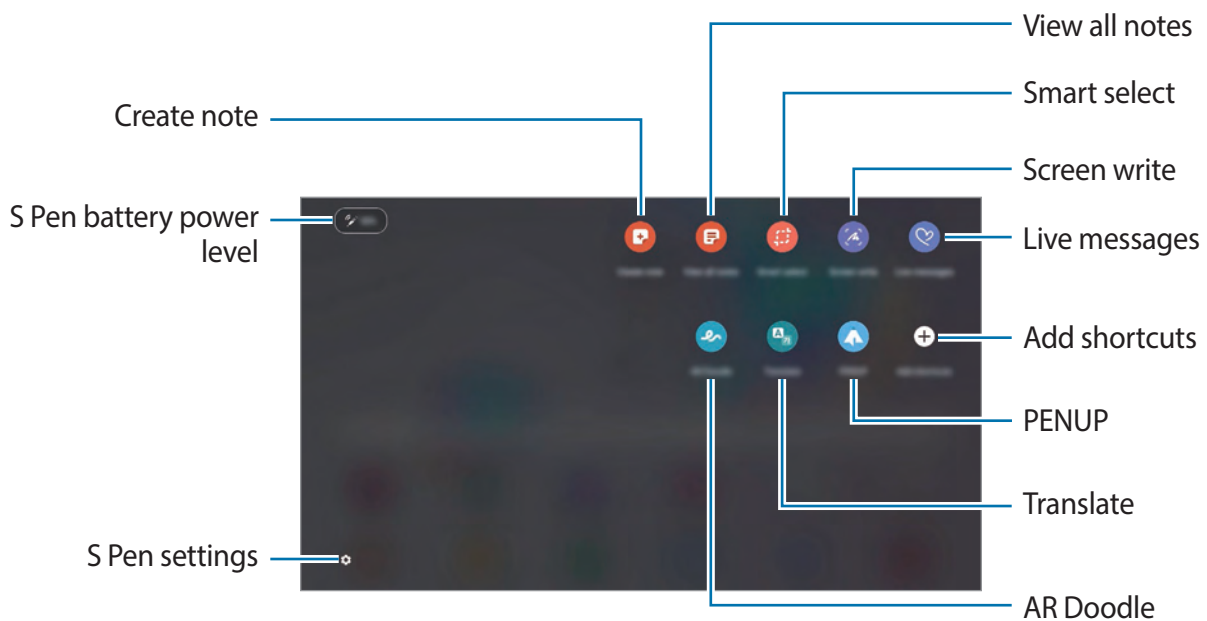

## Adding shortcuts to the Air command panel

Add shortcuts to frequently used apps or functions to the Air command panel.

On the Air command panel, tap **Add shortcuts** and select apps or functions to open from the panel.

Alternatively, open the Air command panel and tap  → **Shortcuts**.

## S Pen features

Activate various S Pen features from the Air command panel. The shortcuts that do not appear on the panel by default can be added by using the Add shortcuts feature.

- **Create note:** Create notes easily in a pop-up window without launching the **Samsung Notes** app. Refer to [Create note](#) for more information.
- **View all notes:** View all notes in the **Samsung Notes** app.
- **Smart select:** Use the S Pen to select an area and perform actions, such as sharing or saving. Refer to [Smart select](#) for more information.
- **Screen write:** Capture screenshots to write or draw on them or crop an area from the captured image. You can also capture the current content and the hidden content on an elongated page, such as a webpage. Refer to [Screen write](#) for more information.
- **Live messages:** Instead of text message, create and send a unique message by recording your actions while handwriting or drawing a live message and saving it as an animated file. Refer to [Live messages](#) for more information.
- **AR Doodle:** Record fun videos with virtual handwriting or drawings on faces. Refer to [AR Doodle](#) for more information.
- **Translate:** Hover the S Pen over a word to translate it. Refer to [Translate](#) for more information.
- **PENUP:** Post your artwork, view others' artwork, and get useful drawing tips. Refer to [PENUP](#) for more information.
- **Bixby Vision:** Use the Bixby Vision features to search for similar images, detect and translate text, and more. Refer to [Bixby Vision](#) for more information.
- **Magnify:** Hover the S Pen over an area of the screen to enlarge it. Refer to [Magnify](#) for more information.
- **Glance:** Reduce an app to a thumbnail and hover the S Pen over the thumbnail to open the app in full screen view. Refer to [Glance](#) for more information.
- **Colouring:** Add colours to images provided by PENUP using the S Pen.
- **Write on calendar:** Launch the **Calendar** app and write or draw on the screen. Refer to [Write on calendar](#) for more information.
- **Add shortcuts:** Add shortcuts to frequently used apps to the Air command panel.

## Air command icon

When the Air command panel is closed, the Air command icon will remain on the screen. You can open the Air command panel by tapping the icon with the S Pen.

To move the icon, drag  to a new location.

To remove the icon, drag  to **Remove** at the top of the screen.

If the Air command icon does not appear on the screen, launch the **Settings** app, tap **Advanced features** → **S Pen**, and then tap the **Show floating icon** switch to activate it.

While using apps that support the Air action feature, you can view actions available with each app by hovering the S Pen over the Air command icon.

## Create note

Create notes easily in a pop-up window without launching the **Samsung Notes** app.

- 1 Open the Air command panel and tap **Create note**. Alternatively, double-tap the screen while pressing and holding the S Pen button.

The note screen will appear as a pop-up window.

- 2 Create a note using the S Pen.

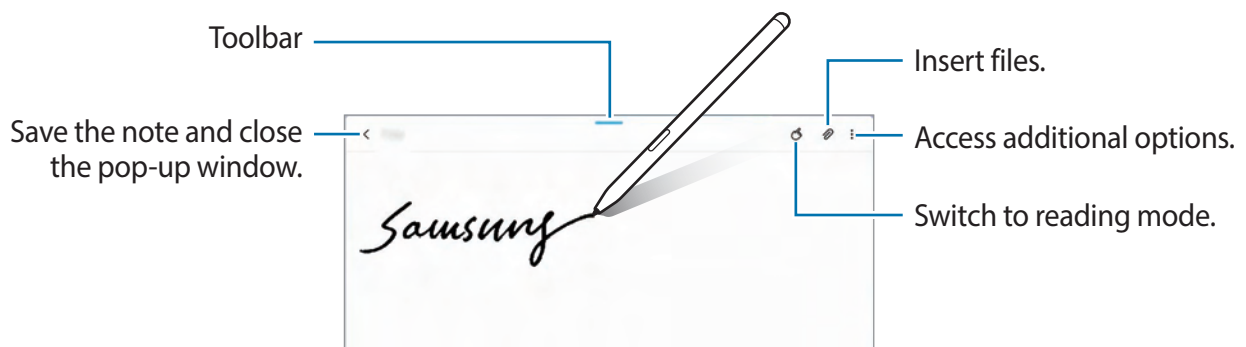

- 3 When you are finished composing the note, tap <.

The note will be saved in **Samsung Notes**.





## Smart select

Use the S Pen to select an area and perform actions, such as sharing or saving. You can also select an area from a video and capture it as a GIF animation.

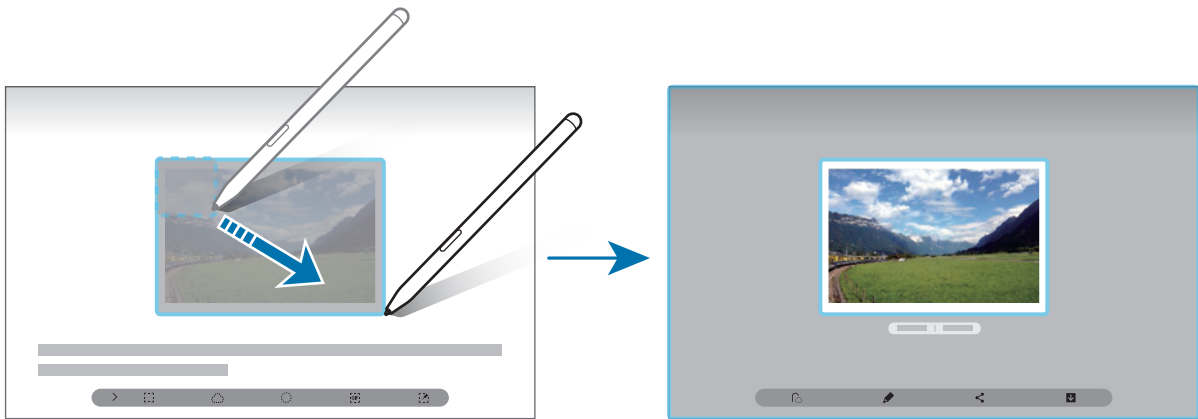
- 1 When there is content you want to capture, such as a part of an image, open the Air command panel and tap **Smart select**.
- 2 Select a desired shape icon on the toolbar and drag the S Pen across the content you want to select.

To pin the selected area at the top of the screen, tap , select the area and then tap **Pin to screen**.



- 3 Select an option to use with the selected area.
  - **Extract text:** Extract text from the selected area.
  - **Pin to screen:** Pin the selected area to the screen.
  - : Automatically changes the appearance of the selected area.
  - : Write or draw on the selected area.
  - : Share the selected area with others.
  - : Save the selected area in **Gallery**.

## Capturing an area from a video

While playing a video, select an area and capture it as a GIF animation.

- 1 When there is content you want to capture during video playback, open the Air command panel and tap **Smart select**.
- 2 On the toolbar, tap .
- 3 Adjust the position and size of the capturing area.







- 4 Tap **Record** to start capturing.



- Before capturing a video, make sure that the video is playing.
- The maximum duration you can capture an area of the video for will be displayed on the screen.
- When capturing an area from a video, its sound will not be recorded.

- 5 Tap **Stop** to stop capturing.

- 6 Select an option to use with the selected area.

- : Write or draw on the selected area. Tap  to view the result before saving the file.
- : Share the selected area with others.
- : Save the selected area in **Gallery**.

## Screen write

Capture screenshots to write or draw on them or crop an area from the captured image.



It is not possible to capture a screenshot while using some apps.

- 1 When there is content you want to capture, open the Air command panel and tap **Screen write**.



The current screen is automatically captured and the editing toolbar appears.

- 2 If you capture the content on an elongated page, such as a webpage, tap **Scroll capture** to capture the hidden content. Tap **Scroll capture** repeatedly until screen capture is complete, and then tap **Done**.

- 3 Write a memo on the screenshot.



- 4 Select an option to use with the screenshot.

- : Share the screenshot with others.
- : Save the screenshot in **Gallery**.

## Live messages

Instead of a text message, create and send a unique message by recording your actions while handwriting or drawing a live message and saving it as an animated file.

- 1 When you want to send an animated message, open the Air command panel and tap **Live messages**.

The live message window will appear.

- 2 Customise background image and tap **Done** or **Start drawing**.

- **Gallery:** Set a photo or a video saved in **Gallery** as a background image.
- **Camera:** Take a photo or record a video and set it as a background image.
- **Colour:** Select a background colour.

- 3 Write or draw on the live message screen.

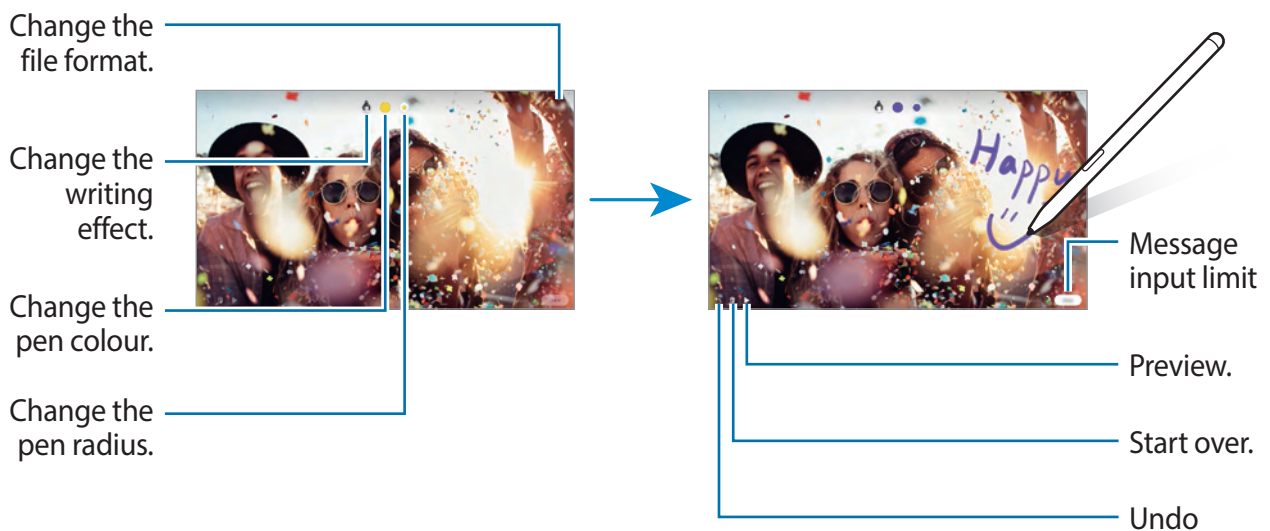

- 4 Tap **Done**.

The live message will be saved in **Gallery** as an animated GIF file or a video.

- 5 Tap **Share** and select a method.



## Translate

Hover the S Pen over the text you want to translate. The units included in the text will also be converted.



- To use this feature, your device must be connected to a Wi-Fi or mobile network.
- This feature does not support some languages.
- This feature is available only when detectable text is on the screen.

1 When there is text you want to translate, open the Air command panel and tap **Translate**.

2 Select the languages on the translator panel at the top of the screen.

You can change the text between words and sentences by tapping  or .

3 Hover the S Pen over the text you want to translate or the unit you want to convert.

The translated text will appear. To listen to the pronunciation of the original text, tap .



The  icon may not appear depending on the language you select.

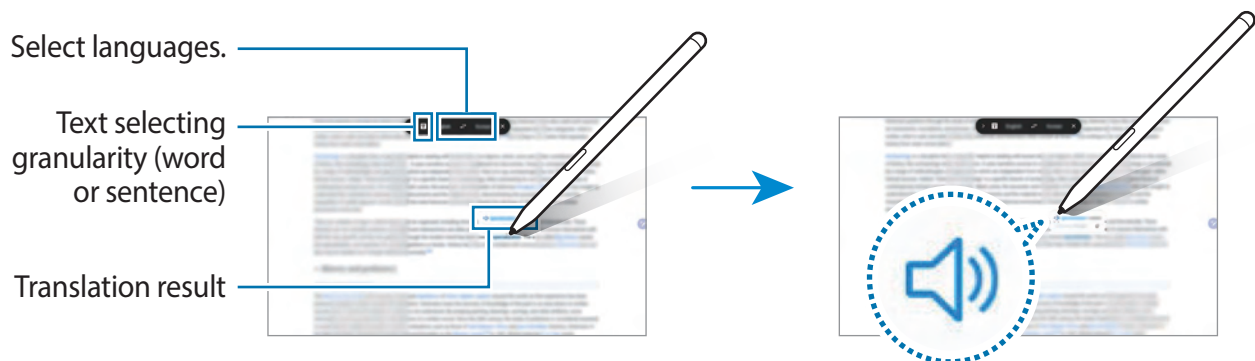

4 To close the translator, tap **X** on the translator panel.

## Bixby Vision

When you hover the S Pen over the content, the content is recognised and available search icons will appear. Use the features to search for similar images, detect and translate text, and more. Refer to [Bixby Vision](#) for more information.

- 1 When there is an image you want to search for relevant information or extract text from, open the Air command panel and tap **Bixby Vision**.
- 2 Hover the S Pen over the content you want.  
When the content is recognised, the available search icons will appear.

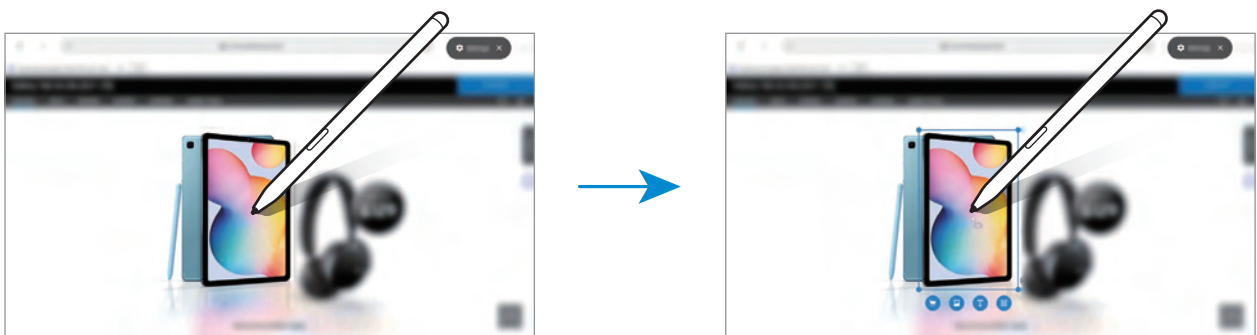

- 3 Select an icon you want.
- 4 To close Bixby Vision, tap **X** on the Bixby Vision panel.

## Magnify

Hover the S Pen over an area of the screen to enlarge it.

Open the Air command panel, tap **Magnify**, and hover the S Pen over the area you want to enlarge.

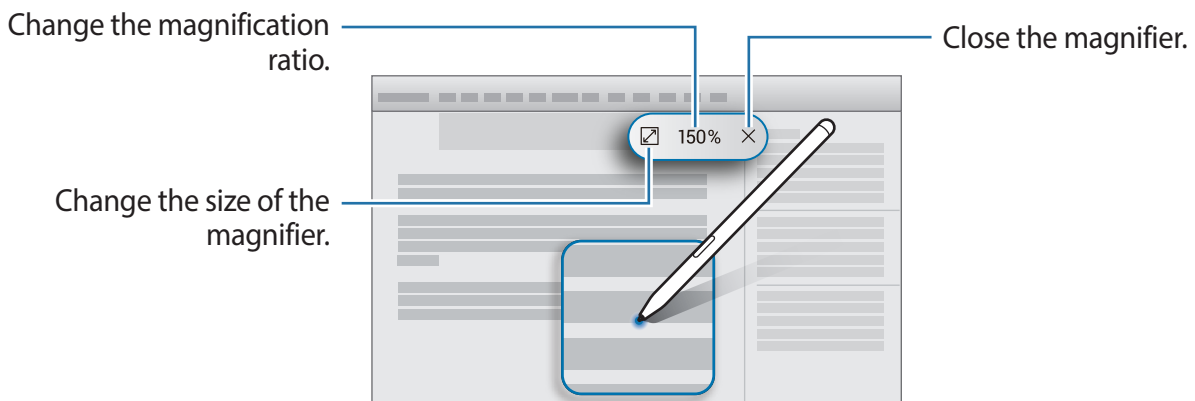

## Glance

Reduce an app to a thumbnail and hover the S Pen over the thumbnail to open the app in full screen view.

For example, launch a map app, open the Air command panel, and then tap **Glance**. The app will be reduced to a thumbnail at the bottom of the screen. While browsing webpages, hover the S Pen over the thumbnail to open the map app on the full screen and quickly search for places.

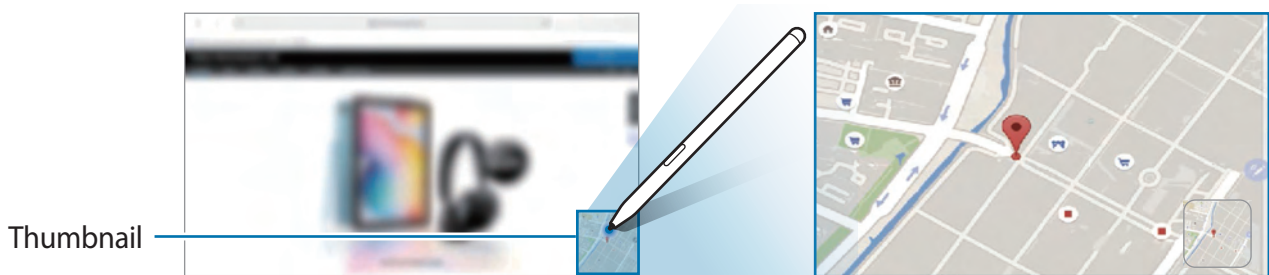

Hover the S Pen away from the screen to reduce the app to a thumbnail again.

To close the minimised app, tap and hold the thumbnail and drag it to **Remove** at the top of the screen.

## Write on calendar

Mark your schedules easily and quickly by writing or drawing on the calendar screen. You can view and manage your schedules on the calendar screen.

Open the Air command panel, tap **Write on calendar**, and then mark your schedules on the calendar. When you are finished, tap **Save**. To edit it, tap .

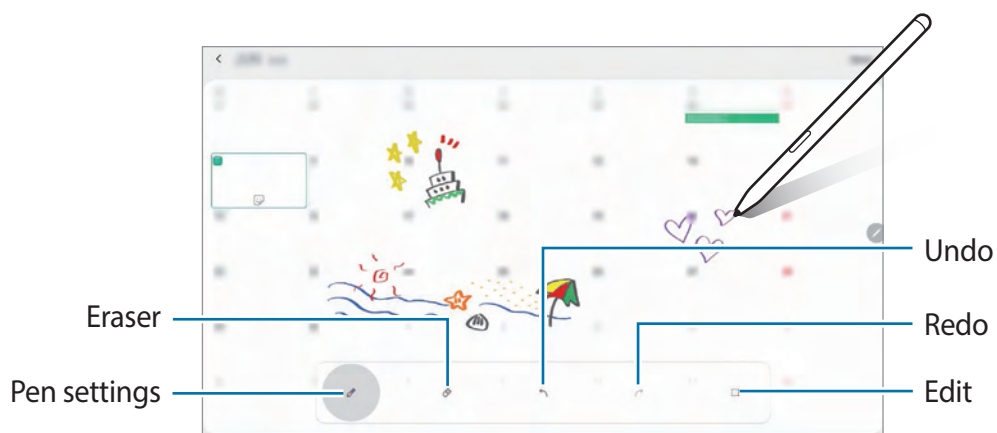

You can use this feature only on the calendar of monthly view.

## Air view

Hover the S Pen over an item on the screen to preview content or view information in a pop-up window.

In some apps, Action buttons will be displayed on the preview window.

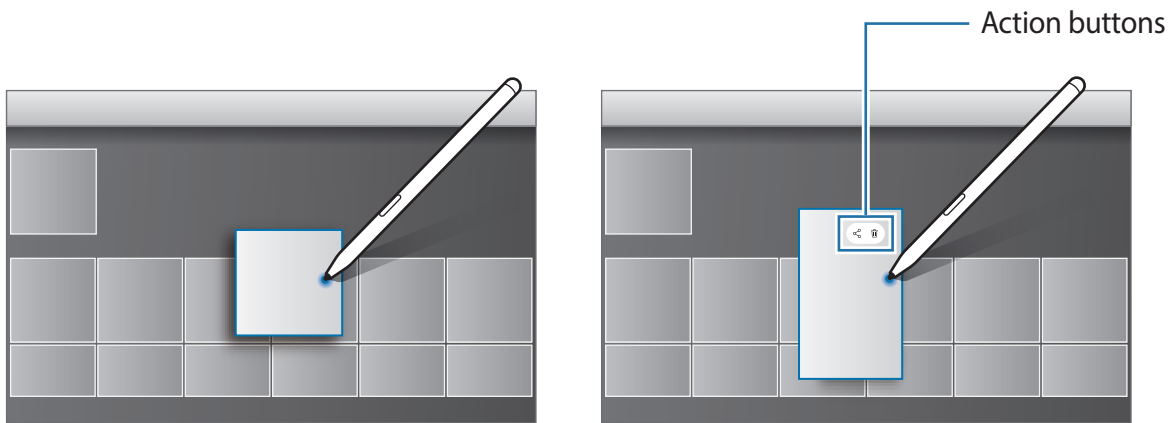

If this feature is not activated, launch the **Settings** app, tap **Advanced features** → **S Pen**, and then tap the **Air view** switch to activate it.

## Pen Select

While pressing and holding the S Pen button, drag the S Pen over text or item lists to select multiple items or text. You can also copy and paste the selected items or text into another app or share them with others.

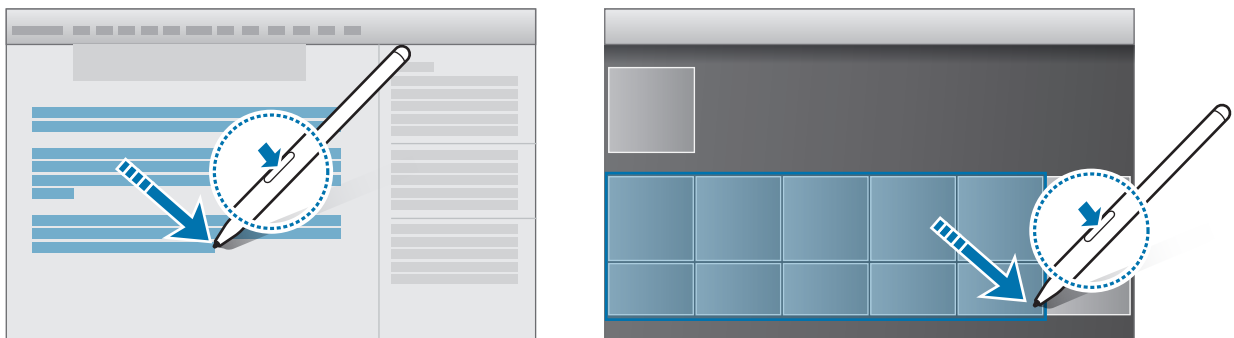

## Screen off memo

You can quickly create memos by writing on the screen without turning on it.



If this feature is not activated, launch the **Settings** app, tap **Advanced features** → **S Pen**, and then tap the **Screen off memo** switch to activate it.

### Creating a screen off memo

1 When the screen is off, hover the S Pen over the screen and press the S Pen button.

2 Write or draw a memo.

To extend the page, tap .

To save the memo, tap **Save** or reattach the S Pen to the S Pen charger. The memo will be saved to **Samsung Notes** →  → **Folders** → **Screen off memo**.

## Unlocking the screen using the S Pen

If the screen is locked while the S Pen is connected, you can unlock the screen by pressing the S Pen button.



- The **Use S Pen unlock** feature is available only when the screen lock method is set.
- To use this feature, the S Pen must be connected to your device.

1 Launch the **Settings** app and tap **Advanced features** → **S Pen** → **S Pen unlock**.

2 Tap **Use S Pen unlock** → **OK**.

3 Unlock the screen using the preset screen lock method.

Now you can unlock the screen by pressing the S Pen button.

## Bixby

### Introduction

Bixby is a user interface that helps you use your device more conveniently.

You can talk to Bixby or type text. Bixby will launch a function you request or show the information you want. It also learns your usage patterns and environments. The more it learns about you, the more precisely it will understand you.



- To use Bixby, your device must be connected to a Wi-Fi or mobile network.
- To use Bixby, you must sign in to your Samsung account.
- Bixby is only available in some languages, and certain features may not be available depending on your region.

## Starting Bixby

When you launch Bixby for the first time, the Bixby intro page will appear. You must select the language to use with Bixby, sign in to your Samsung account according to the on-screen instructions, and then agree to the terms and conditions.

- 1 Press and hold the Side key. Alternatively, launch the **Bixby** app.



- 2 Select the language to use with Bixby.
- 3 Tap **Sign in to Samsung account** and follow the on-screen instructions to sign in to your Samsung account.



If you are already signed in, your account information will appear on the screen.

- 4 Follow the on-screen instructions to complete the setup.  
The Bixby screen will appear.

## Using Bixby

When you say what you want to Bixby, Bixby will launch corresponding functions or show the information you requested.



While pressing and holding the Side key, say what you want to Bixby, and release your finger from the key when you are finished speaking. Alternatively, say “Hi, Bixby”, and when the device emits a sound, say what you want.

For example, while pressing and holding the Side key, say “How’s the weather today?” The weather information will appear on the screen.

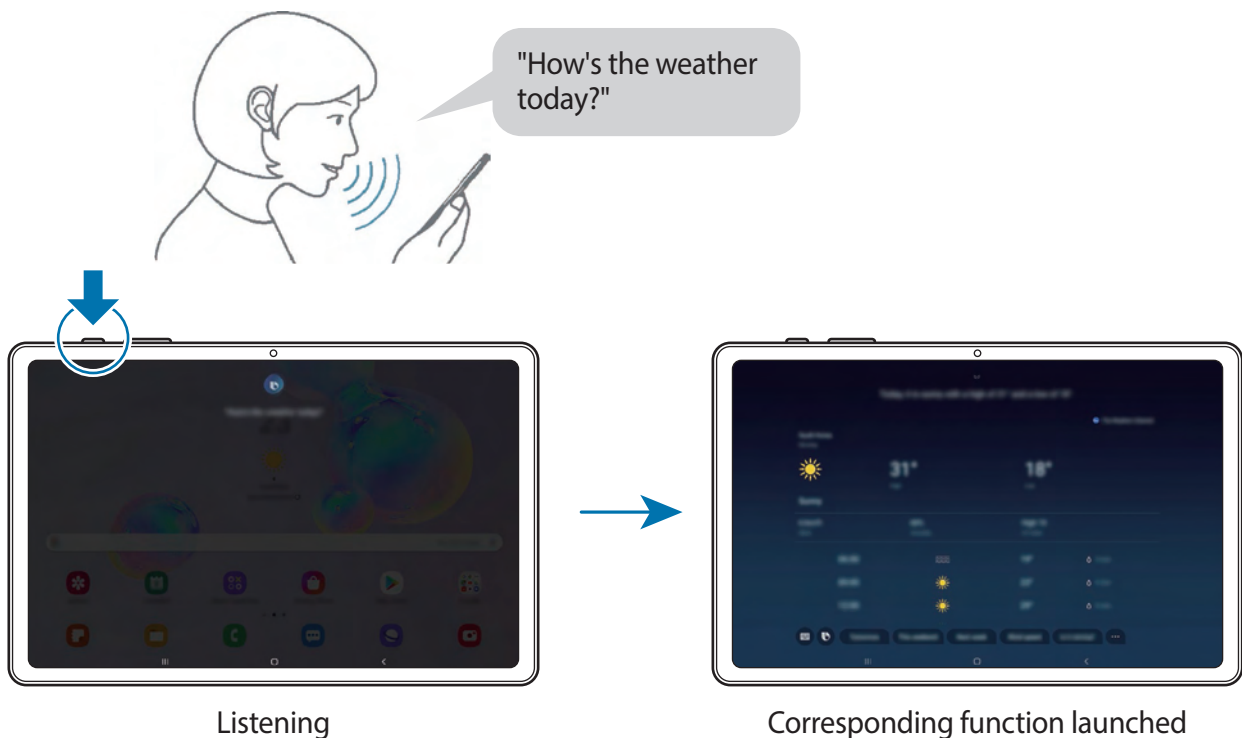
If you want to know the weather tomorrow, while pressing and holding the Side key, just say “Tomorrow?” Because Bixby understands the context of the conversation, it will show you tomorrow’s weather.





If Bixby asks you a question during a conversation, while pressing and holding the Side key, answer Bixby. Or, tap  and answer Bixby.

If you are using headphones or Bluetooth audio, or start a conversation by saying “Hi, Bixby”, you can continue the conversation without tapping the icon. Launch the **Bixby** app and tap  →  → **Automatic listening** → **Hands-free only**.



## Waking up Bixby using your voice

You can start a conversation with Bixby by saying “Hi, Bixby”. Register your voice so that Bixby will respond to your voice when you say “Hi, Bixby”.

- 1 Launch the **Bixby** app and tap  →  → **Voice wake-up**.
- 2 Tap the **Wake with “Hi, Bixby”** switch to activate it.
- 3 Follow the on-screen instructions to complete the setup.

Now you can say “Hi, Bixby”, and when the device emits a sound, start a conversation.

## Communicating by typing text

If your voice is not recognised due to noisy environments or if you are in a situation where speaking is difficult, you can communicate with Bixby via text.

Launch the **Bixby** app, tap , and then type what you want.

During the communication, Bixby also will answer you through text instead of voice feedback.

## Bixby usages

### Launching apps or services

You can launch features quickly via Bixby. You can also use various convenient services, such as ordering coffee or searching for nearby restaurants or hotels and making a reservation.

For example, while pressing and holding the Bixby key, say “Call mom”, and then release your finger from the Bixby key. Bixby will now make a call to the contact saved as mom.

### Viewing more ways to use Bixby

To view more ways to use Bixby, launch the **Bixby** app and tap **All capsules** (or **Marketplace**). You can check out services supported by Bixby and examples of commands.



Some features may not be available depending on the region or service provider.

# Bixby Vision

## Introduction

Bixby Vision is a service that provides various features based on image recognition.

You can use Bixby Vision to quickly search for information by recognising objects or your current location.

Use a variety of useful Bixby Vision features.

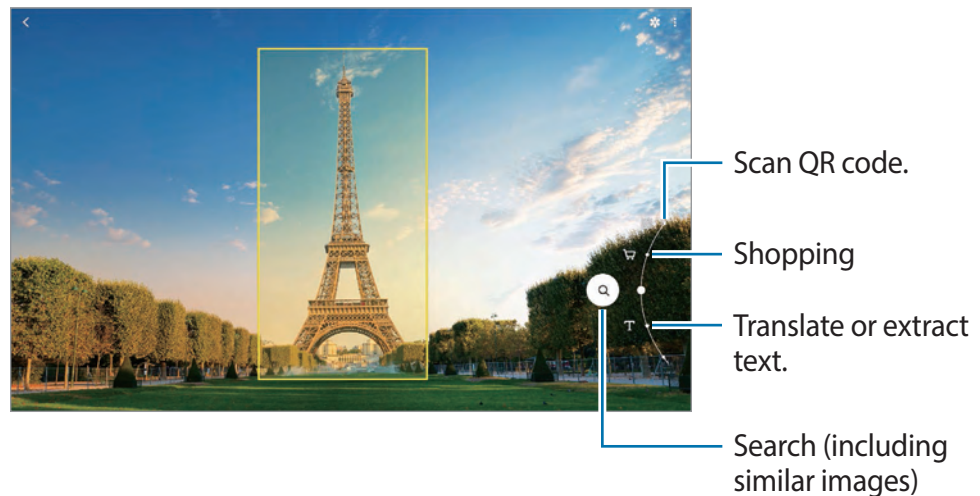

- To use this feature, the device must be connected to a Wi-Fi or mobile network.
- The available features and search results may vary depending on the region or service provider.
- This feature may not be available or you may not get correct search results depending on the image size, format, or resolution.
- Samsung is not responsible for the product information provided by Bixby Vision.

## Launching Bixby Vision



Launch Bixby Vision using one of these methods.

- In the **Camera** app, tap **MORE** on the shooting modes list and tap **BIXBY VISION**.
- In the **Gallery** app, select an image and tap .
- In the **Internet** app, tap and hold an image and tap **Bixby Vision**.
- If you added the Bixby Vision app icon to the Apps screen, launch the **Bixby Vision** app.

## Translating or extracting text

Recognise and show the translated text on the screen. You can also extract text from a document or an image file.

For example, if you want to know what a sign says while travelling abroad, use the Bixby Vision features. The device will translate the sign's text into the language you select.

- 1 Launch the **Camera** app, tap **MORE** on the shooting modes list, and then tap **BIXBY VISION**.
- 2 Select  and keep the text within the screen to recognise it.  
The translated text will appear on the screen.
  - To extract text, tap . If you tap , you can use additional features with the extracted text, such as sharing or saving it.
  - To change the source or target language, tap the language settings panel at the bottom of the screen.

## Searching for similar images and related information

Search for images similar to the recognised object online and related information. You can view various images with properties similar to the object, such as colour or shape, and view the related information.

For example, if you want to know the information about a building, use the Bixby Vision features. The device will search for and show you related information or images with similar characteristics.

- 1 Launch the **Camera** app, tap **MORE** on the shooting modes list, and then tap **BIXBY VISION**.
- 2 Select  and keep the object within the screen to recognise it.
- 3 Select a search result.  
The similar images and related information will appear.

## Searching for shopping information

Recognise a product to search for information even when you do not know the product's name.

For example, if you want to search for the product's information online, use the Bixby Vision features and the device will search for it and show you the results.

- 1 Launch the **Camera** app, tap **MORE** on the shooting modes list, and then tap **BIXBY VISION**.
- 2 Select  and keep the object within the screen to recognise it.
- 3 Select a search result.  
The information about the product will appear.

## Reading QR codes

Recognise QR codes and view a variety of information, such as websites, photos, videos, maps, and business cards.

- 1 Launch the **Camera** app, tap **MORE** on the shooting modes list, and then tap **BIXBY VISION**.
- 2 Select  and keep the QR code within the screen to recognise it.  
The information connected to the QR code will appear.

# Bixby Routines

## Introduction

Bixby Routines is a service that runs the features you want to use as routines when their conditions are detected.

For example, if you want to set the device to turn on the auto rotate feature whenever you play a video, add the video app you want as a condition and set the auto rotate feature as an action.

## Adding routines

Add routines to use your device more conveniently. When you add a routine, you can set its running condition to auto or manual.

### Adding recommended routines

When the conditions of routines on the recommended list of the Bixby Routines main screen are detected, Bixby Routines will suggest that you add one of them as a routine.

When the recommendation notification appears, tap **View all** and add it as your own routine.

### Adding routines from the recommendation list

View the list of useful features and add them as your own routines.



- 1 Launch the **Settings** app and tap **Advanced features** → **Bixby Routines**.
- 2 On the **Discover** list, select a routine you want and tap **Save**.
  - To set the routine's conditions and actions, tap **Edit**. Alternatively, tap the condition or action you want to edit.
  - If you want to set the routine's running condition to manual, tap **Start button tapped**. This option will appear only when there are no running conditions set.For manual routines, you can add them to the Home screen as widgets and access them quickly. When a pop-up window appears, tap **Add**.

## Adding your own routines

Add features you want to use as routines.

- 1 Launch the **Settings** app and tap **Advanced features** → **Bixby Routines** → **+**.
- 2 Tap **+**, set conditions, and then tap **Next**.  
If you want to set the routine's running condition to manual, tap **Start button tapped**.
- 3 Tap **+**, set actions, and then tap **Done**.
- 4 Enter a routine name and tap **Done**.  
For manual routines, you can add them to the Home screen as widgets and access them quickly. When a pop-up windows appears, tap **Add**.

## Using routines

### Running auto routines

Auto routines will run automatically when their conditions are detected.

### Running manual routines

For manual routines which you set the running condition as **Start button tapped**, you can run them manually by tapping the button whenever you want.

Launch the **Settings** app, tap **Advanced features** → **Bixby Routines** → **My routines**, and then tap  next to the routine you want to run. Alternatively, tap the routine's widget on the Home screen.

### Viewing running routines

Currently running routines will appear on the notification panel. To view a routine's details, tap the notification.

### Stopping running routines

You can quickly stop running routines. On the notification panel, tap  next to a routine and tap **Stop**.

## Managing routines

Launch the **Settings** app and tap **Advanced features** → **Bixby Routines** → **My routines**. Your routines will appear.

To deactivate a routine, tap the routine's switch or .

To edit a routine, select a routine and tap **Edit**. Alternatively, tap the condition or action you want to edit.

To delete routines, tap  → **Delete**, tick routines to delete, and then tap **Delete**.

## Phone

### Introduction



Make or answer voice and video calls.



- To make a call and send a text message, launch the **Settings** app, tap **Advanced features**, and then tap the **Call & text on other devices** switch to activate it. You must register and sign in to the same Samsung account on your device and the other device. Some calling and messaging features may not be available. (SM-T870, SM-T875, SM-T970, SM-T976B)
- You can select the call and text method. Select a SIM card or your connected device using the same Samsung account.

### Making calls

- 1 Launch the **Phone** app and tap **Keypad**.
- 2 Enter a phone number.

3 Tap  to make a voice call, or tap  to make a video call.

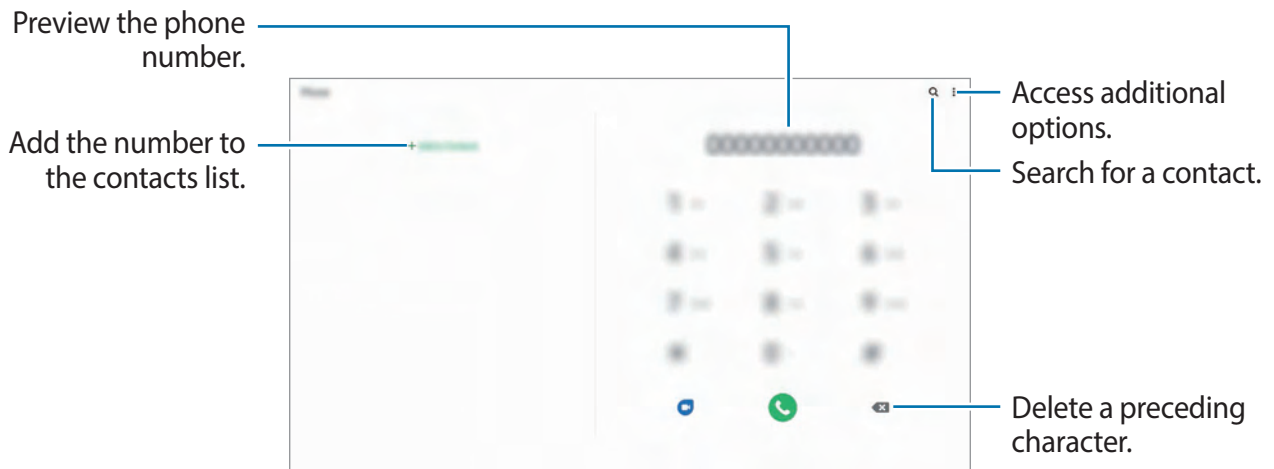

## Making calls from call logs or contacts list

Launch the **Phone** app, tap **Recents** or **Contacts**, and then swipe to the right on a contact or a phone number to make a call.

If this feature is deactivated, launch the **Settings** app, tap **Advanced features** → **Motions and gestures**, and then tap the **Swipe to call or send messages** switch to activate it.

## Using speed dial

Set speed dial numbers to quickly make calls.

To set a number to speed dial, launch the **Phone** app, tap **Keypad** or **Contacts** →  → **Speed dial numbers**, select a speed dial number, and then add a phone number.

To make a call, tap and hold a speed dial number on the keypad. For speed dial numbers 10 and up, tap the first digit(s) of the number, and then tap and hold the last digit.

For example, if you set the number **123** as a speed dial number, tap **1**, tap **2**, and then tap and hold **3**.



## Making calls by searching for nearby places

You can easily make calls to places near your current location by searching for their information. You can search for nearby places by category, such as restaurants or stores, or by selecting recommended hot places.

Launch the **Phone** app, tap **Places**, and then select a category or tap **Q** and enter a business name in the search field. Or, select one from the recommended hot places. The business's information, such as its phone number or address, will appear.



This feature may not be available depending the model and its specifications.

## Making an international call

- 1 Launch the **Phone** app and tap **Keypad**.
- 2 Tap and hold **0** until the + sign appears.
- 3 Enter the country code, area code, and phone number, and then tap .

## Receiving calls



### Answering a call

When a call comes in, drag  outside the large circle.

### Rejecting a call

When a call comes in, drag  outside the large circle.

To send a message when rejecting an incoming call, drag the **Send message** bar upwards and select a message to send. If the **Add reminder** switch is activated, a reminder will be saved to alert you of the rejected call one hour later.



To create various rejection messages, launch the **Phone** app, tap  → **Settings** → **Quick decline messages**, enter a message, and then tap .

### Missed calls

If a call is missed, the  icon appears on the status bar. Open the notification panel to view the list of missed calls. Alternatively, launch the **Phone** app and tap **Recents** to view missed calls.

## Blocking phone numbers

Block calls from specific numbers added to your block list.

- 1 Launch the **Phone** app and tap  → **Settings** → **Block numbers**.
- 2 Tap **Recents** or **Contacts**, select contacts or phone numbers, and then tap **Done**.  
To manually enter a number, tap **Add phone number**, enter a phone number, and then tap .

When blocked numbers try to contact you, you will not receive notifications. The calls will be logged in the call log.



You can also block incoming calls from people that do not show their caller ID. Tap the **Block unknown/hidden numbers** switch to activate the feature.



## Options during calls



The available options may vary depending on the region or service provider.

## During a voice call

The following actions are available:



- : Access additional options.
- **Add call**: Dial a second call. The first call will be put on hold. When you end the second call, the first call will be resumed.
- **Message**: Send a message to the caller.
- **Bluetooth**: Switch to a Bluetooth headset if it is connected to the device.
- **Hold call**: Hold a call. Tap **Resume call** to retrieve the held call.
- **Mute**: Turn off the microphone so that the other party cannot hear you.
- **Keypad / Hide**: Open or close the keypad.
- : End the current call.

## During a video call

Tap the screen to use the following options:



The video call feature may vary depending on the region or service provider.

- : Access additional options.
- **Camera:** Turn off the camera so that the other party cannot see you.
- **Switch:** Switch between the front and rear cameras.
- : End the current call.
- **Mute:** Turn off the microphone so that the other party cannot hear you.
- **Bluetooth:** Switch to a Bluetooth headset if it is connected to the device.

## Adding a phone number to Contacts

### Adding a phone number to Contacts from the keypad

- 1 Launch the **Phone** app and tap **Keypad**.
- 2 Enter the number.
- 3 Tap **Add to Contacts**.
- 4 Tap **Create new contact** to create a new contact, or tap **Update existing contact** to add the number to an existing contact.

### Adding a phone number to Contacts from the calls list

- 1 Launch the **Phone** app and tap **Recents**.
- 2 Tap a phone number and tap **Add**.
- 3 Tap **Create new contact** to create a new contact, or tap **Update existing contact** to add the number to an existing contact.

## Adding a tag to a phone number

You can add tags to numbers without saving them to Contacts. This allows you to view the caller's information when they call without having them listed in Contacts.

- 1 Launch the **Phone** app and tap **Recents**.
- 2 Tap a phone number.
- 3 Tap **Add note**, enter a tag, and then tap **Add**.

When a call comes from that number, the tag will show under the number.

## Contacts

### Introduction

Create new contacts or manage contacts on the device.

### Adding contacts

#### Creating a new contact

- 1 Launch the **Contacts** app and tap .
- 2 Select a storage location.

### 3 Enter contact information.

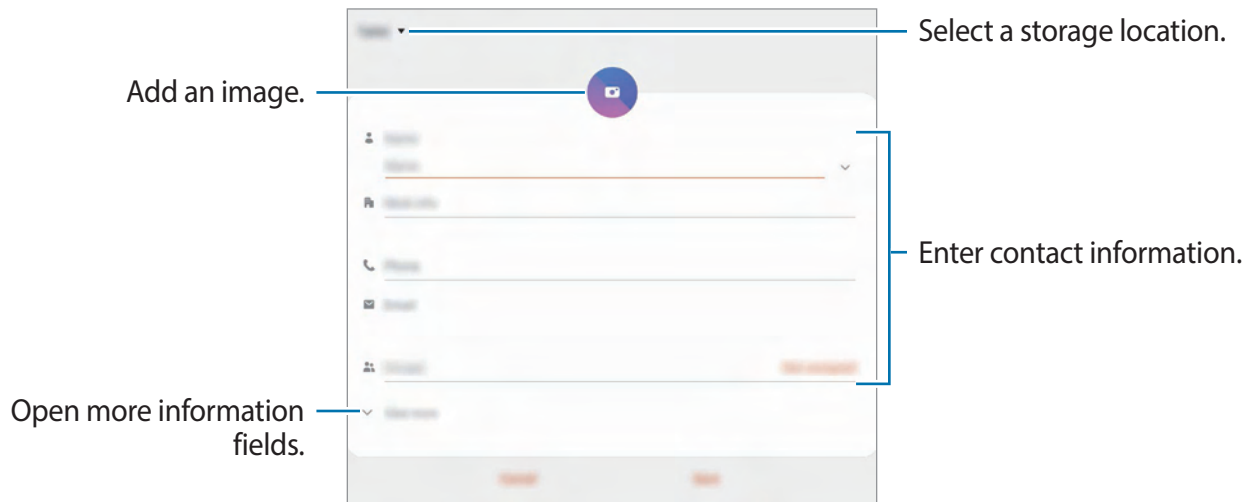

 Depending on the selected storage location, the types of information you can save may vary.

### 4 Tap **Save**.

## Importing contacts

Add contacts by importing them from other storages to your device.

- 1 Launch the **Contacts** app and tap  → **Manage contacts** → **Import or export contacts** → **Import**.
- 2 Select a storage location to import contacts from.
- 3 Tick VCF files or contacts to import and tap **Done**.
- 4 Select a storage location to save contacts to and tap **Import**.

## Syncing contacts with your web accounts

Sync your device contacts with online contacts saved in your web accounts, such as your Samsung account.

- 1 Launch the **Settings** app, tap **Accounts and backup** → **Accounts**, and then select the account to sync with.
- 2 Tap **Sync account** and tap the **Contacts** switch to activate it.  
For the Samsung account, tap  → **Sync settings** and tap the **Contacts** switch to activate it.





## Searching for contacts

Launch the **Contacts** app.

Use one of the following search methods:

- Scroll up or down the contacts list.
- Drag a finger along the index at the right side of the contacts list to scroll through it quickly.
- Tap **Q** at the top of the contacts list and enter search criteria.

Tap the contact. Then take one of the following actions:

-  : Add to favourite contacts.
-  /  : Make a voice or video call. (SM-T875, SM-T975, SM-T976B)
-  : Compose a message.
-  : Compose an email.

## Sharing contacts

You can share contacts with others by using various sharing options.

- 1 Launch the **Contacts** app, tap  at the top of the contacts list, and then tap **Share**.
- 2 Select contacts and tap **Share**.
- 3 Select a sharing method.

## Saving and sharing profile (SM-T875, SM-T975, SM-T976B)

Save and share your profile information, such as your photo and status message, with others using the profile sharing feature.



- To use this feature, you must sign in to your Samsung account.
- The profile sharing feature may not be available depending on the region or service provider.
- The profile sharing feature is only available for contacts who have activated the profile sharing feature on their device.

1 Launch the **Contacts** app and select your profile.

2 Tap **Tap here to share your profile** and tap the switch to activate it.

- To use the profile sharing feature, your phone number must be verified. You can view your contacts' updated profile information in **Contacts**.
- To change the scope of contacts to share your profile with, tap **Select what's shared**, select an item to share, and then select an option.

## Creating groups

You can add groups, such as family or friends, and manage contacts by group.

1 Launch the **Contacts** app and tap  → **Groups** → **Create group**.

2 Enter a group name.



To set a group ringtone, tap **Group ringtone** and select a ringtone.

3 Tap **Add member**, select contacts to add to the group, and then tap **Done**.

4 Tap **Save**.

## Sending a group message

You can send a group message to a group's members at the same time.

Launch the **Contacts** app, tap  → **Groups**, and then select a group. Tap  at the top of the contacts list and tap **Send message**.

## Merging duplicate contacts

When you import contacts from other storages, or sync contacts with other accounts, your contacts list may include duplicate contacts. Merge duplicate contacts into one to streamline your contacts list.

- 1 Launch the **Contacts** app and tap  → **Manage contacts** → **Merge contacts**.
- 2 Tick contacts and tap **Merge**.

## Deleting contacts

- 1 Launch the **Contacts** app, tap  at the top of the contacts list, and then tap **Delete**.
- 2 Select contacts and tap **Delete**.

To delete contacts one by one, tap a contact. Then tap  → **Delete**.

# Messages

## Introduction

Send and view messages by conversation.



- To make a call and send a text message, launch the **Settings** app, tap **Advanced features**, and then tap the **Call & text on other devices** switch to activate it. You must register and sign in to the same Samsung account on your device and the other device. Some calling and messaging features may not be available. (SM-T870, SM-T875, SM-T970, SM-T976B)
- You can select the call and text method. Select a SIM card or your connected device using the same Samsung account.



## Sending messages



You may incur additional charges for sending messages when you are roaming.

1 Launch the **Messages** app and tap **+**.

2 Add recipients and enter a message.

To record and send a voice message, tap and hold , say your message, and then release your finger. The recording icon appears only while the message input field is empty.

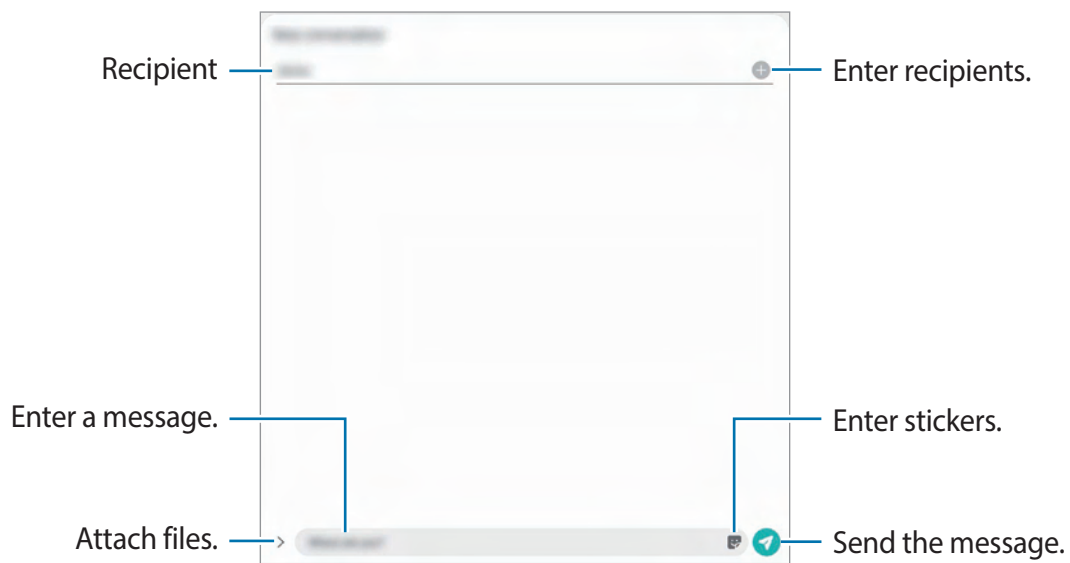

3 Tap  to send the message.

## Viewing messages

Messages are grouped into message threads by contact.



You may incur additional charges for receiving messages when you are roaming.

1 Launch the **Messages** app.

2 On the messages list, select a contact or a phone number.

- To reply to the message, tap input field, enter a message, and then tap .
- To adjust the font size, spread two fingers apart or pinch on the screen.



## Sorting messages

You can sort messages by category and manage them easily.

- 1 Launch the **Messages** app and tap **Conversations**.
- 2 Tap **New category** → **Add category**.  
If the category option does not appear, tap  → **Settings** and tap the **Conversations categories** switch to activate it.
- 3 Enter a category name and tap **Done**.
- 4 Select conversations to add to the category and tap **Done**.

## Blocking unwanted messages

Block messages from specific numbers added to your block list.

- 1 Launch the **Messages** app, tap  at the top of the messages list, and then tap **Settings** → **Block numbers and messages** → **Block numbers**.
- 2 Tap **Conversations** and select a contact or a phone number. Or, tap **Contacts**, select contacts, and then tap **Done**.  
To manually enter a number, enter a phone number under **Enter phone number** and tap .

## Setting the message notification

You can change notification sound, display options, and more.

- 1 Launch the **Messages** app, tap  at the top of the messages list, tap **Settings** → **Notifications**, and then tap the switch to activate it.
- 2 Change the notification settings.

## Setting a message reminder

You can set an alert at an interval to let you know that you have unchecked notifications. If this feature is not activated, launch the **Settings** app, tap **Accessibility** → **Advanced settings** → **Notification reminders**, and then tap the switch to activate it.

## Deleting messages

- 1 Launch the **Messages** app.
- 2 On the messages list, select a contact or a phone number.
- 3 Tap and hold a message, then tap **Delete**.  
To delete multiple messages, tick messages you want to delete.
- 4 Tap **Delete**.

# Internet

## Introduction

Browse the Internet to search for information and bookmark your favourite webpages to access them conveniently.

## Browsing webpages

- 1 Launch the **Internet** app.
- 2 Tap the address field.
- 3 Enter the web address or a keyword, and then tap **Go**.

To view the toolbars, drag your finger downwards slightly on the screen.



## Using secret mode

In secret mode, you can separately manage open tabs, bookmarks, and saved pages. You can lock secret mode using a password and your biometric data.

### Activating secret mode

► **SM-T870, SM-T875, SM-T975, SM-T976B:** Tap → Turn on Secret mode.

► **SM-T970:** Tap → Turn on Secret mode.

If you are using this feature for the first time, set whether to use a password for secret mode.

In secret mode, the device will change the colour of the toolbars.



In secret mode, you cannot use some features, such as screen capture.



### Changing security settings

You can change your password.

Tap → Settings → Privacy and security → Secret mode settings → Change password.

To use your registered biometric data as a lock method along with the password, tap an option switch under **Biometrics** to activate it.

## Deactivating secret mode

- ▶ **SM-T870, SM-T875, SM-T975, SM-T976B**: Tap  → Turn off Secret mode.
- ▶ **SM-T970**: Tap  → Turn off Secret mode.

# Camera

## Introduction

Take photos and record videos using various modes and settings.

### Camera etiquette

- Do not take photos or record videos of other people without their permission.
- Do not take photos or record videos where legally prohibited.
- Do not take photos or record videos in places where you may violate other people's privacy.

## Launching Camera

Use the following methods to launch **Camera**:

- Launch the **Camera** app.
- Press the Side key twice quickly.
- On the locked screen, drag  outside the circle.



- Some methods may not be available depending on the region or service provider.
- Some camera features are not available when you launch the **Camera** app from the locked screen or when the screen is turned off while the screen lock method is set.
- If photos you take appear blurry, clean the camera lens and try again.

## Taking photos

- 1 Tap the image on the preview screen where the camera should focus.
  - Spread two fingers apart on the screen to zoom in, and pinch to zoom out. Alternatively, drag the lens selection icon. Zooming features are available only when using the rear camera.
  - To adjust the brightness of photos, tap the screen. When the adjustment bar appears, drag the adjustment bar towards **+** or **—**.
- 2 Tap  to take a photo.



- The preview screen may vary depending on the shooting mode and which camera is being used.
- The camera automatically shuts off when unused.
- Make sure that the lens is not damaged or contaminated. Otherwise, the device may not work properly in some modes that require high resolutions.
- Your device's camera features a wide-angle lens. Minor distortion may occur in wide-angle photos or videos and does not indicate device performance problems.

### Using the camera button

Tap and hold the camera button to record a video.

To take burst shots, swipe the camera button to the edge of the screen and hold it.

## Options for current shooting mode

















On the preview screen, use the following options.



Options for current shooting mode



The available options may vary depending on the shooting mode.

-  : Activate or deactivate the flash.
-  : Select the length of the delay before the camera automatically takes a photo.
-  : Select an aspect ratio for photos.
-  : Set the device to take a video clip for a few seconds before tapping .
-  : Activate or deactivate the night hyperlapse feature.
-  : Select a frame rate.
-  : Select an aspect ratio for videos.
-  : Apply a filter effect or beauty effects.
-  : Record fun videos with virtual handwriting or drawings on faces or anywhere else. Refer to [AR Doodle](#) for more information.
-  : Select a metering method. This determines how light values are calculated.  **Centre-weighted** uses the light in the centre portion of the shot to calculate the exposure of the shot.  **Spot** uses the light in a concentrated centre area of the shot to calculate the exposure of the shot.  **Matrix** averages the entire scene.
-  : In **FOOD** mode, focus on a subject inside the circular frame and blur the image outside the frame.
-  : In **FOOD** mode, adjust the colour tone.

## Changing shooting modes

To change the shooting mode, drag the shooting modes list to the left or right, or swipe to the left or right on the preview screen.

Select a shooting mode you want.





## Selecting a camera for shooting

On the preview screen, select the camera you want and take a photo or record a video.



This feature is only available in some shooting modes.

-  (Wide-angle): The wide-angle camera lets you take basic photos or record normal videos.
-  (Ultra wide): The Ultra wide camera lets you take wide-angle photos or record wide-angle videos which look just like the actual view. Use this feature to take landscape photos.

To correct the distortion in photos taken with the Ultra wide camera, tap  on the preview screen, tap **Save options**, and then tap the **Ultra wide lens correction** switch to activate it.



 Wide-angle



 Ultra wide



## Photo mode (Intelligent camera)

The camera adjusts the shooting options automatically depending on the surroundings to capture photos easily. The intelligent camera feature automatically recognises the subject and optimises the colour and any effects.



On the shooting modes list, tap **PHOTO** and tap  to take a photo.

### Scene optimiser

The camera adjusts the colour settings and applies the optimised effect automatically by recognising the subject.

On the shooting modes list, tap **PHOTO**. When the camera recognises the subject, the scene optimiser button will change and the optimised colour and effect will be applied.



- If this feature is not activated, tap  on the preview screen and tap the **Scene optimiser** switch to activate it.
- To use additional features, tap  on the preview screen, tap **Scene optimiser**, and then tap the switches next to the features you want.
- If you do not want to use this feature, tap the **Scene optimiser** button on the preview screen.

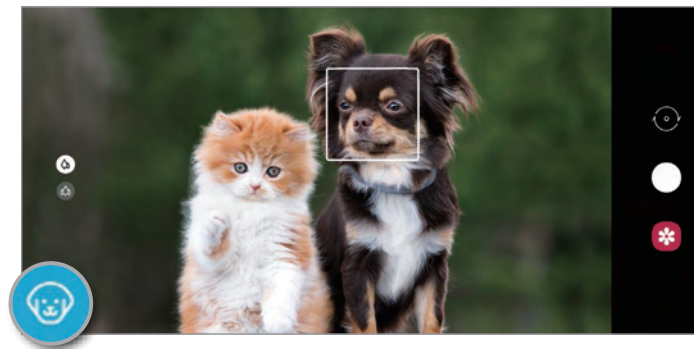

## Shot suggestions

The camera suggests the ideal composition for the photo by recognising the position and angle of your subject.

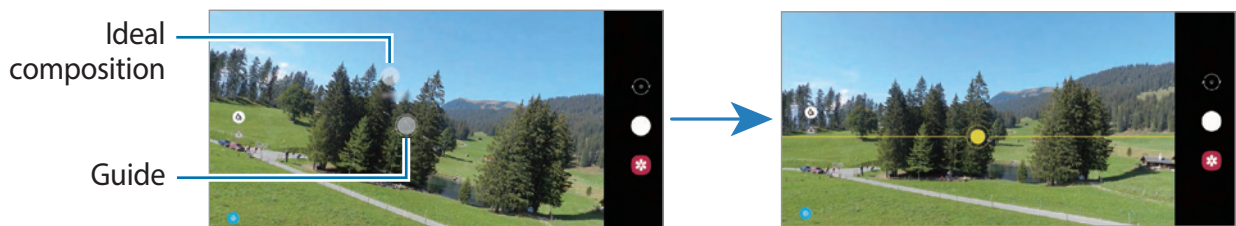

On the preview screen, tap  and tap the **Shot suggestions** switch to activate it.

- 1 On the shooting modes list, tap **PHOTO**.  
A guide will appear on the preview screen.
- 2 Point the subject with the guide on the preview screen.  
The camera recognises the composition, and the recommended composition appears on the preview screen.
- 3 Adjust the position and angle of the camera to fit the composition.  
When the ideal composition is achieved, the guide will change to yellow.
- 4 Tap  to take a photo.



## Taking selfies

You can take self-portraits with the front camera.

- 1 On the shooting modes list, tap **PHOTO**.
- 2 On the preview screen, swipe upwards or downwards, or tap  to switch to the front camera for self-portraits.
- 3 Face the front camera lens.  
To take self-portraits with a wide-angle shot of the landscape or people, tap .
- 4 Tap  to take a photo.



## Applying filter and beauty effects

You can select a filter effect and modify facial features, such as your skin tone or face shape, before taking a photo.

- 1 On the preview screen, tap .
- 2 Select a filter effect or beauty effects and take a photo.

## Creating filters

Select an image with a colour tone you like from **Gallery**, and save the colour tone as a new filter. When you then take a photo with the filter, you can get a similar look.

- 1 On the preview screen, tap  → **My filters**.  
When you create a filter for the first time, select a sample image with a colour tone you want to use and tap **Next** → **Save filter**.
- 2 Tap  and select an image with a colour tone you want to use.  
To change the filter name, tap the name.
- 3 Tap **Save filter**.





## Locking the focus (AF) and exposure (AE)

You can lock the focus or exposure on a selected area to prevent the camera from automatically adjusting based on changes to the subjects or light sources.

Tap and hold the area to focus, the AF/AE frame will appear on the area and the focus and exposure setting will be locked. The setting remains locked even after you take a photo.

## Video mode

The camera adjusts the shooting options automatically depending on the surroundings to record videos easily.

- 1 On the shooting modes list, tap **VIDEO**.
- 2 Tap  to record a video.
  - To switch between the front and rear cameras while recording, swipe upwards or downwards on the preview screen or tap .
  - To capture an image from the video while recording, tap .
  - To change the focus while recording a video, tap where you want to focus. To use auto focus mode, tap **AF** to cancel the manually set focus.
- 3 Tap  to stop recording the video.

## Single take mode

Take photos or videos in single take mode when you want to get a variety of results with just one shot. Your device automatically captures the best shot and videos and creates photos with optimised filters or videos with certain sections repeated.

- 1 On the shooting modes list, tap **SINGLE TAKE**.
- 2 Tap  and move the camera to capture the scene you want.

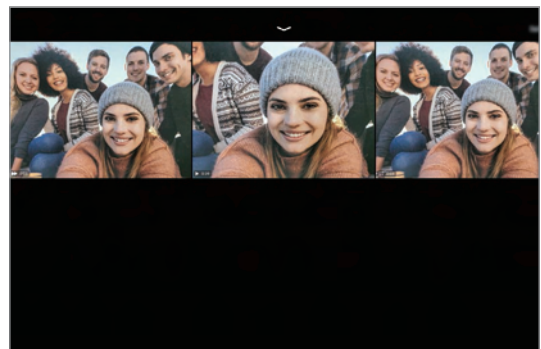

- 3 When you are finished, tap the preview thumbnail.  
A variety of optimised results for the scene will appear.  
To save the results individually, tap **Select**, tick the items you want, and then tap .

## Live focus mode / Live focus video mode

The camera allows you to capture photos or videos where the background is blurred and the subject stands out clearly. You can also apply a background effect and edit it after taking a photo.



The available options may vary depending on the shooting mode.



Background blur



Big circle



Spin



Zoom





Colour point



- Use this feature in a place that has sufficient light.
- The background blur may not be applied properly in the following conditions:
  - The device or the subject is moving.
  - The subject is thin or transparent.
  - The subject has a similar colour to the background.
  - The subject or background is plain.



## Taking portraits that stand out using the Live focus feature

- 1 On the shooting modes list, tap **LIVE FOCUS** or **MORE** → **LIVE FOCUS VIDEO**.
- 2 Tap  and select a background effect you want.  
To adjust the intensity of the background effect, drag the adjustment bar.
- 3 When **Ready** appears on the preview screen, tap  to take a photo or tap  to record a video.



## Editing the background of the Live focus photos

You can also edit the background effect and the intensity of the background effect for a photo taken with the Live focus feature.

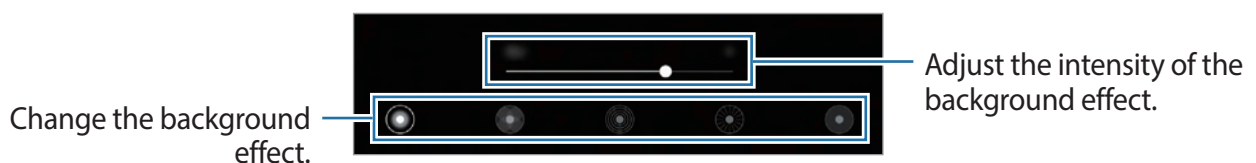

- 1 Select a photo taken with the Live focus feature and tap **Change background effect**.
- 2 Select a background effect you want.
  - To adjust the intensity of the background effect, drag the adjustment bar to the left or right.
  - When the background lighting appears in blurred points, the  (**Artistic**) icon will appear on the effects list. To change the shape of the background blur, tap  and select the shape you want.





- 3 Tap **Apply** to save the photo.

## Pro mode / Pro video mode

Capture photos or videos while manually adjusting various shooting options, such as exposure value and ISO value.

On the shooting modes list, tap **MORE** → **PRO** or **PRO VIDEO**. Select options and customise the settings, and then tap  to take a photo or tap  to record a video.

### Available options

-  : Select an ISO value. This controls camera light sensitivity. Low values are for stationary or brightly lit objects. Higher values are for fast-moving or poorly lit objects. However, higher ISO settings can result in noise in photos or videos.
-  : Select an appropriate white balance, so images have a true-to-life colour range. You can set the colour temperature.
-  : Change the exposure value. This determines how much light the camera's sensor receives. For low-light situations, use a higher exposure.

### Separating the focus area and the exposure area

You can separate the focus area and the exposure area.

Tap and hold the preview screen. The AF/AE frame will appear on the screen. Drag the frame to the area where you want to separate the focus area and the exposure area.

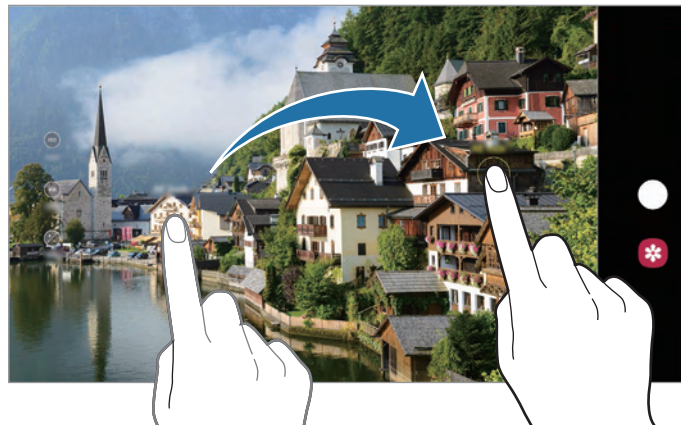



## Panorama mode

Using panorama mode, take a series of photos and then stitch them together to create a wide scene.





To get the best shots using panorama mode, follow these tips:

- Move the camera slowly in one direction.
- Keep the image within the frame on the camera's viewfinder. If the preview image is out of the guide frame or you do not move the device, the device will automatically stop taking photos.
- Avoid taking photos of indistinct backgrounds, such as an empty sky or a plain wall.

- 1 On the shooting modes list, tap **MORE** → **PANORAMA**.
- 2 Tap  and move the device slowly in one direction.
- 3 Tap  to stop taking photos.

## Hyperlapse mode

Record scenes, such as passing people or cars, and view them as fast-motion videos.

- 1 On the shooting modes list, tap **MORE** → **HYPERLAPSE**.
- 2 Tap  and select a frame rate option.  
If you set the frame rate to **Auto**, the device will automatically adjust the frame rate according to the changing rate of the scene.
- 3 Tap  to start recording.
- 4 Tap  to finish recording.
- 5 On the preview screen, tap the preview thumbnail and tap **Play hyperlapse** to view the video.





## Night mode

Take a photo in low-light conditions, without using the flash. When you use a tripod, you can get brighter and steadier results.

- 1 On the shooting modes list, tap **MORE** → **NIGHT**.
- 2 Tap  and hold your device steady until shooting is complete.

## Food mode

Take photos of food with more vibrant colours.

- 1 On the shooting modes list, tap **MORE** → **FOOD**.
- 2 Tap the screen and drag the circular frame over the area to highlight.  
The area outside the circular frame will be blurred.  
To resize the circular frame, drag a corner of the frame.
- 3 Tap  and drag the adjustment bar to adjust the colour tone.
- 4 Tap  to take a photo.

## Customising camera settings

On the preview screen, tap . Some options may not be available depending on the shooting mode.

### Intelligent features

- **Scene optimiser:** Set the device to adjust the colour settings and apply the optimised effect automatically depending on the subject or scene.
- **Shot suggestions:** Set the device to suggest the ideal composition for the photo by recognising the position and angle of your subject.
- **Smart selfie angle:** Set the device to automatically switch to a wide-angle selfie when there are more than two people in the frame.
- **Scan QR codes:** Enable or disable the QR code reader.

## Pictures

- **Swipe Shutter button to edge to:** Select an action to perform when you swipe the camera button to the edge of the screen and hold it.
- **Save options:** Select how you want to save photos.

## Videos

- **Rear video size:** Select a resolution for videos you want to take with the rear camera. Using a higher resolution will result in higher quality videos, but they will take up more memory.
- **Front video size:** Select a resolution for videos you want to take with the front camera. Using a higher resolution will result in higher quality videos, but they will take up more memory.
- **High efficiency video:** Record videos in the High Efficiency Video Codec (HEVC) format. Your HEVC videos will be saved as compressed files to conserve the device's memory.
- **Video stabilisation:** Activate anti-shake to reduce or eliminate blurry image resulting from camera shake while recording a video.

## Useful features

- **Auto HDR:** Take photos with rich colours and reproduce details even in bright and dark areas.
- **Selfie tone:** Set a tone to apply when you take selfies.
- **Pictures as previewed:** Set the device to save photos as they appear on the preview screen when taken with the front camera without flipping them.
- **Grid lines:** Display viewfinder guides to help composition when selecting subjects.
- **Location tags:** Attach a GPS location tag to the photo.
  -  GPS signal strength may decrease in locations where the signal is obstructed, such as between buildings or in low-lying areas, or in poor weather conditions.
  - Your location may appear on your photos when you upload them to the Internet. To avoid this, deactivate the location tag setting.
- **Shooting methods:** Select additional shooting methods for taking a photo or recording a video.
- **Storage location:** Select the memory location for storage. This feature will appear when you insert a memory card.

- **Watermark:** Add a watermark in the bottom left corner when taking pictures.
- **Reset settings:** Reset the camera settings.
- **Contact us:** Ask questions or view frequently asked questions.
- **About Camera:** View the Camera app version and legal information.

## Gallery

### Introduction

View images and videos stored in your device. You can also manage images and videos by album or create stories.

### Using Gallery

Launch the **Gallery** app.

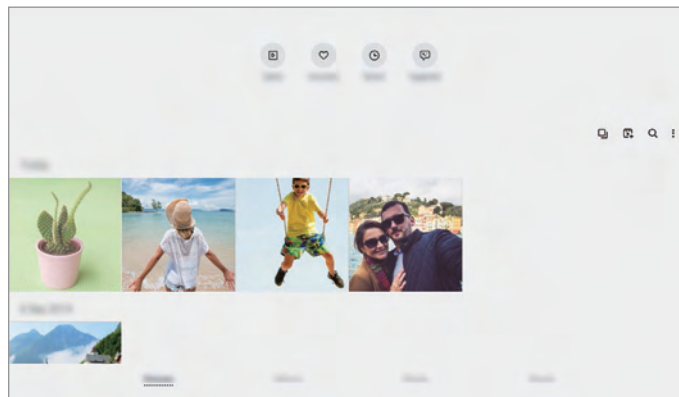

- **Videos:** View the videos saved in your device.
- **Favourites:** View your favourite photos and videos.
- **Recent:** View recent photos and videos.
- **Suggested:** View recommended content.

### Grouping similar images

Launch the **Gallery** app and tap  to group similar images and display only the best shots as a preview of the images. When you tap the image preview, you can view all the images in the group.

## Creating movies

Create a movie by selecting images or videos. Launch the **Gallery** app, tap , tick the files you want to use, and then tap **Create movie**. When you select **Highlight reel**, the device will automatically combine the highlights from the images or videos and create a movie.

## Searching for images

Launch the **Gallery** app and tap  to view images sorted by category, such as types or locations.

To search for images by entering keywords, tap the search field.

## Viewing images

1 Launch the **Gallery** app and tap **Pictures**.

2 Select an image.



## Cropping images by enlarging an area

1 Launch the **Gallery** app and tap **Pictures**.

2 Select an image.