

- Test plots\_MIMO

26T\_0 RU

Ant.1

Ant.2

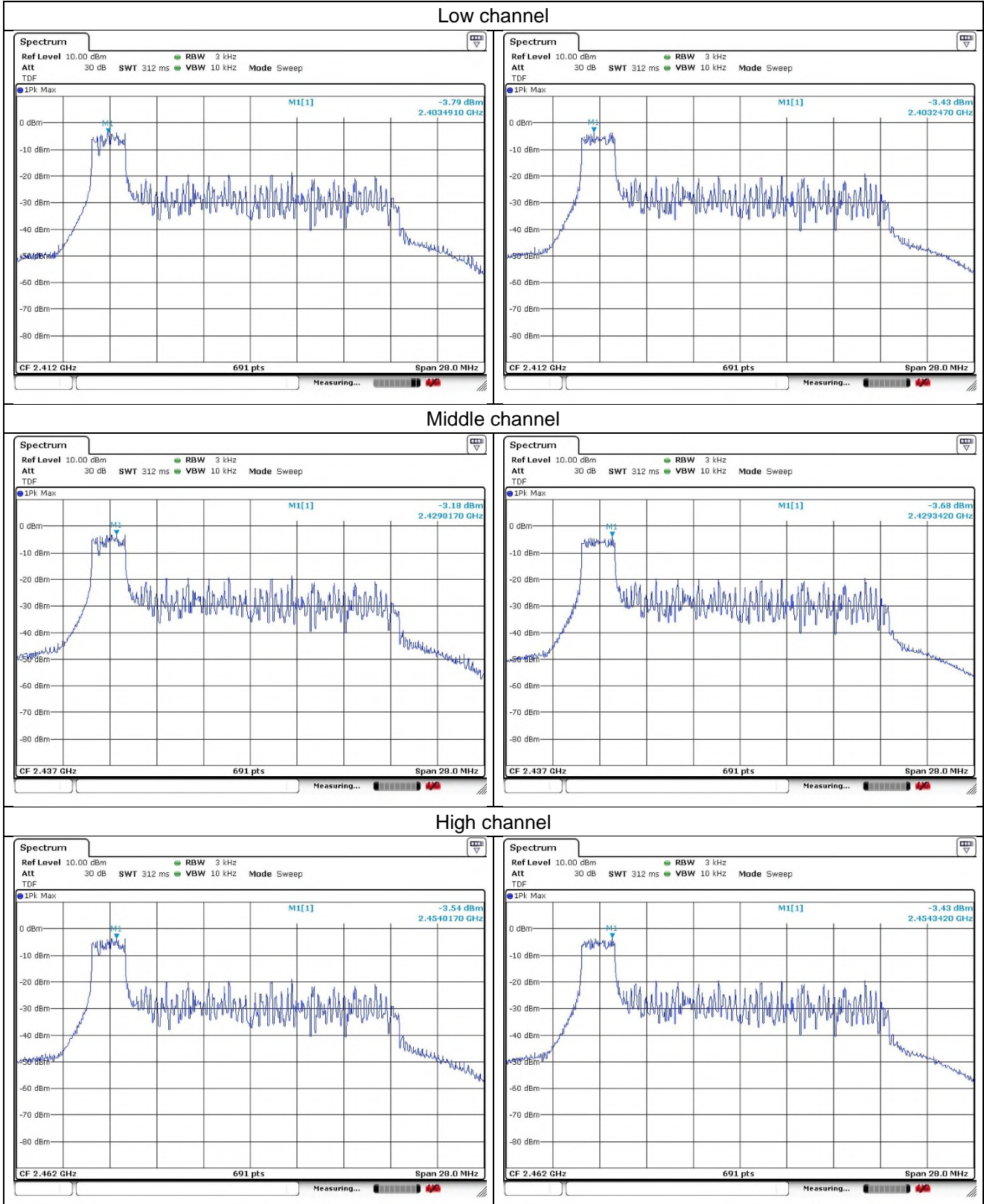

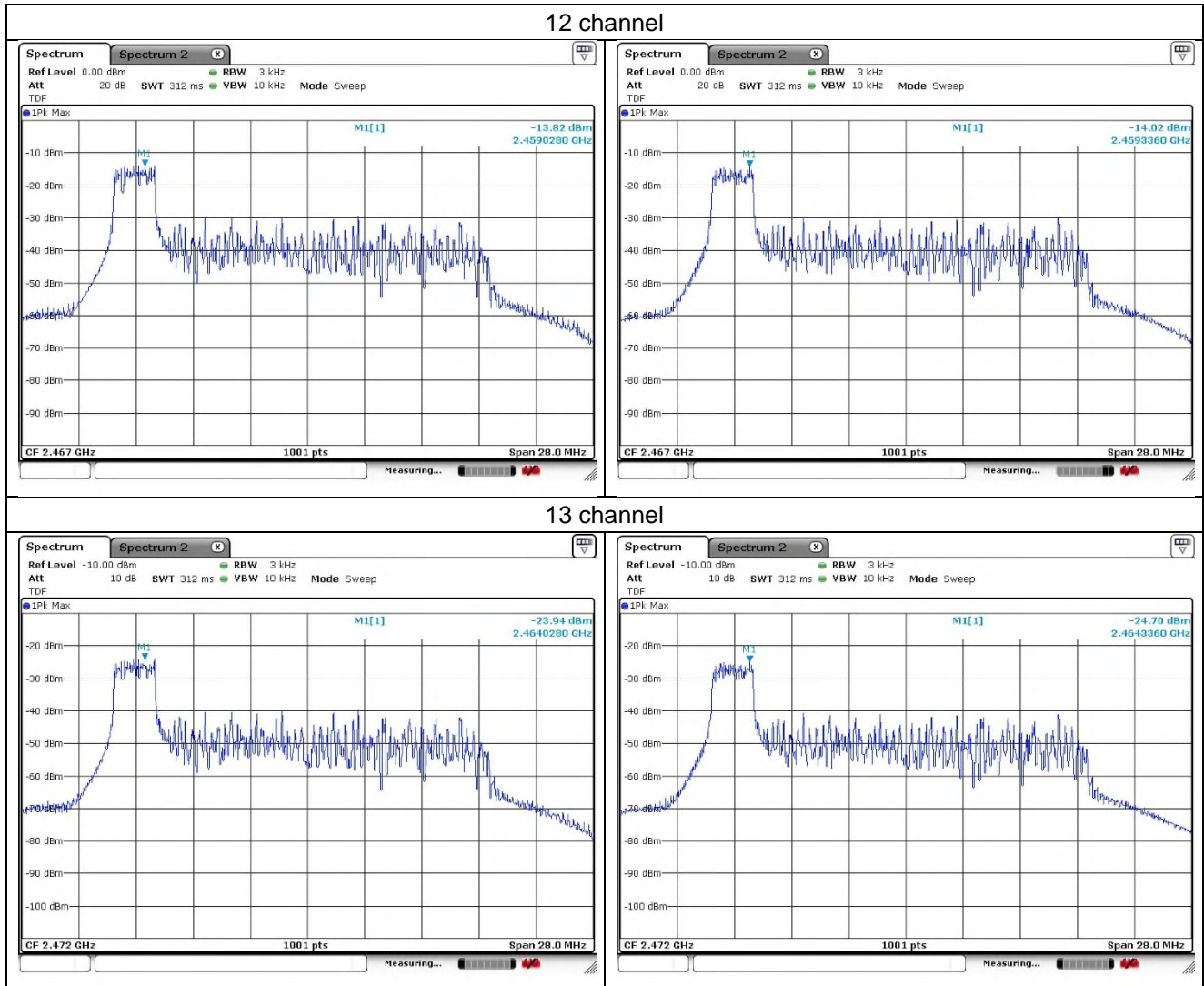

26T\_4 RU

Ant.1

Ant.2

Low channel

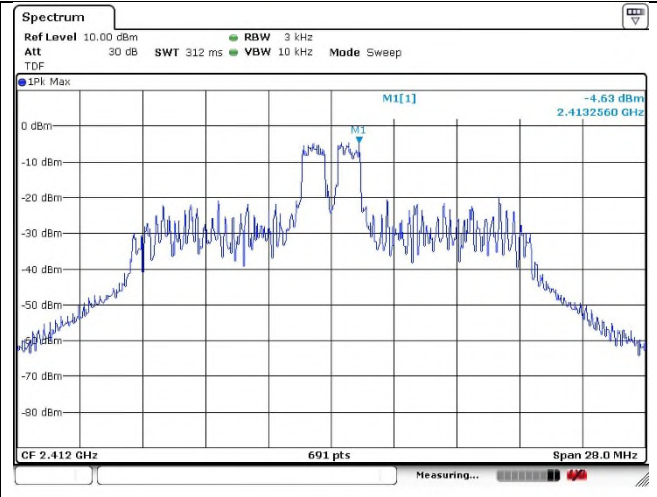
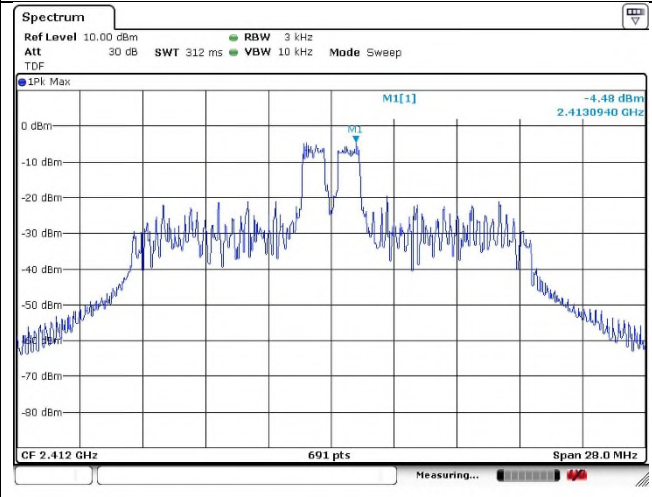

Middle channel

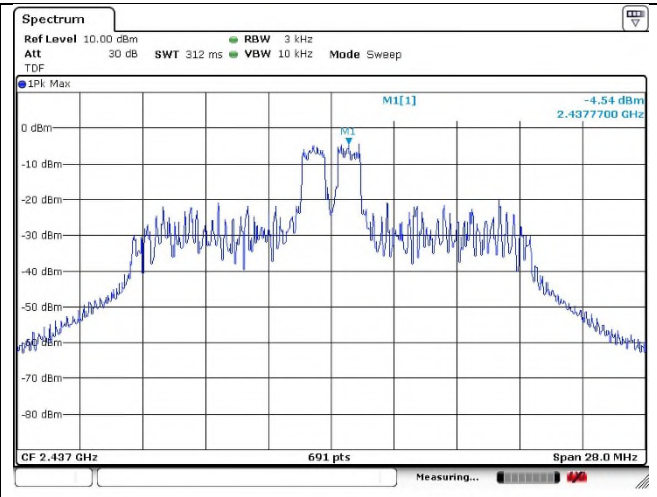
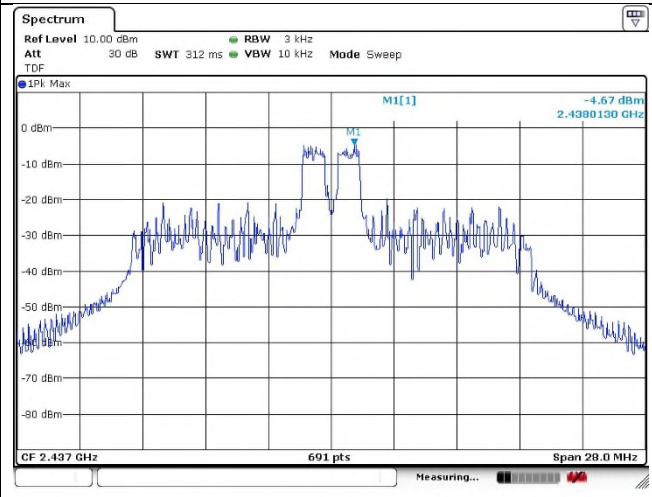

High channel

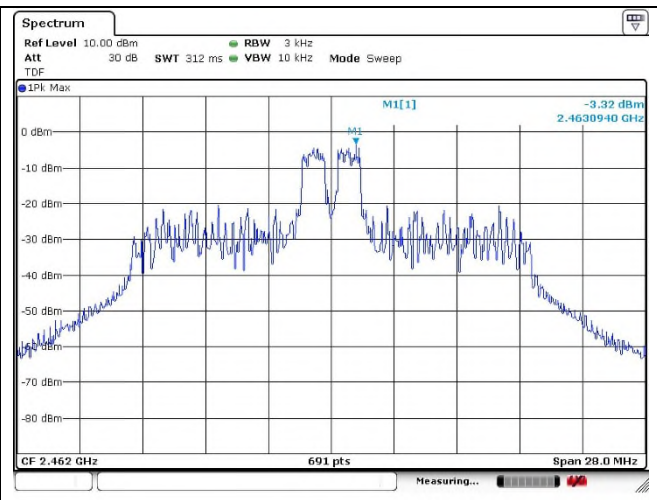
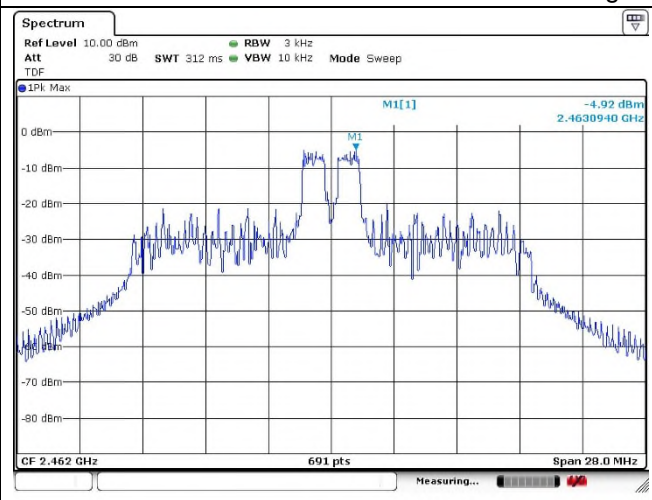

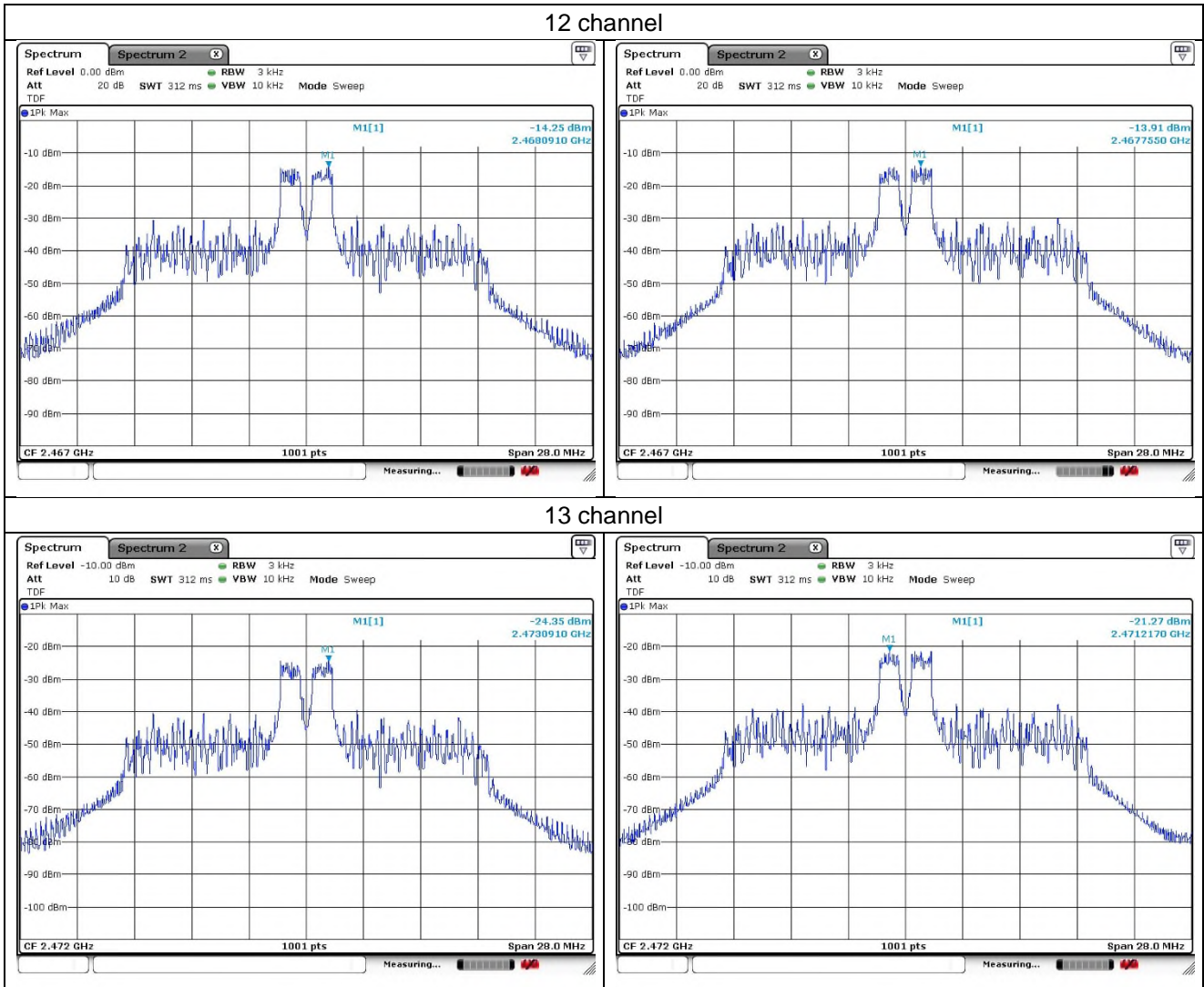

26T\_8 RU

Ant.1

Ant.2

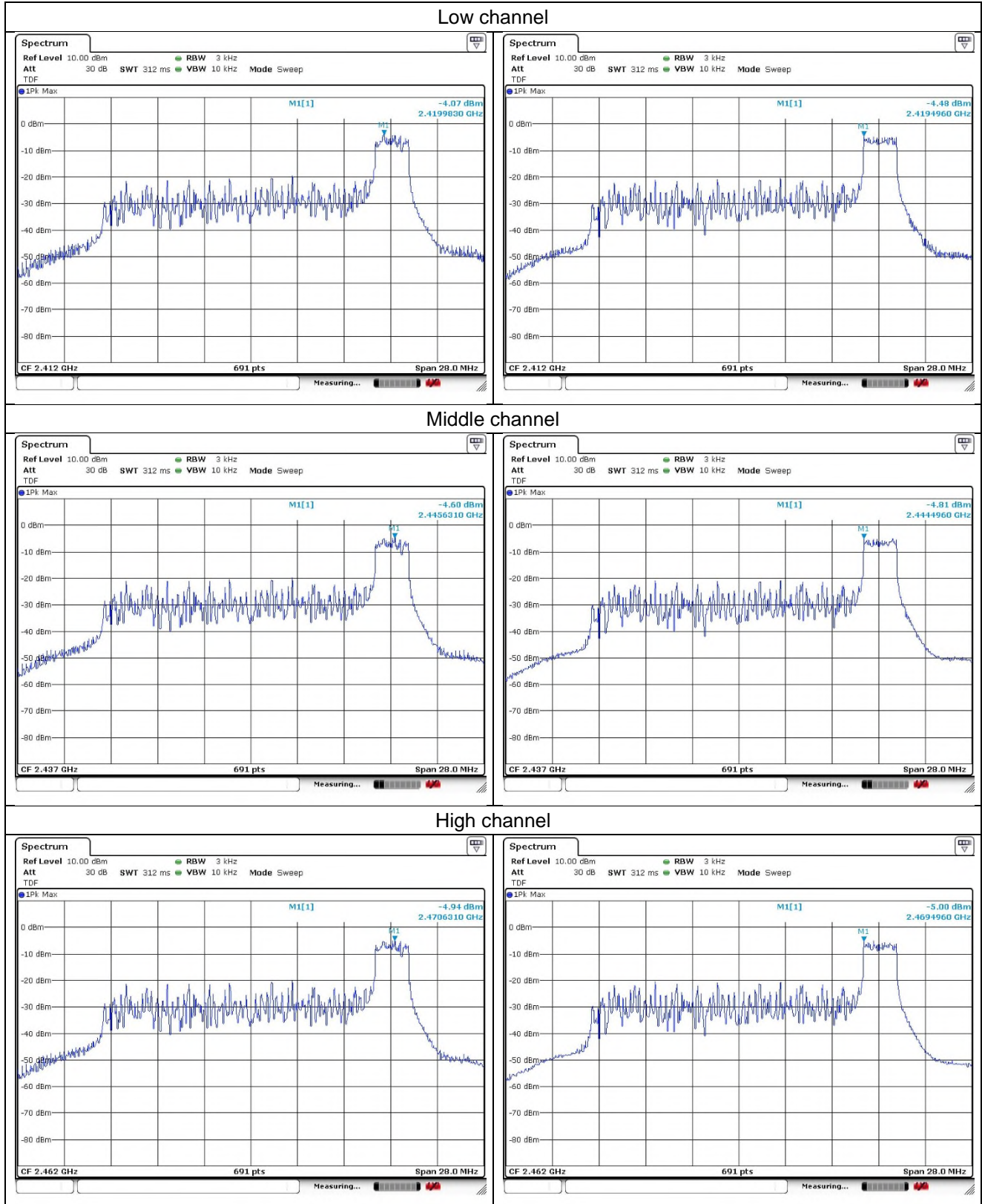

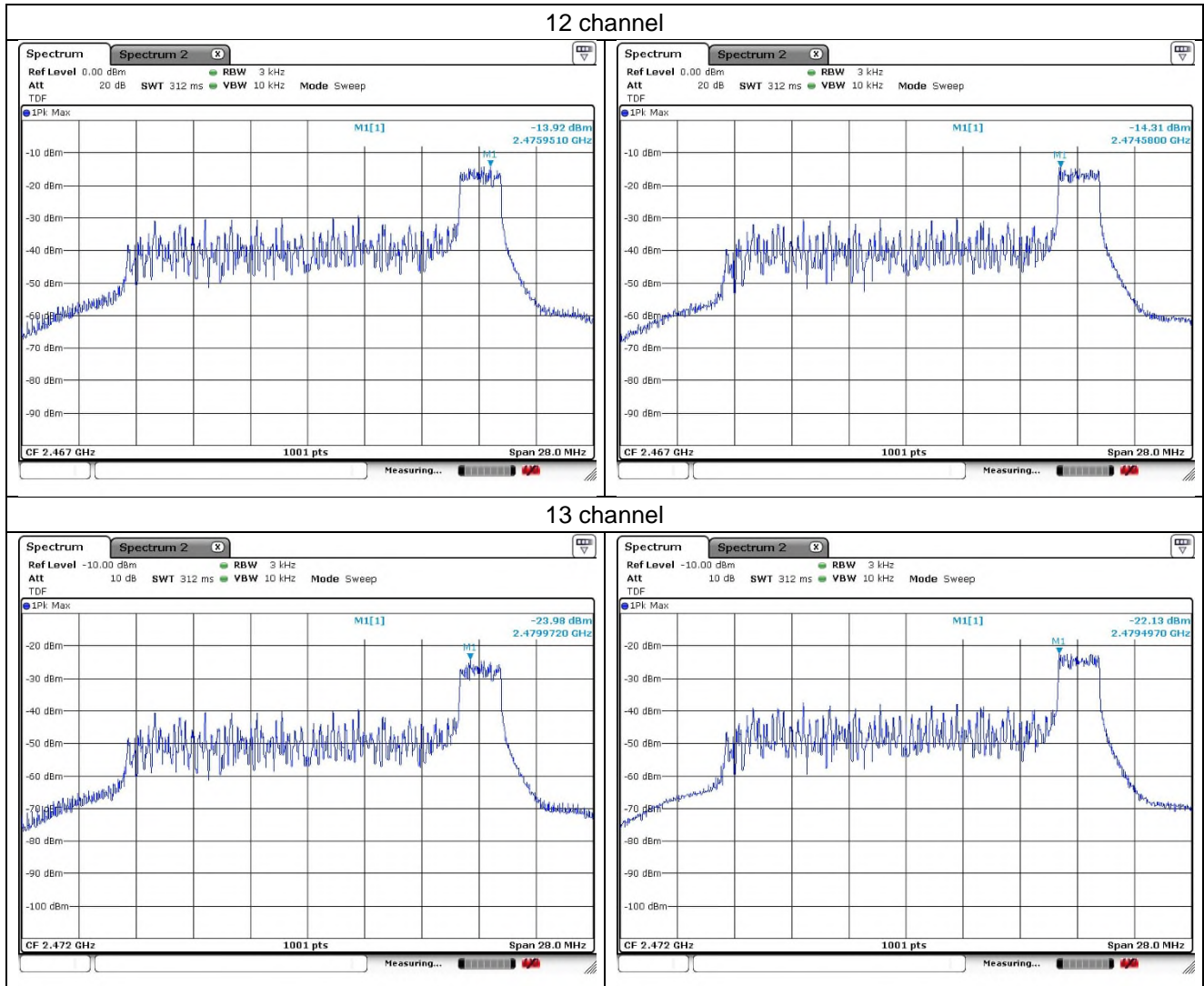

52T\_37 RU

Ant.1

Ant.2

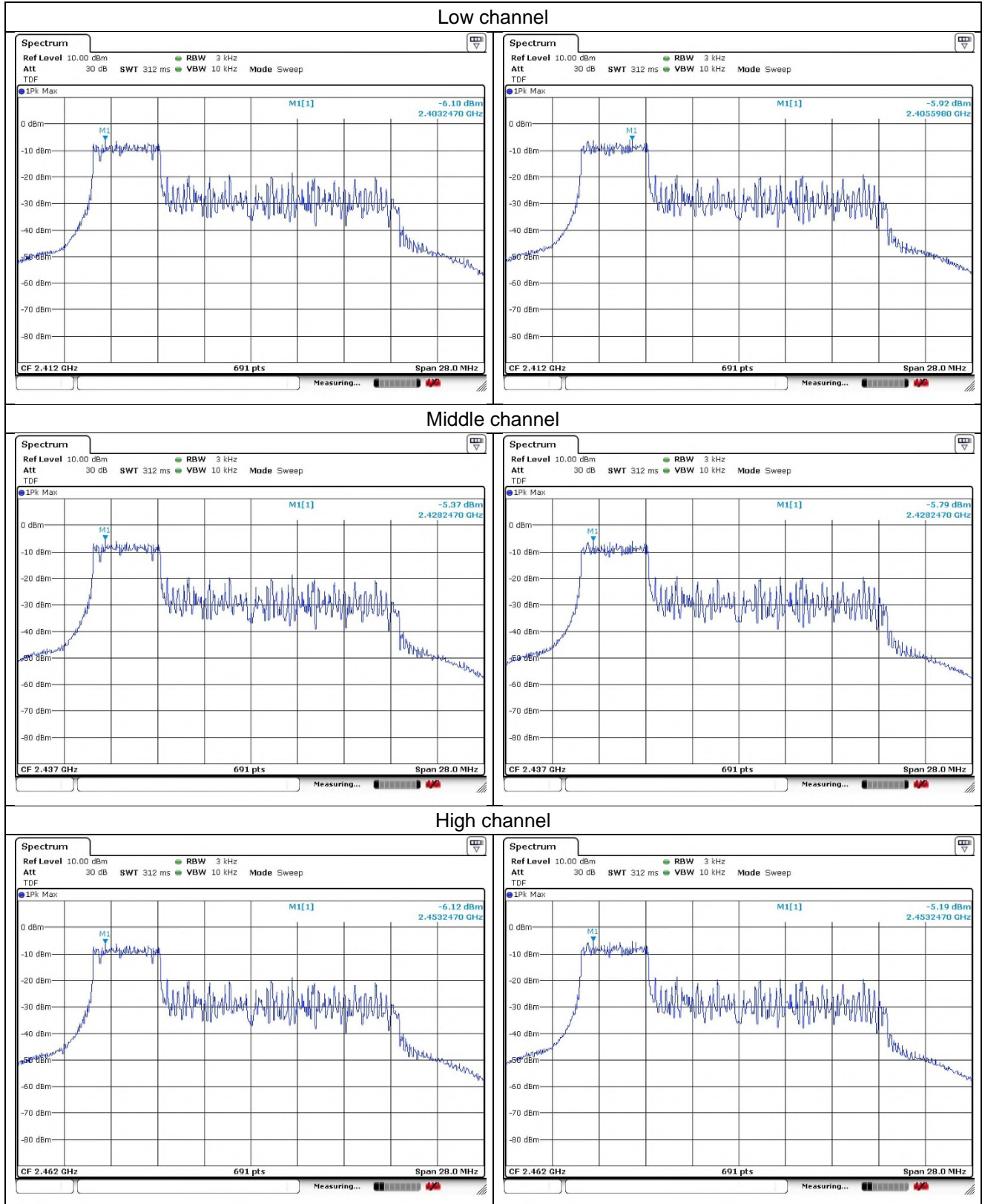



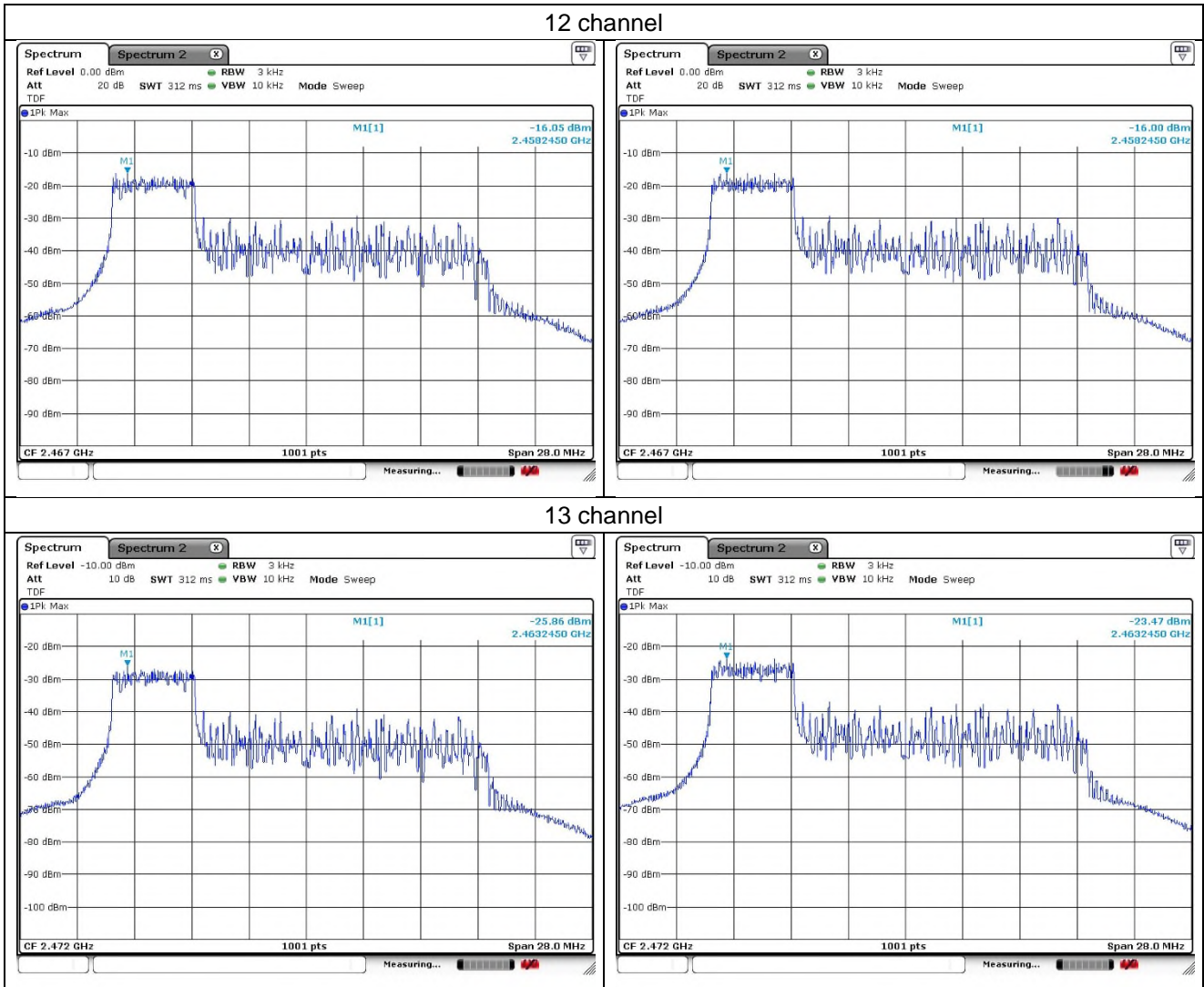

52T\_38 RU

Ant.1

Ant.2

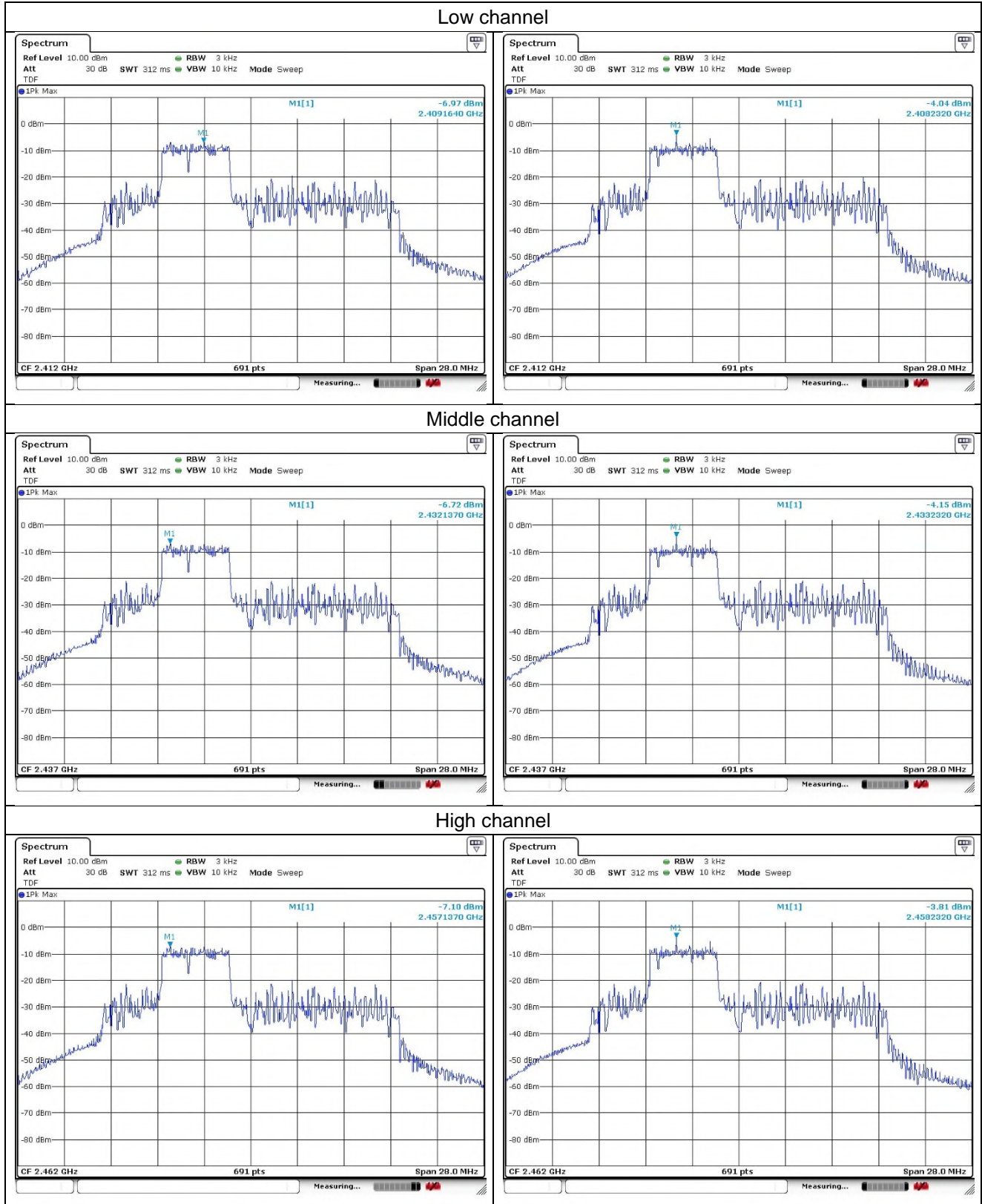

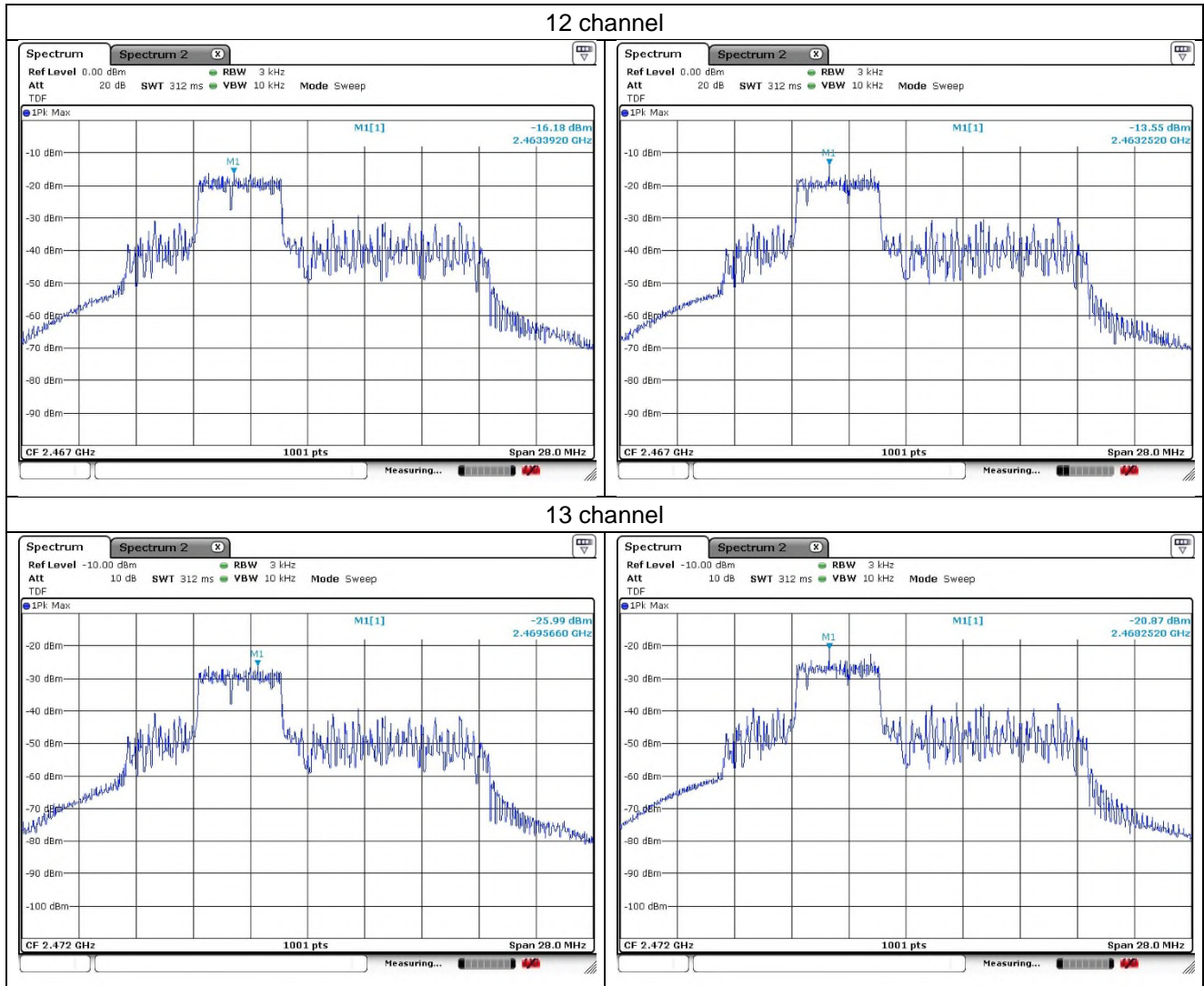

52T\_40 RU

Ant.1

Ant.2

Low channel

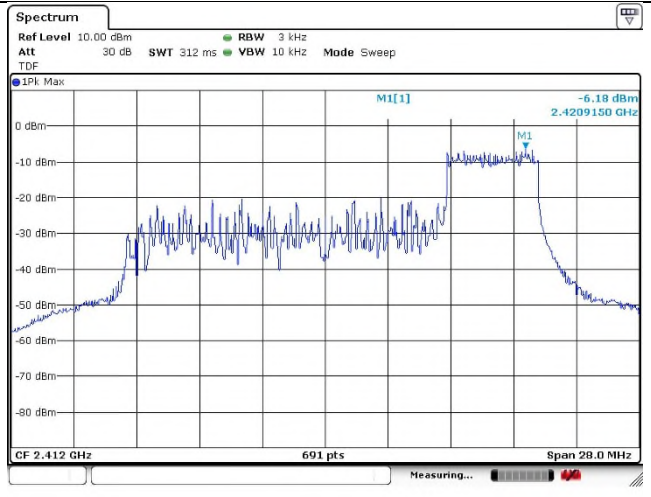
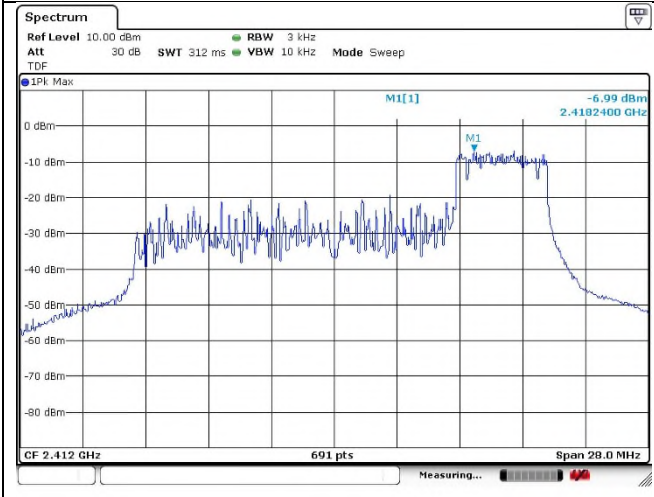

Middle channel

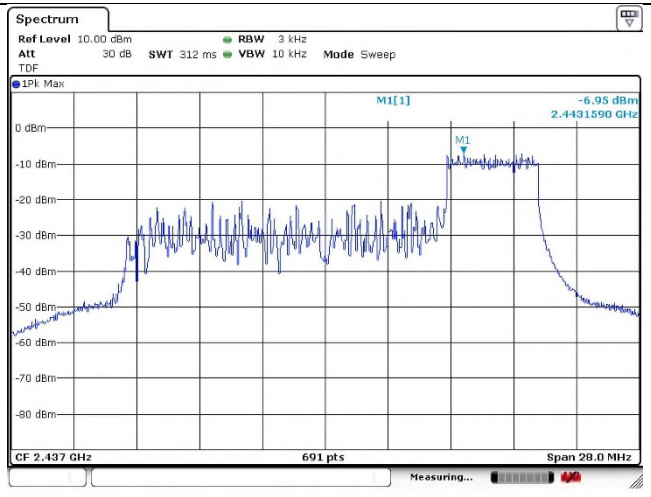
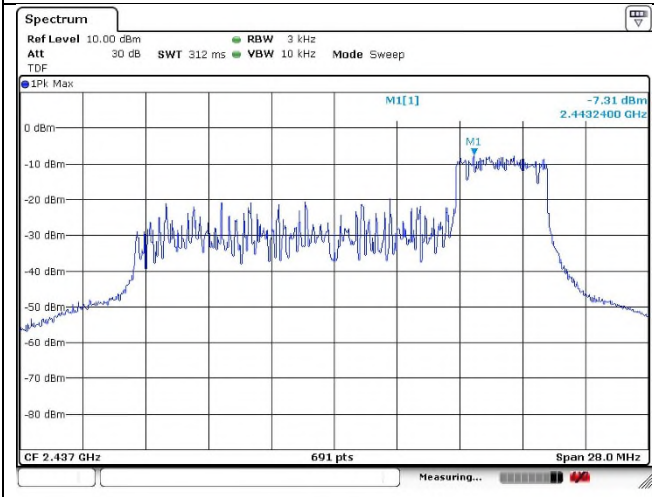

High channel

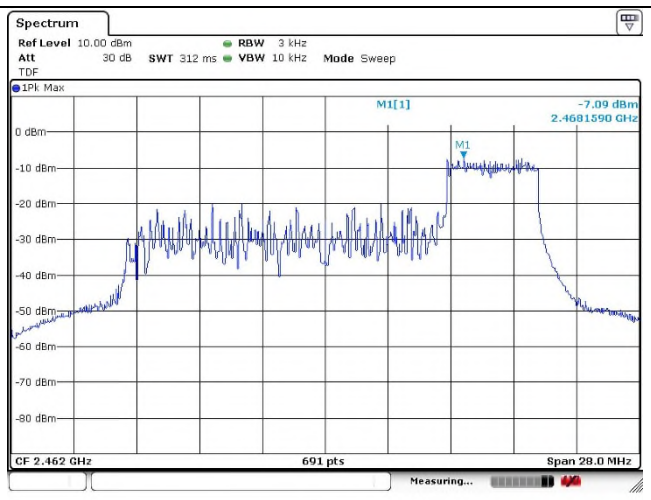
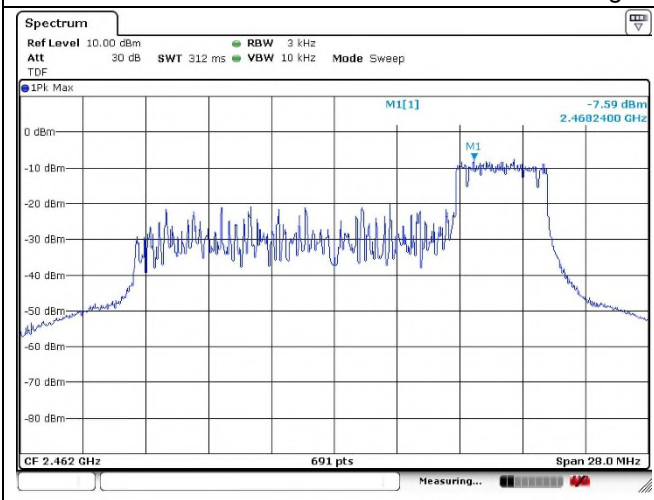

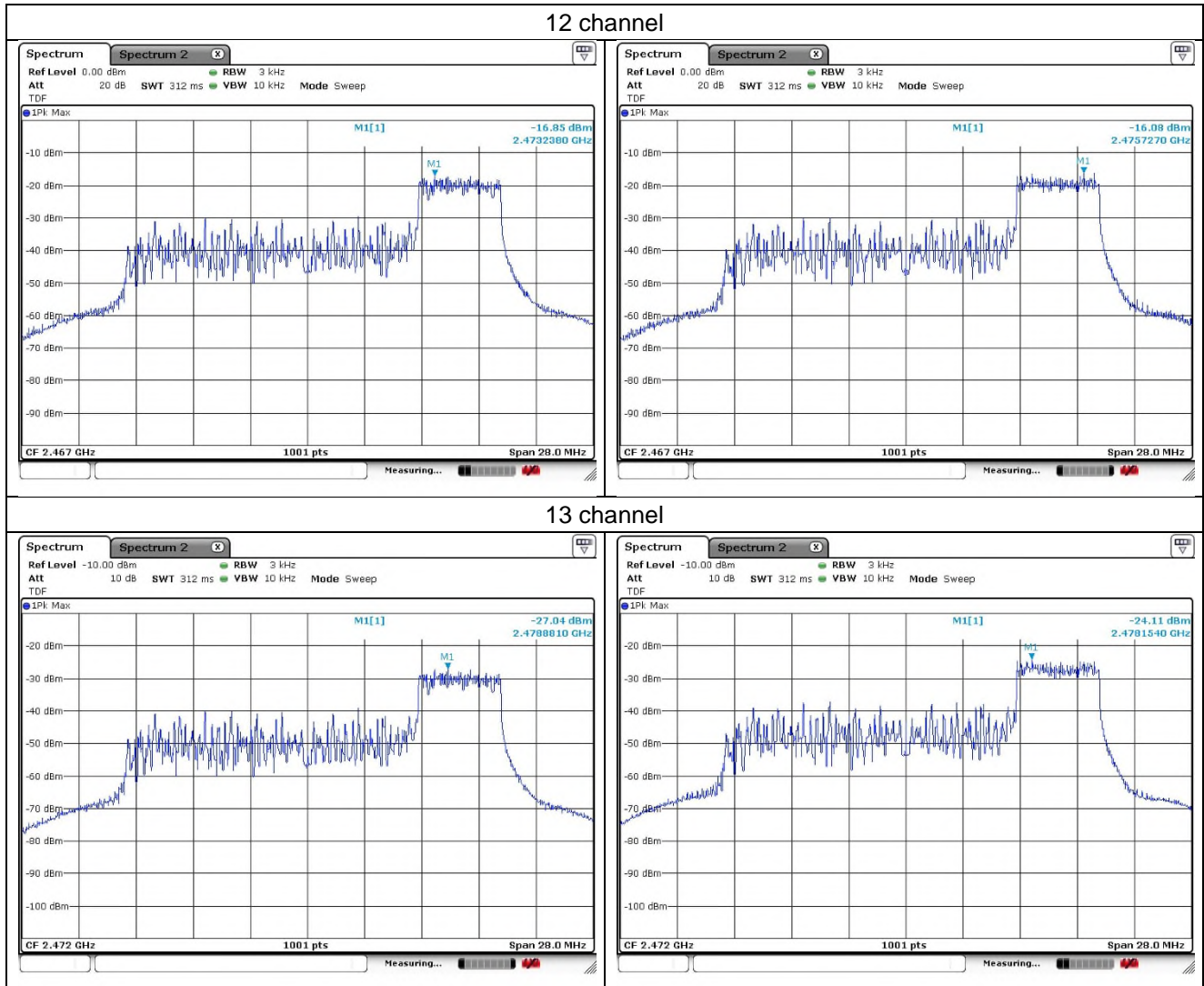

106T\_53 RU

Ant.1

Ant.2

Low channel

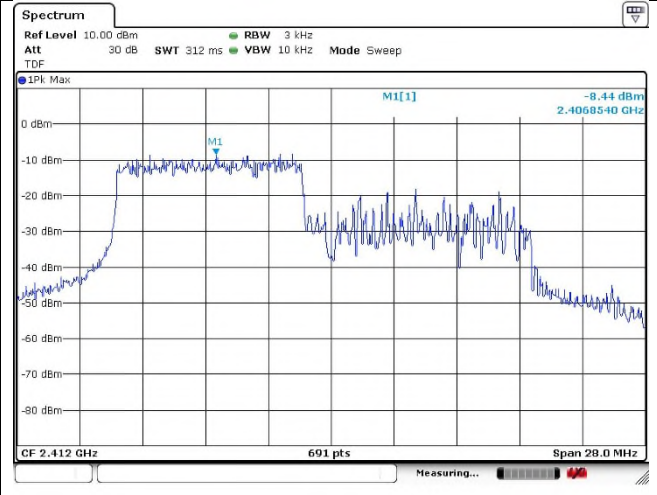
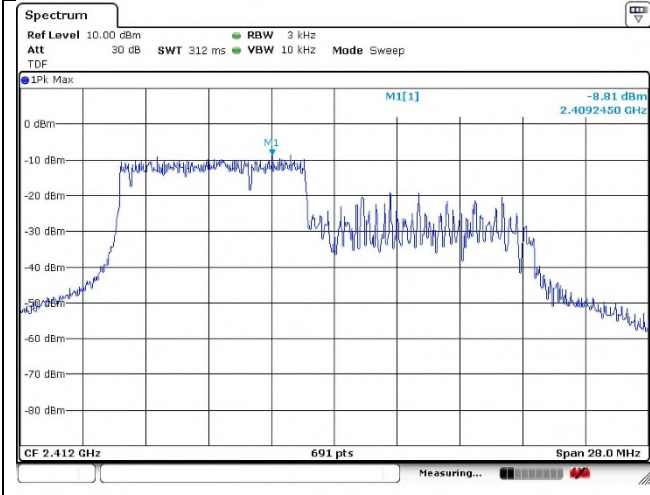

Middle channel

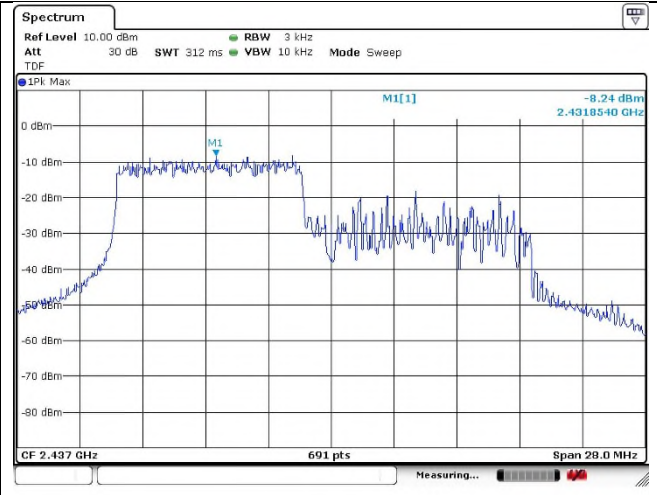
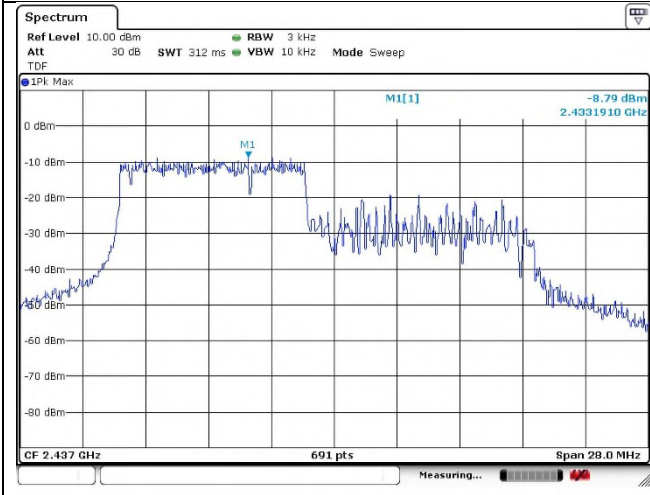

High channel

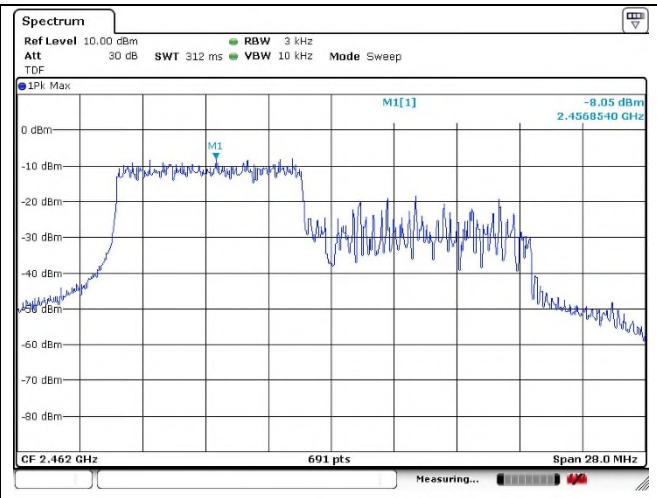
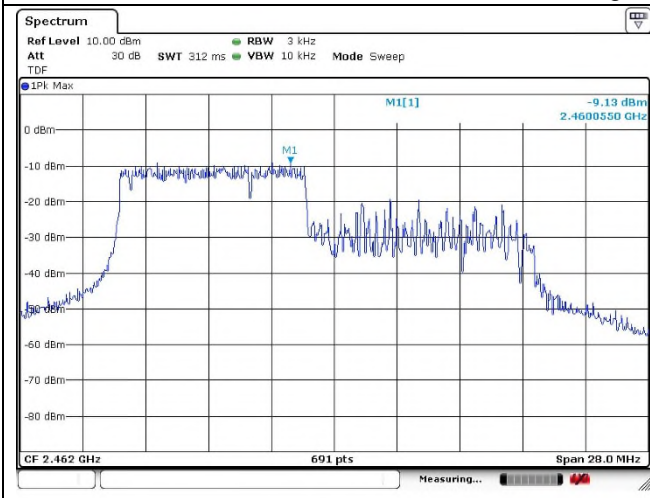

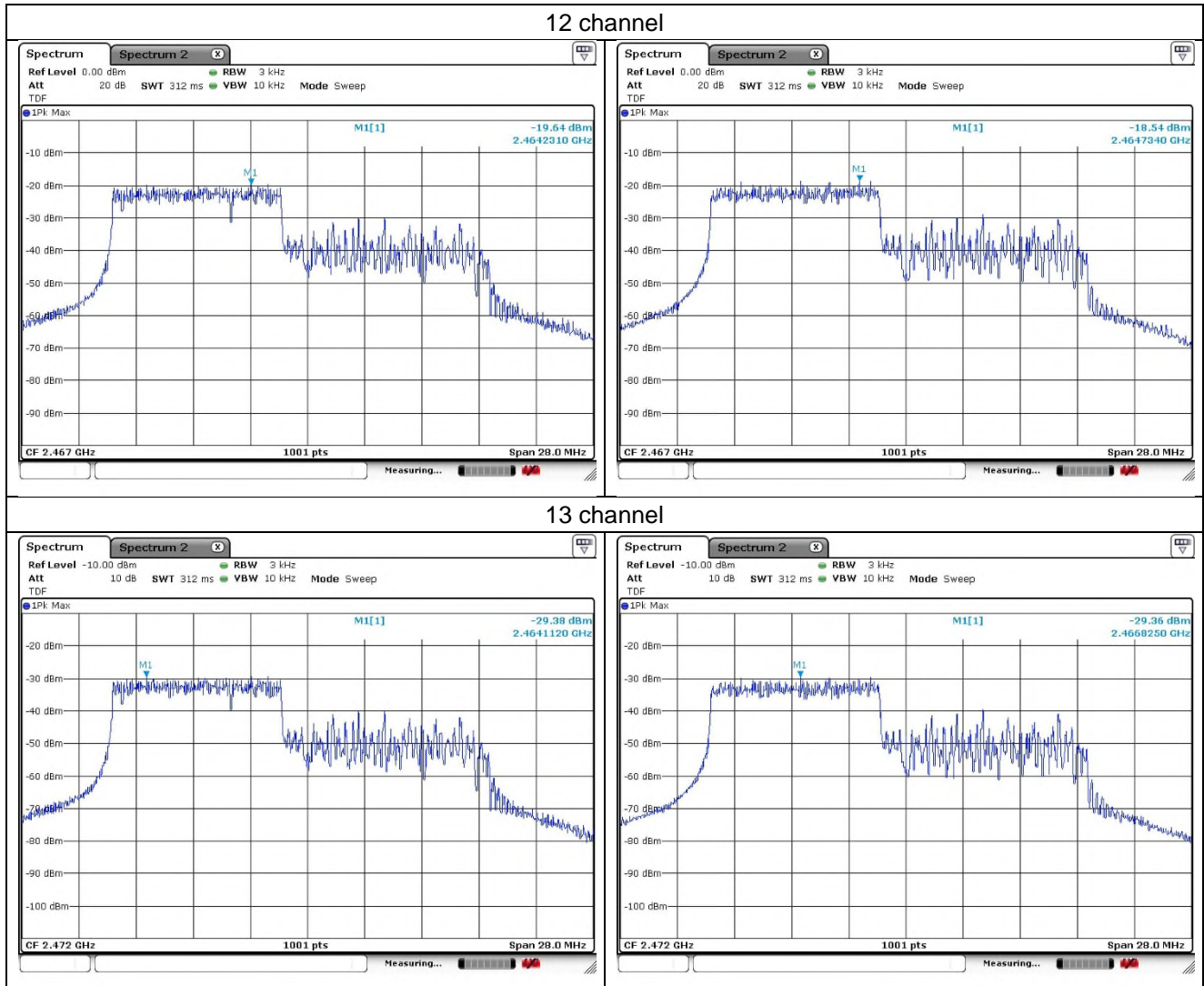

106T\_54 RU

Ant.1

Ant.2

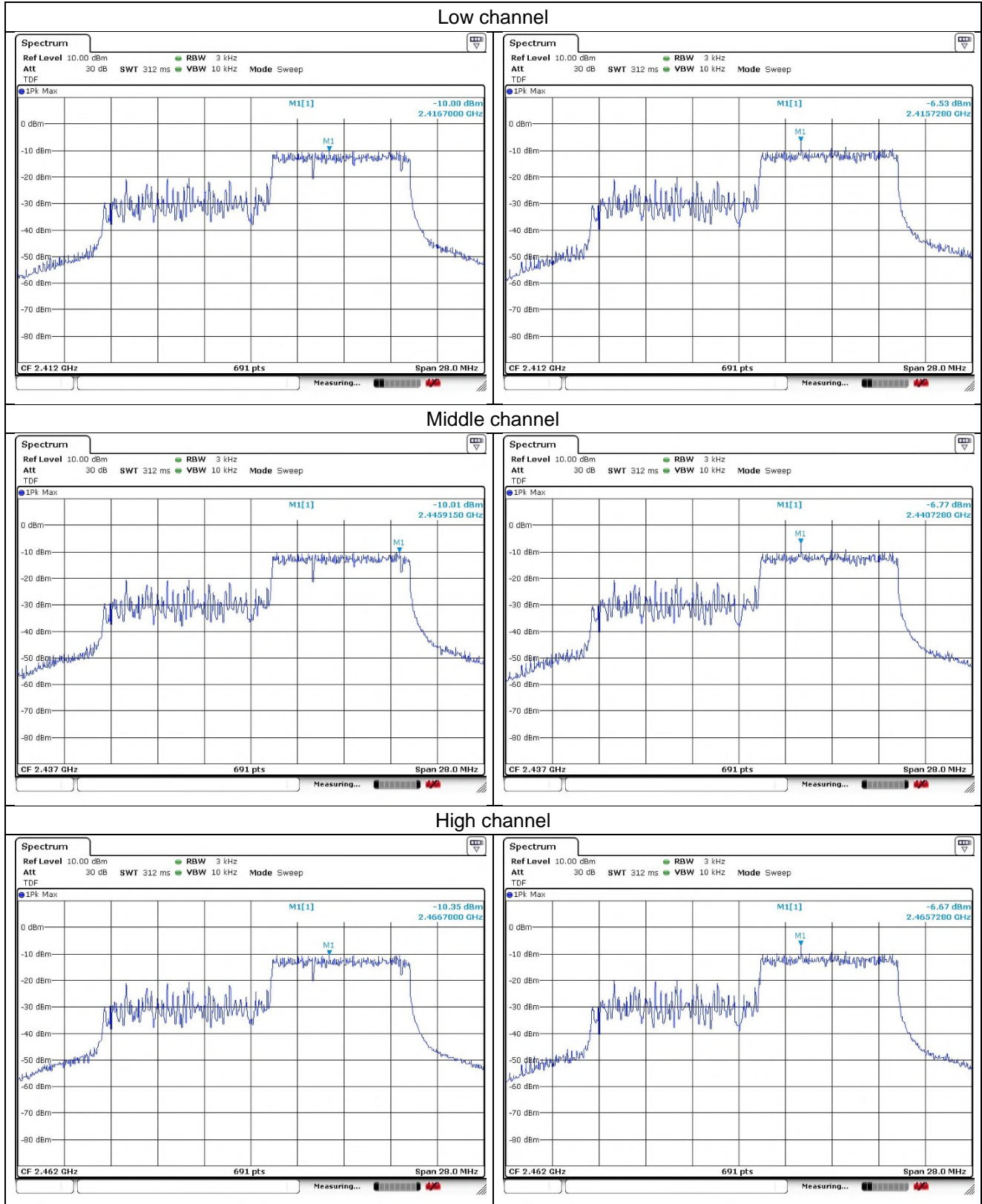



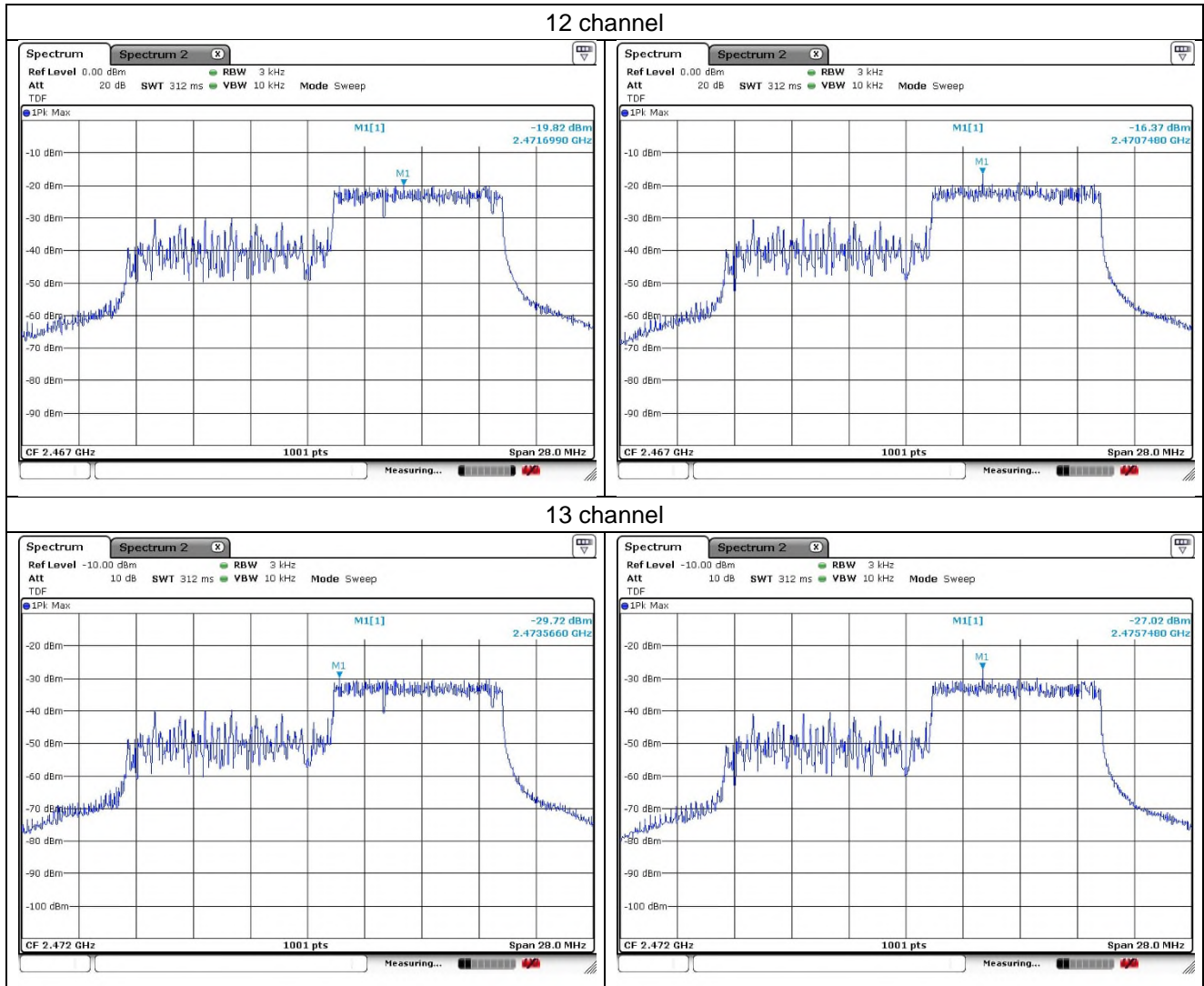

SU

Ant.1

Ant.2

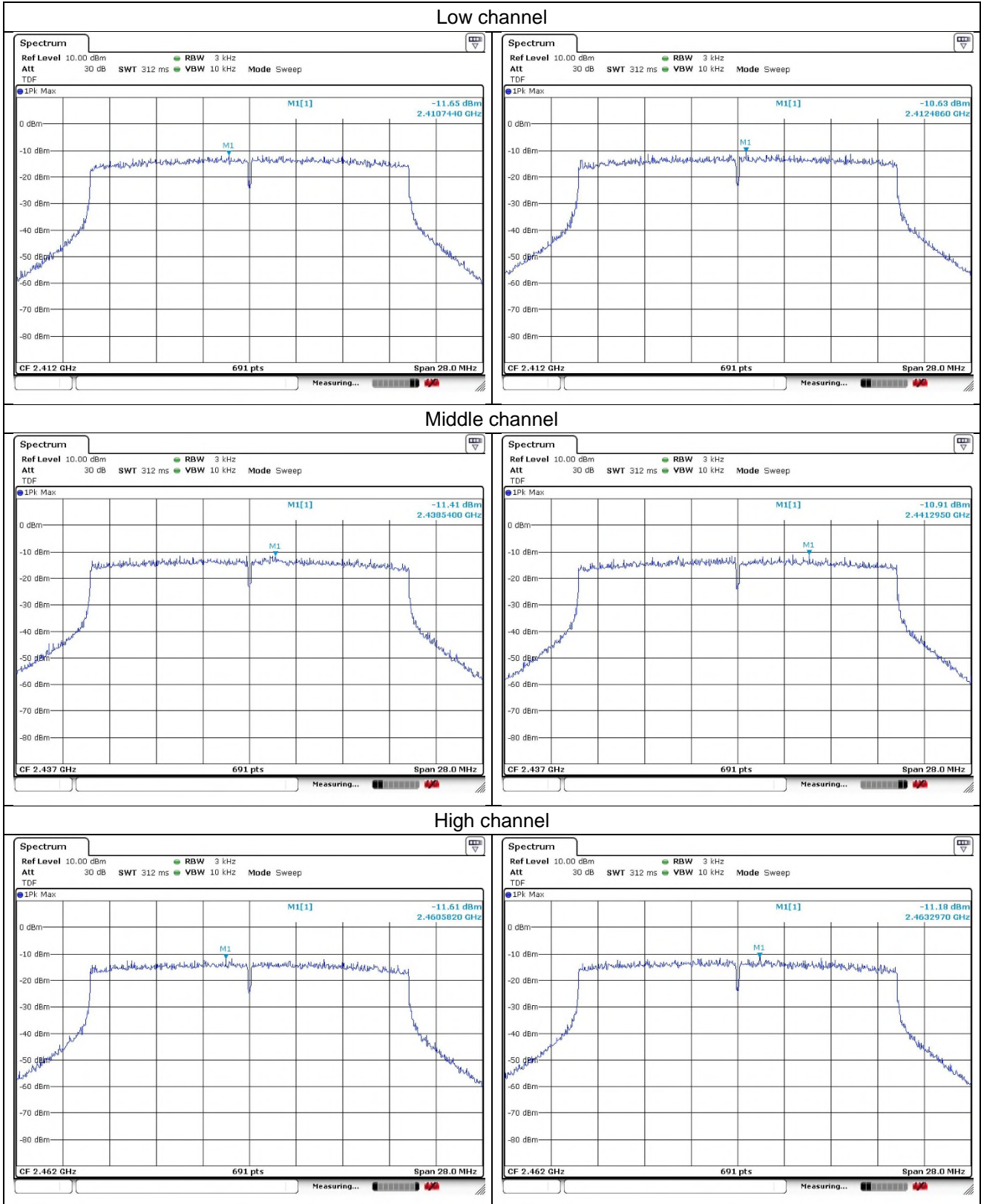

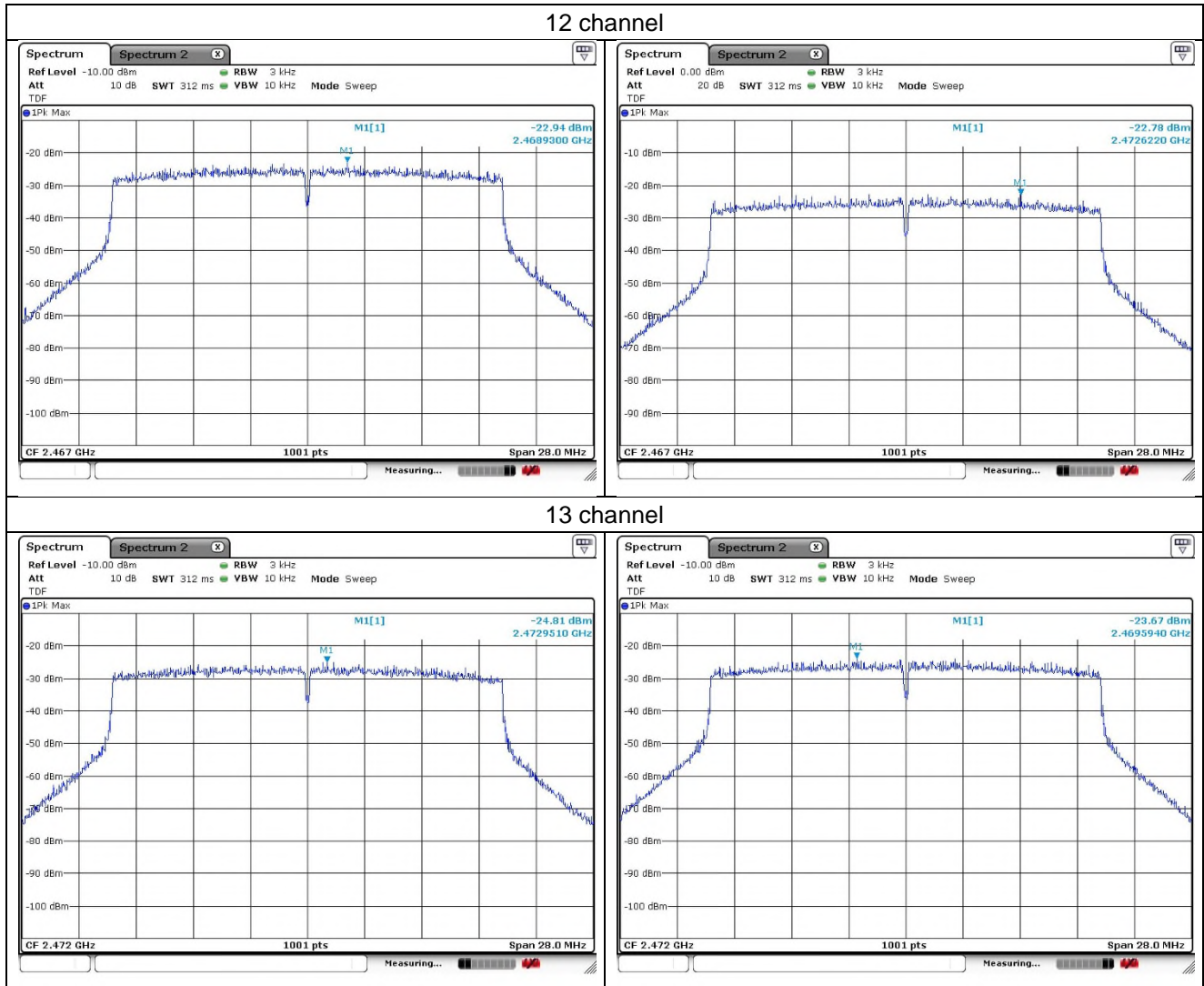

## 6. Transmitter AC Power Line Conducted Emission

### 6.1. Test Setup

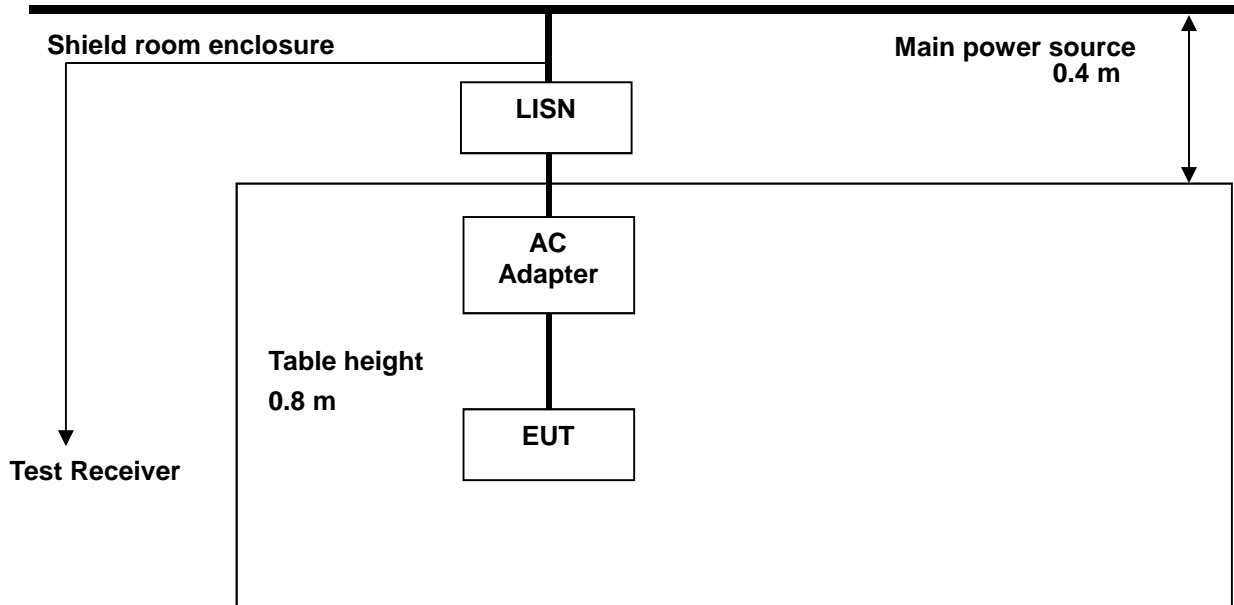

### 6.2. Limit

According to §15.207(a), for an intentional radiator that is designed to be connected to the public utility (AC) power line, the radio frequency voltage that is conducted back onto the AC power line on any frequency or frequencies, within the band 150 kHz to 30 MHz, shall not exceed the limits in the following table, as measured using a 50  $\mu$ H / 50 ohms line impedance stabilization network (LISN).

Compliance with the provision of this paragraph shall be based on the measurement of the radio frequency voltage between each power line and ground at the power terminal. The lower limit applies at the boundary between the frequency ranges.

Frequency of emission (MHz)	Conducted limit (dB $\mu$ V)	
	Quasi-peak	Average
0.15-0.5	66 to 56*	56 to 46*
0.5-5	56	46
5-30	60	50

\* Decreases with the logarithm of the frequency.

### 6.3. Test Procedures

AC conducted emissions from the EUT were measured according to the dictates of ANSI C63.10-2013

1. The test procedure is performed in a 6.5 m × 3.5 m × 3.5 m (L × W × H) shielded room. The EUT along with its peripherals were placed on a 1.0 m (W) × 1.5 m (L) and 0.8 m in height wooden table and the EUT was adjusted to maintain a 0.4 meter space from a vertical reference plane.
2. The EUT was connected to power mains through a line impedance stabilization network (LISN) which provides 50 ohm coupling impedance for measuring instrument and the chassis ground was bounded to the horizontal ground plane of shielded room.
3. All peripherals were connected to the second LISN and the chassis ground also bounded to the horizontal ground plane of shielded room.
4. The excess power cable between the EUT and the LISN was bundled. The power cables of peripherals were unbundled. All connecting cables of EUT and peripherals were moved to find the maximum emission.

### 6.4. Test Results

The following table shows the highest levels of conducted emissions on both phase of Hot and Neutral line.

Ambient temperature : (23 ± 1) °C  
 Relative humidity : 47 % R.H.

Frequency range : 0.15 MHz - 30 MHz  
 Measured Bandwidth : 9 kHz

FREQ. (MHz)	LEVEL (dBμV)		LINE	LIMIT (dBμV)		MARGIN (dB)	
	Q-Peak	Average		Q-Peak	Average	Q-Peak	Average
0.16	49.40	35.20	N	65.46	55.46	16.06	20.26
0.70	36.30	28.70	N	56.00	46.00	19.70	17.30
2.11	33.10	18.10	N	56.00	46.00	22.90	27.90
4.30	39.60	25.00	N	56.00	46.00	16.40	21.00
8.77	37.10	23.30	N	60.00	50.00	22.90	26.70
13.05	44.50	29.70	N	60.00	50.00	15.50	20.30
0.15	49.20	36.60	H	66.00	56.00	16.80	19.40
0.69	37.20	25.70	H	56.00	46.00	18.80	20.30
1.80	34.00	24.10	H	56.00	46.00	22.00	21.90
4.12	40.50	24.80	H	56.00	46.00	15.50	21.20
8.85	36.40	23.90	H	60.00	50.00	23.60	26.10
13.09	41.80	28.60	H	60.00	50.00	18.20	21.40

**Remark;**

1. Line (H): Hot, Line (N): Neutral.
2. All data rates and modes of operation were investigated and the worst-case emissions were reported using **11ax HE20(MIMO) / Low channel / 26T / 0 RU**.
3. The limit for Class B device(s) from 150 kHz to 30 MHz are specified in Section of the Title 47 CFR.
4. Traces shown in plot were made by using a peak detector and average detector.
5. Deviations to the Specifications: None.

**- Test plots**

Test mode: (Neutral)

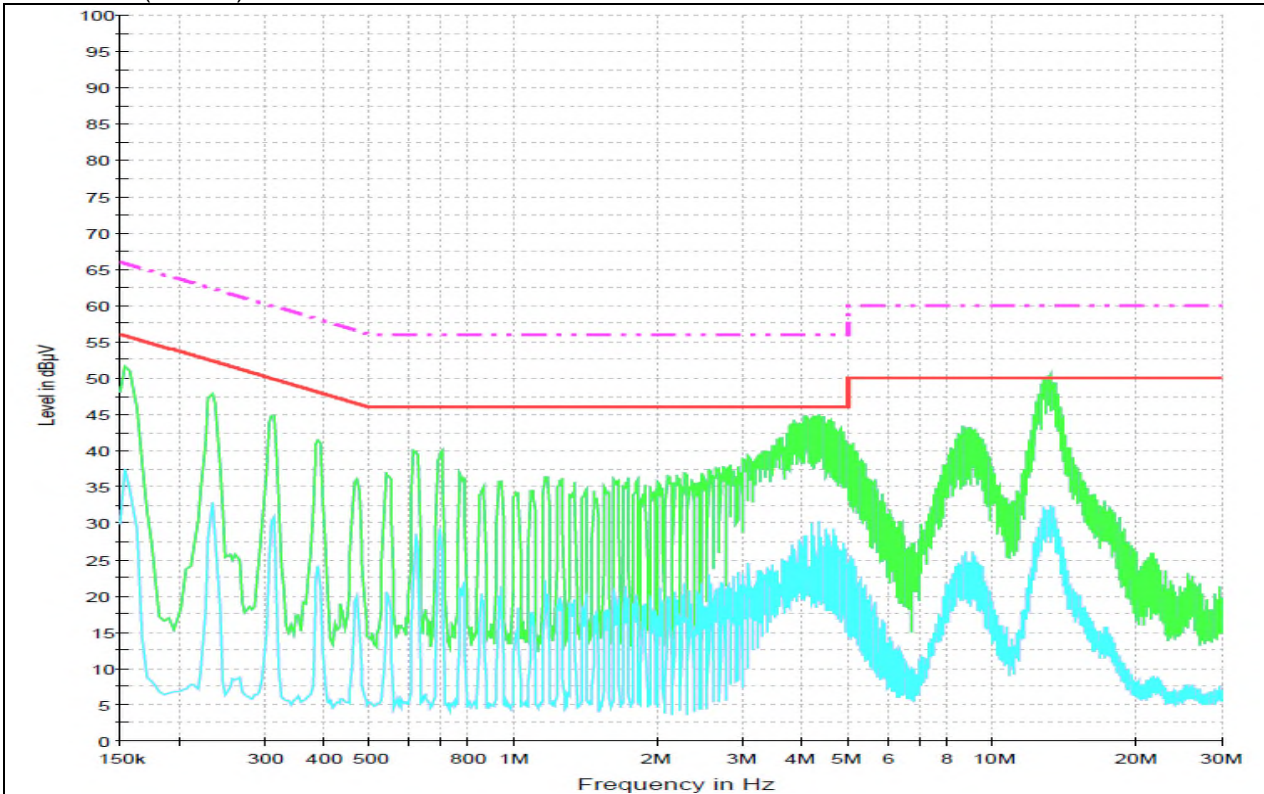

Test mode: (Hot)

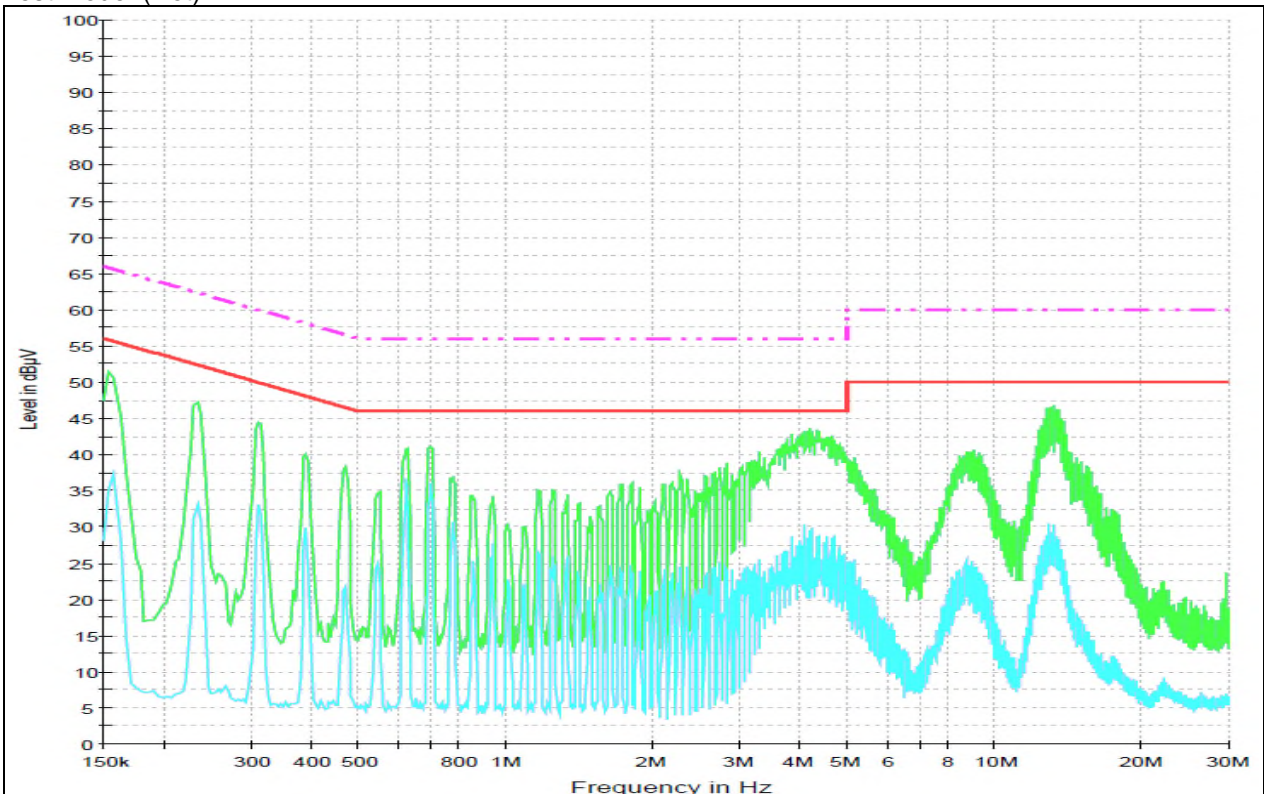

## 7. Antenna Requirement

### 7.1. Standard Applicable

For intentional device, according to FCC 47 CFR Section §15.203, an intentional radiator shall be designed to ensure that no antenna other than that furnished by the responsible party shall be used with the device. And according to FCC 47 CFR Section §15.247(b) if transmitting antennas of directional gain greater than 6 dB i are used, the power shall be reduced by the amount in dB that the gain of the antenna exceeds 6 dB i.

### 7.2. Antenna Connected Construction

Antenna used in this product is Metal Frame Antenna and peak max gain of antenna as below.

<b>Band</b>	<b>2 400 MHz ~ 2 483.5 MHz</b>
<b>Mode</b>	<b>11ax_HE20</b>
<b>Ant.1 Gain</b>	-5.10 dB i
<b>Ant.2 Gain</b>	-4.80 dB i
<b>Ant.1 + Ant.2 Gain</b>	-1.94 dB i

Unequal antenna gains, with equal transmit powers. For antenna gains given by  $G_1, G_2, \dots, G_N$  dB i

(i) If transmit signals are correlated, then

Directional gain =  $10 \log[(10^{G_1/20} + 10^{G_2/20} + \dots + 10^{G_N/20})^2 / N_{ANT}]$  dB i [Note the "20"s in the denominator of each exponent and the square of the sum of terms; the object is to combine the signal levels coherently.]

**- End of the Test Report -**