

**802.11ax\_HE80 Band 2C\_High channel\_52T**

**Ant.1**

**Ant.2**

**37 RU**

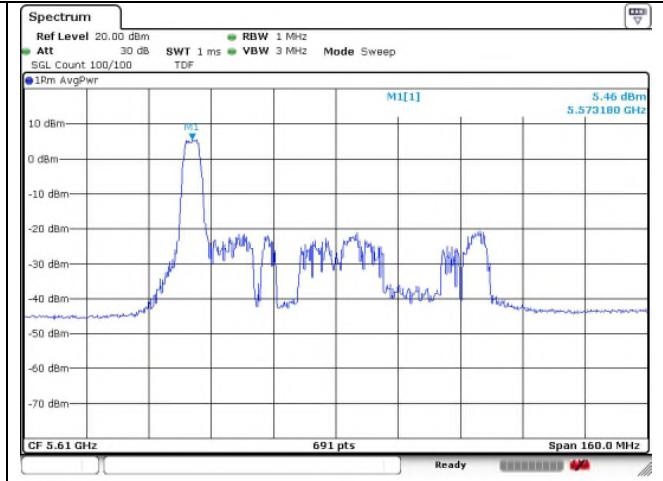
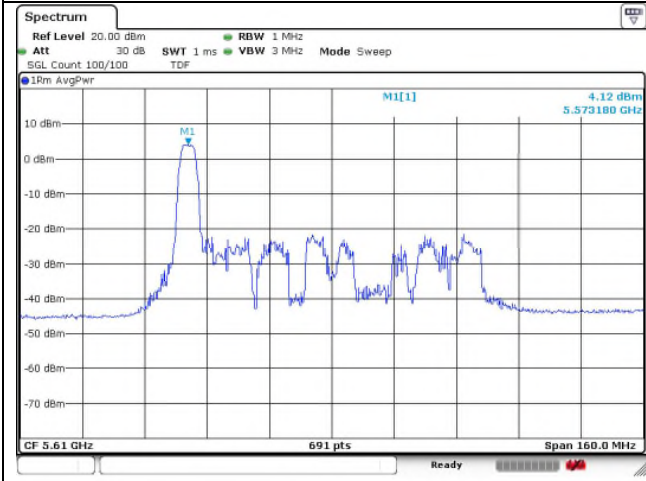

**45 RU**

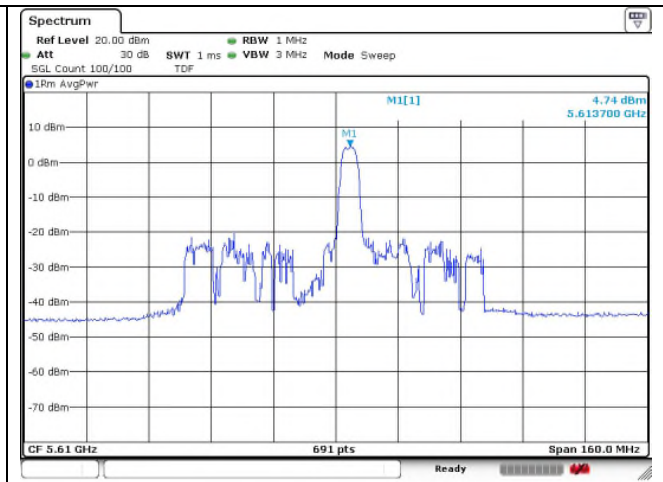
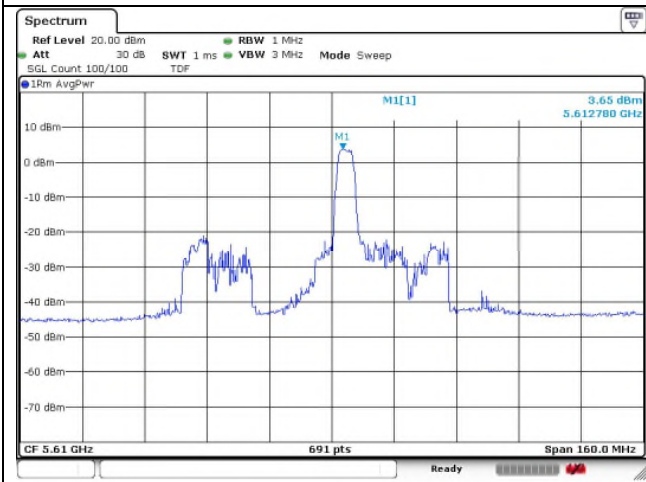

**52 RU**

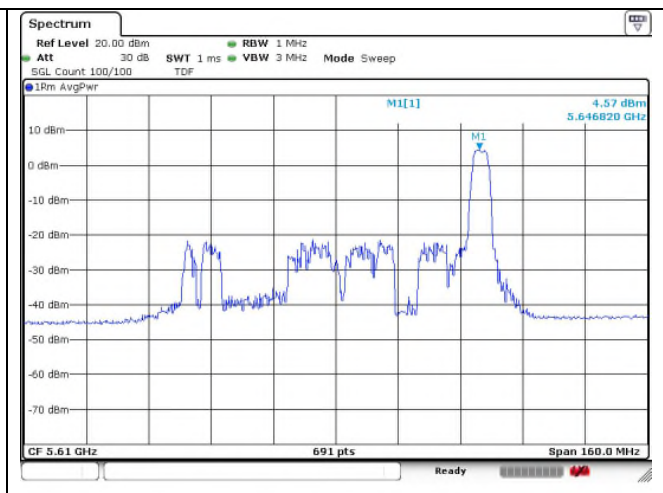
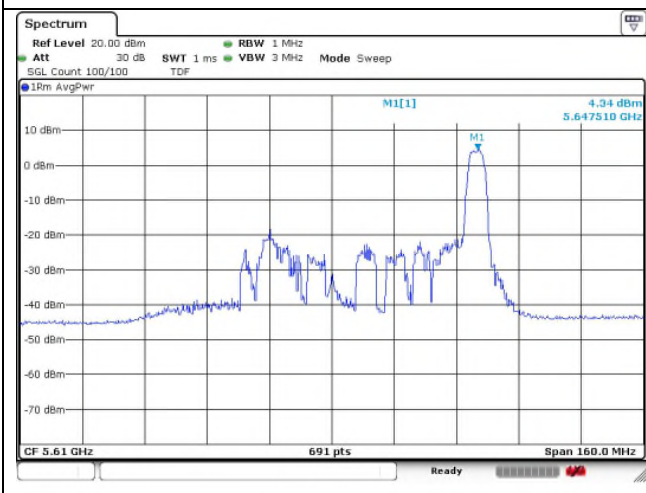

**802.11ax\_HE80 Band 2C\_High channel\_106T**

**Ant.1**

**Ant.2**

**53 RU**

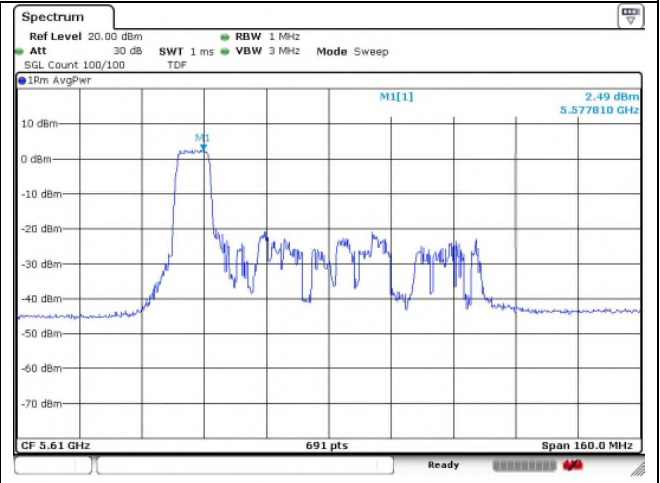
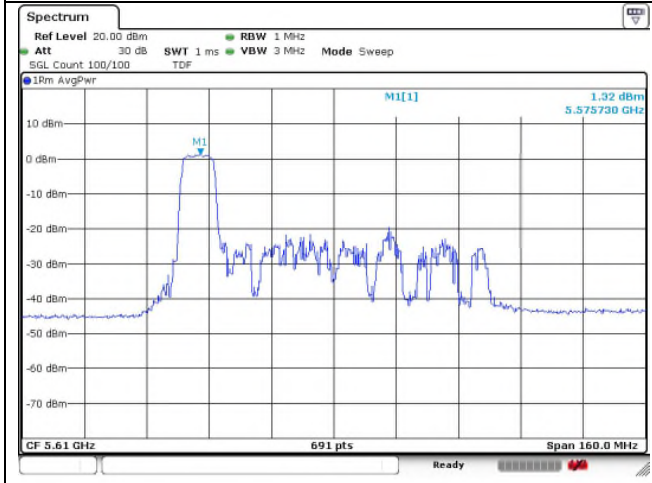

**57 RU**

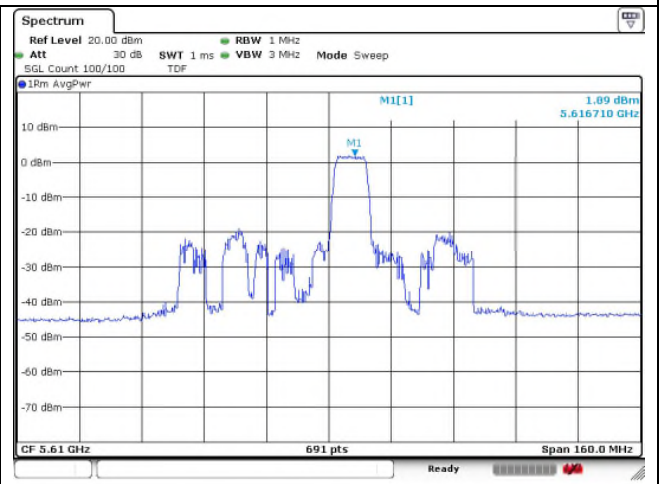
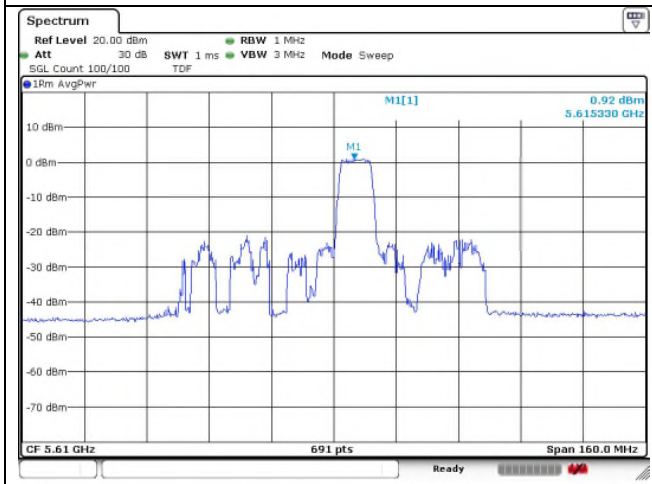

**60 RU**

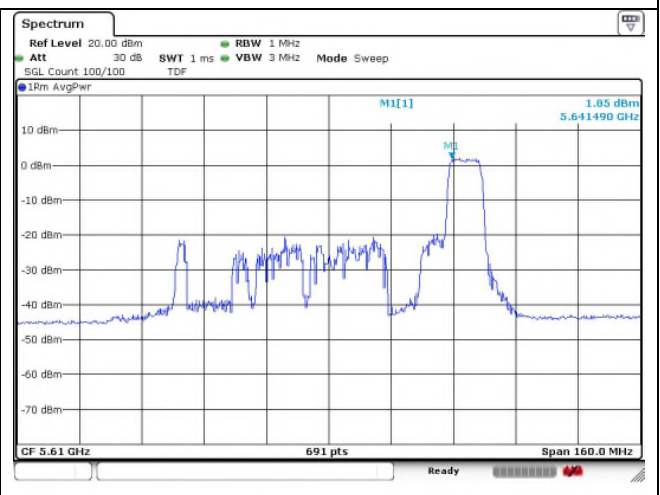
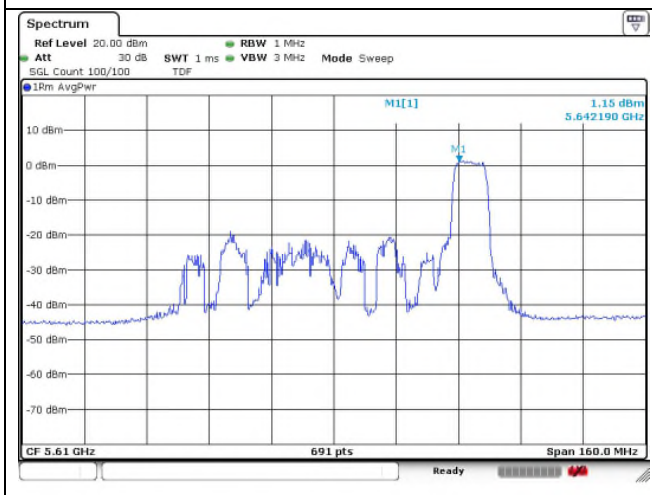

**802.11ax\_HE80 Band 2C\_High channel\_242T**

**Ant.1**

**Ant.2**

**61 RU**

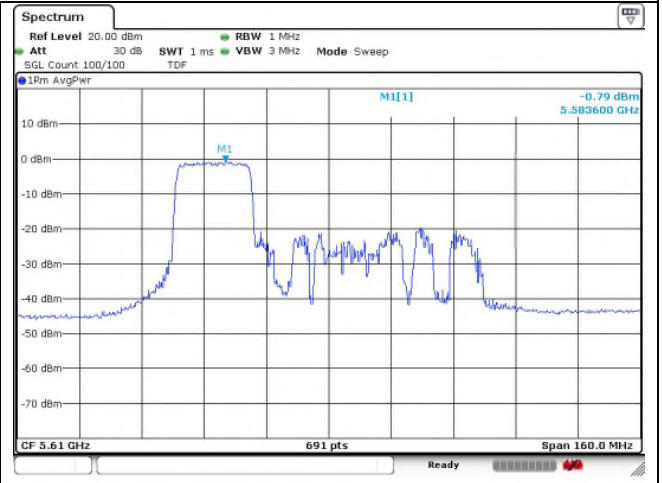
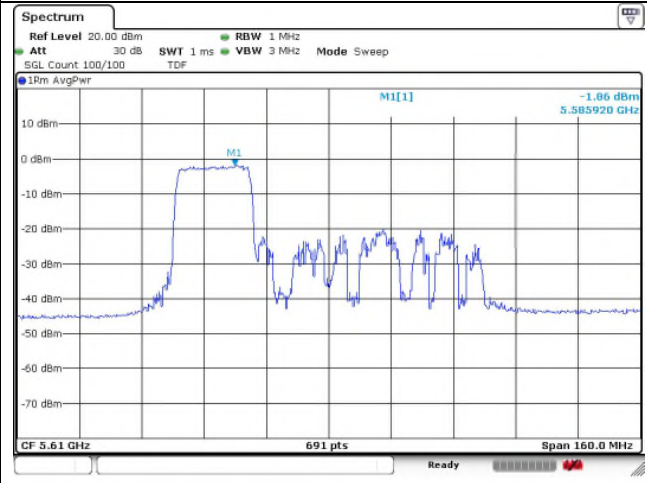

**62 RU**

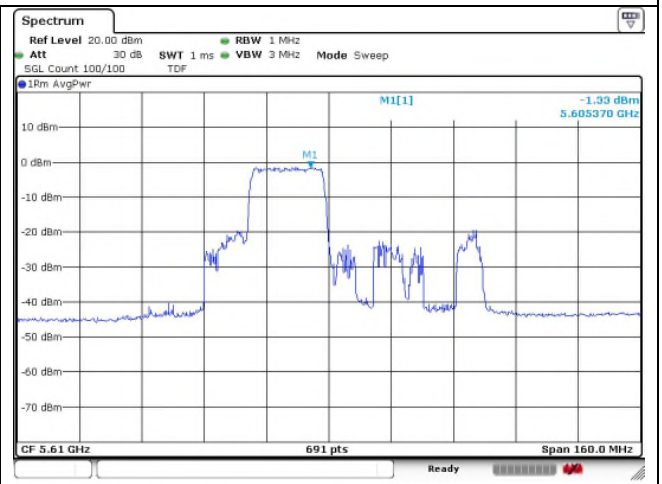
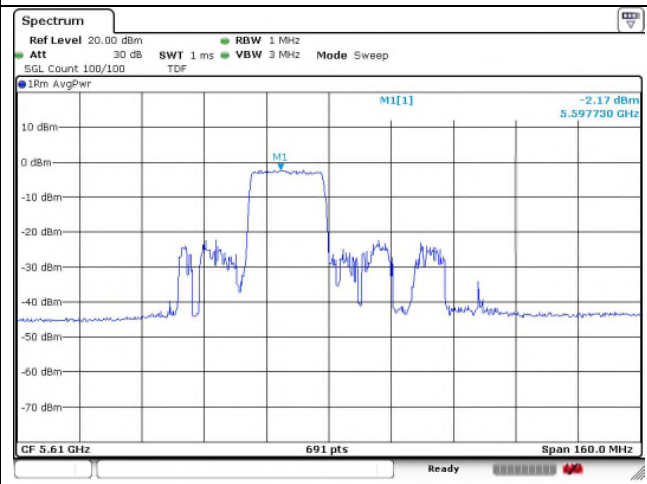

**64 RU**

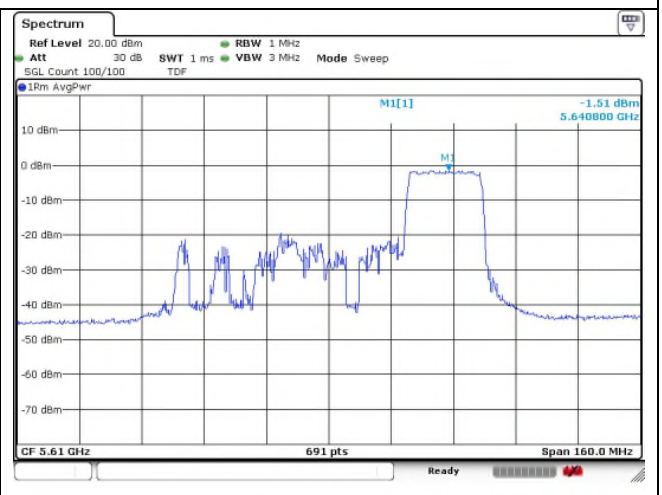
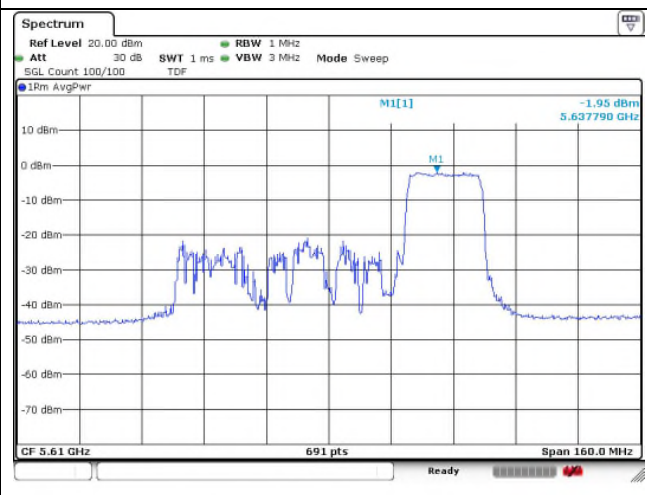

802.11ax\_HE80 Band 2C\_High channel\_242T

Ant.1

Ant.2

65 RU

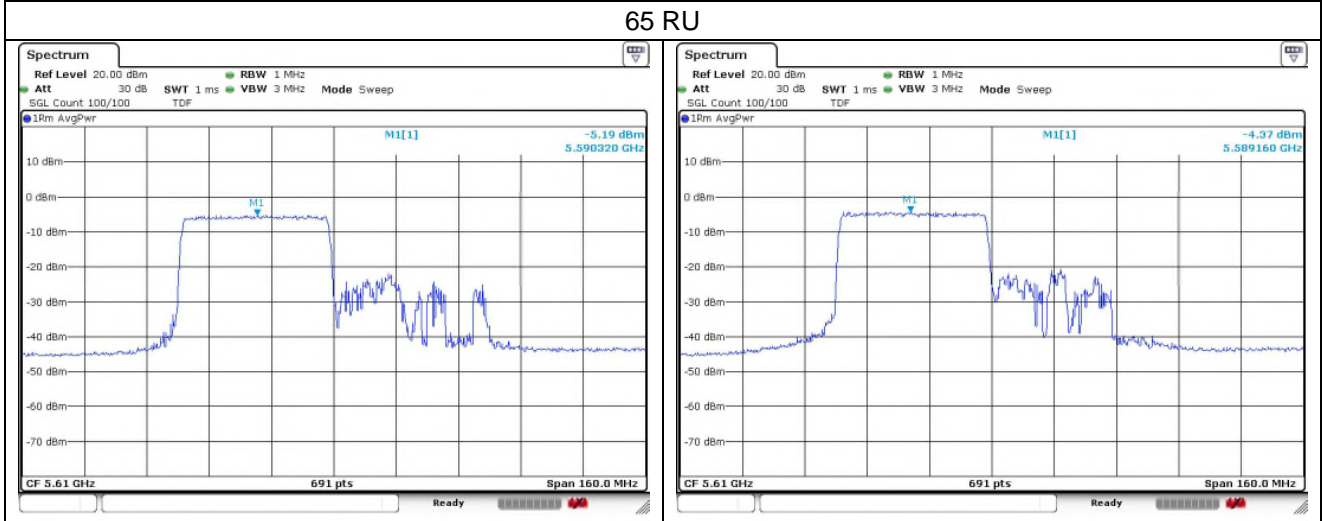

66 RU

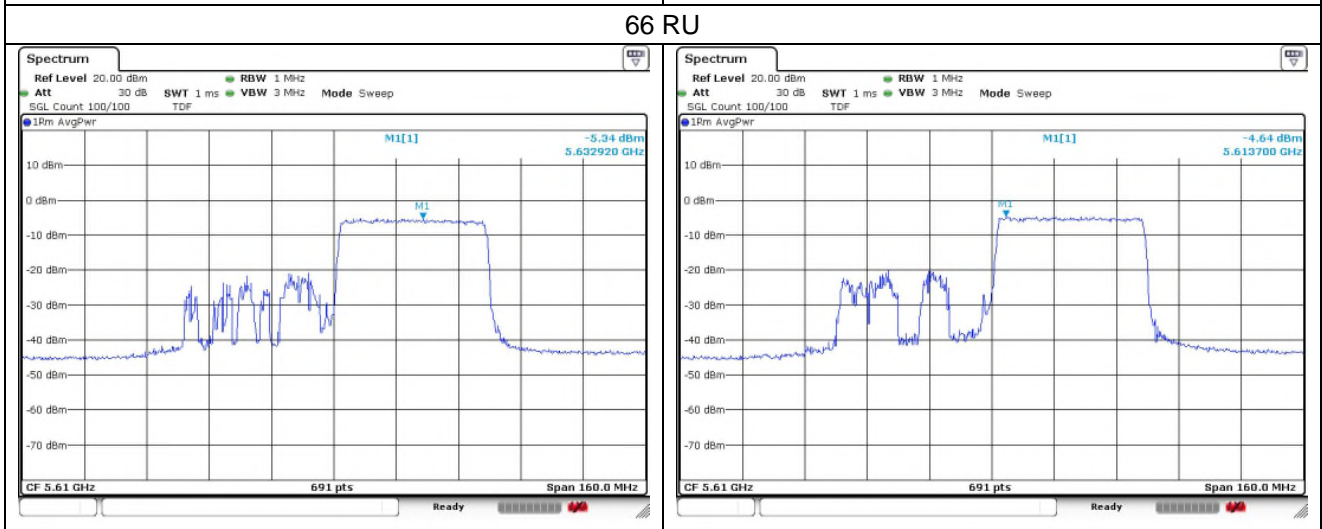

802.11ax\_HE80 Band 2C\_High channel\_SU

Ant.1

Ant.2

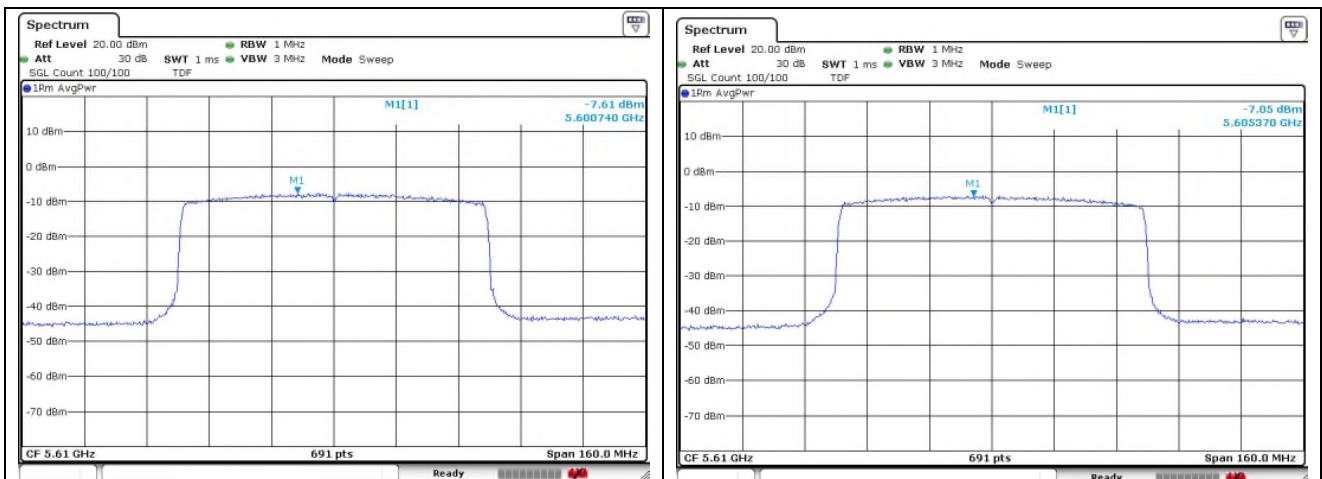

**802.11ax\_HE80 Band 3\_Middle channel\_26T**

**Ant.1**

**Ant.2**

0 RU

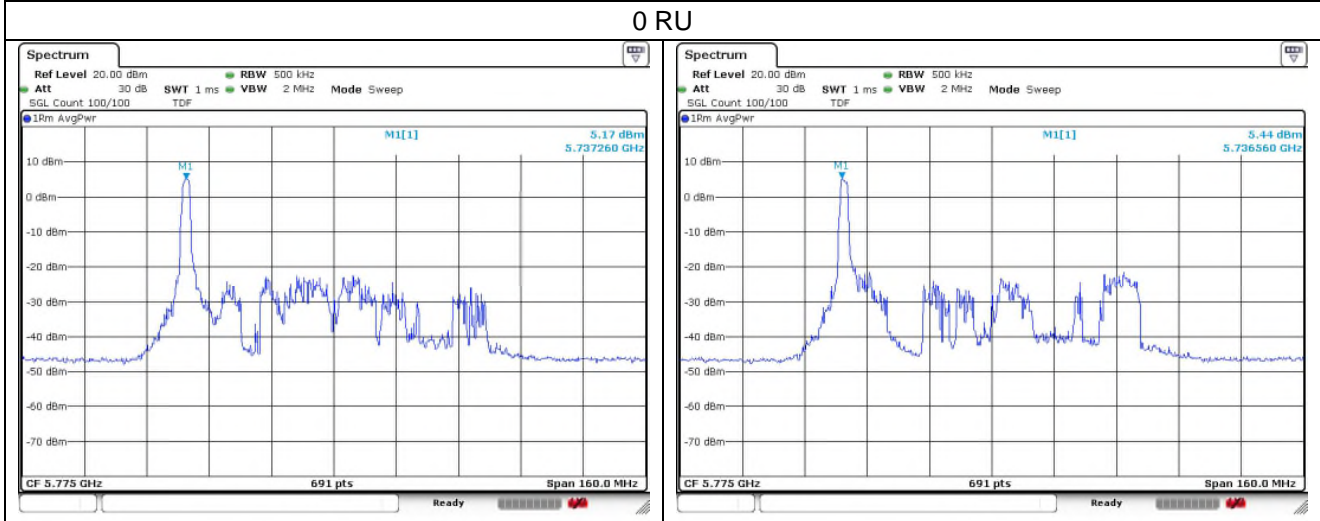

18 RU

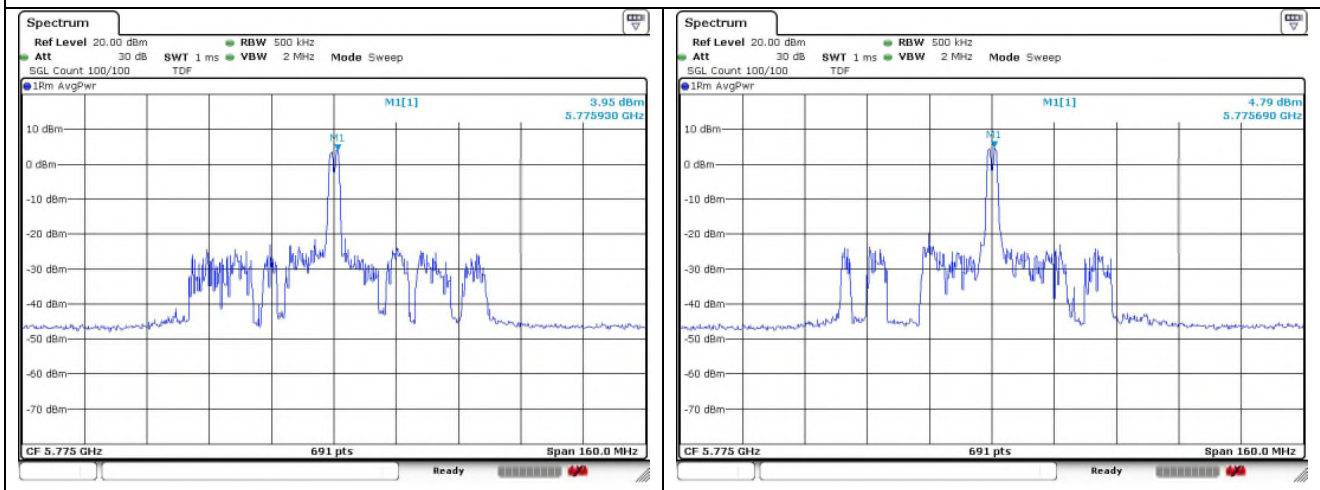

36 RU

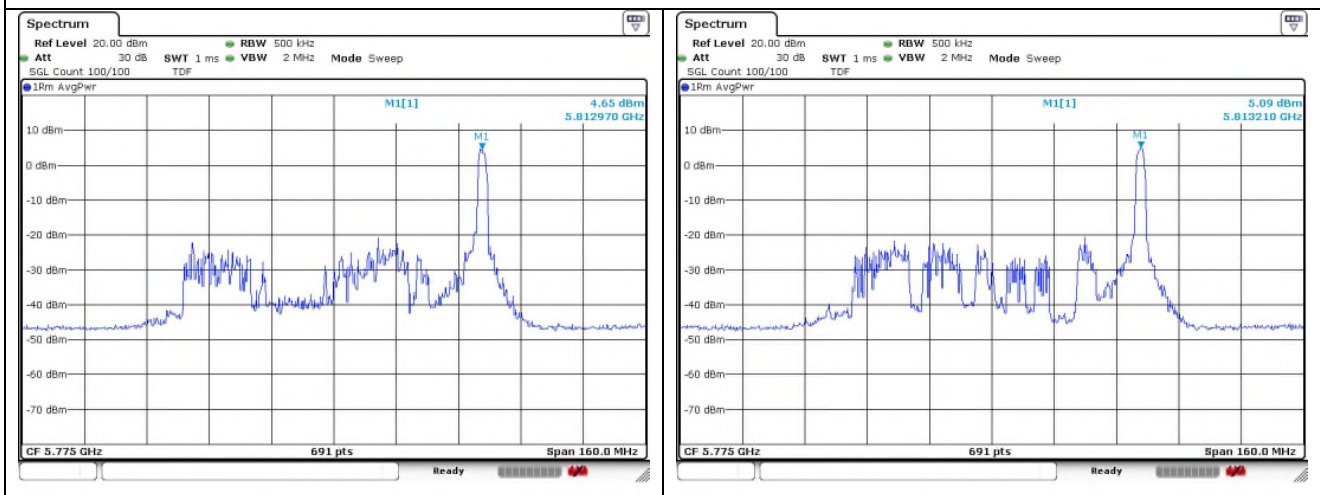

**802.11ax\_HE80 Band 3\_Middle channel\_52T**

**Ant.1**

**Ant.2**

**37 RU**

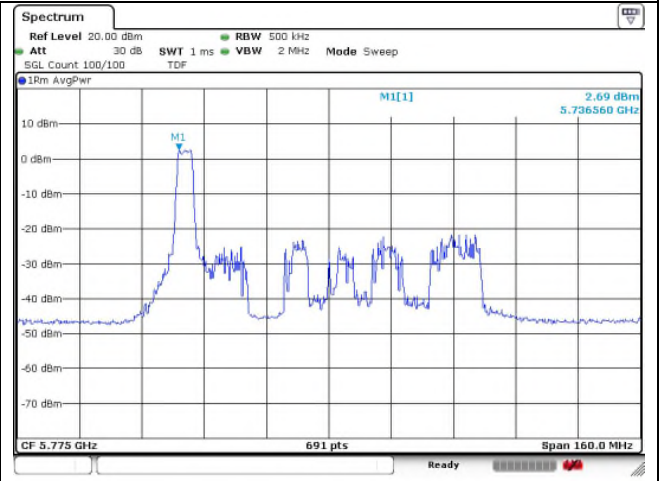
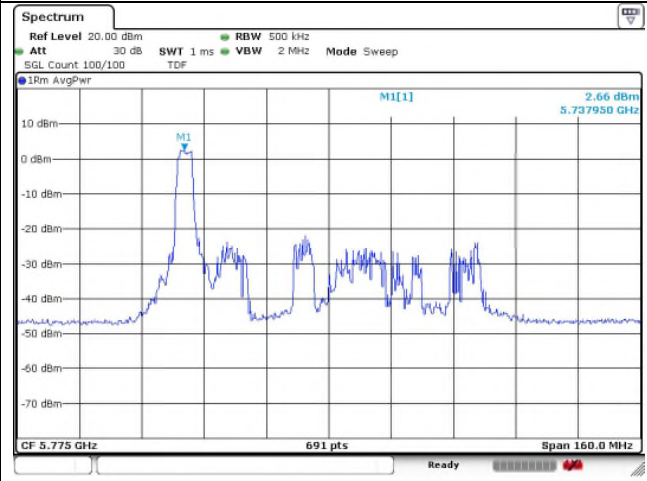

**45 RU**

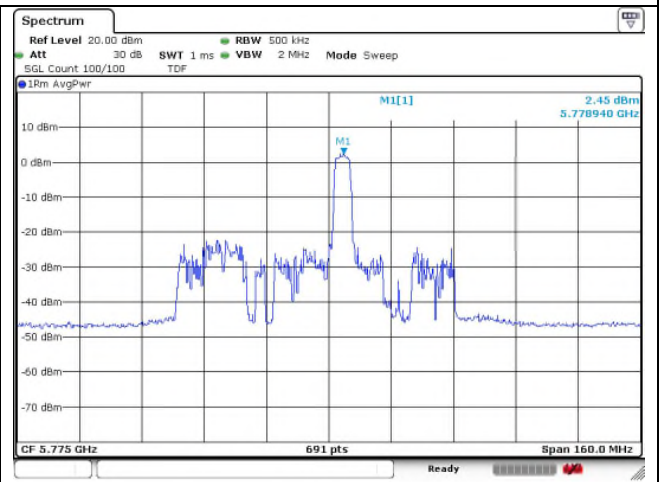
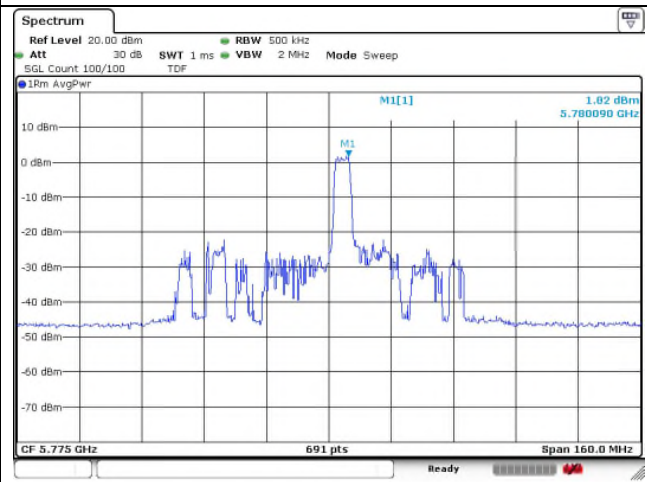

**52 RU**

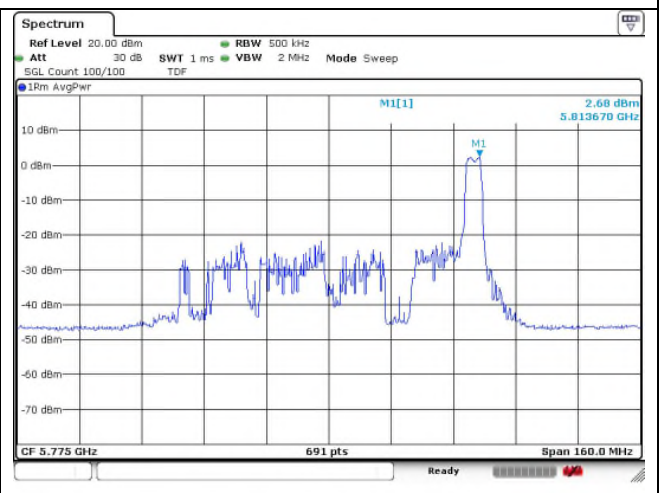
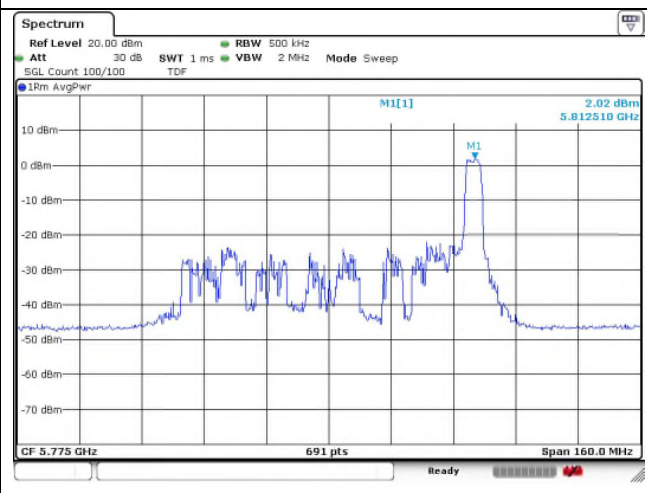

**802.11ax\_HE80 Band 3\_Middle channel\_106T**

**Ant.1**

**Ant.2**

**53 RU**

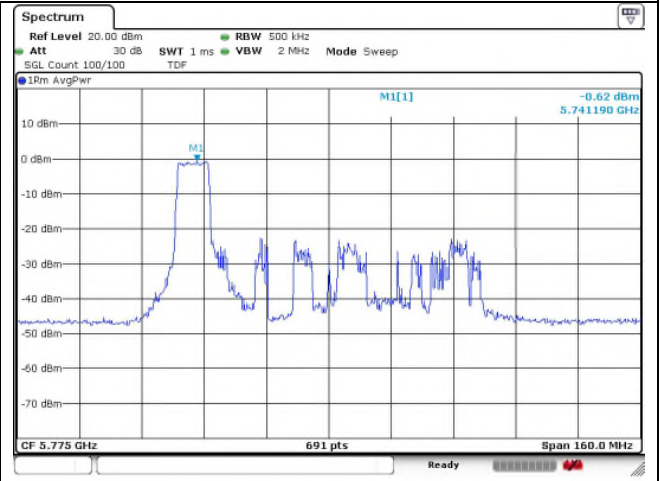
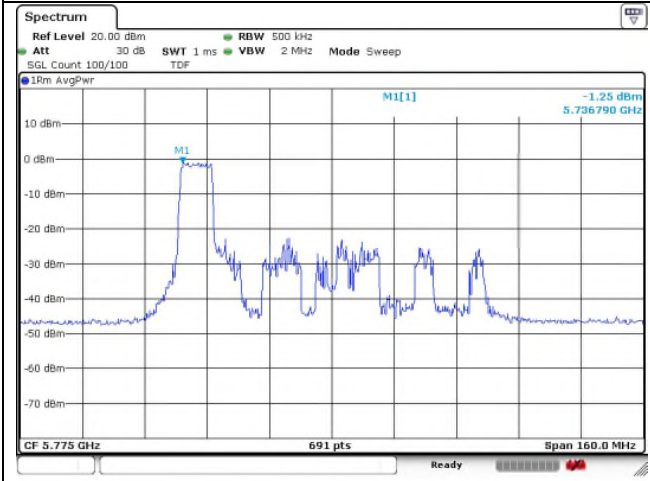

**57 RU**

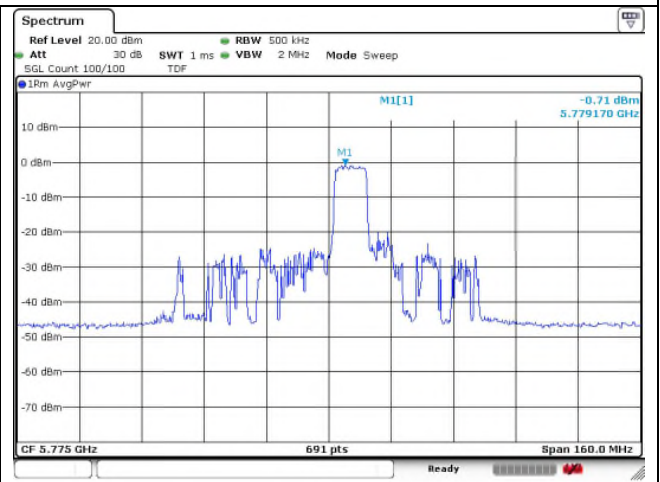
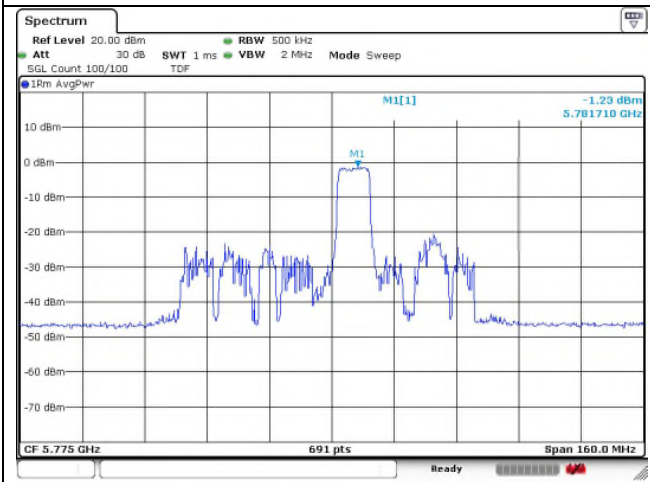

**60 RU**

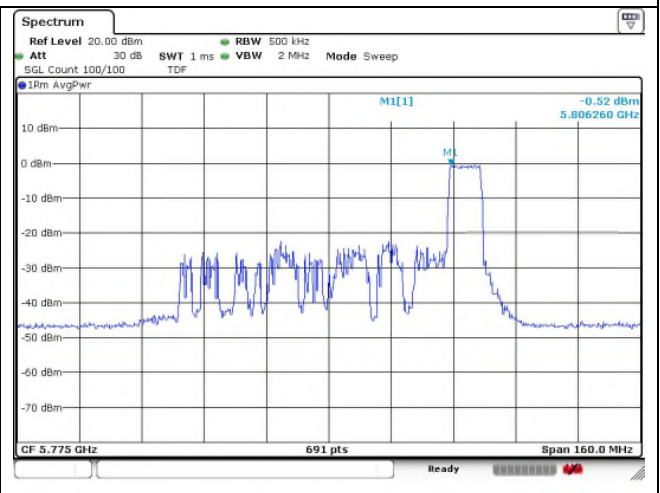
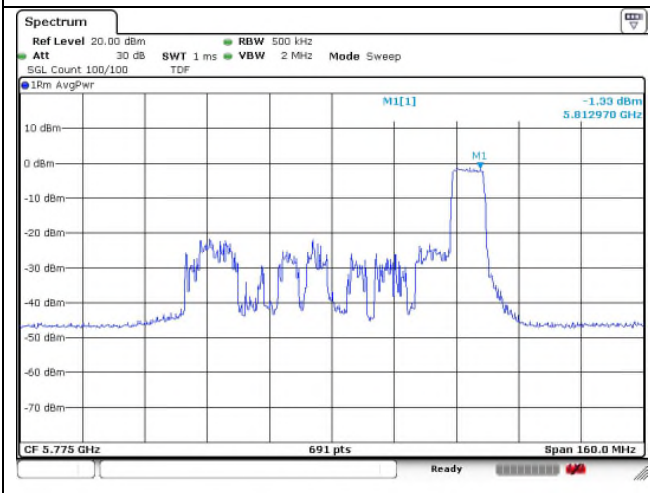

**802.11ax\_HE80 Band 3\_Middle channel\_242T**

**Ant.1**

**Ant.2**

**61 RU**

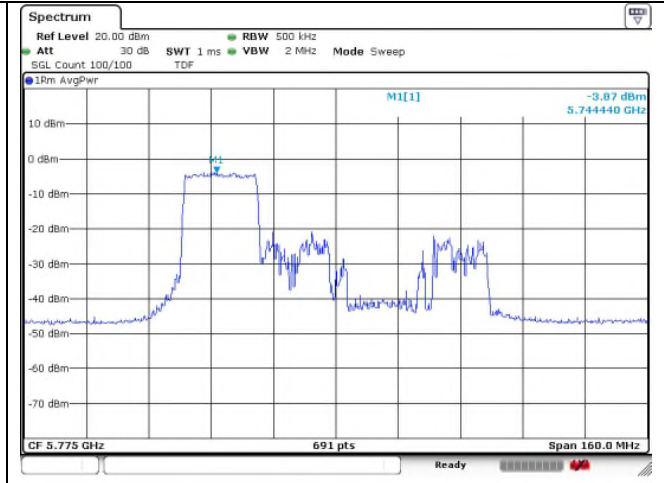
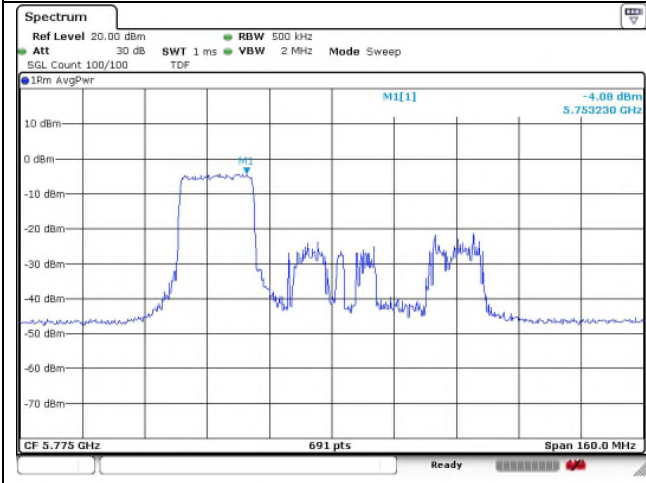

**62 RU**

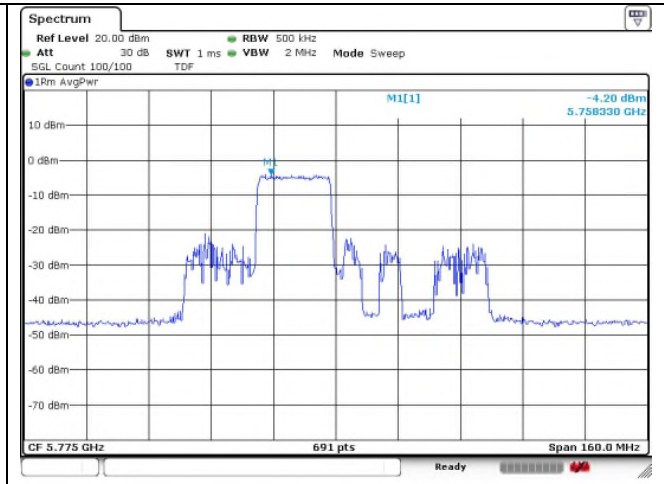
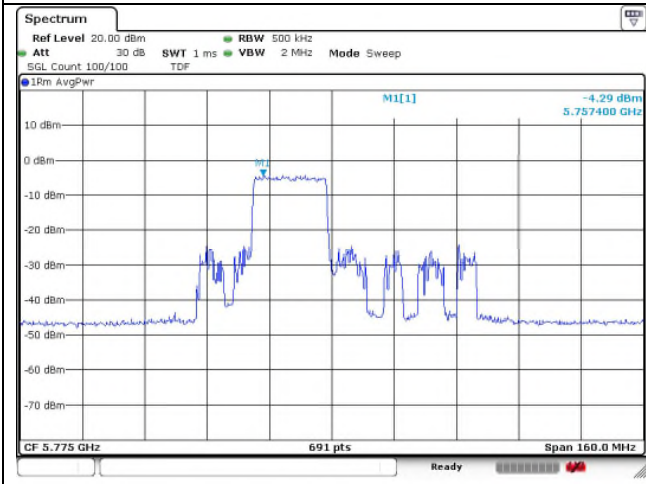

**64 RU**

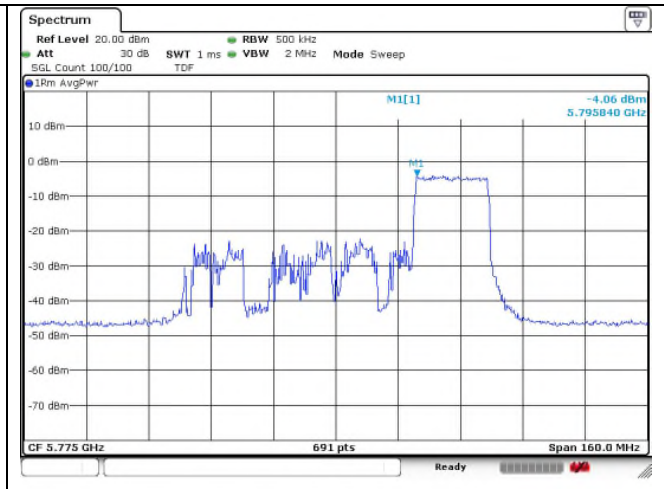
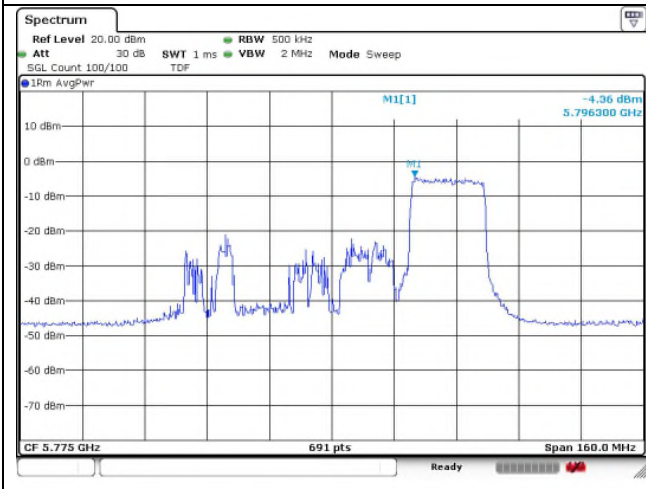



802.11ax\_HE80 Band 3\_Middle channel\_242T

Ant.1

Ant.2

65 RU

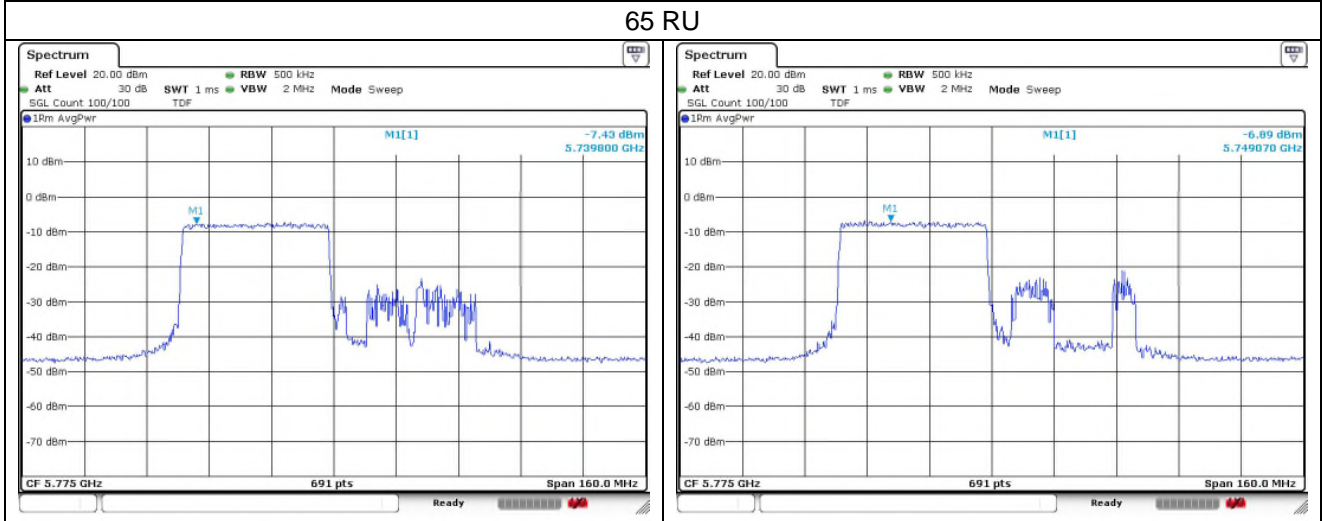

66 RU

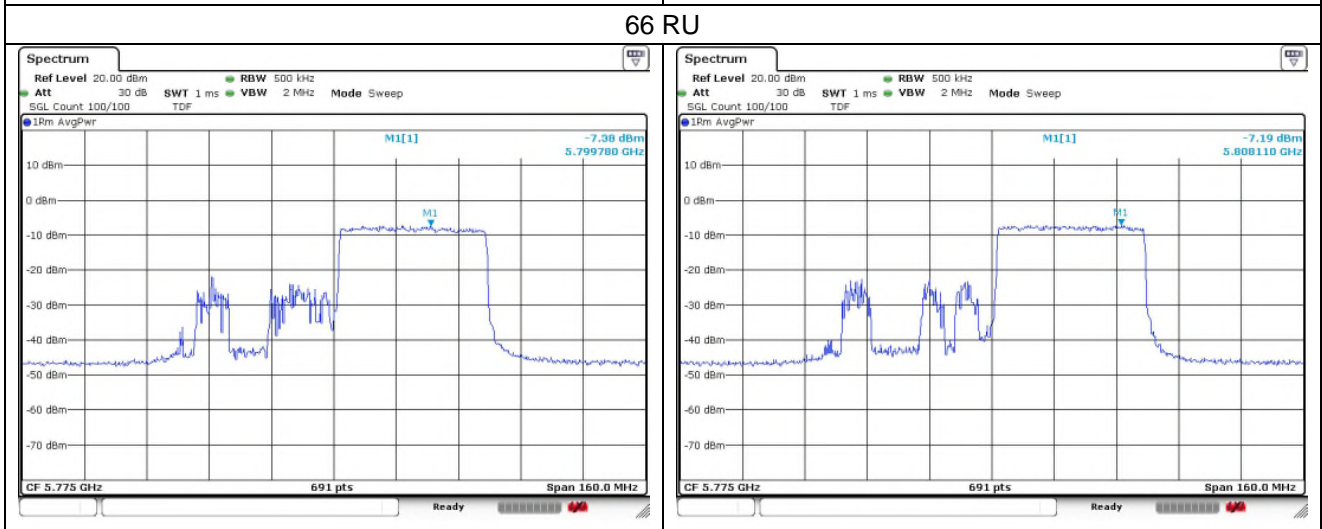

802.11ax\_HE80 Band 3\_Middle channel\_SU

Ant.1

Ant.2

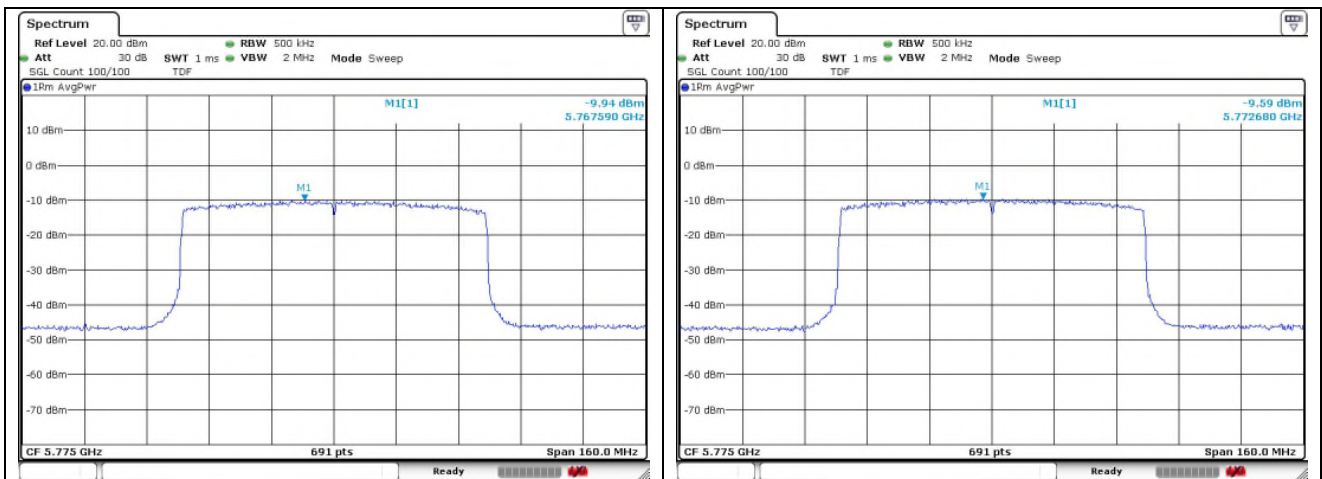

**802.11ax\_HE80 Band 2C\_Straddle channel\_26T**

**Ant.1**

**Ant.2**

0 RU

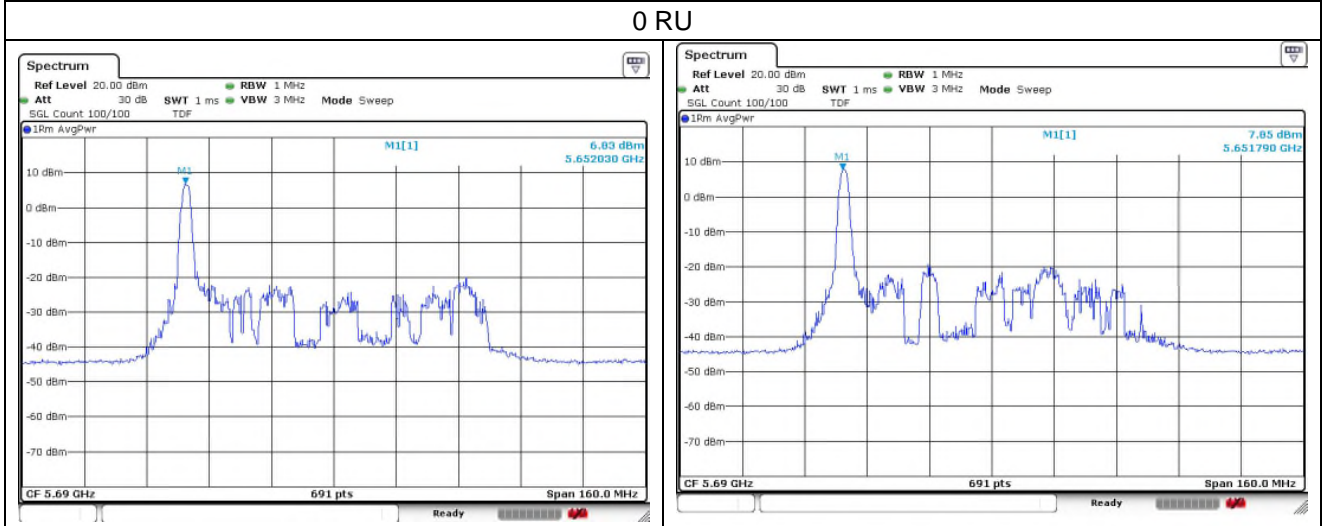

18 RU

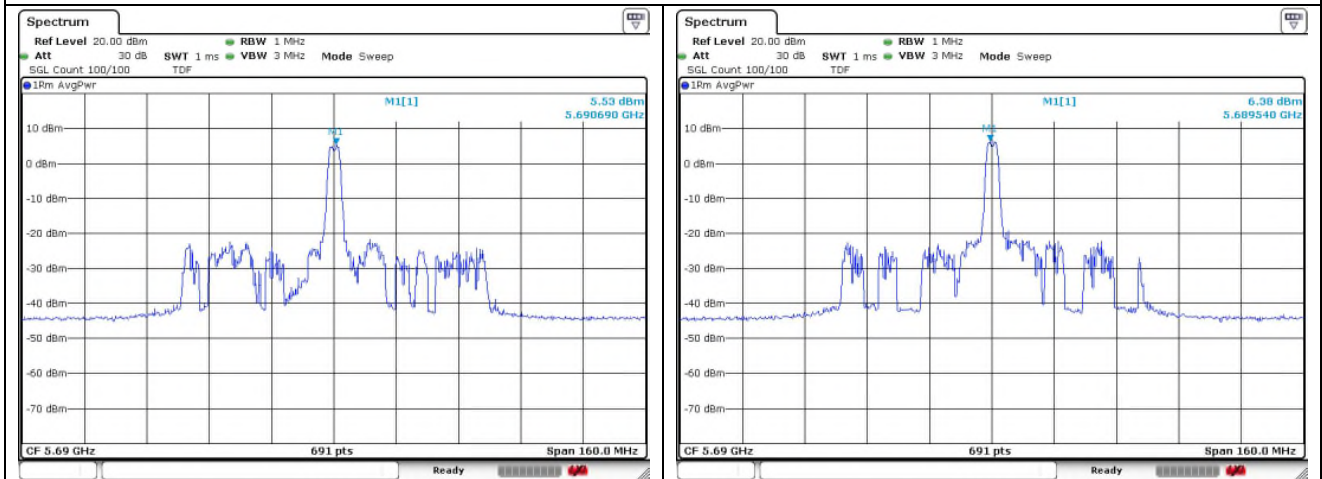

**802.11ax\_HE80 Band 3\_Straddle channel\_26T**

**Ant.1**

**Ant.2**

36 RU

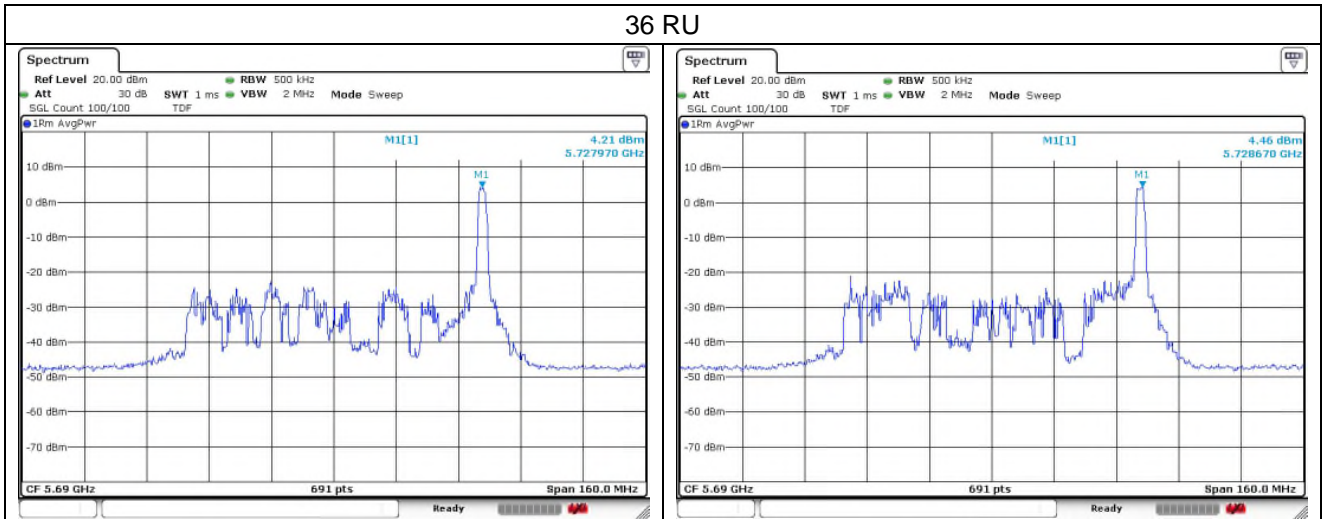

**802.11ax\_HE80 Band 2C\_Straddle channel\_52T**

**Ant.1**

**Ant.2**

**37 RU**

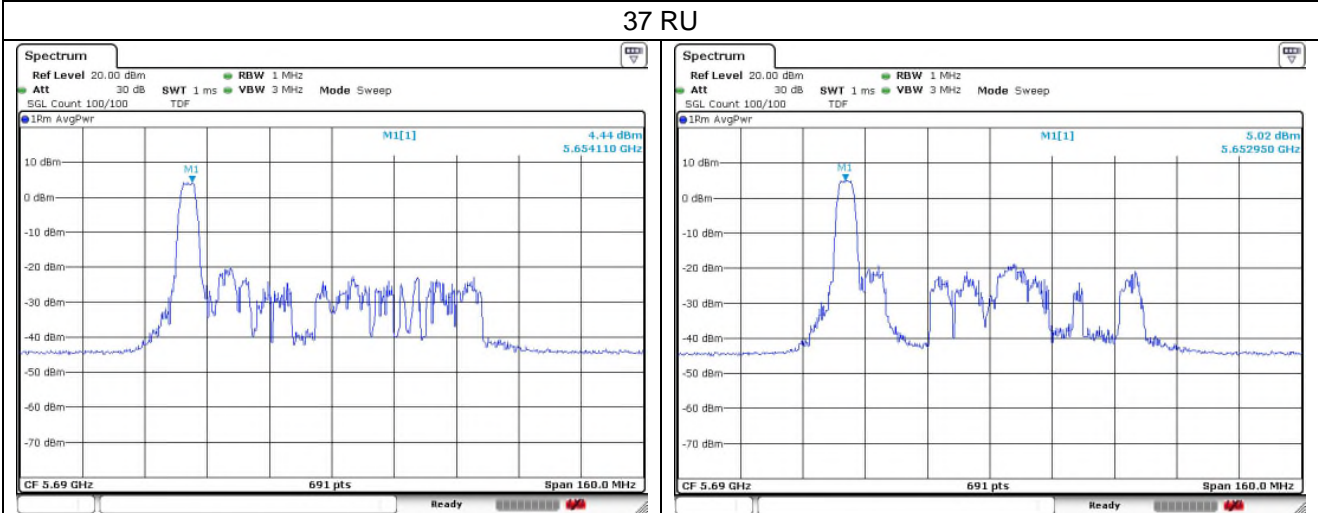

**45 RU**

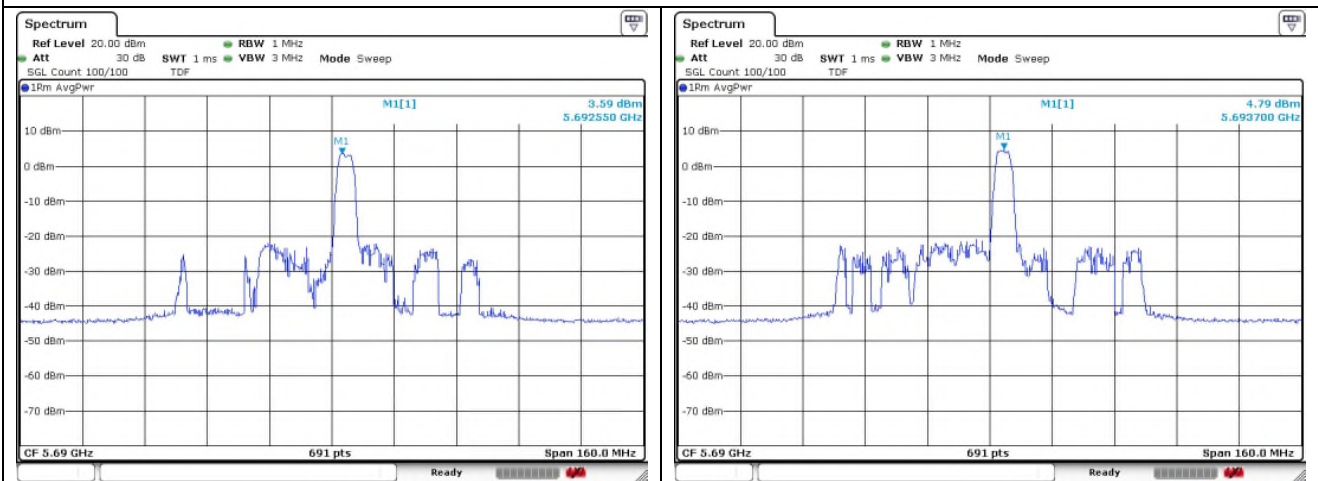

**802.11ax\_HE80 Band 3\_Straddle channel\_52T**

**Ant.1**

**Ant.2**

**52 RU**

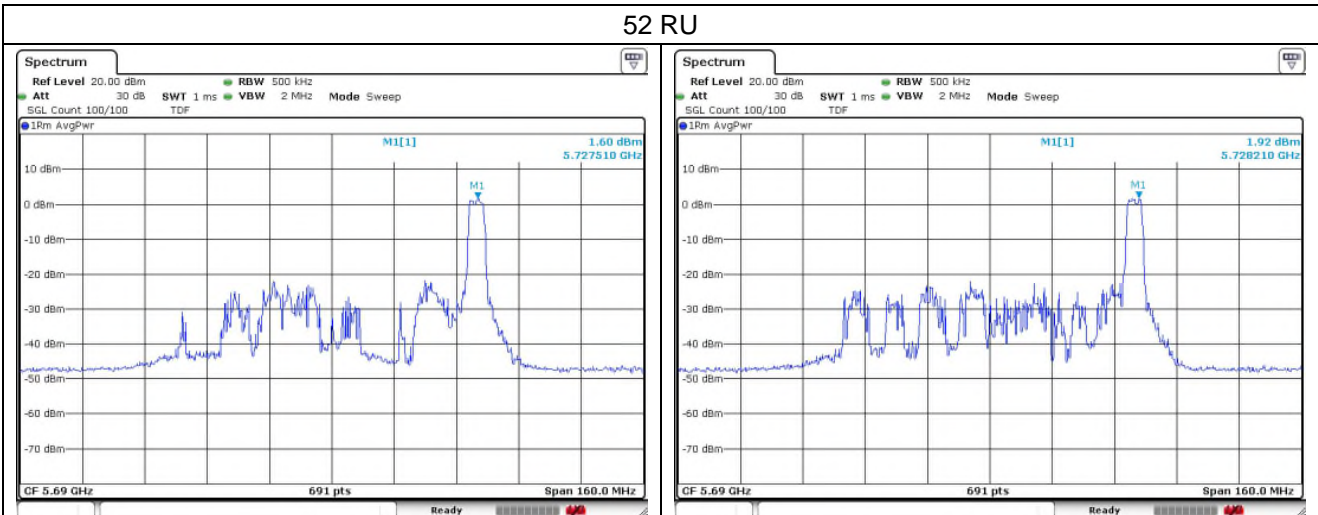

**802.11ax\_HE80 Band 2C\_Straddle channel\_106T**

**Ant.1**

**Ant.2**

**53 RU**

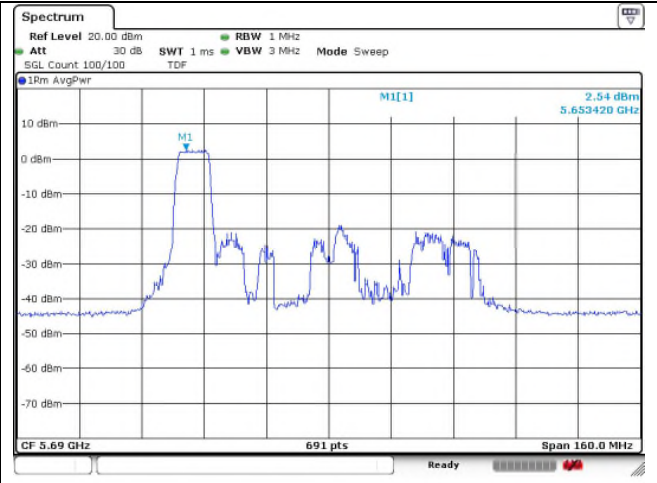
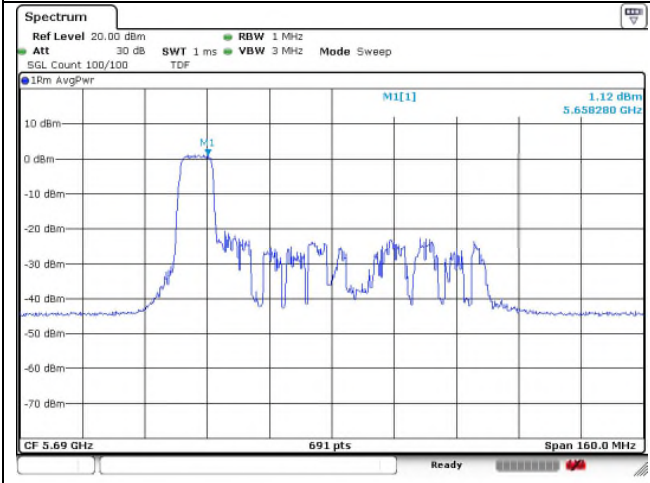

**57 RU**

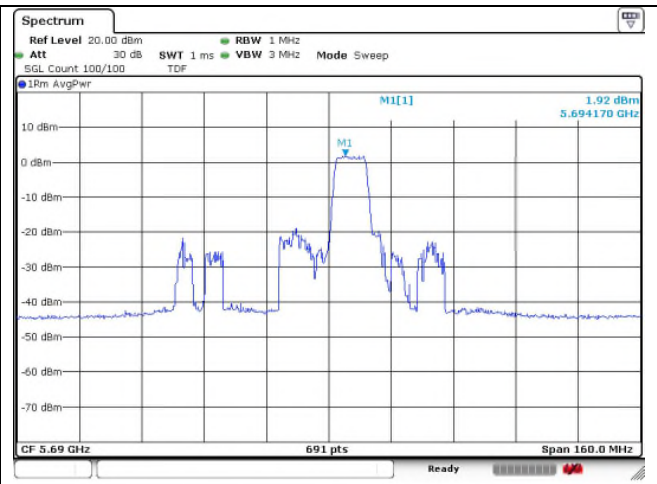
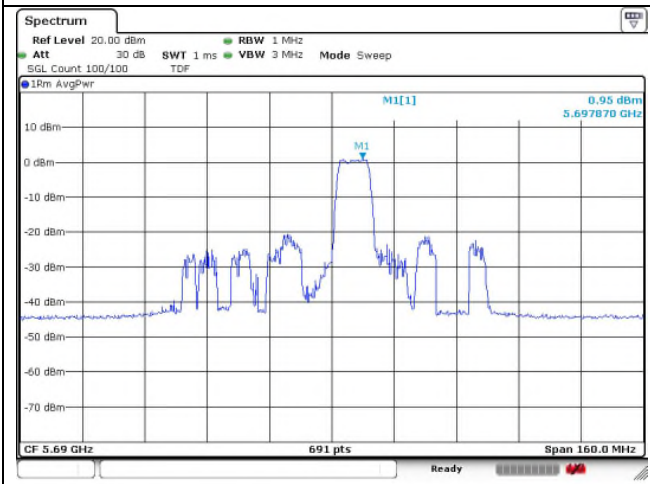

**60 RU**

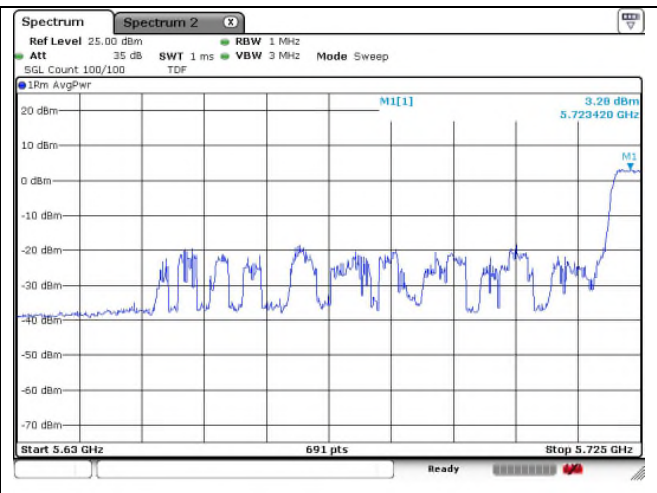
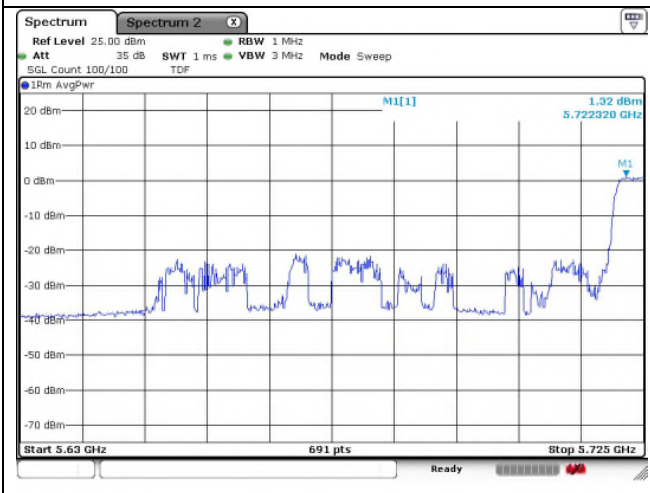

802.11ax\_HE80 Band 3\_Straddle channel\_106T

Ant.1

Ant.2

60 RU

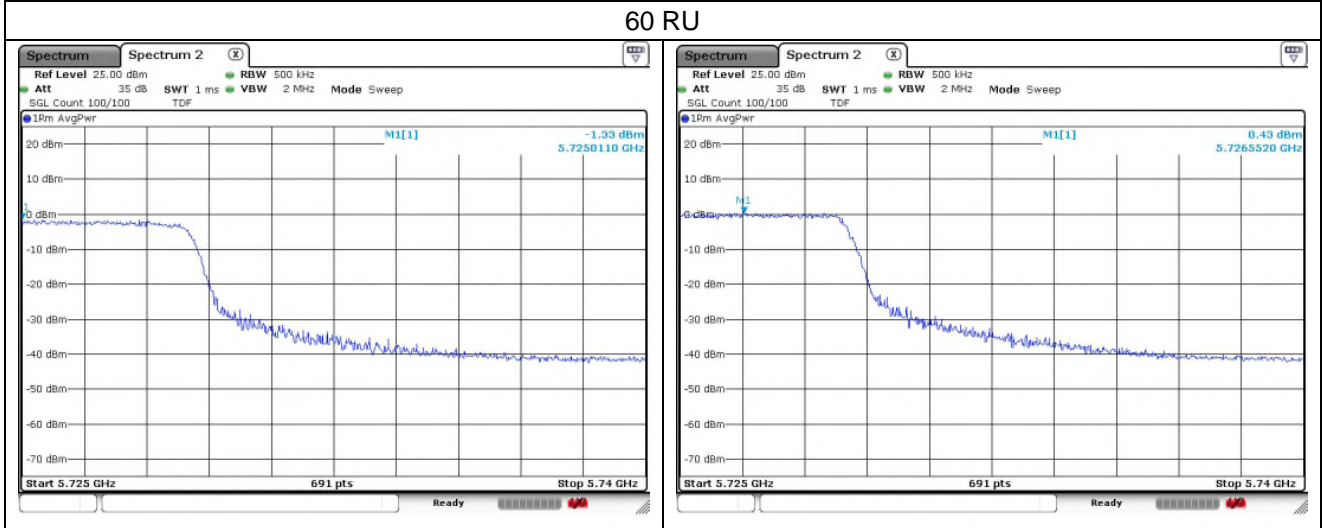

802.11ax\_HE80 Band 2C\_Straddle channel\_242T

Ant.1

Ant.2

61 RU

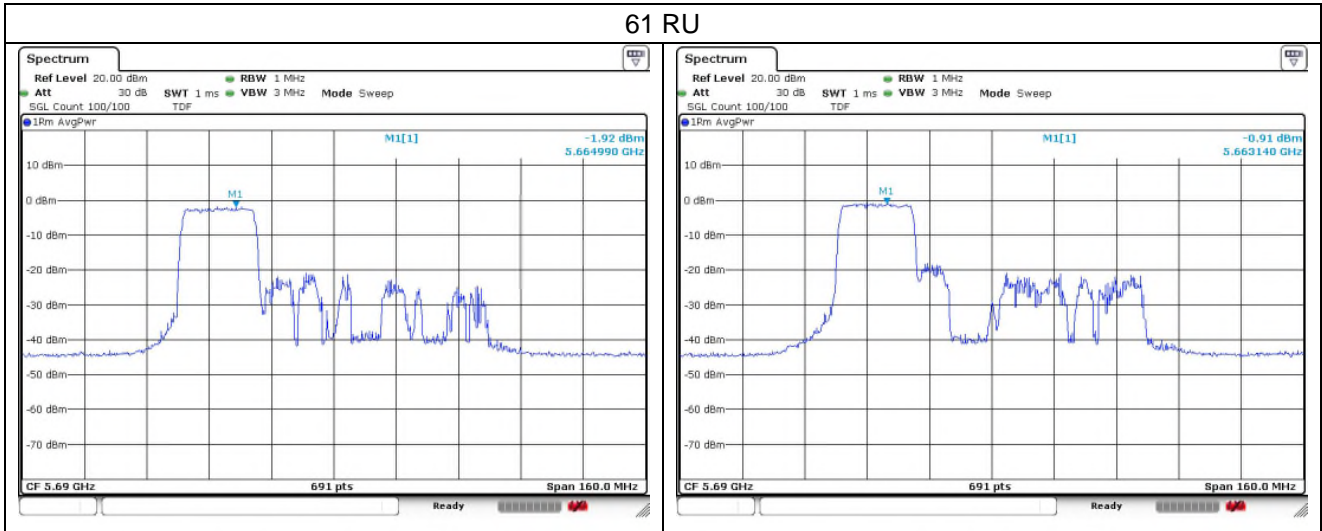

802.11ax\_HE80 Band 2C\_Straddle channel 242T

Ant.1

Ant.2

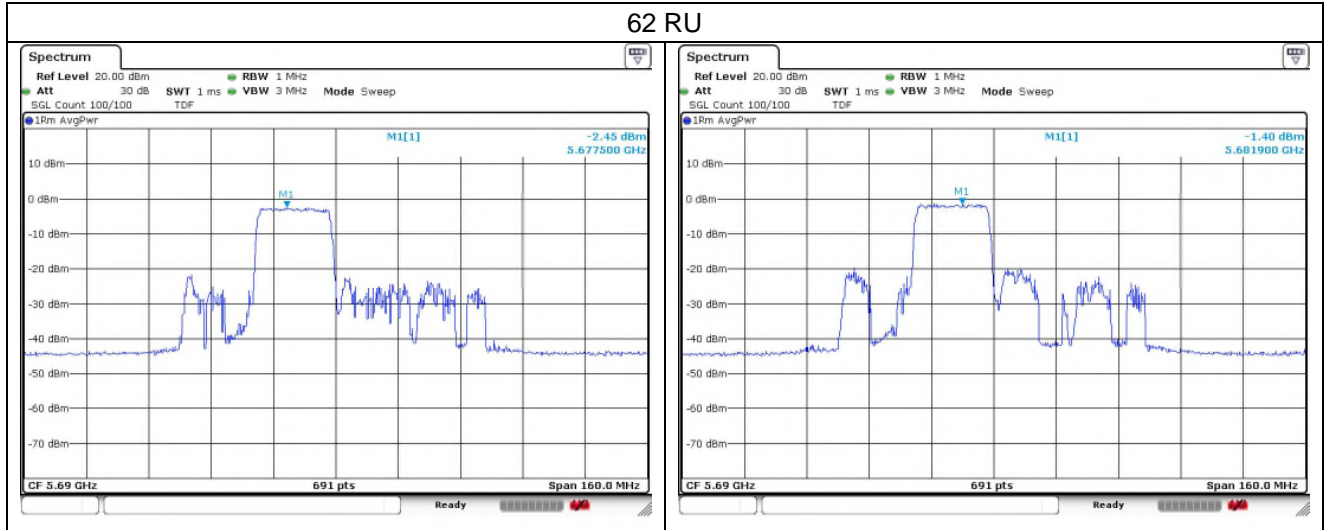

802.11ax\_HE80 Band 2C\_Straddle channel\_242T

Ant.1

Ant.2

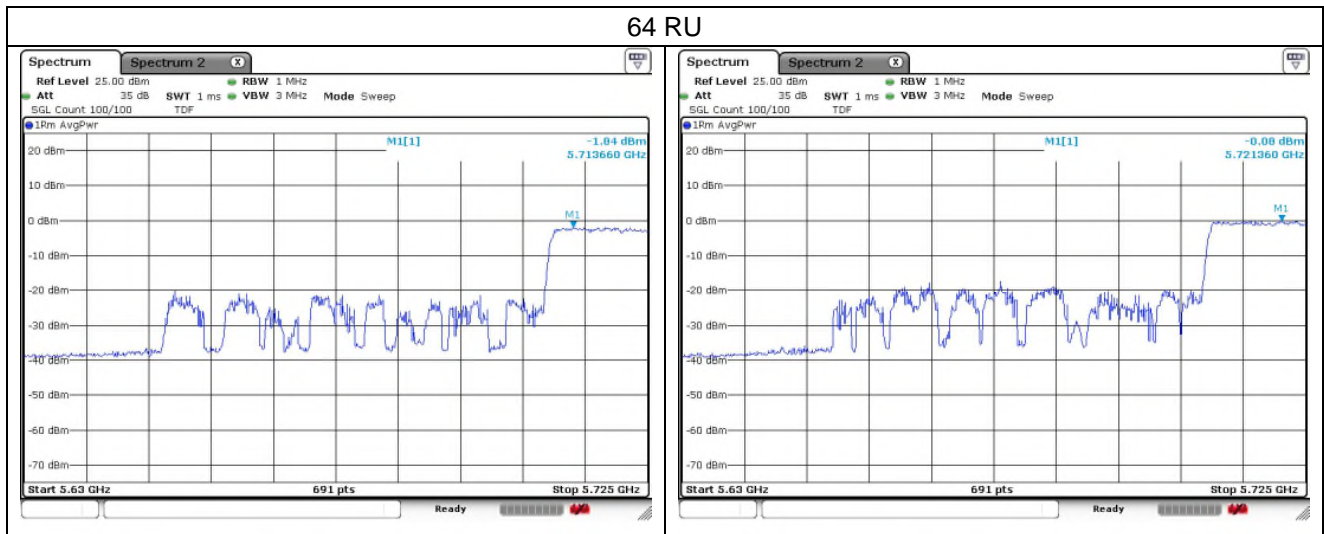

**802.11ax\_HE80 Band 3\_Straddle channel\_242T**

**Ant.1**

**Ant.2**

64 RU

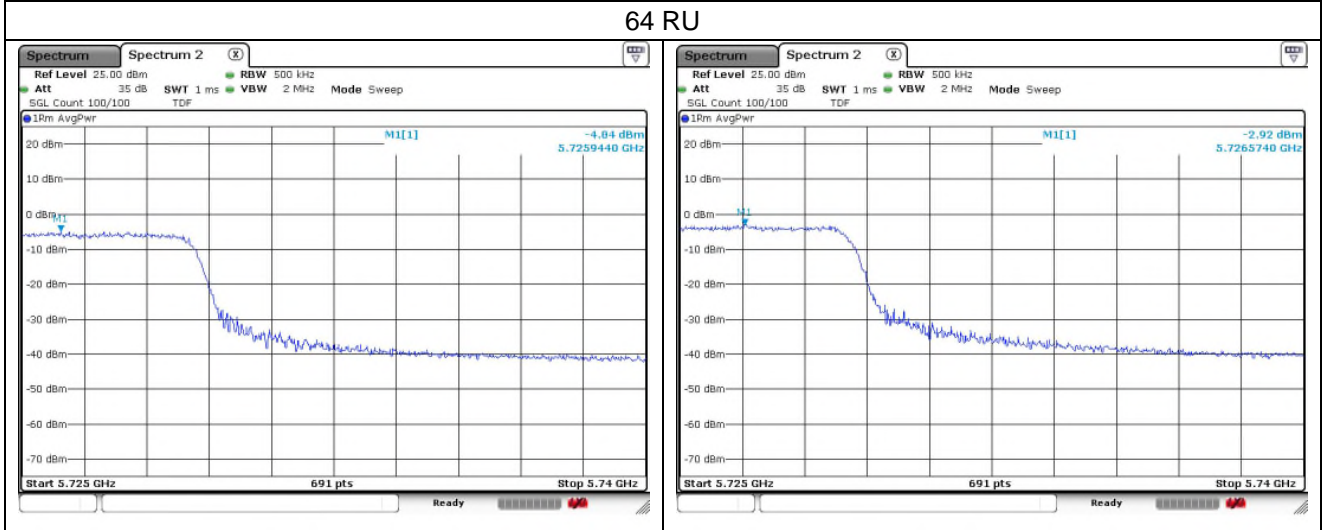

**802.11ax\_HE80 Band 2C\_Straddle channel\_484T**

**Ant.1**

**Ant.2**

65 RU

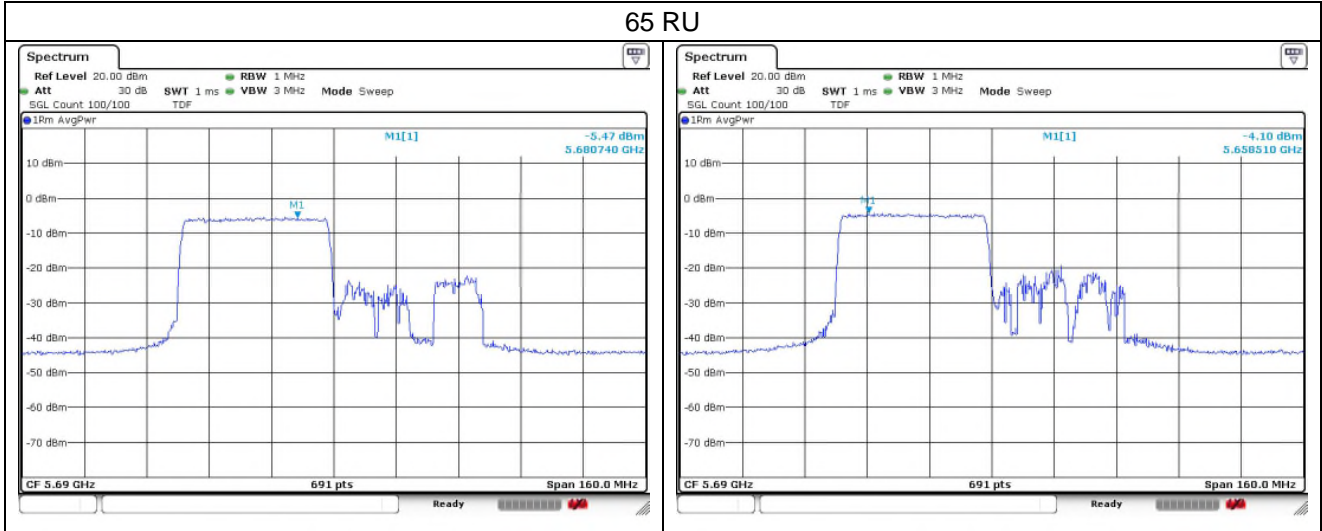

**802.11ax\_HE80 Band 2C\_Straddle channel\_484T**

**Ant.1**

**Ant.2**

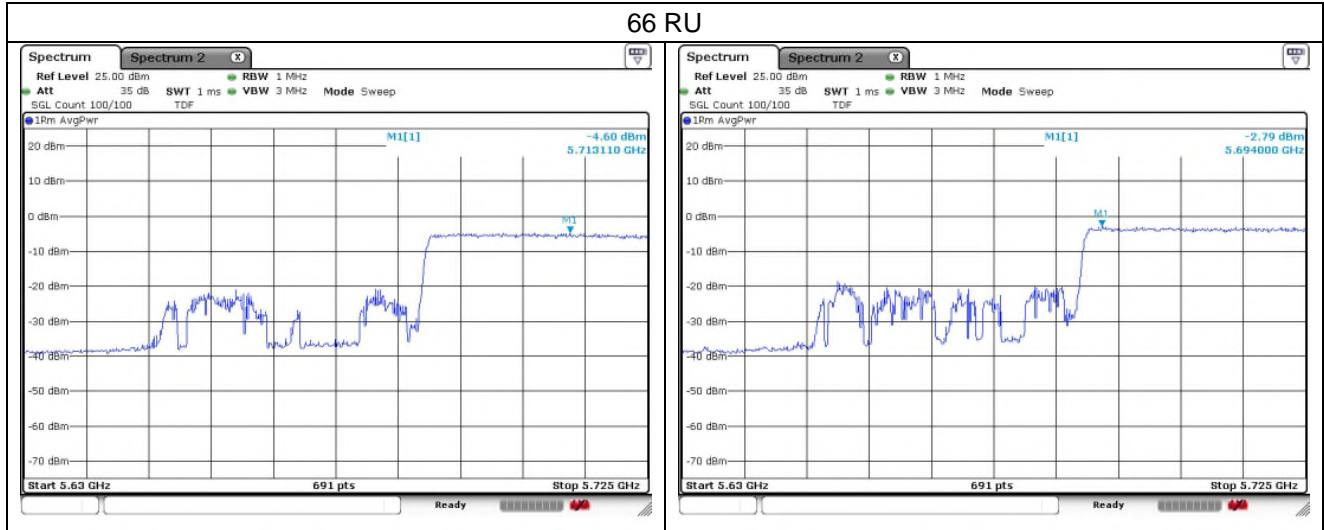

**802.11ax\_HE80 Band 3\_Straddle channel\_484T**

**Ant.1**

**Ant.2**

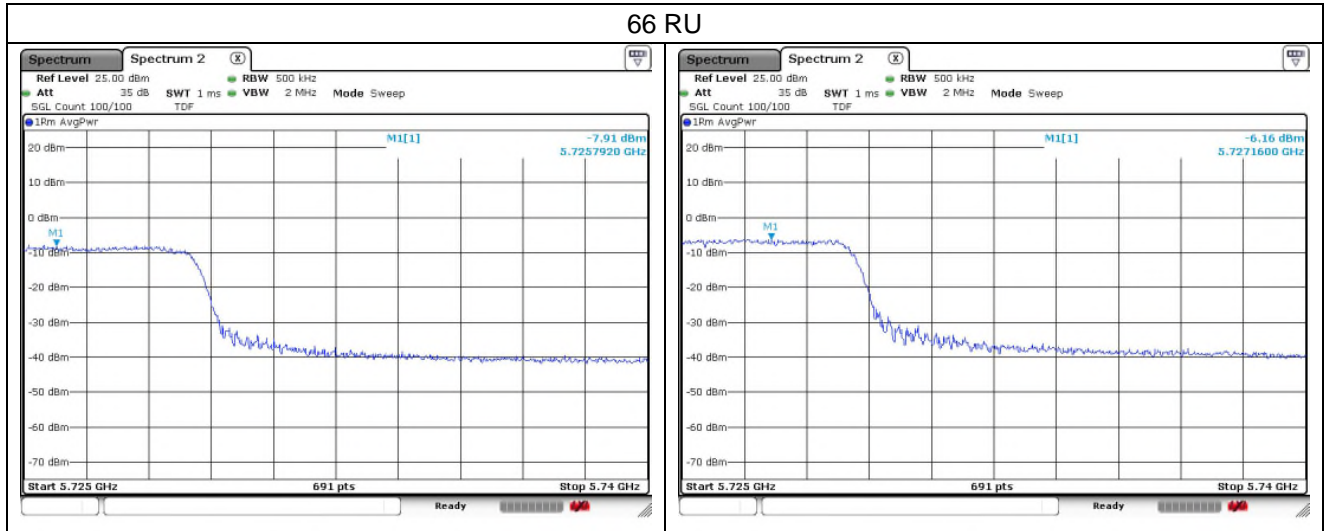



**802.11ax\_HE80 Band 2C\_Straddle channel\_SU**

**Ant.1**

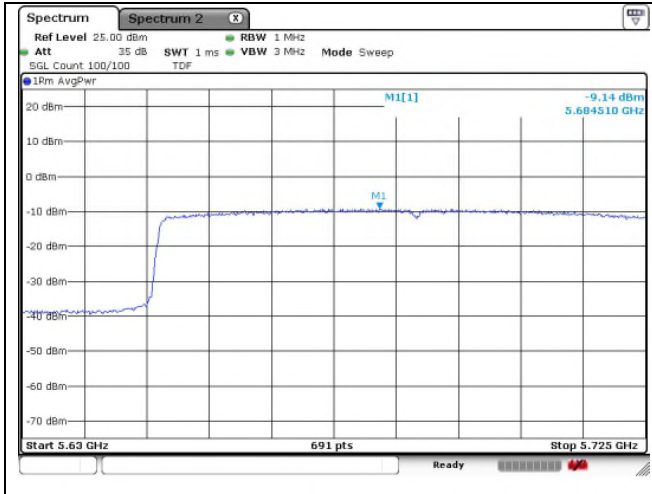

**Ant.2**

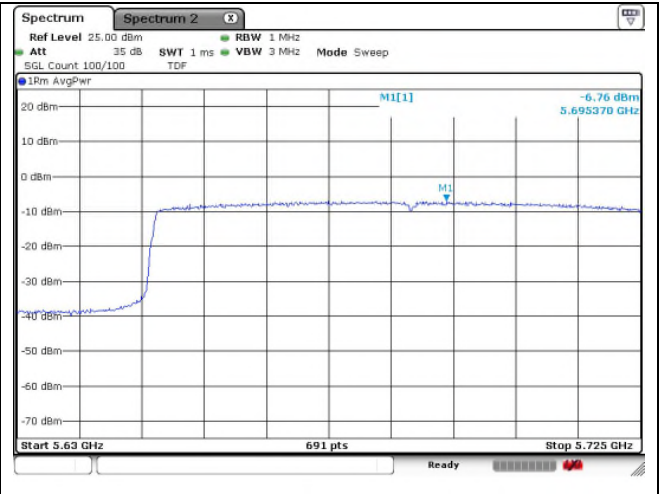

**802.11ax\_HE80 Band 3\_Straddle channel\_SU**

**Ant.1**

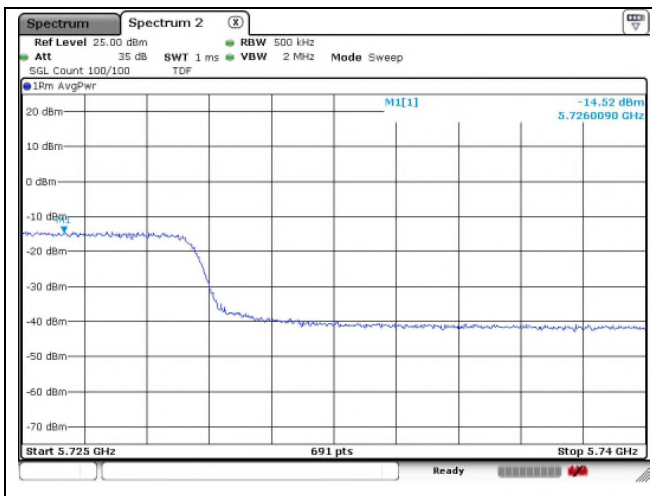

**Ant.2**

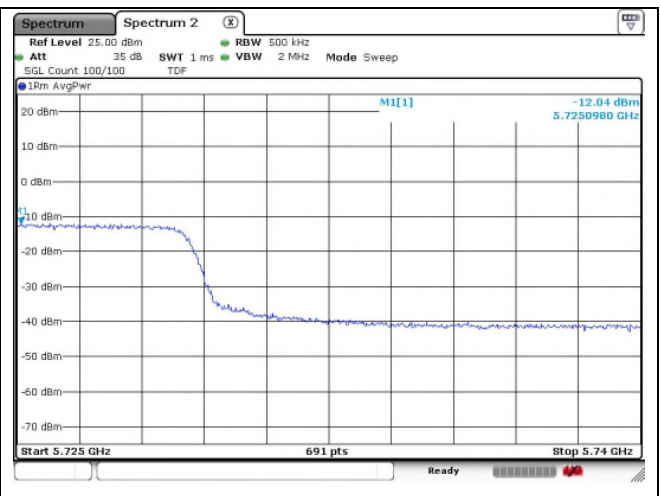

## 7. AC Conducted Power Line Emission

### 7.1. Test Setup

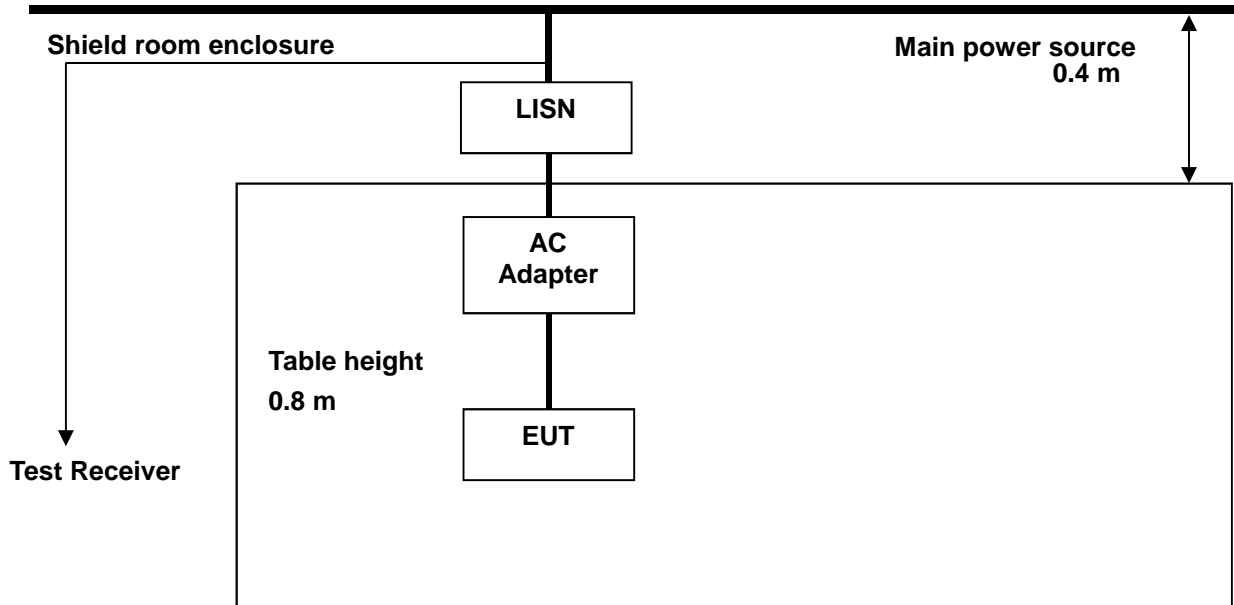

### 7.2. Limit

#### 7.2.1. FCC

According to §15.207(a), for an intentional radiator that is designed to be connected to the public utility (AC) power line, the radio frequency voltage that is conducted back onto the AC power line on any frequency or frequencies, within the band 150 kHz to 30 MHz, shall not exceed the limits in the following table, as measured using a 50 μH / 50 ohms line impedance stabilization network (LISN).

Compliance with the provision of this paragraph shall be based on the measurement of the radio frequency voltage between each power line and ground at the power terminal. The lower limit applies at the boundary between the frequency ranges.

Frequency of emission (MHz)	Conducted limit (dBμV)	
	Quasi-peak	Average
0.15-0.5	66 to 56*	56 to 46*
0.5-5	56	46
5-30	60	50

\* Decreases with the logarithm of the frequency.

**7.2.2. IC**

RSS-Gen Issue 5, 8.8, Unless stated otherwise in the applicable RSS, for radio apparatus that are designed to be connected to the public utility AC power network, the radio frequency voltage that is conducted back onto the AC power line on any frequency or frequencies within the range 150 kHz to 30 MHz shall not exceed the limits in table 4, as measured using a 50  $\mu$  H / 50  $\Omega$  line impedance stabilization network. This requirement applies for the radio frequency voltage measured between each power line and the ground terminal of each AC power-line mains cable of the EUT.

For an EUT that connects to the AC power lines indirectly, through another device, the requirement for compliance with the limits in table 4 shall apply at the terminals of the AC power-line mains cable of a representative support device, while it provides power to the EUT. The lower limit applies at the boundary between the frequency ranges. The device used to power the EUT shall be representative of typical applications.

**Table 4 - AC power-line conducted emissions limits**

Frequency (MHz)	Conducted limit (dB $\mu$ V)	
	Quasi-peak	Average
0.15-0.5	66 to 56 <sup>1</sup>	56 to 46 <sup>1</sup>
0.5-5	56	46
5-30	60	50

**Note 1:** The level decreases linearly with the logarithm of the frequency.

For an EUT with a permanent or detachable antenna operating between 150 kHz and 30 MHz, the AC power-line conducted emissions must be measured using the following configurations:

- (a) Perform the AC power-line conducted emissions test with the antenna connected to determine compliance with the limits of table 4 outside the transmitter's fundamental emission band.
- (b) Retest with a dummy load instead of the antenna to determine compliance with the limits of table 4 within the transmitter's fundamental emission band. For a detachable antenna, remove the antenna and connect a suitable dummy load to the antenna connector. For a permanent antenna, remove the antenna and terminate the RF output with a dummy load or network that simulates the antenna in the fundamental frequency band.

### 7.3. Test Procedures

AC conducted emissions from the EUT were measured according to the dictates of ANSI C63.10-2013

1. The test procedure is performed in a 6.5 m × 3.5 m × 3.5 m (L × W × H) shielded room. The EUT along with its peripherals were placed on a 1.0 m (W) × 1.5 m (L) and 0.8 m in height wooden table and the EUT was adjusted to maintain a 0.4 meter space from a vertical reference plane.
2. The EUT was connected to power mains through a line impedance stabilization network (LISN) which provides 50 ohm coupling impedance for measuring instrument and the chassis ground was bounded to the horizontal ground plane of shielded room.
3. All peripherals were connected to the second LISN and the chassis ground also bounded to the horizontal ground plane of shielded room.
4. The excess power cable between the EUT and the LISN was bundled. The power cables of peripherals were unbundled. All connecting cables of EUT and peripherals were moved to find the maximum emission.

### 7.4. Test Results

The following table shows the highest levels of conducted emissions on both phase of Hot and Neutral line.

Ambient temperature : (23 ± 1) °C  
 Relative humidity : 47 % R.H.  
 Frequency range : 0.15 MHz - 30 MHz  
 Measured Bandwidth : 9 kHz

FREQ. (MHz)	LEVEL (dB $\mu$ V)		LINE	LIMIT (dB $\mu$ V)		MARGIN (dB)	
	Q-Peak	Average		Q-Peak	Average	Q-Peak	Average
0.16	49.40	35.20	N	65.46	55.46	16.06	20.26
0.70	36.30	28.60	N	56.00	46.00	19.70	17.40
1.63	31.80	17.60	N	56.00	46.00	24.20	28.40
4.09	41.90	24.40	N	56.00	46.00	14.10	21.60
8.70	39.30	24.80	N	60.00	50.00	20.70	25.20
13.10	45.60	30.80	N	60.00	50.00	14.40	19.20
0.16	48.80	35.70	H	65.46	55.46	16.66	19.76
0.70	39.40	35.50	H	56.00	46.00	16.60	10.50
1.80	34.10	23.90	H	56.00	46.00	21.90	22.10
4.13	41.10	25.70	H	56.00	46.00	14.90	20.30
8.76	36.50	23.50	H	60.00	50.00	23.50	26.50
13.17	42.10	28.80	H	60.00	50.00	17.90	21.20

**Remark;**

1. Line (H): Hot, Line (N): Neutral.
2. All data rates and modes of operation were investigated and the worst-case emissions were reported using **11ax MIMO(Band 2A) / Middled channel / 242T / 61 RU.**
3. The limit for Class B device(s) from 150 kHz to 30 MHz are specified in Section of the Title 47 CFR.
4. Traces shown in plot were made by using a peak detector and average detector.
5. Deviations to the Specifications: None.

### - Test plots

Test mode: (Neutral)

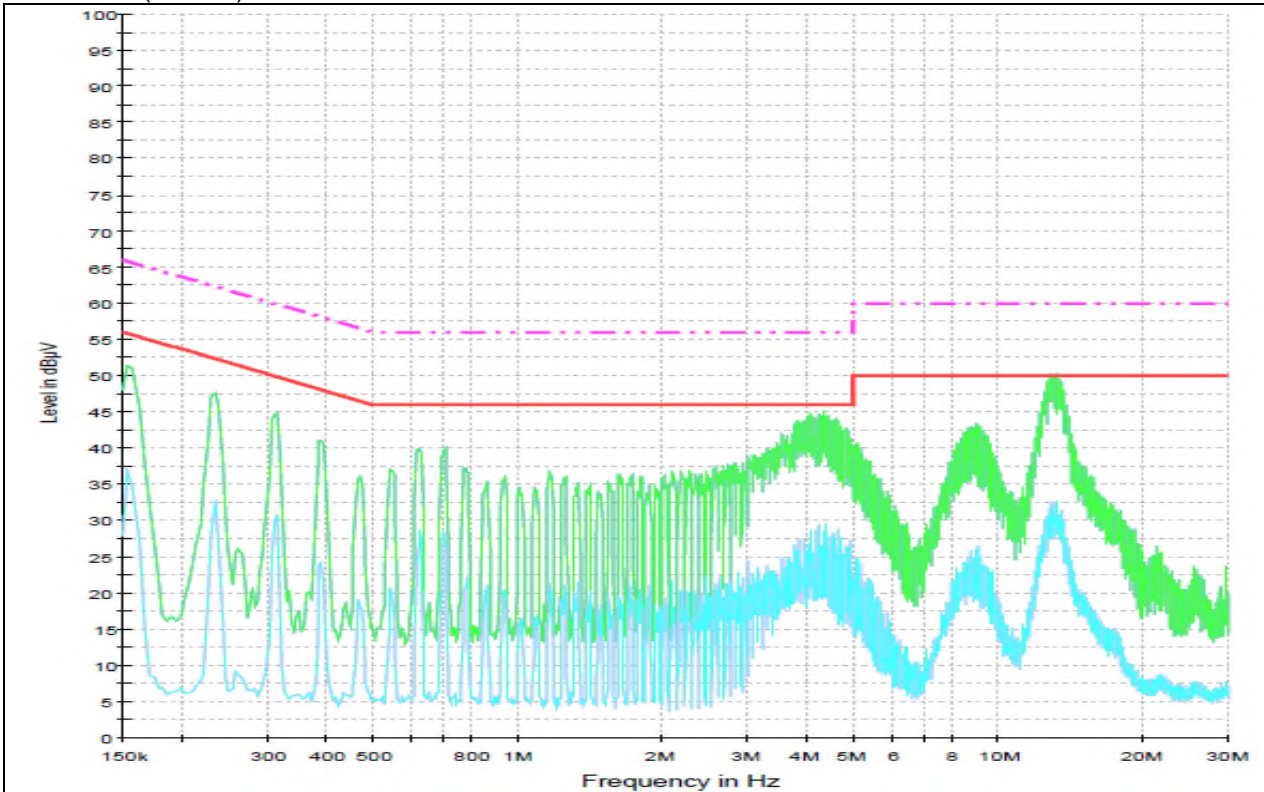

Test mode: (Hot)

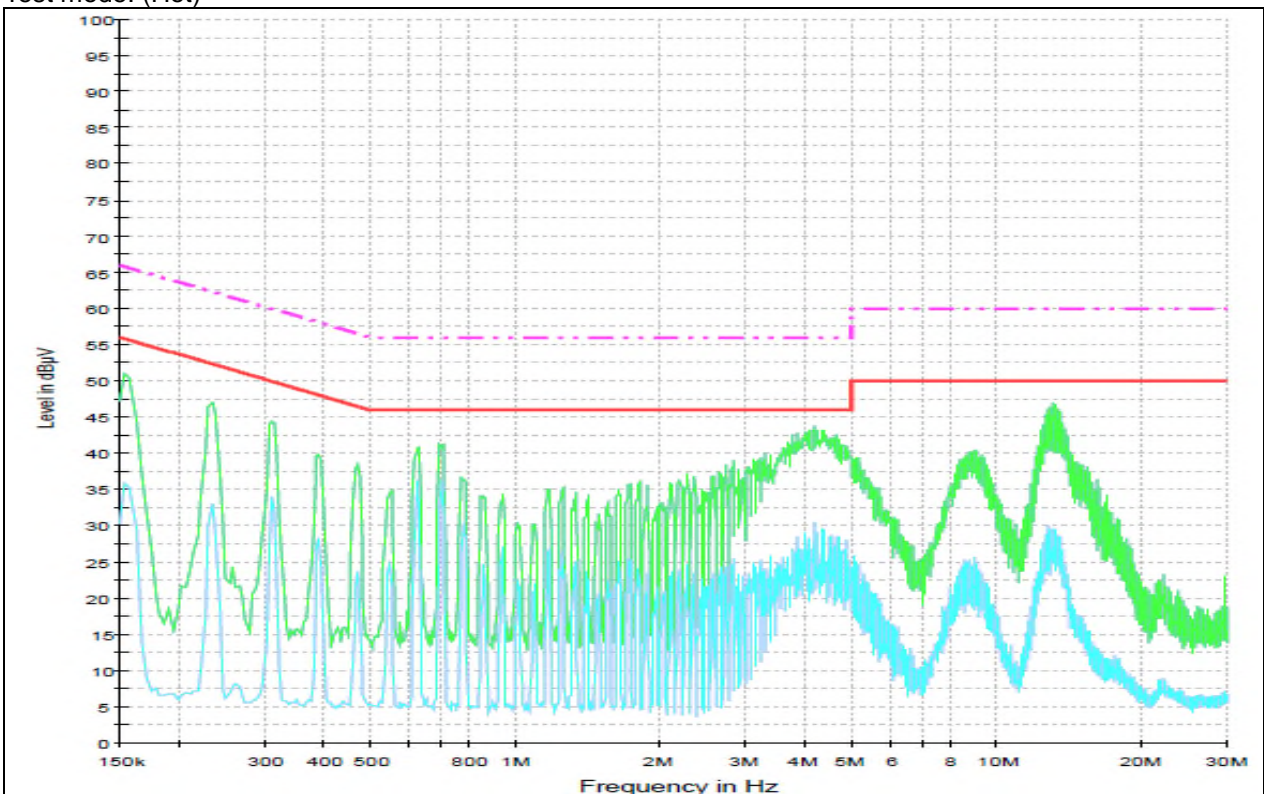

## 8. Antenna Requirement

### 8.1. Standard Applicable

For intentional device, according to FCC 47 CFR Section §15.203, an intentional radiator shall be designed to ensure that no antenna other than that furnished by the responsible party shall be used with the device. And according to FCC 47 CFR Section §15.407(a) if transmitting antennas of directional gain greater than 6 dBi are used, the power shall be reduced by the amount in dBi that the gain of the antenna exceeds 6 dBi.

### 8.2. Antenna Connected Construction

Antenna used in this product is Pattern antenna and peak max gain of antenna as below.

Band	5 150 MHz ~ 5 250 MHz	5 250 MHz ~ 5 350 MHz	5 470 MHz ~ 5 725 MHz	5 725 MHz ~ 5 850 MHz
Mode	11ax_HE20, 11ax_HE80, 11ax_HE80			
Ant.1 Gain	-6.20 dBi	-5.30 dBi	-4.20 dBi	-4.35 dBi
Ant.2 Gain	-7.20 dBi	-6.80 dBi	-6.90 dBi	-7.90 dBi
Ant.1 + Ant.2 Gain	-3.68 dBi	-3.01 dBi	-2.44 dBi	-2.93 dBi

Unequal antenna gains, with equal transmit powers. For antenna gains given by  $G_1, G_2, \dots, G_N$  dBi

- (i) If transmit signals are correlated, then  
 Directional gain =  $10 \log\left[\frac{(10^{G_1/20} + 10^{G_2/20} + \dots + 10^{G_N/20})^2}{N_{ANT}}\right]$  dBi [Note the "20"s in the denominator of each exponent and the square of the sum of terms; the object is to combine the signal levels coherently.]

**- End of the Test Report -**