

11.3.5. TX ABOVE 1GHz 802.11a 2Tx CDD MODE IN THE STRADDLE CHANNEL

STRADDLE CHANNEL HORIZONTAL

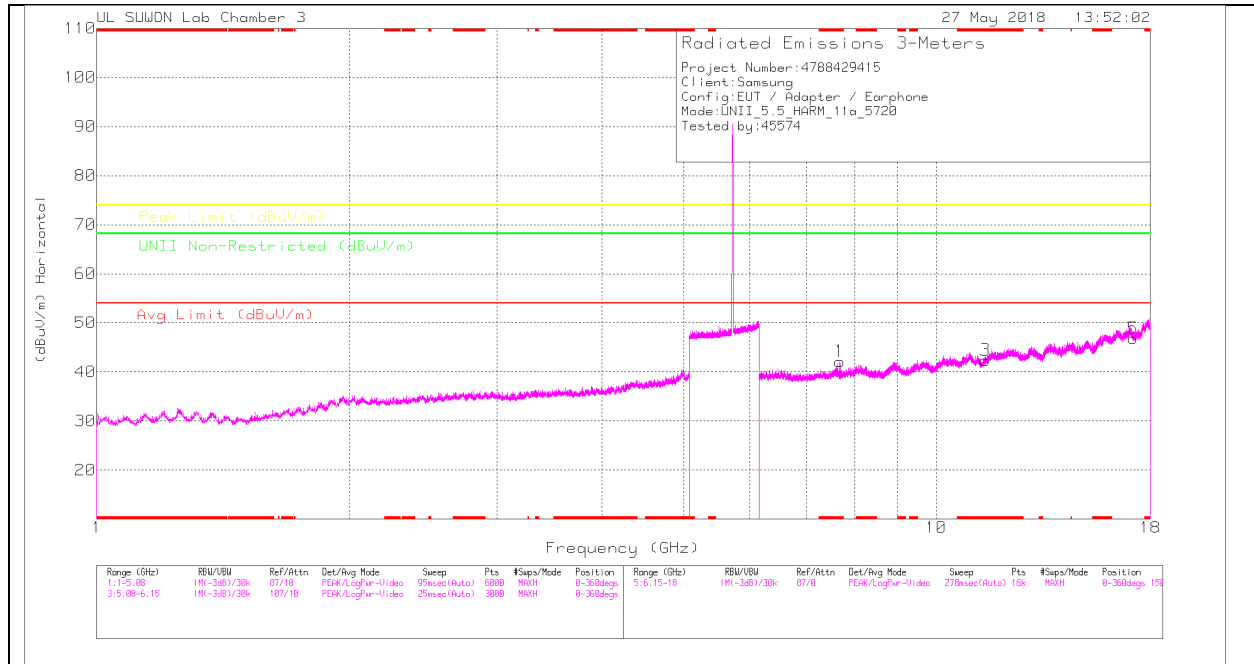

STRADDLE CHANNEL VERTICAL

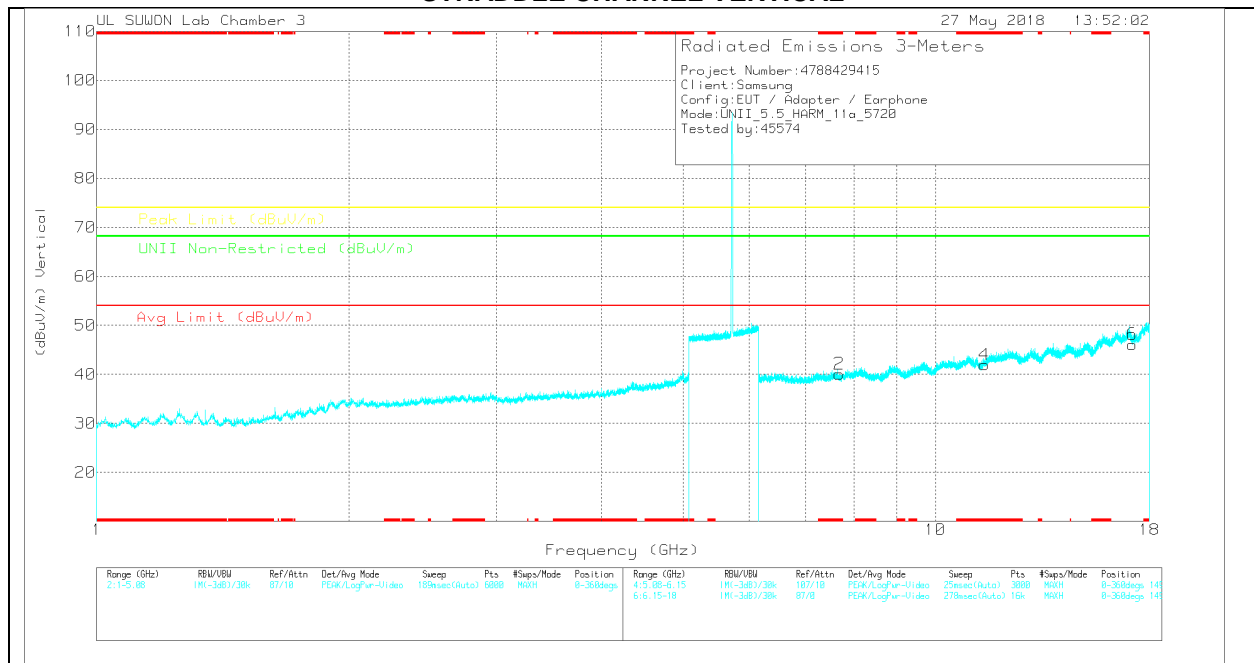

Note: Emission was scanned up to 40GHz; No emissions were detected above the noise floor which was at least 20dB below the specification limit.

STRADDLE CHANNEL DATA

Trace Markers

Marker	Frequency (GHz)	Meter Reading (dBuV)	Det	3117(0020959)	@GHz_HF(dB)	DC Corr (dB)	Corrected Reading (dBuV/m)	Avg Limit (dBuV/m)	Margin (dB)	Peak Limit (dBuV/m)	Margin (dB)	Limit Non-Restricted (dBuV/m)	Margin (dB)	Azimuth (Degs)	Height (cm)	Polarity
1	* 7.679	29.84	PK	35.6	-23.3	0	42.14	-	-	74	-31.86	-	-	0-360	250	H
3	* 11.441	24	PK	38	-19.6	0	42.4	-	-	74	-31.6	-	-	0-360	150	H
5	17.161	21.93	PK	40.9	-16	0	46.83	-	-	-	-	68.2	-21.37	0-360	250	H
2	* 7.679	27.8	PK	35.6	-23.3	0	40.1	-	-	74	-33.9	-	-	0-360	250	V
4	* 11.441	23.53	PK	38	-19.6	0	41.93	-	-	74	-32.07	-	-	0-360	149	V
6	17.161	21.23	PK	40.9	-16	0	46.13	-	-	-	-	68.2	-22.07	0-360	149	V

* - indicates frequency in CFR47 Pt 15 / IC RSS-Restricted Band
 PK – Peak Detector

Radiated Emissions

Frequency (GHz)	Meter Reading (dBuV)	Det	3117(0020959)	@GHz_HF(dB)	DC Corr (dB)	Corrected Reading (dBuV/m)	Avg Limit (dBuV/m)	Margin (dB)	Peak Limit (dBuV/m)	Margin (dB)	Limit Non-Restricted (dBuV/m)	Margin (dB)	Azimuth (Degs)	Height (cm)	Polarity
* 7.689	34	PK-U	35.6	-23.4	0	46.2	-	-	74	-27.8	-	-	111	235	H
* 7.68	27.13	ADR	35.6	-23.3	.12	39.55	54	-14.45	-	-	-	-	111	235	H

* - indicates frequency in CFR47 Pt 15 / IC RSS-Restricted Band
 PK-U - U-NII: Maximum Peak
 ADR - U-NII AD primary method, RMS average

11.3.6.TX ABOVE 1GHz 802.11n HT20 2Tx CDD MODE IN THE STRADDLE CHANNEL

STRADDLE CHANNEL HORIZONTAL

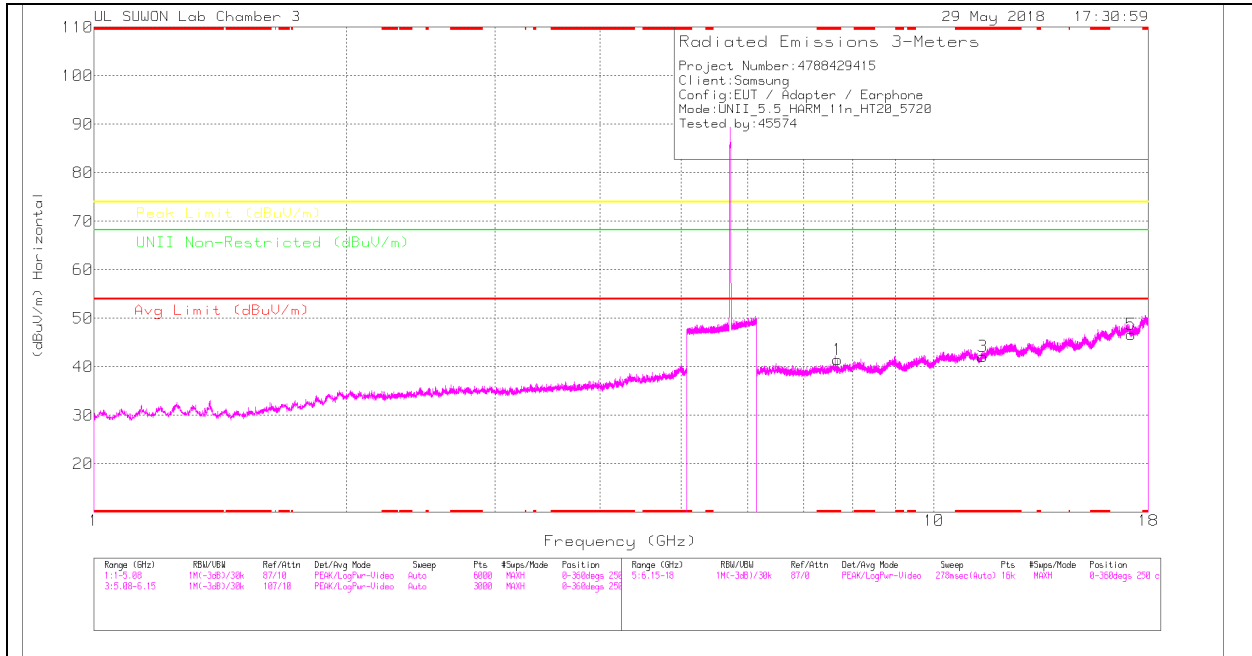

STRADDLE CHANNEL VERTICAL

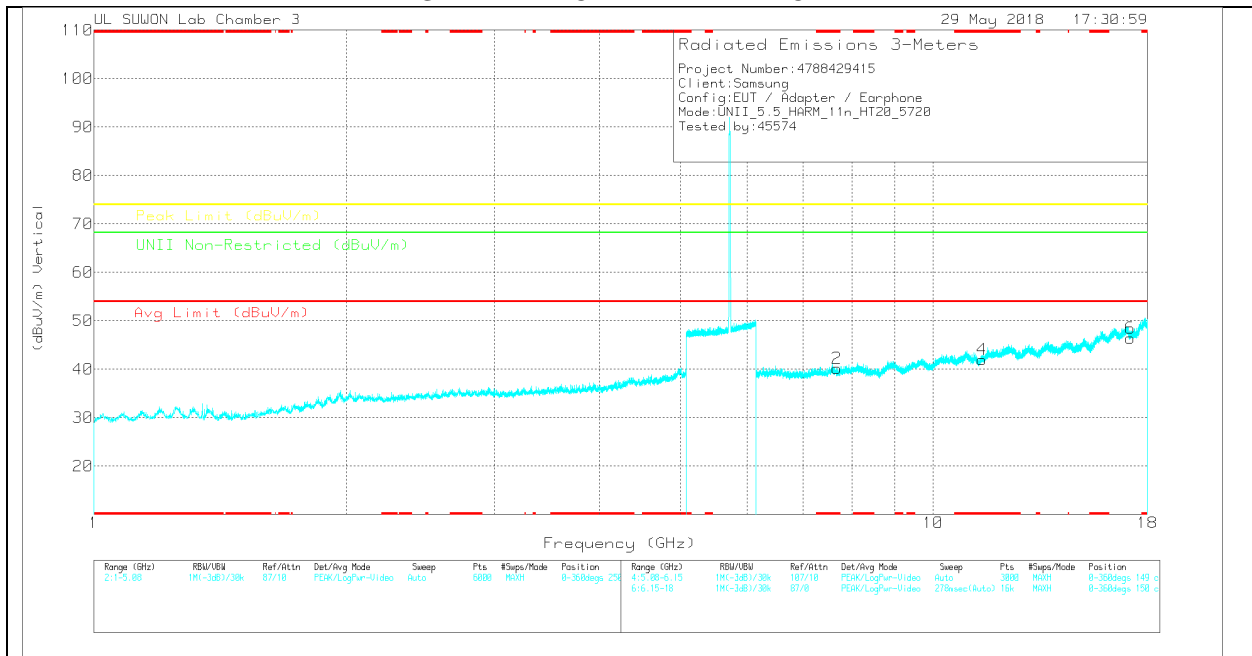

Note: Emission was scanned up to 40GHz; No emissions were detected above the noise floor which was at least 20dB below the specification limit.

STRADDLE CHANNEL DATA

Trace Markers

Marker	Frequency (GHz)	Meter Reading (dBuV)	Det	3117(0205959)	4GHz_HF(dB)	DC Corr (dB)	Corrected Reading (dBuV/m)	Avg Limit (dBuV/m)	Margin (dB)	Peak Limit (dBuV/m)	Margin (dB)	Limit Non-Restricted (dBuV/m)	Margin (dB)	Azimuth (Degs)	Height (cm)	Polarity
1	*7.679	29.17	PK	35.6	-23.3	0	41.47	-	-	74	-32.53	-	-	0-360	150	H
3	*11.44	23.78	PK	38	-19.6	0	42.18	-	-	74	-31.82	-	-	0-360	250	H
5	17.161	21.73	PK	40.9	-16	0	46.63	-	-	-	-	68.2	-21.57	0-360	150	H
2	*7.679	27.89	PK	35.6	-23.3	0	40.19	-	-	74	-33.81	-	-	0-360	150	V
4	*11.44	23.55	PK	38	-19.6	0	41.95	-	-	74	-32.05	-	-	0-360	250	V
6	17.161	21.5	PK	40.9	-16	0	46.4	-	-	-	-	68.2	-21.8	0-360	150	V

* - indicates frequency in CFR47 Pt 15 / IC RSS-Restricted Band
 PK – Peak Detector

Note: Only peak measurement was performed. Because peak measurement result of unwanted emission is less than average limit (54dBuV/m).

11.3.7. TX ABOVE 1GHz 802.11n HT40 2Tx CDD MODE IN THE STRADDLE CHANNEL

STRADDLE CHANNEL HORIZONTAL

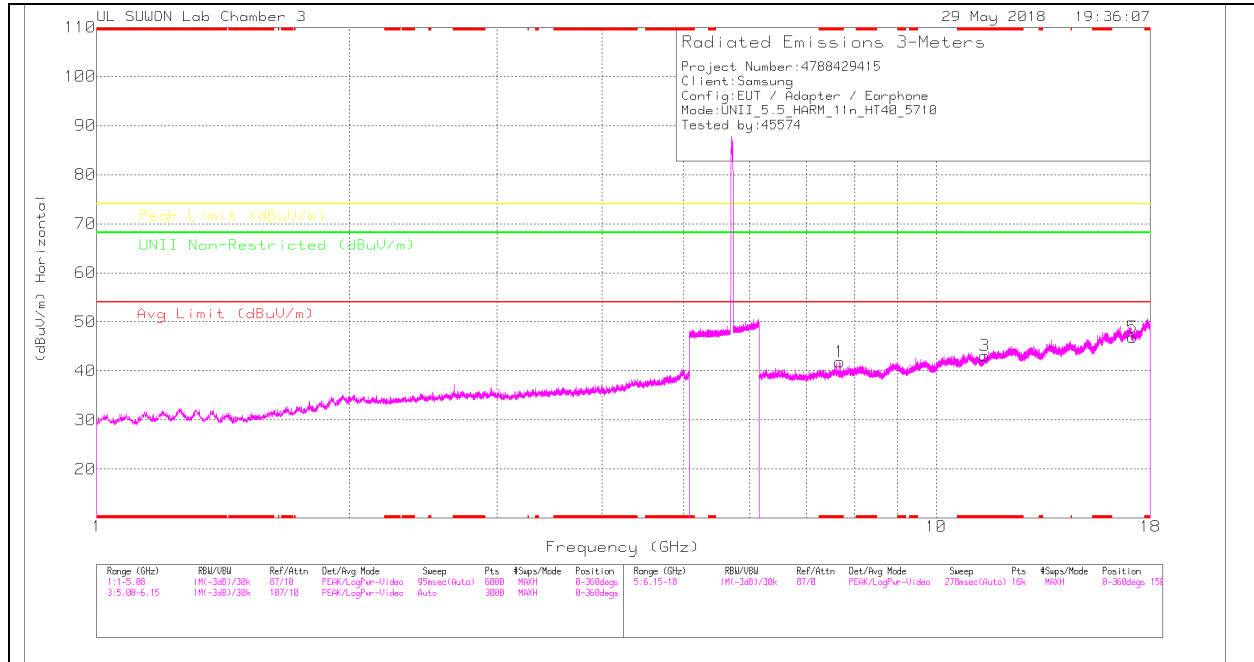

STRADDLE CHANNEL VERTICAL

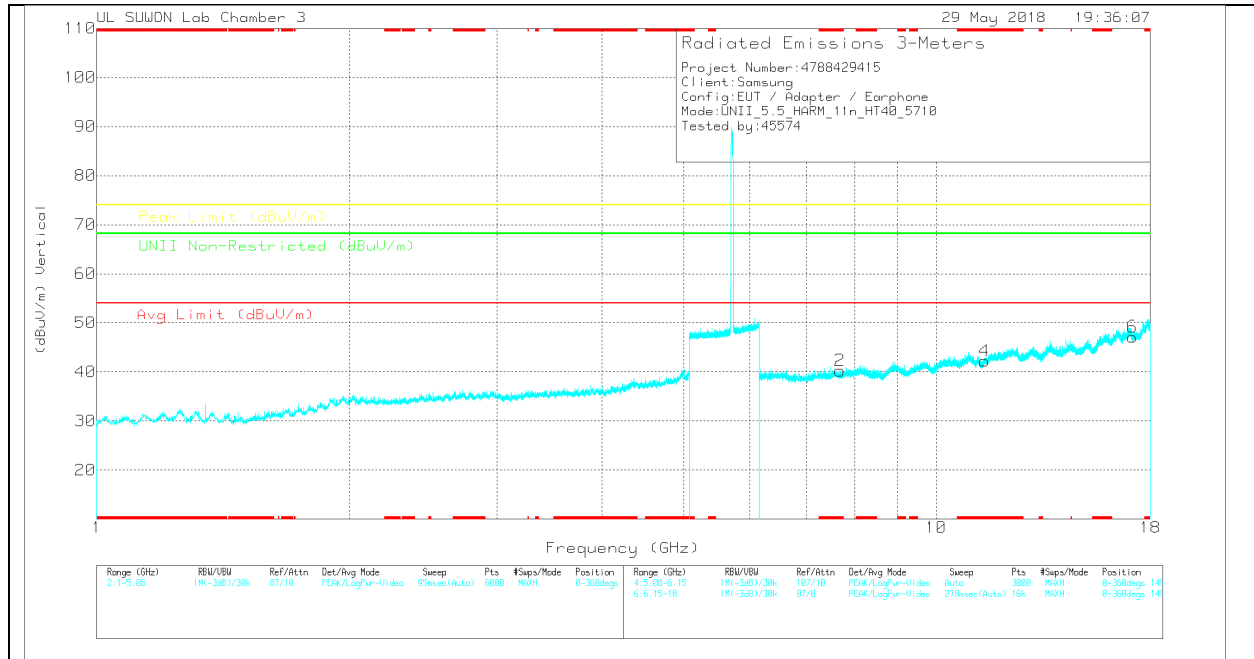

Note: Emission was scanned up to 40GHz; No emissions were detected above the noise floor which was at least 20dB below the specification limit.

STRADDLE CHANNEL DATA

Trace Markers

Marker	Frequency (GHz)	Meter Reading (dBuV)	Det	3117(0020959)	@GHz_HF(dB)	DC Corr (dB)	Corrected Reading (dBuV/m)	Avg Limit (dBuV/m)	Margin (dB)	Peak Limit (dBuV/m)	Margin (dB)	Limit Non-Restricted (dBuV/m)	Margin (dB)	Asimuth (Degs)	Height (cm)	Polarity
1	* 7.679	29.54	PK	35.6	-23.3	0	41.84	-	-	74	-32.16	-	-	0-360	150	H
3	* 11.421	24.85	PK	38	-19.7	0	43.15	-	-	74	-30.85	-	-	0-360	251	H
5	17.13	22.06	PK	40.9	-16.1	0	46.86	-	-	-	-	68.2	-21.34	0-360	251	H
2	* 7.679	27.96	PK	35.6	-23.3	0	40.26	-	-	74	-33.74	-	-	0-360	149	V
4	* 11.42	23.9	PK	38	-19.7	0	42.2	-	-	74	-31.8	-	-	0-360	149	V
6	17.13	22.34	PK	40.9	-16.1	0	47.14	-	-	-	-	68.2	-21.06	0-360	250	V

* - indicates frequency in CFR47 Pt 15 / IC RSS-Restricted Band
 PK – Peak Detector

Radiated Emissions

Frequency (GHz)	Meter Reading (dBuV)	Det	3117(0020959)	@GHz_HF(dB)	DC Corr (dB)	Corrected Reading (dBuV/m)	Avg Limit (dBuV/m)	Margin (dB)	Peak Limit (dBuV/m)	Margin (dB)	Limit Non-Restricted (dBuV/m)	Margin (dB)	Asimuth (Degs)	Height (cm)	Polarity
* 7.69	34.36	PK-U	35.6	-23.4	0	46.56	-	-	74	-27.44	-	-	111	235	H
* 7.68	26.9	ADR	35.6	-23.3	-24	39.44	54	-14.56	-	-	-	-	111	235	H

* - indicates frequency in CFR47 Pt 15 / IC RSS-Restricted Band
 PK-U - U-NII: Maximum Peak
 ADR - U-NII AD primary method, RMS average

11.3.8.TX ABOVE 1GHz 802.11ac VHT80 2Tx CDD MODE IN THE STRADDLE CHANNEL

STRADDLE CHANNEL HORIZONTAL

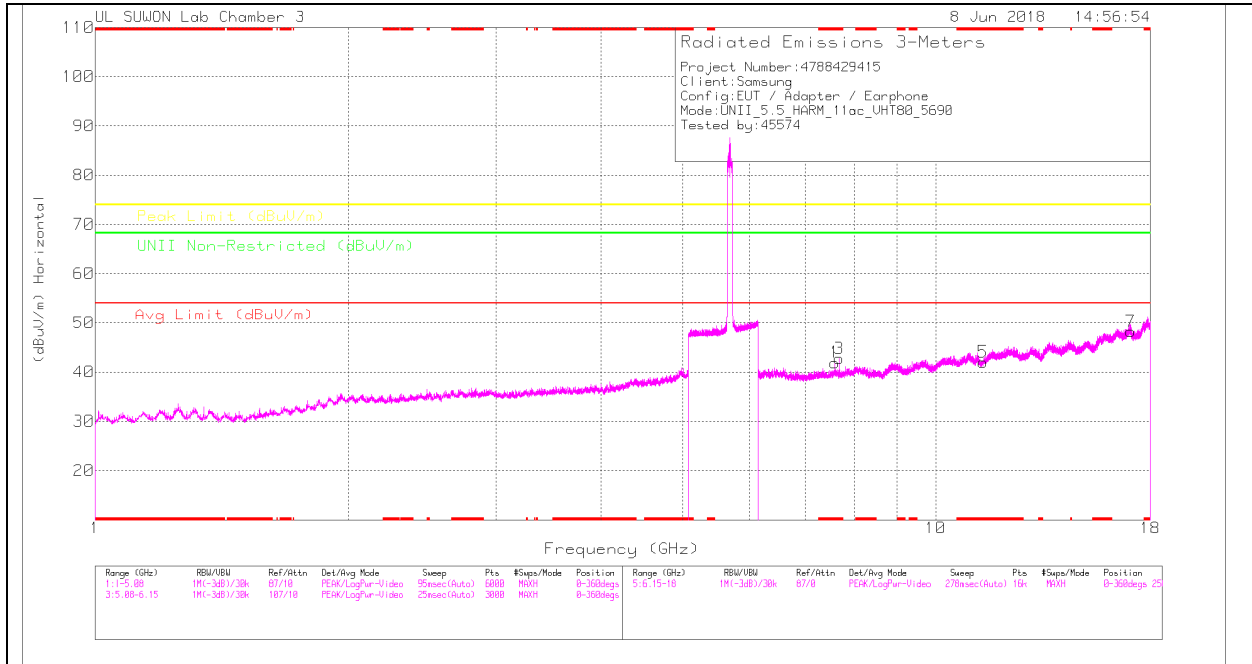

STRADDLE CHANNEL VERTICAL

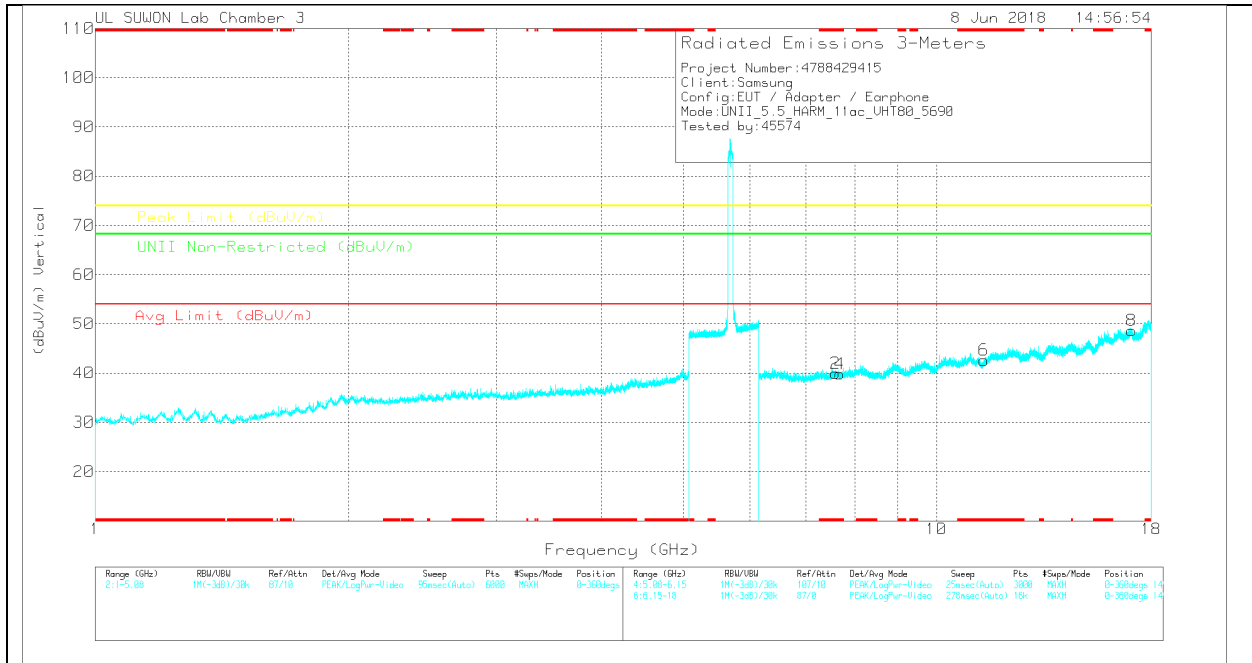

Note: Emission was scanned up to 40GHz; No emissions were detected above the noise floor which was at least 20dB below the specification limit.

STRADDLE CHANNEL DATA

Trace Markers

Marker	Frequency (GHz)	Meter Reading (dBuV)	Det	317(0020959)	6GHz_HF(dB)	DC Corr (dB)	Corrected Reading (dBuV/m)	Avg Limit (dBuV/m)	Margin (dB)	Peak Limit (dBuV/m)	Margin (dB)	UNI Non-Restricted (dBuV/m)	Margin (dB)	Azimuth (Degs)	Height (cm)	Polarity
1	* 7.586	28.54	PK	35.6	-22.2	0	41.94	-	-	74	-32.06	-	-	0-360	150	H
3	* 7.679	30.44	PK	35.6	-23.3	0	42.74	-	-	74	-31.26	-	-	0-360	250	H
5	* 11.381	23.72	PK	38	-19.7	0	42.02	-	-	74	-31.98	-	-	0-360	150	H
7	17.07	23.04	PK	41.1	-15.9	0	48.24	-	-	-	-	68.2	-19.96	0-360	150	H
2	* 7.586	26.56	PK	35.6	-22.2	0	39.96	-	-	74	-34.04	-	-	0-360	250	V
4	* 7.679	27.54	PK	35.6	-23.3	0	39.84	-	-	74	-34.16	-	-	0-360	149	V
6	* 11.381	24.3	PK	38	-19.7	0	42.6	-	-	74	-31.4	-	-	0-360	149	V
8	17.07	23.42	PK	41.1	-15.9	0	48.62	-	-	-	-	68.2	-19.58	0-360	149	V

* - indicates frequency in CFR47 Pt 15 / IC RSS-Restricted Band
 PK – Peak Detector

Radiated Emissions

Frequency (GHz)	Meter Reading (dBuV)	Det	317(0020959)	6GHz_HF(dB)	DC Corr (dB)	Corrected Reading (dBuV/m)	Avg Limit (dBuV/m)	Margin (dB)	Peak Limit (dBuV/m)	Margin (dB)	UNI Non-Restricted (dBuV/m)	Margin (dB)	Azimuth (Degs)	Height (cm)	Polarity
* 7.587	37.34	PK-U	35.6	-22.2	0	50.74	-	-	74	-23.26	-	-	165	159	H
* 7.587	27.64	ADR	35.6	-22.2	.53	41.57	54	-12.43	-	-	-	-	165	159	H
* 7.68	38.2	PK-U	35.6	-23.3	0	50.5	-	-	74	-23.5	-	-	231	195	H
* 7.68	28.93	ADR	35.6	-23.3	.53	41.76	54	-12.24	-	-	-	-	231	195	H

* - indicates frequency in CFR47 Pt 15 / IC RSS-Restricted Band
 PK-U - U-NII: Maximum Peak
 ADR - U-NII AD primary method, RMS average

11.4. 5.8 GHz

11.4.1. TX ABOVE 1GHz 802.11a 2Tx CDD MODE IN THE 5.8GHz BAND

BANDEDGE (LOW CHANNEL)

HORIZONTAL PEAK PLOT

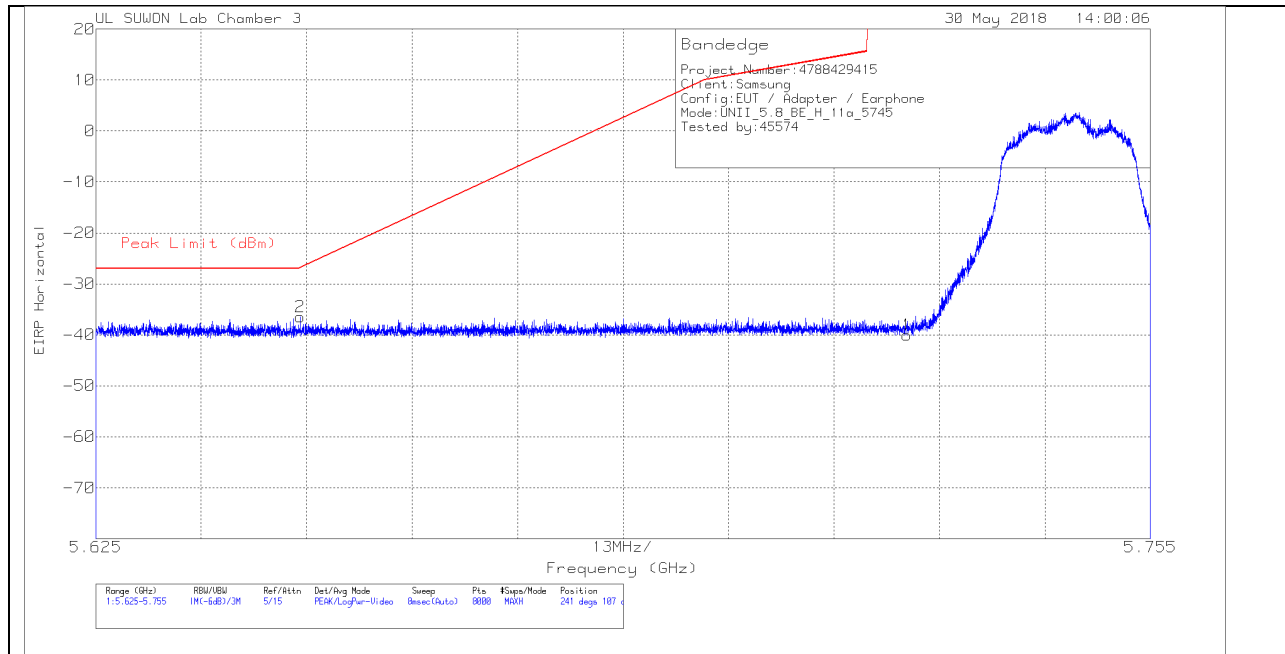

HORIZONTAL DATA

Trace Markers

Marker	Frequency (GHz)	Meter Reading (dBm)	Det	3117[00205959]	10dB_ATT[dB]	Conversion Factor (dB)	Corrected Reading EIRP	Peak Limit (dBm)	PK Margin (dB)	Azimuth (Degs)	Height (cm)	Polarity
1	5.725	-68.58	Pk	34.7	-17.9	11.8	-39.98	278.95	-318.93	241	107	H
2	5.65	-64.68	Pk	34.5	-18.1	11.8	-36.48	-26.85	-9.63	241	107	H

Pk - Peak detector

VERTICAL PEAK PLOT

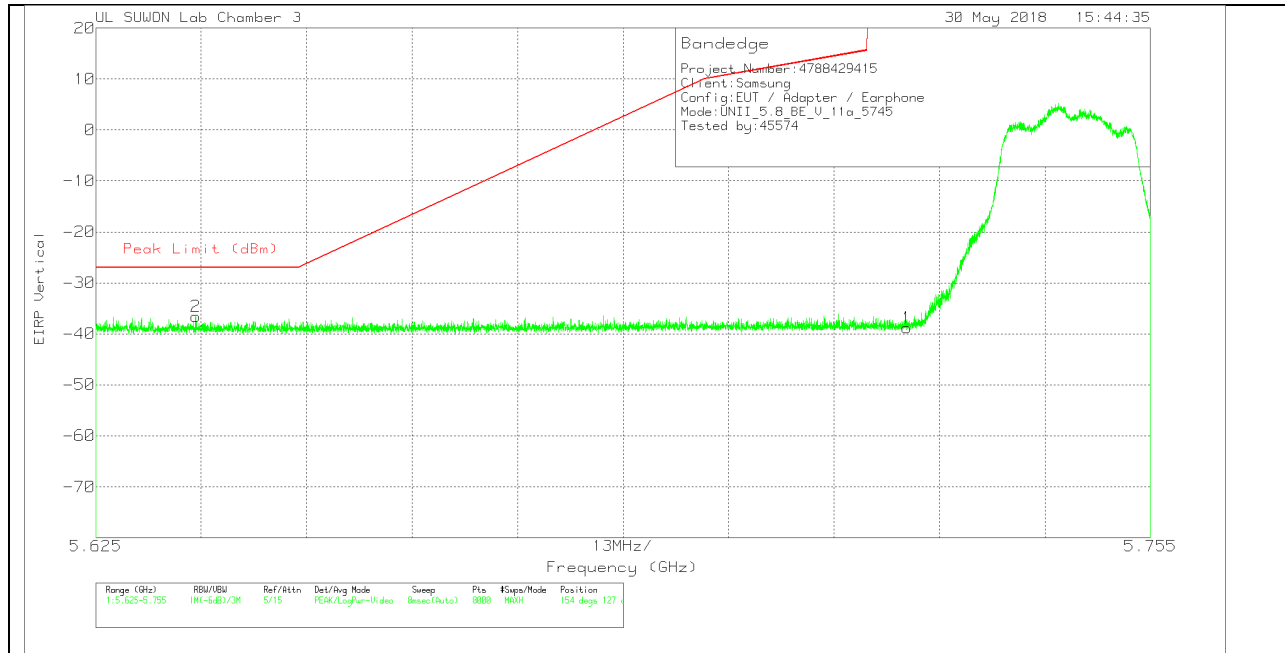

VERTICAL DATA

Trace Markers

Marker	Frequency (GHz)	Meter Reading (dBm)	Det	3117[00205959]	10dB_ATT[dB]	Conversion Factor (dB)	Corrected Reading EIRP	Peak Limit (dBm)	PK Margin (dB)	Azimuth (Degs)	Height (cm)	Polarity
1	5.725	-67.44	Pk	34.7	-17.9	11.8	-38.84	278.95	-317.79	154	127	V
2	5.637	-64.68	Pk	34.5	-18.2	11.8	-36.58	-27	-9.58	154	127	V

Pk - Peak detector

BANDEDGE (HIGH CHANNEL)

HORIZONTAL PEAK PLOT

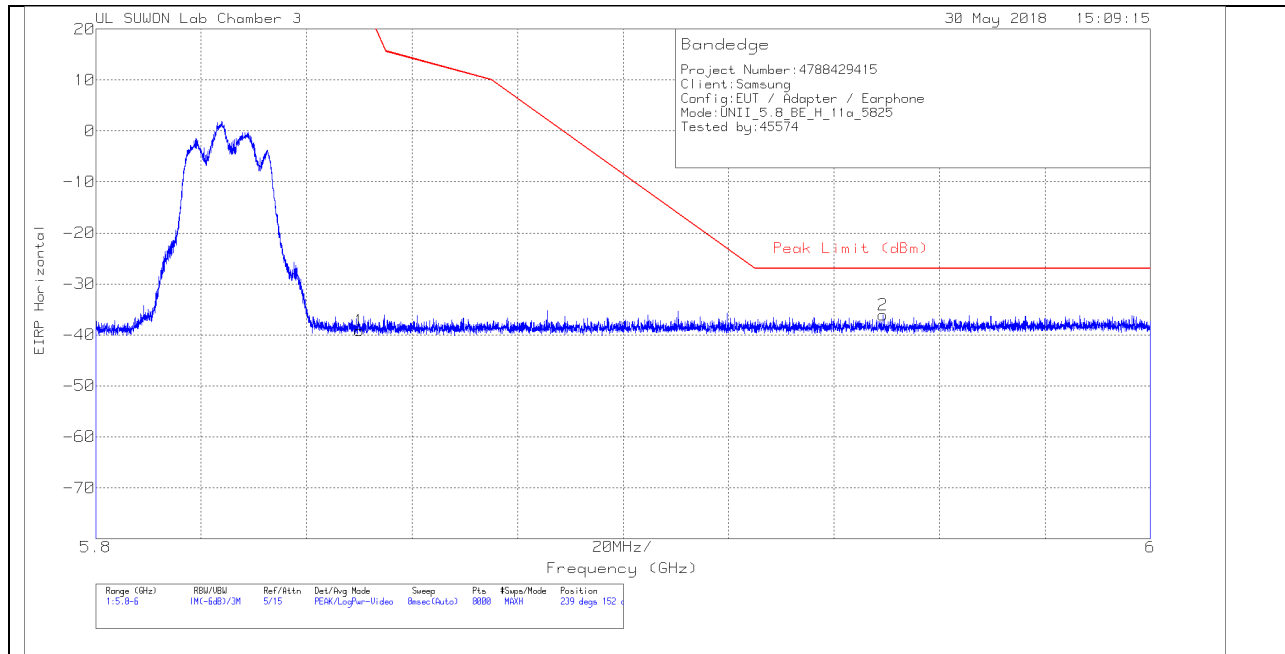

HORIZONTAL DATA

Trace Markers

Marker	Frequency (GHz)	Meter Reading (dBm)	Det	3117[00205959]	10dB_ATT[dB]	Conversion Factor (dB)	Corrected Reading EIRP	Peak Limit (dBm)	PK Margin (dB)	Azimuth (Degs)	Height (cm)	Polarity
1	5.85	-68.22	Pk	34.9	-17.6	11.8	-39.12	26.99	-66.11	239	152	H
2	5.949	-65.44	Pk	35	-17.5	11.8	-36.14	-27	-9.14	239	152	H

Pk - Peak detector

VERTICAL PEAK PLOT

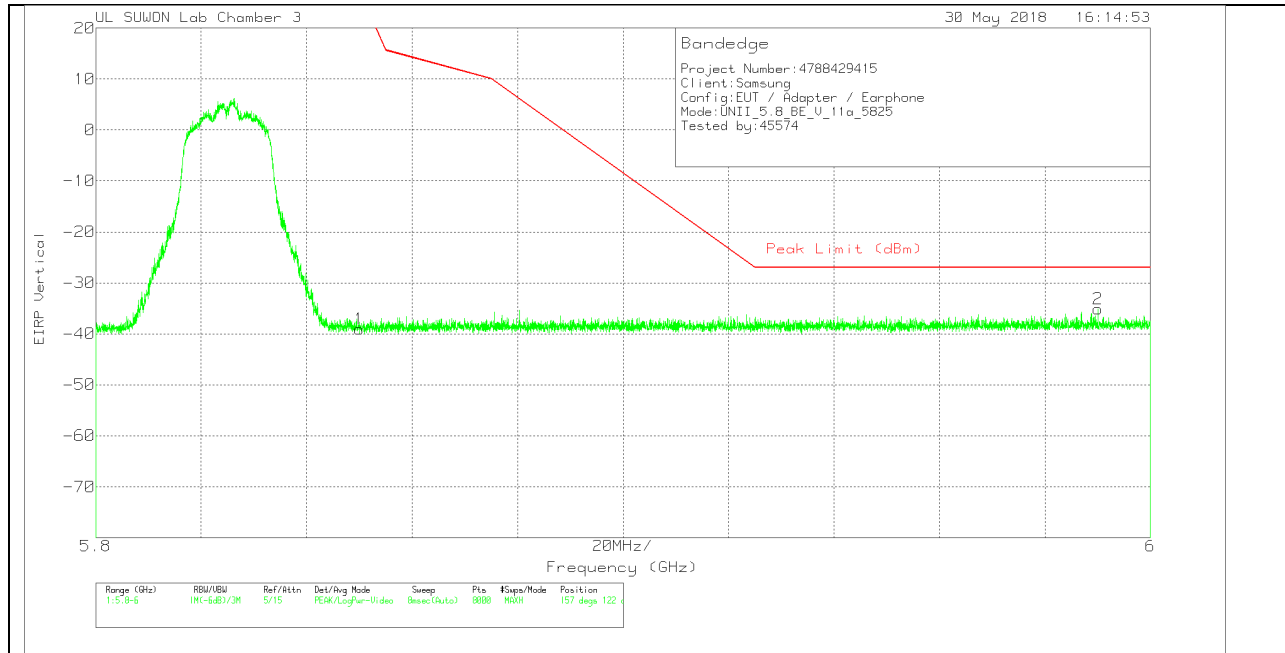

VERTICAL DATA

Trace Markers

Marker	Frequency (GHz)	Meter Reading (dBm)	Det	3117[00205959]	10dB_ATT[dB]	Conversion Factor (dB)	Corrected Reading EIRP	Peak Limit (dBm)	PK Margin (dB)	Azimuth (Degs)	Height (cm)	Polarity
1	5.85	-68.17	Pk	34.9	-17.6	11.8	-39.07	26.99	-66.06	157	122	V
2	5.99	-64.53	Pk	35.1	-17.5	11.8	-35.13	-27	-8.13	157	122	V

Pk - Peak detector

LOW CHANNEL HORIZONTAL

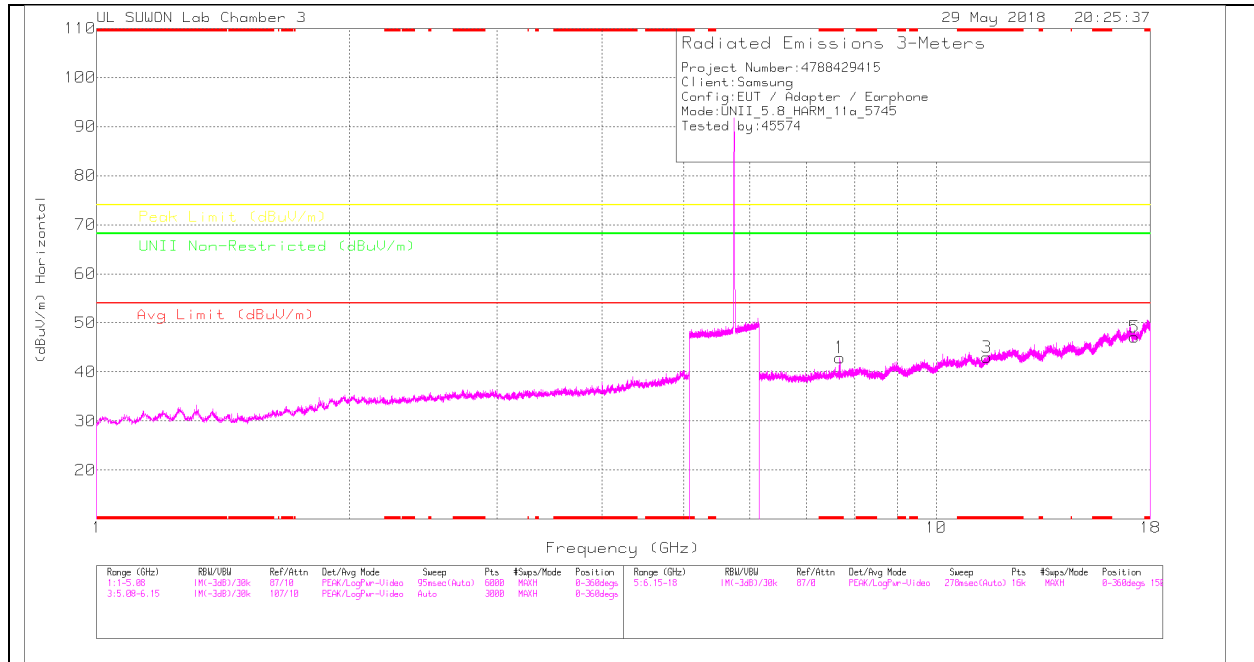

LOW CHANNEL VERTICAL

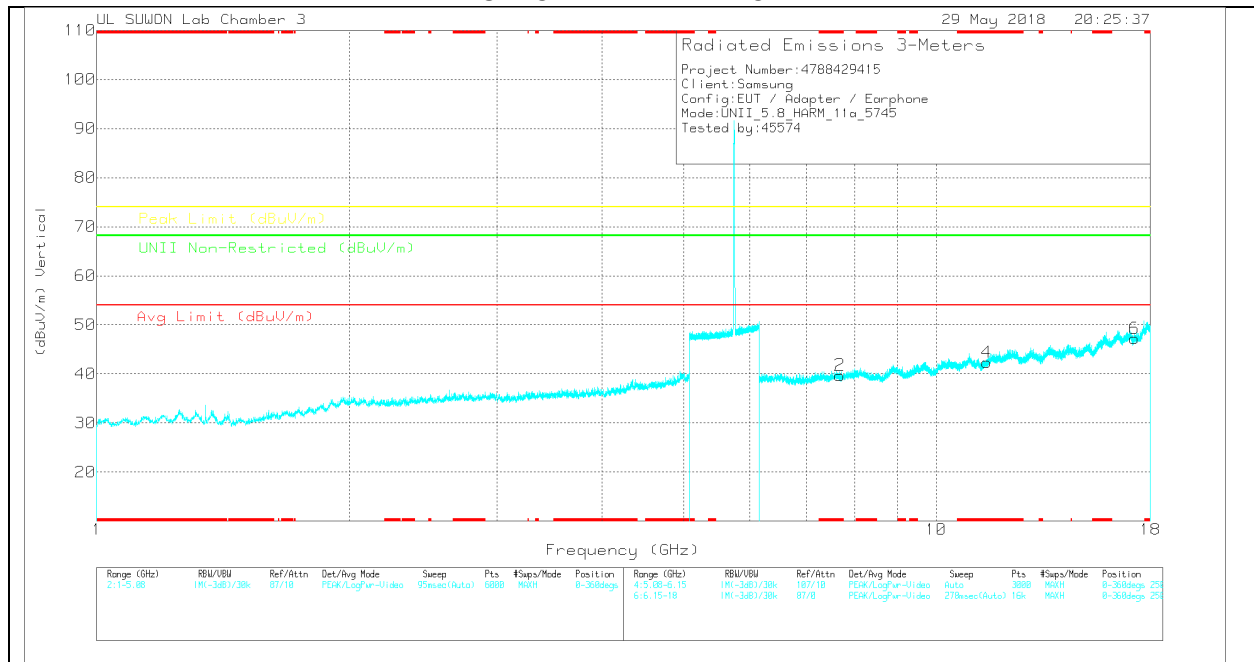

Note: Emission was scanned up to 40GHz; No emissions were detected above the noise floor which was at least 20dB below the specification limit.

LOW CHANNEL DATA

Trace Markers

Marker	Frequency (GHz)	Meter Reading (dBuV)	Det	3117(0205959)	@GHz_HF(dB)	DC Corr (dB)	Corrected Reading (dBuV/m)	Aug Limit (dBuV/m)	Margin (dB)	Peak Limit (dBuV/m)	Margin (dB)	Limit Non-Restricted (dBuV/m)	Margin (dB)	Azimuth (Degs)	Height (cm)	Polarity
1	*7.679	30.61	PK	35.6	-23.3	0	42.91	-	-	74	-31.09	-	-	0-360	250	H
3	*11.49	24.56	PK	38	-19.6	0	42.96	-	-	74	-31.04	-	-	0-360	250	H
5	17.236	21.71	PK	40.7	-15.3	0	47.11	-	-	-	-	68.2	-21.09	0-360	150	H
2	*7.68	27.41	PK	35.6	-23.3	0	39.71	-	-	74	-34.29	-	-	0-360	149	V
4	*11.49	23.93	PK	38	-19.6	0	42.33	-	-	74	-31.67	-	-	0-360	149	V
6	17.235	21.82	PK	40.7	-15.3	0	47.22	-	-	-	-	68.2	-20.98	0-360	250	V

* - indicates frequency in CFR47 Pt 15 / IC RSS-Restricted Band
 PK – Peak Detector

Radiated Emissions

Frequency (GHz)	Meter Reading (dBuV)	Det	3117(0205959)	@GHz_HF(dB)	DC Corr (dB)	Corrected Reading (dBuV/m)	Aug Limit (dBuV/m)	Margin (dB)	Peak Limit (dBuV/m)	Margin (dB)	Limit Non-Restricted (dBuV/m)	Margin (dB)	Azimuth (Degs)	Height (cm)	Polarity
*7.671	33.61	PK-U	35.6	-23.2	0	46.01	-	-	74	-27.99	-	-	111	235	H
*7.68	26.19	ADR	35.6	-23.3	.12	38.61	54	-15.39	-	-	-	-	111	235	H

* - indicates frequency in CFR47 Pt 15 / IC RSS-Restricted Band
 PK-U - U-NII: Maximum Peak
 ADR - U-NII AD primary method, RMS average

MID CHANNEL HORIZONTAL

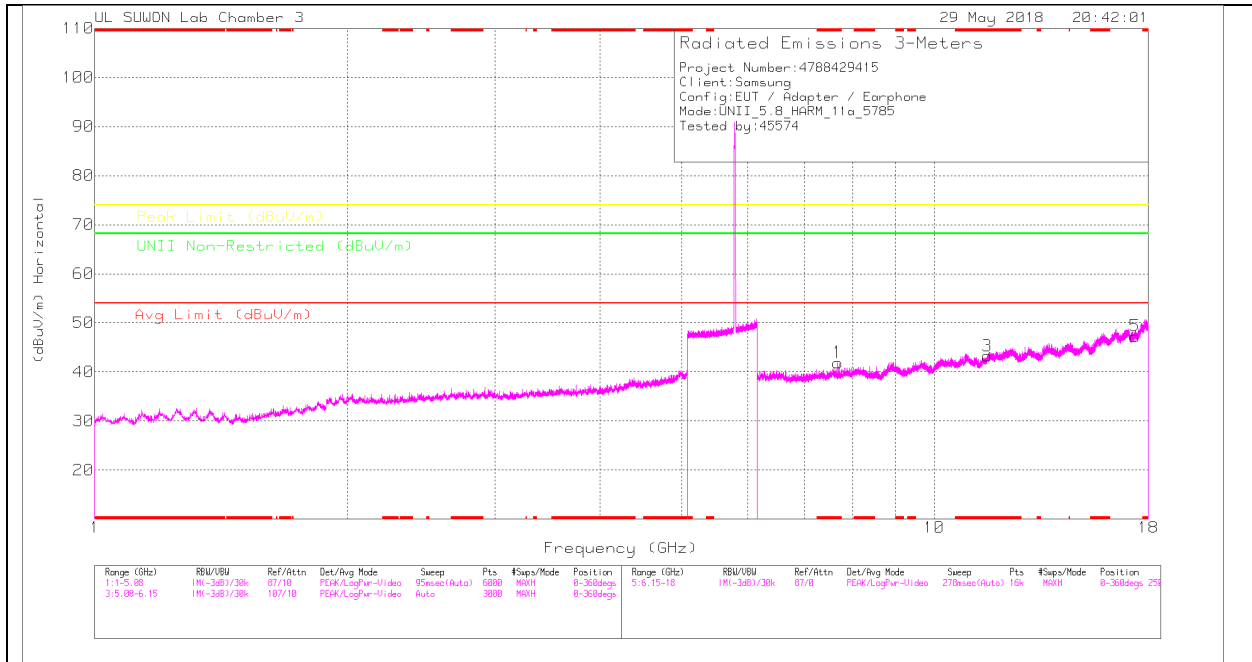

MID CHANNEL VERTICAL

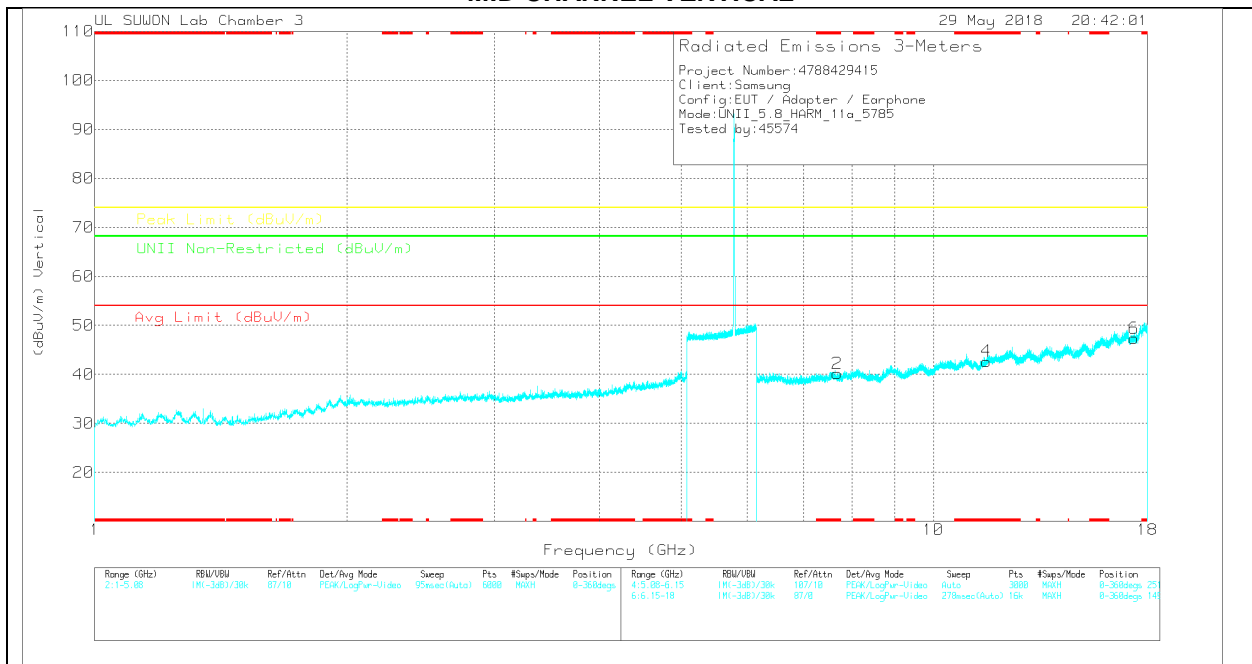

Note: Emission was scanned up to 40GHz; No emissions were detected above the noise floor which was at least 20dB below the specification limit.

MID CHANNEL DATA

Trace Markers

Marker	Frequency (GHz)	Meas Reading (dBuV)	Det	317(0020995)	66Hz_HF[dB]	DC Corr (dB)	Corrected Reading (dBuV/m)	Avg Limit (dBuV/m)	Margin (dB)	Peak Limit (dBuV/m)	Margin (dB)	Limit Non-Restricted (dBuV/m)	Margin (dB)	Altitude (Degs)	Height (cm)	Polarity
1	* 7.679	29.59	PK	35.6	-23.3	0	41.89	-	-	74	-32.11	-	-	0-360	250	H
3	* 11.571	24.85	PK	38.1	-19.7	0	43.25	-	-	74	-30.75	-	-	0-360	150	H
5	17.356	21.79	PK	40.8	-15.3	0	47.29	-	-	-	-	68.2	-20.91	0-360	250	H
2	* 7.68	27.84	PK	35.6	-23.3	0	40.14	-	-	74	-33.86	-	-	0-360	251	V
4	* 11.57	24.36	PK	38.1	-19.8	0	42.66	-	-	74	-31.34	-	-	0-360	149	V
6	17.356	21.88	PK	40.8	-15.3	0	47.38	-	-	-	-	68.2	-20.82	0-360	149	V

* - indicates frequency in CFR47 Pt 15 / IC RSS-Restricted Band
 PK – Peak Detector

Note: Only peak measurement was performed. Because peak measurement result of unwanted emission is less than average limit (54dBuV/m).

HIGH CHANNEL HORIZONTAL

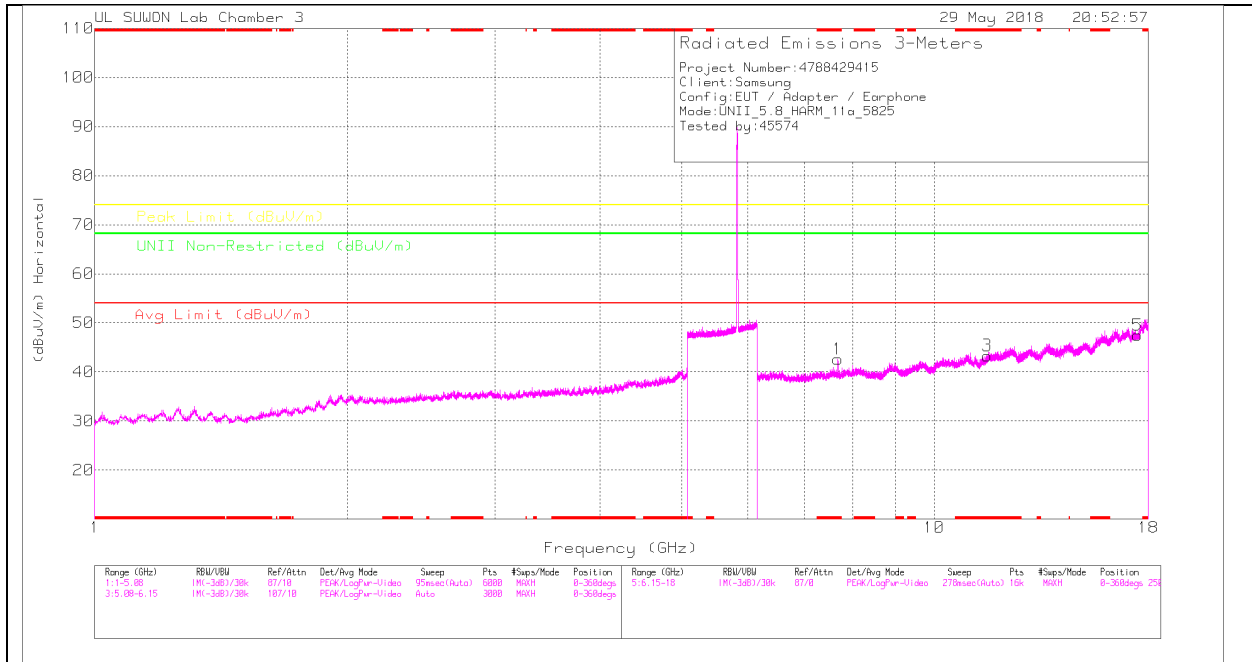

HIGH CHANNEL VERTICAL

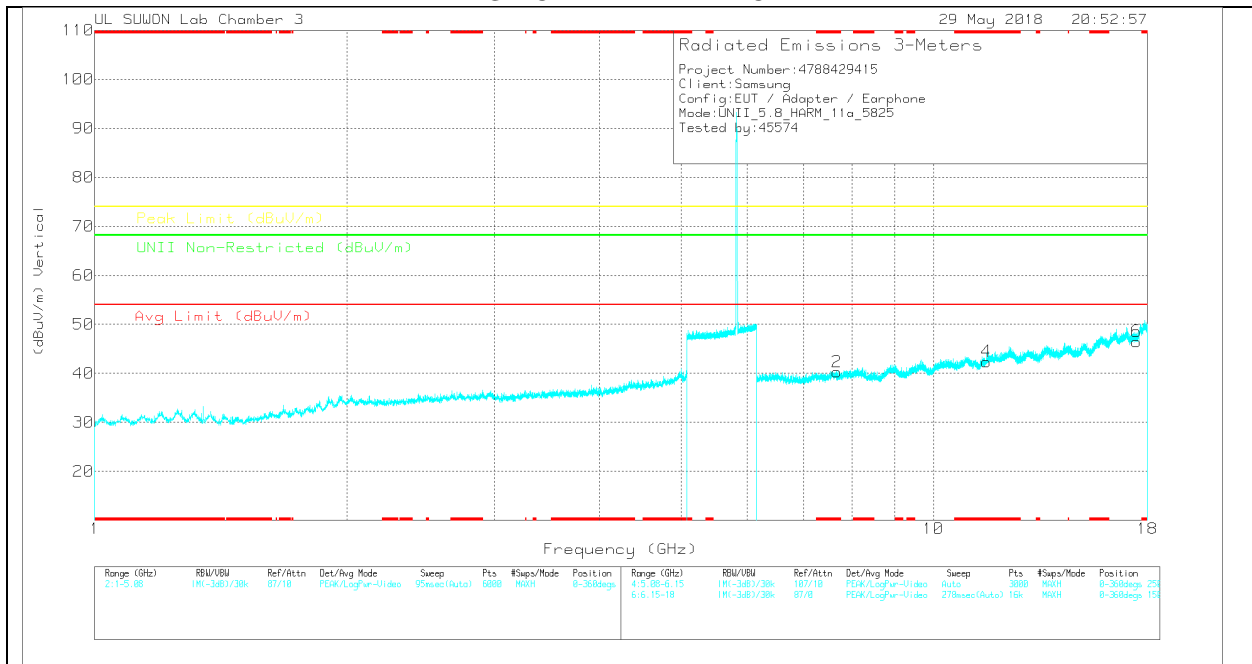

Note: Emission was scanned up to 40GHz; No emissions were detected above the noise floor which was at least 20dB below the specification limit.

HIGH CHANNEL DATA

Trace Markers

Marker	Frequency (GHz)	Meter Reading (dBuV)	Det	3117(0020959)	@GHz_HF(dB)	DC Corr (dB)	Corrected Reading (dBuV/m)	Avg Limit (dBuV/m)	Margin (dB)	Peak Limit (dBuV/m)	Margin (dB)	Limit Non-Restricted (dBuV/m)	Margin (dB)	Azimuth (Degs)	Height (cm)	Polarity
1	* 7.679	30.28	PK	35.6	-23.3	0	42.58	-	-	74	-31.42	-	-	0-360	250	H
3	* 11.561	25.01	PK	38.1	-19.8	0	43.31	-	-	74	-30.69	-	-	0-360	150	H
5	17.476	21.39	PK	41	-14.9	0	47.49	-	-	-	-	68.2	-20.71	0-360	250	H
2	* 7.679	27.99	PK	35.6	-23.3	0	40.29	-	-	74	-33.71	-	-	0-360	250	V
4	* 11.561	24.09	PK	38.1	-19.8	0	42.39	-	-	74	-31.61	-	-	0-360	150	V
6	17.476	20.4	PK	41	-14.9	0	46.5	-	-	-	-	68.2	-21.7	0-360	250	V

* - indicates frequency in CFR47 Pt 15 / IC RSS-Restricted Band
 PK – Peak Detector

Radiated Emissions

Frequency (GHz)	Meter Reading (dBuV)	Det	3117(0020959)	@GHz_HF(dB)	DC Corr (dB)	Corrected Reading (dBuV/m)	Avg Limit (dBuV/m)	Margin (dB)	Peak Limit (dBuV/m)	Margin (dB)	Limit Non-Restricted (dBuV/m)	Margin (dB)	Azimuth (Degs)	Height (cm)	Polarity
* 7.68	33.73	PK-U	35.6	-23.3	0	46.03	-	-	74	-27.97	-	-	111	235	H
* 7.68	27.02	ADR	35.6	-23.3	.12	39.44	54	-14.56	-	-	-	-	111	235	H

* - indicates frequency in CFR47 Pt 15 / IC RSS-Restricted Band
 PK-U - U-NII: Maximum Peak
 ADR - U-NII AD primary method, RMS average

11.4.2.TX ABOVE 1GHz 802.11n HT20 2Tx CDD MODE IN THE 5.8GHz BAND BANDEDGE (LOW CHANNEL)

HORIZONTAL PEAK PLOT

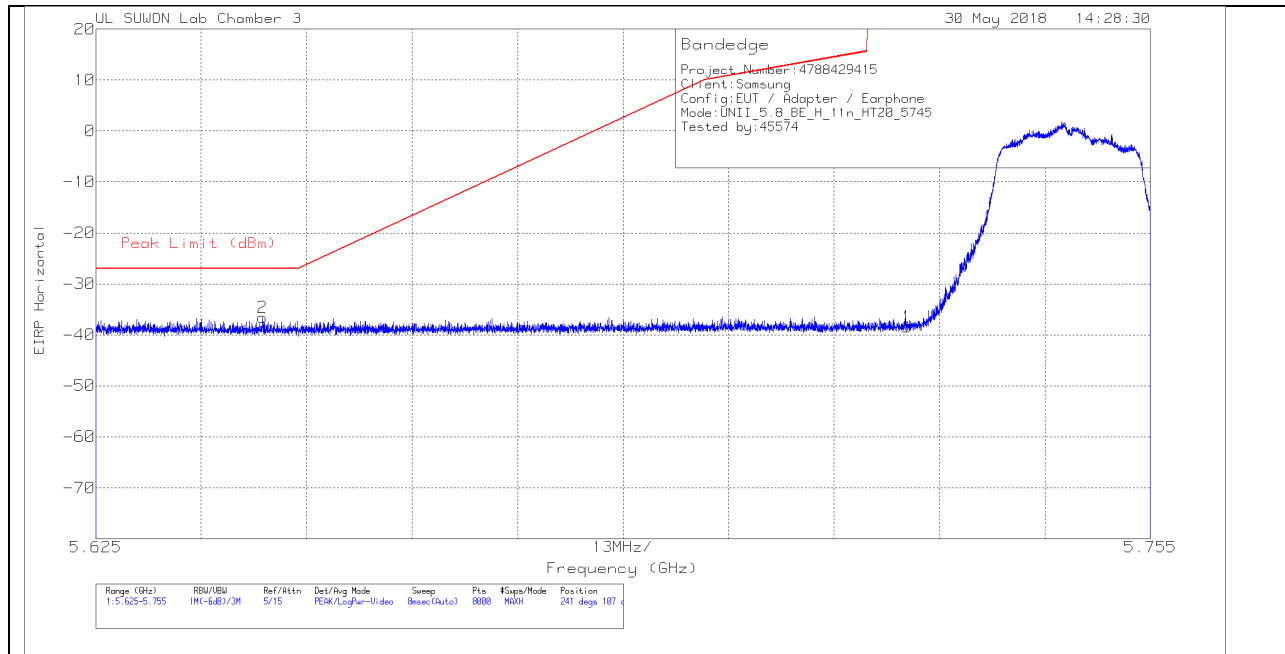

HORIZONTAL DATA

Trace Markers

Marker	Frequency (GHz)	Meter Reading (dBm)	Det	3117[00205959]	10dB_ATT[dB]	Conversion Factor (dB)	Corrected Reading EIRP	Peak Limit (dBm)	PK Margin (dB)	Azimuth (Degs)	Height (cm)	Polarity
1	5.725	-67.05	Pk	34.7	-17.9	11.8	-38.45	278.95	-317.4	241	107	H
2	5.646	-64.75	Pk	34.5	-18.1	11.8	-36.55	-27	-9.55	241	107	H

Pk - Peak detector

VERTICAL PEAK PLOT

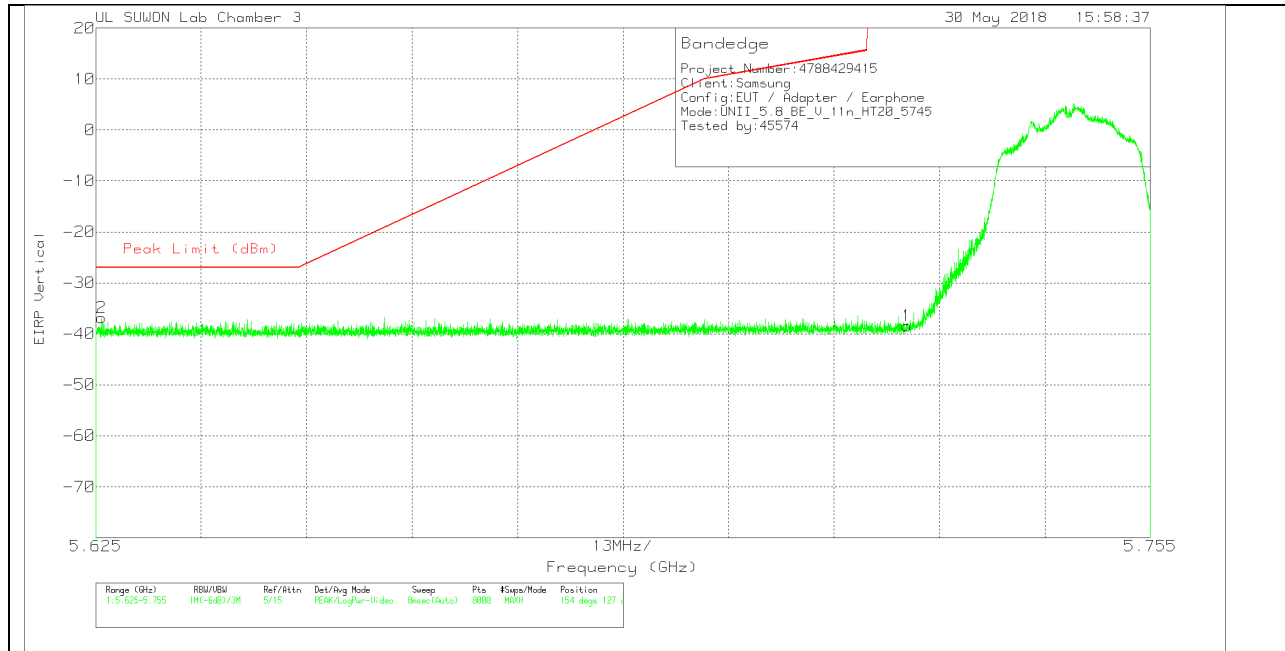

VERTICAL DATA

Trace Markers

Marker	Frequency (GHz)	Meter Reading (dBm)	Det	3117[00205959]	10dB_ATT[dB]	Conversion Factor (dB)	Corrected Reading EIRP	Peak Limit (dBm)	PK Margin (dB)	Azimuth (Degs)	Height (cm)	Polarity
1	5.725	-67.03	Pk	34.7	-17.9	11.8	-38.43	278.95	-317.38	154	127	V
2	5.626	-64.99	Pk	34.5	-18.1	11.8	-36.79	-27	-9.79	154	127	V

Pk - Peak detector

BANDEDGE (HIGH CHANNEL)

HORIZONTAL PEAK AND AVERAGE PLOT

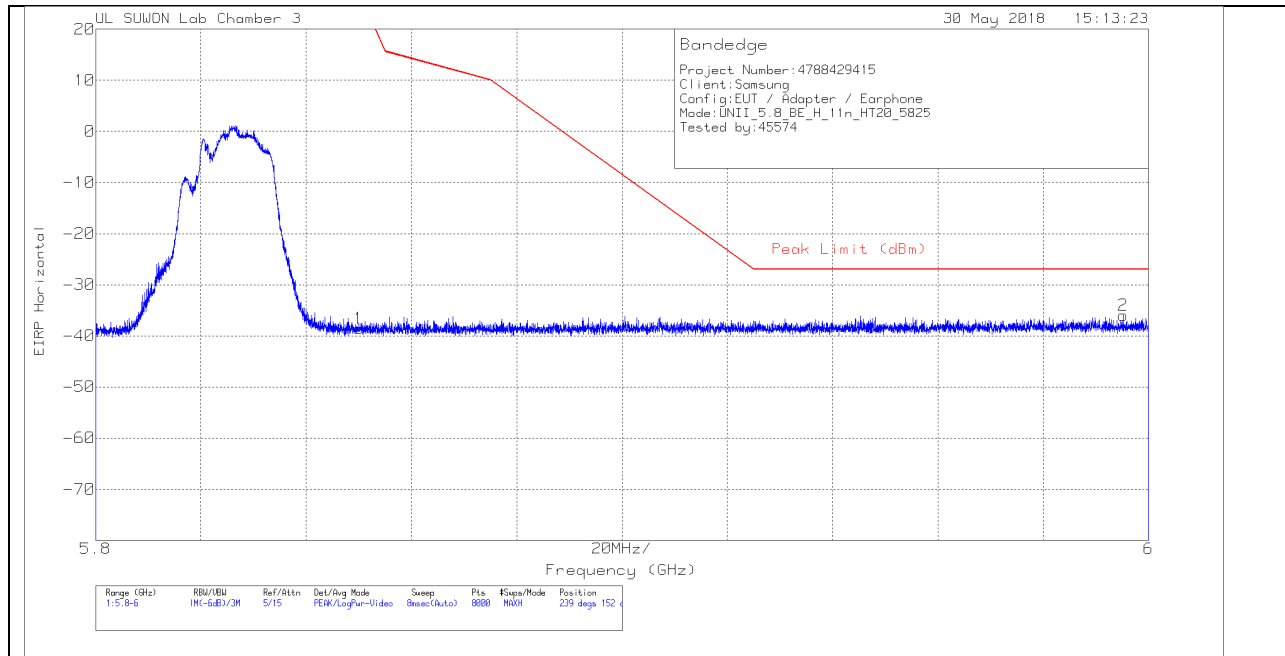

HORIZONTAL DATA

Trace Markers

Marker	Frequency (GHz)	Meter Reading (dBm)	Det	3117[00205959]	10dB_ATT[dB]	Conversion Factor (dB)	Corrected Reading EIRP	Peak Limit (dBm)	PK Margin (dB)	Azimuth (Degs)	Height (cm)	Polarity
1	5.85	-67.67	Pk	34.9	-17.6	11.8	-38.57	26.99	-65.56	239	152	H
2	5.995	-65.33	Pk	35.1	-17.5	11.8	-35.93	-27	-8.93	239	152	H

Pk - Peak detector

VERTICAL PEAK PLOT

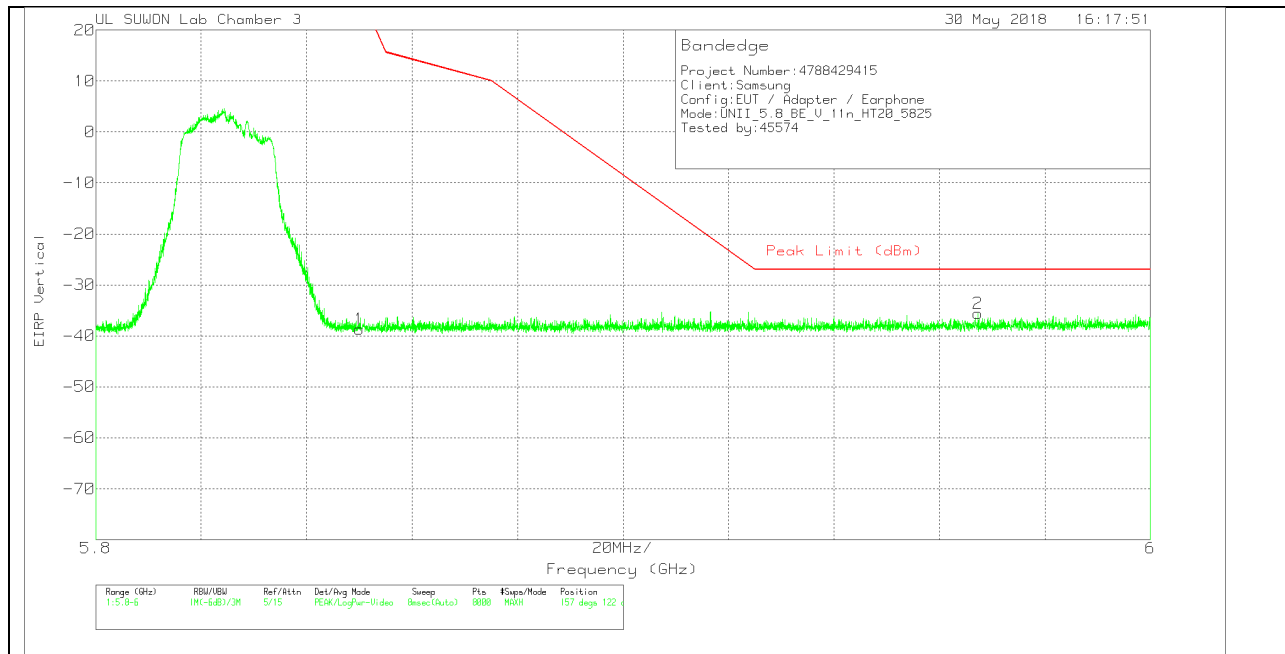

VERTICAL DATA

Trace Markers

Marker	Frequency (GHz)	Meter Reading (dBm)	Det	3117[00205959]	10dB_ATT[dB]	Conversion Factor (dB)	Corrected Reading EIRP	Peak Limit (dBm)	PK Margin (dB)	Azimuth (Degs)	Height (cm)	Polarity
1	5.85	-67.8	Pk	34.9	-17.6	11.8	-38.7	26.99	-65.69	157	122	V
2	5.967	-64.84	Pk	35	-17.6	11.8	-35.64	-27	-8.64	157	122	V

Pk - Peak detector

LOW CHANNEL HORIZONTAL

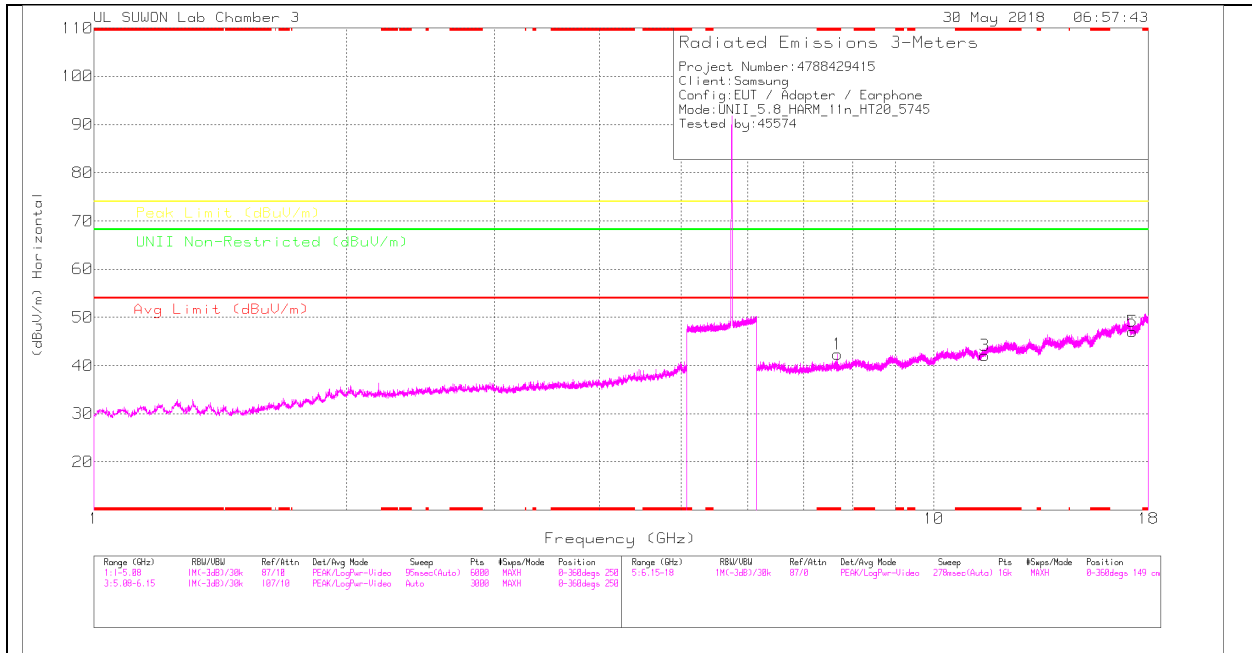

LOW CHANNEL VERTICAL

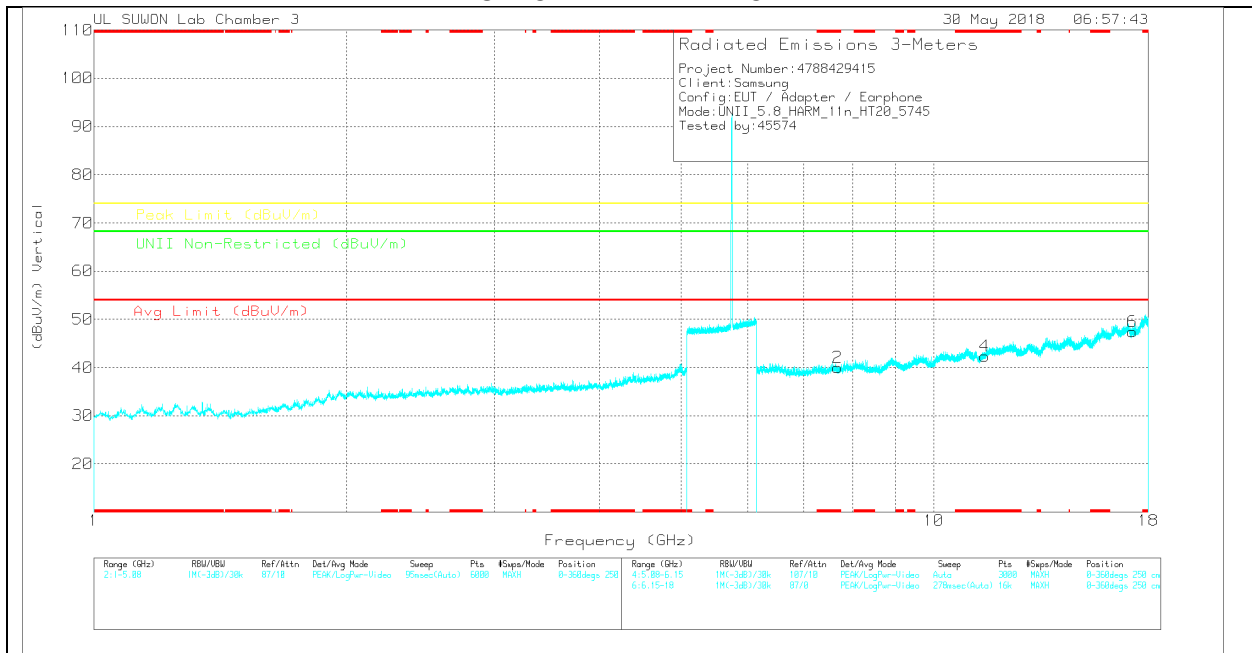

Note: Emission was scanned up to 40GHz; No emissions were detected above the noise floor which was at least 20dB below the specification limit.

LOW CHANNEL DATA

Trace Markers

Marker	Frequency (GHz)	Meter Reading (dBuV)	Det	3117(0205959)	@GHz_HF(dB)	DC Corr (dB)	Corrected Reading (dBuV/m)	Aug Limit (dBuV/m)	Margin (dB)	Peak Limit (dBuV/m)	Margin (dB)	Limit Non-Restricted (dBuV/m)	Margin (dB)	Azimuth (Degs)	Height (cm)	Polarity
1	* 7.68	30.1	PK	35.6	-23.3	0	42.4	-	-	74	-31.6	-	-	0-360	149	H
3	* 11.49	23.73	PK	38	-19.6	0	42.13	-	-	74	-31.87	-	-	0-360	149	H
5	17.236	21.61	PK	40.7	-15.3	0	47.01	-	-	-	-	68.2	-21.19	0-360	250	H
2	* 7.679	27.73	PK	35.6	-23.3	0	40.03	-	-	74	-33.97	-	-	0-360	149	V
4	* 11.49	23.9	PK	38	-19.6	0	42.3	-	-	74	-31.7	-	-	0-360	149	V
6	17.236	22.03	PK	40.7	-15.3	0	47.43	-	-	-	-	68.2	-20.77	0-360	149	V

* - indicates frequency in CFR47 Pt 15 / IC RSS-Restricted Band
 PK – Peak Detector

Radiated Emissions

Frequency (GHz)	Meter Reading (dBuV)	Det	3117(0205959)	@GHz_HF(dB)	DC Corr (dB)	Corrected Reading (dBuV/m)	Aug Limit (dBuV/m)	Margin (dB)	Peak Limit (dBuV/m)	Margin (dB)	Limit Non-Restricted (dBuV/m)	Margin (dB)	Azimuth (Degs)	Height (cm)	Polarity
* 7.68	34.8	PK-U	35.6	-23.3	0	47.1	-	-	74	-26.9	-	-	111	235	H
* 7.68	28.09	ADR	35.6	-23.3	.14	40.53	54	-13.47	-	-	-	-	111	235	H

* - indicates frequency in CFR47 Pt 15 / IC RSS-Restricted Band
 PK-U - U-NII: Maximum Peak
 ADR - U-NII AD primary method, RMS average

MID CHANNEL HORIZONTAL

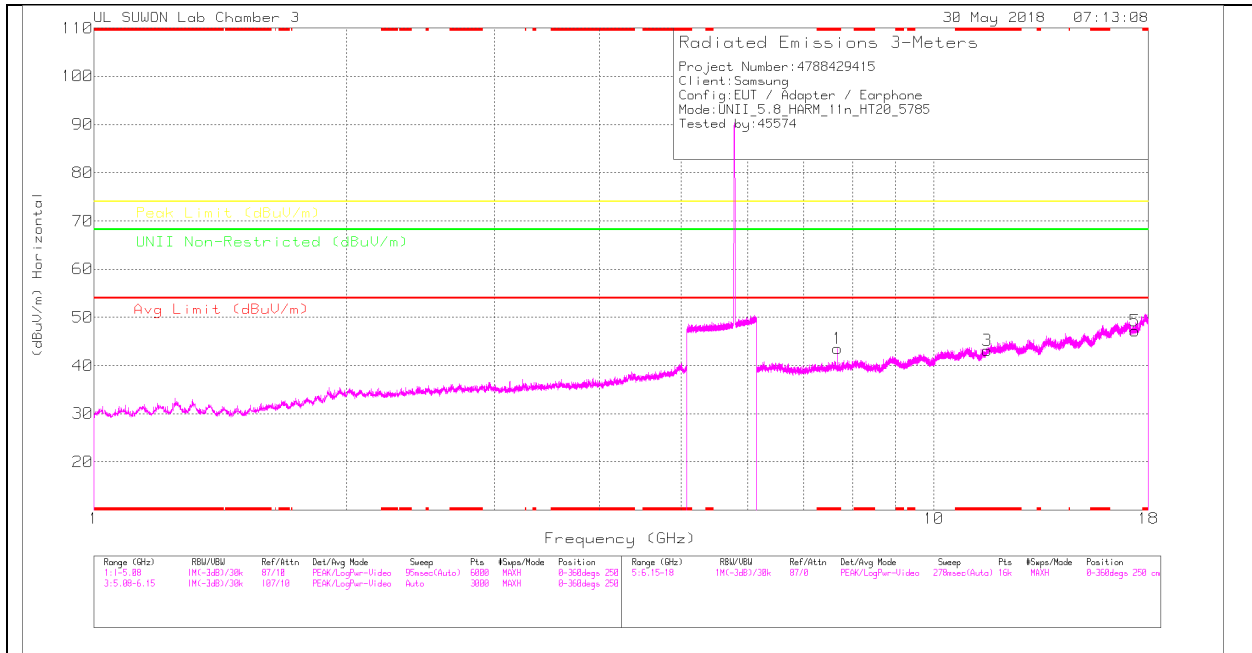

MID CHANNEL VERTICAL

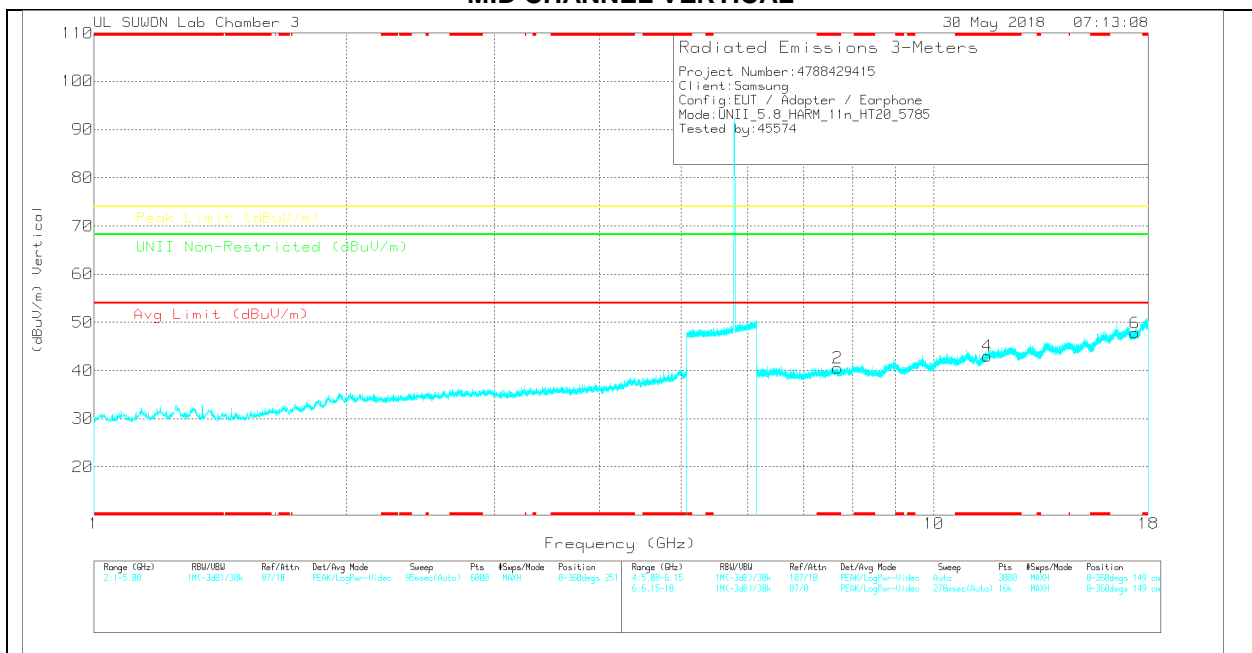

Note: Emission was scanned up to 40GHz; No emissions were detected above the noise floor which was at least 20dB below the specification limit.

MID CHANNEL DATA

Trace Markers

Marker	Frequency (GHz)	Meter Reading (dBuV)	Det	3117(00205959)	6GHz_HF(dB)	DC Corr (dB)	Corrected Reading (dBuV/m)	Avg Limit (dBuV/m)	Margin (dB)	Peak Limit (dBuV/m)	Margin (dB)	UNI Non-Restricted (dBuV/m)	Margin (dB)	Azimuth (Degs)	Height (cm)	Polarity
1	* 7.679	31.18	PK	35.6	-23.3	0	43.48	-	-	74	-30.52	-	-	0-360	150	H
3	* 11.57	24.81	PK	38.1	-19.8	0	43.11	-	-	74	-30.89	-	-	0-360	150	H
5	17.356	21.65	PK	40.8	-15.3	0	47.15	-	-	-	-	68.2	-21.05	0-360	150	H
2	* 7.679	28.28	PK	35.6	-23.3	0	40.58	-	-	74	-33.42	-	-	0-360	149	V
4	* 11.571	24.63	PK	38.1	-19.7	0	43.03	-	-	74	-30.97	-	-	0-360	250	V
6	17.356	22.27	PK	40.8	-15.3	0	47.77	-	-	-	-	68.2	-20.43	0-360	149	V

* - indicates frequency in CFR47 Pt 15 / IC RSS-Restricted Band
 PK – Peak detector

Radiated Emissions

Frequency (GHz)	Meter Reading (dBuV)	Det	3117(00205959)	6GHz_HF(dB)	DC Corr (dB)	Corrected Reading (dBuV/m)	Avg Limit (dBuV/m)	Margin (dB)	Peak Limit (dBuV/m)	Margin (dB)	UNI Non-Restricted (dBuV/m)	Margin (dB)	Azimuth (Degs)	Height (cm)	Polarity
* 7.672	34.16	PK-U	35.6	-23.3	0	46.46	-	-	74	-27.54	-	-	111	235	H
* 7.68	26.99	ADR	35.6	-23.3	.14	39.43	54	-14.57	-	-	-	-	111	235	H

* - indicates frequency in CFR47 Pt 15 / IC RSS-Restricted Band
 PK-U - U-NII: Maximum Peak
 ADR - U-NII AD primary method, RMS average

HIGH CHANNEL HORIZONTAL

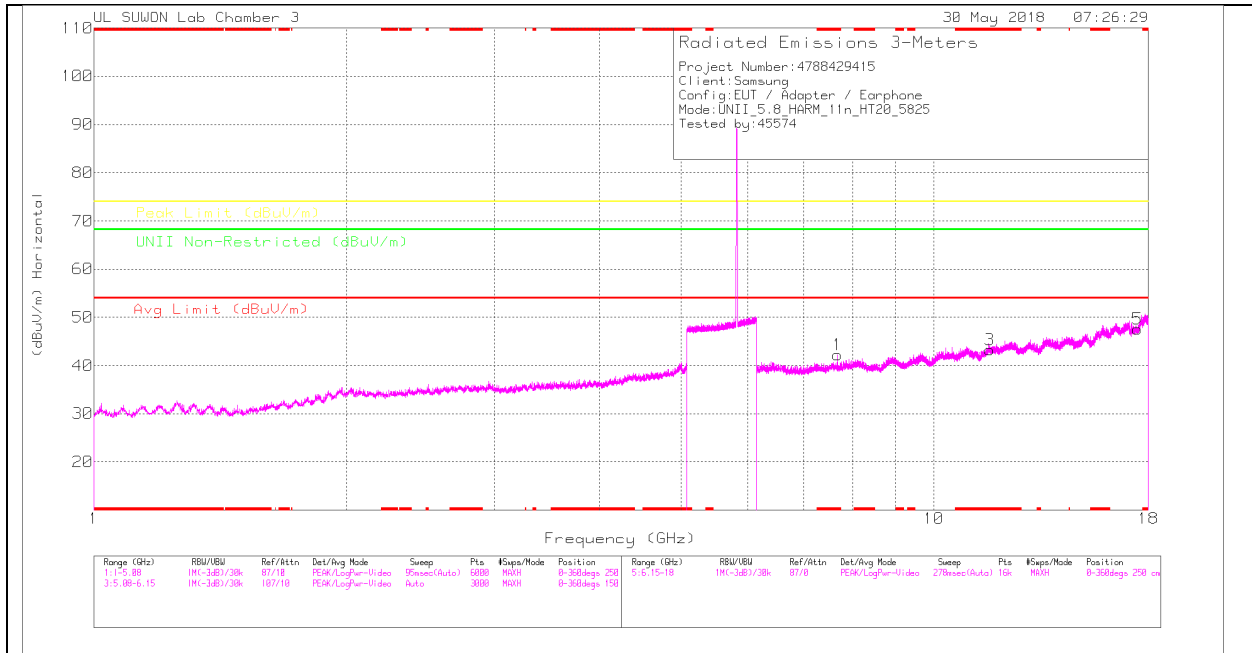

HIGH CHANNEL VERTICAL

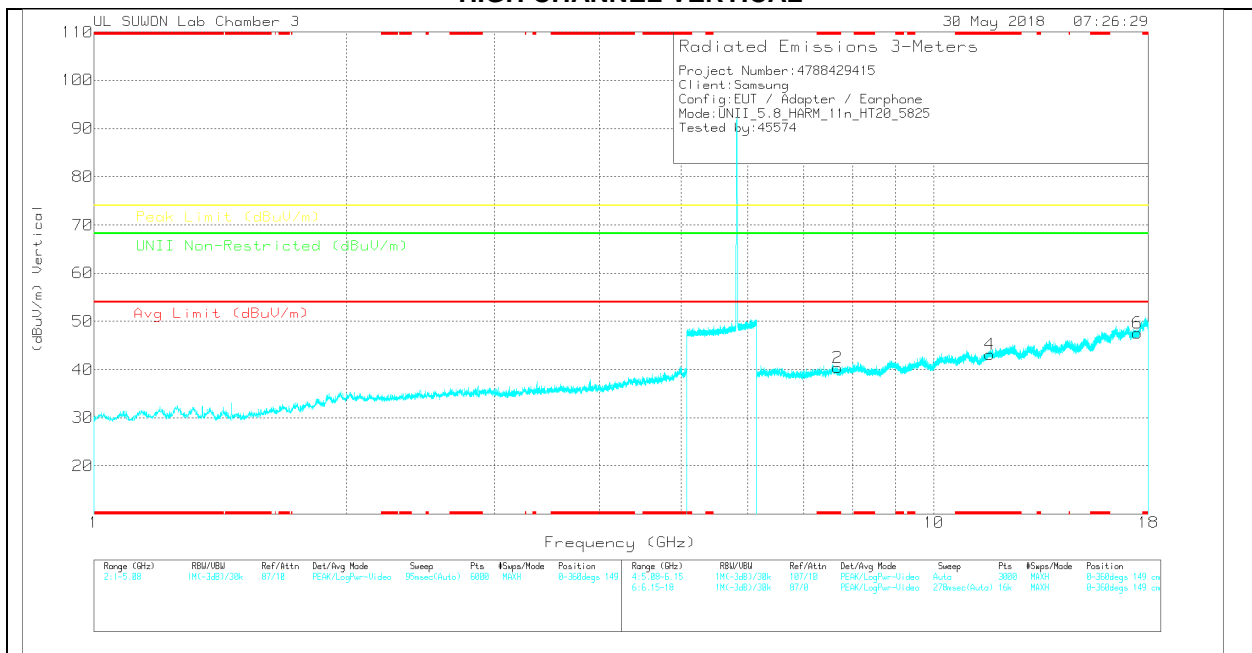

Note: Emission was scanned up to 40GHz; No emissions were detected above the noise floor which was at least 20dB below the specification limit.

HIGH CHANNEL DATA

Trace Markers

Marker	Frequency (GHz)	Meter Reading (dBuV)	Det	3117(0205959)	@GHz_HFj(dB)	DC Corr (dB)	Corrected Reading (dBuV/m)	Aug Limit (dBuV/m)	Margin (dB)	Peak Limit (dBuV/m)	Margin (dB)	Limit Non-Restricted (dBuV/m)	Margin (dB)	Asimuth (Degs)	Height (cm)	Polarity
1	* 7.679	29.87	PK	35.6	-23.3	0	42.17	-	-	74	-31.83	-	-	0-360	150	H
3	* 11.65	24.74	PK	38.2	-19.7	0	43.24	-	-	74	-30.76	-	-	0-360	150	H
5	17.473	21.53	PK	41	-14.9	0	47.63	-	-	-	-	68.2	-20.57	0-360	250	H
2	* 7.68	28.07	PK	35.6	-23.3	0	40.37	-	-	74	-33.63	-	-	0-360	149	V
4	* 11.65	24.69	PK	38.2	-19.7	0	43.19	-	-	74	-30.81	-	-	0-360	149	V
6	17.478	21.51	PK	41	-14.9	0	47.61	-	-	-	-	68.2	-20.59	0-360	250	V

* - indicates frequency in CFR47 Pt 15 / IC RSS-Restricted Band
 PK – Peak Detector

Radiated Emissions

Frequency (GHz)	Meter Reading (dBuV)	Det	3117(0205959)	@GHz_HFj(dB)	DC Corr (dB)	Corrected Reading (dBuV/m)	Aug Limit (dBuV/m)	Margin (dB)	Peak Limit (dBuV/m)	Margin (dB)	Limit Non-Restricted (dBuV/m)	Margin (dB)	Asimuth (Degs)	Height (cm)	Polarity
* 7.677	35.34	PK-U	35.6	-23.3	0	47.64	-	-	74	-26.36	-	-	111	235	H
* 7.68	26.91	ADR	35.6	-23.3	.14	39.35	54	-14.65	-	-	-	-	111	235	H

* - indicates frequency in CFR47 Pt 15 / IC RSS-Restricted Band
 PK-U - U-NII: Maximum Peak
 ADR - U-NII AD primary method, RMS average

11.4.3.TX ABOVE 1GHz 802.11n HT40 2Tx CDD MODE IN THE 5.8GHz BAND BANDEDGE (LOW CHANNEL)

HORIZONTAL PEAK PLOT

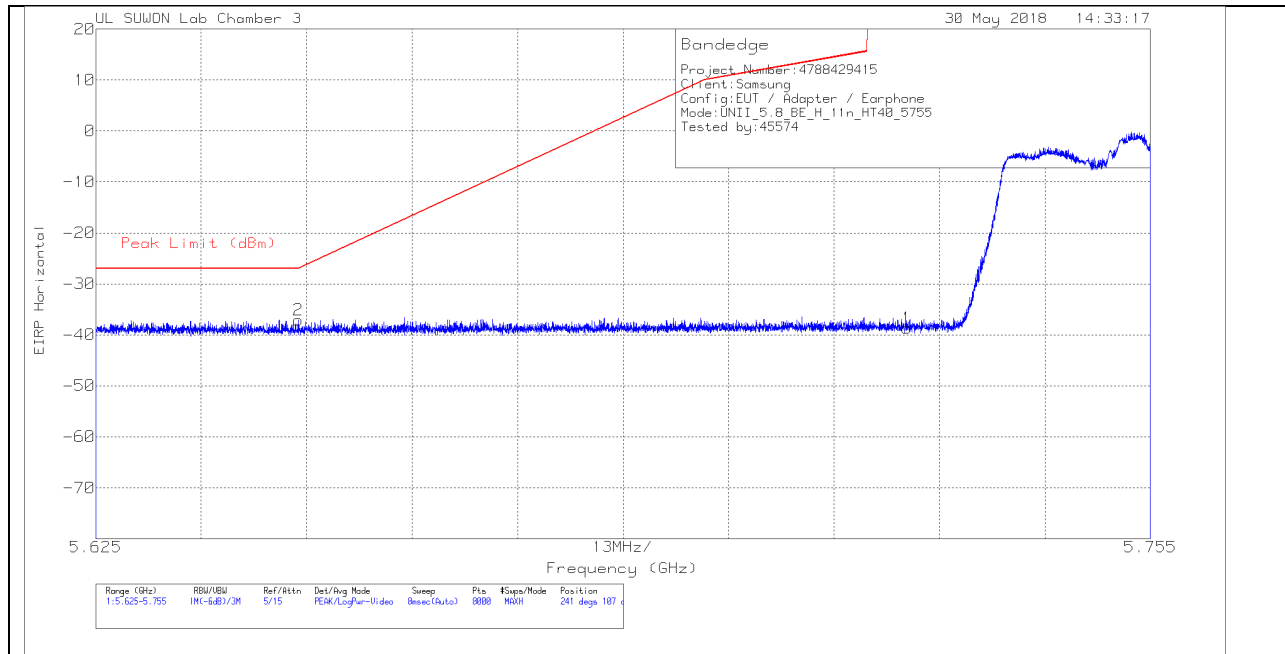

HORIZONTAL DATA

Trace Markers

Marker	Frequency (GHz)	Meter Reading (dBm)	Det	3117[00205959]	10dB_ATT[dB]	Conversion Factor (dB)	Corrected Reading EIRP	Peak Limit (dBm)	PK Margin (dB)	Azimuth (Degs)	Height (cm)	Polarity
1	5.725	-67.26	Pk	34.7	-17.9	11.8	-38.66	278.95	-317.61	241	107	H
2	5.65	-65.25	Pk	34.5	-18.1	11.8	-37.05	-27	-10.05	241	107	H

Pk - Peak detector

VERTICAL PEAK PLOT

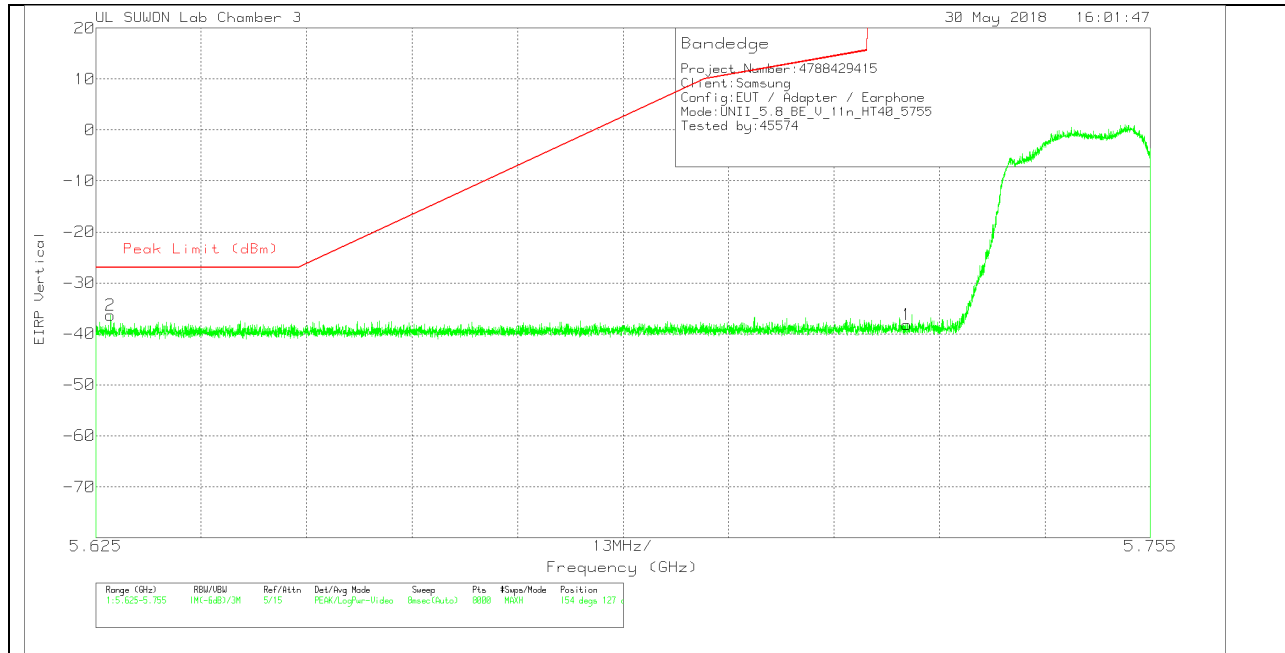

VERTICAL DATA

Trace Markers

Marker	Frequency (GHz)	Meter Reading (dBm)	Det	3117[00205959]	10dB_ATT[dB]	Conversion Factor (dB)	Corrected Reading EIRP	Peak Limit (dBm)	PK Margin (dB)	Azimuth (Degs)	Height (cm)	Polarity
1	5.725	-66.8	Pk	34.7	-17.9	11.8	-38.2	278.95	-317.15	154	127	V
2	5.627	-64.47	Pk	34.5	-18.2	11.8	-36.37	-27	-9.37	154	127	V

Pk - Peak detector

BANDEDGE (HIGH CHANNEL)

HORIZONTAL PEAK PLOT

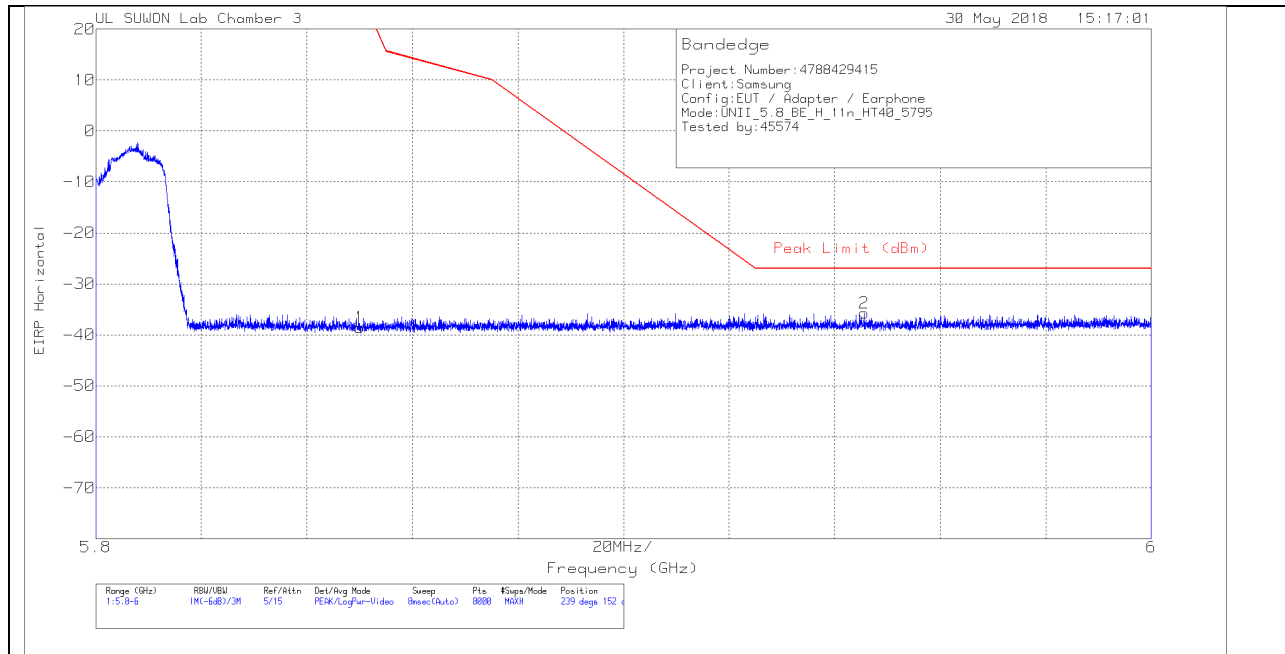

HORIZONTAL DATA

Trace Markers

Marker	Frequency (GHz)	Meter Reading (dBm)	Det	3117[00205959]	10dB_ATT[dB]	Conversion Factor (dB)	Corrected Reading EIRP	Peak Limit (dBm)	PK Margin (dB)	Azimuth (Degs)	Height (cm)	Polarity
1	5.85	-67.61	Pk	34.9	-17.6	11.8	-38.51	26.99	-65.5	239	152	H
2	5.946	-64.97	Pk	35	-17.5	11.8	-35.67	-27	-8.67	239	152	H

Pk - Peak detector

VERTICAL PEAK PLOT

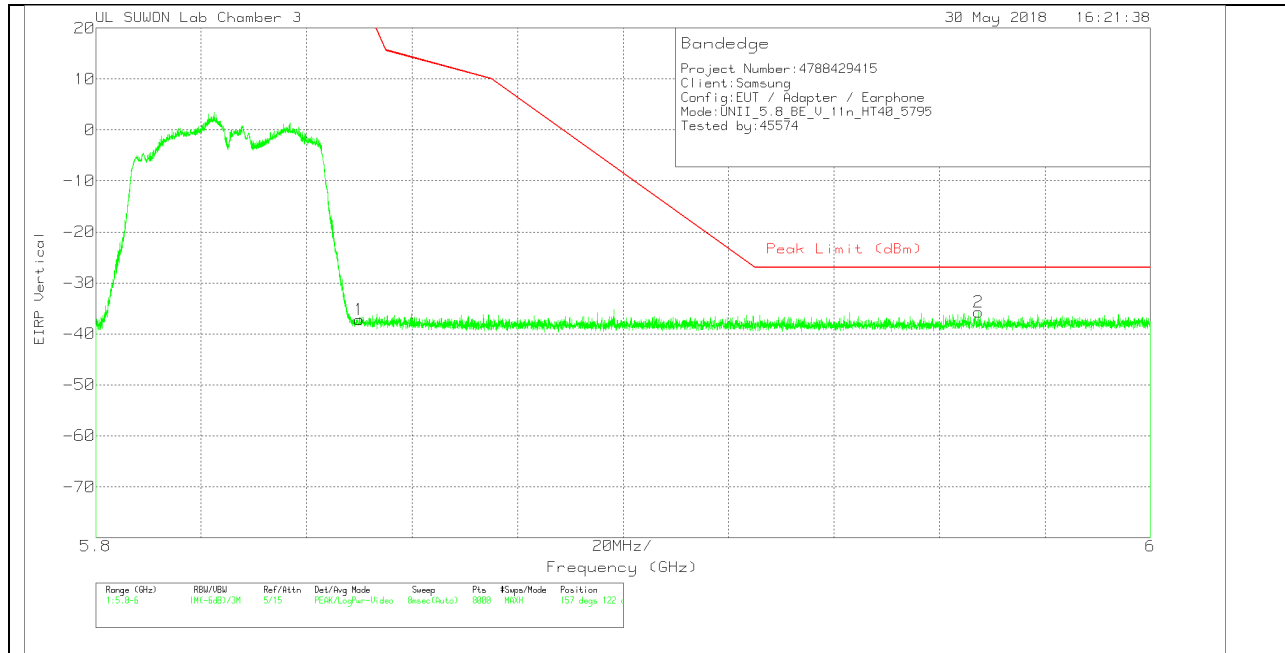

VERTICAL DATA

Trace Markers

Marker	Frequency (GHz)	Meter Reading (dBm)	Det	3117[00205959]	10dB_ATT[dB]	Conversion Factor (dB)	Corrected Reading EIRP	Peak Limit (dBm)	PK Margin (dB)	Azimuth (Degs)	Height (cm)	Polarity
1	5.85	-66.3	Pk	34.9	-17.6	11.8	-37.2	26.99	-64.19	157	122	V
2	5.967	-64.87	Pk	35	-17.6	11.8	-35.67	-27	-8.67	157	122	V

Pk - Peak detector

LOW CHANNEL HORIZONTAL

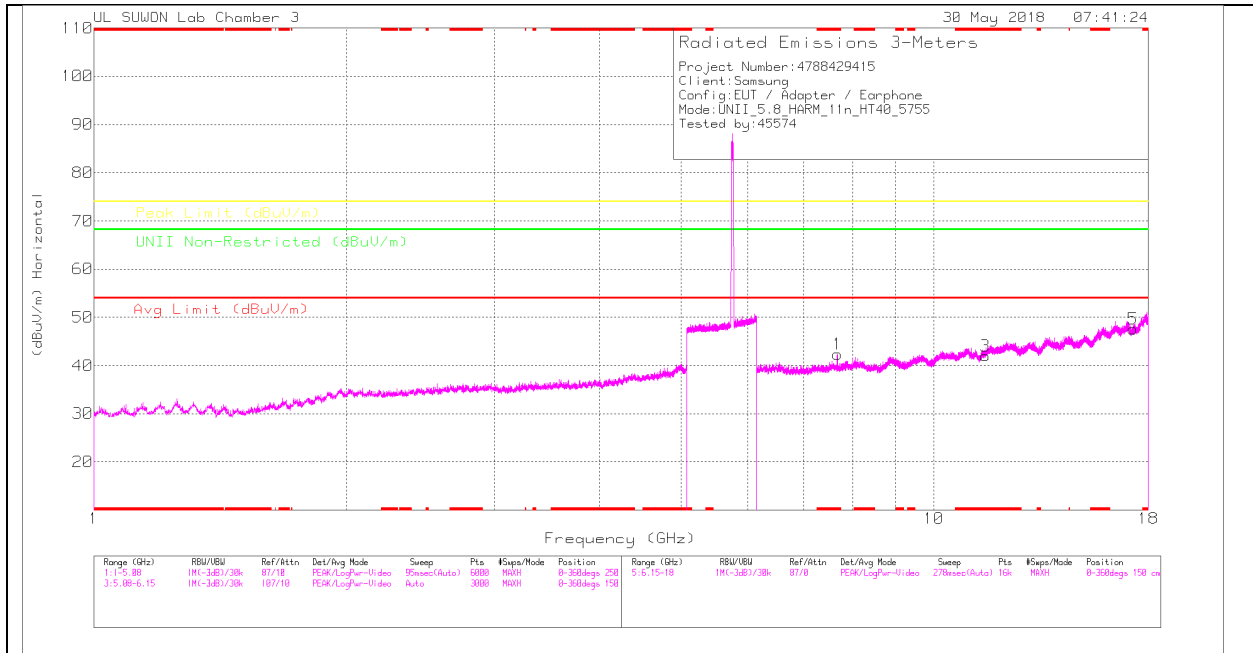

LOW CHANNEL VERTICAL

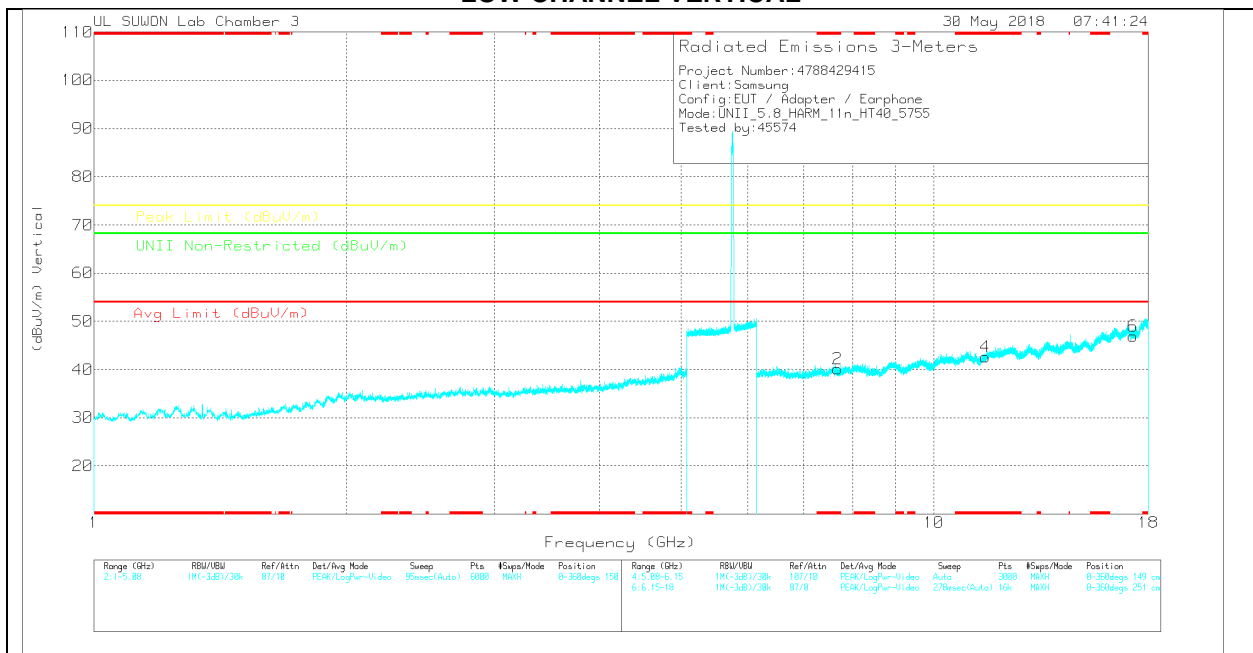

Note: Emission was scanned up to 40GHz; No emissions were detected above the noise floor which was at least 20dB below the specification limit.

LOW CHANNEL DATA

Trace Markers

Marker	Frequency (GHz)	Meter Reading (dBuV)	Det	3117(0020959)	@GHz_HF(dB)	DC Corr (dB)	Corrected Reading (dBuV/m)	AvG Limit (dBuV/m)	Margin (dB)	Peak Limit (dBuV/m)	Margin (dB)	Limit Non-Restricted (dBuV/m)	Margin (dB)	Azimuth (Degs)	Height (cm)	Polarity
1	* 7.679	30	PK	35.6	-23.3	0	42.3	-	-	74	-31.7	-	-	0-360	251	H
3	* 11.511	23.63	PK	38	-19.6	0	42.03	-	-	74	-31.97	-	-	0-360	251	H
5	17.266	21.91	PK	40.7	-15	0	47.61	-	-	-	-	68.2	-20.59	0-360	150	H
2	* 7.679	27.9	PK	35.6	-23.3	0	40.2	-	-	74	-33.8	-	-	0-360	149	V
4	* 11.511	24.24	PK	38	-19.6	0	42.64	-	-	74	-31.36	-	-	0-360	251	V
6	17.266	21.18	PK	40.7	-15	0	46.88	-	-	-	-	68.2	-21.32	0-360	251	V

* - indicates frequency in CFR47 Pt 15 / IC RSS-Restricted Band
 PK – Peak Detector

Radiated Emissions

Frequency (GHz)	Meter Reading (dBuV)	Det	3117(0020959)	@GHz_HF(dB)	DC Corr (dB)	Corrected Reading (dBuV/m)	AvG Limit (dBuV/m)	Margin (dB)	Peak Limit (dBuV/m)	Margin (dB)	Limit Non-Restricted (dBuV/m)	Margin (dB)	Azimuth (Degs)	Height (cm)	Polarity
* 7.681	34.78	PK-U	35.6	-23.3	0	47.08	-	-	74	-26.92	-	-	111	235	H
* 7.68	27.11	ADR	35.6	-23.3	-24	39.65	54	-14.35	-	-	-	-	111	235	H

* - indicates frequency in CFR47 Pt 15 / IC RSS-Restricted Band
 PK-U - U-NII: Maximum Peak
 ADR - U-NII AD primary method, RMS average

HIGH CHANNEL HORIZONTAL

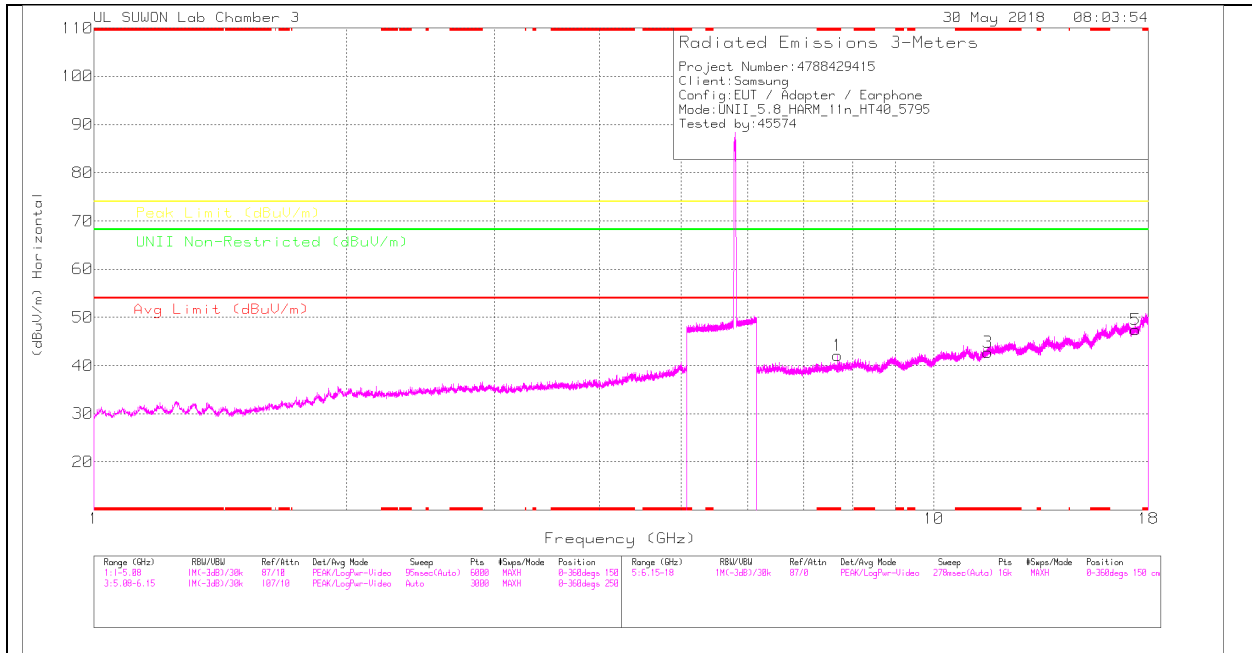

HIGH CHANNEL VERTICAL

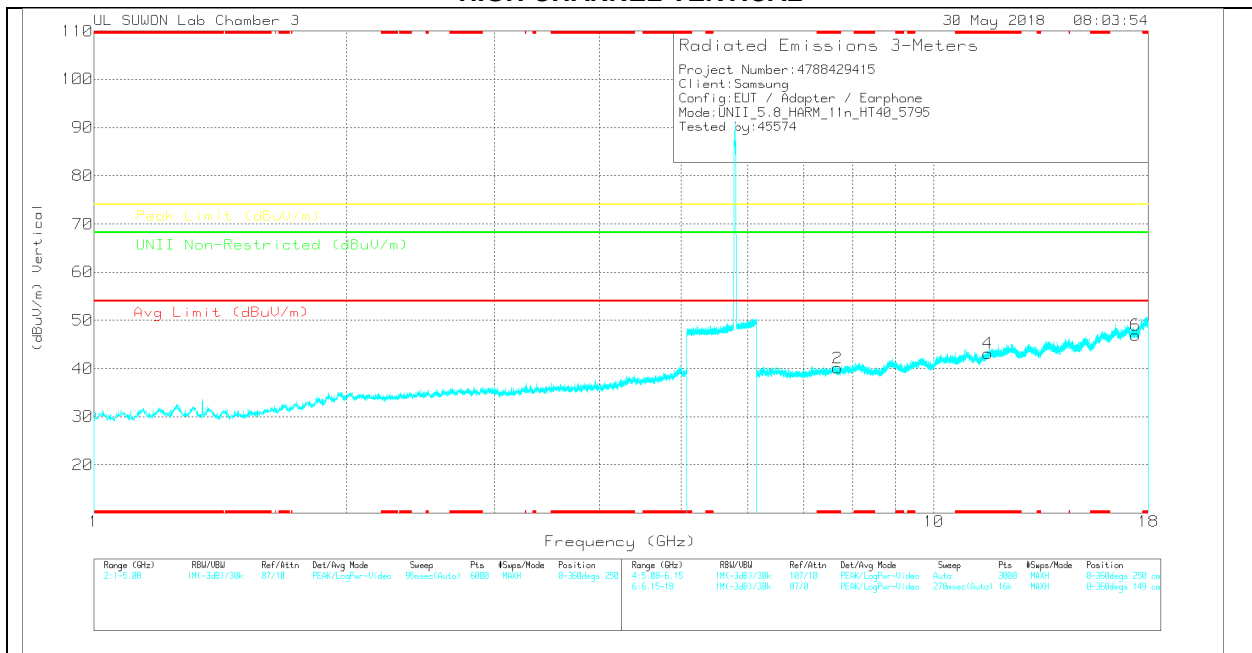

Note: Emission was scanned up to 40GHz; No emissions were detected above the noise floor which was at least 20dB below the specification limit.

HIGH CHANNEL DATA

Trace Markers

Marker	Frequency (GHz)	Meter Reading (dBuV)	Det	3117(0205959)	@GHz_HF(dB)	DC Corr (dB)	Corrected Reading (dBuV/m)	Aug Limit (dBuV/m)	Margin (dB)	Peak Limit (dBuV/m)	Margin (dB)	Limit Non-Restricted (dBuV/m)	Margin (dB)	Azimuth (Degs)	Height (cm)	Polarity
1	* 7.68	29.84	PK	35.6	-23.3	0	42.14	-	-	74	-31.86	-	-	0-360	250	H
3	* 11.59	24.46	PK	38.1	-19.8	0	42.76	-	-	74	-31.24	-	-	0-360	150	H
5	17.386	21.81	PK	40.9	-15.3	0	47.41	-	-	-	-	68.2	-20.79	0-360	250	H
2	* 7.679	27.78	PK	35.6	-23.3	0	40.08	-	-	74	-33.92	-	-	0-360	250	V
4	* 11.59	24.81	PK	38.1	-19.8	0	43.11	-	-	74	-30.89	-	-	0-360	250	V
6	17.386	21.35	PK	40.9	-15.3	0	46.95	-	-	-	-	68.2	-21.25	0-360	250	V

* - indicates frequency in CFR47 Pt 15 / IC RSS-Restricted Band
 PK – Peak detector

Radiated Emissions

Frequency (GHz)	Meter Reading (dBuV)	Det	3117(0205959)	@GHz_HF(dB)	DC Corr (dB)	Corrected Reading (dBuV/m)	Aug Limit (dBuV/m)	Margin (dB)	Peak Limit (dBuV/m)	Margin (dB)	Limit Non-Restricted (dBuV/m)	Margin (dB)	Azimuth (Degs)	Height (cm)	Polarity
* 7.687	35.25	PK-U	35.6	-23.4	0	47.45	-	-	74	-26.55	-	-	111	235	H
* 7.68	27.05	ADR	35.6	-23.3	-24	39.59	54	-14.41	-	-	-	-	111	235	H

* - indicates frequency in CFR47 Pt 15 / IC RSS-Restricted Band
 PK-U - U-NII: Maximum Peak
 ADR - U-NII AD primary method, RMS average

11.4.4. TX ABOVE 1GHz 802.11ac VHT80 2Tx CDD MODE IN THE 5.8GHz BAND BANDEDGE (Lower side)

HORIZONTAL PEAK PLOT

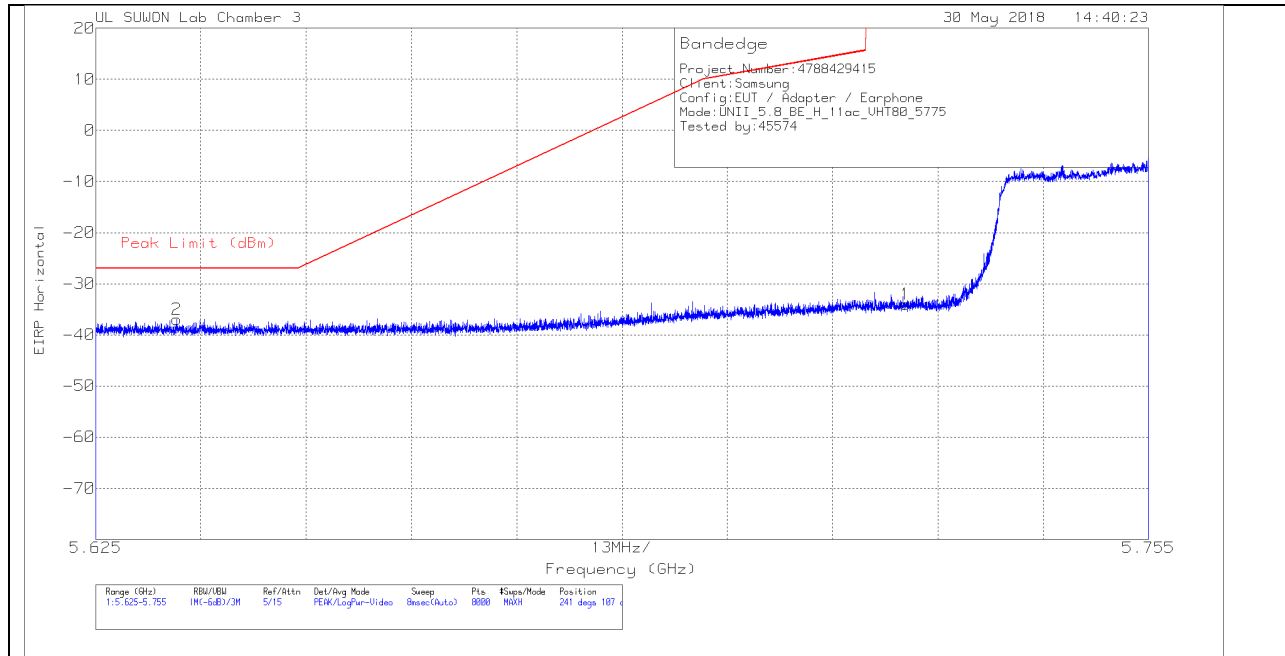

HORIZONTAL DATA

Trace Markers

Marker	Frequency (GHz)	Meter Reading (dBm)	Det	3117[00205959]	10dB_ATT[dB]	Conversion Factor (dB)	Corrected Reading EIRP	Peak Limit (dBm)	PK Margin (dB)	Azimuth (Degs)	Height (cm)	Polarity
1	5.725	-62.55	Pk	34.7	-17.9	11.8	-33.95	278.95	-312.9	241	107	H
2	5.635	-65.12	Pk	34.5	-18.1	11.8	-36.92	-27	-9.92	241	107	H

Pk - Peak detector

VERTICAL PEAK PLOT

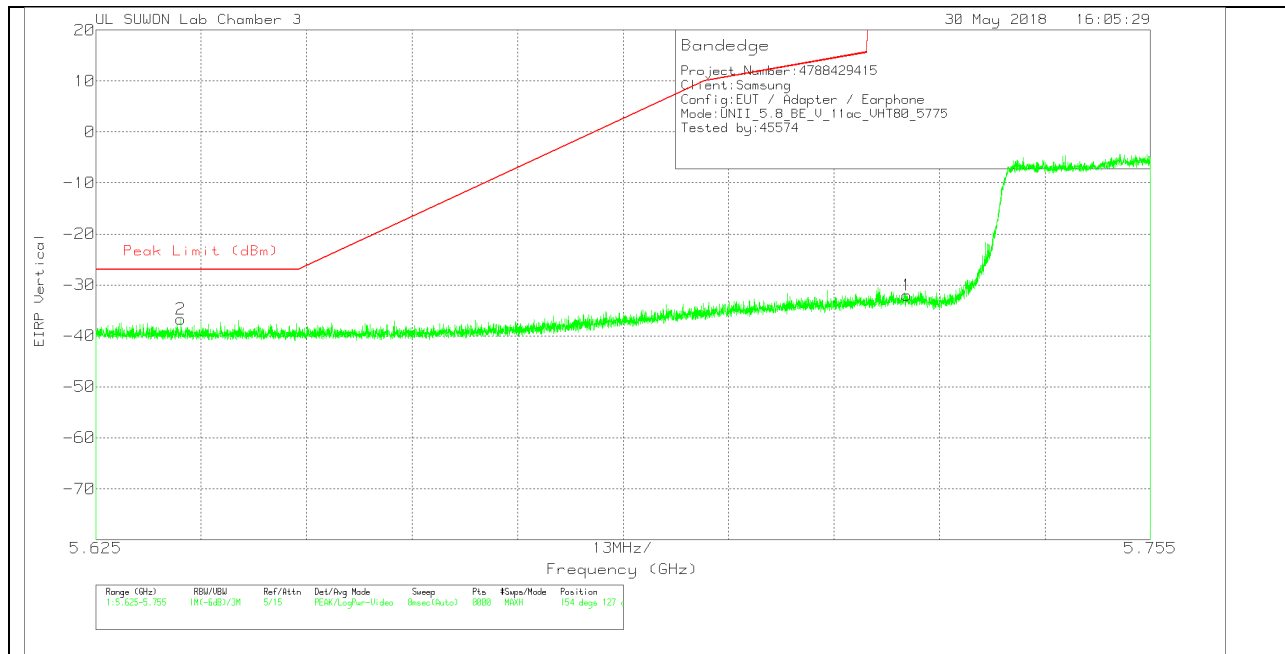

VERTICAL DATA

Trace Markers

Marker	Frequency (GHz)	Meter Reading (dBm)	Det	3117[00205959]	10dB_ATT[dB]	Conversion Factor (dB)	Corrected Reading EIRP	Peak Limit (dBm)	PK Margin (dB)	Azimuth (Degs)	Height (cm)	Polarity
1	5.725	-60.66	Pk	34.7	-17.9	11.8	-32.06	278.95	-311.01	154	127	V
2	5.635	-64.75	Pk	34.5	-18.2	11.8	-36.65	-27	-9.65	154	127	V

Pk - Peak detector

BANDEDGE (Upper side)

HORIZONTAL PEAK PLOT

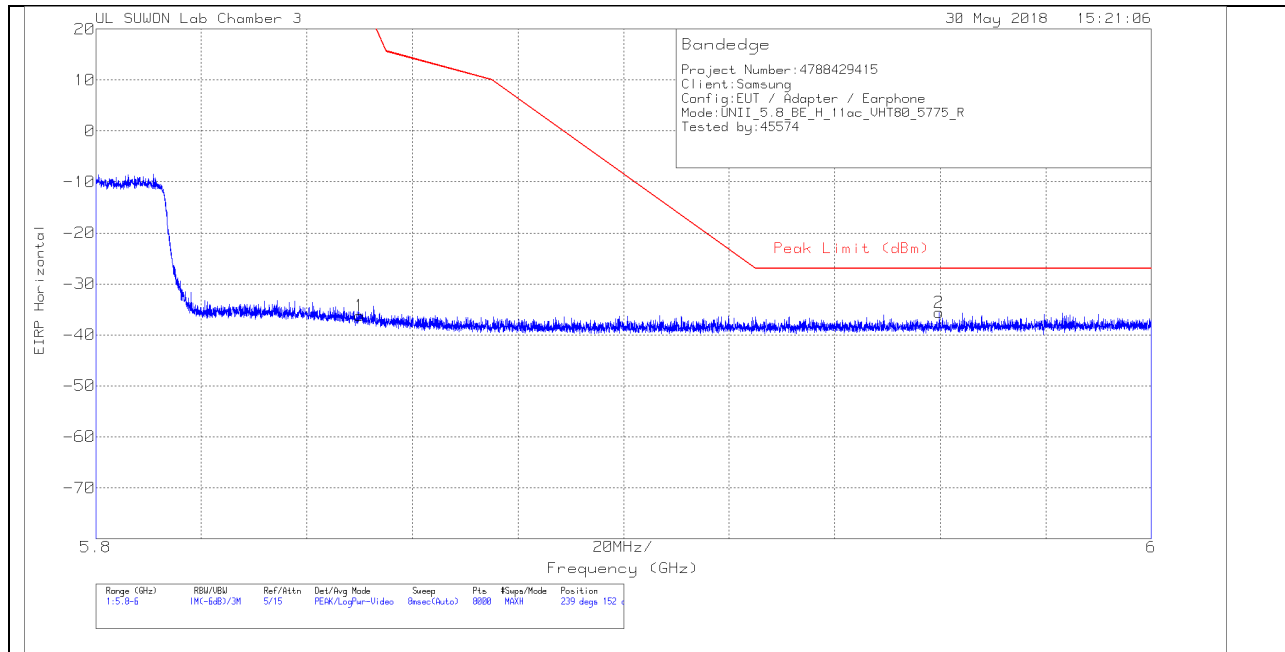

HORIZONTAL DATA

Trace Markers

Marker	Frequency (GHz)	Meter Reading (dBm)	Det	3117[00205959]	10dB_ATT[dB]	Conversion Factor (dB)	Corrected Reading EIRP	Peak Limit (dBm)	PK Margin (dB)	Azimuth (Degs)	Height (cm)	Polarity
1	5.85	-65.26	Pk	34.9	-17.6	11.8	-36.16	26.99	-63.15	239	152	H
2	5.96	-64.88	Pk	35	-17.5	11.8	-35.58	-27	-8.58	239	152	H

Pk - Peak detector

VERTICAL PEAK PLOT

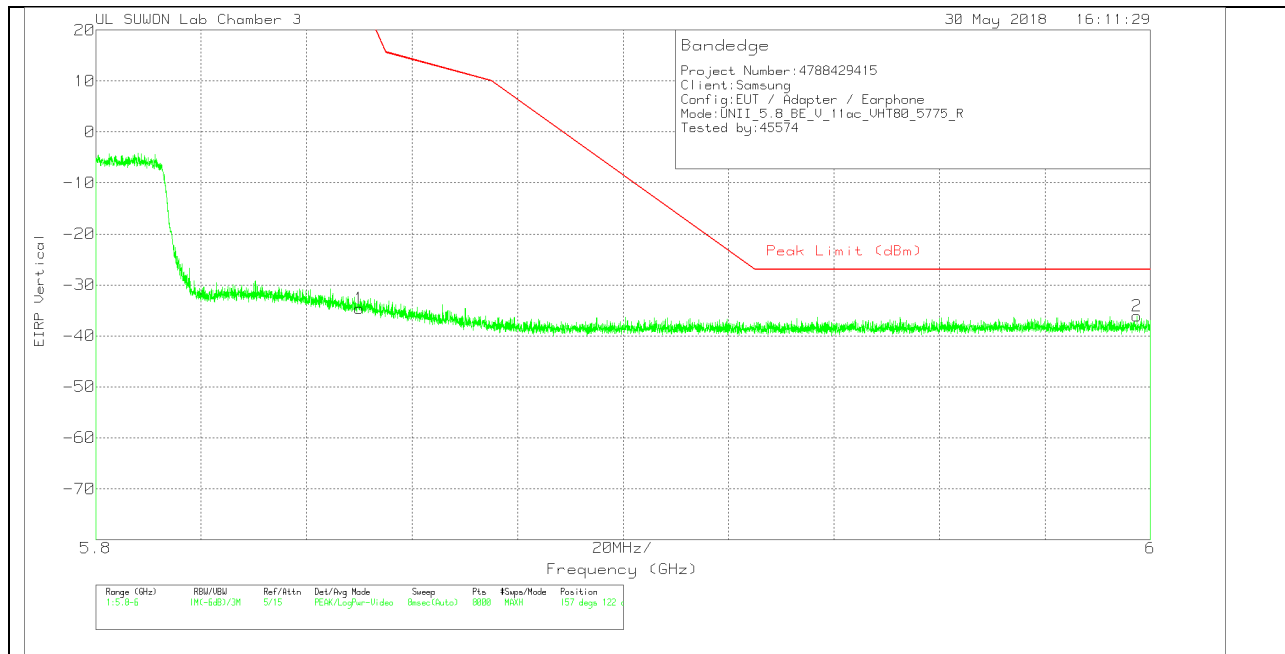

VERTICAL DATA

Trace Markers

Marker	Frequency (GHz)	Meter Reading (dBm)	Det	3117[00205959]	10dB_ATT[dB]	Conversion Factor (dB)	Corrected Reading EIRP	Peak Limit (dBm)	PK Margin (dB)	Azimuth (Degs)	Height (cm)	Polarity
1	5.85	-63.66	Pk	34.9	-17.6	11.8	-34.56	26.99	-61.55	157	122	V
2	5.997	-65.49	Pk	35.1	-17.5	11.8	-36.09	-27	-9.09	157	122	V

Pk - Peak detector

MID CHANNEL HORIZONTAL

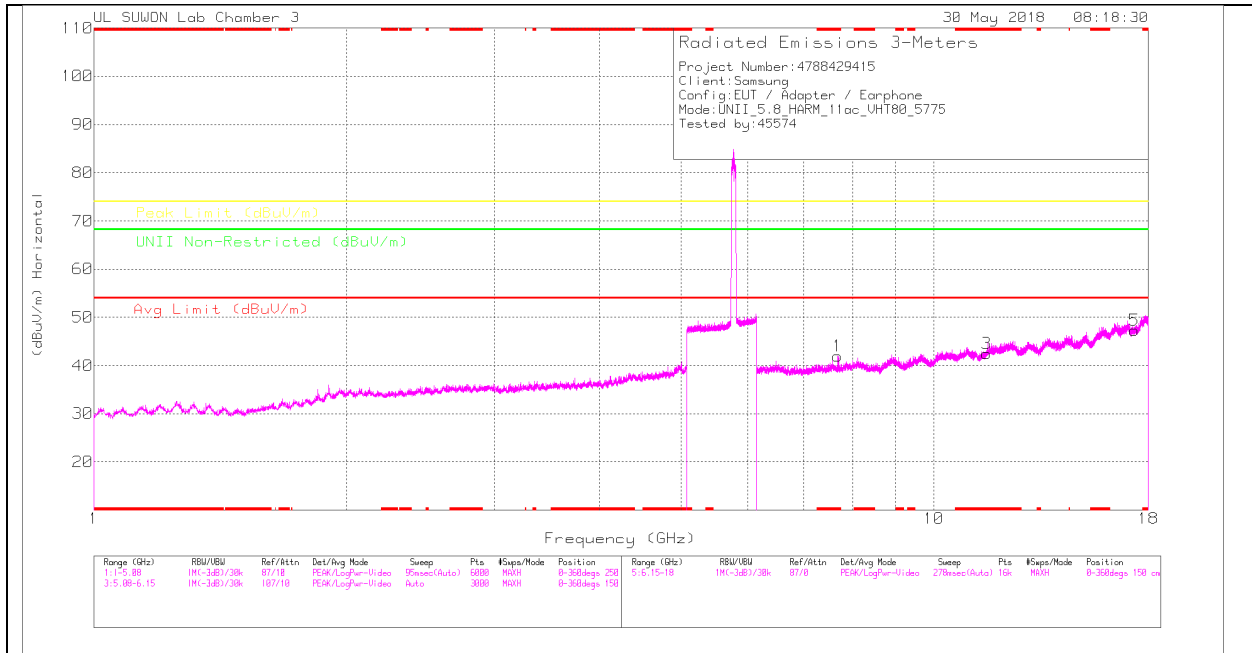

MID CHANNEL VERTICAL

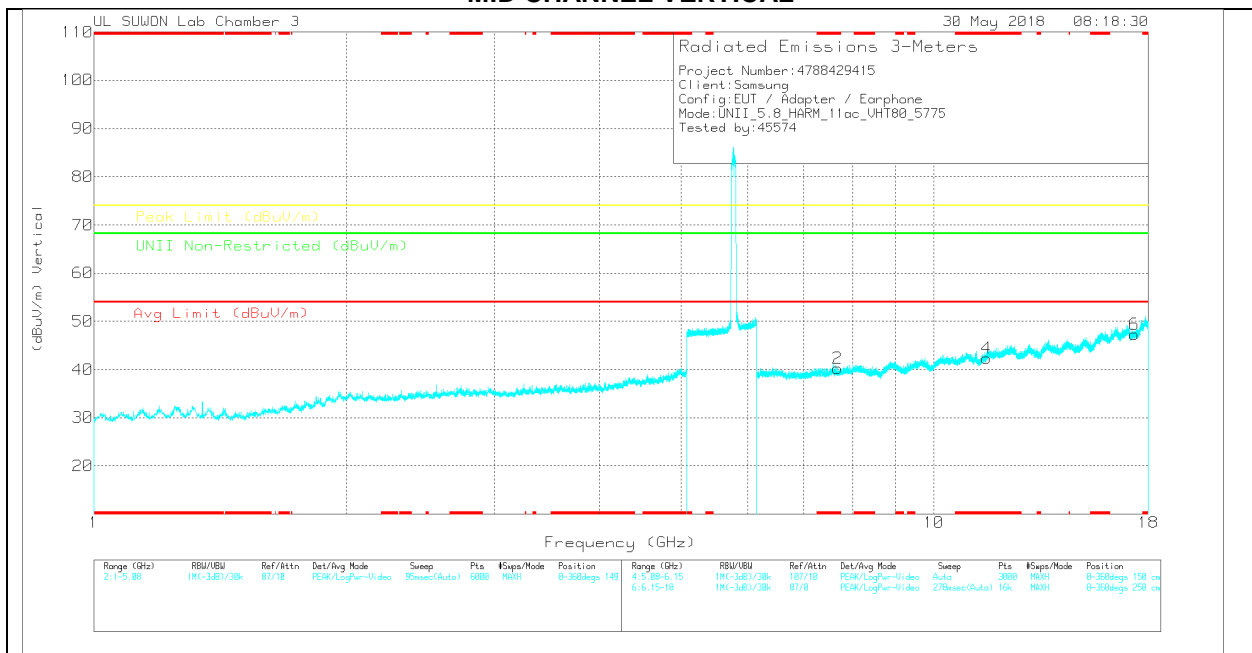

Note: Emission was scanned up to 40GHz; No emissions were detected above the noise floor which was at least 20dB below the specification limit.

MID CHANNEL DATA

Trace Markers

Marker	Frequency (GHz)	Meter Reading (dBuV)	Det	3117(0205959)	@GHz_HF(dB)	DC Corr (dB)	Corrected Reading (dBuV/m)	Aug Limit (dBuV/m)	Margin (dB)	Peak Limit (dBuV/m)	Margin (dB)	Limit Non-Restricted (dBuV/m)	Margin (dB)	Azimuth (Degs)	Height (cm)	Polarity
1	*7.679	29.72	PK	35.6	-23.3	0	42.02	-	-	74	-31.98	-	-	0-360	250	H
3	*11.55	24.03	PK	38.1	-19.7	0	42.43	-	-	74	-31.57	-	-	0-360	150	H
5	17.326	21.93	PK	40.8	-15.4	0	47.33	-	-	-	-	68.2	-20.87	0-360	250	H
2	*7.679	27.96	PK	35.6	-23.3	0	40.26	-	-	74	-33.74	-	-	0-360	250	V
4	*11.55	23.96	PK	38.1	-19.7	0	42.36	-	-	74	-31.64	-	-	0-360	250	V
6	17.326	21.95	PK	40.8	-15.4	0	47.35	-	-	-	-	68.2	-20.85	0-360	250	V

* - indicates frequency in CFR47 Pt 15 / IC RSS-Restricted Band
 PK – Peak Detector

Radiated Emissions

Frequency (GHz)	Meter Reading (dBuV)	Det	3117(0205959)	@GHz_HF(dB)	DC Corr (dB)	Corrected Reading (dBuV/m)	Aug Limit (dBuV/m)	Margin (dB)	Peak Limit (dBuV/m)	Margin (dB)	Limit Non-Restricted (dBuV/m)	Margin (dB)	Azimuth (Degs)	Height (cm)	Polarity
*7.68	33.77	PK-U	35.6	-23.3	0	46.07	-	-	74	-27.93	-	-	111	235	H
*7.68	27.15	ADR	35.6	-23.3	0	39.45	54	-14.55	-	-	-	-	111	235	H

* - indicates frequency in CFR47 Pt 15 / IC RSS-Restricted Band
 PK-U - U-NII: Maximum Peak
 ADR - U-NII AD primary method, RMS average

11.5. Spurious Emissions for Simultaneous Transmission

Simultaneous TX Condition

Frequency	Supported
2.4 GHz Antenna 1 + 5 GHz Antenna 2	Yes
2.4 GHz Antenna 2 + 5 GHz Antenna 1	No
2.4 GHz Antenna 1 + 5 GHz Antenna 1	No
2.4 GHz Antenna 2 + 5 GHz Antenna 2	No

11.5.1. Worst test case condition

	ANTENNA 1 - 2.4GHz	ANTENNA 2 - 5GHz
Mode	802.11 b mode	802.11 n H40 mode
Channel	11	159
Frequency	2462 MHz	5795 MHz
Data Rate	1 Mbps	MCS0

NOTE

Max conducted power condition(channel and mode) were selected worst test case condition on each antenna. No significant emissions were detected, but because some new emissions were created. So test lab. conducted additional test for below conditions. All test data complied FCC technical limit.

	ANTENNA 1 - 2.4GHz	ANTENNA 2 - 5GHz
Mode	802.11 b mode	802.11 n H40 mode
Channel	11	38
Frequency	2462 MHz	5190 MHz
Data Rate	1 Mbps	MCS0

	ANTENNA 1 - 2.4GHz	ANTENNA 2 - 5GHz
Mode	802.11 b mode	802.11 n H40 mode
Channel	11	54
Frequency	2462 MHz	5270 MHz
Data Rate	1 Mbps	MCS0

	ANTENNA 1 - 2.4GHz	ANTENNA 2 - 5GHz
Mode	802.11 b mode	802.11 n H40 mode
Channel	11	118
Frequency	2462 MHz	5590 MHz
Data Rate	1 Mbps	MCS0

RESULTS

11.5.1.1. Spurious emission for ANTENNA 1

802.11b 11 CHANNEL HORIZONTAL

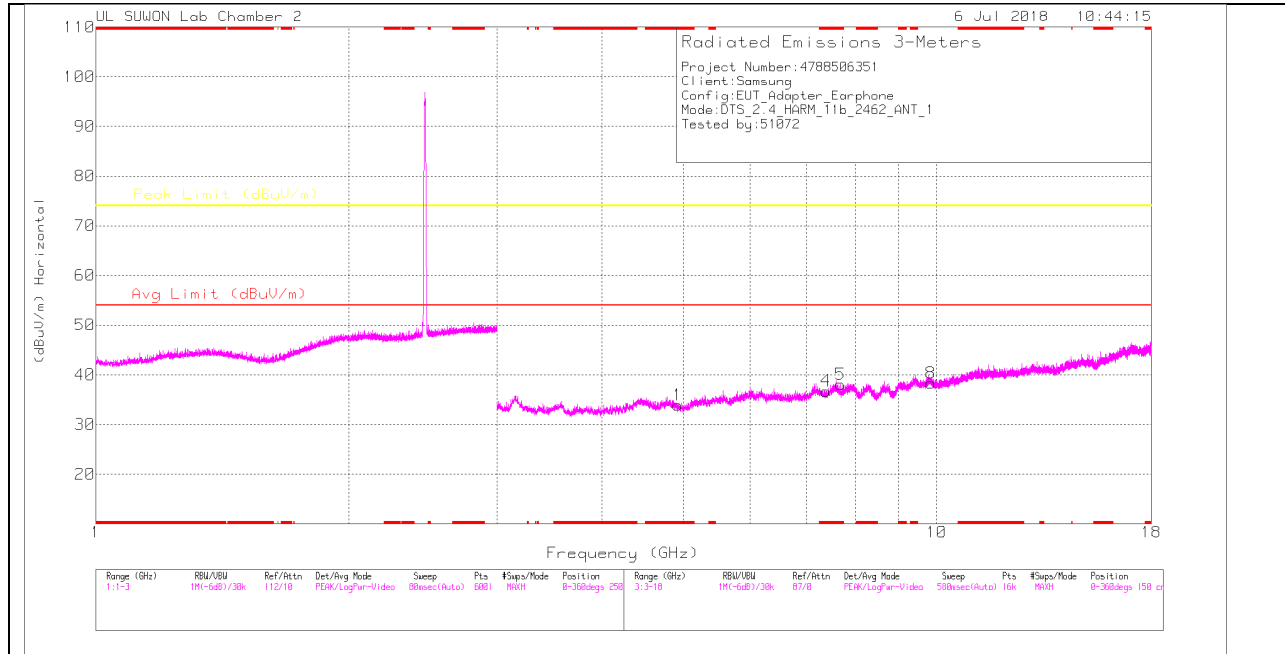

802.11b 11 CHANNEL VERTICAL

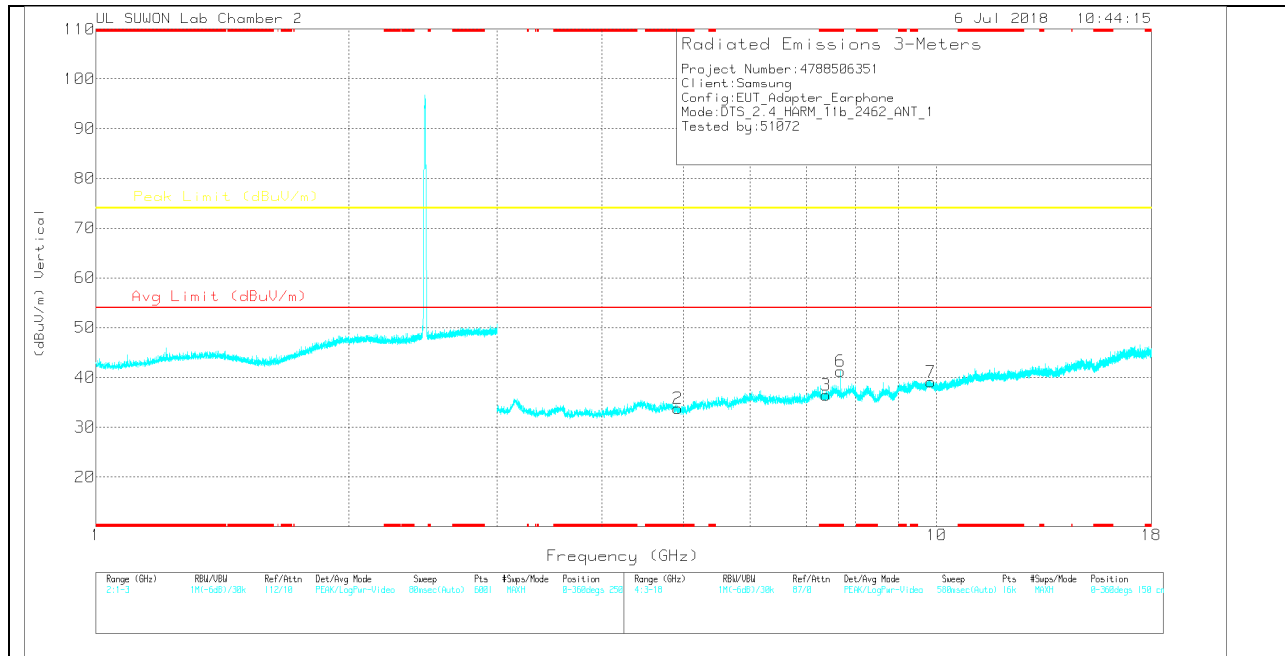

802.11b 11 CHANNEL VERTICAL

Trace Markers

Marker	Frequency (GHz)	Meter Reading (dBuV)	Det	170531_3117[00168724]	3GHz_HP[dB]	DC Corr (dB)	Corrected Reading (dBuV/m)	Avg Limit (dBuV/m)	Margin (dB)	Peak Limit (dBuV/m)	Margin (dB)	Azimuth (Degs)	Height (cm)	Polarity
1	* 4.925	24.85	PK	33.8	-24.7	0	33.95	-	-	74	-40.05	0-360	150	H
4	* 7.386	22.26	PK	35.9	-21.4	0	36.76	-	-	74	-37.24	0-360	150	H
5	* 7.68	23.73	PK	35.7	-21.3	0	38.13	-	-	74	-35.87	0-360	150	H
8	9.848	19.27	PK	37	-17.9	0	38.37	-	-	74	-35.63	0-360	150	H
2	* 4.925	24.73	PK	33.8	-24.7	0	33.83	-	-	74	-40.17	0-360	150	V
3	* 7.386	21.93	PK	35.9	-21.4	0	36.43	-	-	74	-37.57	0-360	250	V
6	* 7.68	26.8	PK	35.7	-21.3	0	41.2	-	-	74	-32.8	0-360	250	V
7	9.848	20.03	PK	37	-17.9	0	39.13	-	-	74	-34.87	0-360	250	V

* - indicates frequency in CFR47 Pt 15 / IC RSS-Restricted Band
 PK – Peak Detector

Radiated Emissions

Frequency (GHz)	Meter Reading (dBuV)	Det	170531_3117[00168724]	3GHz_HP[dB]	DC Corr (dB)	Corrected Reading (dBuV/m)	Avg Limit (dBuV/m)	Margin (dB)	Peak Limit (dBuV/m)	Margin (dB)	Azimuth (Degs)	Height (cm)	Polarity
* 7.679	31.45	PK2	35.7	-21.3	0	45.85	-	-	74	-28.15	138	354	H
* 7.68	19.32	MAv1	35.7	-21.3	0	33.72	54	-20.28	-	-	138	354	H

* - indicates frequency in CFR47 Pt 15 / IC RSS-Restricted Band
 PK2 - KDB558074 Method: Maximum Peak
 MAv1 - KDB558074 Option 1 Maximum RMS Average

11.5.1.2. Spurious emission for ANTENNA 2

802.11n HT40 159 CHANNEL HORIZONTAL

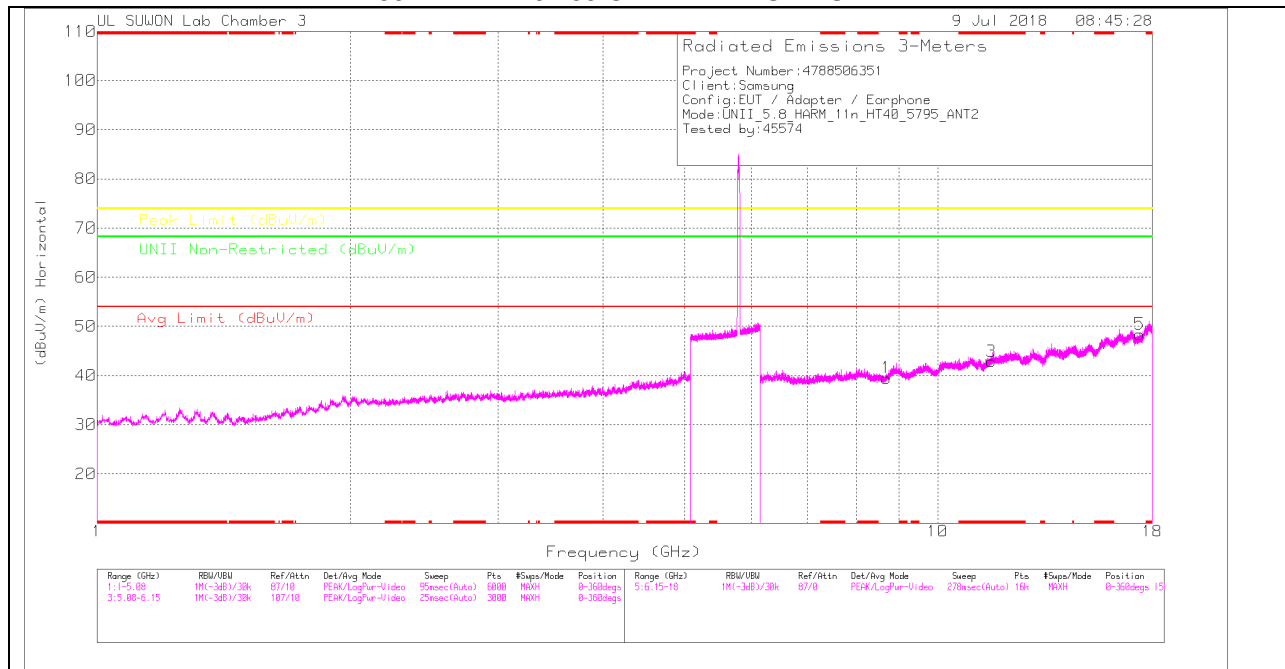

802.11n HT40 159 CHANNEL VERTICAL

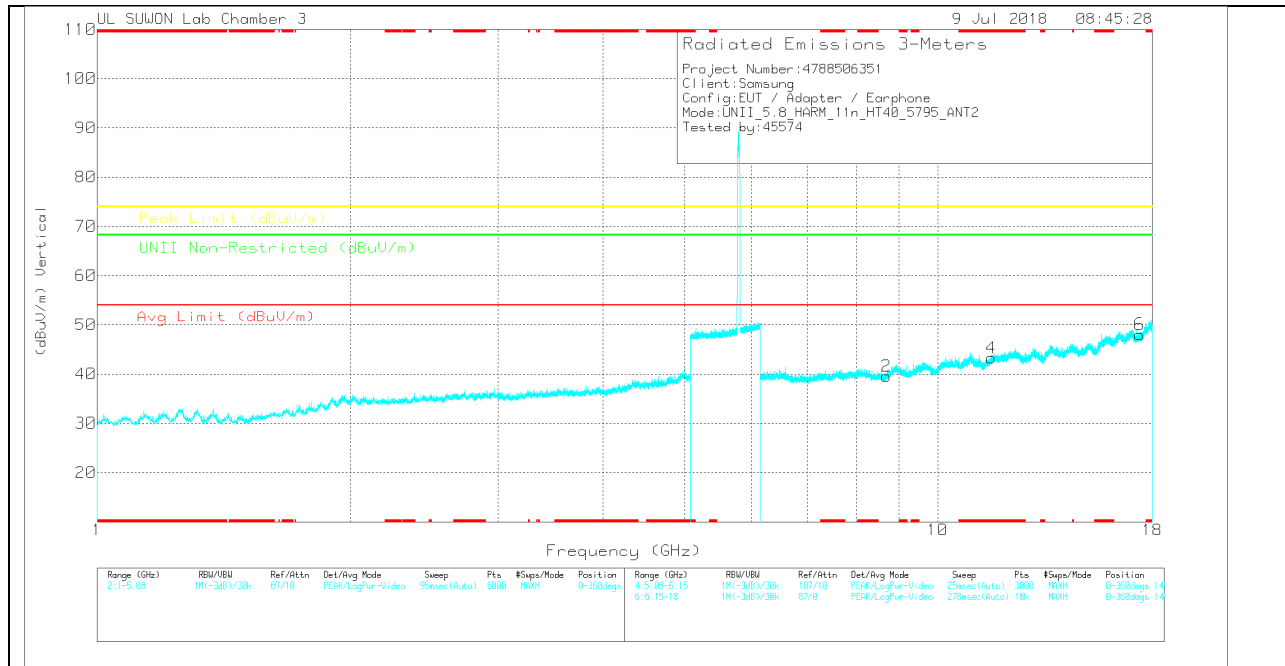

802.11n HT40 159 CHANNEL DATA

Trace Markers

Marker	Frequency (GHz)	Meter Reading (dBuV)	Det	3117(0205959)	6GHz_HP[dB]	DC Corr (dB)	Corrected Reading (dBuV/m)	Aug Limit (dBuV/m)	Margin (dB)	Peak Limit (dBuV/m)	Margin (dB)	UNII Non-Restricted (dBuV/m)	Margin (dB)	Azimuth (Degs)	Height (cm)	Polarity
1	8.693	24.91	PK	35.9	-21.3	0	39.51	-	-	-	-	68.2	-28.69	0-360	251	H
3	* 11.59	24.59	PK	38.1	-19.8	0	42.89	-	-	74	-31.11	-	-	0-360	150	H
5	17.385	22.82	PK	40.9	-15.3	0	48.42	-	-	-	-	68.2	-19.78	0-360	150	H
2	8.693	24.97	PK	35.9	-21.3	0	39.57	-	-	-	-	68.2	-28.63	0-360	251	V
4	* 11.59	24.95	PK	38.1	-19.8	0	43.25	-	-	74	-30.75	-	-	0-360	251	V
6	17.384	22.54	PK	40.9	-15.4	0	48.04	-	-	-	-	68.2	-20.16	0-360	251	V

* - indicates frequency in CFR47 Pt 15 / IC RSS-Restricted Band
 PK – Peak Detector

11.5.1.3. Spurious emission for Simultaneous Transmission

802.11b 11 CHANNEL + 802.11n HT40 159 CHANNEL HORIZONTAL

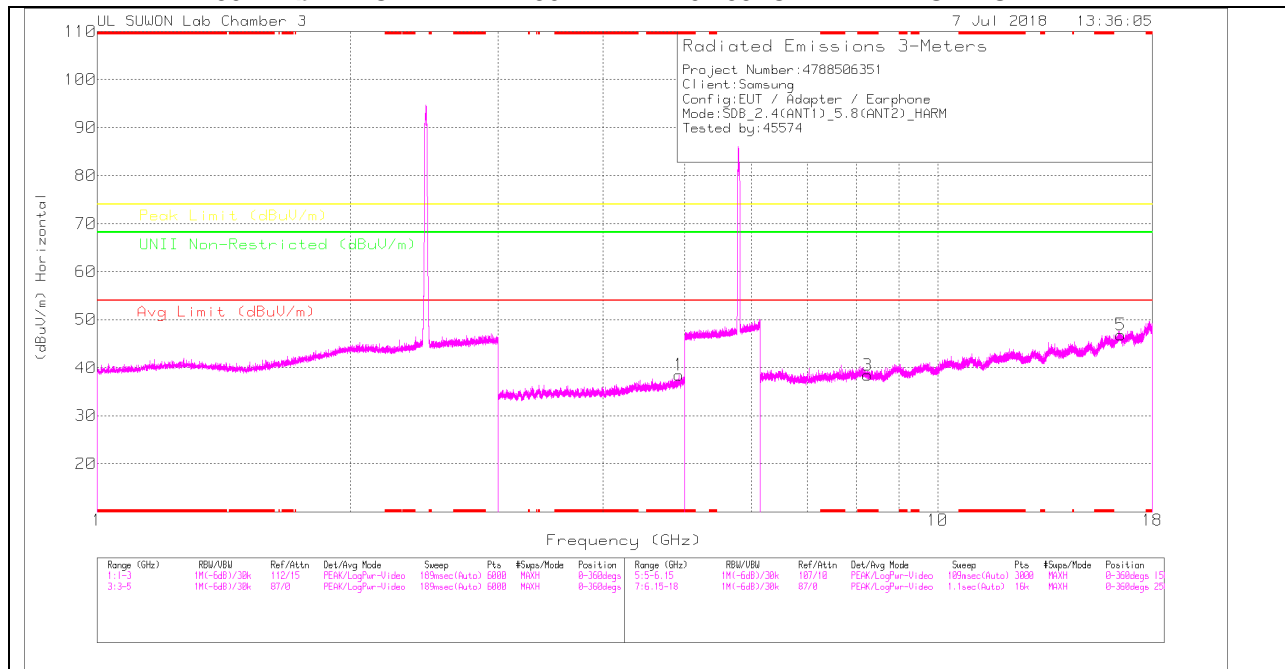

802.11b 11 CHANNEL + 802.11n HT40 159 CHANNEL VERTICAL

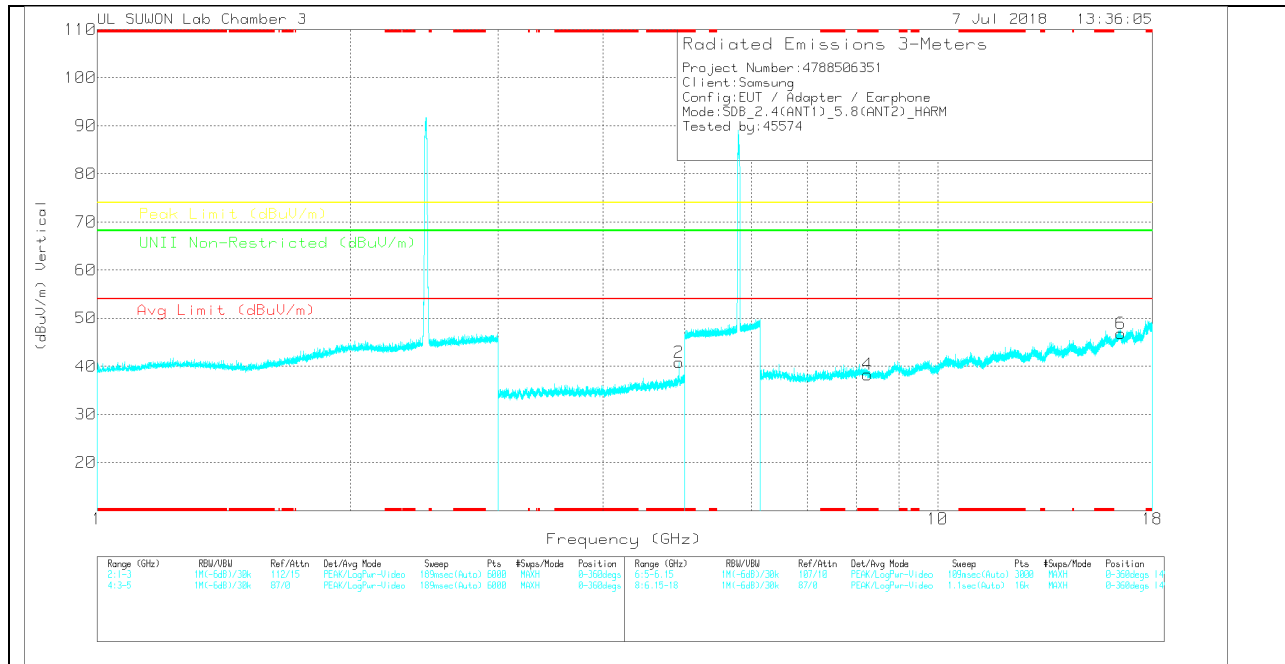

802.11b 11 CHANNEL + 802.11n HT40 159 CHANNEL DATA

Trace Markers

Marker	Frequency (GHz)	Meter Reading (dBuV)	Det	3117(0020959)	5GHz_LF(dB)	DTS_Notch	DC Corr (dB)	Corrected Reading (dBuV/m)	Avg Limit (dBuV/m)	Margin (dB)	Peak Limit (dBuV/m)	Margin (dB)	Limit Non-Restricted (dBuV/m)	Margin (dB)	Azimuth (Degs)	Height (cm)	Polarity
1	* 4.924	31.58	PK	34	-27.5	.A	0	38.48	-	-	74	-35.52	-	-	0-360	150	H
2	* 4.924	33.9	PK	34	-27.5	.A	0	40.8	-	-	74	-33.2	-	-	0-360	250	V

Marker	Frequency (GHz)	Meter Reading (dBuV)	Det	3117(0020959)	5GHz_HF(dB)	DTS_Notch	DC Corr (dB)	Corrected Reading (dBuV/m)	Avg Limit (dBuV/m)	Margin (dB)	Peak Limit (dBuV/m)	Margin (dB)	Limit Non-Restricted (dBuV/m)	Margin (dB)	Azimuth (Degs)	Height (cm)	Polarity
3	* 8.257	24.66	PK	35.8	-22		0	38.46	-	-	74	-35.54	-	-	0-360	250	H
5	16.513	22.84	PK	41.4	-17.4		0	46.84	-	-	-	-	68.2	-21.36	0-360	250	H
4	* 8.257	24.47	PK	35.8	-22		0	38.27	-	-	74	-35.73	-	-	0-360	250	V
6	16.515	22.79	PK	41.4	-17.4		0	46.79	-	-	-	-	68.2	-21.41	0-360	250	V

* - indicates frequency in CFR47 Pt 15 / IC RSS-Restricted Band
 PK – Peak Detector

Radiated Emissions

Frequency (GHz)	Meter Reading (dBuV)	Det	3117(0020959)	5GHz_LF(dB)	DTS_Notch	DC Corr (dB)	Corrected Reading (dBuV/m)	Avg Limit (dBuV/m)	Margin (dB)	Peak Limit (dBuV/m)	Margin (dB)	Limit Non-Restricted (dBuV/m)	Margin (dB)	Azimuth (Degs)	Height (cm)	Polarity
* 4.924	41.16	PK2	34	-27.5	.A	0	48.06	-	-	74	-25.94	-	-	128	157	H
* 4.924	30.33	MAV1	34	-27.5	.A	0	37.23	54	-16.77	-	-	-	-	128	157	H
* 4.924	42.89	PK2	34	-27.5	.A	0	49.79	-	-	74	-24.21	-	-	157	217	V
* 4.924	32.96	MAV1	34	-27.5	.A	0	39.86	54	-14.14	-	-	-	-	157	217	V

* - indicates frequency in CFR47 Pt 15 / IC RSS-Restricted Band
 PK2 - KDB558074 Method: Maximum Peak
 MAV1 - KDB558074 Option 1 Maximum RMS Average

12. WORST-CASE BELOW 1 GHz

SPURIOUS EMISSIONS 30 TO 1000 MHz (WORST-CASE CONFIGURATION, HORIZONTAL)

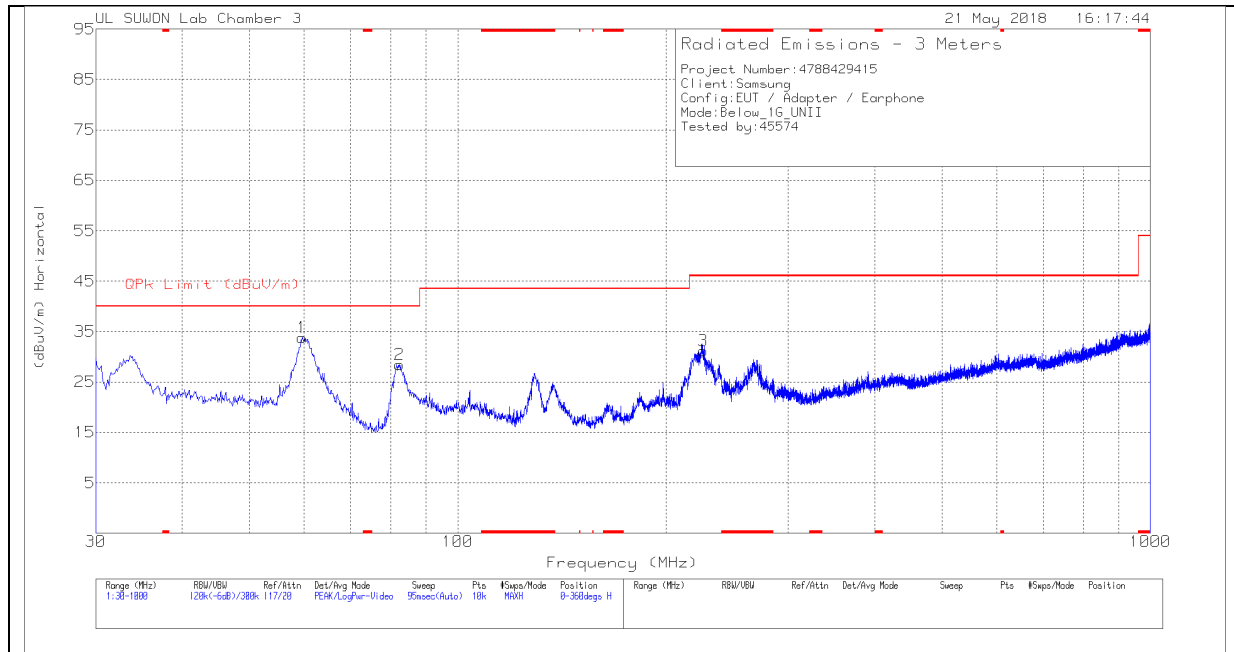

SPURIOUS EMISSIONS 30 TO 1000 MHz (WORST-CASE CONFIGURATION, VERTICAL)

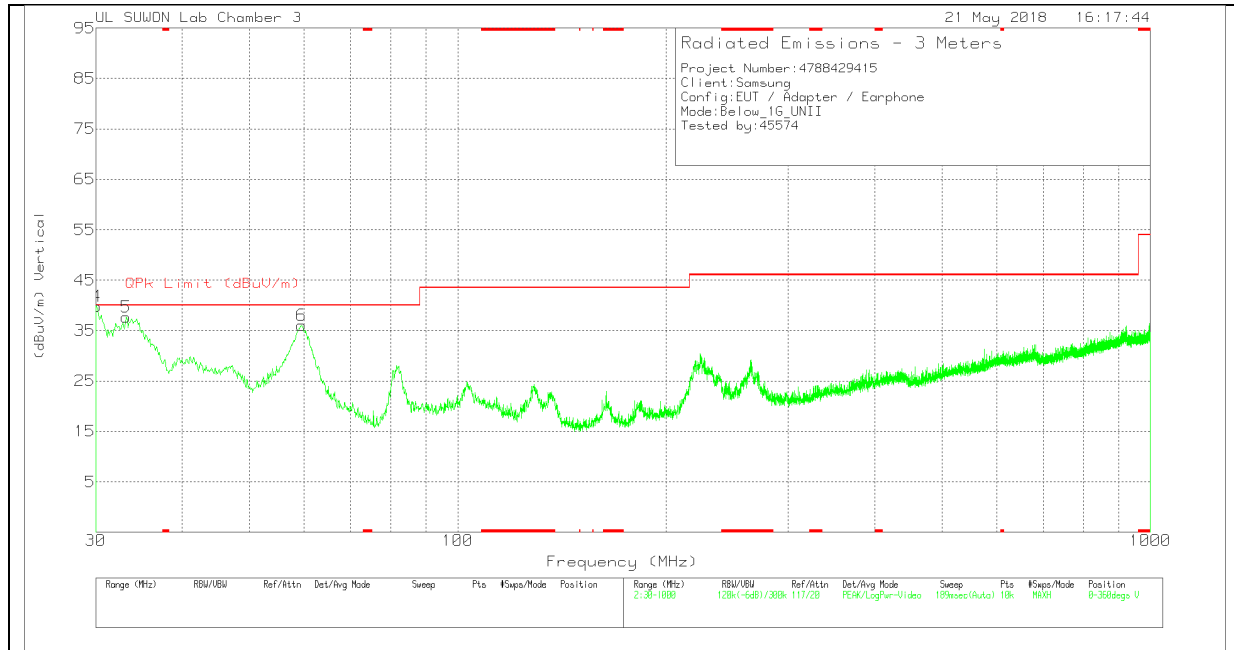

Below 1G Data

Trace Markers

Marker	Frequency (MHz)	Meter Reading (dBuV)	Det	VULB9163-845	30-1000MHz[dB]	Corrected Reading (dBuV/m)	QPk Limit (dBuV/m)	Margin (dB)	Azimuth (Degs)	Height (cm)	Polarity
1	59.5881	47.07	Pk	18.6	-31.8	33.87	40	-6.13	0-360	400	H
2	82.3854	46.42	Pk	13.6	-31.6	28.42	40	-11.58	0-360	200	H
3	225.9602	44.68	Pk	17.5	-31	31.18	46.02	-14.84	0-360	100	H
4	30.097	55.96	Pk	15.9	-32.1	39.76	40	-.24	0-360	100	V
5	33.2013	53.12	Pk	16.6	-32.1	37.62	40	-2.38	0-360	100	V
6	59.491	49.22	Pk	18.6	-31.8	36.02	40	-3.98	0-360	100	V

* - indicates frequency in CFR47 Pt 15 / IC RSS-Restricted Band

Pk - Peak detector

Radiated Emissions

Frequency (MHz)	Meter Reading (dBuV)	Det	VULB9163-845	30-1000MHz[dB]	Corrected Reading (dBuV/m)	QPk Limit (dBuV/m)	Margin (dB)	Azimuth (Degs)	Height (cm)	Polarity
59.5881	44.87	Qp	18.6	-31.8	31.67	40	-8.33	360	400	H
30.1685	50.83	Qp	16	-32.1	34.73	40	-5.27	274	114	V
33.2013	50.22	Qp	16.6	-32.1	34.72	40	-5.28	272	138	V
59.491	41.07	Qp	18.6	-31.8	27.87	40	-12.13	36	100	V

* - indicates frequency in CFR47 Pt 15 / IC RSS-Restricted Band

Qp - Quasi-Peak detector

SPURIOUS EMISSIONS 30 TO 1000 MHz (EQUIPPED WITH KEYBOARD, HORIZONTAL)

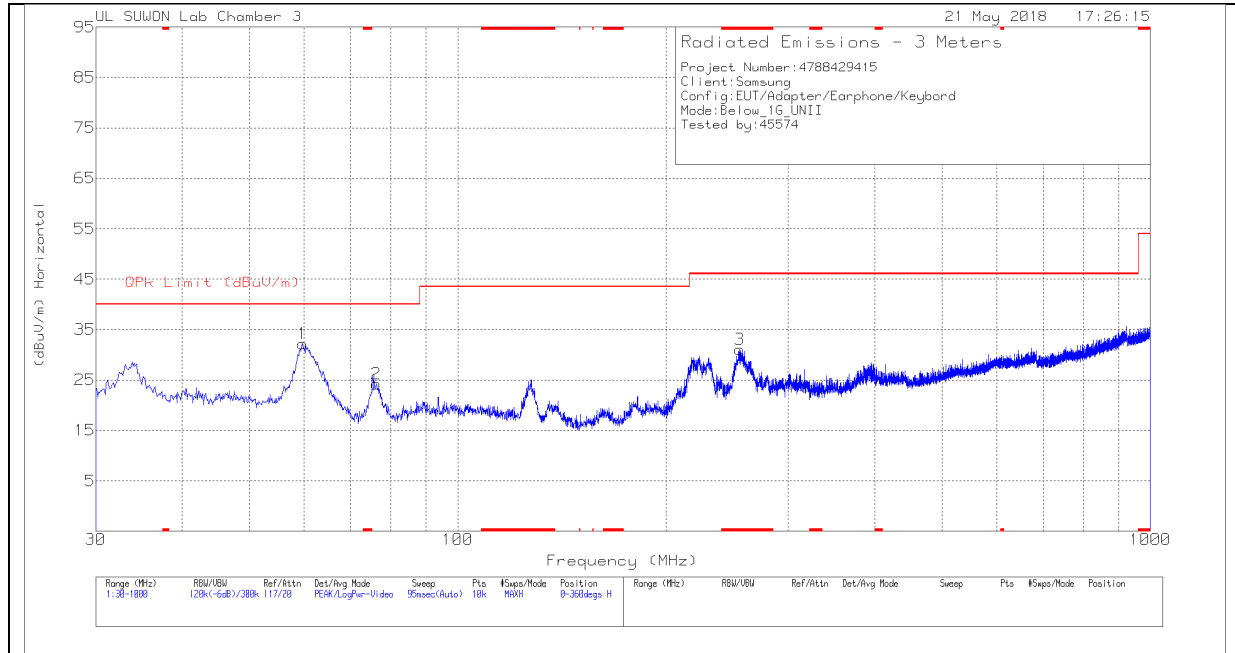

SPURIOUS EMISSIONS 30 TO 1000 MHz (EQUIPPED WITH KEYBOARD, VERTICAL)

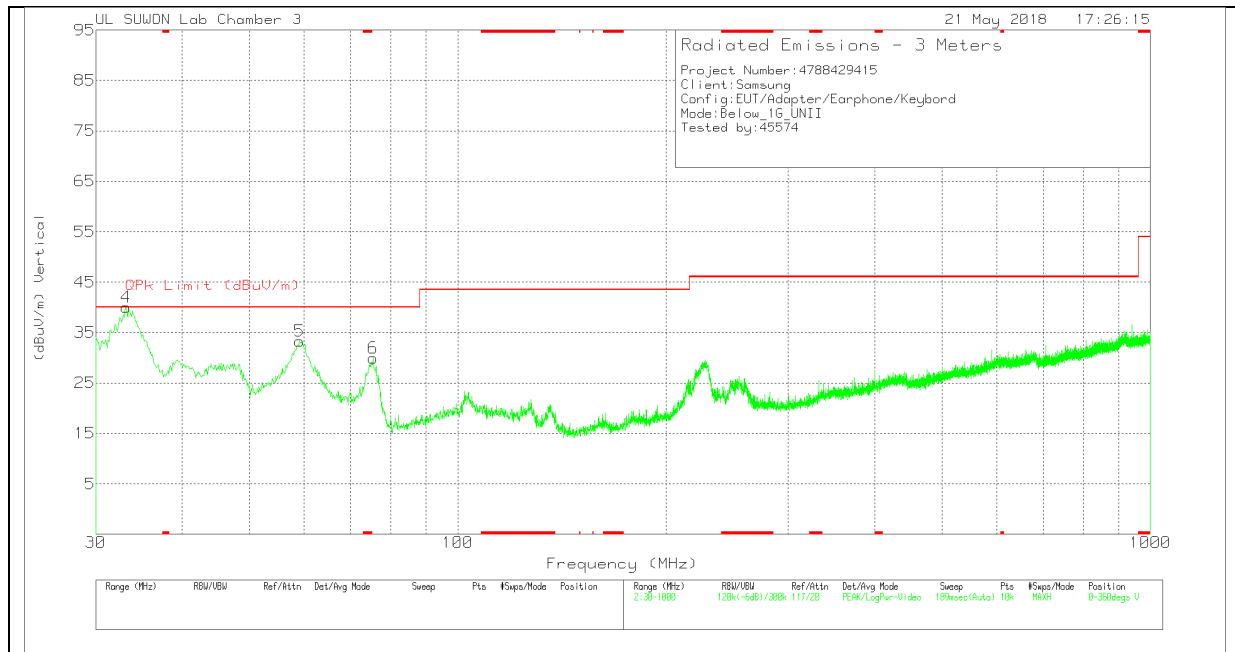

Below 1G Data

Trace Markers

Marker	Frequency (MHz)	Meter Reading (dBuV)	Det	VULB9163-845	30-1000MHz[dB]	Corrected Reading (dBuV/m)	QPk Limit (dBuV/m)	Margin (dB)	Azimuth (Degs)	Height (cm)	Polarity
1	59.6851	45.4	Pk	18.6	-31.8	32.2	40	-7.8	0-360	400	H
2	76.2253	42.67	Pk	13.3	-31.7	24.27	40	-15.73	0-360	200	H
3	* 255.4512	43.58	Pk	18.4	-30.9	31.08	46.02	-14.94	0-360	100	H
4	33.2013	55.51	Pk	16.6	-32.1	40.01	40	.01	0-360	100	V
5	59.103	46.55	Pk	18.7	-31.9	33.35	40	-6.65	0-360	100	V
6	75.4007	48.22	Pk	13.4	-31.7	29.92	40	-10.08	0-360	100	V

* - indicates frequency in CFR47 Pt 15 / IC RSS-Restricted Band

Pk - Peak detector

Radiated Emissions

Frequency (MHz)	Meter Reading (dBuV)	Det	VULB9163-845	30-1000MHz[dB]	Corrected Reading (dBuV/m)	QPk Limit (dBuV/m)	Margin (dB)	Azimuth (Degs)	Height (cm)	Polarity
33.2013	49.83	Qp	16.6	-32.1	34.33	40	-5.67	338	100	V
59.103	44.58	Qp	18.7	-31.9	31.38	40	-8.62	180	100	V
33.2013	50.22	Qp	16.6	-32.1	34.72	40	-5.28	272	138	V
59.491	41.07	Qp	18.6	-31.8	27.87	40	-12.13	36	100	V

* - indicates frequency in CFR47 Pt 15 / IC RSS-Restricted Band

Qp - Quasi-Peak detector

13. AC POWER LINE CONDUCTED EMISSIONS

LIMITS

FCC §15.207 (a)

Frequency of Emission (MHz)	Conducted Limit (dBuV)	
	Quasi-peak	Average
0.15-0.5	66 to 56	56 to 46
0.5-5	56	46
5-30	60	50

*Decreases with the logarithm of the frequency.

TEST PROCEDURE

The EUT is placed on a non-conducting table 40 cm from the vertical ground plane and 80 cm above the horizontal ground plane. The EUT is configured in accordance with ANSI C63.10.

The receiver is set to a resolution bandwidth of 9 kHz. Peak detection is used unless otherwise noted as quasi-peak or average.

Line conducted data is recorded for both NEUTRAL and HOT lines.

RESULTS

6 WORST EMISSIONS

LINE 1 PLOT

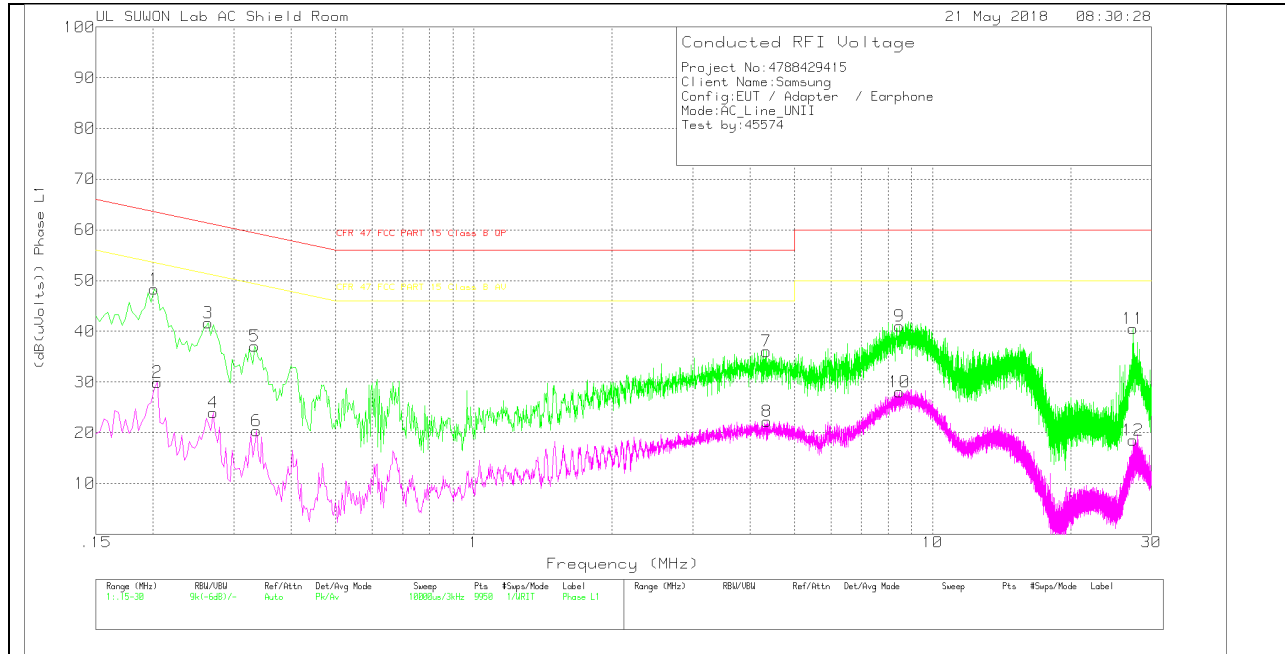

LINE 1 RESULTS

Trace Markers

Range 1: Phase L1 .15 - 30MHz

Marker	Frequency (MHz)	Meter Reading (dBuV)	Det	101837_L1_wit h extension	CABLELOSS(dB)	Corrected Reading (dB(uVolts))	CFR 47 FCC PART 15 Class B QP	Margin (dB)	CFR 47 FCC PART 15 Class B AV	Margin (dB)
1	.201	38.36	Pk	9.8	.2	48.36	63.57	-15.21	-	-
2	.204	19.96	Av	9.8	.2	29.96	-	-	53.45	-23.49
3	.264	32	Pk	9.5	.2	41.7	61.3	-19.6	-	-
4	.27	14.14	Av	9.6	.2	23.94	-	-	51.12	-27.18
5	.333	27.22	Pk	9.7	.2	37.12	59.38	-22.26	-	-
6	.336	10.43	Av	9.7	.2	20.33	-	-	49.3	-28.97
7	4.347	26.03	Pk	9.7	.3	36.03	56	-19.97	-	-
8	4.356	12.26	Av	9.7	.3	22.26	-	-	46	-23.74
9	8.475	31.07	Pk	9.7	.3	41.07	60	-18.93	-	-
10	8.475	18.1	Av	9.7	.3	28.1	-	-	50	-21.9
11	27.36	29.97	Pk	10.3	.3	40.57	60	-19.43	-	-
12	27.36	7.94	Av	10.3	.3	18.54	-	-	50	-31.46

Pk - Peak detector
 Av - Average detection

LINE 2 PLOT

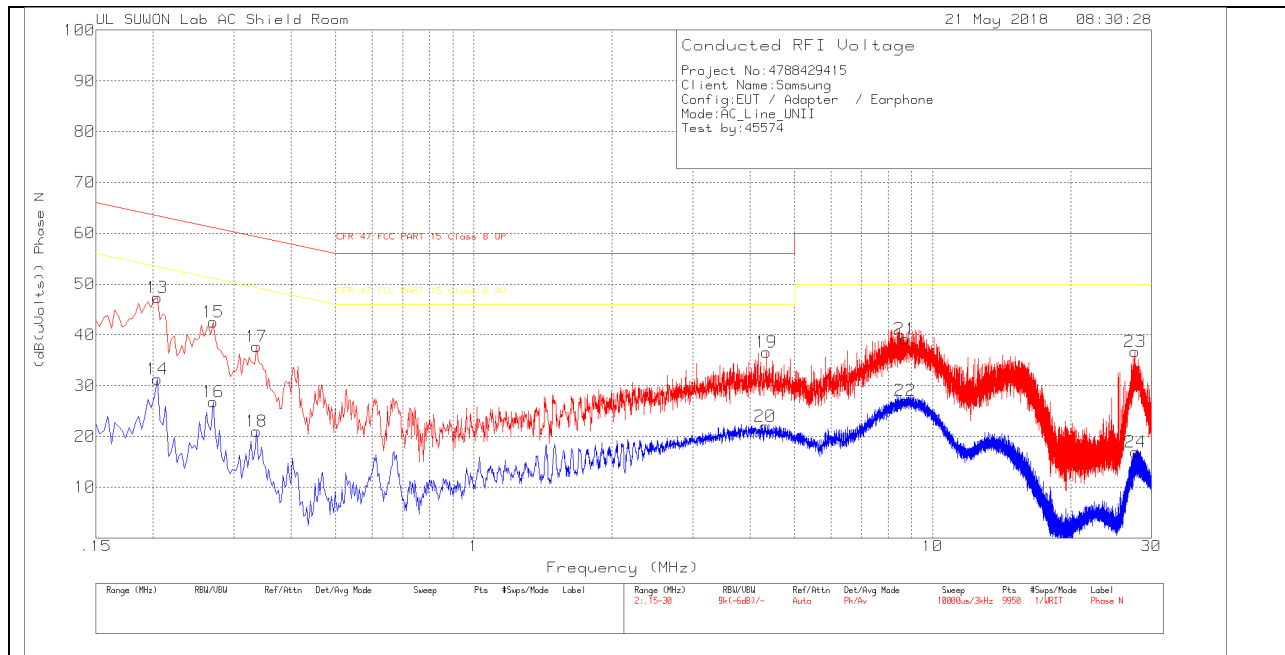

LINE 2 RESULTS

Trace Markers

Range 2: Phase N .15 - 30MHz

Marker	Frequency (MHz)	Meter Reading (dBuV)	Det	101837_N_with extension	CABLELOSS(dB)	Corrected Reading (dB(uVolts))	CFR 47 FCC PART 15 Class B QP	Margin (dB)	CFR 47 FCC PART 15 Class B AV	Margin (dB)
13	.204	37.33	Pk	9.8	.2	47.33	63.45	-16.12	-	-
14	.204	21.28	Av	9.8	.2	31.28	-	-	53.45	-22.17
15	.27	32.69	Pk	9.6	.2	42.49	61.12	-18.63	-	-
16	.27	17	Av	9.6	.2	26.8	-	-	51.12	-24.32
17	.336	27.84	Pk	9.7	.2	37.74	59.3	-21.56	-	-
18	.336	11.14	Av	9.7	.2	21.04	-	-	49.3	-28.26
19	4.344	26.51	Pk	9.8	.3	36.61	56	-19.39	-	-
20	4.32	11.93	Av	9.8	.3	22.03	-	-	46	-23.97
21	8.703	29	Pk	9.8	.4	39.2	60	-20.8	-	-
22	8.721	16.88	Av	9.8	.4	27.08	-	-	50	-22.92
23	27.666	26.15	Pk	10.3	.3	36.75	60	-23.25	-	-
24	27.705	6.32	Av	10.3	.3	16.92	-	-	50	-33.08

Pk - Peak detector

Av - Average detection

14. DYNAMIC FREQUENCY SELECTION

14.1. OVERVIEW

14.1.1. LIMITS

FCC

§15.407 (h), FCC KDB 905462 D02 "COMPLIANCE MEASUREMENT PROCEDURES FOR UNLICENSED-NATIONAL INFORMATION INFRASTRUCTURE DEVICES OPERATING IN THE 5250-5350 MHz AND 5470-5725 MHz BANDS INCORPORATING DYNAMIC FREQUENCY SELECTION" and KDB 905462 D03 "U-NII CLIENT DEVICES WITHOUT RADAR DETECTION CAPABILITY".

Table 1: Applicability of DFS requirements prior to use of a channel

Requirement	Operational Mode		
	Master	Client (without radar detection)	Client (with radar detection)
Non-Occupancy Period	Yes	Not required	Yes
DFS Detection Threshold	Yes	Not required	Yes
Channel Availability Check Time	Yes	Not required	Not required
U-NII Detection Bandwidth	Yes	Not required	Yes

Table 2: Applicability of DFS requirements during normal operation

Requirement	Operational Mode		
	Master	Client (without DFS)	Client (with DFS)
DFS Detection Threshold	Yes	Not required	Yes
Channel Closing Transmission Time	Yes	Yes	Yes
Channel Move Time	Yes	Yes	Yes
U-NII Detection Bandwidth	Yes	Not required	Yes

Additional requirements for devices with multiple bandwidth modes	Master Device or Client with Radar DFS	Client (without DFS)
U-NII Detection Bandwidth and Statistical Performance Check	All BW modes must be tested	Not required
Channel Move Time and Channel Closing Transmission Time	Test using widest BW mode available	Test using the widest BW mode available for the link
All other tests	Any single BW mode	Not required
Note: Frequencies selected for statistical performance check (Section 7.8.4) should include several frequencies within the radar detection bandwidth and frequencies near the edge of the radar detection bandwidth. For 802.11 devices it is suggested to select frequencies in all 20 MHz channel blocks and a null frequency between the bonded 20 MHz channel blocks.		

Table 3: Interference Threshold values, Master or Client incorporating In-Service Monitoring

Maximum Transmit Power	Value (see notes)
E.I.R.P. \geq 200 mill watt	-64 dBm
E.I.R.P. < 200 mill watt and power spectral density < 10 dBm/MHz	-62 dBm
E.I.R.P. < 200 mill watt that do not meet power spectral density requirement	-64 dBm
<p>Note 1: This is the level at the input of the receiver assuming a 0 dBi receive antenna</p> <p>Note 2: Throughout these test procedures an additional 1 dB has been added to the amplitude of the test transmission waveforms to account for variations in measurement equipment. This will ensure that the test signal is at or above the detection threshold level to trigger a DFS response.</p> <p>Note 3: E.I.R.P. is based on the highest antenna gain. For MIMO devices refer to KDB publication 662911 D01.</p>	

Table 4: DFS Response requirement values

Parameter	Value
<i>Non-occupancy period</i>	30 minutes
<i>Channel Availability Check Time</i>	60 seconds
<i>Channel Move Time</i>	10 seconds (See Note 1)
<i>Channel Closing Transmission Time</i>	200 milliseconds + approx. 60 milliseconds over remaining 10 second period. (See Notes 1 and 2)
<i>U-NII Detection Bandwidth</i>	Minimum 100% of the U-NII 99% transmission power bandwidth. (See Note 3)
<p>Note 1: <i>Channel Move Time</i> and the <i>Channel Closing Transmission Time</i> should be performed with Radar Type 0. The measurement timing begins at the end of the Radar Type 0 burst.</p> <p>Note 2: The <i>Channel Closing Transmission Time</i> is comprised of 200 milliseconds starting at the beginning of the <i>Channel Move Time</i> plus any additional intermittent control signals required to facilitate a <i>Channel</i> move (an aggregate of 60 milliseconds) during the remainder of the 10 second period. The aggregate duration of control signals will not count quiet periods in between transmissions.</p> <p>Note 3: During the <i>U-NII Detection Bandwidth</i> detection test, radar type 0 should be used. For each frequency step the minimum percentage of detection is 90 percent. Measurements are performed with no data traffic.</p>	

Table 5 – Short Pulse Radar Test Waveforms

Radar Type	Pulse Width (usec)	PRI (usec)	Pulses	Minimum Percentage of Successful Detection	Minimum Trials
0	1	1428	18	See Note 1	See Note 1
1	1	Test A: 15 unique PRI values randomly selected from the list of 23 PRI values in table 5a	Roundup: $\{(1/360) \times (19 \times 10^6 \text{ PRI}_{\text{usec}})\}$	60%	30
		Test B: 15 unique PRI values randomly selected within the range of 518-3066 usec. With a minimum increment of 1 usec, excluding PRI values selected in Test A			
2	1-5	150-230	23-29	60%	30
3	6-10	200-500	16-18	60%	30
4	11-20	200-500	12-16	60%	30
Aggregate (Radar Types 1-4)				80%	120
Note 1: Short Pulse Radar Type 0 should be used for the <i>Detection Bandwidth</i> test, <i>Channel Move Time</i> , and <i>Channel Closing Time</i> tests.					

Table 6 – Long Pulse Radar Test Signal

Radar Waveform Type	Pulse Width (µsec)	Chirp Width (MHz)	PRI (µsec)	Pulses per Burst	Number of Bursts	Minimum Percentage of Successful Detection	Minimum Trials
5	50-100	5-20	1000-2000	1-3	8-20	80%	30

Table 7 – Frequency Hopping Radar Test Signal

Radar Waveform Type	Pulse Width (µsec)	PRI (µsec)	Pulses per Hop	Hopping Rate (kHz)	Hopping Sequence Length (msec)	Minimum Percentage of Successful Detection	Minimum Trials
6	1	333	9	0.333	300	70%	30

14.1.1. TEST AND MEASUREMENT SYSTEM

CONDUCTED METHOD SYSTEM BLOCK DIAGRAM

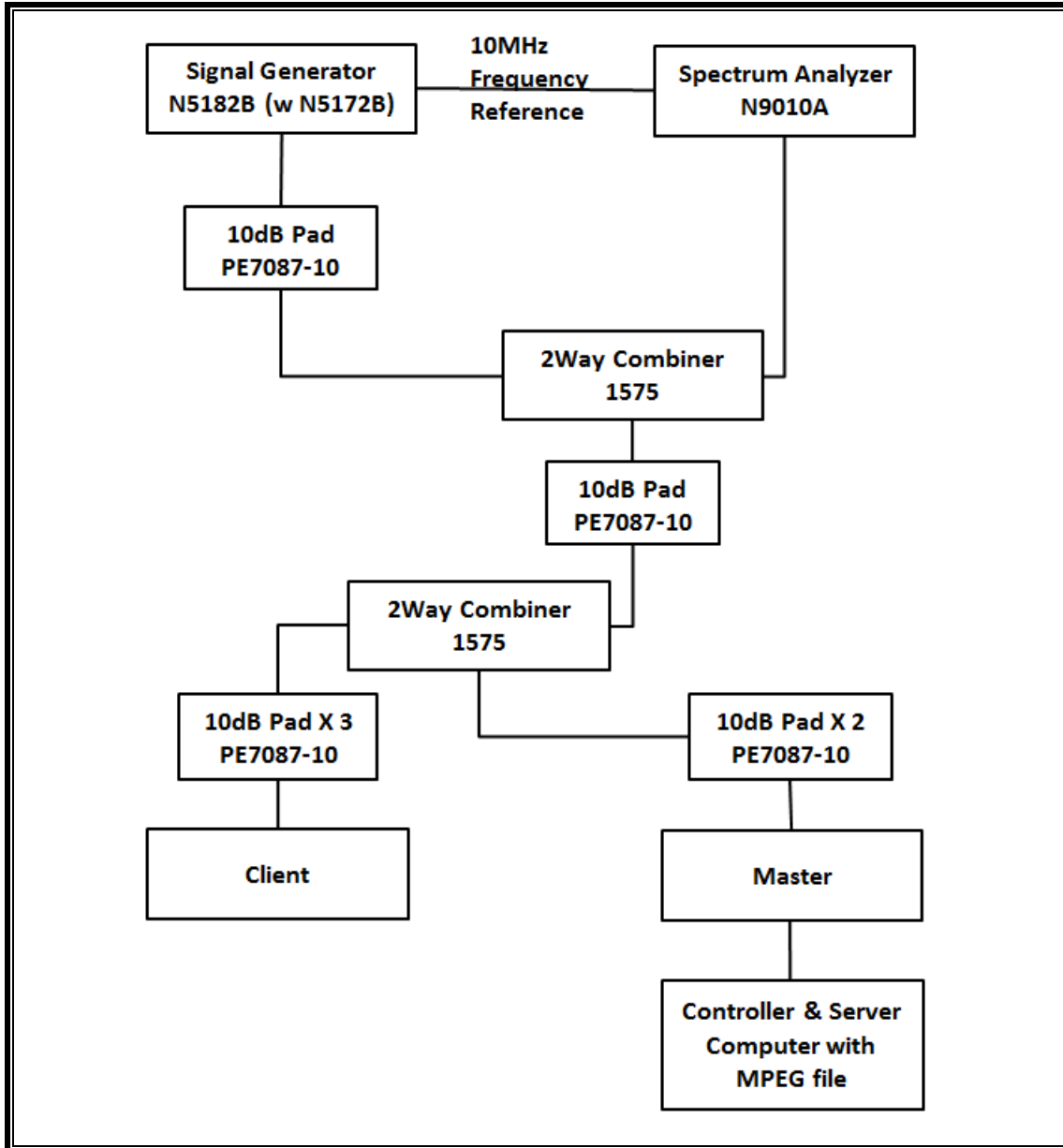

SYSTEM OVERVIEW

The short pulse and long pulse signal generating system utilizes the Keysite Signal Studio for Pulse Building as N5172B. The Vector Signal Generator has been validated by the NTIA. The hopping signal generating system utilizes the CCS simulated hopping method and system, which has been validated by the DoD, FCC and NTIA. The software selects waveform parameters from within the bounds of the signal type on a random basis using uniform distribution.

The short pulse types 1, 2, 3 and 4, and the long pulse type 5 parameters are randomized at run-time.

The hopping type 6 pulse parameters are fixed while the hopping sequence is based on the August 2005 NTIA Hopping Frequency List. The initial starting point randomized at run-time and each subsequent starting point is incremented by 475. Each frequency in the 100-length segment is compared to the boundaries of the EUT Detection Bandwidth and the software creates a hopping burst pattern in accordance with Section 7.4.1.3 Method #2 Simulated Frequency Hopping Radar Waveform Generating Subsystem of KDB 905462 D02. The frequency of the signal generator is incremented in 1 MHz steps from F_L to F_H for each successive trial. This incremental sequence is repeated as required to generate a minimum of 30 total trials and to maintain a uniform frequency distribution over the entire Detection Bandwidth.

The signal monitoring equipment consists of a spectrum analyzer. The aggregate ON time is calculated by multiplying the number of bins above a threshold during a particular observation period by the dwell time per bin, with the analyzer set to peak detection and max hold.

SYSTEM CALIBRATION

A 50-ohm load is connected in place of the spectrum analyzer, and the spectrum analyzer is connected to a horn antenna via a coaxial cable, with the reference level offset set to (horn antenna gain – coaxial cable loss). The signal generator is set to CW mode. The amplitude of the signal generator is adjusted to yield a level of –64 dBm as measured on the spectrum analyzer.

Without changing any of the instrument settings, the spectrum analyzer is reconnected to the Common port of the Spectrum Analyzer Combiner/Divider. The Reference Level Offset of the spectrum analyzer is adjusted so that the displayed amplitude of the signal is –64 dBm.

The spectrum analyzer displays the level of the signal generator as received at the antenna ports of the Master Device. The interference detection threshold may be varied from the calibrated value of –64 dBm and the spectrum analyzer will still indicate the level as received by the Master Device.

ADJUSTMENT OF DISPLAYED TRAFFIC LEVEL

A link is established between the Master and Slave and the distance between the units is adjusted as needed to provide a suitable received level at the Master and Slave devices. The video test file is streamed to generate WLAN traffic. The monitoring antenna is adjusted so that the WLAN traffic level, as displayed on the spectrum analyzer, is at lower amplitude than the radar detection threshold.

TEST AND MEASUREMENT EQUIPMENT

The following test and measurement equipment was utilized for the DFS tests documented in this report:

TEST EQUIPMENT LIST				
Description	Manufacturer	Model	S/N	Cal Due
Spectrum Analyzer, 7 GHz	Agilent / HP	N9010A	MY54200580	08-07-18
Vector Signal Generator, 6GHz	Agilent / HP	N5182B	MY53051241	08-07-18

14.1.2. SETUP OF EUT

CONDUCTED METHOD EUT TEST SETUP

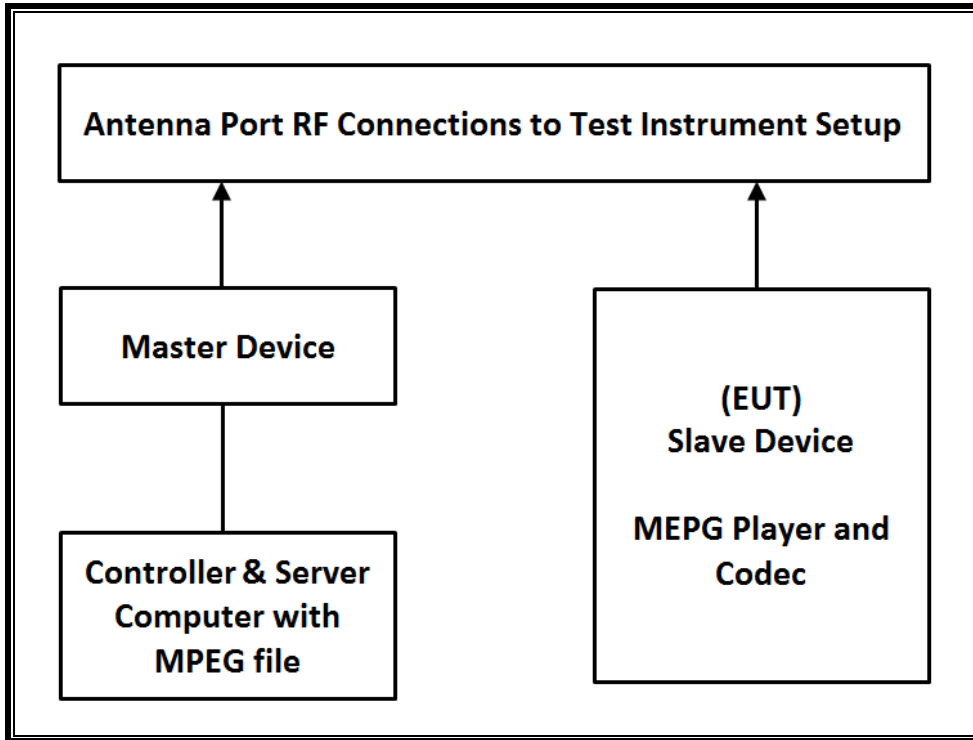

SUPPORT EQUIPMENT

The following support equipment was utilized for the DFS tests documented in this report:

PERIPHERAL SUPPORT EQUIPMENT LIST				
Description	Manufacturer	Model	Serial Number	FCC ID
Wireless Access Point	Cisco	AIR-CAP3702E-A-K9	FTX182276QX	LDK102087
Notebook PC (Controller/Server)	HP	HP EliteDesk 800 G1 TWR	CZC4125J25	DoC

14.1.3. DESCRIPTION OF EUT

The EUT operates over the 5250-5350 MHz and 5470-5725 MHz ranges.

The EUT is a Slave Device without Radar Detection.

The highest power level within these bands is 12.62 dBm in the 5250-5350 MHz band and 12.81 dBm in the 5470-5725 MHz band.

The antenna assembly utilized two antenna with the EUT one is -3.62 dBi, and the other is -5.37 dBi.

The rated output power of the Master unit is > 23dBm (EIRP). Therefore the required interference threshold level is -64 dBm. After correction for procedural adjustments, the required conducted threshold at the antenna port is $-64 + 1 = -63$ dBm.

The calibrated radiated DFS Detection Threshold level is set to -64 dBm. The tested level is lower than the required level hence it provides a margin to the limit.

The EUT uses one transmitter/receiver chain connected to an antenna to perform radiated tests.

WLAN traffic that meets or exceeds the minimum required loading was generated by transferring a data stream from the controller/server PC to the EUT using iPerf version 2.0.5 software package.

TPC is not required since the maximum EIRP is less than 500 mW (27 dBm).

The EUT utilizes the 802.11ac architecture. Three nominal channel bandwidths are implemented: 20 MHz, 40 MHz and 80 MHz.

The software installed in the access point is 12.4(25d)JA1.

UNIFORM CHANNEL SPREADING

This requirement is not applicable to Slave radio devices.

OVERVIEW OF MASTER DEVICE WITH RESPECT TO §15.407 (h) REQUIREMENTS

The Master Device is a Cisco Access Point, FCC ID: LDK102087. The minimum antenna gain for the Master Device is 6 dBi.

The rated output power of the Master unit is > 23dBm (EIRP). Therefore the required interference threshold level is -64 dBm. After correction for procedural adjustments, the required radiated threshold at the antenna port is $-64 + 1 = -63$ dBm.

The calibrated radiated DFS Detection Threshold level is set to -64 dBm. The tested level is lower than the required level hence it provides a margin to the limit.

14.2. RESULTS FOR 20 MHz BANDWIDTH

14.2.1. TEST CHANNEL

All tests were performed at a channel center frequency of 5500 MHz.

14.2.2. RADAR WAVEFORM AND TRAFFIC

RADAR WAVEFORM

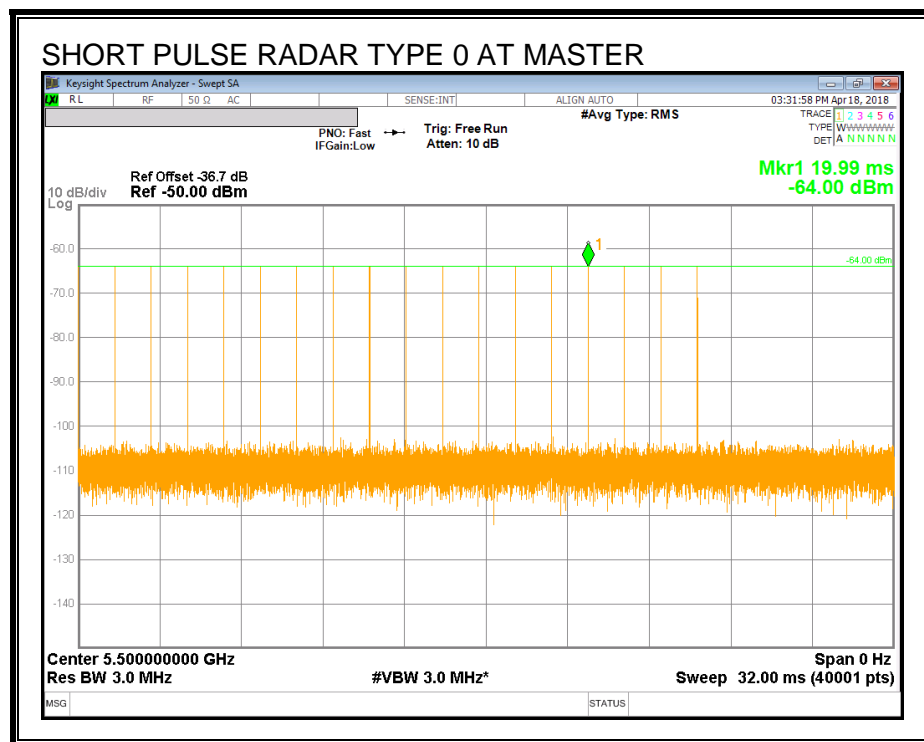

TRAFFIC

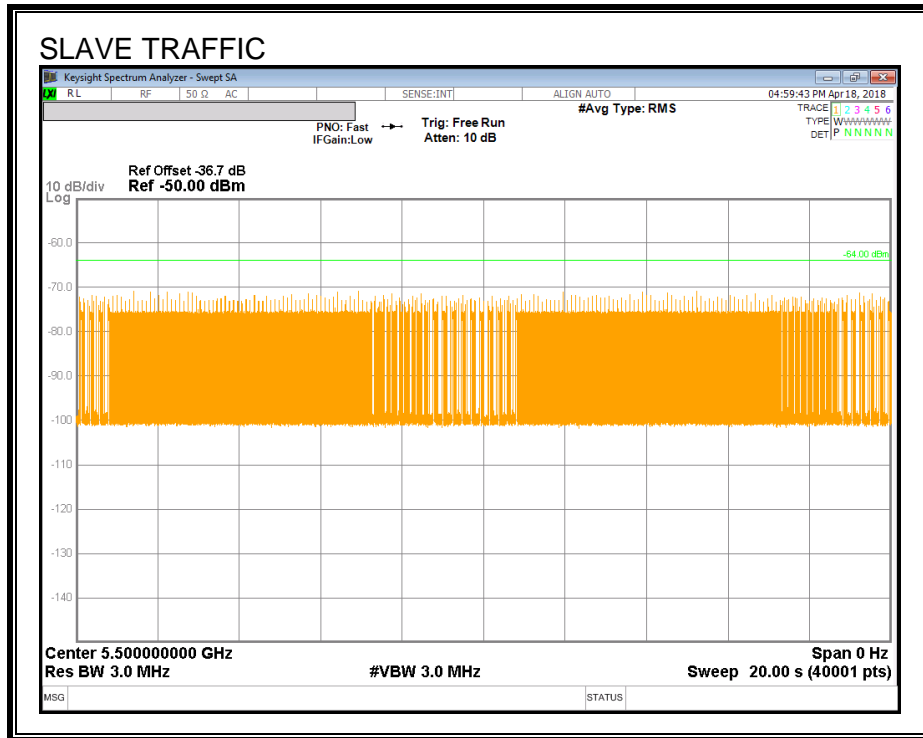

14.2.3. OVERLAPPING CHANNEL TESTS

RESULTS

These tests are not applicable.

14.2.4. MOVE AND CLOSING TIME

REPORTING NOTES

The reference marker is set at the end of last radar pulse.

The delta marker is set at the end of the last WLAN transmission following the radar pulse. This delta is the channel move time.

The aggregate channel closing transmission time is calculated as follows:

Aggregate Transmission Time =
(Number of analyzer bins showing transmission) * (dwell time per bin)

The observation period over which the aggregate time is calculated begins at (Reference Marker + 200 msec) and ends no earlier than (Reference Marker + 10 sec).

RESULTS

Channel Move Time (sec)	Limit (sec)
0.711	10

Aggregate Channel Closing Transmission Time (msec)	Limit (msec)
2.625	60

MOVE TIME & CHANNEL CLOSING TIME

AGGREGATE CHANNEL CLOSING TRANSMISSION TIME

No transmissions are observed during the aggregate monitoring period.

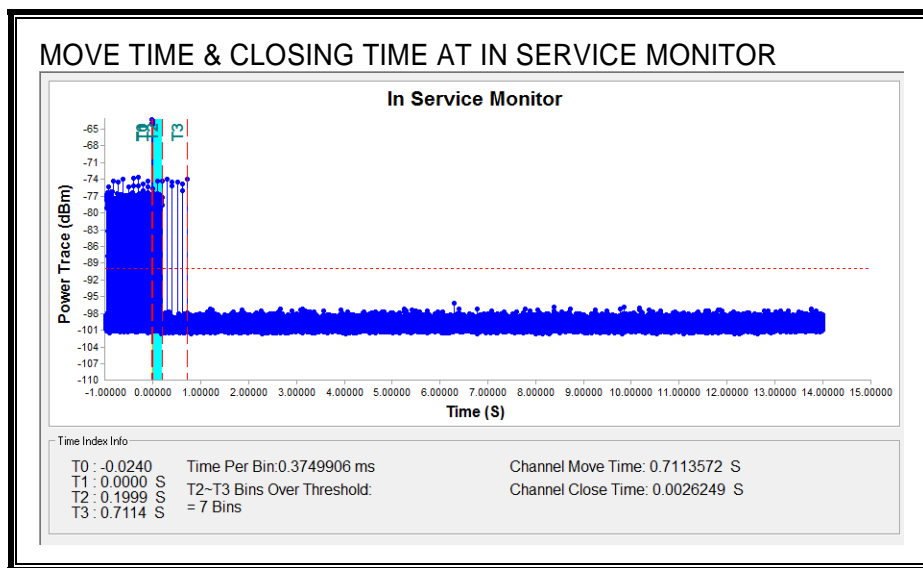
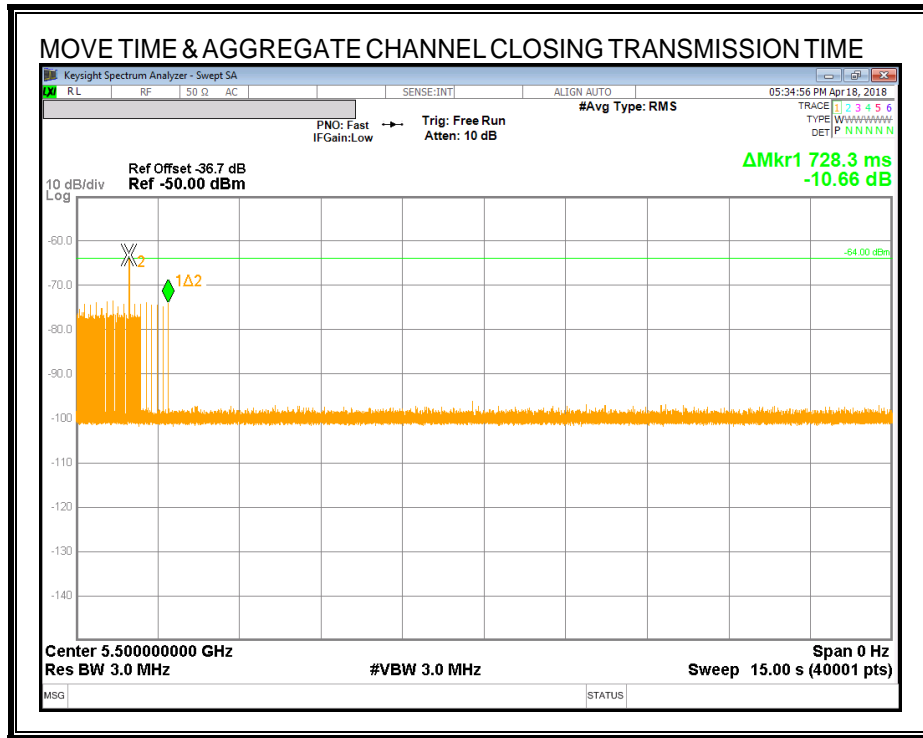

14.3. RESULTS FOR 40 MHz BANDWIDTH

14.3.1. TEST CHANNEL

All tests were performed at a channel center frequency of 5510 MHz.

14.3.2. RADAR WAVEFORM AND TRAFFIC

RADAR WAVEFORM

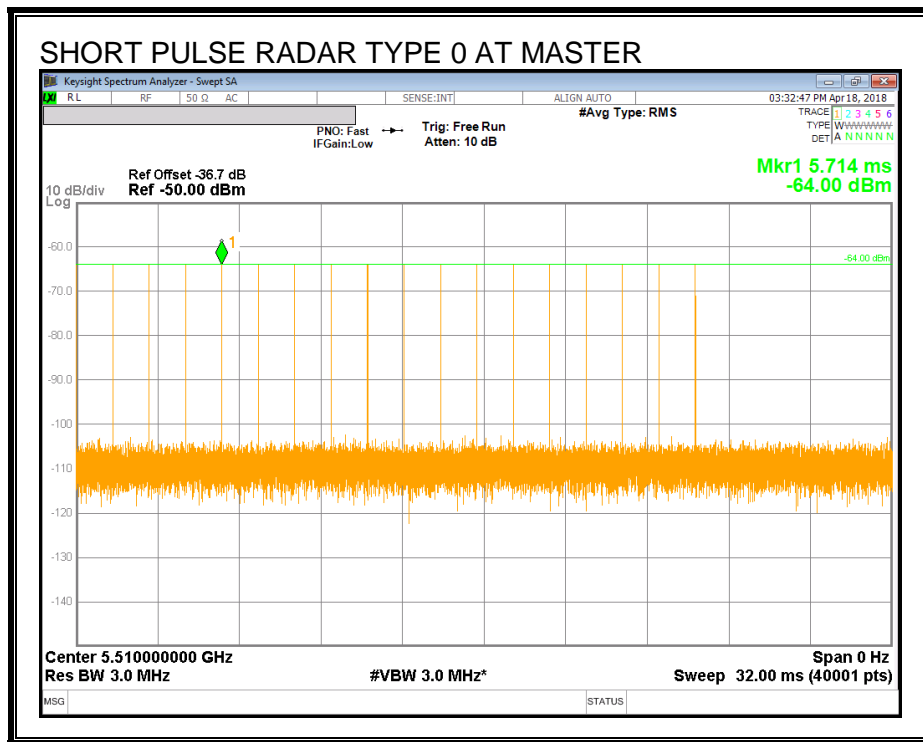

TRAFFIC

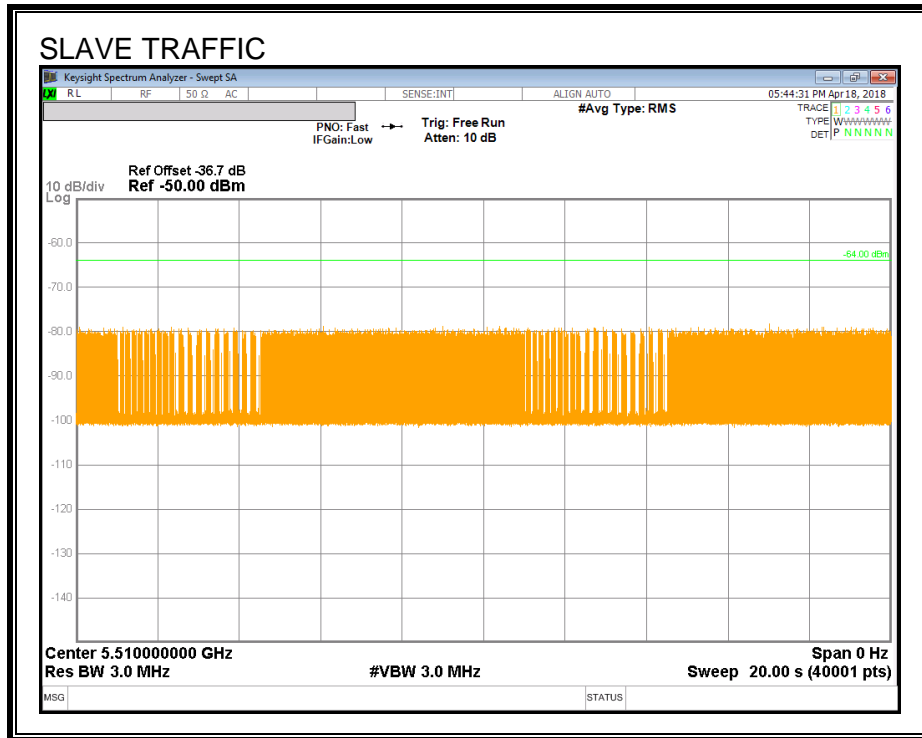

14.3.3. OVERLAPPING CHANNEL TESTS

RESULTS

These tests are not applicable.

14.3.4. MOVE AND CLOSING TIME

REPORTING NOTES

The reference marker is set at the end of last radar pulse.

The delta marker is set at the end of the last WLAN transmission following the radar pulse. This delta is the channel move time.

The aggregate channel closing transmission time is calculated as follows:

Aggregate Transmission Time =
(Number of analyzer bins showing transmission) * (dwell time per bin)

The observation period over which the aggregate time is calculated begins at (Reference Marker + 200 msec) and ends no earlier than (Reference Marker + 10 sec).

RESULTS

Channel Move Time (sec)	Limit (sec)
0.721	10

Aggregate Channel Closing Transmission Time (msec)	Limit (msec)
7.125	60

MOVE TIME & CHANNEL CLOSING TIME

AGGREGATE CHANNEL CLOSING TRANSMISSION TIME

No transmissions are observed during the aggregate monitoring period.

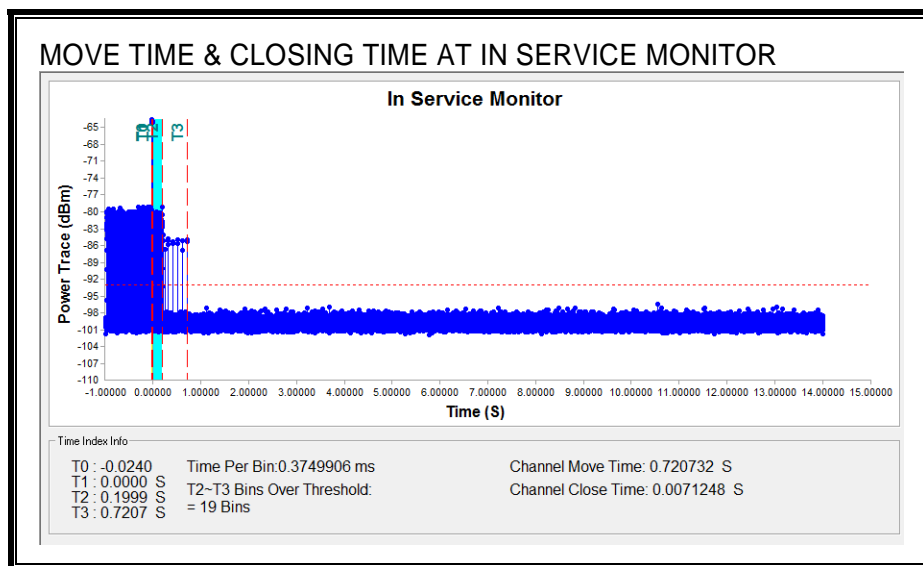
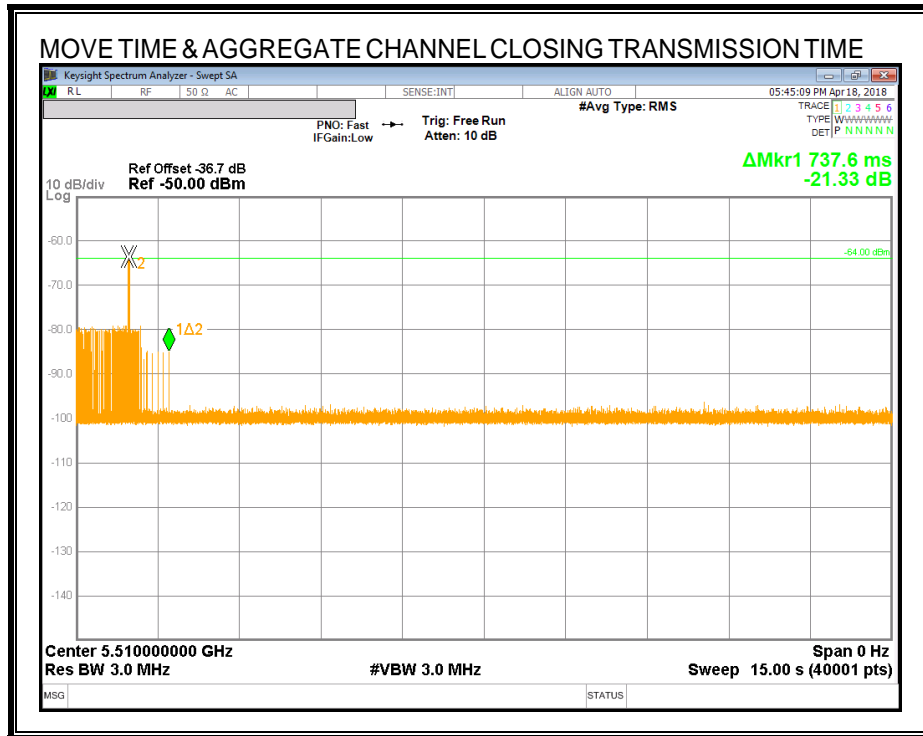

NON-OCCUPANCY PERIOD

RESULTS

No EUT transmissions were observed on the test channel during the 10-minute observation time.

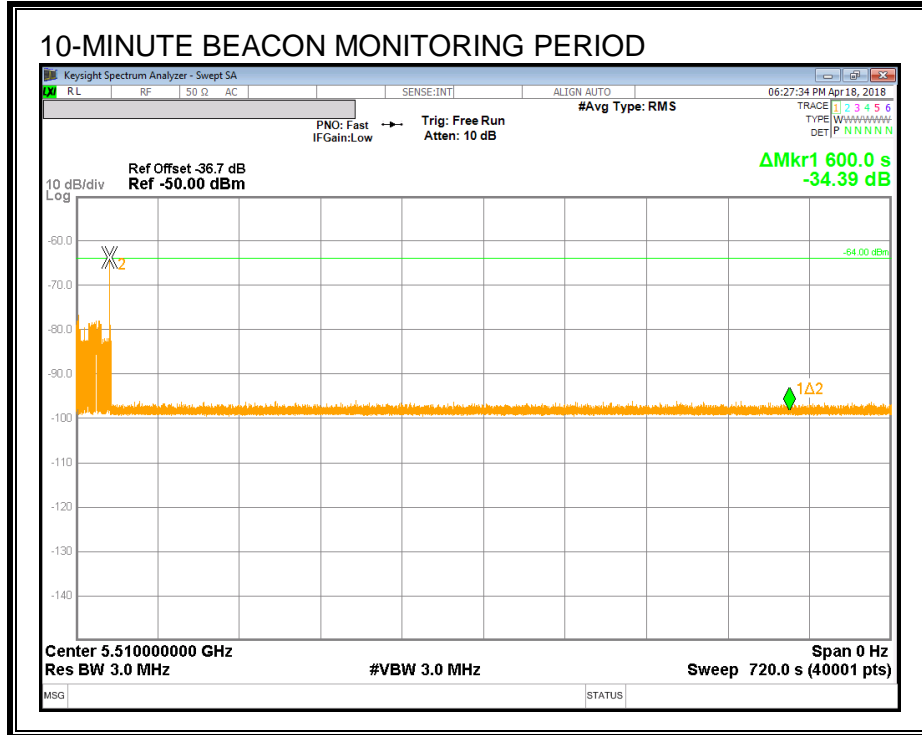

TRAFFIC

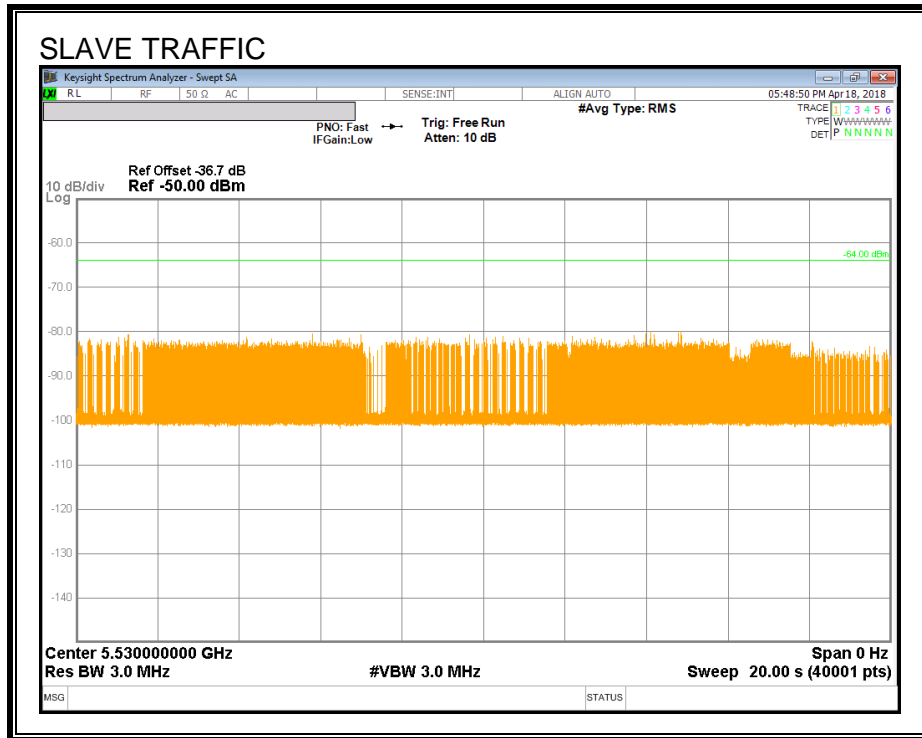

14.4.3. OVERLAPPING CHANNEL TESTS

RESULTS

These tests are not applicable.

14.4.4. MOVE AND CLOSING TIME

REPORTING NOTES

The reference marker is set at the end of last radar pulse.

The delta marker is set at the end of the last WLAN transmission following the radar pulse. This delta is the channel move time.

The aggregate channel closing transmission time is calculated as follows:

Aggregate Transmission Time =
(Number of analyzer bins showing transmission) * (dwell time per bin)

The observation period over which the aggregate time is calculated begins at (Reference Marker + 200 msec) and ends no earlier than (Reference Marker + 10 sec).

RESULTS

Channel Move Time (sec)	Limit (sec)
3.525	10

Aggregate Channel Closing Transmission Time (msec)	Limit (msec)
0.375	60

MOVE TIME & CHANNEL CLOSING TIME

AGGREGATE CHANNEL CLOSING TRANSMISSION TIME

No transmissions are observed during the aggregate monitoring period.

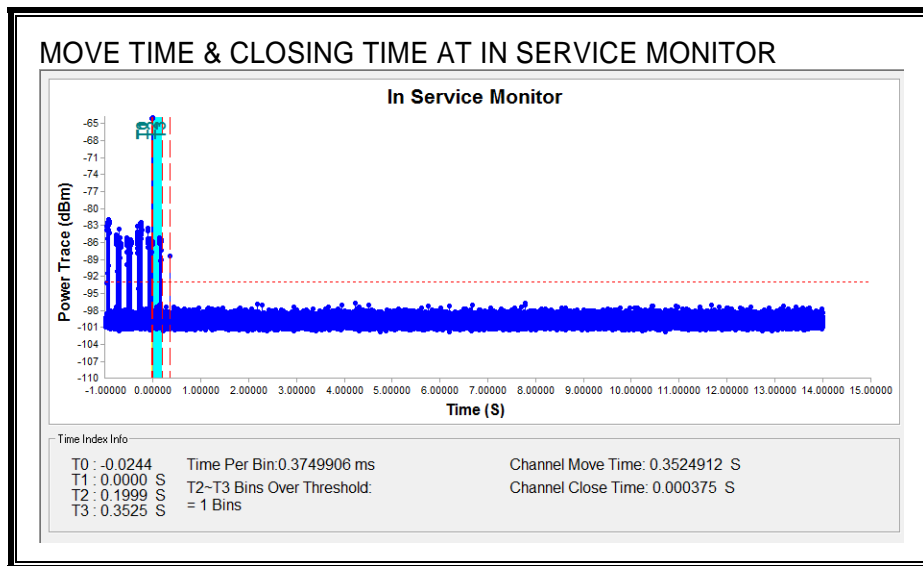
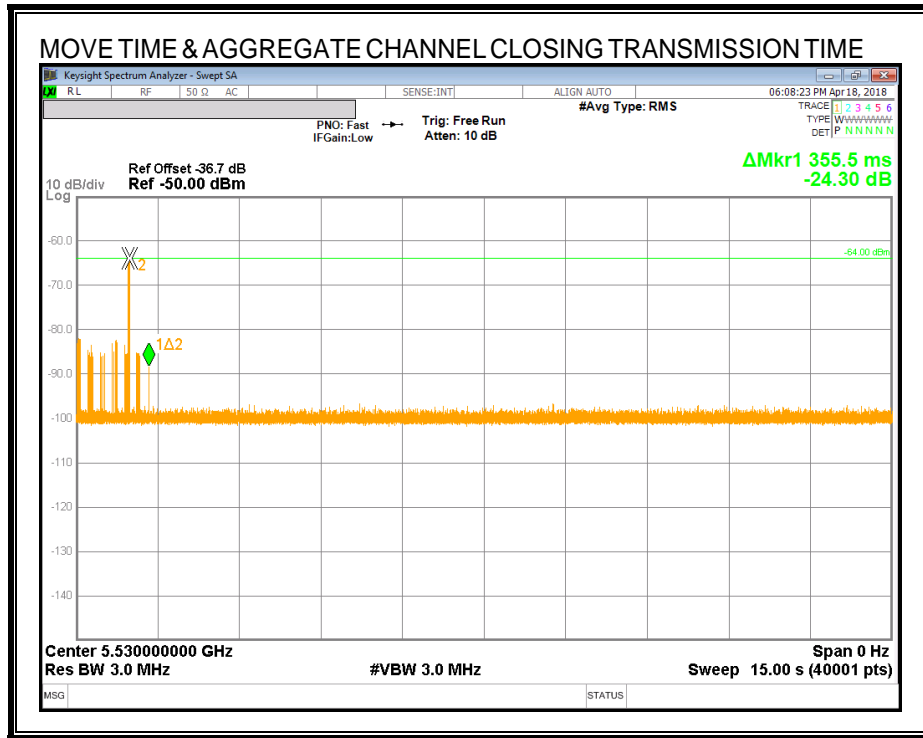

NON-OCCUPANCY PERIOD

RESULTS

No EUT transmissions were observed on the test channel during the 10-minute observation time.

