



FCC CFR47 PART 15 SUBPART C

Bluetooth

CERTIFICATION TEST REPORT

FOR

GSM/WCDMA/LTE Tablet + BT/BLE, DTS/UNII a/b/g/n/ac and ANT+

MODEL NUMBER : SM-T835C

FCC ID: A3LSMT835C

REPORT NUMBER: 4788506351-E3V1

ISSUE DATE: JUL 11, 2018

Prepared for
SAMSUNG ELECTRONICS CO., LTD.
129 SAMSUNG-RO, YEONGTONG-GU, SUWON-SI,
GYEONGGI-DO, 16677, KOREA

Prepared by
UL Korea, Ltd.
26th floor, 152, Teheran-ro, Gangnam-gu Seoul, 06236, Korea

Suwon Test Site: UL Korea, Ltd. Suwon Laboratory
218 Maeyeong-ro, Yeongtong-gu,
Suwon-si, Gyeonggi-do, 16675, Korea
TEL: (031) 337-9902
FAX: (031) 213-5433



ACCREDITED*

Testing
Laboratory

TL-637

Revision History

<u>Rev.</u>	<u>Issue Date</u>	<u>Revisions</u>	<u>Revised By</u>
V1	07/11/18	Initial issue	Junwhan Lee

TABLE OF CONTENTS

1. ATTESTATION OF TEST RESULTS	5
2. TEST METHODOLOGY	6
3. FACILITIES AND ACCREDITATION	6
4. CALIBRATION AND UNCERTAINTY	6
4.1. MEASURING INSTRUMENT CALIBRATION	6
4.2. SAMPLE CALCULATION	6
4.3. MEASUREMENT UNCERTAINTY.....	7
5. EQUIPMENT UNDER TEST	8
5.1. DESCRIPTION OF EUT	8
5.1. MAXIMUM OUTPUT POWER.....	8
5.2. DESCRIPTION OF AVAILABLE ANTENNAS	8
5.3. WORST-CASE CONFIGURATION AND MODE.....	8
5.4. DESCRIPTION OF TEST SETUP.....	9
6. MEASUREMENT METHODS	11
7. TEST AND MEASUREMENT EQUIPMENT	12
8. REFERENCE MEASUREMENT RESULTS.....	13
8.1. ON TIME AND DUTY CYCLE RESULTS.....	13
8.2. 20 dB AND 99% BANDWIDTH	14
8.2.1. BASIC DATA RATE GFSK MODULATION	14
8.2.2. ENHANCED DATA RATE Pi/4-DQPSK MODULATION.....	14
8.2.3. ENHANCED DATA RATE 8PSK MODULATION	14
8.2.4. 20 dB AND 99% BANDWIDTH PLOTS.....	15
9. SUMMARY TABLE	18
10. ANTENNA PORT TEST RESULTS	19
10.1. HOPPING FREQUENCY SEPARATION.....	19
10.2. NUMBER OF HOPPING CHANNELS	20
10.3. AVERAGE TIME OF OCCUPANCY	24
10.4. OUTPUT POWER.....	32
10.4.1. BASIC DATA RATE GFSK MODULATION	32
10.4.2. ENHANCED DATA RATE Pi/4-DPSK MODULATION	32
10.4.3. ENHANCED DATA RATE 8PSK MODULATION.....	32
10.4.4. OUTPUT POWER PLOTS	33
10.5. AVERAGE POWER	36

10.5.1.	BASIC DATA RATE GFSK MODULATION	36
10.5.2.	DATA RATE PI/4-DQPSK MODULATION.....	36
10.5.3.	ENHANCED DATA RATE 8PSK MODULATION.....	36
10.6.	CONDUCTED SPURIOUS EMISSIONS	37
10.6.1.	BASIC DATA RATE GFSK MODULATION	38
11.	RADIATED TEST RESULTS	50
11.1.	LIMITS AND PROCEDURE.....	50
11.2.	TRANSMITTER ABOVE 1 GHz.....	52
11.2.1.	BASIC DATA RATE GFSK MODULATION	52
11.2.2.	ENHANCED DATA RATE 8PSK MODULATION.....	62
11.3.	WORST-CASE BELOW 1 GHz	72
12.	AC POWER LINE CONDUCTED EMISSIONS	76
13.	SETUP PHOTOS	81

1. ATTESTATION OF TEST RESULTS

COMPANY NAME: SAMSUNG ELECTRONICS CO., LTD.
EUT DESCRIPTION: GSM/WCDMA/LTE Tablet + BT/BLE, DTS/UNII a/b/g/n/ac and ANT+
MODEL NUMBER: SM-T835C
SERIAL NUMBER: R22K500LEAW (RADIATED);
R22K4004WOF (CONDUCTED)
DATE TESTED: JUN 20, 2018 - JUL 11, 2018

APPLICABLE STANDARDS	
STANDARD	TEST RESULTS
CFR 47 Part 15 Subpart C	Pass

UL Korea, Ltd. tested the above equipment in accordance with the requirements set forth in the above standards. All indications of Pass/Fail in this report are opinions expressed by UL Korea, Ltd. based on interpretations and/or observations of test results. Measurement Uncertainties were not taken into account and are published for informational purposes only. The test results show that the equipment tested is capable of demonstrating compliance with the requirements as documented in this report.

Note: The results documented in this report apply only to the tested sample, under the conditions and modes of operation as described herein. This document may not be altered or revised in any way unless done so by UL Korea, Ltd. and all revisions are duly noted in the revisions section. Any alteration of this document not carried out by UL Korea, Ltd. will constitute fraud and shall nullify the document. This report must not be used by the client to claim product certification, approval, or endorsement by IAS, any agency of the Federal Government, or any agency of any government.

Approved & Released For
UL Korea, Ltd. By:

Tested By:



SungGil Park
Suwon Lab Engineer
UL Korea, Ltd.



Junwhan Lee
Suwon Lab Engineer
UL Korea, Ltd.

2. TEST METHODOLOGY

The tests documented in this report were performed in accordance with following methods.

1. FCC CFR 47 Part 2.
2. FCC CFR 47 Part 15.
3. FCC DA 00-705 Filing and measurement guidelines for FHSS systems
4. ANSI C63.10-2013.

3. FACILITIES AND ACCREDITATION

The test sites and measurement facilities used to collect data are located at 218 Maeyeong-ro, Yeongtong-gu, Suwon-si, Gyeonggi-do, 16675, Korea. Line conducted emissions are measured only at the 218 address. The following table identifies which facilities were utilized for radiated emission measurements documented in this report. Specific facilities are also identified in the test results sections.

218 Maeyeong-ro	
<input checked="" type="checkbox"/>	Chamber 1
<input type="checkbox"/>	Chamber 2
<input checked="" type="checkbox"/>	Chamber 3

UL Korea, Ltd. is accredited by IAS, Laboratory Code TL-637. The full scope of accreditation can be viewed at <http://www.iasonline.org/PDF/TL/TL-637.pdf>.

4. CALIBRATION AND UNCERTAINTY

4.1. MEASURING INSTRUMENT CALIBRATION

The measuring equipment utilized to perform the tests documented in this report has been calibrated in accordance with the manufacturer's recommendations, and is traceable to recognized national standards.

4.2. SAMPLE CALCULATION

Where relevant, the following sample calculation is provided:

$$\begin{aligned} \text{Field Strength (dBuV/m)} &= \text{Measured Voltage (dBuV)} + \text{Antenna Factor (dB/m)} + \\ &\text{Cable Loss (dB)} - \text{Preamp Gain (dB)} \\ 36.5 \text{ dBuV} + 18.7 \text{ dB/m} + 0.6 \text{ dB} - 26.9 \text{ dB} &= 28.9 \text{ dBuV/m} \end{aligned}$$

4.3. MEASUREMENT UNCERTAINTY

Where relevant, the following measurement uncertainty levels have been estimated for tests performed on the apparatus:

PARAMETER	UNCERTAINTY
Conducted Disturbance, 0.15 to 30 MHz	2.32 dB
Radiated Disturbance, Below 1GHz	3.86 dB
Radiated Disturbance, Above 1 GHz	5.97 dB

Uncertainty figures are valid to a confidence level of 95%.

5. EQUIPMENT UNDER TEST

5.1. DESCRIPTION OF EUT

The EUT is a GSM/WCDMA/LTE Tablet + BT/BLE, DTS/UNII a/b/g/n/ac and ANT+. This test report addresses the DSS (BT) operational mode.

5.1. MAXIMUM OUTPUT POWER

The transmitter has a maximum conducted output power as follows:

Frequency Range [MHz]	Mode	Power Mode	Output Power [dBm]	Output Power [mW]
2402 - 2480	Basic GFSK	Average	9.251	8.416
		Peak	9.510	8.933
	Enhanced Pi/4-DPSK	Average	8.826	7.631
		Peak	10.729	11.828
	Enhanced 8PSK	Average	8.876	7.720
		Peak	10.998	12.583

5.2. DESCRIPTION OF AVAILABLE ANTENNAS

The radio utilizes an internal antenna, with a maximum gain of -1.84 dBi.

5.3. WORST-CASE CONFIGURATION AND MODE

Radiated emission below 1GHz and power line conducted emission were performed with the EUT set to transmit at the channel with highest output power as worst-case scenario.

Radiated emission above 1GHz was performed with the EUT set to transmit low/mid/high channels.

The fundamental of the EUT was investigated in three orthogonal orientations X, Y and Z it was determined that Y orientation was worst-case orientation; therefore, all final radiated testing was performed with the EUT in Y orientation.

Note: GFSK, Pi/4-DQPSK, 8PSK average Power are all investigated, The GFSK & 8PSK Power are the worst case. Testing is based on this mode to showing compliance. For average power data please refer to section 9.5. All radiated and power line conducted tests were performed connected with earphone and charger for evaluation of worst case mode.

5.4. DESCRIPTION OF TEST SETUP

SUPPORT EQUIPMENT

Support Equipment List				
Description	Manufacturer	Model	Serial Number	FCC ID
Charger	SAMSUNG	EP-TA200	R37K49A2631DK3	N/A
Data Cable	SAMSUNG	EP-DN930CWE	N/A	N/A
Earphone	SAMSUNG	EO-EG920BW	N/A	N/A

I/O CABLES

I/O Cable List						
Cable No	Port	# of identical ports	Connector Type	Cable Type	Cable Length (m)	Remarks
1	DC Power	1	C Type	Shielded	1.1m	N/A
2	Audio	2	Mini-Jack	Unshielded	1.2m	N/A

TEST SETUP

The EUT is continuously communicating to the Bluetooth tester during the tests.
Test software enable BT communications.

NOTE

Additional tests under 1 GHz were performed with the keyboard attached to check on all port terminated conditions. Keyboard is not an in-box item.

SETUP DIAGRAM FOR TESTS (CONDUCTED TEST SETUP)

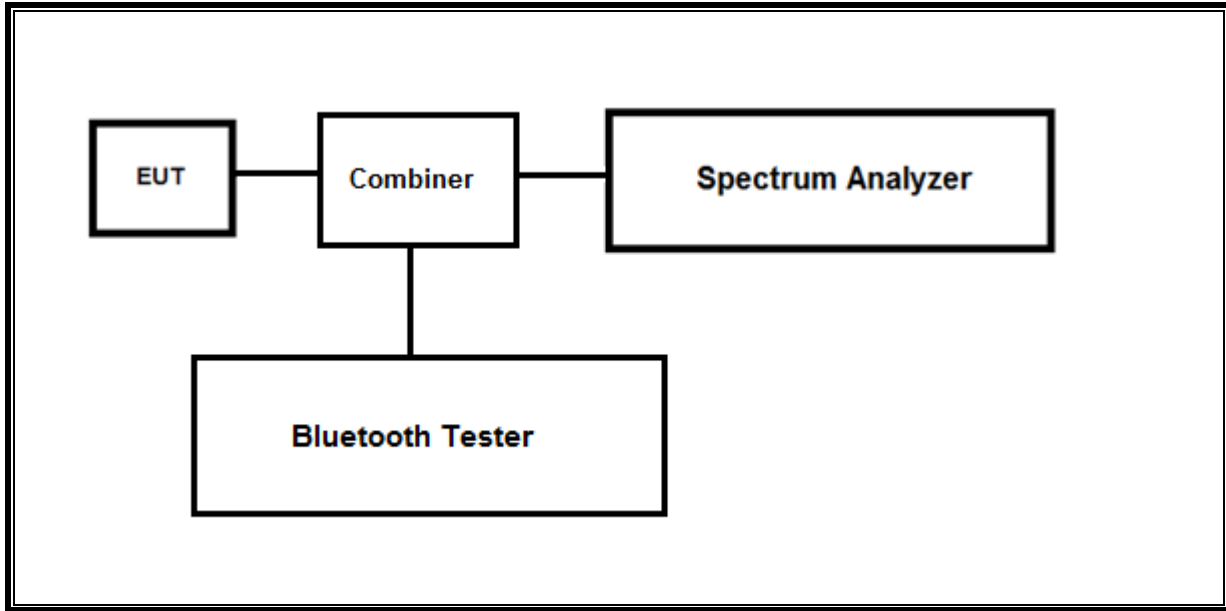

SETUP DIAGRAM FOR TESTS (RADIATED TEST SETUP)

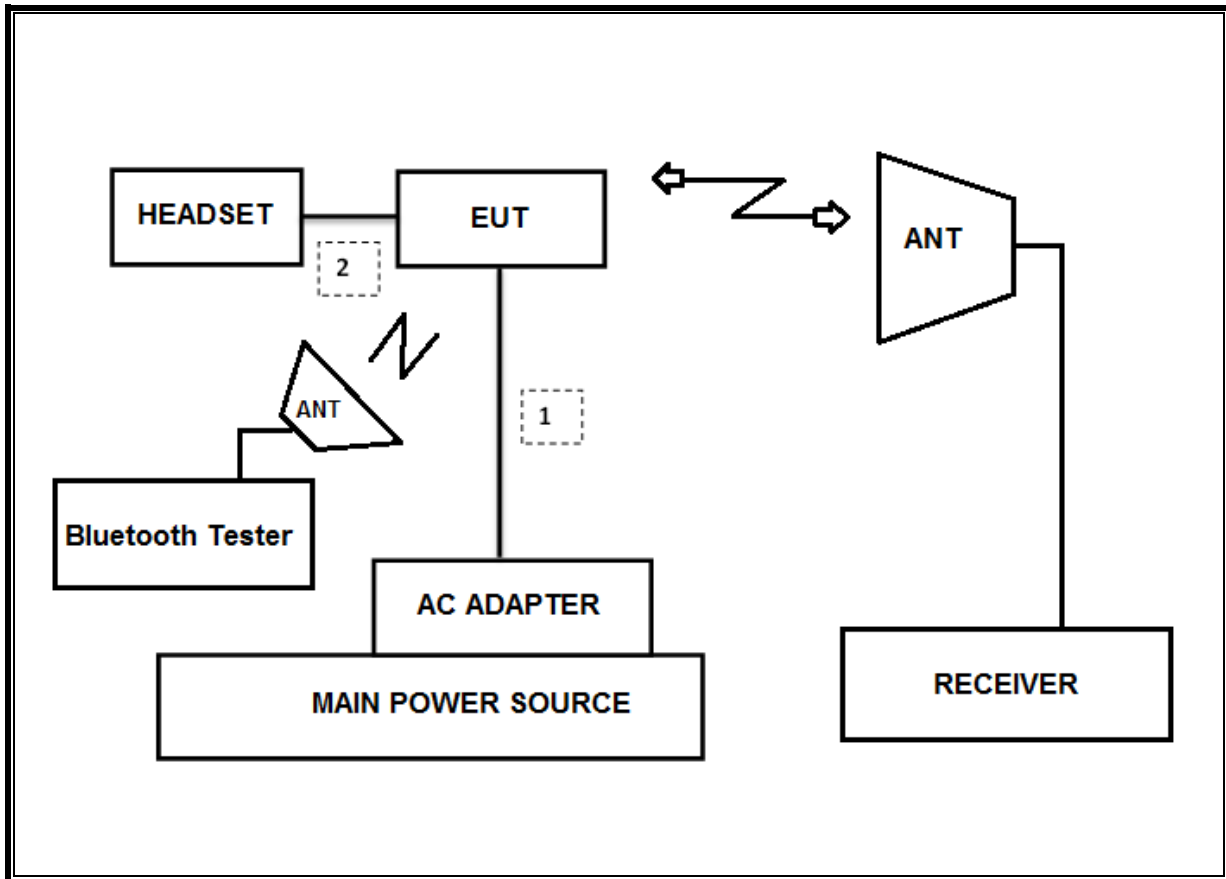

6. MEASUREMENT METHODS

20dB BW : ANSI C63.10, Section 6.9.2

99% BW : ANSI C63.10, Section 6.9.3

HOPPING FREQUENCY SEPARATION : ANSI C63.10, Section 7.8.2

NUMBER OF HOPPING CHANNELS : ANSI C63.10, Section 7.8.3

AVERAGE TIME OF OCCUPANCY : ANSI C63.10, Section 7.8.4

OUTPUT POWER : ANSI C63.10, Section 7.8.5.

Out-of-band EMISSIONS (Conducted) : ANSI C63.10, Section 7.8.6, 7.8.8

Out-of-band EMISSIONS IN NON-RESTRICTED BANDS: ANSI C63.10, Section 6.

Out-of-band EMISSIONS IN RESTRICTED BANDS : ANSI C63.10, Section 6.

AC Power Line Conducted Emission : ANSI C63.10-2013, Section 6.2.

7. TEST AND MEASUREMENT EQUIPMENT

The following test and measurement equipment was utilized for the tests documented in this report:

Test Equipment List				
Description	Manufacturer	Model	S/N	Cal Due
Antenna, Bilog, 30MHz-1GHz	SCHWARZBECK	VULB9163	750	08-31-19
Antenna, Bilog, 30MHz-1GHz	SCHWARZBECK	VULB9163	749	09-14-19
Antenna, Bilog, 30MHz-1GHz	SCHWARZBECK	VULB9163	845	08-31-19
Antenna, Horn, 18 GHz	ETS	3115	00167211	10-14-18
Antenna, Horn, 18 GHz	ETS	3115	00161451	03-10-19
Antenna, Horn, 18 GHz	ETS	3117	00168724	05-31-19
Antenna, Horn, 18 GHz	ETS	3117	00168717	05-31-19
Antenna, Horn, 18 GHz	ETS	3117	00205959	11-29-18
Antenna, Horn, 40 GHz	ETS	3116C	00166155	12-04-19
Antenna, Horn, 40 GHz	ETS	3116C	00168645	12-04-19
Antenna, Horn, 40 GHz	ETS	3116C-PA	00168841	11-13-19
Preamplifier, 1000 MHz	Sonoma	310N	341282	08-09-18
Preamplifier, 1000 MHz	Sonoma	310N	351741	08-07-18
Preamplifier, 1000 MHz	Sonoma	310N	370599	08-10-18
Preamplifier, 18 GHz	Miteq	AFS42-00101800-25-S-42	1876511	08-08-18
Preamplifier, 18 GHz	Miteq	AFS42-00101800-25-S-42	1896138	08-08-18
Preamplifier, 18 GHz	Miteq	AFS42-00101800-25-S-42	2029169	08-11-18
Spectrum Analyzer, 44 GHz	Agilent / HP	N9030A	MY54170614	08-08-18
Spectrum Analyzer, 44 GHz	Agilent / HP	N9030A	MY54490312	08-08-18
Average Power Sensor	Agilent / HP	U2000	MY54270007	08-08-18
Bluetooth Tester	TESCOM	TC-3000C	3000C000546	08-08-18
Combiner	WEINCHEL	1575	2152	08-08-18
Attenuator	PASTERNAK	PE7087-10	A001	08-08-18
Attenuator	PASTERNAK	PE7087-10	A008	08-08-18
Attenuator	PASTERNAK	PE7087-10	2	08-10-18
EMI Test Receive, 40 GHz	R&S	ESU40	100439	08-08-18
EMI Test Receive, 40 GHz	R&S	ESU40	100457	08-08-18
EMI Test Receive, 44 GHz	R&S	ESW44	101590	08-09-18
EMI Test Receive, 3 GHz	R&S	ESR3	101832	08-07-18
Low Pass Filter 5GHz	Micro-Tronics	LPS17541	009	08-08-18
Low Pass Filter 5GHz	Micro-Tronics	LPS17541	015	08-08-18
Low Pass Filter 5GHz	Micro-Tronics	LPS17541	020	08-11-18
High Pass Filter 3GHz	Micro-Tronics	HPM17543	010	08-08-18
High Pass Filter 3GHz	Micro-Tronics	HPM17543	015	08-08-18
High Pass Filter 3GHz	Micro-Tronics	HPM17543	020	08-11-18
High Pass Filter 6GHz	Micro-Tronics	HPS17542	009	08-08-18
High Pass Filter 6GHz	Micro-Tronics	HPS17542	016	08-08-18
High Pass Filter 6GHz	Micro-Tronics	HPS17542	021	08-11-18
LISN	R&S	ENV-216	101837	08-09-18
UL Software				
Description	Manufacturer	Model	Version	
Radiated software	UL	UL EMC	Ver 9.5	
AC Line Conducted software	UL	UL EMC	Ver 9.5	

8. REFERENCE MEASUREMENT RESULTS

8.1. ON TIME AND DUTY CYCLE RESULTS

LIMITS

None: for reporting purposes only.

Mode	ON Time B [msec]	Period [msec]	Duty Cycle x [linear]	Duty Cycle [%]	Duty Cycle Correction Factor [dB]	1/T Minimum VBW [kHz]
2400MHz Bands						
BT	2.884	3.750	0.769	76.9%	1.14	0.347

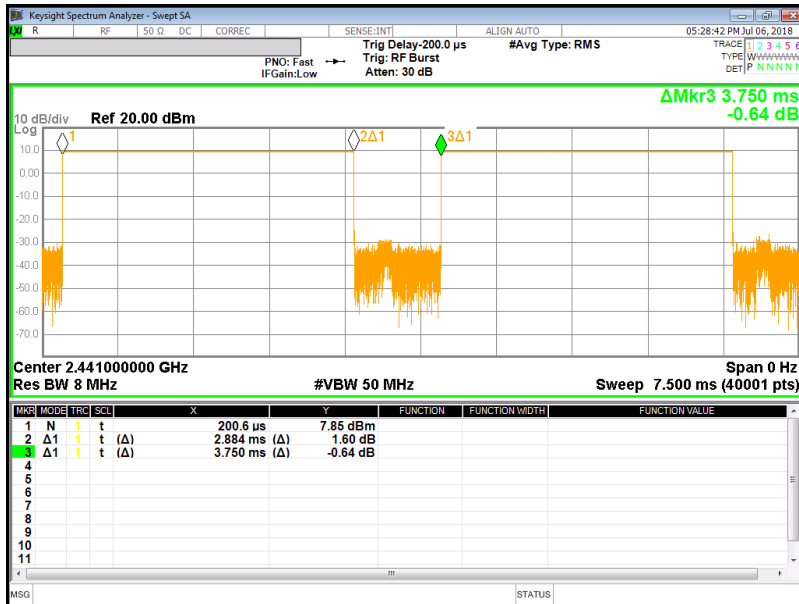

8.2. 20 dB AND 99% BANDWIDTH

LIMITS

None; for reporting purposes only.

TEST PROCEDURE

The transmitter output is connected to a spectrum analyzer. The RBW is set to $\geq 1\%$ of the 20 dB bandwidth. The VBW is set to \geq RBW. The sweep time is coupled.

RESULTS

8.2.1. BASIC DATA RATE GFSK MODULATION

Channel	Frequency [MHz]	20 dB Bandwidth [kHz]	99% Bandwidth [kHz]
Low	2402	822.7	827.82
Mid	2441	932.5	830.50
High	2480	931.5	828.39
Worst		932.5	830.50

8.2.2. ENHANCED DATA RATE Pi/4-DQPSK MODULATION

Channel	Frequency [MHz]	20 dB Bandwidth [MHz]	99% Bandwidth [MHz]
Low	2402	1.231	1.165
Mid	2441	1.303	1.165
High	2480	1.303	1.162
Worst		1.303	1.165

8.2.3. ENHANCED DATA RATE 8PSK MODULATION

Channel	Frequency [MHz]	20 dB Bandwidth [MHz]	99% Bandwidth [MHz]
Low	2402	1.267	1.164
Mid	2441	1.265	1.162
High	2480	1.265	1.162
Worst		1.267	1.164

8.2.4. 20 dB AND 99% BANDWIDTH PLOTS

GFSK BANDWIDTH

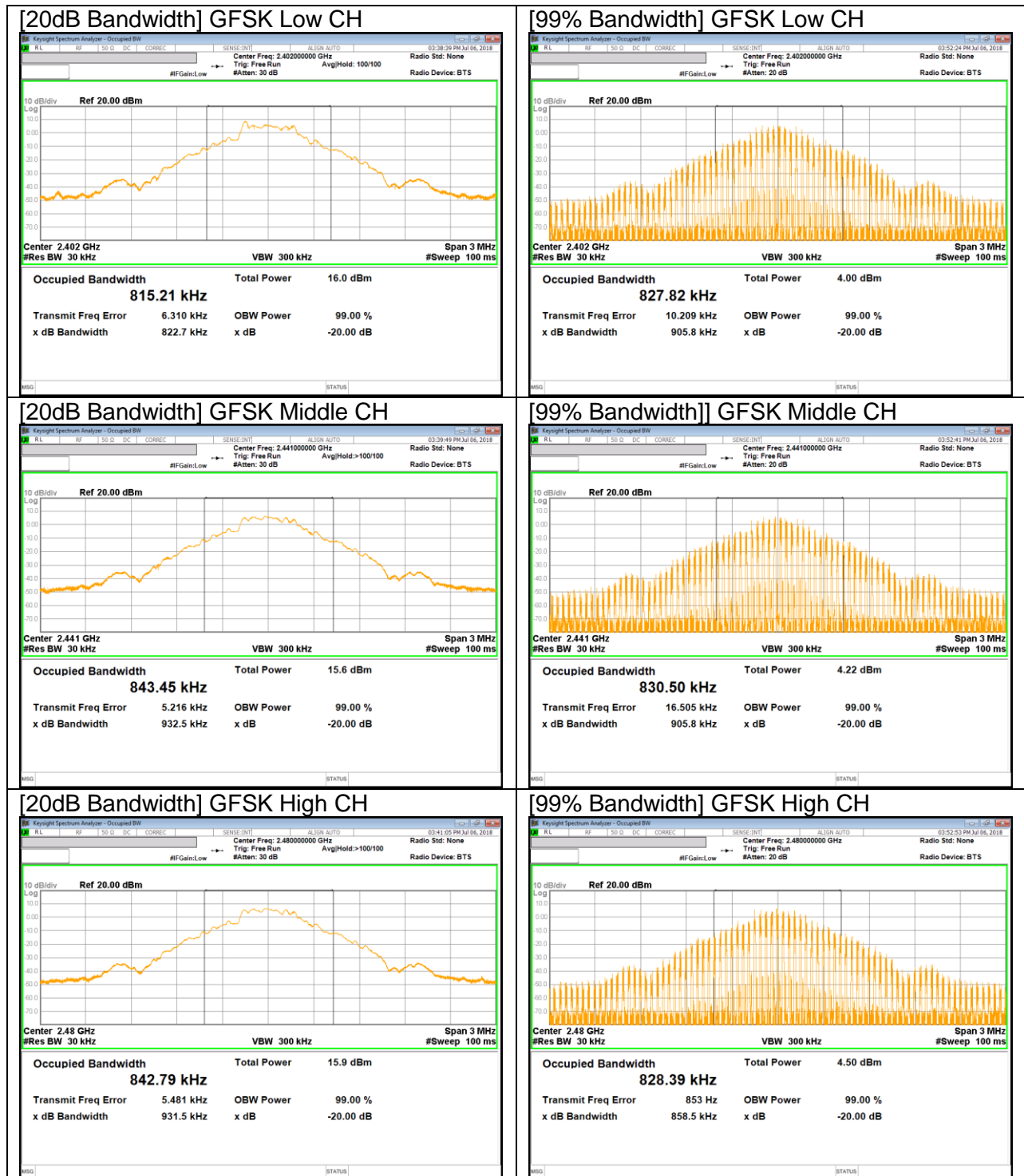

Pi/4-DQPSK BANDWIDTH

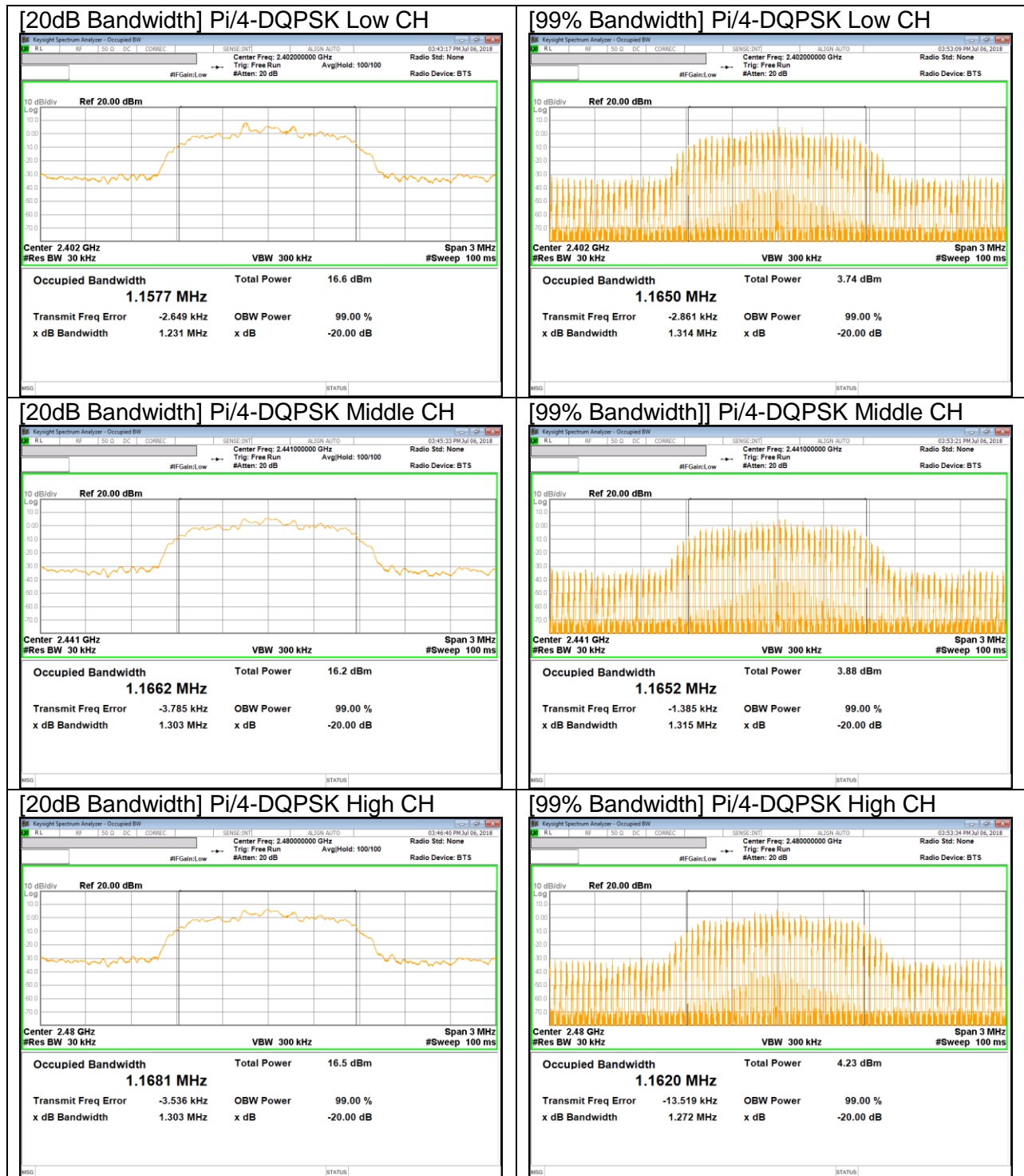

8PSK BANDWIDTH

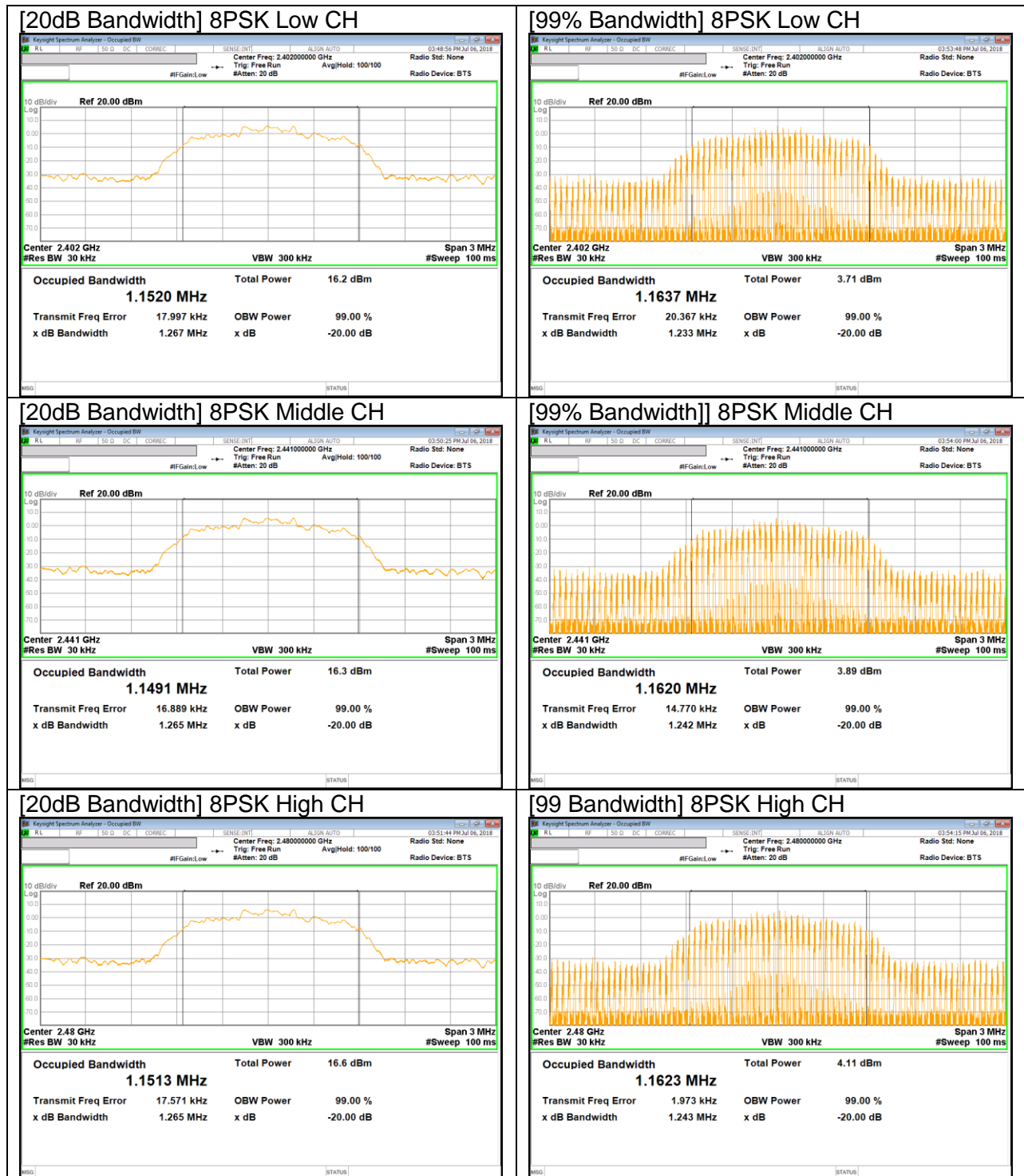

9. SUMMARY TABLE

FCC Part Section	Test Description	Test Limit	Test Condition	Test Result
2.1051, 15.247 (d)	Band Edge / Conducted Spurious Emission	-20dBc		Pass
15.247 (b)(1)	TX conducted output power	<30dBm		Pass
15.247 (a)(1)	Hopping frequency separation	> two-thirds of the 20 dB bandwidth		Pass
15.247 (a)(1)(iii)	Number of Hopping channels	More than 15 non-overlapping channels		Pass
15.247 (a)(1)(iii)	Avg Time of Occupancy	< 0.4sec		Pass
15.207 (a)	AC Power Line conducted emissions	Section 10	Power Line conducted	Pass
15.205, 15.209	Radiated Spurious Emission	< 54dBuV/m	Radiated	Pass

10. ANTENNA PORT TEST RESULTS

10.1. HOPPING FREQUENCY SEPARATION

LIMIT

FCC §15.247 (a) (1)

Frequency hopping systems shall have hopping channel carrier frequencies separated by a minimum of 25 kHz or the 20 dB bandwidth of the hopping channel, whichever is greater.

Alternatively, frequency hopping systems operating in the 2400-2483.5 MHz band may have hopping channel carrier frequencies that are separated by 25 kHz or two-thirds of the 20 dB bandwidth of the hopping channel, whichever is greater, provided the systems operate with an output power no greater than 125 mW.

TEST PROCEDURE

The transmitter output is connected to a spectrum analyzer. The RBW is set to 300 kHz and the VBW is set to 300 kHz. The sweep time is coupled.

RESULTS

HOPPING FREQUENCY SEPARATION PLOT

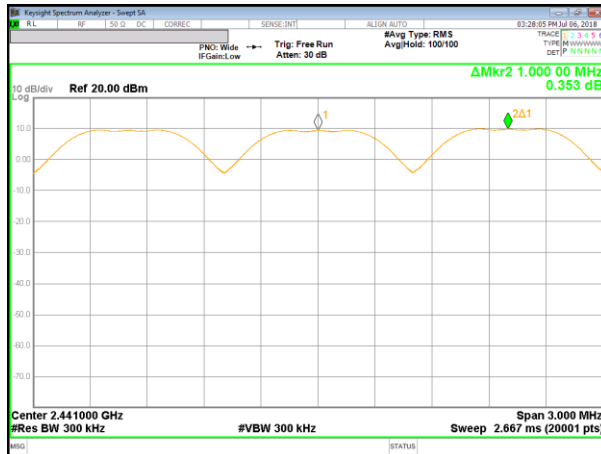

[GFSK]

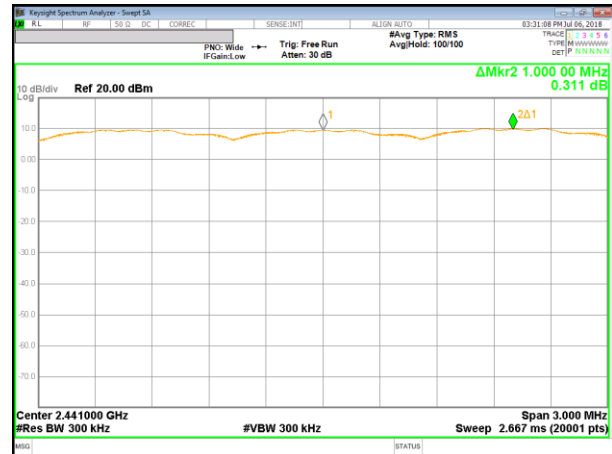

[8PSK]

10.2. NUMBER OF HOPPING CHANNELS

LIMIT

FCC §15.247 (a) (1) (iii)

Frequency hopping systems in the 2400 – 2483.5 MHz band shall use at least 15 non-overlapping channels.

TEST PROCEDURE

The transmitter output is connected to a spectrum analyzer. The span is set to cover the entire authorized band, in either a single sweep or in multiple contiguous sweeps. The RBW is set to a maximum of 1 % of the span. The analyzer is set to Max Hold.

RESULTS

Normal Mode: 79 Channels observed.

NUMBER OF HOPPING CHANNELS PLOTS[GFSK]

NUMBER OF HOPPING CHANNELS (100 MHz SPAN)

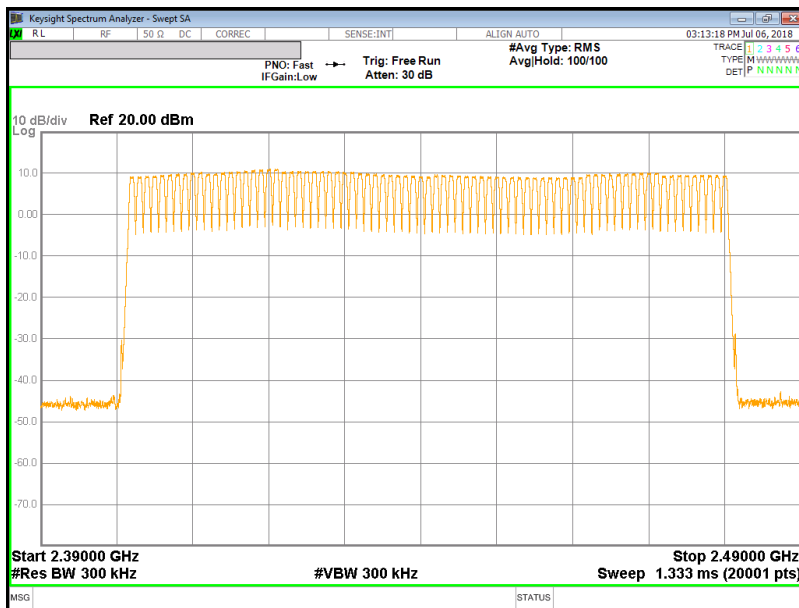

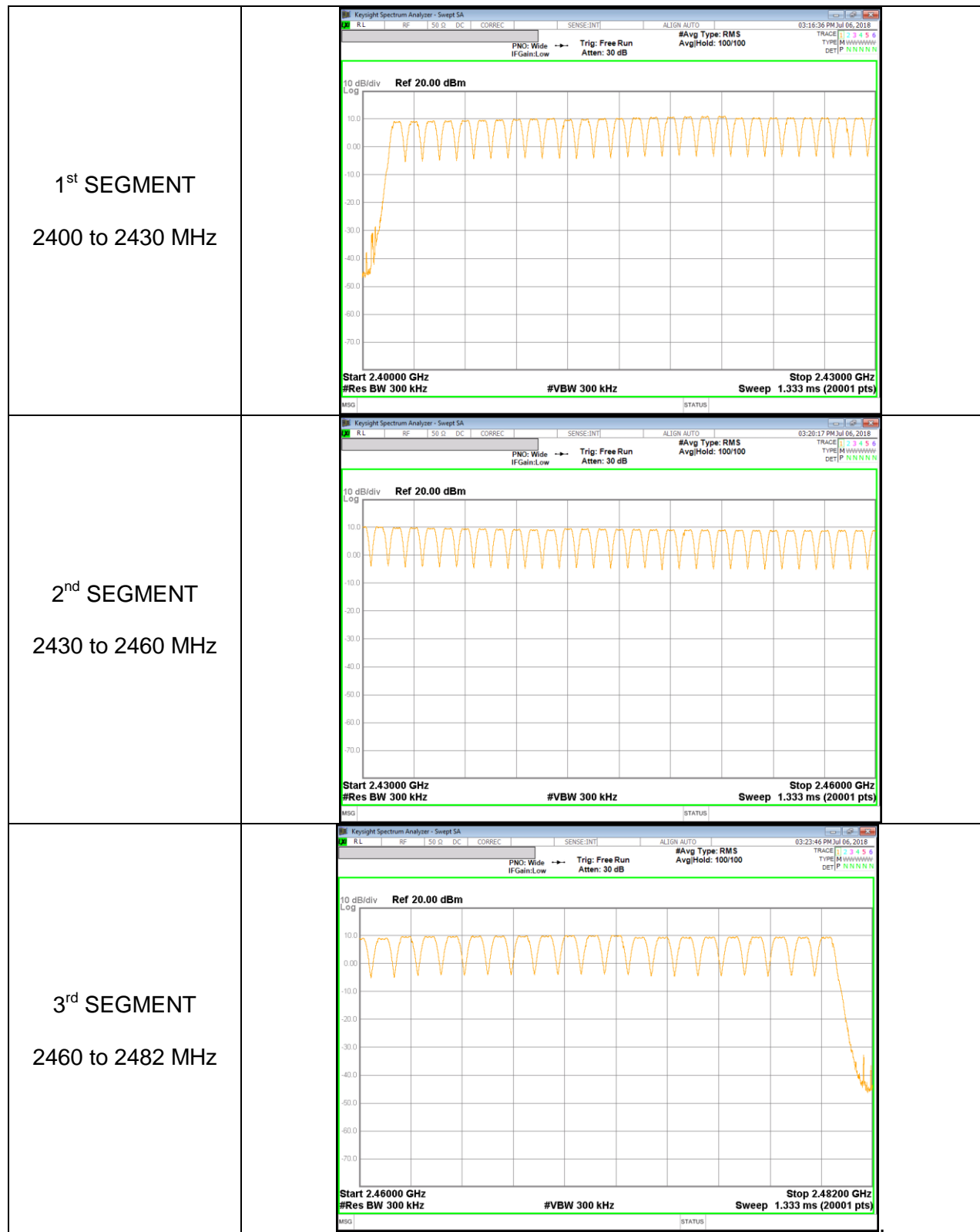

NUMBER OF HOPPING CHANNELS PLOTS[8PSK]

NUMBER OF HOPPING CHANNELS (100 MHZ SPAN)

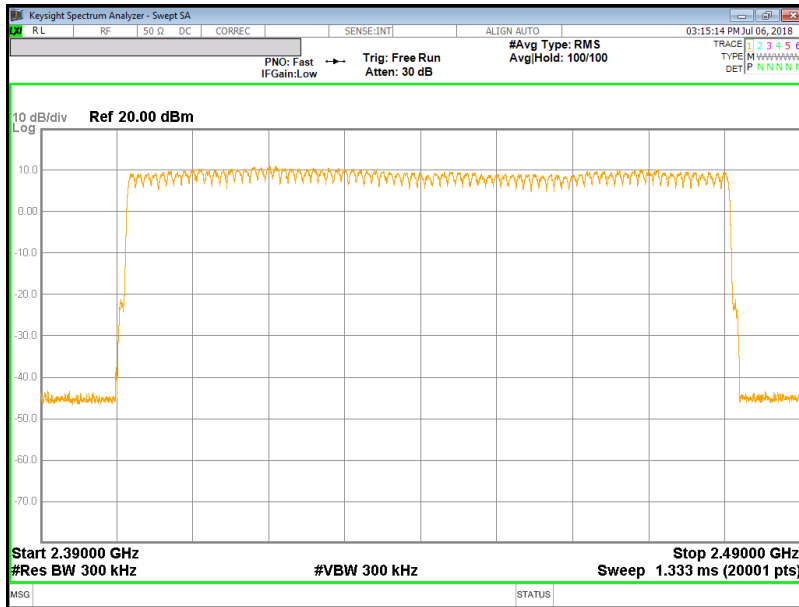



10.3. AVERAGE TIME OF OCCUPANCY

LIMIT

FCC §15.247 (a) (1) (iii)

The average time of occupancy on any channel shall not be greater than 0.4 seconds within a period of 0.4 seconds multiplied by the number of hopping channels employed.

TEST PROCEDURE

The transmitter output is connected to a spectrum analyzer. The span is set to 0 Hz, centered on a single, selected hopping channel. The width of a single pulse is measured in a fast scan. The number of pulses is measured in a 3.16 second scan, to enable resolution of each occurrence.

The average time of occupancy in the specified 31.6 second period (79 channels * 0.4 s) is equal to 10 * (# of pulses in 3.16 s) * pulse width.

For AFH mode, the average time of occupancy in the specified 8 second period (20 channels * 0.4 seconds) is equal to 10 * (# of pulses in 0.8 s) * pulse width.

RESULTS[GFSK]

	Width [msec]	Pulses in 3.16 seconds	of Occupancy [sec]	[sec]	[sec]
GFSK Normal					
DH1	0.380	32	0.121568	0.4	-0.2784
DH3	1.636	16	0.261760	0.4	-0.1382
DH5	2.884	12	0.346080	0.4	-0.0539
GFSK AFH					
DH Packet	Pulse Width [msec]	Number of Pulses in 0.8 seconds	Average Time of Occupancy [sec]	Limit [sec]	Margin [sec]
GFSK AFH					
DH1	0.380	8	0.030392	0.4	-0.36961
DH3	1.636	4	0.065440	0.4	-0.33456
DH5	2.884	3	0.086520	0.4	-0.31348

DH1

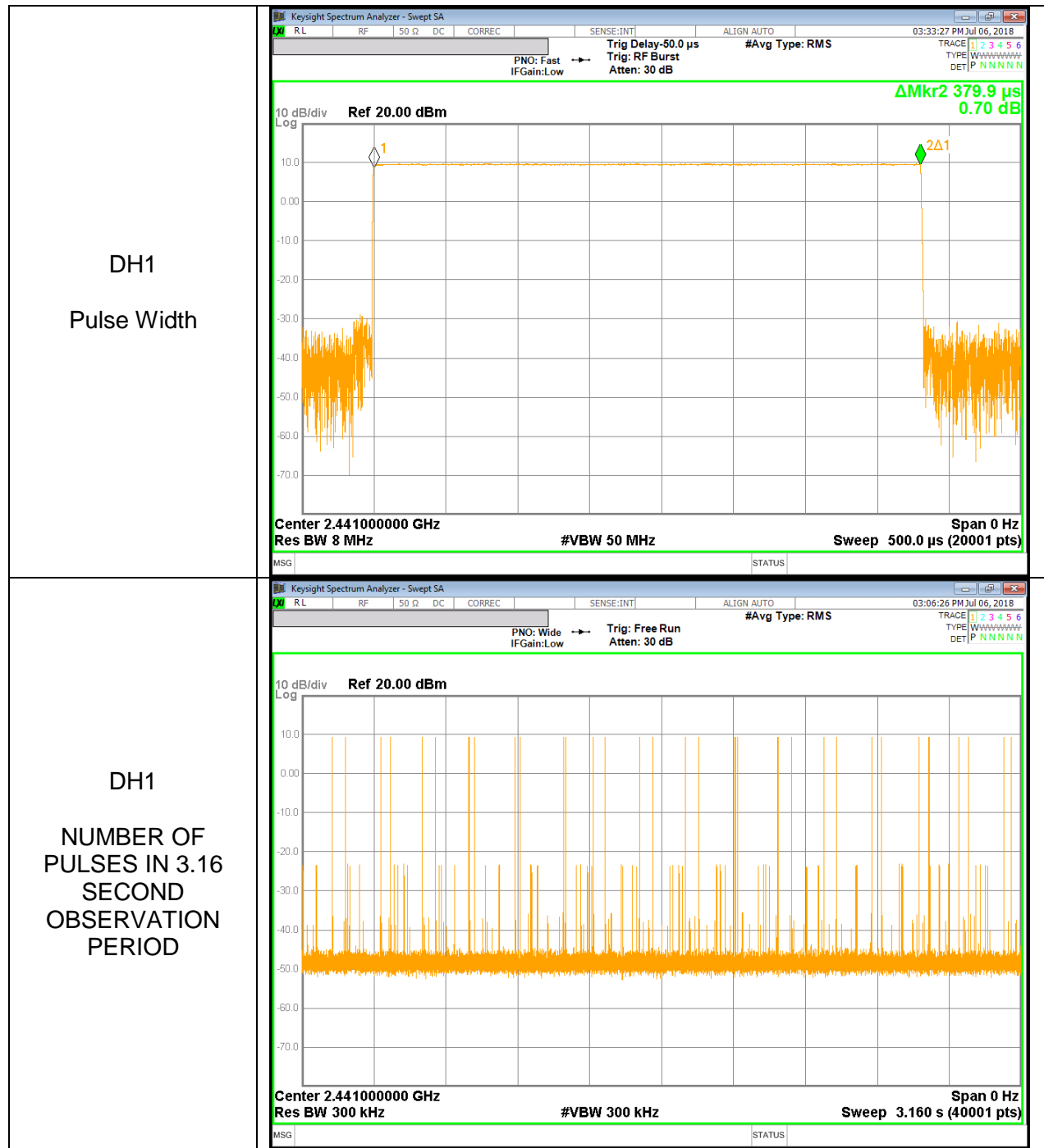

DH3

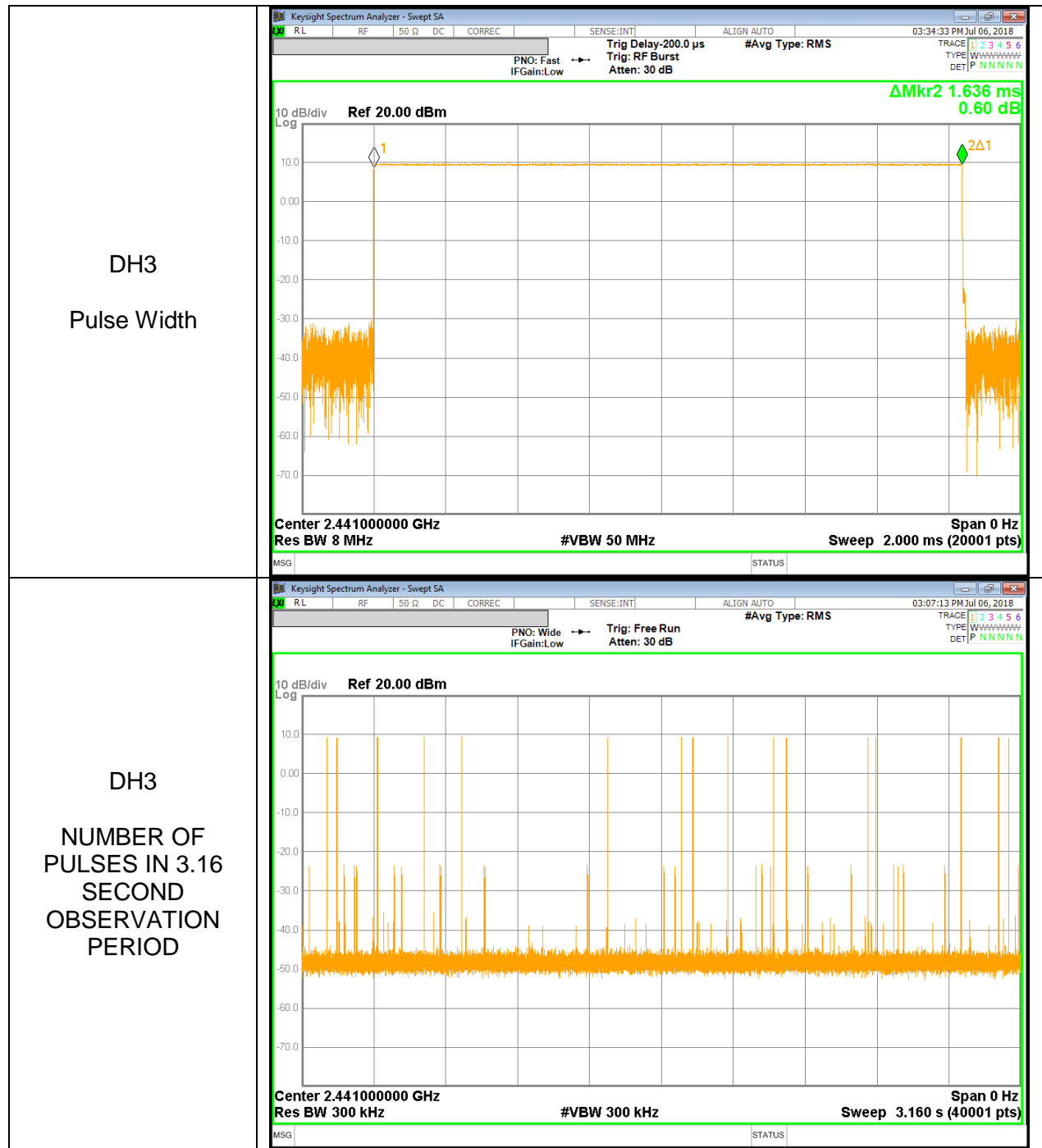

RESULTS[8PSK]

	Width [msec]	Pulses in 3.16 seconds	of Occupancy [sec]	[sec]	[sec]
GFSK Normal					
DH1	0.386	32	0.123616	0.4	-0.2764
DH3	1.637	16	0.261920	0.4	-0.1381
DH5	2.888	12	0.346560	0.4	-0.0534
GFSK AFH					
DH Packet	Pulse Width [msec]	Number of Pulses in 0.8 seconds	Average Time of Occupancy [sec]	Limit [sec]	Margin [sec]
GFSK AFH					
DH1	0.386	8	0.030904	0.4	-0.3691
DH3	1.637	4	0.065480	0.4	-0.33452
DH5	2.888	3	0.086640	0.4	-0.31336

DH1

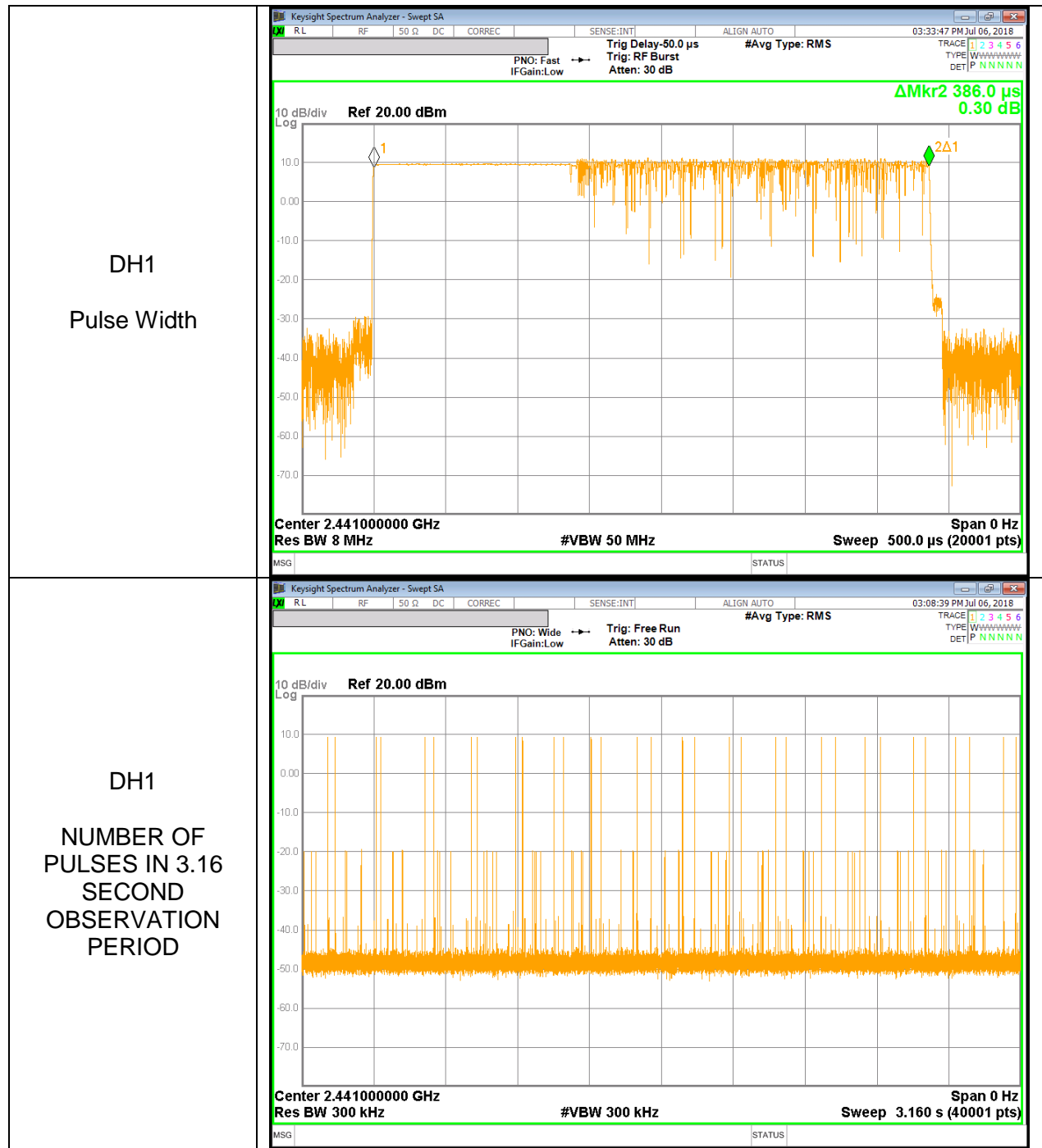

DH3

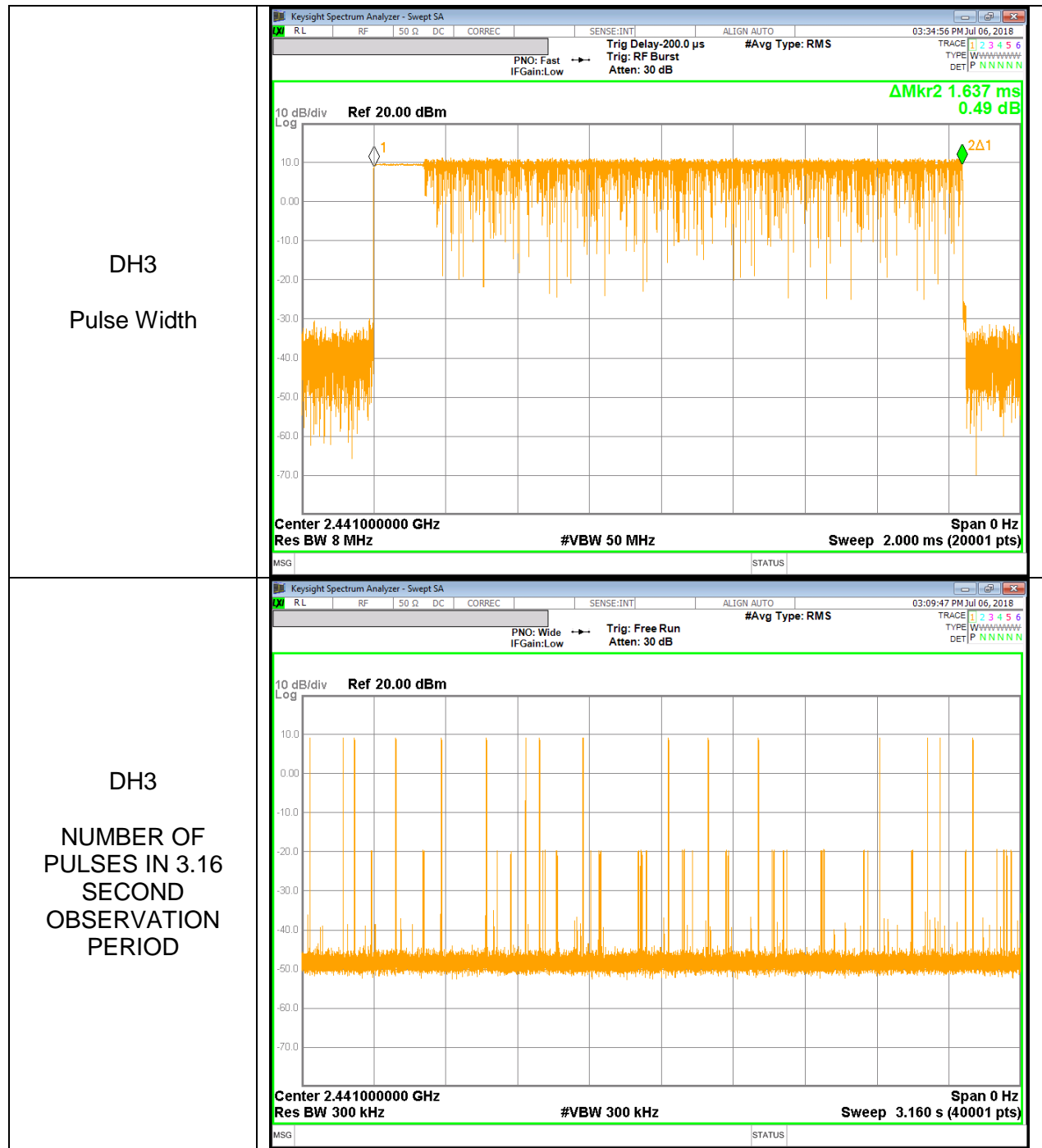

DH5

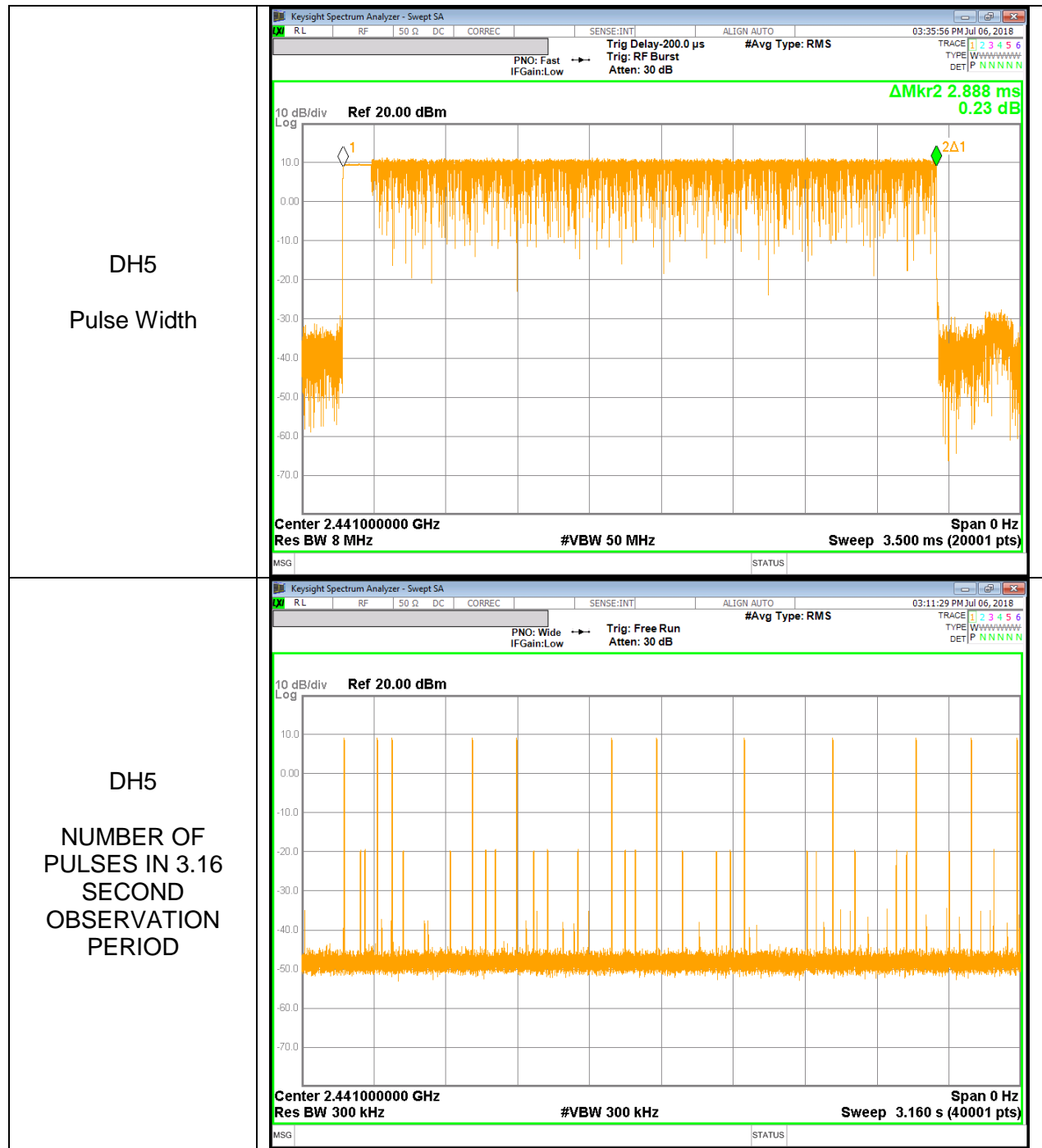

10.4. OUTPUT POWER

LIMIT

§15.247 (b) (1)

The maximum antenna gain is less than 6 dBi, therefore the limit is 21 dBm.

TEST PROCEDURE

The transmitter output is connected to a spectrum analyzer the analyzer bandwidth is set to a value greater than the 20 dB bandwidth of the EUT.

RESULTS

10.4.1. BASIC DATA RATE GFSK MODULATION

Channel	Frequency [MHz]	Output Power [dBm]	Limit [dBm]	Margin [dB]
Low	2402	9.243	21	-11.757
Middle	2441	9.181	21	-11.819
High	2480	9.510	21	-11.49
Worst		9.510	21	-11.49

10.4.2. ENHANCED DATA RATE Pi/4-DPSK MODULATION

Channel	Frequency [MHz]	Output Power [dBm]	Limit [dBm]	Margin [dB]
Low	2402	10.425	21	-10.575
Middle	2441	10.507	21	-10.493
High	2480	10.729	21	-10.271
Worst		10.729	21	-10.271

10.4.3. ENHANCED DATA RATE 8PSK MODULATION

Channel	Frequency [MHz]	Output Power [dBm]	Limit [dBm]	Margin [dB]
Low	2402	10.651	21	-10.349
Middle	2441	10.736	21	-10.264
High	2480	10.998	21	-10.002
Worst		10.998	21	-10.002

10.4.4. OUTPUT POWER PLOTS

GFSK OUTPUT POWER

<p>GFSK Low CH</p>	<p>Key parameters from the plot: Center: 2.4020645 GHz #Res BW: 3.0 MHz #VBW: 50 MHz Sweep: 1.333 ms (20001 pts) Mkr1: 2.402 064 5 GHz 9.243 dBm</p>
<p>GFSK Middle CH</p>	<p>Key parameters from the plot: Center: 2.4411535 GHz #Res BW: 3.0 MHz #VBW: 50 MHz Sweep: 1.333 ms (20001 pts) Mkr1: 2.441 153 5 GHz 9.181 dBm</p>
<p>GFSK High CH</p>	<p>Key parameters from the plot: Center Freq: 2.48000000 GHz #Res BW: 3.0 MHz #VBW: 50 MHz Sweep: 1.333 ms (20001 pts) Mkr1: 2.480 169 0 GHz 9.510 dBm</p>

Pi/4-DPSK OUTPUT POWER

<p>Pi/4-DPSK Low CH</p>	<p>KeySight Spectrum Analyzer - Swept SA 04:34:41 PM Jul 03, 2018 #Avg Type: RMS Avg/Hold: 100/100 PNO: Fast IF Gain: Low Trig: Free Run Atten: 40 dB Ref 30.00 dBm Mkr1 2.401 999 0 GHz 10.425 dBm 10 dB/div Log Center 2.402000 GHz Span 10.00 MHz #Res BW 3.0 MHz #VBW 50 MHz Sweep 1.333 ms (20001 pts)</p>
<p>Pi/4-DPSK Middle CH</p>	<p>KeySight Spectrum Analyzer - Swept SA 04:36:22 PM Jul 03, 2018 #Avg Type: RMS Avg/Hold: 100/100 PNO: Fast IF Gain: Low Trig: Free Run Atten: 40 dB Ref 30.00 dBm Mkr1 2.441 303 5 GHz 10.507 dBm 10 dB/div Log Center 2.441000 GHz Span 10.00 MHz #Res BW 3.0 MHz #VBW 50 MHz Sweep 1.333 ms (20001 pts)</p>
<p>Pi/4-DPSK High CH</p>	<p>KeySight Spectrum Analyzer - Swept SA 04:36:53 PM Jul 03, 2018 #Avg Type: RMS Avg/Hold: 100/100 PNO: Fast IF Gain: Low Trig: Free Run Atten: 40 dB Ref 30.00 dBm Mkr1 2.479 889 0 GHz 10.729 dBm 10 dB/div Log Center 2.480000 GHz Span 10.00 MHz #Res BW 3.0 MHz #VBW 50 MHz Sweep 1.333 ms (20001 pts)</p>

8PSK OUTPUT POWER

<p>8PSK Low CH</p>	<p>Keyight Spectrum Analyzer - Swept SA 04:37:37 PM Jul 03, 2018 #Avg Type: RMS Avg/Hold: 100/100 PNO: Fast IF Gain: Low Trig: Free Run Atten: 40 dB Ref 30.00 dBm Mkr1 2.402 148 5 GHz 10.651 dBm Center 2.402000 GHz #Res BW 3.0 MHz #VBW 50 MHz Span 10.00 MHz Sweep 1.333 ms (20001 pts)</p>
<p>8PSK Middle CH</p>	<p>Keyight Spectrum Analyzer - Swept SA 04:38:03 PM Jul 03, 2018 #Avg Type: RMS Avg/Hold: 100/100 PNO: Fast IF Gain: Low Trig: Free Run Atten: 40 dB Ref 30.00 dBm Mkr1 2.440 840 5 GHz 10.736 dBm Center 2.441000 GHz #Res BW 3.0 MHz #VBW 50 MHz Span 10.00 MHz Sweep 1.333 ms (20001 pts)</p>
<p>8PSK High CH</p>	<p>Keyight Spectrum Analyzer - Swept SA 04:38:30 PM Jul 03, 2018 #Avg Type: RMS Avg/Hold: 100/100 PNO: Fast IF Gain: Low Trig: Free Run Atten: 40 dB Ref 30.00 dBm Mkr1 2.480 028 5 GHz 10.998 dBm Center 2.480000 GHz #Res BW 3.0 MHz #VBW 50 MHz Span 10.00 MHz Sweep 1.333 ms (20001 pts)</p>

10.5. AVERAGE POWER

LIMIT

None; for reporting purposes only.

TEST PROCEDURE

The transmitter output is connected to a power meter.

RESULTS

The cable assembly insertion loss was entered as an offset in the power meter to allow for direct reading of power.

10.5.1. BASIC DATA RATE GFSK MODULATION

Channel	Frequency [MHz]	AV power [dBm]	AV power [mW]
Low	2402	8.972	7.89
Middle	2441	8.916	7.79
High	2480	9.251	8.42

10.5.2. DATA RATE PI/4-DQPSK MODULATION

Channel	Frequency [MHz]	AV power [dBm]	AV power [mW]
Low	2402	8.528	7.13
Middle	2441	8.499	7.08
High	2480	8.826	7.63

10.5.3. ENHANCED DATA RATE 8PSK MODULATION

Channel	Frequency [MHz]	AV power [dBm]	AV power [mW]
Low	2402	8.542	7.15
Middle	2441	8.545	7.15
High	2480	8.876	7.72

10.6. CONDUCTED SPURIOUS EMISSIONS

LIMITS

FCC §15.247 (d)

Limit = -20 dBc

TEST PROCEDURE

The transmitter output is connected to a spectrum analyzer. The resolution bandwidth is set to 100 kHz. The video bandwidth is set to 300 kHz.

The spectrum from 30 MHz to 26 GHz is investigated with the transmitter set to the lowest, middle, and highest channels.

The bandedges at 2.4 and 2.4835 GHz are investigated with the transmitter set to the normal hopping mode.

RESULTS

10.6.1. BASIC DATA RATE GFSK MODULATION

GFSK Mode

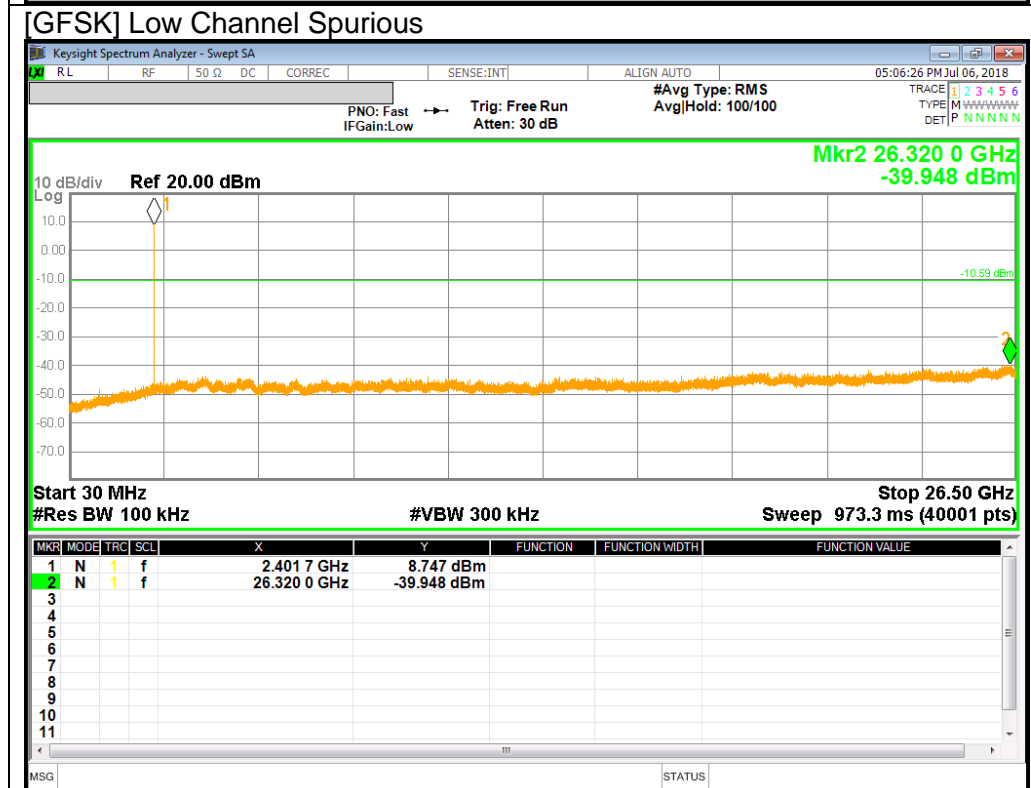
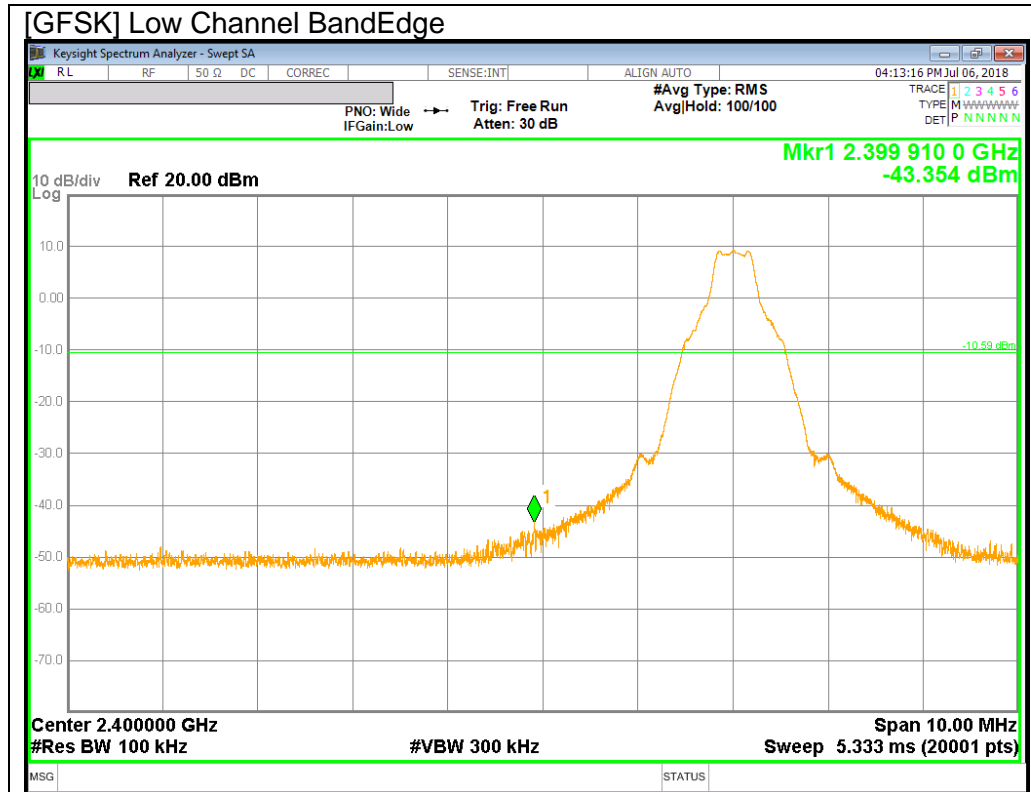

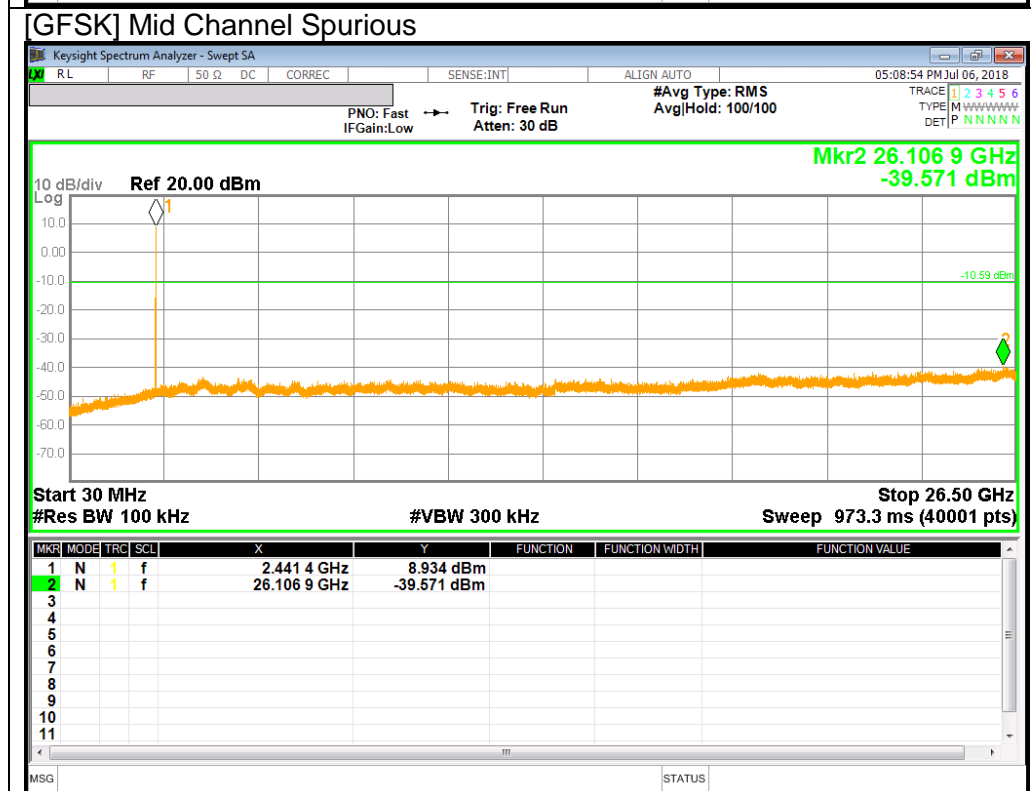
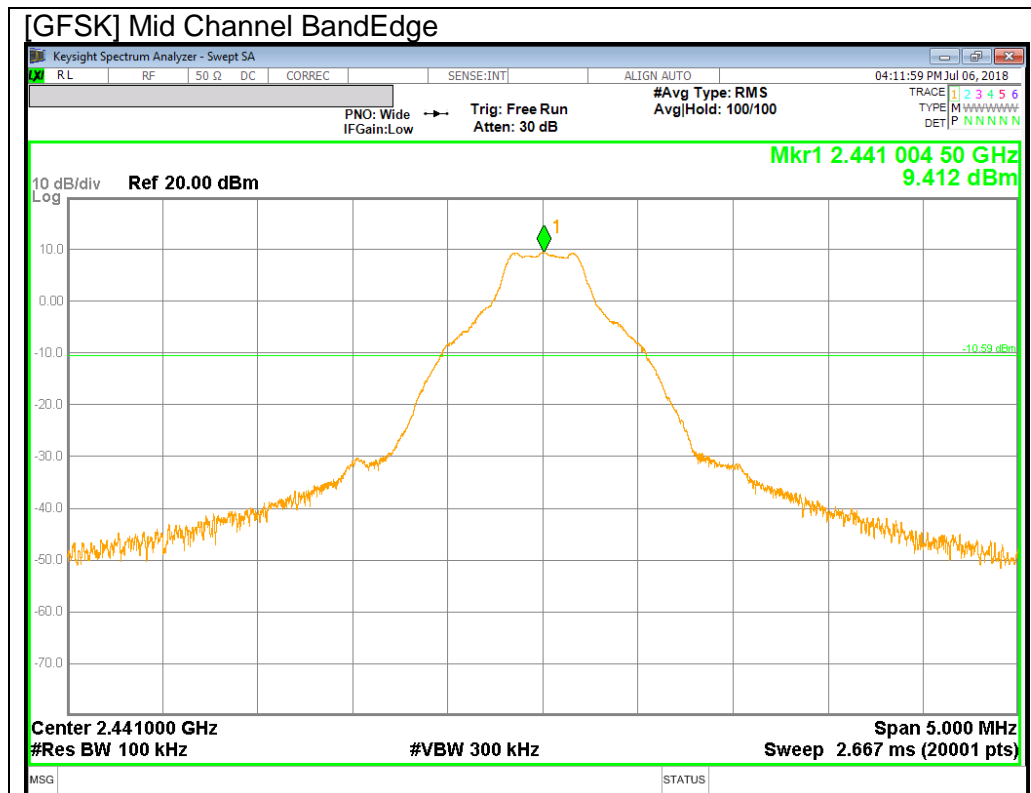

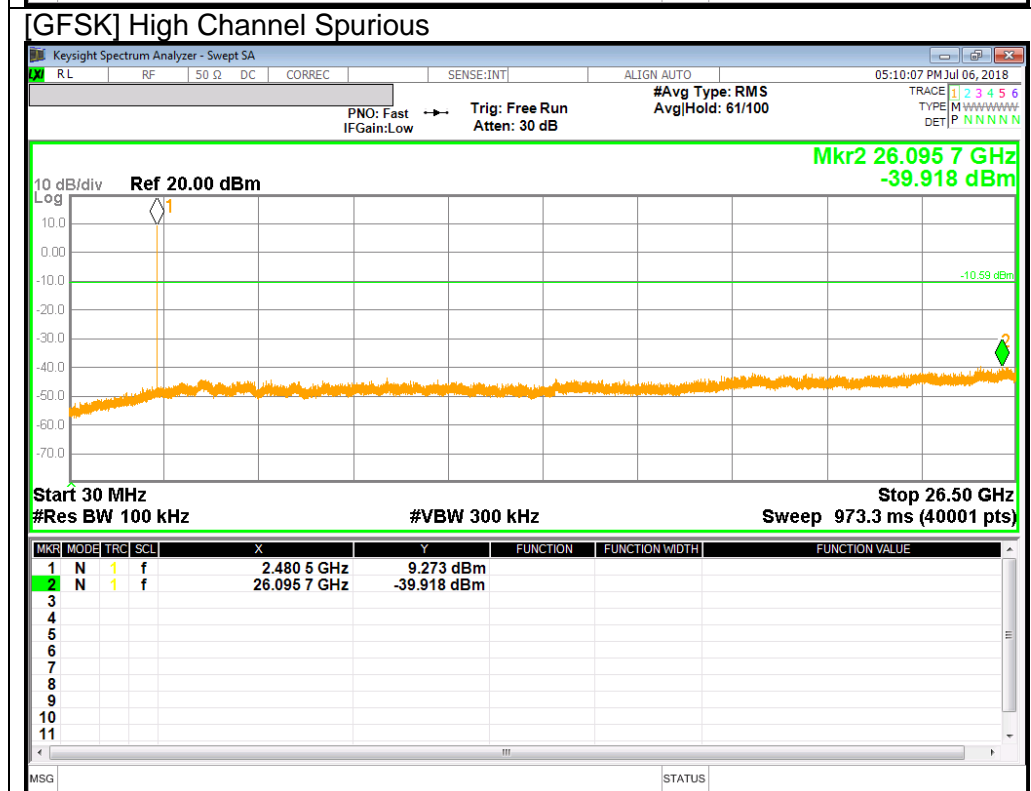
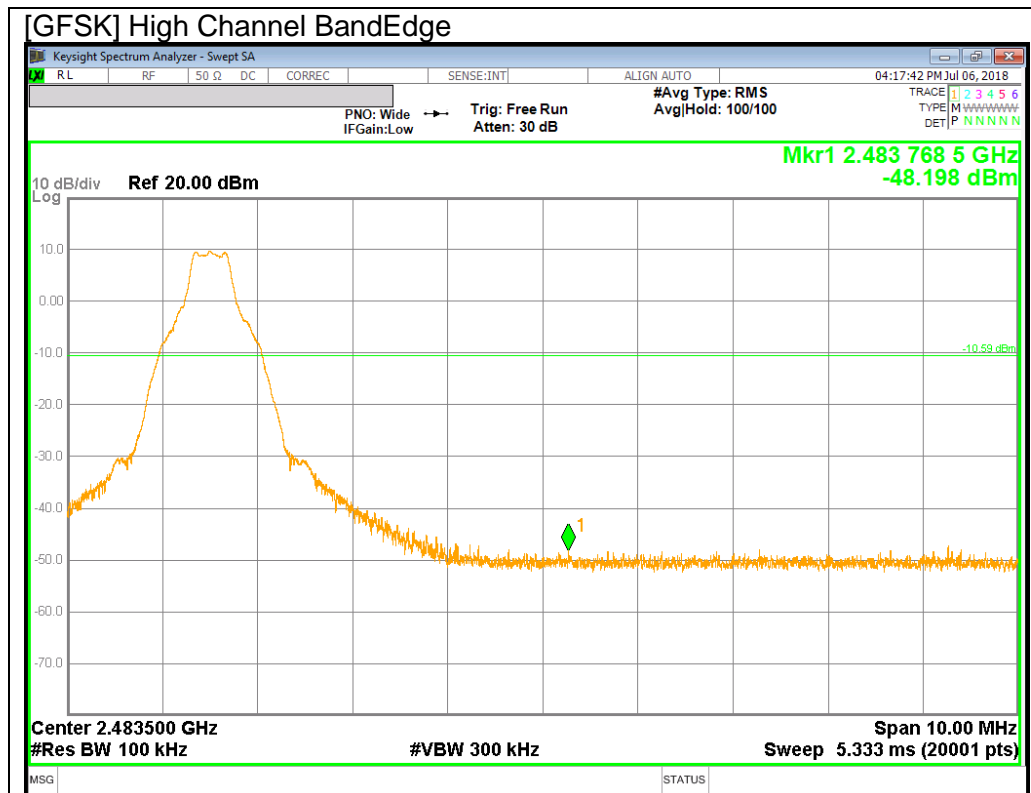

BandEdge Emission at GFSK Hopping Mode

[GFSK Hopping Mode] Low Channel BandEdge

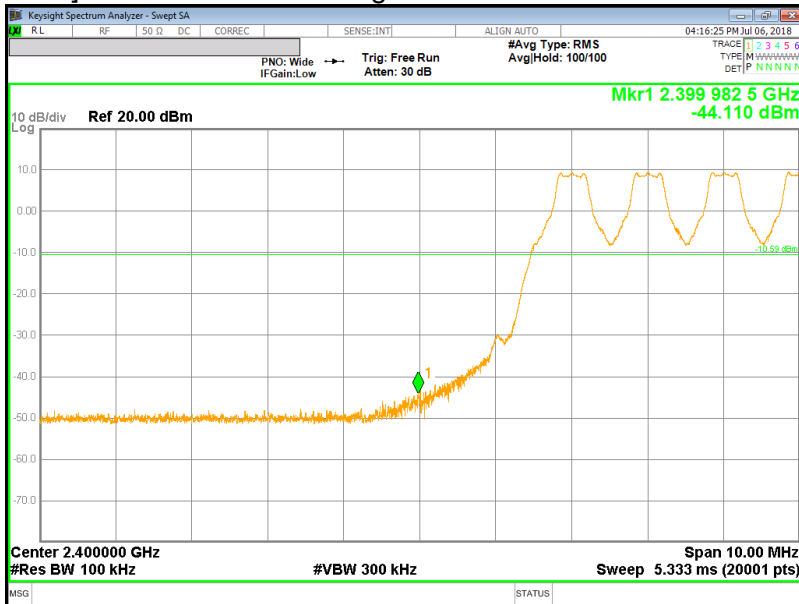

[GFSK Hopping Mode] High Channel BandEdge

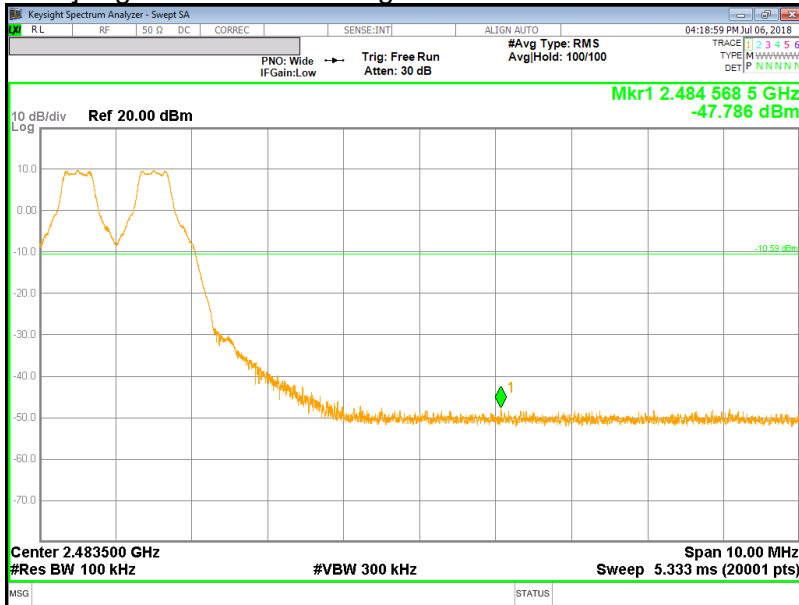

PI/4-DQPSK Mode

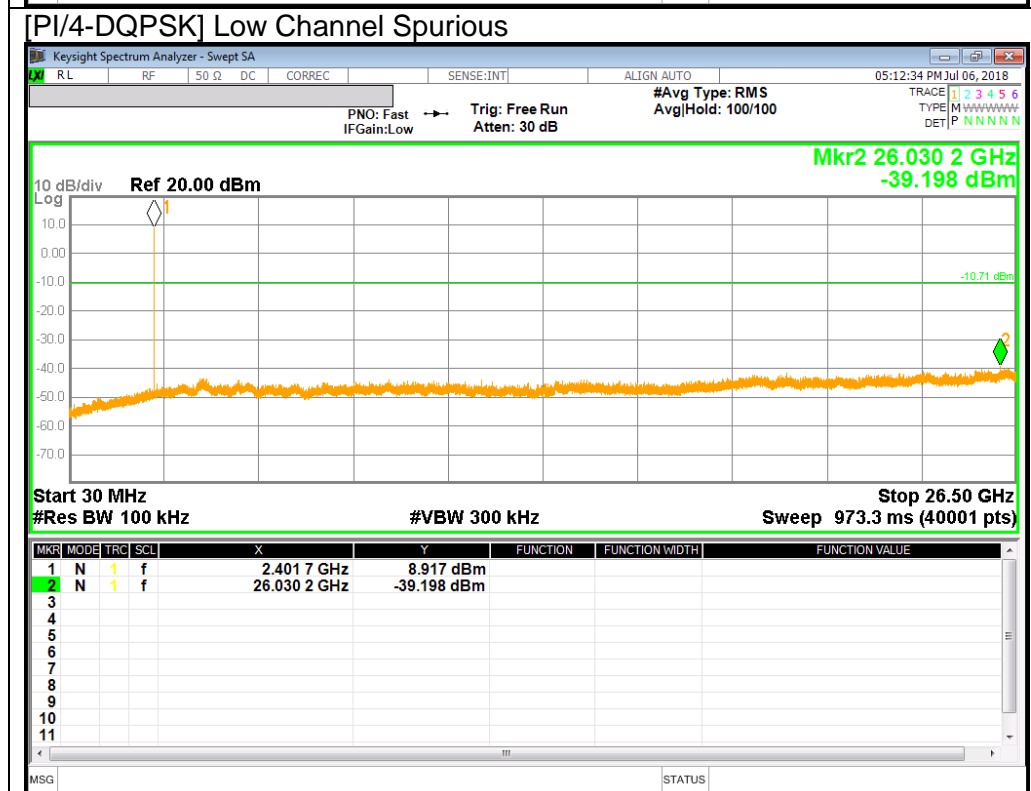
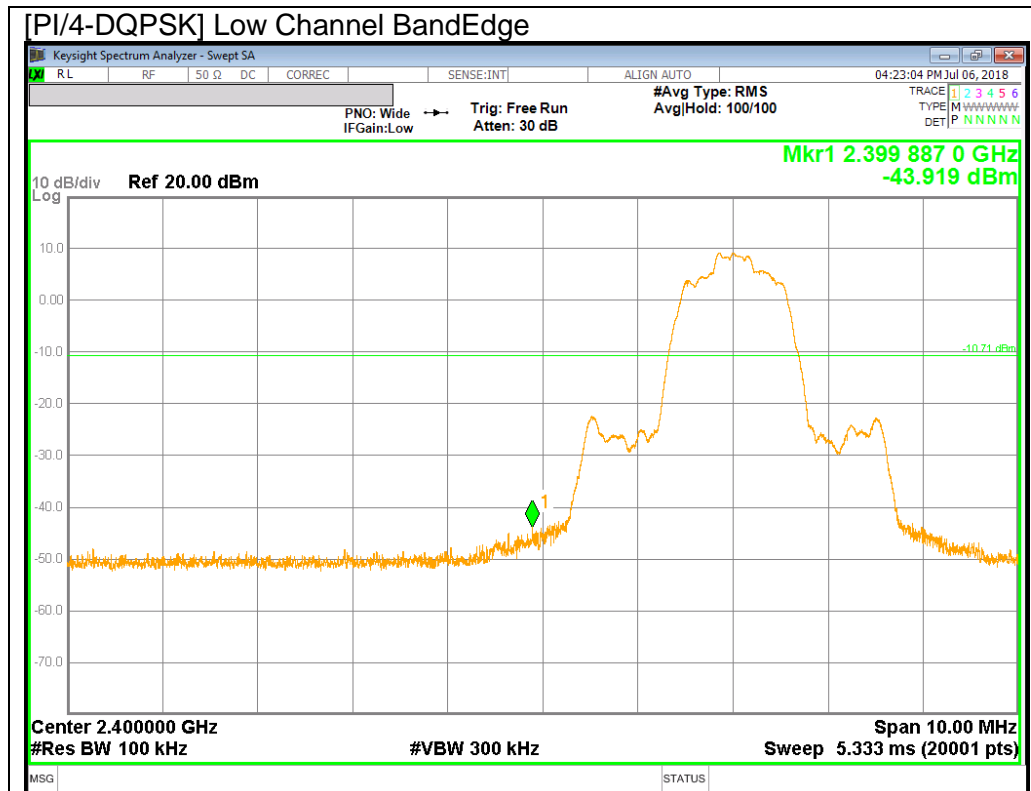

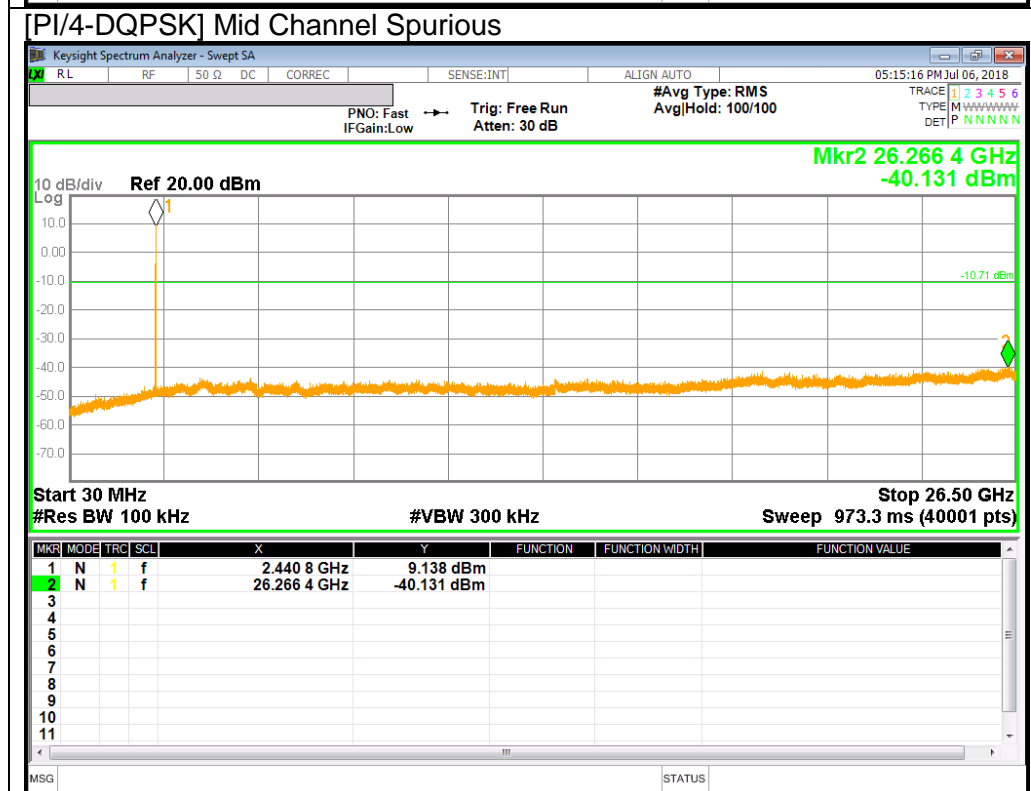
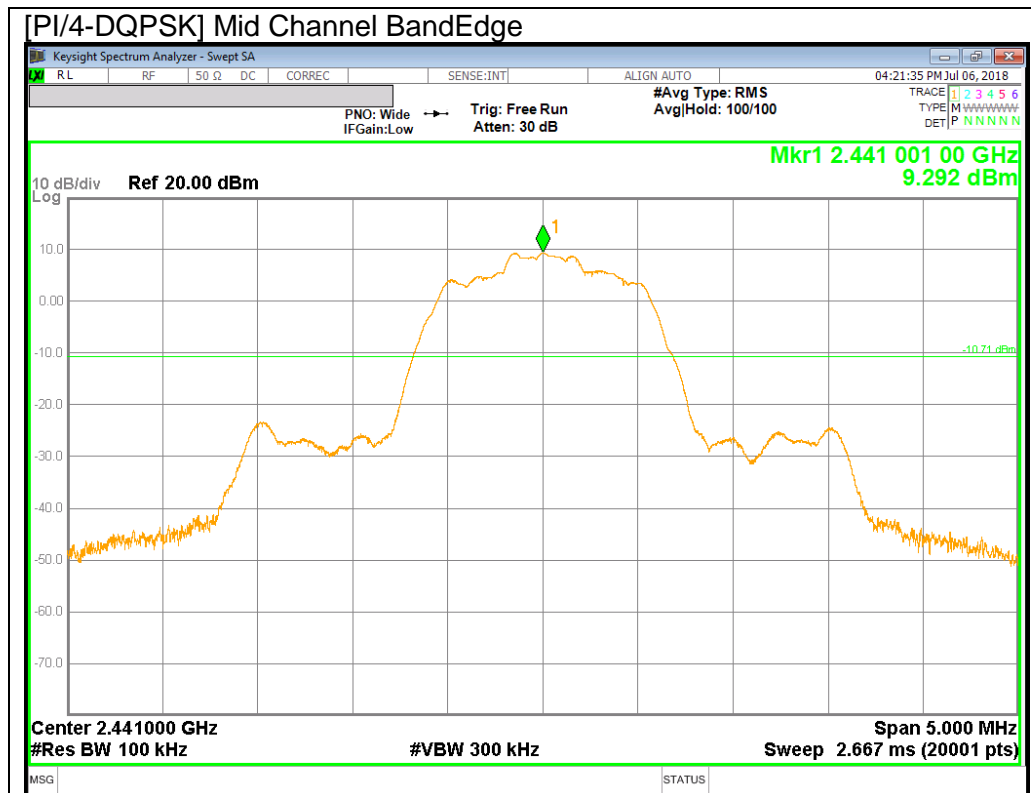

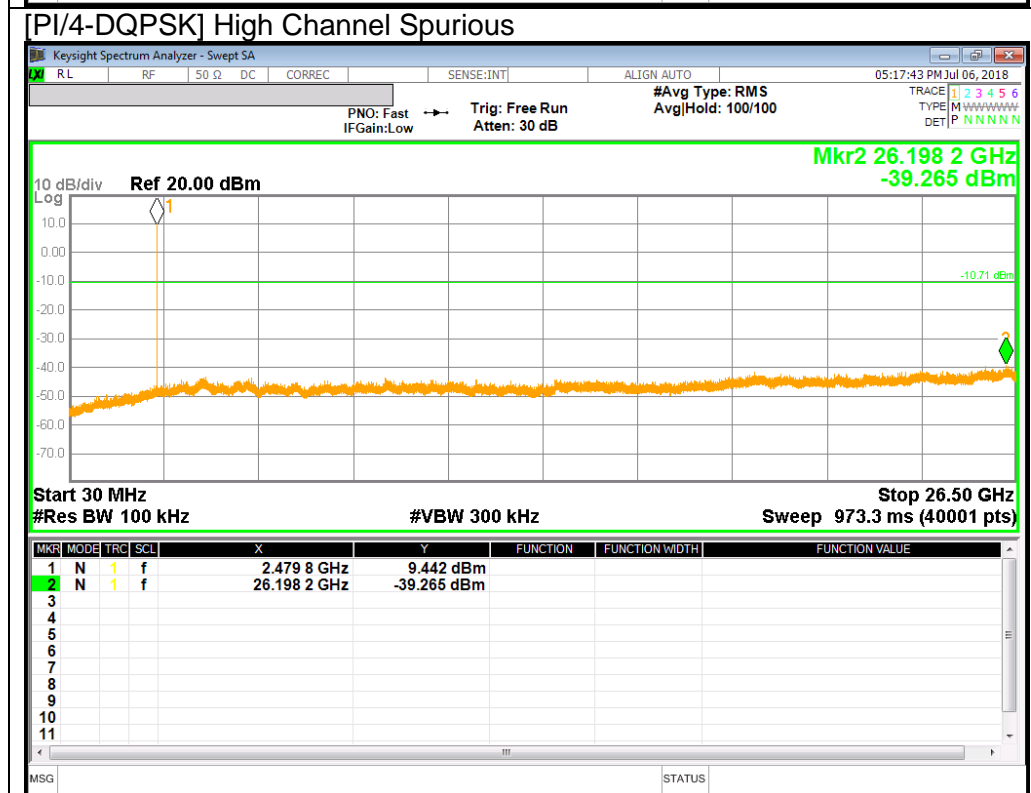
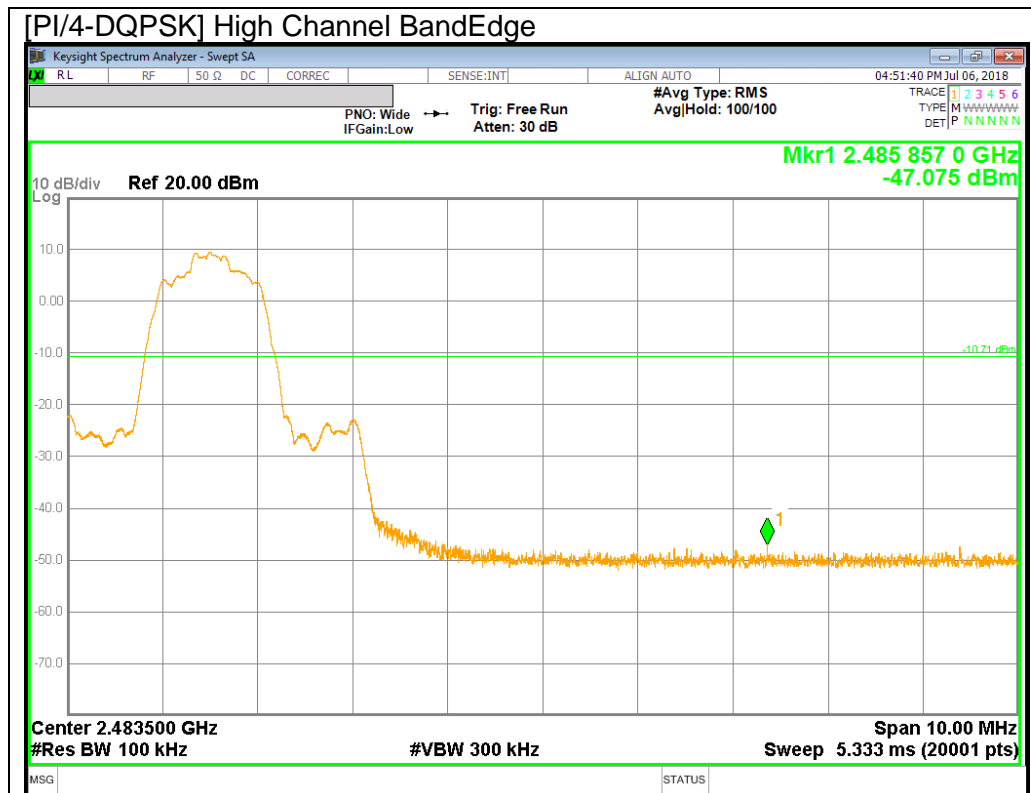

BandEdge Emission at PI/4-DQPSK Hopping Mode

[PI/4-DQPSK Hopping Mode] Low Channel BandEdge

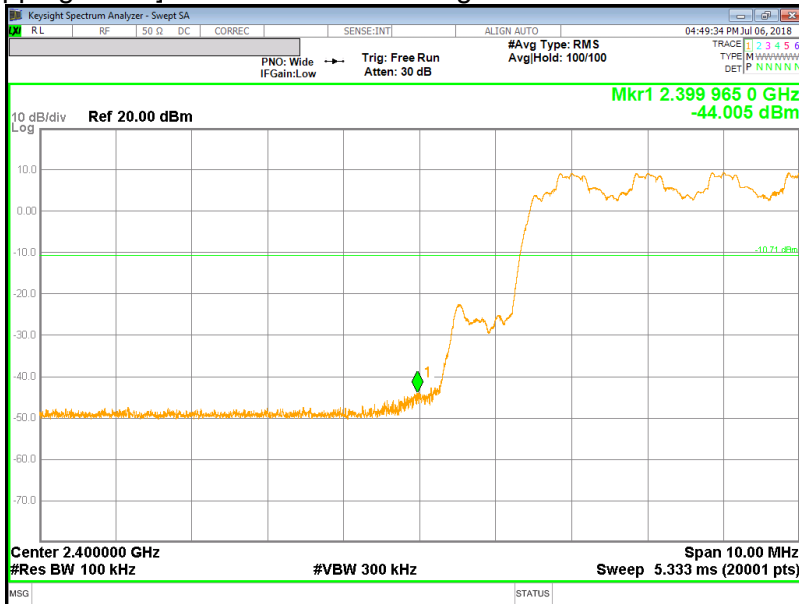

[PI/4-DQPSK Hopping Mode] High Channel BandEdge

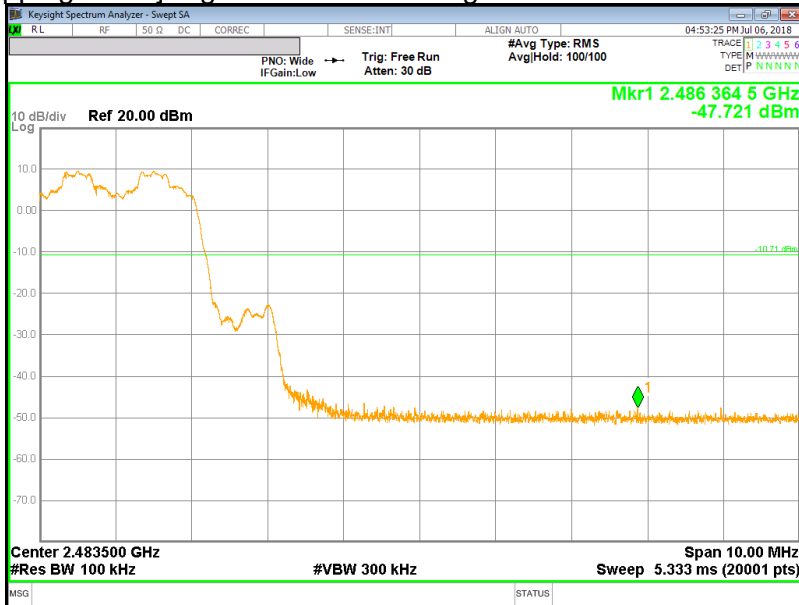

8PSK Mode

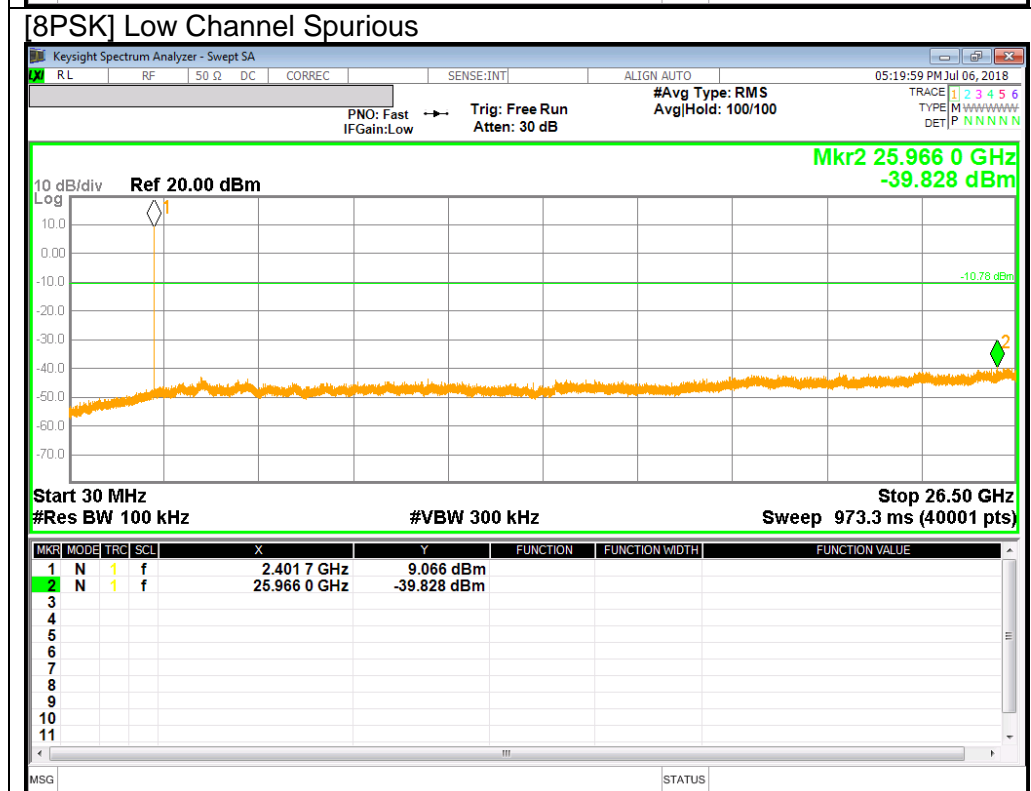
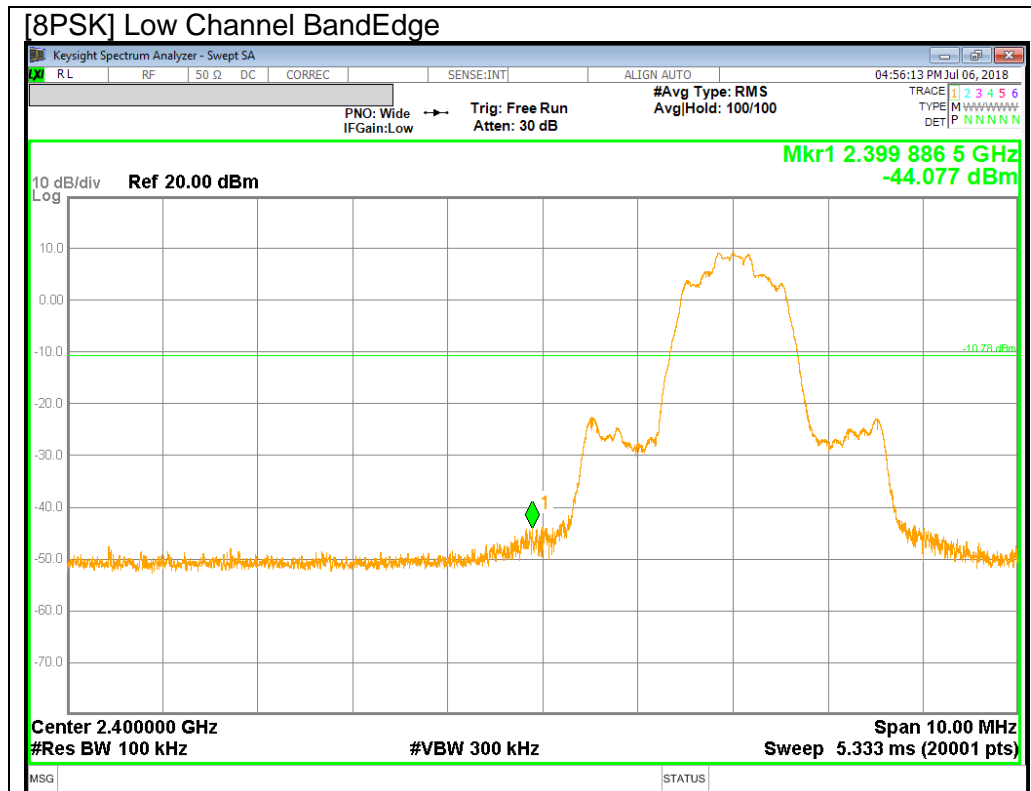

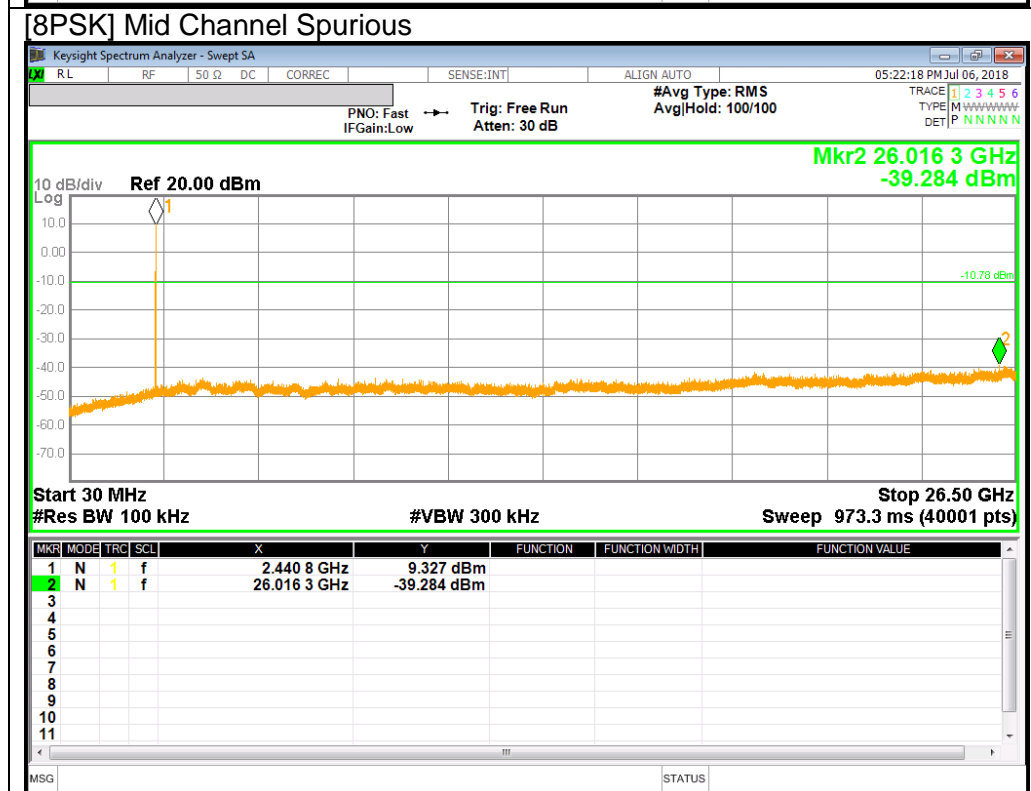
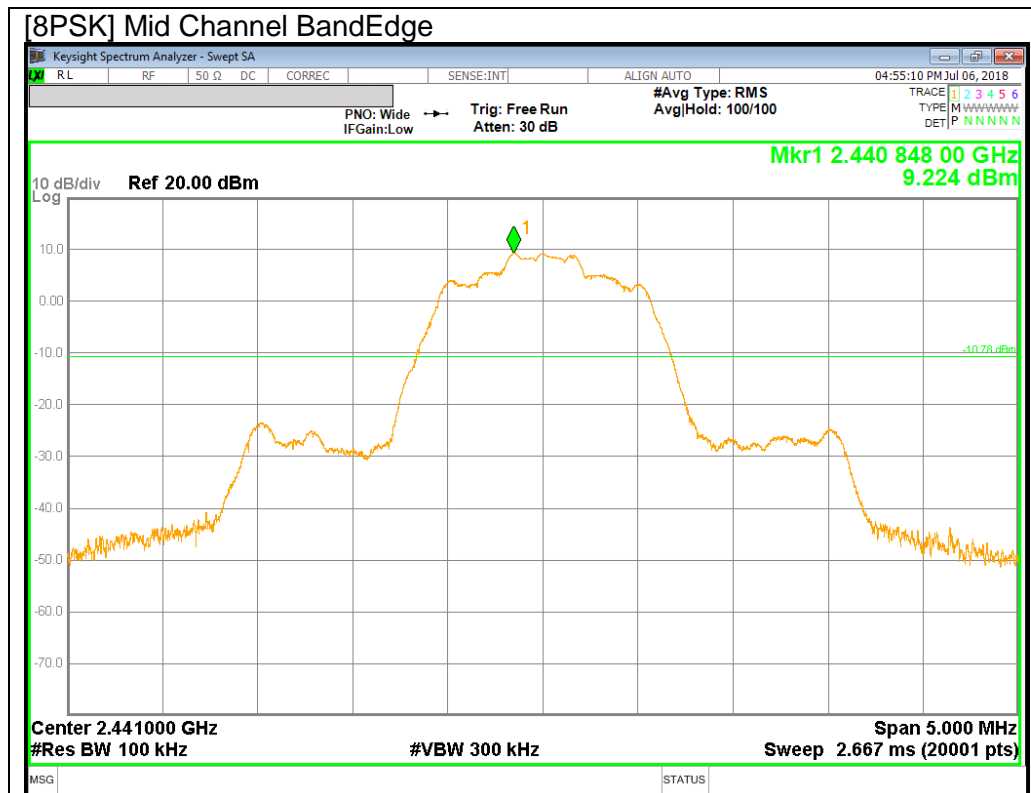

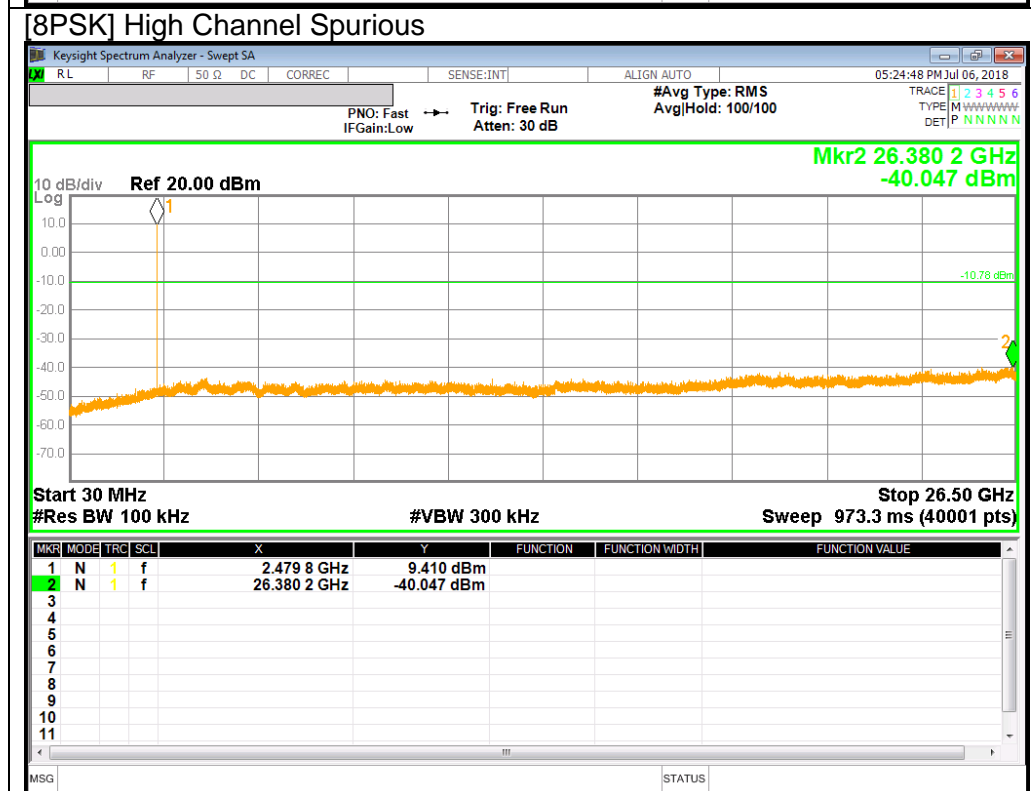
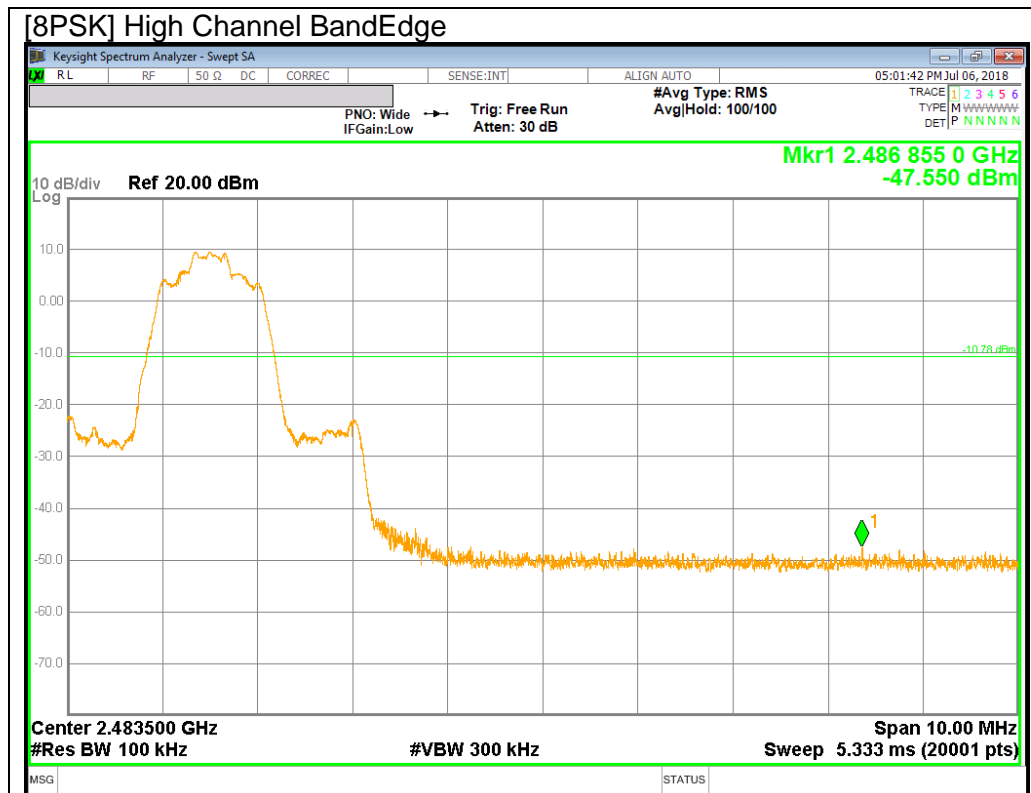

BandEdge Emission at 8PSK Hopping Mode

[8PSK Hopping Mode] Low Channel BandEdge

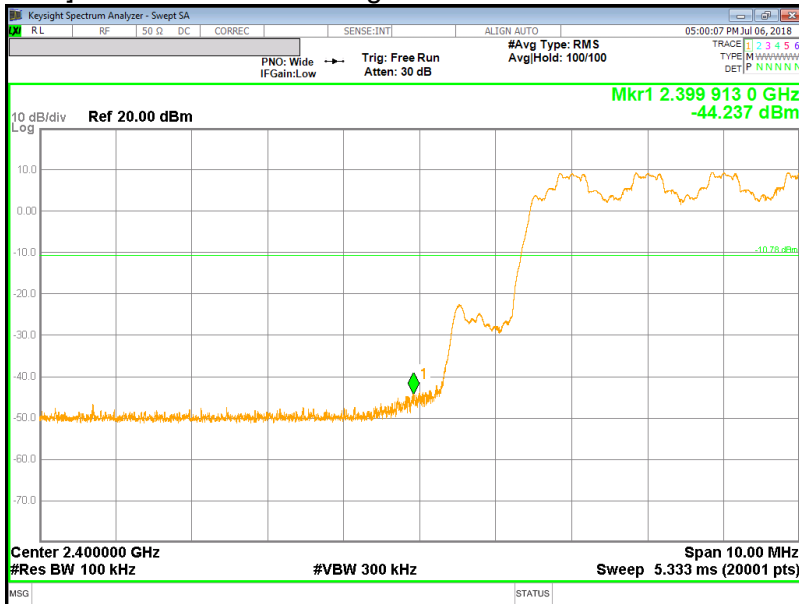

[8PSK Hopping Mode] High Channel BandEdge

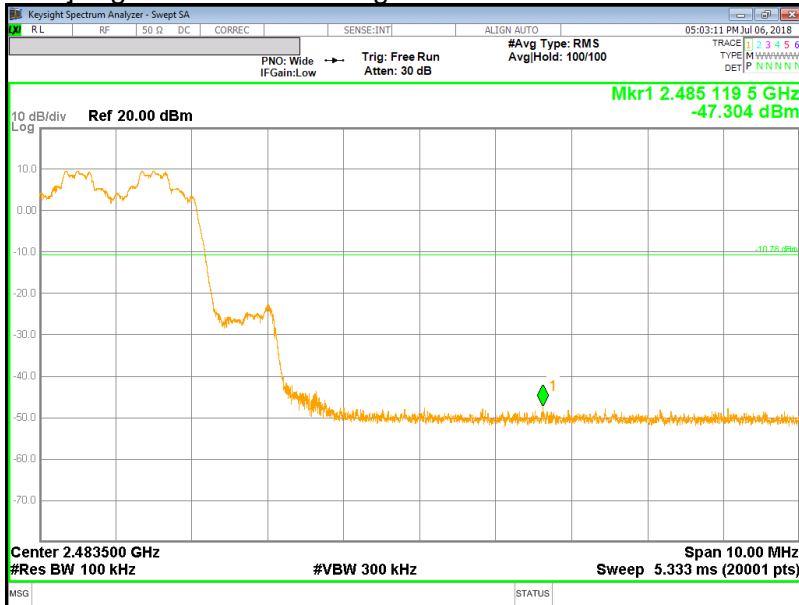

11. RADIATED TEST RESULTS

11.1. LIMITS AND PROCEDURE

LIMITS

FCC §15.205 and §15.209

Limits for radiated disturbance of an intentional radiator		
Frequency range (MHz)	Limits (µV/m)	Measurement Distance (m)
0.009 – 0.490	2400 / F (kHz)	300
0.490 – 1.705	24000 / F (kHz)	30
1.705 – 30.0	30	30
30 – 88	100**	3
88 - 216	150**	3
216 – 960	200**	3
Above 960	500	3

** Except as provided in paragraph (g), fundamental emissions from intentional radiators operating under this section shall not be located in the frequency bands 54-72 MHz, 76-88 MHz, 174-216 MHz or 470-806 MHz. However, operation within these frequency bands is permitted under other sections of this part, e.g. §§ 15.231 and 15.241.

TEST PROCEDURE

The EUT is placed on a non-conducting table 80 cm above the ground plane for below 1GHz and 150 cm for above 1GHz. The EUT is configured in accordance with ANSI C63.10. The EUT is set to transmit in a continuous mode.

For measurements below 1 GHz the resolution bandwidth is set to 100 kHz for peak detection measurements or 120 kHz for quasi-peak detection measurements. Peak detection is used unless otherwise noted as quasi-peak.

For measurements above 1 GHz the resolution bandwidth is set to 1 MHz; the video bandwidth is set to 3 MHz for peak measurements.(Pre-scans to detect harmonic and spurious emissions, the resolution bandwidth is set to 1 MHz; the video bandwidth is set to 30 KHz for peak measurements.)

For band edge measurements above 1 GHz the resolution bandwidth is set to 1 MHz, then the video bandwidth is set to 3 MHz for peak measurements and 1/T (on time) for average measurement.

$$\text{GFSK} = 1/T = 1 / 0.002884\text{S} = 347\text{Hz}.$$

The minimum VBW was 350Hz, but test receiver(ESU40) couldn't set value 350Hz. Due to this reason, testing VBW was set to 500Hz(Worst cases).

The spectrum from 1GHz to 26 GHz is investigated with the transmitter set to the lowest, middle, and highest channels in the 2.4 GHz band.
(From 30MHz to 1GHz, test was performed with the EUT set to transmit at the channel with highest output power)

The frequency range of interest is monitored at a fixed antenna height and EUT azimuth. The EUT is rotated through 360 degrees to maximize emissions received. The antenna is scanned from 1 to 4 meters above the ground plane to further maximize the emission. Measurements are made with the antenna polarized in both the vertical and the horizontal positions.

Note : Emission was pre-scanned from 9KHz to 30MHz; No emissions were detected which was at least 20dB below the specification limit (consider distance correction factor).
Per FCC part 15.31(o), test results were not reported.

Although these tests were performed other than open area test site, adequate comparison measurements were confirmed against 30 m open are test site.
Therefore sufficient tests were made to demonstrate that the alternative site produces results that correlate with the one of tests made in an open field based on KDB 414788.

11.2. TRANSMITTER ABOVE 1 GHz

11.2.1. BASIC DATA RATE GFSK MODULATION

RESTRICTED BANDEDGE (LOW CHANNEL)

HORIZONTAL PEAK AND AVERAGE PLOT

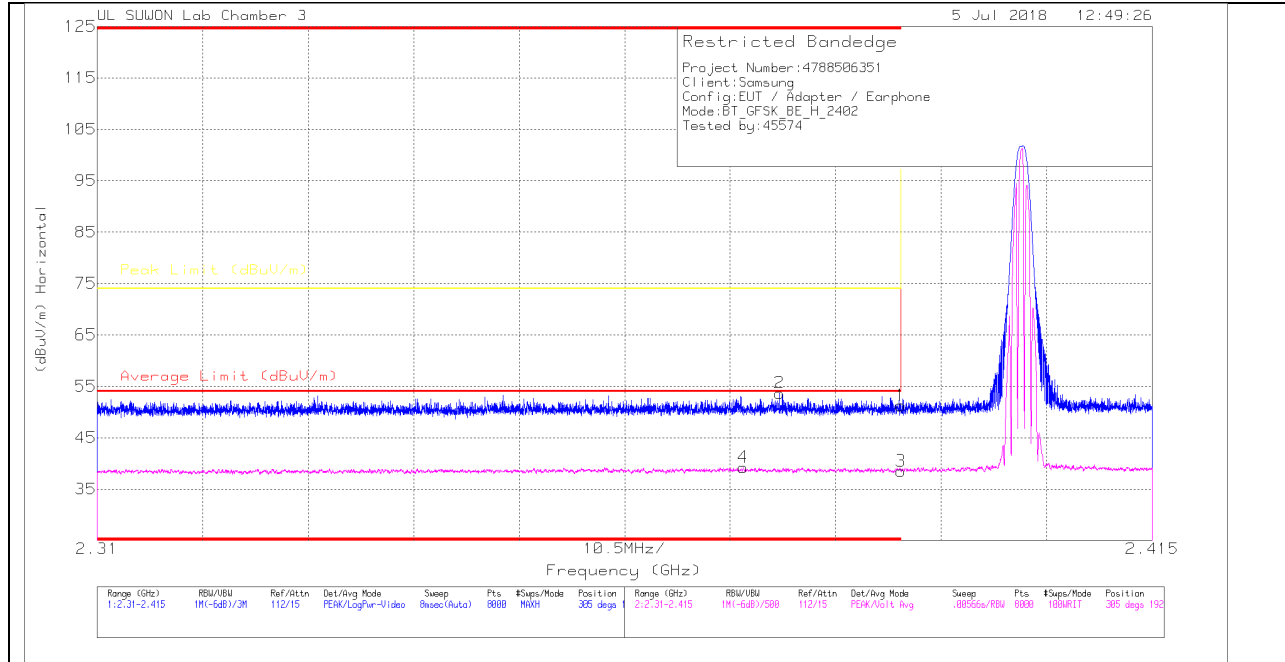

HORIZONTAL DATA

Trace Markers

Marker	Frequency (GHz)	Meter Reading (dBuV)	Det	3117[00205959]	10dB_ATT[dB]	Corrected Reading (dBuV/m)	Average Limit (dBuV/m)	Margin (dB)	Peak Limit (dBuV/m)	PK Margin (dB)	Azimuth (Degs)	Height (cm)	Polarity
1	* 2.39	42.76	Pk	31.8	-23.3	51.26	-	-	74	-22.74	305	192	H
2	* 2.378	45.09	Pk	31.8	-23.2	53.69	-	-	74	-20.31	305	192	H
3	* 2.39	30	VA1T	31.8	-23.3	38.5	54	-15.5	-	-	305	192	H
4	* 2.374	30.73	VA1T	31.7	-23.2	39.23	54	-14.77	-	-	305	192	H

* - indicates frequency in CFR47 Pt 15 / IC RSS-Restricted Band

Pk - Peak detector

VA1T - FHSS: Linear Voltage Average VB=1/Ton where: Ton is transmit duration

VERTICAL PEAK AND AVERAGE PLOT

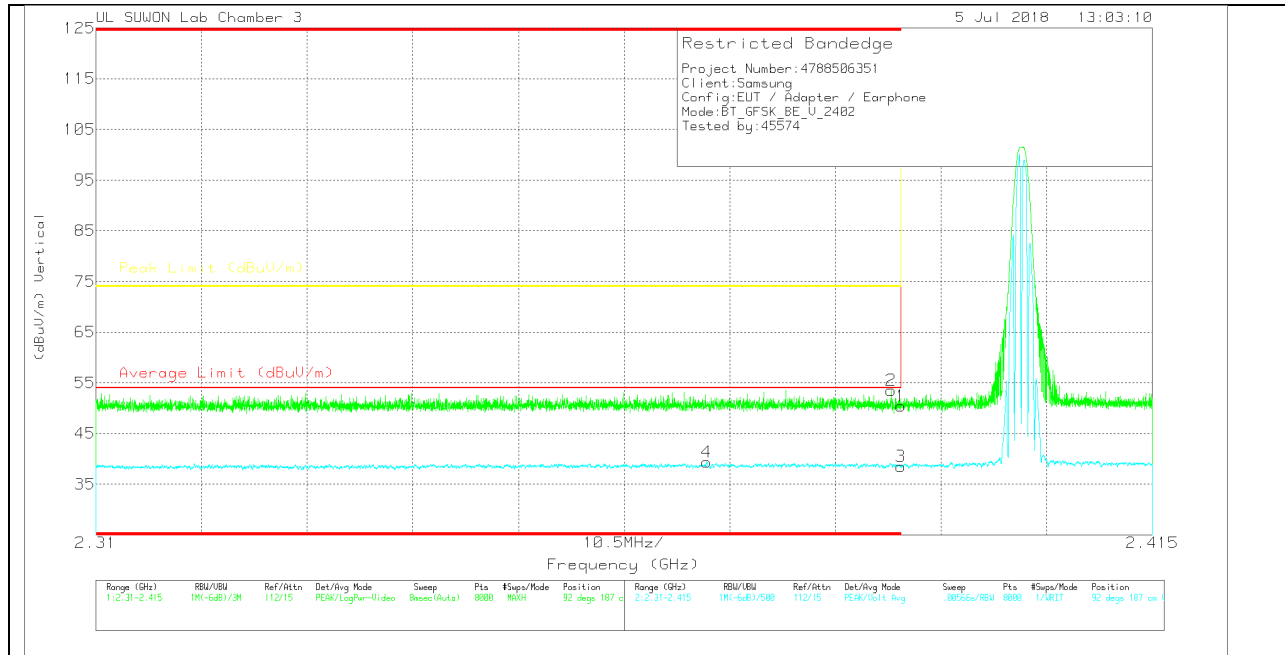

VERTICAL DATA

Trace Markers

Marker	Frequency (GHz)	Meter Reading (dBuV)	Det	3117(00205959)	10dB_ATT[dB]	Corrected Reading (dBuV/m)	Average Limit (dBuV/m)	Margin (dB)	Peak Limit (dBuV/m)	PK Margin (dB)	Azimuth (Degs)	Height (cm)	Polarity
1	* 2.39	41.91	Pk	31.8	-23.3	50.41	-	-	74	-23.59	92	187	V
2	* 2.389	45.02	Pk	31.8	-23.3	53.52	-	-	74	-20.48	92	187	V
3	* 2.39	30	VA1T	31.8	-23.3	38.5	54	-15.5	-	-	92	187	V
4	* 2.371	30.95	VA1T	31.7	-23.3	39.35	54	-14.65	-	-	92	187	V

* - indicates frequency in CFR47 Pt 15 / IC RSS-Restricted Band

Pk - Peak detector

VA1T - FHSS: Linear Voltage Average $V_B=1/T_{on}$ where: T_{on} is transmit duration

AUTHORIZED BANDEDGE (HIGH CHANNEL)

HORIZONTAL PEAK AND AVERAGE PLOT

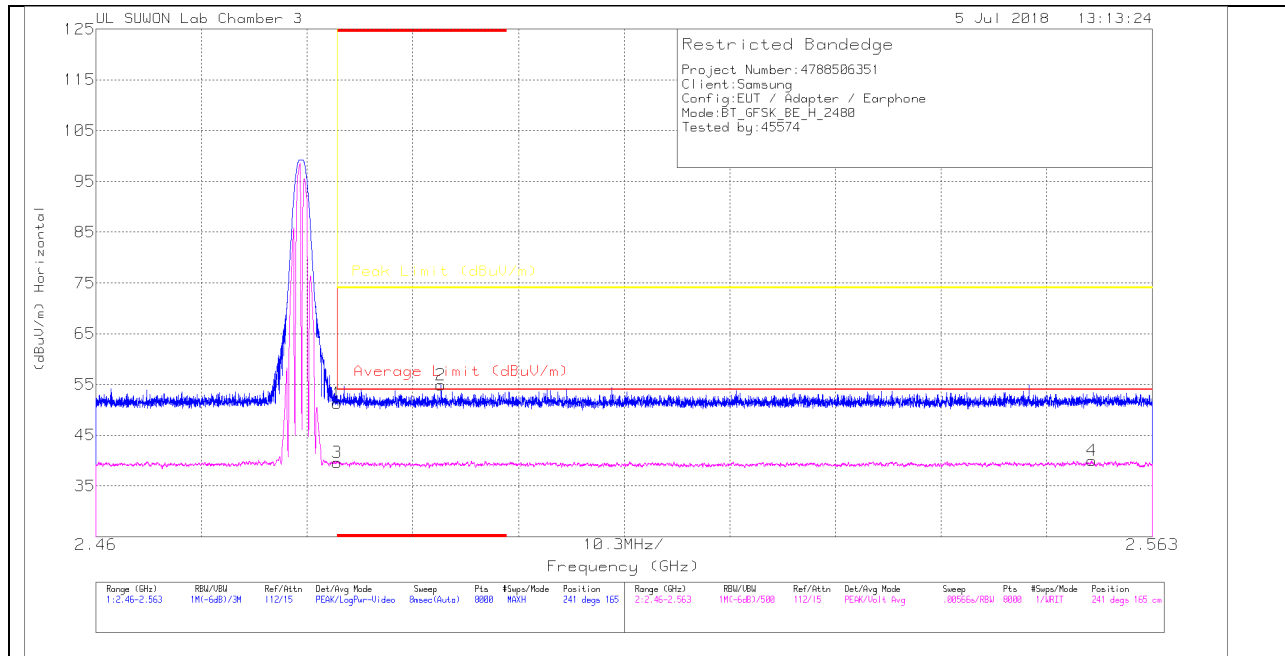

HORIZONTAL DATA

Trace Markers

Marker	Frequency (GHz)	Meter Reading (dBuV)	Det	3117[00205959]	10dB_ATT[dB]	Corrected Reading (dBuV/m)	Average Limit (dBuV/m)	Margin (dB)	Peak Limit (dBuV/m)	PK Margin (dB)	Azimuth (Degs)	Height (cm)	Polarity
1	* 2.484	42.22	Pk	32.1	-23	51.32	-	-	74	-22.68	241	165	H
2	* 2.494	45.86	Pk	32.1	-23.1	54.86	-	-	74	-19.14	241	165	H
3	* 2.484	30.57	VA1T	32.1	-23	39.67	54	-14.33	-	-	241	165	H
4	2.557	30.73	VA1T	32.1	-22.9	39.93	54	-14.07	-	-	241	165	H

* - indicates frequency in CFR47 Pt 15 / IC RSS-Restricted Band

Pk - Peak detector

VA1T - FHSS: Linear Voltage Average VB=1/Ton where: Ton is transmit duration

VERTICAL PEAK AND AVERAGE PLOT

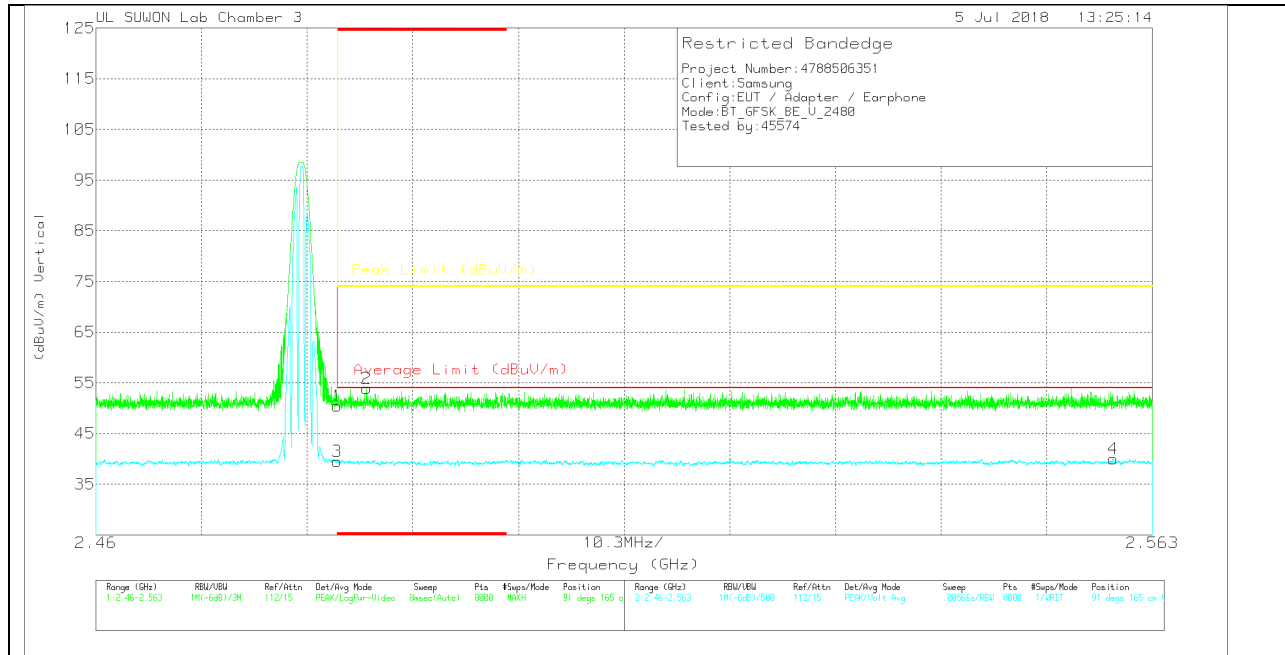

VERTICAL DATA

Trace Markers

Marker	Frequency (GHz)	Meter Reading (dBuV)	Det	3117(00205959)	10dB_ATT[dB]	Corrected Reading (dBuV/m)	Average Limit (dBuV/m)	Margin (dB)	Peak Limit (dBuV/m)	PK Margin (dB)	Azimuth (Degs)	Height (cm)	Polarity
1	* 2.484	41.29	Pk	32.1	-23	50.39	-	-	74	-23.61	91	165	V
2	* 2.486	44.85	Pk	32.1	-23.1	53.85	-	-	74	-20.15	91	165	V
3	* 2.484	30.36	VA1T	32.1	-23	39.46	54	-14.54	-	-	91	165	V
4	2.559	30.79	VA1T	32.1	-22.9	39.99	54	-14.01	-	-	91	165	V

* - indicates frequency in CFR47 Pt 15 / IC RSS-Restricted Band

Pk - Peak detector

VA1T - FHSS: Linear Voltage Average VB=1/Ton where: Ton is transmit duration

HARMONICS AND SPURIOUS EMISSIONS

LOW CHANNEL HORIZONTAL

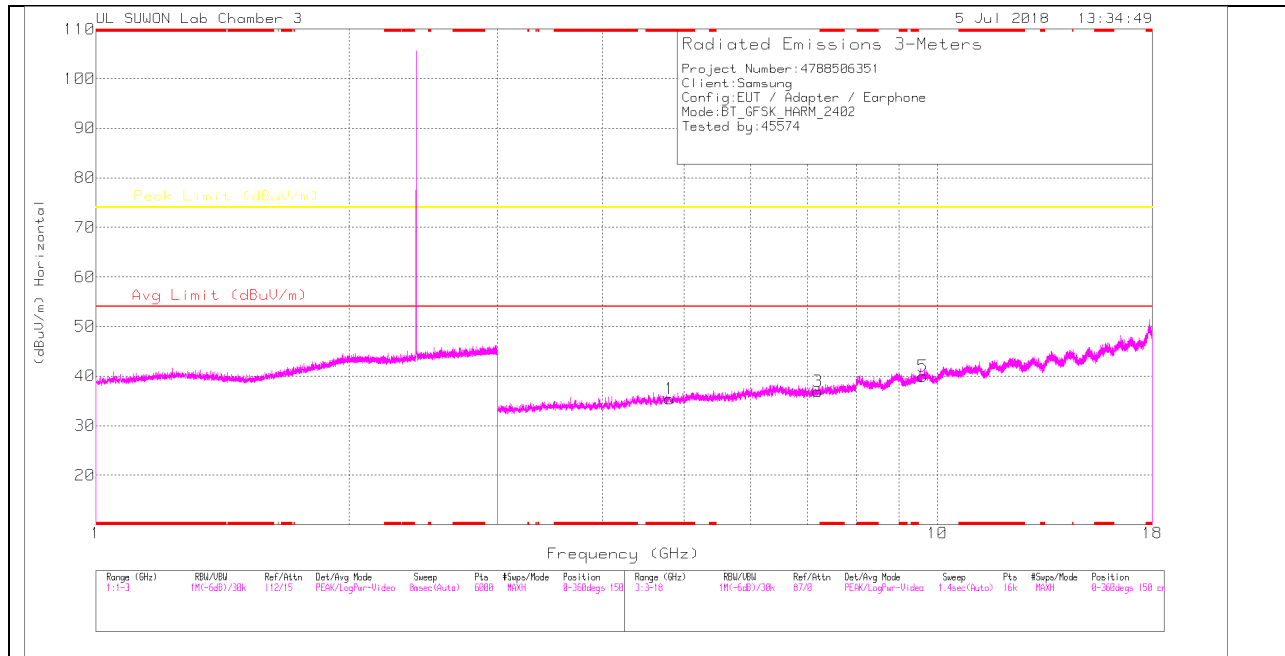

LOW CHANNEL VERTICAL

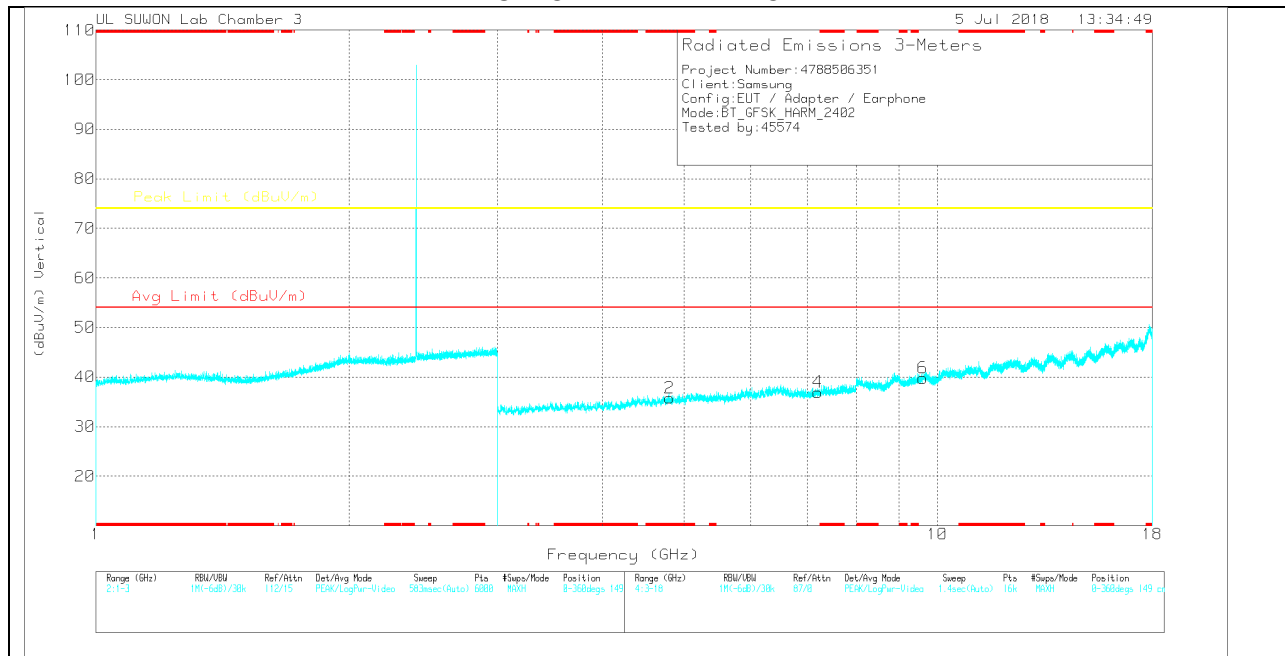

Note: Emission was scanned up to 26GHz; No emissions were detected above the noise floor which was at least 20dB below the specification limit.

LOW CHANNEL DATA

Trace Markers

Marker	Frequency (GHz)	Meter Reading (dBuV)	Det	3117[00205959]	3GHz_HP[dB]	Corrected Reading (dBuV/m)	Avg Limit (dBuV/m)	Margin (dB)	Peak Limit (dBuV/m)	Margin (dB)	Azimuth (Degs)	Height (cm)	Polarity
1	* 4.805	29.69	PK	33.9	-28.2	35.39	-	-	74	-38.61	0-360	250	H
3	7.206	25.17	PK	35.6	-23.9	36.87	-	-	74	-37.13	0-360	150	H
5	9.608	23.12	PK	36.7	-19.9	39.92	-	-	74	-34.08	0-360	250	H
2	* 4.805	30.06	PK	33.9	-28.2	35.76	-	-	74	-38.24	0-360	250	V
4	7.206	25.28	PK	35.6	-23.9	36.98	-	-	74	-37.02	0-360	250	V
6	9.608	22.98	PK	36.7	-19.9	39.78	-	-	74	-34.22	0-360	149	V

* - indicates frequency in CFR47 Pt 15 / IC RSS-Restricted Band

PK – Peak Detector

Note: Only peak measurement was performed. Because peak measurement result of unwanted emission is less than average limit (54dBuV/m).

MID CHANNEL HORIZONTAL

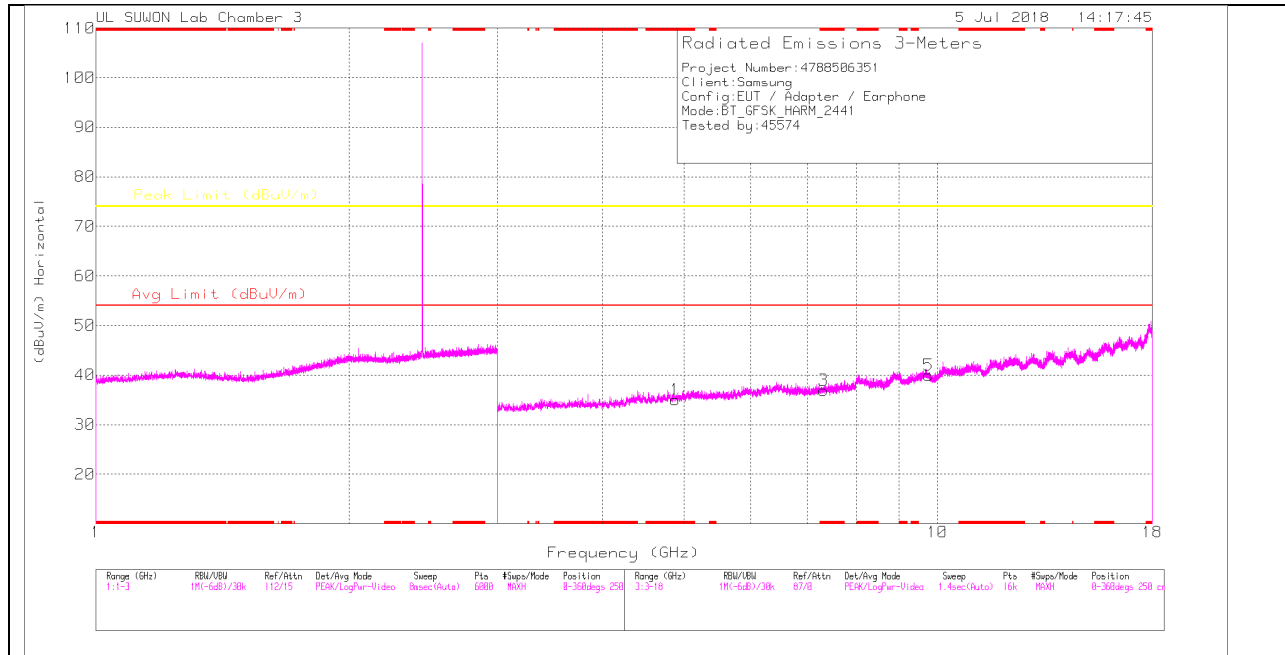

MID CHANNEL VERTICAL

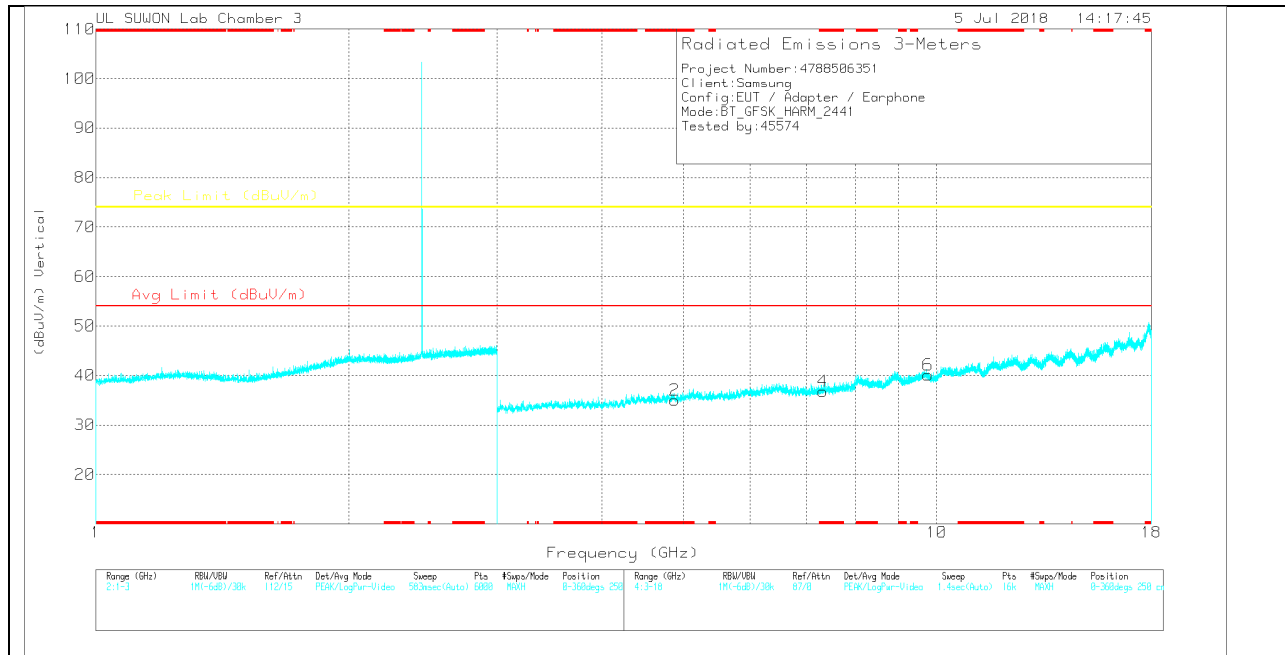

Note: Emission was scanned up to 26GHz; No emissions were detected above the noise floor which was at least 20dB below the specification limit.

MID CHANNEL DATA

Trace Markers

Marker	Frequency (GHz)	Meter Reading (dBuV)	Det	3117[00205959]	3GHz_HP[dB]	Corrected Reading (dBuV/m)	Avg Limit (dBuV/m)	Margin (dB)	Peak Limit (dBuV/m)	Margin (dB)	Azimuth (Degs)	Height (cm)	Polarity
1	* 4.883	29.89	PK	34	-28.9	34.99	-	-	74	-39.01	0-360	250	H
3	* 7.323	24.71	PK	35.6	-23.4	36.91	-	-	74	-37.09	0-360	250	H
5	9.764	22.52	PK	36.9	-19.5	39.92	-	-	74	-34.08	0-360	250	H
2	* 4.883	29.86	PK	34	-28.9	34.96	-	-	74	-39.04	0-360	149	V
4	* 7.323	24.56	PK	35.6	-23.4	36.76	-	-	74	-37.24	0-360	149	V
6	9.765	22.73	PK	36.9	-19.5	40.13	-	-	74	-33.87	0-360	250	V

* - indicates frequency in CFR47 Pt 15 / IC RSS-Restricted Band

PK – Peak Detector

Note: Only peak measurement was performed. Because peak measurement result of unwanted emission is less than average limit (54dBuV/m).

HIGH CHANNEL HORIZONTAL

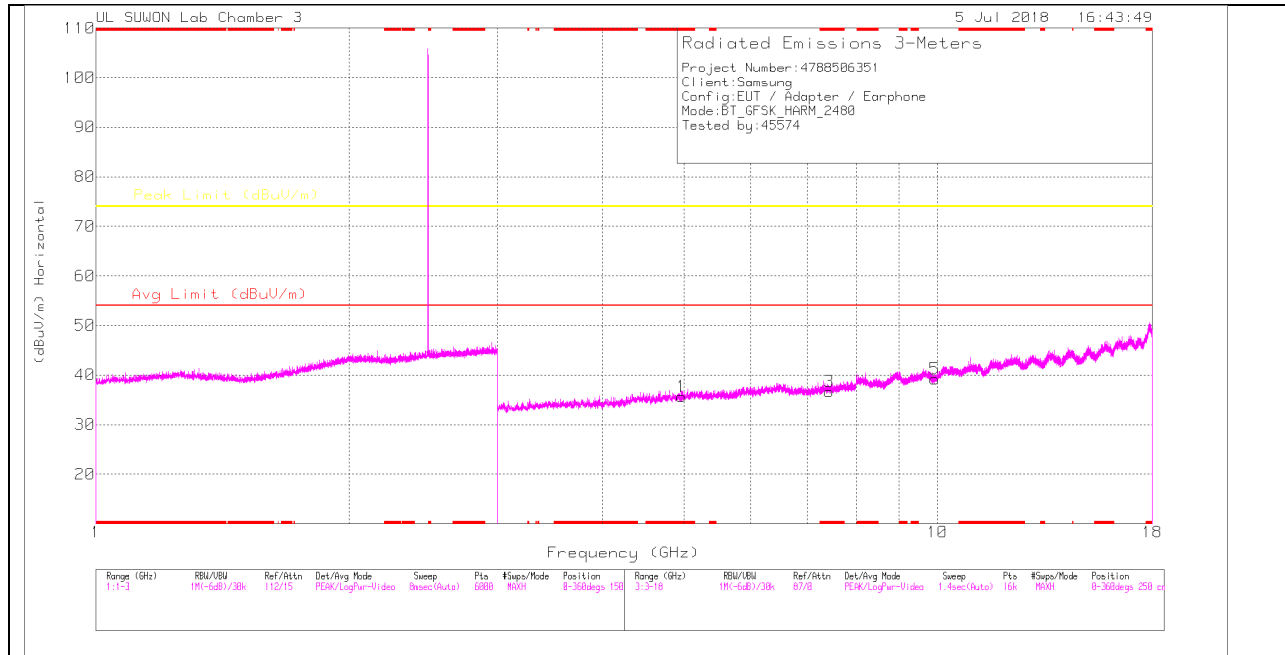

HIGH CHANNEL VERTICAL

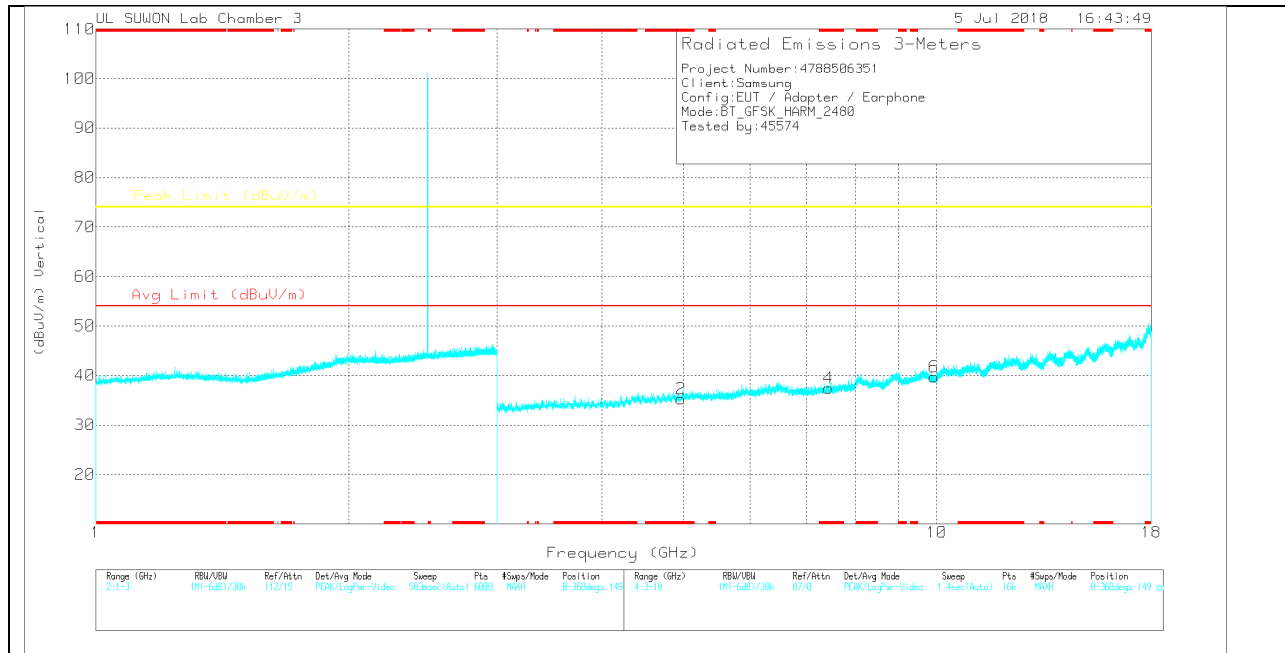

Note: Emission was scanned up to 26GHz; No emissions were detected above the noise floor which was at least 20dB below the specification limit.

HIGH CHANNEL DATA

Trace Markers

Marker	Frequency (GHz)	Meter Reading (dBuV)	Det	3117[00205959]	3GHz_HP[dB]	Corrected Reading (dBuV/m)	Avg Limit (dBuV/m)	Margin (dB)	Peak Limit (dBuV/m)	Margin (dB)	Azimuth (Degs)	Height (cm)	Polarity
1	* 4.96	30.01	PK	34.1	-28.5	35.61	-	-	74	-38.39	0-360	250	H
3	* 7.44	24.25	PK	35.6	-23.2	36.65	-	-	74	-37.35	0-360	250	H
5	9.92	21.88	PK	37	-19.7	39.18	-	-	74	-34.82	0-360	250	H
2	* 4.96	29.72	PK	34.1	-28.5	35.32	-	-	74	-38.68	0-360	149	V
4	* 7.44	25.01	PK	35.6	-23.2	37.41	-	-	74	-36.59	0-360	250	V
6	9.92	22.36	PK	37	-19.7	39.66	-	-	74	-34.34	0-360	250	V

* - indicates frequency in CFR47 Pt 15 / IC RSS-Restricted Band
 PK – Peak Detector

Note: Only peak measurement was performed. Because peak measurement result of unwanted emission is less than average limit (54dBuV/m).

11.2.2. ENHANCED DATA RATE 8PSK MODULATION RESTRICTED BANDEDGE (LOW CHANNEL)

HORIZONTAL PEAK AND AVERAGE PLOT

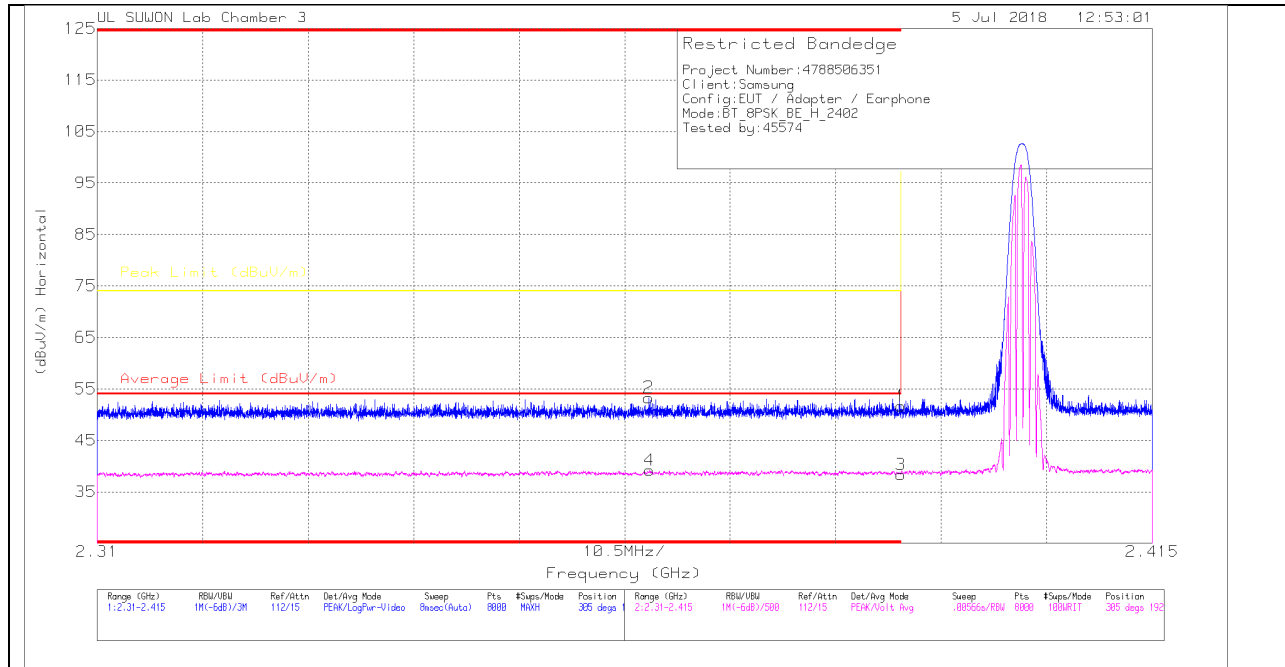

HORIZONTAL DATA

Trace Markers

Marker	Frequency (GHz)	Meter Reading (dBuV)	Det	3117(00205959)	10dB_ATT[dB]	Corrected Reading (dBuV/m)	Average Limit (dBuV/m)	Margin (dB)	Peak Limit (dBuV/m)	PK Margin (dB)	Azimuth (Degs)	Height (cm)	Polarity
1	* 2.39	43.19	Pk	31.8	-23.3	51.69	-	-	74	-22.31	305	192	H
2	* 2.365	44.78	Pk	31.7	-23.2	53.28	-	-	74	-20.72	305	192	H
3	* 2.39	29.85	VA1T	31.8	-23.3	38.35	54	-15.65	-	-	305	192	H
4	* 2.365	30.72	VA1T	31.7	-23.2	39.22	54	-14.78	-	-	305	192	H

* - indicates frequency in CFR47 Pt 15 / IC RSS-Restricted Band

Pk - Peak detector

VA1T - FHSS: Linear Voltage Average $V_B=1/T_{on}$ where: T_{on} is transmit duration

VERTICAL PEAK AND AVERAGE PLOT

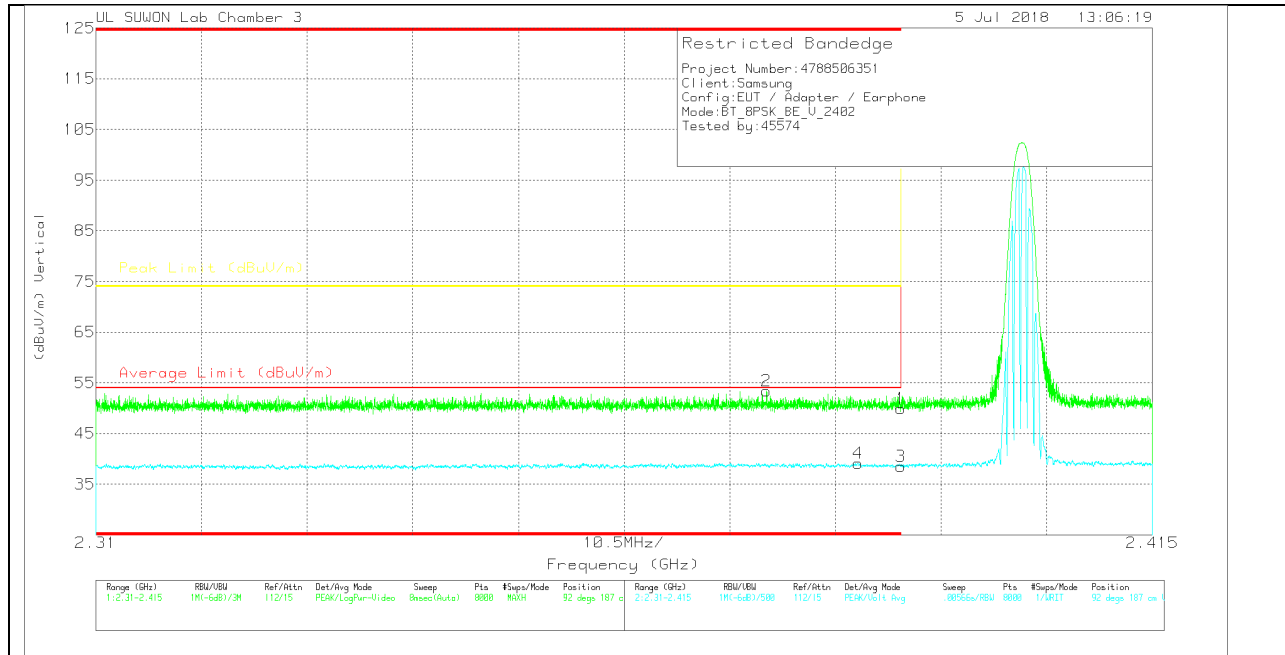

VERTICAL DATA

Trace Markers

Marker	Frequency (GHz)	Meter Reading (dBuV)	Det	3117(00205959)	10dB_ATT[dB]	Corrected Reading (dBuV/m)	Average Limit (dBuV/m)	Margin (dB)	Peak Limit (dBuV/m)	PK Margin (dB)	Azimuth (Degs)	Height (cm)	Polarity
1	* 2.39	41.42	Pk	31.8	-23.3	49.92	-	-	74	-24.08	92	187	V
2	* 2.377	44.81	Pk	31.8	-23.2	53.41	-	-	74	-20.59	92	187	V
3	* 2.39	30.01	VA1T	31.8	-23.3	38.51	54	-15.49	-	-	92	187	V
4	* 2.386	30.67	VA1T	31.8	-23.3	39.17	54	-14.83	-	-	92	187	V

* - indicates frequency in CFR47 Pt 15 / IC RSS-Restricted Band

Pk - Peak detector

VA1T - FHSS: Linear Voltage Average VB=1/Ton where: Ton is transmit duration

AUTHORIZED BANDEDGE (HIGH CHANNEL)

HORIZONTAL PEAK AND AVERAGE PLOT

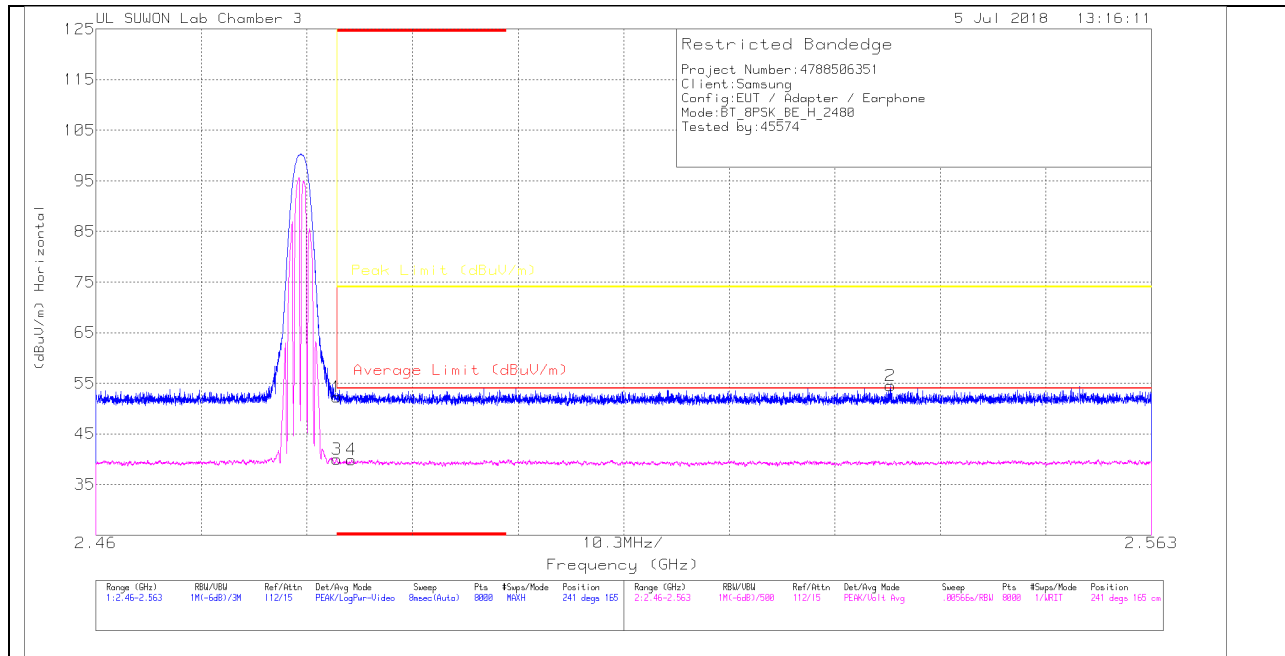

HORIZONTAL DATA

Trace Markers

Marker	Frequency (GHz)	Meter Reading (dBuV)	Det	3117(00205959)	10dB_ATT[dB]	Corrected Reading (dBuV/m)	Average Limit (dBuV/m)	Margin (dB)	Peak Limit (dBuV/m)	PK Margin (dB)	Azimuth (Degs)	Height (cm)	Polarity
1	* 2.484	43.19	Pk	32.1	-23	52.29	-	-	74	-21.71	241	165	H
2	2.538	45.36	Pk	32.1	-23	54.46	-	-	74	-19.54	241	165	H
3	* 2.484	30.88	VA1T	32.1	-23	39.98	54	-14.02	-	-	241	165	H
4	* 2.485	30.92	VA1T	32.1	-23.1	39.92	54	-14.08	-	-	241	165	H

* - indicates frequency in CFR47 Pt 15 / IC RSS-Restricted Band

Pk - Peak detector

VA1T - FHSS: Linear Voltage Average $VB=1/Ton$ where: Ton is transmit duration

VERTICAL PEAK AND AVERAGE PLOT

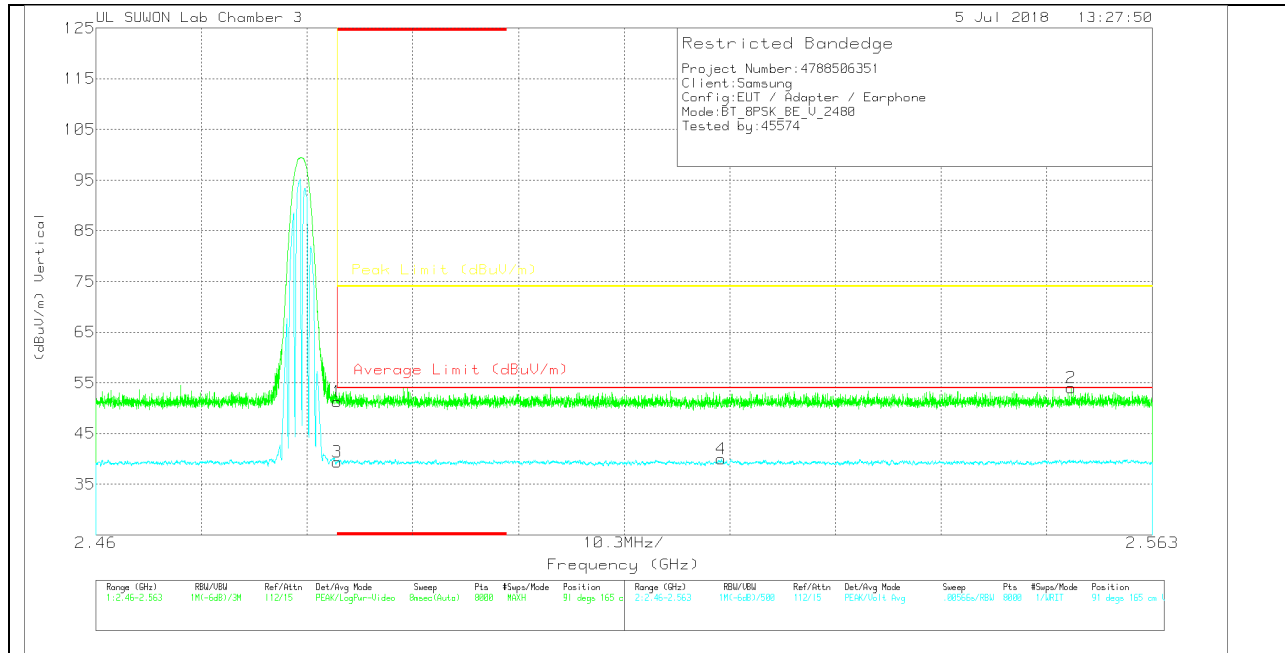

VERTICAL DATA

Trace Markers

Marker	Frequency (GHz)	Meter Reading (dBuV)	Det	3117(00205959)	10dB_ATT(dB)	Corrected Reading (dBuV/m)	Average Limit (dBuV/m)	Margin (dB)	Peak Limit (dBuV/m)	PK Margin (dB)	Azimuth (Degs)	Height (cm)	Polarity
1	* 2.484	42.14	Pk	32.1	-23	51.24	-	-	74	-22.76	91	165	V
2	2.555	44.85	Pk	32.1	-22.9	54.05	-	-	74	-19.95	91	165	V
3	* 2.484	30.32	VA1T	32.1	-23	39.42	54	-14.58	-	-	91	165	V
4	2.521	30.83	VA1T	32.1	-23	39.93	54	-14.07	-	-	91	165	V

* - indicates frequency in CFR47 Pt 15 / IC RSS-Restricted Band

Pk - Peak detector

VA1T - FHSS: Linear Voltage Average VB=1/Ton where: Ton is transmit duration

HARMONICS AND SPURIOUS EMISSIONS

LOW CHANNEL HORIZONTAL

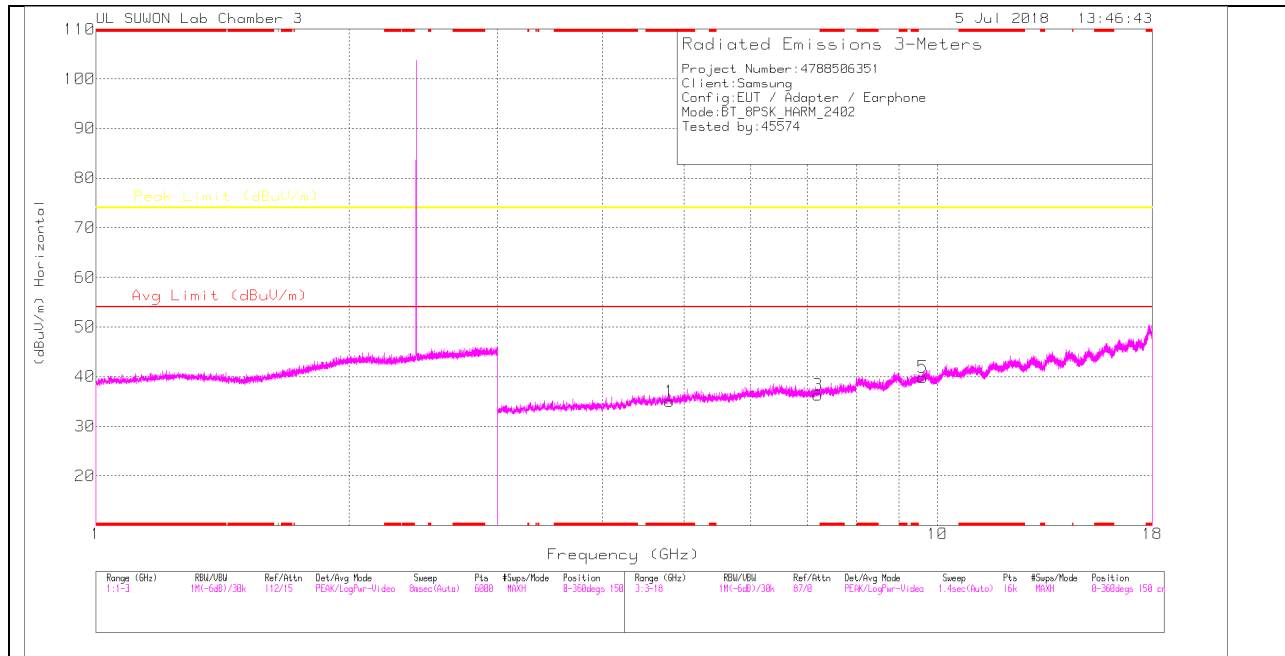

LOW CHANNEL VERTICAL

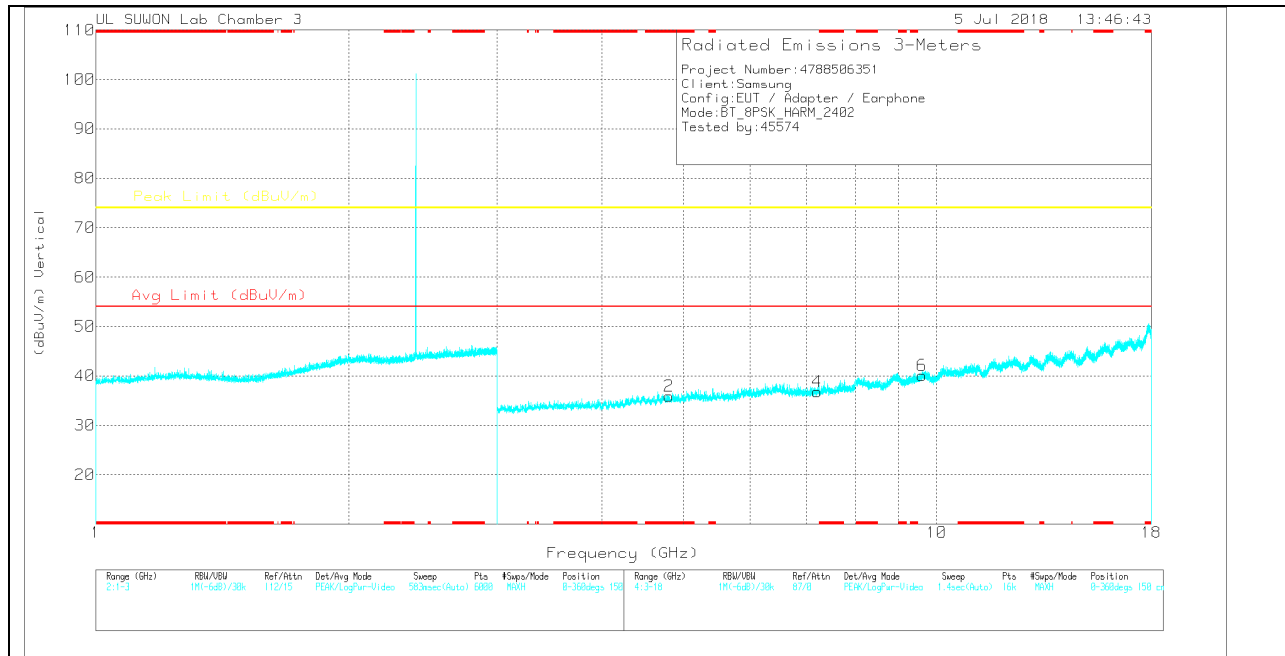

Note: Emission was scanned up to 26GHz; No emissions were detected above the noise floor which was at least 20dB below the specification limit.

LOW CHANNEL DATA

Trace Markers

Marker	Frequency (GHz)	Meter Reading (dBuV)	Det	3117[00205959]	3GHz_HP[dB]	Corrected Reading (dBuV/m)	Avg Limit (dBuV/m)	Margin (dB)	Peak Limit (dBuV/m)	Margin (dB)	Azimuth (Degs)	Height (cm)	Polarity
1	* 4.805	29.27	PK	33.9	-28.2	34.97	-	-	74	-39.03	0-360	150	H
3	7.207	24.67	PK	35.6	-24	36.27	-	-	74	-37.73	0-360	251	H
5	9.608	23.1	PK	36.7	-19.9	39.9	-	-	74	-34.1	0-360	150	H
2	* 4.805	30.17	PK	33.9	-28.2	35.87	-	-	74	-38.13	0-360	250	V
4	7.207	25.25	PK	35.6	-24	36.85	-	-	74	-37.15	0-360	250	V
6	9.608	23.27	PK	36.7	-19.9	40.07	-	-	74	-33.93	0-360	250	V

* - indicates frequency in CFR47 Pt 15 / IC RSS-Restricted Band

PK – Peak Detector

Note: Only peak measurement was performed. Because peak measurement result of unwanted emission is less than average limit (54dBuV/m).

MID CHANNEL HORIZONTAL

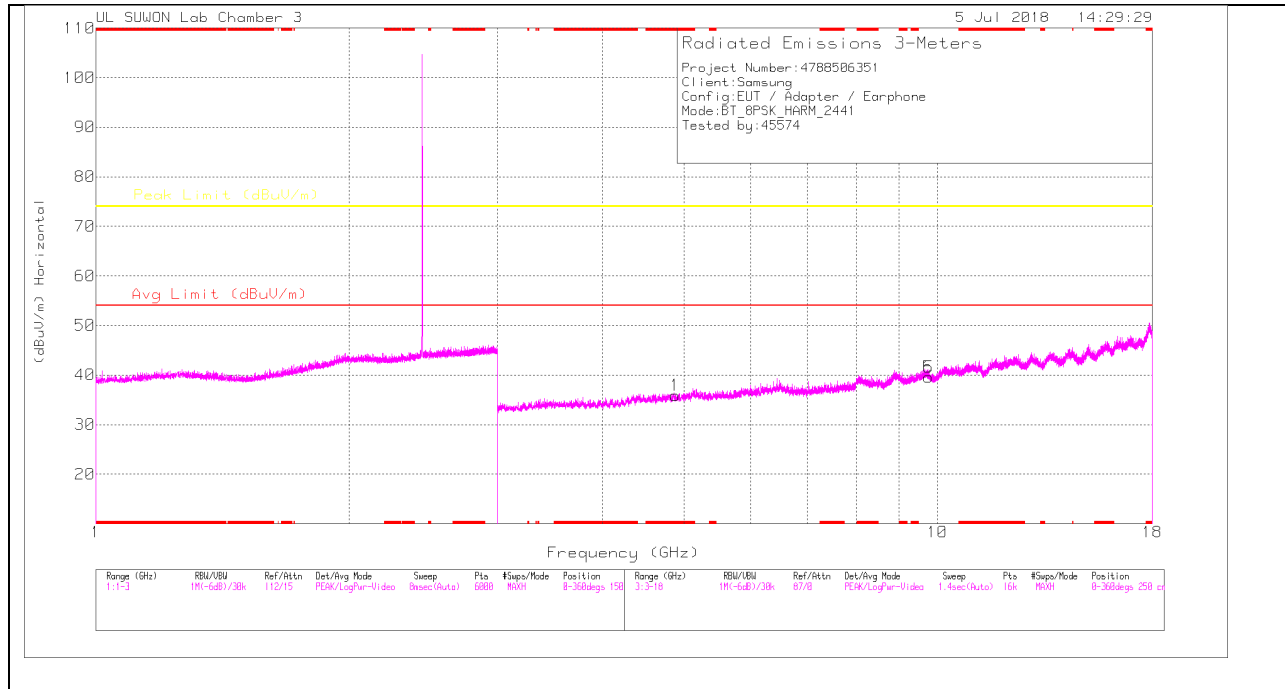

MID CHANNEL VERTICAL

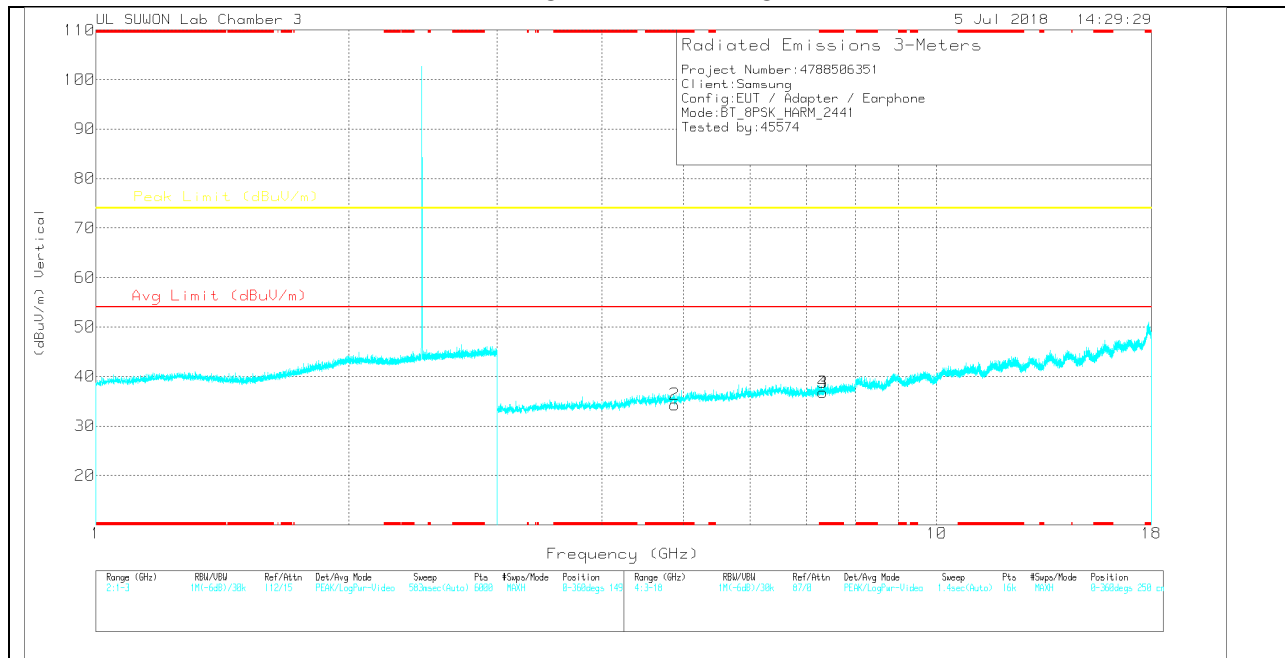

Note: Emission was scanned up to 26GHz; No emissions were detected above the noise floor which was at least 20dB below the specification limit.

MID CHANNEL DATA

Trace Markers

Marker	Frequency (GHz)	Meter Reading (dBuV)	Det	3117[00205959]	3GHz_HP[dB]	Corrected Reading (dBuV/m)	Avg Limit (dBuV/m)	Margin (dB)	Peak Limit (dBuV/m)	Margin (dB)	Azimuth (Degs)	Height (cm)	Polarity
1	* 4.883	30.75	PK	34	-28.9	35.85	-	-	74	-38.15	0-360	150	H
5	9.764	22.15	PK	36.9	-19.5	39.55	-	-	74	-34.45	0-360	150	H
6	9.764	22.15	PK	36.9	-19.5	39.55	-	-	74	-34.45	0-360	150	H
2	* 4.883	29.22	PK	34	-28.9	34.32	-	-	74	-39.68	0-360	250	V
3	* 7.323	24.59	PK	35.6	-23.4	36.79	-	-	74	-37.21	0-360	250	V
4	* 7.323	24.59	PK	35.6	-23.4	36.79	-	-	74	-37.21	0-360	250	V

* - indicates frequency in CFR47 Pt 15 / IC RSS-Restricted Band

PK – Peak Detector

Note: Only peak measurement was performed. Because peak measurement result of unwanted emission is less than average limit (54dBuV/m).

HIGH CHANNEL HORIZONTAL

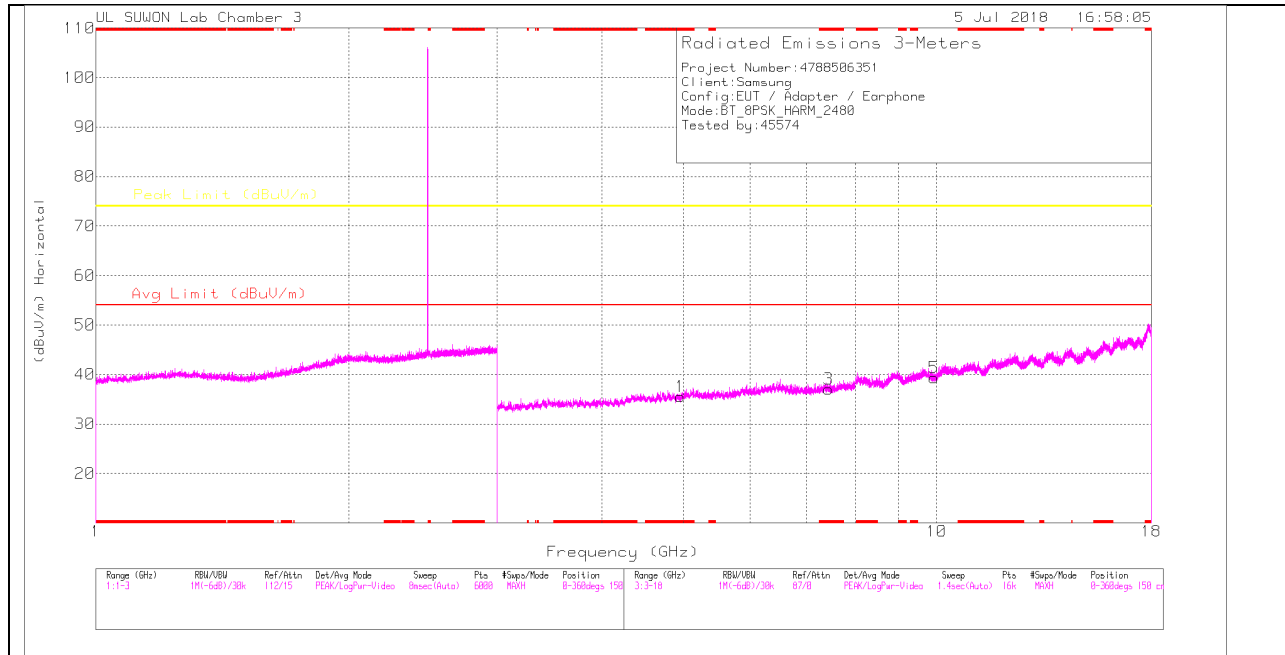

HIGH CHANNEL VERTICAL

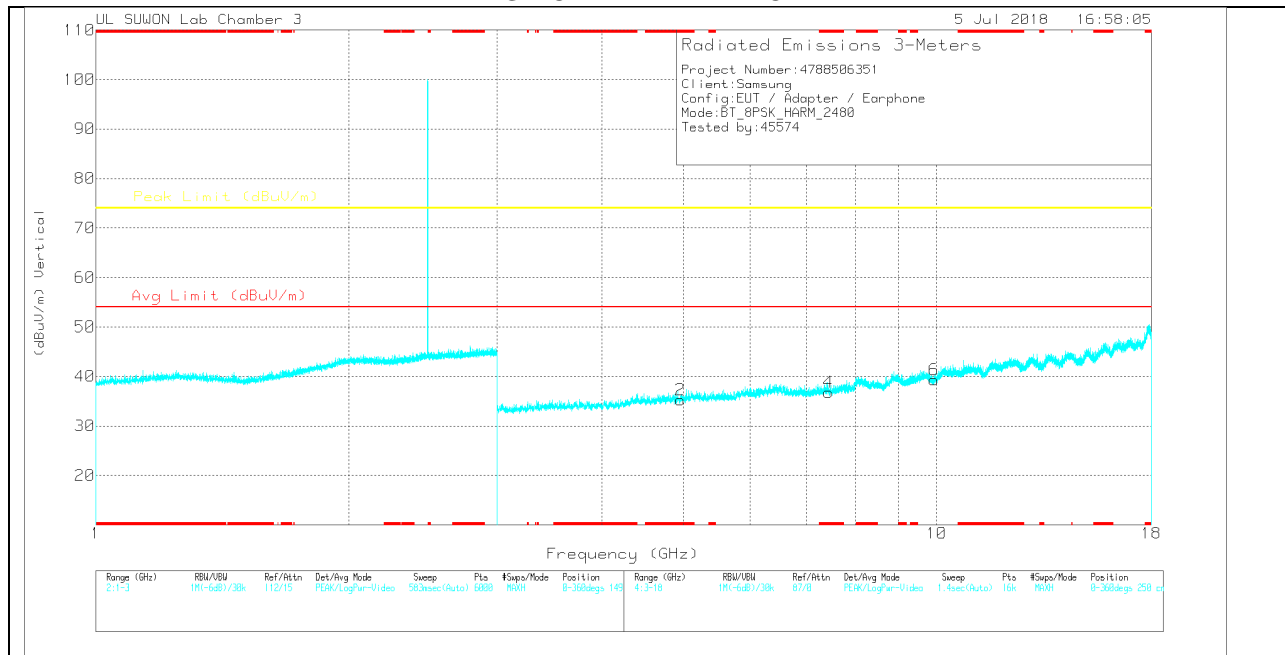

Note: Emission was scanned up to 26GHz; No emissions were detected above the noise floor which was at least 20dB below the specification limit.

HIGH CHANNEL DATA

Trace Markers

Marker	Frequency (GHz)	Meter Reading (dBuV)	Det	3117[00205959]	3GHz_HP[dB]	Corrected Reading (dBuV/m)	Avg Limit (dBuV/m)	Margin (dB)	Peak Limit (dBuV/m)	Margin (dB)	Azimuth (Degs)	Height (cm)	Polarity
1	* 4.959	29.93	PK	34.1	-28.5	35.53	-	-	74	-38.47	0-360	250	H
3	* 7.44	24.66	PK	35.6	-23.2	37.06	-	-	74	-36.94	0-360	150	H
5	9.921	22	PK	37	-19.7	39.3	-	-	74	-34.7	0-360	150	H
2	* 4.959	29.65	PK	34.1	-28.5	35.25	-	-	74	-38.75	0-360	250	V
4	* 7.441	24.45	PK	35.6	-23.2	36.85	-	-	74	-37.15	0-360	150	V
6	9.921	22.03	PK	37	-19.7	39.33	-	-	74	-34.67	0-360	250	V

* - indicates frequency in CFR47 Pt 15 / IC RSS-Restricted Band
 PK – Peak Detector

Note: Only peak measurement was performed. Because peak measurement result of unwanted emission is less than average limit (54dBuV/m).

11.3. WORST-CASE BELOW 1 GHz

GFSK SPURIOUS EMISSIONS 30 TO 1000 MHz

HORIZONTAL PLOT

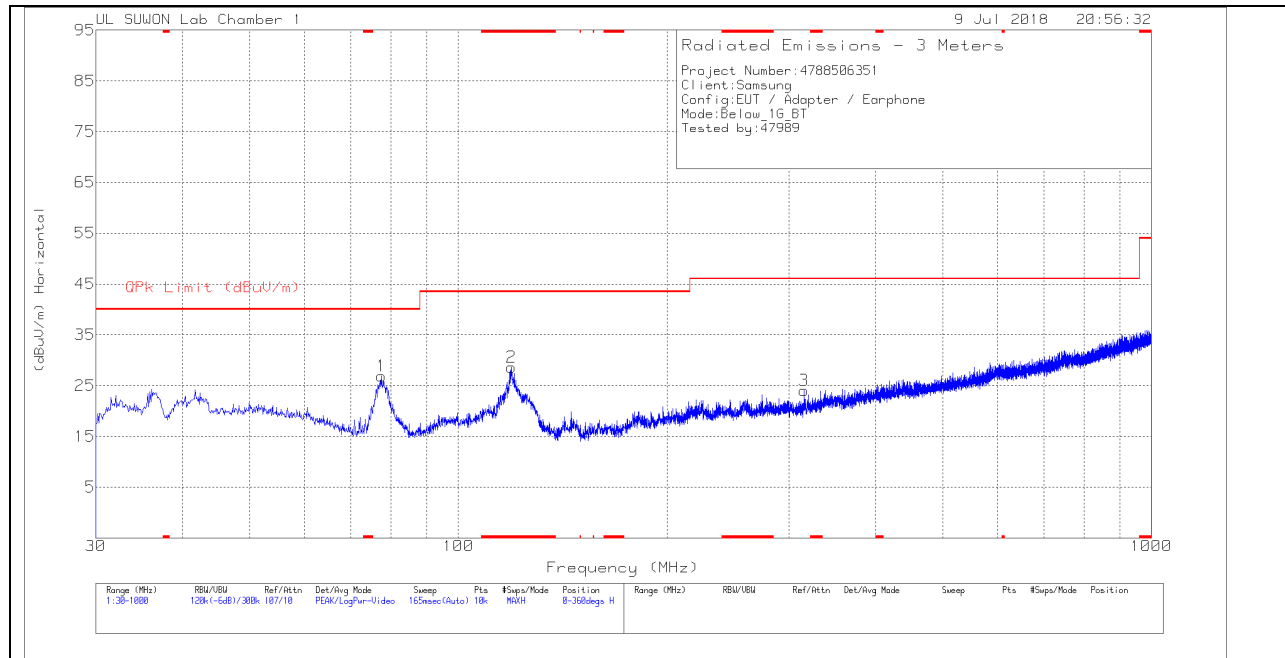

VERTICAL PLOT

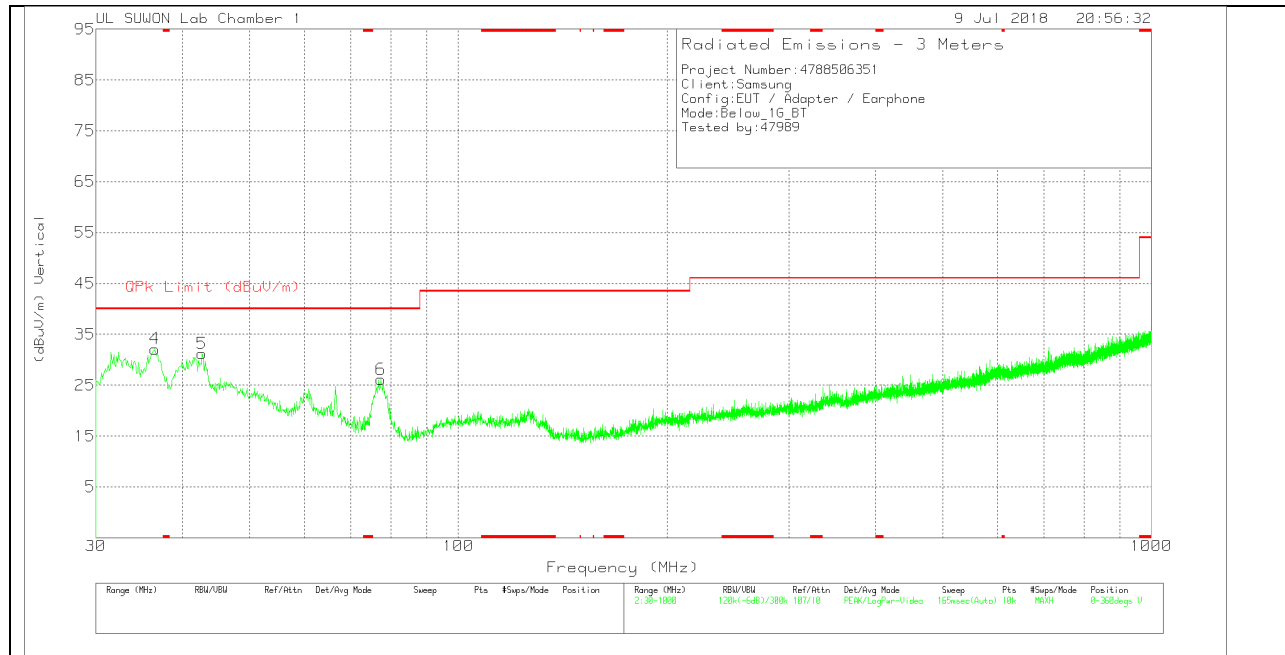

BELOW 1 GHz TABLE

Trace Markers

Marker	Frequency (MHz)	Meter Reading (dBuV)	Det	750_20170831	30-1000MHz[dB]	Corrected Reading (dBuV/m)	QPk Limit (dBuV/m)	Margin (dB)	Azimuth (Degs)	Height (cm)	Polarity
1	77.433	42.67	Pk	13	-28.8	26.87	40	-13.13	0-360	300	H
2	* 119.337	40.66	Pk	16	-28.1	28.56	43.52	-14.96	0-360	200	H
3	315.277	31.35	Pk	19.5	-26.8	24.05	46.02	-21.97	0-360	200	H
4	36.499	44.84	Pk	17.2	-29.9	32.14	40	-7.86	0-360	100	V
5	42.707	41.43	Pk	19.2	-29.4	31.23	40	-8.77	0-360	100	V
6	77.336	41.79	Pk	13.1	-28.8	26.09	40	-13.91	0-360	200	V

* - indicates frequency in CFR47 Pt 15 / IC RSS-Restricted Band
 Pk - Peak detector

GFSK SPURIOUS EMISSIONS 30 TO 1000 MHz (EQUIPPED WITH KEYBOARD)

HORIZONTAL PLOT

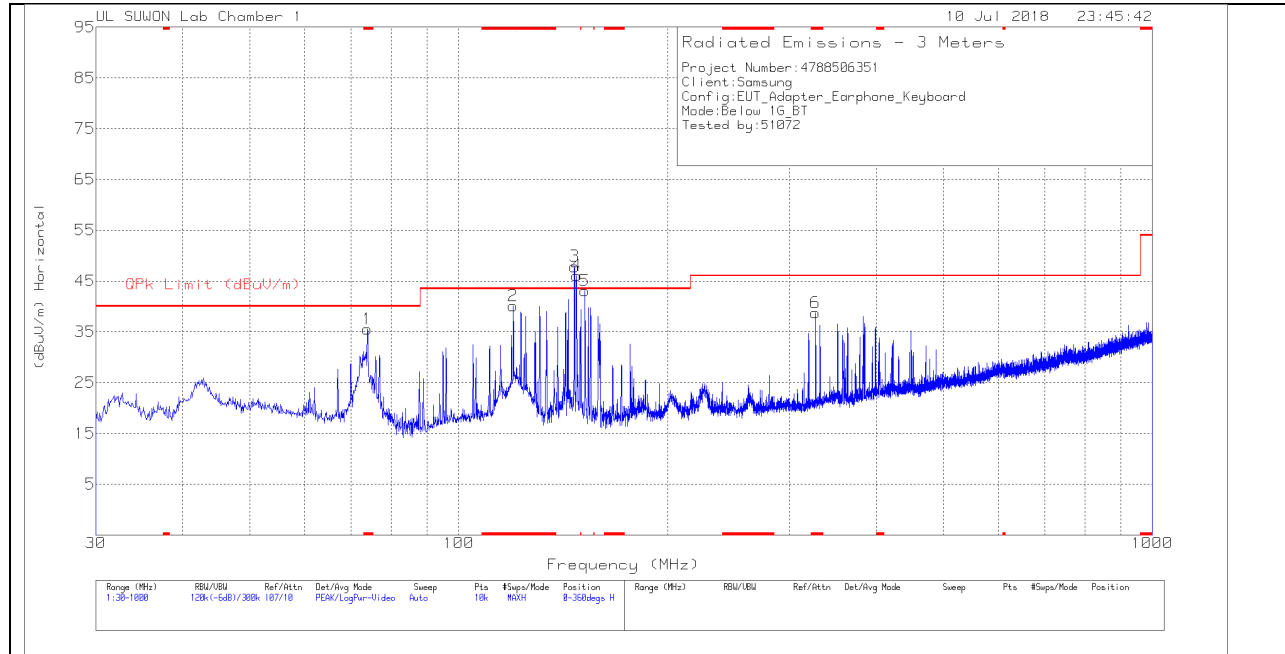

VERTICAL PLOT

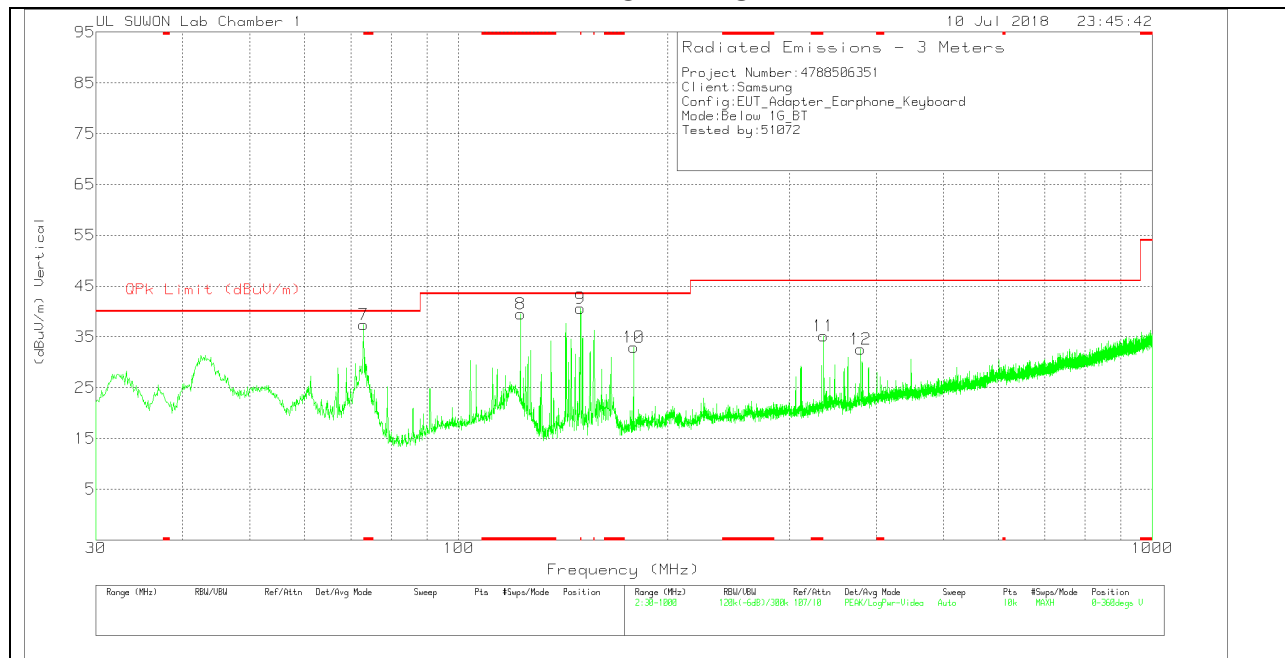

BELOW 1 GHz TABLE

Trace Markers

Marker	Frequency (MHz)	Meter Reading (dBuV)	Det	750_20170831	30-1000MHz[dB]	Corrected Reading (dBuV/m)	QPk Limit (dBuV/m)	Margin (dB)	Azimuth (Degs)	Height (cm)	Polarity
1	* 73.844	50.85	Pk	13.8	-29.1	35.55	40	-4.45	0-360	100	H
2	* 119.919	52.33	Pk	15.9	-28.1	40.13	43.52	-3.39	0-360	400	H
3	146.885	62.05	Pk	13.7	-27.9	47.85	43.52	4.33	0-360	100	H
4	147.855	60.31	Pk	13.7	-27.9	46.11	43.52	2.59	0-360	300	H
5	151.929	56.98	Pk	13.9	-27.8	43.08	43.52	-.44	0-360	200	H
6	* 326.917	45.52	Pk	19.9	-26.7	38.72	46.02	-7.3	0-360	100	H
7	72.971	52.42	Pk	14.1	-29.1	37.42	40	-2.58	0-360	300	V
8	* 122.829	52.35	Pk	15.4	-28.2	39.55	43.52	-3.97	0-360	200	V
9	149.892	54.74	Pk	13.8	-27.9	40.64	43.52	-2.88	0-360	100	V
10	178.798	45.19	Pk	15.3	-27.6	32.89	43.52	-10.63	0-360	100	V
11	335.841	41.45	Pk	20.4	-26.7	35.15	46.02	-10.87	0-360	200	V
12	379.976	38.02	Pk	20.9	-26.4	32.52	46.02	-13.5	0-360	200	V

* - indicates frequency in CFR47 Pt 15 / IC RSS-Restricted Band
 Pk - Peak detector

Radiated Emissions

Frequency (MHz)	Meter Reading (dBuV)	Det	750_20170831	30-1000MHz[dB]	Corrected Reading (dBuV/m)	QPk Limit (dBuV/m)	Margin (dB)	Azimuth (Degs)	Height (cm)	Polarity
* 73.6044	42.33	Qp	13.9	-29.2	27.03	40	-12.97	294	255	H
* 120.1376	35.43	Qp	15.8	-28.2	23.03	43.52	-20.49	168	182	H
147.1193	34.49	Qp	13.7	-27.9	20.29	43.52	-23.23	357	180	H
147.8668	41.53	Qp	13.7	-27.9	27.33	43.52	-16.19	40	247	H
152.0342	33.25	Qp	13.9	-27.8	19.35	43.52	-24.17	8	199	H
72.7562	40.05	Qp	14.2	-29.1	25.15	40	-14.85	136	160	V

* - indicates frequency in CFR47 Pt 15 / IC RSS-Restricted Band
 Qp - Quasi-Peak detector

12. AC POWER LINE CONDUCTED EMISSIONS

LIMITS

FCC §15.207 (a)

Frequency of Emission (MHz)	Conducted Limit (dBuV)	
	Quasi-peak	Average
0.15-0.5	66 to 56	56 to 46
0.5-5	56	46
5-30	60	50

*Decreases with the logarithm of the frequency.

TEST PROCEDURE

The EUT is placed on a non-conducting table 40 cm from the vertical ground plane and 80 cm above the horizontal ground plane. The EUT is configured in accordance with ANSI C63.10.

The receiver is set to a resolution bandwidth of 9 kHz. Peak detection is used unless otherwise noted as quasi-peak or average.

Line conducted data is recorded for both NEUTRAL and HOT lines.

RESULTS

WORST EMISSIONS

LINE 1 PLOT

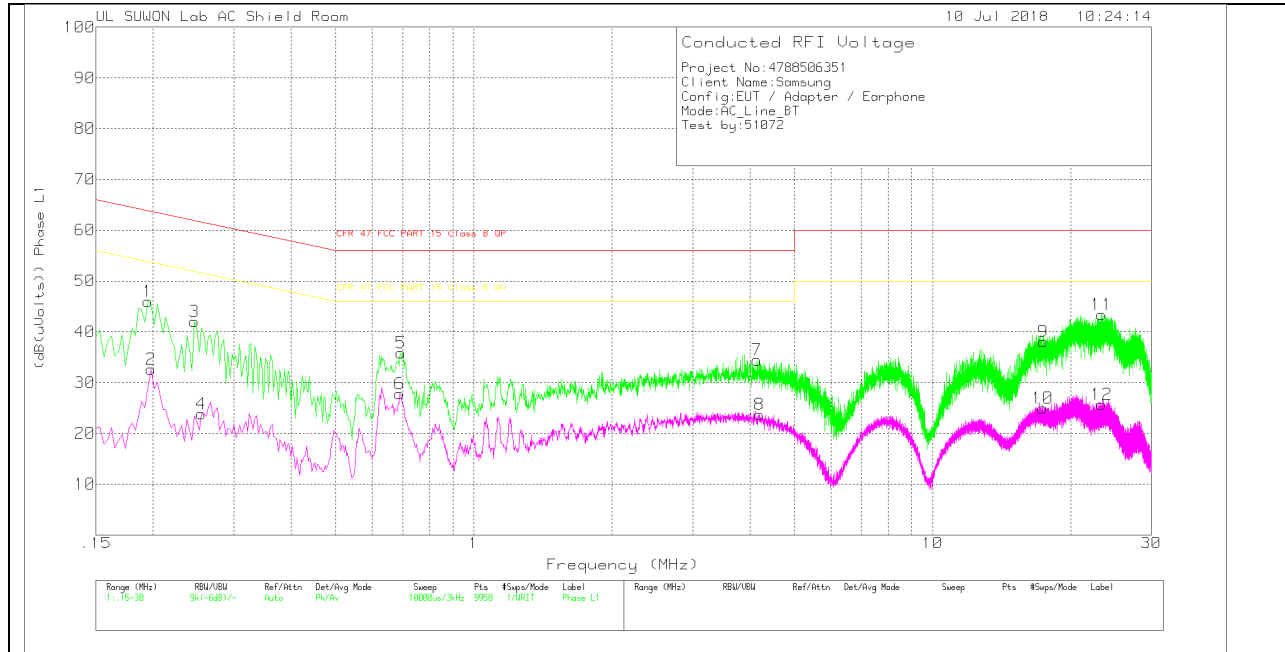

LINE 1 RESULTS

Trace Markers

Range 1: Phase L1 .15 - 30MHz

Marker	Frequency (MHz)	Meter Reading (dBuV)	Det	101837_L1_with extension	CABLELOSS(dB)	Corrected Reading (dB(uVolts))	CFR 47 FCC PART 15 Class B QP	Margin (dB)	CFR 47 FCC PART 15 Class B AV	Margin (dB)
1	.195	36.03	Pk	9.8	.2	46.03	63.82	-17.79	-	-
2	.198	22.62	Av	9.8	.2	32.62	-	-	53.69	-21.07
3	.246	32.38	Pk	9.5	.2	42.08	61.89	-19.81	-	-
4	.255	14.12	Av	9.5	.2	23.82	-	-	51.59	-27.77
5	.693	25.99	Pk	9.7	.2	35.89	56	-20.11	-	-
6	.69	17.87	Av	9.7	.2	27.77	-	-	46	-18.23
7	4.149	24.42	Pk	9.7	.3	34.42	56	-21.58	-	-
8	4.191	13.67	Av	9.7	.3	23.67	-	-	46	-22.33
9	17.442	27.61	Pk	10	.4	38.01	60	-21.99	-	-
10	17.391	14.61	Av	10	.4	25.01	-	-	50	-24.99
11	23.406	32.81	Pk	10.2	.4	43.41	60	-16.59	-	-
12	23.358	15.06	Av	10.2	.4	25.66	-	-	50	-24.34

Pk - Peak detector

Av - Average detection

Quasi-Peak Emissions

Range 1: Phase L1 .15 - 30MHz

Frequency (MHz)	Meter Reading (dBuV)	Det	101837_L1_with extension	CABLELOSS(dB)	Corrected Reading (dB(uVolts))	CFR 47 FCC PART 15 Class B QP	Margin (dB)	CFR 47 FCC PART 15 Class B AV	Margin (dB)
.19575	31.83	Qp	9.8	.2	41.83	63.79	-21.96	-	-
.19815	32.84	Qp	9.8	.2	42.84	63.69	-20.85	-	-
.24615	33.76	Qp	9.5	.2	43.46	61.89	-18.43	-	-
.25575	27.48	Qp	9.5	.2	37.18	61.57	-24.39	-	-
.69375	22.35	Qp	9.7	.2	32.25	56	-23.75	-	-
.69075	22.87	Qp	9.7	.2	32.77	56	-23.23	-	-
4.14975	18.88	Qp	9.7	.3	28.88	56	-27.12	-	-
4.19175	18.59	Qp	9.7	.3	28.59	56	-27.41	-	-
17.4422	22.39	Qp	10	.4	32.79	60	-27.21	-	-
17.3903	23.26	Qp	10	.4	33.66	60	-26.34	-	-
23.4062	26.47	Qp	10.2	.4	37.07	60	-22.93	-	-
23.3582	26.35	Qp	10.2	.4	36.95	60	-23.05	-	-

Qp - Quasi-Peak detector

LINE 2 PLOT

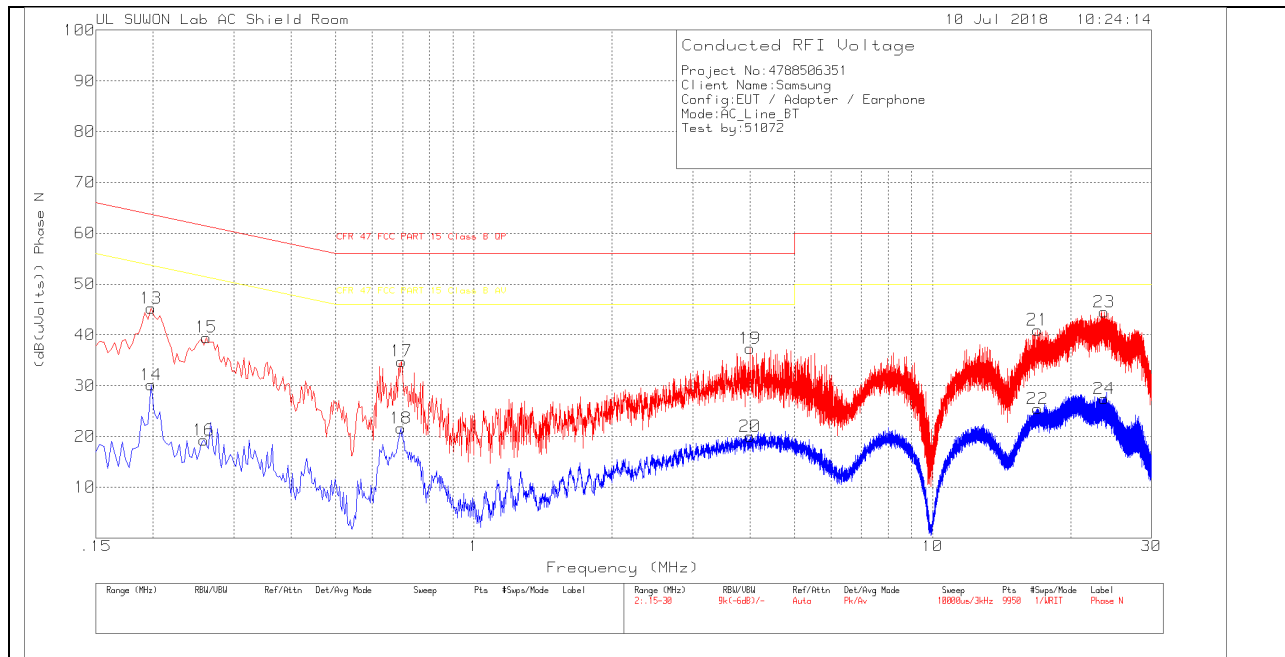

LINE 2 RESULTS

Trace Markers

Range 2: Phase N .15 - 30MHz

Marker	Frequency (MHz)	Meter Reading (dBuV)	Det	101837_N_with extension	CABLELOSS(dB)	Corrected Reading (dB(uVolts))	CFR 47 FCC PART 15 Class B QP	Margin (dB)	CFR 47 FCC PART 15 Class B AV	Margin (dB)
13	.198	35.09	Pk	9.9	.2	45.19	63.69	-18.5	-	-
14	.198	20.08	Av	9.9	.2	30.18	-	-	53.69	-23.51
15	.261	29.69	Pk	9.6	.2	39.49	61.4	-21.91	-	-
16	.258	9.41	Av	9.6	.2	19.21	-	-	51.5	-32.29
17	.696	24.79	Pk	9.8	.2	34.79	56	-21.21	-	-
18	.693	11.56	Av	9.8	.2	21.56	-	-	46	-24.44
19	3.999	27.18	Pk	9.8	.3	37.28	56	-18.72	-	-
20	3.999	9.92	Av	9.8	.3	20.02	-	-	46	-25.98
21	16.959	30.67	Pk	9.9	.4	40.97	60	-19.03	-	-
22	16.959	15.14	Av	9.9	.4	25.44	-	-	50	-24.56
23	23.673	33.95	Pk	10.2	.4	44.55	60	-15.45	-	-
24	23.685	16.86	Av	10.2	.4	27.46	-	-	50	-22.54

Pk - Peak detector

Av - Average detection

Quasi-Peak Emissions

Range 2: Phase N .15 - 30MHz

Frequency (MHz)	Meter Reading (dBuV)	Det	101837_N_with extension	CABLELOSS(dB)	Corrected Reading (dB(uVolts))	CFR 47 FCC PART 15 Class B QP	Margin (dB)	CFR 47 FCC PART 15 Class B AV	Margin (dB)
.19815	31.69	Qp	9.9	.2	41.79	63.69	-21.9	-	-
.26175	25.65	Qp	9.6	.2	35.45	61.38	-25.93	-	-
.25875	25.86	Qp	9.6	.2	35.66	61.47	-25.81	-	-
.69525	18.8	Qp	9.8	.2	28.8	56	-27.2	-	-
.69225	18.96	Qp	9.8	.2	28.96	56	-27.04	-	-
3.99915	17.87	Qp	9.8	.3	27.97	56	-28.03	-	-
16.9598	23.03	Qp	9.9	.4	33.33	60	-26.67	-	-
23.6732	27.39	Qp	10.2	.4	37.99	60	-22.01	-	-
23.6843	27.65	Qp	10.2	.4	38.25	60	-21.75	-	-

Qp - Quasi-Peak detector