



**FCC 47 CFR § 2.1093**

**RF EXPOSURE EVALUATION REPORT  
(Part 2: Test Under Dynamic Transmission Condition)**

**FOR**

**WCDMA/LTE/5G NR Tablet + BT/BLE, DTS/UNII a/b/g/n/ac**

**MODEL NUMBER: SM-T738U**

**FCC ID: A3LSMT738U**

**REPORT NUMBER: 4789867826-S1V4**

**ISSUE DATE: 6/22/2021**

*Prepared for*

**SAMSUNG ELECTRONICS CO., LTD.  
129 SAMSUNG-RO, YEONGTONG-GU, SUWON-SI,  
GYEONGGI-DO, 16677, KOREA**

*Prepared by*

**UL Korea, Ltd.**

**26th floor, 152, Teheran-ro, Gangnam-gu Seoul, 06236, Korea**

**Suwon Test Site: UL Korea, Ltd. Suwon Laboratory  
218 Maeyeong-ro, Yeongtong-gu,  
Suwon-si, Gyeonggi-do, 16675, Korea  
TEL: (031) 337-9902  
FAX: (031) 213-5433**



**Testing Laboratory**

**TL-637**

**Revision History**

Rev.	Date	Revisions	Revised By
V1	6/3/2021	Initial Issue	--
V2	6/4/2021	Added note in Section.10 Revised data in Section 8.2 & 8.2.1 to 8.2.6.	Sunghoon Kim
V3	6/11/2021	Revised NR Band n66's data in Section 5.1.	Sunghoon Kim
V4	6/22/2021	Revised NR Band n77's data in Section 6.3.6 & 6.4 & 6.7 & 7.3.6.	Sunghoon Kim

## Table of Contents

<b>Attestation of Test Results</b> .....	<b>6</b>
<b>1. Introduction</b> .....	<b>7</b>
<b>2. Tx Varying Transmission Test Cases and Test Proposal</b> .....	<b>8</b>
<b>3. SAR Time Averaging Validation Test Procedures</b> .....	<b>11</b>
3.1. <i>Test sequence determination for validation</i> .....	11
3.2. <i>Test configuration selection criteria for validation Smart Transmit feature</i> .....	11
3.2.1 <i>Test configuration selection for time-varying Tx power transmission</i> .....	11
3.2.2 <i>Test configuration selection for change in call</i> .....	12
3.2.3 <i>Test configuration selection for change in technology/band</i> .....	12
3.2.4 <i>Test configuration selection for change in antenna</i> .....	12
3.2.5 <i>Test configuration selection for change in DSI</i> .....	13
3.2.6 <i>Test configuration selection for change in time window</i> .....	13
3.2.7 <i>Test configuration selection for SAR exposure switching</i> .....	13
3.3. <i>Test procedures for conducted power measurements</i> .....	14
3.3.1 <i>Time-varying Tx power transmission scenario</i> .....	14
3.3.2 <i>Change in call scenario</i> .....	16
3.3.3 <i>Change in technology and band</i> .....	16
3.3.4 <i>Change in antenna</i> .....	17
3.3.5 <i>Change in DSI</i> .....	18
3.3.6 <i>Change in time window</i> .....	18
3.3.7 <i>SAR exposure switching</i> .....	20
3.4. <i>Test procedures for time-varying SAR measurements</i> .....	21
<b>4. PD Time Averaging Validation Test Procedures</b> .....	<b>22</b>
4.1. <i>Test sequence for validation in mmW NR transmission</i> .....	22
4.2. <i>Test configuration selection criteria for validating Smart Transmit feature</i> .....	22
4.2.1 <i>Test configuration selection for time-varying Tx power transmission</i> .....	22
4.2.2 <i>Test configuration selection for change in antenna configuration (beam)</i> .....	22
4.2.3 <i>Test configuration selection for SAR vs. PD exposure switch during transmission</i> .....	22
4.3. <i>Test procedures for mmW radiated power measurements</i> .....	22
4.3.1 <i>Time-varying Tx power scenario</i> .....	23
4.3.2 <i>Switch in SAR vs. PD exposure during transmission</i> .....	24
4.3.3 <i>Change in antenna configuration (beam)</i> .....	25
4.4. <i>Test procedures for time-varying PD measurements</i> .....	27
<b>5. Test Configurations</b> .....	<b>29</b>

5.1.	WWAN (sub-6) transmission.....	29
5.2.	LTE + mmW NR transmission.....	31
<b>6.</b>	<b>Conducted Power Test Results for Sub-6 Smart Transmit Feature Validation.....</b>	<b>32</b>
6.1.	Measurement setup.....	32
6.2.	$P_{limit}$ and $P_{max}$ measurement results.....	35
6.3.	Time-varying Tx power measurement results (test case 1 - 6 in Table 5-2).....	36
6.3.1	WCDMA Band II.....	37
6.3.2	WCDMA Band V.....	39
6.3.3	LTE Band 26.....	41
6.3.4	LTE Band 7.....	43
6.3.5	NR Band n5.....	45
6.3.6	NR Band n77.....	47
6.4.	Change in Call Test Results (test case 7 in Table 5-2).....	49
6.5.	Change in technology/band test results (test case 8 in Table 5-2).....	51
6.6.	Change in Time Window/Antenna test results (test case 9 in Table 5-2).....	53
6.7.	Change in DSI test results (test case 10 in Table 5-2).....	57
6.8.	Switch in SAR exposure test results (test case 11 in Table 5-2).....	59
<b>7.</b>	<b>SAR Test Results for Sub-6 Smart Transmit Feature Validation.....</b>	<b>61</b>
7.1.	Dielectric Property Measurements & System Check.....	61
7.1.1	Dielectric Property Measurements.....	61
7.1.2	SAR system check.....	62
7.2.	Measurement setup.....	62
7.3.	SAR measurement results for time-varying Tx power transmission scenario.....	63
7.3.1	WCDMA Band II.....	64
7.3.2	WCDMA Band V.....	65
7.3.3	LTE Band 26.....	66
7.3.4	LTE Band 7.....	67
7.3.5	NR Band n5.....	68
7.3.6	NR Band n77.....	69
<b>8.</b>	<b>Radiated Power Test Results for mmW Smart Transmit Feature Validation.....</b>	<b>70</b>
8.1.	Measurement setup.....	70
8.2.	mmW NR radiated power test results.....	71
8.2.1	Maximum Tx power test results for n261.....	73
8.2.2	Maximum Tx power test results for n260.....	75
8.2.3	Switch in SAR vs. PD exposure test results for n261.....	77
8.2.4	Switch in SAR vs. PD exposure test results for n260.....	79



8.2.5	<i>Change in Beam test results for n261</i> .....	81
8.2.6	<i>Change in Beam test results for n260</i> .....	83
<b>9.</b>	<b>PD Test Results for mmW Smart Transmit Feature Validation.</b> .....	<b>85</b>
9.1.	<i>Power density measurement system</i> .....	85
9.2.	<i>Power density probe</i> .....	85
9.3.	<i>Power density measurement system verification</i> .....	85
9.4.	<i>Measurement setup</i> .....	86
9.5.	<i>PD measurement results for maximum power transmission scenario</i> .....	87
9.2.1	<i>PD test results for n261</i> .....	88
9.2.2	<i>PD test results for n260</i> .....	89
<b>10.</b>	<b>Test Equipment</b> .....	<b>90</b>
<b>11.</b>	<b>Measurement Uncertainty</b> .....	<b>91</b>
11.1.	<i>SAR</i> .....	91
11.2.	<i>Power density</i> .....	91
<b>12.</b>	<b>Conclusions</b> .....	<b>92</b>
<b>Section A. Test Sequences</b> .....		<b>93</b>
<b>Section B. Test Procedures for sub6 NR + LTE Radio</b> .....		<b>95</b>
<b>Appendixes</b> .....		<b>97</b>
	<i>4789867826-S1 FCC Report RF exposure_App A_Test setup photos</i> .....	97
	<i>4789867826-S1 FCC Report RF exposure_App B_System Check plots</i> .....	97

### Attestation of Test Results

Applicant Name	SAMSUNG ELECTRONICS CO.,LTD.
FCC ID	A3LSMT738U
Model Number	SM-T738U
Applicable Standards	FCC 47 CFR § 2.1093
Date Tested	5/7/2021 to 6/3/2021
Test Results	Pass

UL Korea, Ltd. tested the above equipment in accordance with the requirements set forth in the above standards. All indications of Pass/Fail in this report are opinions expressed by UL Korea, Ltd. based on interpretations and/or observations of test results. Measurement Uncertainties were not taken into account and are published for informational purposes only. The test results show that the equipment tested is capable of demonstrating compliance with the requirements as documented in this report.

**Note:** The results documented in this report apply only to the tested sample, under the conditions and modes of operation as described herein. This document may not be altered or revised in any way unless done so by UL Korea, Ltd. and all revisions are duly noted in the revisions section. Any alteration of this document not carried out by UL Korea, Ltd. will constitute fraud and shall nullify the document. This report must not be used by the client to claim product certification, approval, or endorsement by IAS, any agency of the Federal Government, or any agency of any government.

Approved & Released By: 	Prepared By: 
Justin Park Operations Leader UL Korea, Ltd. Suwon Laboratory	Sunghoon Kim Test Engineer UL Korea, Ltd. Suwon Laboratory

## 1. Introduction

The equipment under test (EUT) is SM-T738U (FCC ID : A3LSMT738U), it contains the Qualcomm modems supporting 3G/4G technologies and 5G NR bands (Sub-6 and mmW). Both of these modems are enabled with Qualcomm Smart Transmit feature to control and manage transmitting power in real time and to ensure at all times the time-averaged RF exposure is in compliance with the FCC requirement.

This purpose of the Part 2 report is to demonstrate the EUT complies with FCC RF exposure requirement under Tx varying transmission scenarios, thereby validity of Qualcomm Smart Transmit feature for FCC equipment authorization of A3LSMT738U.

The  $P_{limit}$  (For 3G/4G and 5G NR Sub-6) and *input.power.limit* (For 5G NR mmW) used in this report is determined in Part 0 and Part 1 reports.

Refer to Compliance summary report for product description and terminology used in this report.

## 2. Tx Varying Transmission Test Cases and Test Proposal

To validate time averaging feature and demonstrate the compliance in Tx varying transmission conditions, the following transmission scenarios are covered in Part 2 test:

1. During a time-varying Tx power transmission: To prove that the Smart Transmit feature accounts for Tx power variations in time accurately.
2. During a call disconnected and re-establish scenario: To prove that the Smart Transmit feature accounts for history of past Tx power transmissions accurately.
3. During technology/band handover: To prove that the Smart Transmit feature functions correctly during transitions in technology/band.
4. During DSI (Device State Index) change: To prove that The Smart Transmit feature functions correctly during transition from one device state (DSI) to another.
5. During antenna (or beam) switch: To prove that the Smart Transmit feature functions correctly during transitions in antenna (Such as AsDiv scenario) or beams (different antenna array configurations).
6. SAR vs. PD exposure switching during sub-6 + mmW transmission: To prove that the Smart Transmit feature functions correctly and ensures total RF exposure compliance during transitions in SAR dominant exposure, SAR + PD exposure, and PD dominant exposure scenarios.
7. During time window switch: To prove that the Smart Transmit feature correctly handles the transition from one time window to another specified by FCC, and maintains the normalized time-averaged RF exposure to be less than normalized FCC limit of 1.0 at all times.
8. SAR exposure switching between two active radios (radio1 and radio2): To prove that the Smart Transmit feature functions correctly and ensures total RF exposure compliance when exposure varies among SAR\_radio1 only, SAR\_radio1 + SAR\_radio2, and SAR\_radio2 only scenarios. As described in Part 0 report, the RF exposure is proportional to the Tx power for a SAR- and PD-characterized wireless device. Thus, feature validation in Part 2 can be effectively performed through conducted (for  $f < 6\text{GHz}$ ) and radiated (for  $f \geq 6\text{GHz}$ ) power measurement. Therefore, the compliance demonstration under dynamic transmission conditions and feature validation are done in conducted/radiated power measurement setup for transmission scenario 1 through 8.

To add confidence in the feature validation, the time-averaged SAR and PD measurements are also performed but only performed for transmission scenario 1 to avoid the complexity in SAR and PD measurement (such as, for scenario 3 requiring change in SAR probe calibration file to accommodate different bands and/or tissue simulating liquid).

The strategy for testing in Tx varying transmission condition is outlined as follows:

- Demonstrate the total RF exposure averaged over FCC defined time windows does not exceed FCC's SAR and PD limits, through time-averaged power measurements.
  - Measure conducted Tx power (for  $< 6\text{GHz}$ ) versus time, and radiated Tx power (EIRP for  $f > 10\text{GHz}$ ) versus time.
  - Convert it into RF exposure and divide by respective FCC limits to get normalized exposure versus time.
  - Perform running time-averaging over FCC defined time windows.
  - Demonstrate that the total normalized time-averaged RF exposure is less than 1 for all transmission scenarios (i.e., transmission scenarios 1, 2, 3, 4, 5, 6, 7, and 8) at all times.



Mathematical expression:

- For sub-6 transmission only:

$$1g\_or\_10gSAR(t) = \frac{conducted\_Tx\_power(t)}{conducted\_Tx\_power\_P_{limit}} * 1g\_or\_10gSAR\_P_{limit} \quad (1a)$$

$$\frac{\frac{1}{T_{SAR}} \int_{t-T_{SAR}}^t 1g\_or\_10gSAR(t) dt}{FCC\ SAR\ limit} \leq 1 \quad (1b)$$

- For sub6 + mmW transmission:

$$1g\_or\_10gSAR(t) = \frac{conducted\_Tx\_power(t)}{conducted\_Tx\_power\_P_{limit}} * 1g\_or\_10gSAR\_P_{limit} \quad (2a)$$

$$4cm^2PD(t) = \frac{radiated\_Tx\_power(t)}{radiated\_Tx\_power\_input.power.limit} * 4cm^2PD\_input.power.limit \quad (2b)$$

$$\frac{\frac{1}{T_{SAR}} \int_{t-T_{SAR}}^t 1g\_or\_10gSAR(t) dt}{FCC\ SAR\ limit} + \frac{\frac{1}{T_{PD}} \int_{t-T_{PD}}^t 4cm^2PD(t) dt}{FCC\ 4cm^2\ PD\ limit} \leq 1 \quad (2c)$$

Where, *conducted\_Tx\_power(t)*, *conducted\_Tx\_power\_P<sub>limit</sub>*, and *1g\_or\_10gSAR\_P<sub>limit</sub>* correspond to the measured instantaneous conducted Tx power, measured conducted Tx power at *P<sub>limit</sub>*, and measured *1gSAR* or *10gSAR* values at *P<sub>limit</sub>* corresponding to sub-6 transmission. Similarly, *radiated\_Tx\_power(t)*, *radiated\_Tx\_power\_input.power.limit*, and *4cm<sup>2</sup>PD\_input.power.limit* correspond to the measured instantaneous radiated Tx power, radiated Tx power at *input.power.limit* (i.e., radiated power limit), and *4cm<sup>2</sup>PD* value at *input.power.limit* corresponding to mmW transmission. Both *P<sub>limit</sub>* and *input.power.limit* are the parameters pre-defined in Part 0 and loaded via Embedded File System (EFS) onto the EUT, *T<sub>SAR</sub>* is the FCC defined time window for sub-6 radio; *T<sub>PD</sub>* is the FCC defined time window for mmW radio.

- Demonstrate the total RF exposure averaged over FCC defined time windows does not exceed FCC's SAR and PD limits, through time-averaged SAR and PD measurements. Note as mentioned earlier, this measurement is performed for transmission scenario 1 only.
  - For sub-6 transmission only, measure instantaneous SAR versus time; for LTE+sub6 NR transmission, request low power (or all-down bits) on LTE so that measured SAR predominantly corresponds to sub6 NR.
  - For LTE + mmW transmission, measure instantaneous E-field versus time for mmW radio And instantaneous conducted power versus time for LTE radio.
  - Convert it into RF exposure and divide by respective FCC limits to obtain normalized exposure versus time.
  - Perform time averaging over FCC defined time window.
  - Demonstrate that the total normalized time-averaged RF exposure is less than 1 for transmission scenario 1 at all times.

Mathematical expression:

- For sub-6 transmission only:

$$1g\_or\_10gSAR(t) = \frac{pointSAR(t)}{pointSAR\_P_{limit}} * 1g\_or\_10gSAR(t)\_P_{limit} \quad (3a)$$

$$\frac{\frac{1}{T_{SAR}} \int_{t-T_{SAR}}^t 1g\_or\_10gSAR(t) dt}{FCC\ SAR\ limit} \leq 1 \quad (3b)$$

- For LTE + mmW transmission:

$$1g\_or\_10gSAR(t) = \frac{conducted\_Tx\_power(t)}{conducted\_Tx\_power\_P_{limit}} * 1g\_or\_10gSAR\_P_{limit} \quad (4a)$$

$$4cm^2PD(t) = \frac{[pointE(t)]^2}{[pointE\_input.power.limit]^2} * 4cm^2PD\_input.power.limit \quad (4b)$$

$$\frac{\frac{1}{T_{SAR}} \int_{t-T_{SAR}}^t 1g\_or\_10gSAR(t) dt}{FCC\ SAR\ limit} + \frac{\frac{1}{T_{PD}} \int_{t-T_{PD}}^t 4cm^2PD(t) dt}{FCC\ 4cm^2PD\ limit} \leq 1 \quad (4c)$$

Where,  $pointSAR(t)$ ,  $pointSAR\_P_{limit}$ , and  $1g\_or\_10gSAR\_P_{limit}$  correspond to the measured instantaneous point SAR, measured point SAR at  $P_{limit}$  and measured  $1gSAR$  or  $10gSAR$  values at  $P_{limit}$  corresponding to sub-6 transmission. Similarly,  $pointE(t)$ ,  $pointE\_input.power.limit$ , and  $4cm^2PD\_input.power.limit$  correspond to the measured instantaneous E-field, E-field at  $input.power.limit$ , and  $4cm^2PD$  value at  $input.power.limit$  corresponding to mmW transmission.

Note: cDASY6 measurement system by Schmid & Partner Engineering AG (SPEAG) of Zurich, Switzerland measures relative E-field, and provides ratio of  $[pointE(t)]^2 / [pointE\_input.power.limit]^2$  versus time.

### 3. SAR Time Averaging Validation Test Procedures

This chapter provides the test plan and test procedures for validating Qualcomm Smart Transmit feature for sub-6 transmission. The 100 seconds time window for operating  $f < 3\text{GHz}$  is used as an example to detail the test procedures in this chapter. The same test plan and test procedures described in this chapter apply to 60 seconds time window for operating  $f \geq 3\text{GHz}$ .

#### 3.1. Test sequence determination for validation

Following the FCC recommendation, two test sequences having time-variation in Tx power are predefined for sub-6 ( $f < 6\text{GHz}$ ) validation:

- Test sequence 1 : request EUT's Tx power to be at maximum power, measured  $P_{max}$ , for 80s, then requesting for half of the maximum power, i.e., measured  $P_{max}/2$ , for the rest of the time.
- Test sequence 2 : request EUT's Tx power to vary with time. This sequence is generated relative to measured  $P_{max}$ , measured  $P_{limit}$  and Calculated  $P_{reserve}$  (= measured  $P_{limit}$  in dBm – Reserve\_power\_margin in dB) of EUT based on measured  $P_{limit}$ .

The details for generating these two test sequences is described and listed in Section A.

Note: For test sequence generation, “measured  $P_{limit}$ ” and “measured  $P_{max}$ ” are used instead of the “ $P_{limit}$ ” specified in EFS entry and “ $P_{max}$ ” specified for the device, because Smart Transmit feature operates against the actual power level of the “ $P_{limit}$ ” that was calibrated for the EUT. The “measured  $P_{limit}$ ” accurately reflects what the feature is referencing to, therefore, it should be used during feature validation testing. The RF tune up and device-to-device variation are already considered in Part 0 report prior to determining  $P_{limit}$ .

#### 3.2. Test configuration selection criteria for validation Smart Transmit feature

For validating Smart Transmit feature, this section provides a general guidance to select test cases. In practice, an adjustment can be made in test case selection. The justification/clarification may be provide.

##### 3.2.1 Test configuration selection for time-varying Tx power transmission

The Smart Transmit time averaging feature operation is independent of bands, modes, and channels for a given technology. Hence, validation of Smart Transmit on one band/mode/channel per technology is sufficient. Two bands per technology are proposed and selected for this testing to provide high confidence in this validation.

The criteria for the selection are based on the  $P_{limit}$  values determined in Part 0 report. Select two bands\* in each supported technology that correspond to least\*\* and highest\*\*\*  $P_{limit}$  values that are less than  $P_{max}$  for validating Smart Transmit.

- \* If one  $P_{limit}$  level applies to all the bands within a technology, then only one band needs to be tested. In this case, within the bands having the same  $P_{limit}$ , the radio configuration (e.g., # of RBs, channel#) and device position that correspond to the highest measured 1gSAR at  $P_{limit}$  shown in Part 1 report is selected.
- \*\* In case of multiple bands having the same least  $P_{limit}$  within the technology, then select the band having the highest measured 1gSAR at  $P_{limit}$ .

- \*\*\* The band having a higher  $P_{limit}$  needs to be properly selected so that the power limiting enforced by Smart Transmit can be validated using the pre-defined test sequences. If the highest  $P_{limit}$  in a technology is too high where the power limiting enforcement is not needed when testing with the pre-defined test sequences, then the next highest level is checked. This process is continued within the technology until second band for validation test is determined.

### 3.2.2 Test configuration selection for change in call

The criteria to select a test configuration for call-drop measurement is:

- Select technology/band with least  $P_{limit}$  among all supported technologies/bands, and select the radio configuration (e.g., # of RBs, channel#) in this technology/band that corresponds to the highest *measured 1gSAR* at  $P_{limit}$  listed in Part 1 report.
- In case of multiple bands having same least  $P_{limit}$ , then select the band having the highest *measured 1gSAR* at  $P_{limit}$  in Part 1 report.

This test is performed with the EUT's Tx power requested to be at maximum power, the above band selection will result in Tx power enforcement (i.e., during the time when EUT is forced to have Tx power at  $P_{reserve}$ ) for longest duration in one FCC defined window. The call change (call drop/reestablish) is performed during the Tx power enforcement duration (i.e., during the time when EUT is forced to have Tx power at  $P_{reserve}$ ). One test is sufficient as the feature operation is independent of technology and band.

### 3.2.3 Test configuration selection for change in technology/band

The selection criteria for this measurement is, for a given antenna, to have EUT switch from a technology/band with lowest  $P_{limit}$  within the technology group (in case of multiple bands having the same  $P_{limit}$ , then select the band with highest *measured 1gSAR* at  $P_{limit}$ ) to a technology/band with highest  $P_{limit}$  within the technology group, in case of multiple bands having the same  $P_{limit}$ , then select the band with lowest *measured 1gSAR* at  $P_{limit}$  in Part 1 report, or vice versa.

This test is performed with the EUT's Tx power requested to be at maximum power, the technology/band switch is performed during Tx power enforcement duration (i.e., during the time when EUT is forced to have Tx power at  $P_{reserve}$ ).

### 3.2.4 Test configuration selection for change in antenna

The criteria to select a test configuration for antenna switch measurement is:

- Whenever possible and supported by the EUT, first antenna switch configuration within the same technology/band (i.e., same technology and band combination).
- Then, select any technology/band that supports multiple Tx antennas, and has the highest difference in  $P_{limit}$  among all supported antennas.
- In case of multiple bands having same difference in  $P_{limit}$  among supported antennas, then select the band having the highest *measured 1gSAR* at  $P_{limit}$  in Part 1 report.

This test is performed with the EUT's Tx power requested to be at maximum power in selected technology/band, and antenna change is conducted during Tx power enforcement duration (i.e., during the time when EUT is forced to have Tx power at  $P_{reserve}$ ).

### 3.2.5 Test configuration selection for change in DSI

The criteria to select a test configuration for DSI change test is:

- Select a technology/band having the  $P_{limit} < P_{max}$  within any technology and DSI group, and for same technology/band having a different  $P_{limit}$  in any other DSI group. Note that the selected DSI transition need to be supported by the device.

This test is performed with the EUT's Tx power requested to be at maximum power in selected technology/band, and DSI change is conducted during Tx power enforcement duration (i.e., during the time when EUT is forced to have Tx power at  $P_{reserve}$ ).

### 3.2.6 Test configuration selection for change in time window

FCC specifies different time window for time averaging based on operation frequency. The criteria to select a test configuration for validating Smart Transmit feature and demonstrating the compliance during the change in time window is:

- Select any technology/band that has operation frequency classified in a different time window defined by FCC (such as 100-seconds time window), and its corresponding  $P_{limit}$  is less than  $P_{max}$  if possible.
- Select the 2<sup>nd</sup> technology/band that has operation frequency classified in a different time window defined by FCC (such as 60-seconds time window), and its corresponding  $P_{limit}$  is less than  $P_{max}$  if possible.
- Note it is preferred both  $P_{limit}$  values of two selected technology/band less than corresponding  $P_{max}$ , but if not possible, at least one of technologies/bands has its  $P_{limit}$  less than  $P_{max}$ .

This test is performed with the EUT's Tx power requested to be at maximum power in selected technology/band. Test for one pair of time windows selected is sufficient as the feature operation is the same.

### 3.2.7 Test configuration selection for SAR exposure switching

If supported, the test configuration for SAR exposure switching should cover:

1. SAR exposure switch when two active radios are in the same time window
2. SAR exposure switch when two active radios are in different time windows. One test with two active radios in any two different time windows is sufficient as Smart Transmit operation is the same for RF exposure switch in any combination of two different time windows. For device supporting LTE + mmW NR, this test is covered in Section 8.5.3 and 8.5.4.

The Smart Transmit time averaging operation is independent of the source of SAR exposure (for example, LTE vs. Sub6 NR) and ensures total time-averaged RF exposure compliance. Hence, validation of Smart Transmit in any one simultaneous SAR transmission scenario (i.e., one combination for LTE + Sub6 NR transmission) is sufficient, where the SAR exposure varies among  $SAR_{radio1}$  only,  $SAR_{radio1} + SAR_{radio2}$ , and  $SAR_{radio2}$  only scenarios.

The criteria to select a test configuration for validating Smart Transmit feature during SAR exposure switching scenarios is:

- Select any two < 6GHz technologies/bands that the EUT supports simultaneous transmission (for example, LTE + Sub NR)
- Among all supported simultaneous transmission configurations, the selection order is
  1. Select one configuration where both  $P_{limit}$  of radio1 and radio2 is less than their corresponding  $P_{max}$ , preferably, with different  $P_{limits}$ . If this configuration is not available, then,
  2. Select one configuration that has  $P_{limit}$  less than its  $P_{max}$  for at least one radio. If this cannot be found, then.
  3. Select one configuration that has  $P_{limit}$  of radio1 and radio2 greater than  $P_{max}$  but with least  $(P_{limit} - P_{max})$  delta.

Test for one simultaneous transmission scenario is sufficient as the feature operation is the same.

### 3.3. Test procedures for conducted power measurements

This section provides general conducted power measurement procedures to perform compliance test under dynamic transmission scenarios described in Section 2. In practice, an adjustment can be made in these procedures. The justification/clarification may be provide.

#### 3.3.1 Time-varying Tx power transmission scenario

This test is performed with the two pre-defined test sequences described in Section 3.1 for all the technologies and bands selected in Section 3.2.1. The purpose of the test is to demonstrate the effectiveness of power limiting enforcement and that the time-averaged SAR (corresponding time averaged Tx power) does not exceed the FCC limit at all times (see Eq. (1a) and (1b)).

#### Test procedure:

1. Measure  $P_{max}$ , measure  $P_{limit}$  and calculate  $Reserve\_power\_margin$  (= measured  $P_{limit}$  in dBm –  $Reserve\_power\_margin$  in dB) and follow Section 3.1 to generate the test sequences for all the technologies and bands selected in Section 3.2.1. Both test sequence 1 and test sequency 2 are created based on measured  $P_{max}$  and measured  $P_{limit}$  of the EUT. Test condition to measure  $P_{max}$  and  $P_{limit}$  is:
  - Measure  $P_{max}$  with Smart Transmit disable and callbox set to request maximum power.
  - Measure  $P_{limit}$  with Smart Transmit enable and  $Reserve\_power\_margin$  set to 0 dB; callbox set to request maximum power.

2. Set *Rerve\_power\_margin* to actual (intended) value (3dB for this EUT based on Part 1 report) and reset power on EUT to enable Smart Transmit, establish radio link in desired radio configuration, with callbox requesting the EUT’s Tx power to be at pre-defined test sequence 1, measure and record Tx power versus time, and then convert the conducted Tx power into 1gSAR or 10gSAR value (see Eq. (1a)) using measured  $P_{limit}$  from above Step 1. Perform running time average to determine time-averaged power and 1gSAR or 10gSAR versus time as illustrated in Figure A-1 where using 100-secnods time window as an example.

Note: In Eq.(1a), instantaneous Tx power is converted into instantaneous 1gSAR or 10gSAR value by applying the measured worst-case 1gSAR or 10gSAR value at  $P_{limit}$  for the corresponding technology/band/antenna/DSI reported in Part 1 report.

Note: For an easier computation of the running time average, 0 dBm can be added at the beginning of the test sequences the length of the responding time window, for example, add 0 dBm for 100-seconds so the running time average can be directly performed starting with the first 100-seconds data using excel spreadsheet. This technique applies to all tests performed in this Part 2 report for easier time-averaged computation using excel spreadsheet.

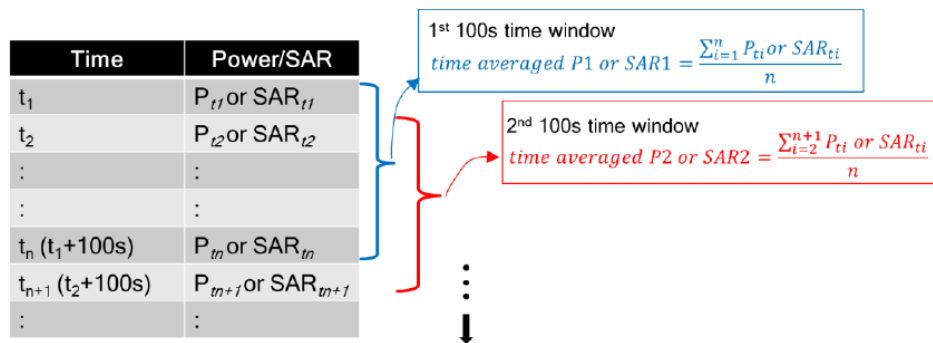

Figure A-1 100s running average illustration

3. Make one plot containing:
  - a. Instantaneous Tx power versus time measured in Step 2,
  - b. Requested Tx power used in Step 2 (Test sequence 1),
  - c. Computed time-averaged power versus time determined in Step 2,
  - d. Time-averaged power limit (corresponding to FCC SAR limit of 1.6 W/kg for 1gSAR or 4.0W/kg for 10gSAR) given by:

$$Time\ avearged\ power\ limit = meas.P_{limit} + 10 \times \log\left(\frac{FCC\ SAR\ limit}{meas.SAR\_P_{limit}}\right) \quad (5a)$$

Where  $meas.P_{limit}$  and  $meas.SAR\_P_{limit}$  correspond to measured power at  $P_{limit}$  and measured SAR at  $P_{limit}$ .

4. Make another plot containing:
  - a. Computed time-averaged 1gSAR or 10gSAR versus time determined in Step 2
  - b. FCC  $1gSAR_{limit}$  of 1.6W/kg or  $10gSAR_{limit}$  of 4.0W/kg.
5. Repeated Steps 2 ~ 4 for pre-defined test sequence 2 and replace the requested Tx power (test sequence 1) in Step 2 with test sequence 2.
6. Repeat Steps 2 ~ 5 for all the selected technologies and bands.  
 The validation criteria are, at all times, the time-averaged power versus time shown in Step 3 plot shall not exceed the time-averaged power limit (defined in Eq. (5a)), in turn, the time-averaged 1gSAR or 10gSAR versus time shown in Step 4 plot shall not exceed the FCC limit of 1.6 W/kg for 1gSAR or 4.0W/kg for 10gSAR (i.e., Eq. (1b)).

### 3.3.2 Change in call scenario

This test is to demonstrate that Smart Transmit feature accurately accounts for the past Tx powers during time-averaging when a new call is established.

The call disconnects and re-establishment needs to be performed during power limit enforcement, i.e., when the EUT's Tx power is at  $P_{reserve}$  level, to demonstrate the continuity of RF exposure management and limiting in call change scenario. In other words, the RF exposure averaged over any FCC defined time window (including the time windows containing the call change) doesn't exceed FCC limit of 1.6 W/kg for 1gSAR or 4.0W/kg for 10gSAR.

#### Test procedure:

1. Measure  $P_{limit}$  for the technology/band selected in Section 3.2.2. measure  $P_{limit}$  with Smart Transmit enable and *Reserve\_power\_margin* set to 0 dB; callbox set to request maximum power.
2. Set *Reserve\_power\_margin* to actual (intended) value and reset power on EUT to enable Smart Transmit.
3. Establish radio link with callbox in the selected technology/band.
4. Request EUT's Tx power at 0 dBm for at least one time window specified for the selected technology/band, followed by requesting EUT's Tx power to be at maximum power for about ~60 seconds, and then drop the call for ~10 seconds. Afterwards, re-establish another call in the same radio configuration (i.e., same technology/band/channel) and continue callbox requesting EUT's Tx power to be at maximum power for the remaining time of at least another full duration of the specified time window. Measure and record Tx power versus time, Once the measurement is done, extract instantaneous Tx power versus time, convert the measured conducted Tx power into 1gSAR or 10gSAR value using Eq.(1a), and then perform the running time average to determine time-averaged power and 1gSAR or 10gSAR versus time.  
Note: In Eq.(1a), instantaneous Tx power is converted into instantaneous 1gSAR or 10gSAR value by applying the measured worst-case 1gSAR or 10gSAR value at  $P_{limit}$  for the corresponding technology/band/antenna/DSI reported in Part 1 report.
5. Make one plot containing: (a) instantaneous Tx power versus time, (b) requested power, (c) computed time-averaged power, (d) time-averaged power limit calculated using Eq.(5a).
6. Make another plot containing: (a) computed time-averaged 1gSAR or 10gSAR versus time, and (b) FCC limit of 1.6 W/kg for 1gSAR or 4.0 W/kg for 10gSAR.

The validation criteria are, at all times, the time-averaged power versus time shall not exceed the time-averaged power limit (defined in Eq.(5a)), in turn, the time-averaged 1gSAR or 10gSAR versus time shall not exceed the FCC limit of 1.6W/kg for 1gSAR or 4.0W/kg for 10gSAR (i.e., Eq.(1b)).

### 3.3.3 Change in technology and band

This test is to demonstrate the correct power control by Smart Transmit during technology and/or band handovers.

Similar to the change in call test in Section 3.3.2, to validate the continuity of RF exposure limiting during the transition, the technology and band handover needs to be performed when EUT's Tx power is at  $P_{reserve}$  level (i.e., during Tx power enforcement) to make sure that the EUT's Tx power from previous  $P_{reserve}$  level to the new  $P_{reserve}$  level (corresponding to new technology/band). Since the  $P_{limit}$  could vary with technology and band, Eq.(1a) can be written as follows to convert the instantaneous Tx power in 1gSAR or 10gSAR exposure for the two given radios, respectively:



$$1g\_or\_10gSAR_1(t) = \frac{conducted\_Tx\_power\_1(t)}{conducted\_Tx\_power\_P_{limit\_1}} * 1g\_or\_10gSAR\_P_{limit\_1} \quad (6a)$$

$$1g\_or\_10gSAR_2(t) = \frac{conducted\_Tx\_power\_2(t)}{conducted\_Tx\_power\_P_{limit\_2}} * 1g\_or\_10gSAR\_P_{limit\_2} \quad (6b)$$

$$\frac{1}{T_{SAR}} \left[ \int_{t-T_{SAR}}^{t_1} \frac{1g\_or\_10gSAR_1(t)}{FCC\ SAR\ limit} dt + \int_{t-T_{SAR}}^t \frac{1g\_or\_10gSAR_2(t)}{FCC\ SAR\ limit} dt \right] \leq 1 \quad (6c)$$

where,  $conducted\_Tx\_power\_1(t)$ ,  $conducted\_Tx\_power\_P_{limit\_1}$ , and  $1g\_or\_10gSAR\_P_{limit\_1}$  correspond to the measured instantaneous conducted Tx power, measured conducted Tx power at  $P_{limit}$ , and measured  $1g$  SAR or  $10g$ SAR value at technology1/band1;  $conducted\_Tx\_power\_2(t)$ ,  $conducted\_Tx\_power\_P_{limit\_2}$ , and  $1g\_or\_10gSAR\_P_{limit\_2}$  correspond to the measured instantaneous conducted Tx power, measured conducted Tx power at  $P_{limit}$ , and measured  $1g$ SAR or  $10g$ SAR value at  $P_{limit}$  of technology2/band2. Transition from technology1/band1 to the technology2/band2 happens at time-instant 't<sub>1</sub>'.

### Test procedure:

1. Measure  $P_{limit}$  for both the technologies and bands selected in Section 3.2.3. Measure  $P_{limit}$  with Smart Transmit enabled and *Reserve\_power\_margin* set to 0 dB; callbox set to request maximum power.
2. Set *Reserve\_power\_margin* to actual(intended) value and reset power on EUT to enable Smart Transmit.
3. Establish radio link with callbox in first technology/band selected.
4. Request EUT's Tx power at 0 dBm for at least one time window specified for the selected technology/band, followed by requesting EUT's Tx power to be at maximum power for about ~60 second, and then switch to second technology/band selected. Continue with callbox requesting EUT's Tx power to be at maximum power for the remaining time of least another full duration of the specified time window. Measure and record Tx power versus time for the full duration of the test.
5. Once the measurement is done, extract instantaneous Tx power versus time, and convert the conducted Tx power into  $1g$ SAR or  $10g$ SAR value using Eq.(6a) and (6b) and corresponding measured  $P_{limit}$  values from Step 1 of this section. Perform the running time average to determine time-averaged power and  $1g$ SAR or  $10g$ SAR versus time.  
Note: In Eq.(6a) & (6b), instantaneous Tx power is converted into instantaneous  $1g$ SAR or  $10g$ SAR value by applying the measured the measured worst-case  $1g$ SAR or  $10g$ SAR value at  $P_{limit}$  for the corresponding technology/band/antenna/DSI reported in Part 1 report.
6. Make one plot containing: (a) instantaneous Tx power versus time, (b) requested power, (c) computed time-averaged power, (d) time-averaged power limit calculated using Eq.(5a).
7. Make another plot containing: (a) computed time-averaged  $1g$ SAR or  $10g$ SAR versus time, and (b) FCC limit of 1.6W/kg for  $1g$ SAR or 4.0 W/kg for  $10g$ SAR. (i.e., Eq.(6c)).

### 3.3.4 Change in antenna

This test is to demonstrate the correct power control by Smart Transmit during antenna switches from one antenna to another. The test procedure is identical to Section 3.3.3, by replacing technology/band switch operation with antenna switch. The validation criteria are, at all times, the time-average  $1g$ SAR or  $10g$ SAR versus time shall not exceed FCC limit of 1.6 W/kg for  $1g$ SAR or 4.0 W/kg for  $10g$ SAR.

Note: If the EUT does not support antenna switch within the same technology/band, but has multiple antennas to support different frequency bands, then the antenna switch test is included as part of change in technology and band (Section 3.3.3) test.

### 3.3.5 Change in DSI

This test is to demonstrate the correct power control by Smart Transmit during DSI switches from one DSI to another. The test procedure is identical to Section 3.3.3, by replacing technology/band switch operation with DSI switch. The validation criteria are, at all times, the time-averaged 1gSAR or 10gSAR versus time shall not exceed FCC limit of 1.6 W/kg for 1gSAR or 4.0W/kg for 10gSAR.

### 3.3.6 Change in time window

This test is to demonstrate the correct power control by Smart Transmit during the change in averaging time window when a specific band handover occurs. FCC specifies time-averaging window of 100s for Tx frequency < 3GHz, and 60s for Tx frequency between 3GHz and 6Ghz. To validate the continuity of RF exposure limiting during the transition, the band handover test needs to be performed when EUT handovers from operation band less than 3GHz to greater than 3GHz and vice versa. The equations (3a) and (3b) in Section 2 can be written as follows for transmission scenario having change in time window:

$$1gSAR_1(t) = \frac{\text{conducted\_Tx\_power\_1}(t)}{\text{conducted\_Tx\_power\_Plimit\_1}} * 1g\_or\ 10g\_SAR\_Plimit\_1 \quad (7a)$$

$$1gSAR_2(t) = \frac{\text{conducted\_Tx\_power\_2}(t)}{\text{conducted\_Tx\_power\_Plimit\_2}} * 1g\_or\ 10g\_SAR\_Plimit\_2 \quad (7b)$$

$$\frac{1}{T1_{SAR}} \left[ \int_{t-T1_{SAR}}^{t_1} \frac{1g\_or\ 10g\_SAR_1(t)}{FCC\ SAR\ limit} dt \right] + \frac{1}{T2_{SAR}} \left[ \int_{t-T2_{SAR}}^t \frac{1g\_or\ 10g\_SAR_2(t)}{FCC\ SAR\ limit} dt \right] \leq 1 \quad (7c)$$

Where, *conducted\_Tx\_power\_1(t)*, *conducted\_Tx\_power\_Plimit\_1(t)*, and *1g\_or 10g\_SAR\_Plimit\_1* correspond to the instantaneous Tx power, conducted Tx power at P<sub>limit</sub>, and compliance *1g\_or 10g\_SAR* values at P<sub>limit\_1</sub> of band1 with time-averaging window 'T<sub>1SAR</sub>'; *conducted\_Tx\_power\_2(t)*, *Conducted Tx power at P<sub>limit</sub>*, and compliance *1g\_or 10g\_SAR* values at P<sub>limit\_2</sub> of Band2 with time-averaging window 'T<sub>2SAR</sub>'. One of the two bands is less than 3GHz, another is greater than 3GHz. Transition from first band with time-averaging window 'T<sub>1SAR</sub>' to the second band with time-averaging window 'T<sub>2SAR</sub>' happens at time-instant 't<sub>1</sub>'.

#### Test procedure:

1. Measure P<sub>limit</sub> for both the technologies and bands selected in Section 3.2.6 Measure P<sub>limit</sub> with Smart Transmit enabled and *Reserve\_power\_margin* set to 0 dB, callbox set to request maximum power.
2. Set *Reserve\_power\_margin* to actual (intended) value and enable Smart Transmit.

#### Transition from 100s time window to 60s time window, and vice versa

3. Establish radio link with callbox in the technology/band having 100s time window selected in Section 3.2.6.
4. Request EUT's Tx power to be at 0 dBm for at least 100 seconds, followed by requesting EUT's Tx power to be at maximum power for about ~140 seconds, and then switch to second technology/band (having 60s time window) selected in Section 3.2.6. Continue with callbox requesting EUT's Tx power to be at maximum power for at least another 100s. Measure and record Tx power versus time for the entire duration of the test.

5. Once the measurement is done, extract instantaneous Tx power versus time, and convert the conducted Tx power into 1gSAR or 10gSAR value (see Eq.(7a) and (7b)) using corresponding technology/band Step 1 result, and then perform 100s average to determine time-averaged 1gSAR or 10gSAR versus time. Note that in Eq.(7a) & (7B), instantaneous Tx power is converted into instantaneous 1gSAR or 10gSAR value by applying the worst-case 1gSAR or 10gSAR value tested in Part 1 for the selected technologies/bands at  $P_{limit}$ .
6. Make one plot containing: (a) instantaneous Tx power versus time measured in Step 4.
7. Make another plot containing: (a) instantaneous 1gSAR versus time determined in Step 5, (b) computed time-averaged 1gSAR versus time determined in Step 5, and (c) corresponding regulatory  $1gSAR_{limit}$  of 1.6W/kg or  $10gSAR_{limit}$  of 4.0W/kg.

### **Transition from 60s time window to 100s time window, and vice versa**

8. Establish radio link with callbox in the technology/band having 60s time window selected in Section 3.2.6.
9. Request EUT's Tx power to be at 0 dBm for at least 60 seconds, followed by requesting EUT's Tx power to be at maximum power for about ~80 seconds, and then switch to second technology/band (having 100s time window) selected in Section 3.2.6. Continue with callbox requesting EUT's Tx power to be at maximum power for the remaining time for a total test time of 500 seconds. Measure and record Tx power versus time for the entire duration of the test.
10. Repeat above Step 5~7 to generate the plots

The validation criteria is, at all times, the time-averaged 1gSAR or 10gSAR versus time shall not exceed the regulatory  $1gSAR_{limit}$  of 1.6W/kg or  $10gSAR_{limit}$  of 4.0W/kg.

### 3.3.7 SAR exposure switching

This test is to demonstrate that Smart Transmit feature is accurately accounts for switching in exposures among SAR from radio1 only, SAR from both radio1 and radio2, and SAR from radio2 only scenarios, and ensures total time-averaged RF exposure complies with the FCC limit. Here, radio1 represents primary radio (for example, sub6 NR or mmW NR). The detailed test procedure for SAR exposure switching in the case of LTE + Sub6 NR non-standalone mode transmission scenario is provided in Section B.2.

#### Test procedure:

1. Measure conducted Tx power corresponding to  $P_{limit}$  for radio 1 and radio 2 in selected band. Test condition to measure conducted  $P_{limit}$  is:
  - Establish device in call with the callbox for radio1 technology/band. Measure conducted Tx power corresponding to radio 1  $P_{limit}$  with Smart Transmit enable and *Reserve\_Power\_margin* set to 0 dB, callbox set to request maximum power.
  - Repeat above step to measure conducted Tx power corresponding to radio2  $P_{limit}$ . If radio2 is dependent on radio1 (for example, non-standalone mode of Sub6 NR requiring radio1 LTE as anchor), then establish radio1 + radio2 call with callbox, and request all down bits for radio1 LTE. In this scenario, with callbox requesting maximum power from radio2 Sub6 NR, measured conducted Tx power corresponds to radio2  $P_{limit}$  (as radio1 LTE is at all-down bits)
2. Set *Reserve\_power\_margin* to actual (intended) value, with EUT setup for radio1 + radio2 call. In this description, it is assumed that radio2 has lower priority than radio1. Establish device in radio1 + radio2 call, and request all-down bits or low power on radio1, with callbox requesting EUT's Tx power to be at maximum power in radio2 for at least one time window. After one time window, set callbox to request EUT's Tx power to be at maximum power on radio1, i.e., all-up bits. Continue radio1 + radio2 call with both radios at maximum power for at least one time window, and drop (or request all-down bits on) radio2. Continue radio1 at maximum power for at least one time window. Record the conducted Tx power for both radio1 and radio2 for the entire duration of this test.
3. Once the measurement is done, extract instantaneous Tx power versus time for both radio1 and radio2 links. Convert the conducted Tx power for both these radios into 1gSAR or 10gSAR value (see Eq.(6a) and (6b)) using corresponding technology/band  $P_{limit}$  measured in Step 1, and then perform the running time average to determine time-averaged 1gSAR or 10gSAR versus time.
4. Make one plot containing: (a) instantaneous Tx power versus time measured in Step 2.
5. Make another plot containing: (a) instantaneous 1gSAR versus time determined in Step 3, (b) computed time-averaged 1gSAR versus time determined in Step 3, and (c) corresponding regulatory  $1gSAR_{limit}$  or 1.6W/kg or  $10gSAR_{limit}$  of 4.0W/kg.

The validation criteria is, at all times, the time-averaged 1gSAR or 10gSAR versus time shall not exceed the regulatory  $1gSAR_{limit}$  or 1.6W/kg or  $10gSAR_{limit}$  of 4.0W/kg.

### 3.4. Test procedures for time-varying SAR measurements

This section provides general time-varying SAR measurement procedures to perform compliance test under dynamic transmission scenarios described in Section 2. In practice, an adjustment can be made in these procedures. The justification/clarification may be provided.

To perform the validation through SAR measurement for transmission scenario 1 described in Section 2, the “path loss” between callbox antenna and EUT needs to be calibrated to ensure that the EUT Tx power reacts to the requested power from callbox in a radiated call. It should be noted that when signaling in closed loop mode, protocol-level power control is in play, resulting in EUT not solely following callbox TPC (Tx power control) commands. In other words, EUT response has many dependencies (RSSI, quality of signal, path loss variation, fading, etc.,) other than just TPC commands. These dependencies have less impact in conducted setup (as it is a controlled environment and the path loss can be very well calibrated) but have significant impact on radiated testing in an uncontrolled environment, such as SAR test setup. Therefore, the deviation in EUT Tx power from callbox requested power is expected, however the time-averaged SAR should not exceed FCC SAR requirement at all times as Smart Transmit controls Tx power at EUT.

The following steps are for time averaging feature validation through SAR measurement:

1. “Path Loss” calibration: Place the EUT against the phantom in the worst-case position determined based on Section 3.2.1. For each band selected, prior to SAR measurement, perform “path loss” calibration between callbox antenna and EUT. Since the SAR test environment is not controlled and well calibrated for OTA (Over the Air) test, extreme care needs to be taken to avoid the influence from reflections. The test setup is described in Section 7.1.
2. Time averaging feature validation:
  - i. For a given radio configuration (technology/band) selected in Section 3.2.1, enable Smart Transmit and set *Reserve\_power\_margin* to 0 dB, with callbox to request maximum power, perform area scan, conduct point SAR measurement at peak location of the area scan. This point SAR value, *pointSAR<sub>P<sub>limit</sub></sub>*, corresponds to point SAR at the measured *P<sub>limit</sub>* (i.e., measured *P<sub>limit</sub>* from the EUT in Step 1 of Section 3.3.1).
  - ii. Set *Reserve\_power\_margin* to actual (intended) value and reset power on EUT to enable Smart Transmit. Note, if *Reserve\_power\_margin* cannot be set wirelessly, care must be taken to re-position the EUT in the exact same position relative to the SAM phantom as in above Step 2.i. Establish radio link in desired radio configuration, with callbox requesting the EUT’s Tx power at power levels described by test sequence 1 generated in Step 1 of Section 3.3.1, conducted point SAR measurement versus time at peak location is done, extract instantaneous point SAR vs time data, *pointSAR(t)*, and convert it into instantaneous 1gSAR or 10gSAR vs. time using Eq. (3a), re-written below:

$$1g\_or\_10gSAR(t) = \frac{pointSAR(t)}{pointSAR_{P_{limit}}} * 1g\_or\_10gSAR_{P_{limit}}$$

Where, *pointSAR<sub>P<sub>limit</sub></sub>* is the value determined in Step 2.i, and *pointSAR(t)* is the instantaneous point SAR measured in Step 2.ii, *1g\_or\_10g\_SAR<sub>P<sub>limit</sub></sub>* is the measured 1gSAR or 10gSAR value listed in Part 1 report.

- iii. Perform 100s running average to determine time-averaged 1gSAR or 10gSAR versus time.
- iv. Make one plot containing: (a) time-average 1gSAR or 10gSAR versus time determined in Step 2.iii of this section, (b) FCC limit of 1.6 W/kg for 1gSAR or 4.0 W/kg for 10gSAR.
- v. Repeat 2.ii ~ 2.iv for test sequence 2 generated in Step 1 of Section 3.3.1.
- vi. Repeat 2.i ~ 2.v for all the technologies and bands selected in Section 3.2.1.

The time-averaging validation criteria for SAR measurement is that, at all times, the time-averaged 1gSAR or 10gSAR versus time shall not exceed FCC limit of 1.6 W/kg for 1gSAR or 4.0 W/kg for 10gSAR (i.e., Eq.(3b)).

## 4. PD Time Averaging Validation Test Procedures

This chapter provides the test plan and test procedures for validating Qualcomm Smart Transmit feature for mmW transmission, For this EUT, millimeter wave (mmW) transmission is only in non-standalone mode, i.e., it requires an LTE link as anchor.

### 4.1. Test sequence for validation in mmW NR transmission

In 5G mmW NR transmission, the test sequence for validation is with the callbox requesting EUT's Tx power in 5G mmW NR at maximum power all the time.

### 4.2. Test configuration selection criteria for validating Smart Transmit feature

#### 4.2.1 Test configuration selection for time-varying Tx power transmission

The Smart Transmit time averaging feature operation is independent of bands, modes, channels, and antenna configurations (beams) for a given technology. Hence, validation of Smart Transmit in any one band/mode/channel per technology is sufficient.

#### 4.2.2 Test configuration selection for change in antenna configuration (beam)

The Smart Transmit time averaging feature operation is independent of bands, modes, channels, and antenna configurations (beams) for a given technology. Hence, validation of Smart Transmit with beam switch between any two beams is sufficient.

#### 4.2.3 Test configuration selection for SAR vs. PD exposure switch during transmission

The Smart Transmit time averaging feature operation is independent of the nature of exposure (SAR vs. PD) and ensures total time-average RF exposure compliance. Hence, validation of Smart Transmit in any one band/mode/channel/beam for mmW + sub-6 (LTE) transmission is sufficient, where the exposure varies among SAR dominant scenario, SAR + PD scenario, and PD dominant scenario.

### 4.3. Test procedures for mmW radiated power measurements

Perform conducted power measurement (for  $f < 6\text{GHz}$ ) and radiated power measurement (for  $f > 6\text{GHz}$ ) for LTE + mmW transmission to validate Smart Transmit time averaging feature in the various transmission scenarios described in Section 2.

This section provides general conducted power measurement procedures to perform compliance test under dynamic transmission scenarios described in Section 2. In practice, an adjustment can be made in these procedures. The justification/clarification may be provided.

### 4.3.1 Time-varying Tx power scenario

The purpose of the test is to demonstrate the effectiveness of power limiting enforcement and that the time-averaged Tx power when converted into RF exposure values does not exceed the FCC limit at all times (see Eq. (2a), (2b) & (2c) in Section 2).

#### Test procedure:

1. Measure conducted Tx power corresponding to  $P_{limit}$  for LTE in selected band, and measure radiated Tx power corresponding to *input.power.limit* in desired mmW band/channel/beam by following below steps:
  - a. Measure radiated power corresponding to mmW *input.power.limit* by setting up the EUT's Tx power in desired band/channel/beam at *input.power.limit* in Factory Test Mode (FTM). This test is performed in calibrated anechoic chamber. Rotate the EUT to obtain maximum radiated Tx power, keep the EUT in this position and do not disturb the position of the EUT inside the anechoic chamber for the rest of this test.
  - b. Reset EUT to place in online mode and establish radio link in LTE, measure conducted Tx power corresponding to LTE  $P_{limit}$  with Smart Transmit enabled and *Reserve\_power\_margin* set to 0 dB, callbox set to request maximum power.
2. Set *Reserve\_power\_margin* to actual (intended) value and reset power on EUT to enable Smart Transmit. With EUT setup for a mmW NR call in the desire/selected LTE band and mmW NR band, perform the following steps:
  - a. Establish LTE and mmW NR connection in desired band/channel/beam used in Step 1. As soon as the mmW connection is established, immediately request all-down bits on LTE link. With callbox requesting EUT's Tx power to be at maximum mmW power to test predominantly PD exposure scenario (as SAR exposure is less when LTE's Tx power is at low power).
  - b. After 120s, request LTE to go all-upbits for at least 100s. SAR exposure is dominant. There are two scenarios:
    - i. If  $P_{limit} < P_{max}$  for LTE, then the RF exposure margin (provided to mmW NR) gradually runs out (due to high SAR exposure). This results in gradual reduction in the 5G mmW NR transmission power and eventually seized 5G mmW NR transmission when LTE goes to  $P_{reserve}$  level.
    - ii. If  $P_{limit} \geq P_{max}$  for LTE, then the 5G mmW NR transmission's averaged power should gradually reduce but the mmW NR connection can sustain all the time (assuming TxAGC uncertainty = 0 dB).
  - c. Record the conducted Tx power of LTE and radiated Tx power of mmW for the full duration of this test of least 300s.
3. Once the measurement is done, extract instantaneous Tx power versus time for both LTE and mmW links. Convert the conducted Tx power for LTE into 1gSAR or 10gSAR value using Eq.(2a) and  $P_{limit}$  measured in Step 1.b, and then divide by FCC limit of 1.6W/kg for 1gSAR or 4.0W/kg for 10gSAR to obtain instantaneous normalized 1gSAR or 10gSAR versus time. Perform 100s running average to determine normalized 100s-averaged 1gSAR or 10gSAR versus time.
 

Note: In Eq.(2a), instantaneous Tx power is converted into instantaneous 1gSAR or 10gSAR Value by applying the measured worst-case 1gSAR or 10gSAR value at  $P_{limit}$  for the corresponding technology/band/antenna/DSI reported in Part 1 report.



4. Similarly, convert the radiated Tx power for mmW into 4cm<sup>2</sup>PD value using Eq.(2b) and the radiated Tx power limit (i.e., radiated Tx power at *input.power.limit*) measured in Step 1.a, then divide by FCC 4cm<sup>2</sup>PD limit of 10W/m<sup>2</sup> to obtain instantaneous normalized 4cm<sup>2</sup>PD versus time. Perform 4s running average to determine normalized 4s-averaged 4cm<sup>2</sup>PD versus time. Note: In Eq.(2b), instantaneous radiated Tx power is converted into instantaneous 4cm<sup>2</sup>PD by applying the worst-case 4cm<sup>2</sup>PD value measured at *input.power.limit* for the selected band/beam in Part 1 report.
5. Make one plot containing: (a) instantaneous conducted Tx power for LTE versus time, (b) computed 100s-averaged conducted Tx power for LTE versus time, (c) instantaneous radiated Tx power for mmW versus time, as measured in Step 2, (d) computed 4s-averaged radiated Tx power for mmW versus time, and (e) time-averaged conducted and radiated power limits for LTE and mmW radio using Eq.(5a) & (5b), respectively:

$$\text{Time averaged LTE power limit} = \text{meas. } P_{\text{limit}} + 10 \times \log\left(\frac{\text{FCC SAR limit}}{\text{meas.SAR\_Plimit}}\right) \quad (5a)$$

$$\text{Time averaged mmW NR power limit} = \text{meas. EIRP}_{\text{input.power.limit}} + 10 \times \log\left(\frac{\text{FCC PD limit}}{\text{meas.PD\_input.power.limit}}\right) \quad (5b)$$

Where *meas.EIRP<sub>input.power.limit</sub>* and *meas.PD\_input.power.limit* correspond to measured EIRP at *input.power.limit* and measured power density at *input.power.limit*.

6. Make another plot containing: (a) computed normalized 100s-averaged 1gSAR or 10gSAR versus time determined in Step 3, (b) computed normalized 4s-averaged 4cm<sup>2</sup>PD versus time determined in Step 4, and (c) corresponding total normalized time-averaged RF exposure (sum of steps (6.a) and (6.b)) versus time.

The validation criteria are, at all times, the total normalized time-averaged RF exposure versus time determined in Step 6.c shall not exceed the normalized limit of 1.0 of FCC requirement (i.e., Eq. (2c)).

### 4.3.2 Switch in SAR vs. PD exposure during transmission

This test is to demonstrate that Smart Transmit feature is independent of the nature of exposure (SAR vs. PD), accurately accounts for switching in exposures among SAR dominant, SAR + PD, and PD dominant scenarios, and ensures total time-averaged RF exposure compliance.

#### Test procedure:

1. Measure conducted Tx power corresponding to  $P_{\text{limit}}$  for LTE in selected band, and measure radiated Tx power corresponding to *input.power.limit* in desired mmW band/channel/beam by following below steps:
  - a. Measure radiated power corresponding to *input.power.limit* by setting up the EUT's Tx power in desired band/channel/beam at *input.power.limit* in FTM. This test is performed in a calibrated anechoic chamber. Rotate the EUT to obtain maximum radiate Tx power, keep the EUT in this position and do not disturb the position of the EUT inside the anechoic chamber for the rest of this test.
  - b. Reset EUT to place in online mode and establish radio link in LTE, measure conducted Tx power corresponding to LTE  $P_{\text{limit}}$  with Smart Transmit enabled and *Reserve\_power\_margin* set to 0 dB, callbox set to request maximum power.



2. Set *Reserver\_power\_margin* to actual (intended) value and reset power in EUT, with EUT setup for LTE + mmW call, perform the following steps:
  - a. Establish LTE (sub-6) and mmW NR connection with callbox.
  - b. As soon as the mmW connection is established, immediately request all-down bits on LTE link. Continue LTE (all-down bits) + mmW transmission for more than 100s duration to test predominantly PD exposure scenario (as SAR exposure is negligible from all-down bits in LTE).
  - c. After 120s, request LTE to go all-up bits, mmW transmission should gradually run out of RF exposure margin if LTE's  $P_{limit} < P_{max}$  and seize mmW transmission (SAR only scenario); or mmW transmission should gradually reduce in Tx power and will sustain the connection if LTE's  $P_{limit} > P_{max}$ .
  - d. After 75s, request LTE to go all-down bits, mmW transmission should start getting back RF exposure margin and resume transmission again.
  - e. Record the conducted Tx power of LTE and radiated Tx power of mmW for the entire duration of this test of at least 300s.
3. Once the measurement is done, extract instantaneous Tx power versus time for both LTE and mmW links. Convert the conducted Tx power for LTE into 1gSAR or 10gSAR value using Eq.(2a) and  $P_{limit}$  measured in Step 1.b, and then divide by FCC limit of 1.6 W/kg for 1gSAR or 4.0 W/kg for 10gSAR to obtain instantaneous normalized 1gSAR or 10gSAR versus time. Perform 100s running average to determine normalized 100s-averaged 1gSAR or 10gSAR versus time. Note: In Eq.(2a), instantaneous Tx power is converted into instantaneous 1gSAR or 10gSAR value by applying the measured worst-case 1gSAR or 10gSAR value at  $P_{limit}$  for the corresponding technology/band/antenna/DSI reported in Part 1 report.
4. Similarly, convert the radiated Tx power for mmW into 4cm<sup>2</sup>PD value using Eq.(2b) and the radiated Tx power limit (i.e., radiated Tx power at *input.power.limit*) measured in Step 1.a, then divide this by FCC 4cm<sup>2</sup>PD limit of 10W/m<sup>2</sup> to obtain instantaneous normalized 4cm<sup>2</sup>PD versus time. Perform 4s running average to determine normalized 4s-averaged 4cm<sup>2</sup>PD versus time.
5. Make one plot containing: (a) instantaneous conducted Tx power for LTE versus time, (b) computed 100s-averaged conducted Tx power for LTE versus time, (c) instantaneous radiated Tx power for mmW versus time, as measured in Step 2, (d) compute 4s-averaged radiated Tx power for mmW versus time, and (e) time-averaged conducted and radiated power limits for LTE and mmW radio using Eq. (5a) & (5b), respectively.
6. Make another plot containing: (a) computed normalized 100s-averaged 1gSAR or 10gSAR versus time determined in Step 3, (b) computed normalized 4s-averaged 4cm<sup>2</sup>PD versus time determined in Step 4, and (C) corresponding total normalized time-averaged RF exposure (sum of steps (6.a) and (6.b)) versus time.

The validation criteria are, at all times, the total normalized time-averaged RF exposure versus time determined in Step 6.c shall not exceed the normalized limit of 1.0 of FCC requirement (i.e., Eq. (2c)).

### 4.3.3 Change in antenna configuration (beam)

This test is to demonstrate the correct power control by Smart Transmit during changes in antenna configuration (beam). Since the *input.power.limit* varies with beam, the Eq. (2a), (2b) and (2c) in Section 2 are written as below for transmission scenario having change in beam:

$$1g\_or\_10gSAR(t) = \frac{conducted\_Tx\_power(t)}{conducted\_Tx\_power\_P_{limit}} * 1g\_or\_10gSAR\_P_{limit} \quad (8a)$$

$$4cm^2PD_1(t) = \frac{radiated\_Tx\_power\_1(t)}{radiated\_Tx\_power\_input.power.limit\_1} * 4cm^2PD\_input.power.limit\_1 \quad (8b)$$

$$4cm^2PD_2(t) = \frac{radiated\_Tx\_power\_2(t)}{radiated\_Tx\_power\_input.power.limit\_2} * 4cm^2PD\_input.power.limit\_2 \quad (8c)$$

$$\frac{\frac{1}{T_{SAR}} \int_{t-T_{SAR}}^t 1g\_or\_10gSAR(t)dt}{FCC\ SAR\ limit} + \frac{\frac{1}{T_{PD}} \left[ \int_{t-T_{PD}}^{t_1} 4cm^2PD_1(t)dt + \int_{t_1}^t 4cm^2PD_2(t)dt \right]}{FCC4cm^2\ PD\ limit} \leq 1 \quad (8d)$$

Where, *conducted\_Tx\_power(t)*, *conducted\_Tx\_power\_Plimit*, and *1g\_or\_10gSAR\_Plimit* correspond to the measured instantaneous conducted Tx power, measured conducted Tx power at *P<sub>limit</sub>*, and measured *1gSAR* or *10gSAR* values at *P<sub>limit</sub>* corresponding to LTE transmission. Similarly, *radiated\_Tx\_power\_1(t)*, *radiated\_Tx\_power\_input.power.limit\_1*, and *4cm<sup>2</sup>PD\_input.power.limit\_1* correspond to the measured instantaneous radiated Tx power, radiated Tx power at *input.power.limit*, and *4cm<sup>2</sup>PD* value at *input.power.limit* of beam 1; *radiated\_Tx\_power\_2(t)*, *radiated\_Tx\_power\_input.power.limit\_2*, and *4cm<sup>2</sup>PD\_input.power.limit\_2* correspond to the measured instantaneous radiated Tx power, radiated Tx power at *input.power.limit*, and *4cm<sup>2</sup>PD* value at *input.power.limit* of beam 2 corresponding to mmW transmission.

### Test procedure:

1. Measure conducted Tx power corresponding to *P<sub>limit</sub>* for LTE in selected band, and measure radiated Tx power corresponding to *input.power.limit* in desired mmW band/channel/beam by following below steps:
  - a. Measure radiated power corresponding to mmW *input.power.limit* by setting up the EUT's Tx power of the EUT inside the anechoic chamber for the rest of this test. Repeat this Step 1.a for beam 2.
  - b. Reset EUT to place in online mode and establish radio link in LTE, measure conducted Tx power corresponding to LTE *P<sub>limit</sub>* with Smart Transmit enable and *Reserve\_power\_margin* set to 0 dB, callbox set to request maximum power.
2. Set *Reserve\_power\_margin* to actual (intended) value and reset power in EUT, With EUT setup for LTE + mmW connection, perform the following steps:
  - a. Establish LTE (sub-6) and mmW NR connection in beam 1. As soon as the mmW connection is established, immediately request all-down bits on LTE link with the callbox requesting EUT's Tx power to be at maximum mmW power.
  - b. After beam 1 continues transmission for at least 20s, request the EUT to change from beam 1 to beam 2, and continue transmitting with beam 2 for at least 20s.
  - c. Record the conducted Tx power of LTE and radiated Tx power of mmW for the entire duration of this test.
3. Once the measurement is done, extract instantaneous Tx power versus time for both LTE and mmW links. Convert the conducted Tx power for LTE into 1gSAR or 10gSAR value using the similar approach described in Step 3 of Section 4.3.2. Perform 100s running average to determine normalized 100s-averaged 1gSAR or 10gSAR versus time.
4. Similarly, convert the radiated Tx power for mmW NR into 4cm<sup>2</sup>PD value using Eq.(8b), (8c) and the radiated Tx power limits (i.e., radiated Tx power at *input.power.limit*) measured in Step 1.a for beam 1 and beam 2, respectively, and then divide the resulted PD values by FCC 4cm<sup>2</sup>PD limit of 10W/m<sup>2</sup> to obtain instantaneous normalized 4cm<sup>2</sup>PD versus time for beam 1 and beam 2. Perform 4s running average to determine normalized 4s-averaged 4cm<sup>2</sup>PD versus time.  
 Note: In Eq.(8b) and (8c), instantaneous radiated Tx power of beam 1 and beam 2 is converted into instantaneous 4cm<sup>2</sup>PD by applying the worst-case 4cm<sup>2</sup>PD value measured at the *input.power.limit* of beam 1 and beam 2 in Part 1 report, respectively.

5. Since the measured radiated powers for beam 1 and beam 2 in Step 1.a were performed at an arbitrary rotation of EUT in anechoic chamber, repeat Step 1.a of this procedure by rotating the EUT to determine maximum radiated power at *input.power.limit* in FTM mode for both beams separately. Re-scale the measured instantaneous radiated power in Step 2.c by the delta in radiated power measured in Step 5 and the radiated power measured in Step 1.a for plotting purpose in next Step. In other words, this step essentially converts measured instantaneous radiated power during the measurement in Step 2 into maximum instantaneous radiated power for both beams. Perform 4s running average to compute 4s-averaged radiated Tx power. Additionally, use these EIRP values measured at *input.power.limit* at respective peak locations to determine the EIRP limits (using Eq. (5b)) for both these beams.
6. Make one plot containing: (a) instantaneous conducted Tx power for LTE versus time, (b) computed 100s-averaged conducted Tx power for LTE versus time, (c) instantaneous radiated Tx power for mmW versus time, as obtained in Step 5, (d) computed 4s-averaged radiated Tx power for mmW versus time, as obtained in Step 5, and (e) time-averaged conducted and radiated power limits for LTE and mmW radio, respectively.
7. Make another plot containing: (a) computed normalized 100s-averaged 1gSAR or 10gSAR versus time determined in Step 3, (b) computed normalized 4s-averaged 4cm<sup>2</sup>PD versus time determined in Step 4, and (c) corresponding total normalized time-averaged RF exposure (sum of steps (6.a) and (6.b)) versus time.

The validation criteria are, at all times, the total normalized time-averaged RF exposure versus time determined in Step 6.c shall not exceed the normalized limit of 1.0 of FCC requirement (i.e., (8d)).

#### 4.4. Test procedures for time-varying PD measurements

The following steps are used to perform the validation through PD measurement for transmission scenario 1 described in Section 2:

1. Place the EUT on the cDASY6 platform to perform PD measurement in the worst-case position/surface for the selected mmW band/beam. In PD measurement, the callbox is set to request maximum Tx power from EUT all the time. Hence, "path loss" calibration between callbox antenna and EUT is not needed in this test.
2. Time averaging feature validation:
  - a. Measure conducted Tx power corresponding to  $P_{limit}$  for LTE in selected band, and measure point E-field corresponding to *input.power.limit* in desired mmW band/channel/beam by following the below steps:
    - i. Measure conducted Tx power corresponding to LTE  $P_{limit}$  with Smart Transmit enabled and *Reserve\_power\_margin* set to 0 dB, with callbox set to request maximum power.
    - ii. Measure point E-field at peak location of fast area scan corresponding to *input.power.limit* by setting up the EUT's Tx power in desired mmW band/channel/beam at *input.power.limit* in FTM. Do not disturb the position of EUT and mmW cDASY6 probe.
  - b. Set *Reserve\_power\_margin* to actual value (i.e., intended value) and reset power on EUT, place EUT in online mode. With EUT setup for LTE (sub-6) + mmW NR call, as soon as the mmW NR connection is established, request all-down bits on LTE link. Continue LTE (all-down bits) + mmW transmission for more than 100s duration to test predominantly PD exposure scenario. After 120s, request LTE to go all-up bits, mmW transmission should gradually reduce. Simultaneously, record the conducted Tx power of LTE transmission using power meter and point E-field (in terms of ratio of  $\frac{[pointE(t)]^2}{[pointE_{input.power.limit}]^2}$ ) of mmW transmission using cDASY6 E-field probe at peak location identified in Step 2.a.ii for the entire duration of this test of at least 300s.

- c. Once the measurement is done, extract instantaneous conducted Tx power versus time for LTE transmission and  $\frac{[pointE(t)]^2}{[pointE\_input.power.limit]^2}$  ratio versus time from cDASY6 system for mmW transmission. Convert the conducted Tx power for LTE into 1gSAR or 10gSAR value using Eq.(4a) and  $P_{limit}$  measured in Step 2.a.i, and then divide this by FCC limit of 1.6 W/kg for 1gSAR or 4.0 W/kg for 10gSAR to obtain instantaneous normalized 100s-averaged 1gSAR or 10gSAR versus time
- Note: In Eq.(4a), instantaneous Tx power is converted into instantaneous 1gSAR or 10gSAR value by applying the measured worst-case 1gSAR or 10gSAR value at  $P_{limit}$  for the corresponding technology/band reported in Part 1 report.
- d. Similarly, convert the point E-field for mmW transmission into  $4cm^2PD$  value using Eq.(4b) and radiated power limit measured in Step 2.a.ii, and then divide this by FCC  $4cm^2PD$  limit of  $10W/m^2$  to obtain instantaneous normalized  $4cm^2PD$  versus time, Perform 4s running average to determine normalized 4s-averaged  $4cm^2PD$  versus time.
- e. Make one plot containing in Step 2.c, (ii) computed normalized 100s-averaged 1gSAR or 10gSAR versus time determined in Step 2.c, (ii) computed normalized 4s-averaged  $4cm^2PD$  versus time determined in Step 2.d, and (iii) corresponding total normalized time-averaged RF exposure (sum of steps (2.e.i) and (2.e.ii)) versus time.

The validation criteria are, at all times, the total normalized time-averaged RF exposure versus time determined in Step 2.e.iii shall not exceed the normalized limit of 1.0 of FCC requirement (i.e., Eq. (4c)).

## 5. Test Configurations

### 5.1. WWAN (sub-6) transmission

This  $P_{limit}$  values, corresponding to 1.0 W/kg (1gSAR) of  $SAR_{design\_target}$ , for technologies and bands supported by EUT are derived in Part 0 report and summarized in Table 5-1. Note all  $P_{limit}$  power levels entered in Table 5-1 correspond to average power levels plus tolerance after accounting for duty cycle in the case of TDD modulation schemes (for e.g., GSM, LTE TDD & Sub6 NR TDD).

Table 5-1 :  $P_{limit}$  for supported technologies and bands ( $P_{limit}$  in EFS file)

Device State Index (DSI)		0	1	Pmax (Maximum tune-up Power) (dBm)
Exposure scenario		Standalone SAR without triggering sensor	Standalone SAR with triggering sensor	
Test Distance (mm)		Refet to Section 6.3.		
Spatial-average		1g	1g	
WWAN Bands	Antenna	PLimit (dBm)		
WCDMA Band II	Main.1	27.6	12.5	22.5
WCDMA Band IV	Main.1	28.2	12.5	22.5
WCDMA Band V	Main.1	27.6	14.0	24.0
LTE Band 7	Main.1	27.5	13.0	24.0
LTE Band 12	Main.1	29.2	14.0	24.5
LTE Band 13	Main.1	27.7	14.0	24.0
LTE Band 14	Main.1	28.2	16.0	24.0
LTE Band 25/2	Main.1	29.5	14.0	24.0
LTE Band 26/5	Main.1	29.6	16.5	24.5
LTE Band 30	Main.1	25.6	13.0	22.0
LTE Band 41-PC3	Main.1	29.8	11.0	22.0
LTE Band 41-PC2	Main.1	29.7	10.4	22.9
LTE Band 66/4	Main.1	28.9	13.0	24.0
LTE Band 71	Main.1	31.5	20.0	24.5
NR Band n5	Main.1	28.2	18.0	24.0
NR Band n25/n2	Main.1	30.6	14.0	24.0
NR Band n66	Main.1	29.3	13.5	24.0
NR Band n71	Main.1	30.5	20.0	24.5
NR Band n41	Main.2	29.4	14.0	25.5
LTE Band 48	Main.3	20.6	11.0	20.5
NR Band n77	Main.3	20.5	11.0	24.5

\* Maximum Tune-up Target Power,  $P_{max}$  is configured in NV settings in DUT to limit maximum average transmitting power. This Power is converted into peak power in NV settings for TDD schemes. The DUT maximum allowed output power is equal to  $P_{max} + 1.0$  dB device uncertainty.

Based on selection criteria described in Section 3.2.1, the selected technologies/bands for testing time-varying test sequences are highlighted in Table 5-1. During Part 2 testing, the  $Reserve\_power\_margin$  (dB) is set to 3dB in EFS according to the manufacturer guide.

As Part 1 and Part 2 testing took place in parallel the selected technologies/bands were chosen based upon anticipated values encountered during pretesting before Tx powers were finalized.

The radio configurations used in Part 2 test for selected technologies, bands, DSIs and antennas are listed in Table 5-2. The corresponding worst-case radio configuration 1g SAR values for selected technology/band/DSI are extracted from Part 1 report and are listed in the last column of Table 5-2.

Based on equations (1a), (2a), (3a) and (4a), it is clear that Part 2 testing outcome is normalized quantity, which implies that it can be applied to any radio configuration within a selected technology/band/DSI. Thus, as long as applying the worst-case SAR obtained from the worst radio configuration in Part 1 testing to calculate time-varying SAR exposure in equations (1a), (2a), (3a) and (4a), the accuracy in compliance demonstrate remains the same.

**Table 5-2 : Radio configurations selected for Part 2 test**

Test Case	Test Scenario	Tech	Band	Antenna	DSI	Channel	Freq. (MHz)	RB/RB Offset/Bandwidth (MHz)	Mode	SAR Exposure Scenario	Worst configurations	Part 1 Worst Case Measured SAR at Plimit (W/kg)
1	Test Sequence 1	WCDMA	II	Main.1	1	9400	1880.0	-	RMC	Standalone	Edge 4 - 0mm	0.894
	9400					1880.0	-	RMC				
2	Test Sequence 1		V	Main.1	1	4183	836.6	-	RMC	Standalone	Edge 4 - 0mm	0.581
	Test Sequence 2					4183	836.6	-	RMC			
3	Test Sequence 1	LTE	26	Main.1	1	26865	831.5	1/74/15 MHz	QPSK	Standalone	Edge 4 - 0mm	0.682
	Test Sequence 2					26865	831.5	1/74/15 MHz	QSPK			
4	Test Sequence 1		7	Main.1	1	21350	2560.0	50/24/20 MHz	QPSK	Standalone	Edge 4 - 0mm	0.943
	Test Sequence 2					21350	2560.0	50/24/20 MHz	QPSK			
5	Test Sequence 1	NR	n5 (SA mode)	Main.1	1	167300	836.5	1/53/20 MHz	DFT-s-OFDM QPSK	Standalone	Edge 4 - 0mm	0.840
	Test Sequence 2					167300	836.5	1/53/20 MHz	DFT-s-OFDM QPSK			
6	Test Sequence 1		n77 (NSA mode)	Main.3	1	650000	3750	135/138/100 MHz	DFT-s-OFDM QPSK	Standalone	Edge 4 - 0mm	0.500
	Test Sequence 2					650000	3750	135/138/100 MHz	DFT-s-OFDM QPSK			
7	Change in Call	NR	n77 (NSA mode)	Main.3	1	650000	3750	135/138/100 MHz	DFT-s-OFDM QPSK	Standalone	Edge 4 - 0mm	0.500
8	Tech/Band Switch	WCDMA	II	Main.1	1	9400	1880.0	-	RMC	Standalone	Edge 4 - 0mm	0.894
		LTE	26	Main.1	1	26865	831.5	1/74/15 MHz	QPSK	Standalone	Edge 4 - 0mm	0.682
9	Time Window/ Antenna Switch	LTE	71	Main.1	1	133297	680.5	50/0/20 MHz	QPSK	Standalone	Edge 4 - 0mm	0.612
		LTE	48	Main.3	1	55340	3560	50/24/20 MHz	QPSK	Standalone	Edge 4 - 0mm	0.398
10	DSI Switch	NR	n77 (NSA mode)	Main.3	0	650000	3750	135/138/100 MHz	DFT-s-OFDM QPSK	Standalone	Edge 4 - 0mm	0.500
				Main.3	1	656000	3840	135/69/100 MHz	DFT-s-OFDM QPSK	Standalone	Rear - 8mm	0.556
11	SAR1 vs SAR2 (EN-DC)	NR	n71	Main.1	1	136100	680.5	50/28/20 MHz	DFT-s-OFDM QPSK	Standalone	Edge 4 - 0mm	0.944
		LTE	66	Main.1	1	132572	1770	1/0/20 MHz	DFT-s-OFDM QPSK	Standalone	Edge 4 - 0mm	0.834

**Notes:**

Reported SAR values in Part 1 SAR report are tested at  $P_{limit} + \text{tolerance}$ . Therefore, 100s(or 60s) average SAR is shown to be  $\pm 1.0$  dB from SAR design target.

Based on the selection criteria described in Section 3.2, the radio configurations for the Tx varying transmission test cases listed in Section 2 are:

1. Technologies and bands for time-varying Tx power transmission: The test case 1 ~ 6 listed in Table 5-2 are selected to test with the test sequences defined in Section 3.1 in both time-varying conducted power measurement and time-varying SAR measurement.
2. Technology and band for change in call test: NR Band n77 having the lowest  $P_{limit}$  among all technologies and bands (test case 7 in Table 5-2) is selected for performing the call drop test in conducted power setup.
3. Technologies and bands for change in technology/band test: Following the guidelines in Section 3.2.3, test case 8 in Table 5-2 is selected for handover test from a technology/band in Within one technology group (WCDMA Band II, DSI=1, Main.1 Ant), to a technology/band in the same DSI within another technology group (LTE Band 26, DSI=1, Main.1 Ant) in conducted power setup.
4. Technologies and bands for change in DSI: Based on selection criteria in Section 3.2.5, for a given technology and band, test case 10 in Table 5-2 is selected for DSI switch test by establishing a call in NR Band n77 in DSI=0, and then handing over to DSI =1 exposure scenario in conducted power setup.
5. Technologies and bands for change in time-window/antenna: Based on selection criteria in Section 3.2.6 and 3.2.4 for a given DSI=1, test case 9 in Table 5-2 is selected for time window switch between 100s window (LTE Band 71, Main.1 Ant) and 60s window (LTE Band 48, Main.3 Ant) in conducted power setup.
6. Technologies and bands for switch in SAR exposure: Based on selection criteria in Section 3.2.7 Scenario 1, test case 11 in Table 5-2 is selected for SAR exposure switching test in one of the supported simultaneous WWAN transmission scenario, i.e., LTE + Sub6 NR active in the same 100s time window, in conducted power setup, Since this device supports LTE + mmW NR, test for Section 3.2.7 Scenario 2 for RF exposure switch is covered in Sections 8.2.3 and 8.2.4 between LTE (100s window) and mmW NR (4s window).

## 5.2. LTE + mmW NR transmission

Based on the selection criteria described in Section 4.2, the selections for LTE and mmW NR validation test are listed in Table 5-3. The radio configurations used in this test are listed in Table 5-4.

**Table 5-3 : Selections for LTE + mmW NR validation measurements**

Transmission Scenario	Test	Technology and Band	mmW Beam
Time-varying Tx power test	1. cond. & Rad. Power meas. 2. PD meas.	LTE Band 5 and n261	Beam ID 18
		LTE Band 5 and n260	Beam ID 26
Switch in SAR vs. PD	1. cond. & Rad. Power meas.	LTE Band 5 and n261	Beam ID 18
		LTE Band 5 and n260	Beam ID 26
Beam switch test	1. cond. & Rad. Power meas.	LTE Band 5 and n261	Beam ID 18 to Beam ID 146
		LTE Band 5 and n260	Beam ID 20 to Beam ID 148

**Table 5-4 : Test configuration for LTE + mmW NR validation**

Tech	Band	Antenna	DSI	Channel	Bandwidth (MHz)	RB Size	RB Offset	Freq (MHz)	Mode	UL Duty Cycle
LTE	5	Main Ant.1	1	20525	10	1	49	836.5	QPSK	100.0%
mmW NR	n261	K-patch	-	2077891	100	66	0	27923.52	CP-OFDM, QPSK	75.6%*
	n260	K-patch	-	2254147	100	66	0	38498.88	CP-OFDM, QPSK	75.6%*

Note 1, mmW NR callbox UL duty cycle should be configured to be greater than 75% for all LTE + mmW NR Part 2 tests.



## 6. Conducted Power Test Results for Sub-6 Smart Transmit Feature Validation

### 6.1. Measurement setup

#### WCDMA / LTE test setup using The Rohde & Schwarz CMW500 callbox

The Rohde & Schwarz CMW500 callbox is used in this test.

Test setup Schematic	Test item(s)	Description(s)	Test setup photo
Figure B-1(a)	Time-varying Tx power transmission test (Section 3.3.1)	Single antenna measurement, one port (RF1 COM) of callbox	A.1
Figure B-1(b)	Change in technology and band test (Section 3.3.3)	Single antenna measurement, two ports (RF1 & RF3 COM) of callbox	A.2
	SAR exposure switching (Section 3.3.7)		
Figure B-1(c)	Change in antenna (Section 3.3.4)	two different antennas measurement,	A.3
	Change in time window (Section 3.3.6)	two ports (RF1 & RF3 COM) of callbox	

#### LTE + Sub6 NR(NSA mode) / Sub6 NR (SA mode) test setup using The UXM callbox

The UXM callbox is used in this test.

Test setup Schematic	Test item(s)	Description(s)	Test setup photo
Figure B-1(a)	Time-varying Tx power transmission test (Section 3.3.1) -SA mode-	Single tech measurement, one port (RF1 COM) of callbox	A.4
Figure B-1(d)	Time-varying Tx power transmission test (Section 3.3.1) Change in Call test (Section 3.3.2) Change in DSI test (Section 3.3.5) -NSA mode-	Single tech measurement, two ports (RF1 & RF3 COM) of callbox	A.5
Figure B-1(d)	SAR exposure switch test (Section 3.3.7)	two different techs measurement, two ports (RF1 & RF3 COM) of callbox	A.6

All the path losses from RF port of DUT to the callbox RF COM port and to the power meter are calibrated and automatically entered as offsets in the callbox and the power meter via test scripts on the PC used to control callbox and power meter.

Setup photos of Test setup Schematic are list in Appendix A.



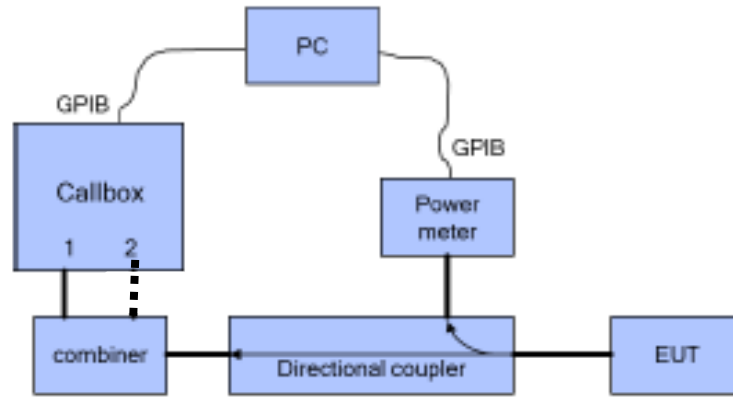

Figure B-1 (a) & Figure B-1 (b)

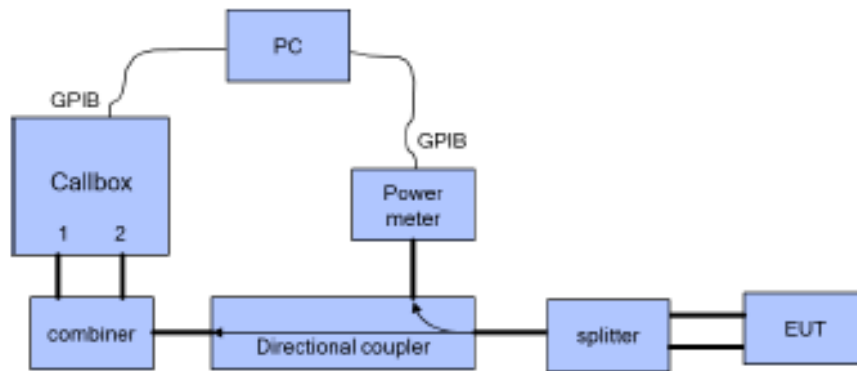

Figure B-1 (c)

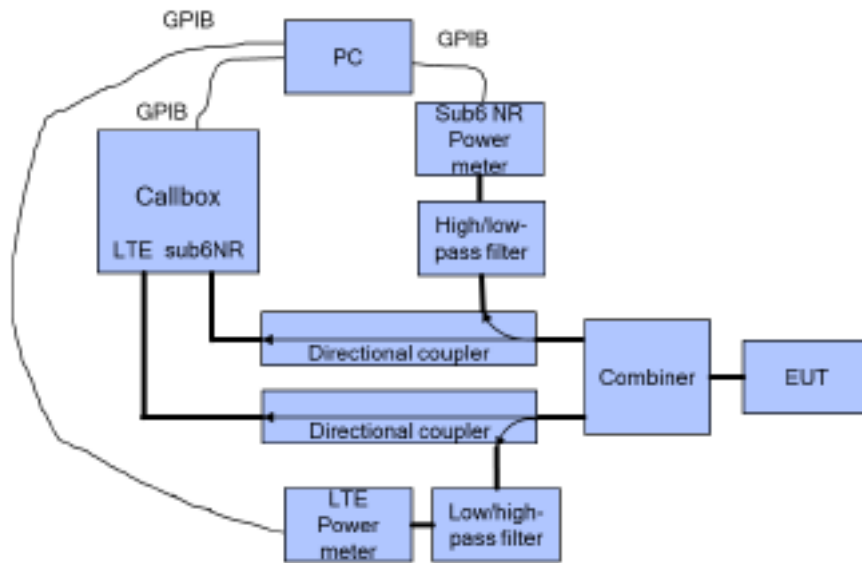

Figure B-1 (d)

Both the callbox and power meter are connected to the PC using GPIB cables. Two test scripts are custom made for automation, and the test duration set in the test scripts is 500 seconds.

For time-varying Tx power measurement, the PC runs the 1<sup>st</sup> test script to send GPIB commands to control the callbox's requested power versus time, while at the same time to record the conducted power measured at EUT RF port using the power meter. The commands sent to the callbox to request power are:

- 0 dBm for 100 seconds
- Test sequence 1 or test sequence 2 (defined in Section 3.1 and generated in Section 3.2.1), For 360 seconds
- Stay at the last power level of test sequence 1 or sequence 2 for the remaining time. Power meter readings are periodically recorded every 100ms. A running average of this measured Tx power over 100 seconds is performed in the post-data processing to determine the 100s-time averaged power.

For call drop, technology/band/antenna switch, and DSI switch tests, after the call is established, the callbox is set to request the EUT's Tx power at 0dBm for 100 seconds while simultaneously starting the 2<sup>nd</sup> test script runs at the same time to start recording the Tx power measured at EUT RF port using the power meter. After the initial 100 seconds since starting the Tx power recording, the callbox is set to request maximum power from the EUT for the rest of the test. Note that the call drop/re-establish, or technology/band/antenna switch or DSI switch is manually performed when the Tx power of EUT is at  $P_{reserve}$  level. See Section 3.3 for detailed test procedure of call drop test, technology/band/antenna switch test and DSI switch test.

## 6.2. $P_{limit}$ and $P_{max}$ measurement results

This measured  $P_{limit}$  for all the selected radio configurations given in Table 5-2 are listed in below Table 6-1.  $P_{max}$  was also measured for radio configurations selected for testing time-varying Tx power transmission scenarios in order to generate test sequences following the test procedures in Section 3.1.

**Table 6-1 : Measured  $P_{limit}$  and  $P_{max}$  of selected radio configurations**  
 Note: the device uncertainty of  $P_{max}$  is +1.0dB/-1.5dB as provided by manufacturer.

Test Case	Test Scenario	Tech	Band	Antenna	DSI	Channel	Freq. (MHz)	RB/RB Offset/Bandwidth (MHz)	Mode	SAR Exposure Scenario	Worst configurations	Part 1 Worst Case Measured SAR at $P_{limit}$ (W/kg)	$P_{limit}$ (dBm)	measured $P_{limit}$ (dBm)	Tune-up $P_{max}$ (dBm)	Measured $P_{max}$ (dBm)
1	Test Sequence 1	WCDMA	II	Main.1	1	9400	1880.0	-	RMC	Standalone	Edge 4 - 0mm	0.894	12.5	12.55	22.5	22.61
	9400					1880.0	-	RMC								
2	Test Sequence 1		V	Main.1	1	4183	836.6	-	RMC							
	4183					836.6	-	RMC								
3	Test Sequence 1	LTE	26	Main.1	1	26865	831.5	1/74/15 MHz	QPSK	Standalone	Edge 4 - 0mm	0.682	16.5	16.15	24.5	24.24
	Test Sequence 2					26865	831.5	1/74/15 MHz	QSPK							
4	Test Sequence 1		7	Main.1	1	21350	2560.0	50/24/20 MHz	QPSK							
	Test Sequence 2					21350	2560.0	50/24/20 MHz	QPSK							
5	Test Sequence 1	NR	n5 (SA mode)	Main.1	1	167300	836.5	1/53/20 MHz	DFT-s-OFDM QPSK	Standalone	Edge 4 - 0mm	0.840	18.0	18.33	24.0	23.90
	Test Sequence 2					167300	836.5	1/53/20 MHz	DFT-s-OFDM QPSK							
6	Test Sequence 1		n77 (NSA mode)	Main.3	1	650000	3750	135/138/100 MHz	DFT-s-OFDM QPSK							
	Test Sequence 2					650000	3750	135/138/100 MHz	DFT-s-OFDM QPSK							
7	Change in Call	NR	n77 (NSA mode)	Main.3	1	650000	3750	135/138/100 MHz	DFT-s-OFDM QPSK	Standalone	Edge 4 - 0mm	0.500	11.0	10.18	24.5	23.75
8	Tech/Band Switch	WCDMA	II	Main.1	1	9400	1880.0	-	RMC	Standalone	Edge 4 - 0mm	0.894	12.5	12.55	22.5	22.61
		LTE	26	Main.1	1	26865	831.5	1/74/15 MHz	QPSK	Standalone	Edge 4 - 0mm	0.682	16.5	16.15	24.5	24.24
9	Time Window/Antenna Switch	LTE	71	Main.1	1	133297	680.5	50/0/20 MHz	QPSK	Standalone	Edge 4 - 0mm	0.612	16.0	16.30	24.5	24.83
		LTE	48	Main.3	1	55340	3560	50/24/20 MHz	QPSK	Standalone	Edge 4 - 0mm	0.398	11.0	11.00	20.5	20.31
10	DSI Switch	NR	n77 (NSA mode)	Main.3	0	650000	3750	135/138/100 MHz	DFT-s-OFDM QPSK	Standalone	Edge 4 - 0mm	0.500	20.5	19.90	24.5	23.75
				Main.3	1	656000	3840	135/69/100 MHz	DFT-s-OFDM QPSK	Standalone	Rear - 8mm	0.556	11.0	10.18	24.5	23.75
11	SAR1 vs SAR2 (EN-DC)	NR	n71	Main.1	1	136100	680.5	50/28/20 MHz	DFT-s-OFDM QPSK	Standalone	Edge 4 - 0mm	0.944	16.0	19.70	24.5	25.09
		LTE	66	Main.1	1	132572	1770	1/0/20 MHz	DFT-s-OFDM QPSK	Standalone	Edge 4 - 0mm	0.834	13.0	13.31	24.0	24.68

**Notes:**

1. Tests including duty-cycle transmit are normalized to frame average.
2. Due to a limitation of the available test equipment, a modified procedure was used for Sub6 NR TDD Cases. The relevant parameters are shown below. On the above table, NR Band n77 measured  $P_{max}$  and Measured  $P_{limit}$  values represent  $P_{max\_sequence}$  and  $P_{limit\_sequence}$ . Section B.3 contains more details about the modified procedure used for NR Band n77 evaluation.

**Table 6-1-1 : Parameter for NR Band n77 Testing**

Modified Procedure lists	Output power
$P_{max\_online\_avg\_dBm}$	22.63 dBm
$P_{limit\_ftm\_dBm}$	4.18 dBm
$P_{limit\_online\_avg\_dBm}$	9.06 dBm
DutyCycle_dB	1.12 dB
<b><math>P_{max\_Sequence}</math></b>	<b>23.75 dBm</b>
<b><math>P_{limit\_Sequence}</math></b>	<b>10.18 dBm</b>

### 6.3. Time-varying Tx power measurement results (test case 1 - 6 in Table 5-2)

The measurement setup is shown in Figures A-1(a) and A-1(c). The purpose of the time-varying Tx power measurement is to demonstrate the effectiveness of power limiting enforcement and that the time-averaged Tx power when represented in time-averaged 1gSAR or 10gSAR values does not exceed FCC limit as shown in Eq.(1a) and (1b), rewritten below:

$$1g\_or\_10gSAR(t) = \frac{\text{conducted\_Tx\_power}(t)}{\text{conducted\_Tx\_power\_P}_{limit}} * 1g\_or\_10gSAR\_P_{limit} \quad (1a)$$

$$\frac{\frac{1}{T_{SAR}} \int_{t-T_{SAR}}^t 1g\_or\_10gSAR(t) dt}{FCC\ SAR\ limit} \leq 1 \quad (1b)$$

Where, *conducted\_Tx\_power(t)*, *conducted\_Tx\_power\_P<sub>limit</sub>*, and *1g\_or\_10gSAR\_P<sub>limit</sub>* correspond to the measured instantaneous conducted Tx power, measured conducted Tx power at *P<sub>limit</sub>*, and measured 1gSAR and 10gSAR value at *P<sub>limit</sub>* reported in Part 1 test (listed in Table 5-2 of this report as well). Following the test procedure in Section 3.3, the conducted Tx power measurement for all selected configurations are reported in this section. In all the conducted Tx power plots, the dotted line represents the requested power by callbox (test sequence 1 or test sequence 2), the blue curve represents the instantaneous conducted Tx power measured using power meter, the green curve represents time-averaged power and red line represents the conducted power limit that corresponds to FCC limit of 1.6 W/kg for 1gSAR or 4.0 W/kg for 10gSAR.

Similarly, in all the 1g or 10gSAR plots (when converted using Eq. (1a)), the green curve represents the 100s/60s-time averaged 1gSAR or 10gSAR value calculated based on instantaneous 1gSAR or 10gSAR; and the red line limit represents the FCC limit of 1.6 W/kg for 1gSAR or 4.0 W/kg for 10gSAR.

Time-varying Tx power measurements were conducted on test case #1 ~ #6 in Table 5-2, by generating test sequence 1 and test sequence 2 given in Section A using measured *P<sub>limit</sub>* and measured P<sub>max</sub> (last two columns of Table 6-1) for each of these test cases. Measurement results for test cases #1 ~ #6 are given in Sections 6.3.1 – 6.3.6.

### 6.3.1 WCDMA Band II

#### Test result for test sequence 1:

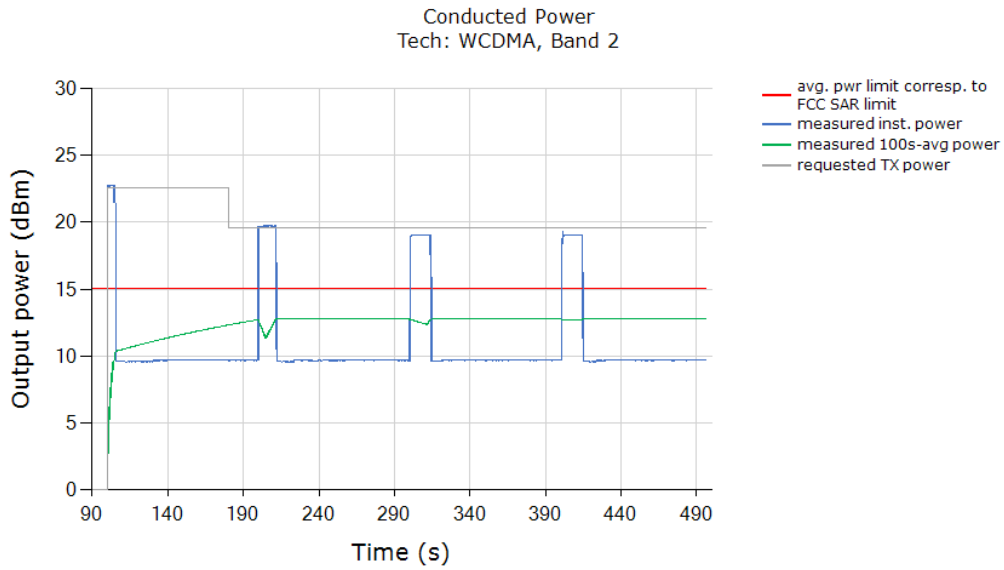

Above time-averaged conducted Tx power is converted/calculated into time-averaged SAR using Equation (1a) and plotted below to demonstrate that the time-averaged SAR versus time does not exceed the FCC limit for SAR (1.6W/kg for 1g SAR):

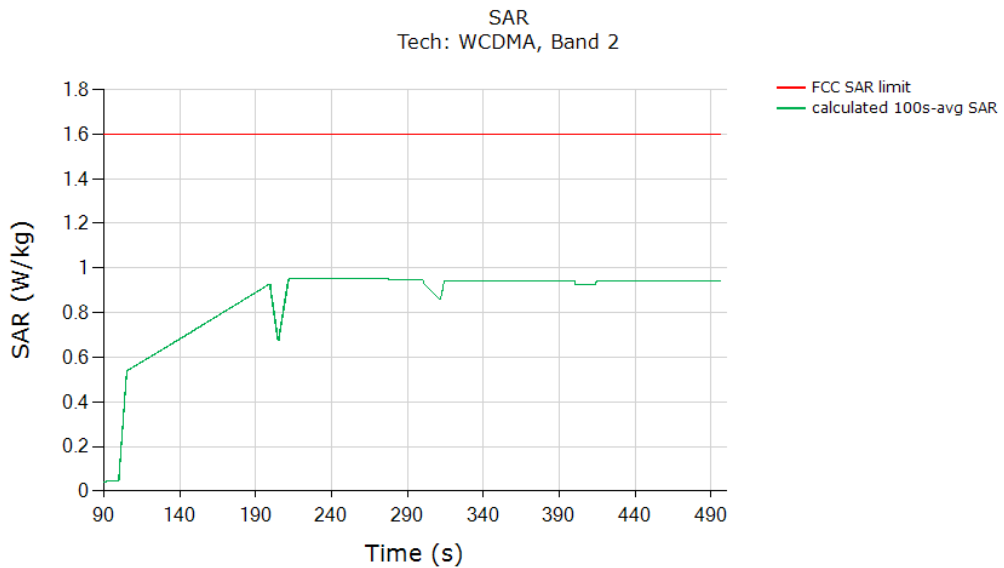

	(W/kg)
FCC 1gSAR limit	1.6
Max 100s-time averaged 1gSAR (green curve)	0.951
Validated : Max time averaged SAR (green curve) is within 1 dB device uncertainty of measured SAR at $P_{limit}$ (Table 5-2).	

Test result for test sequence 2:

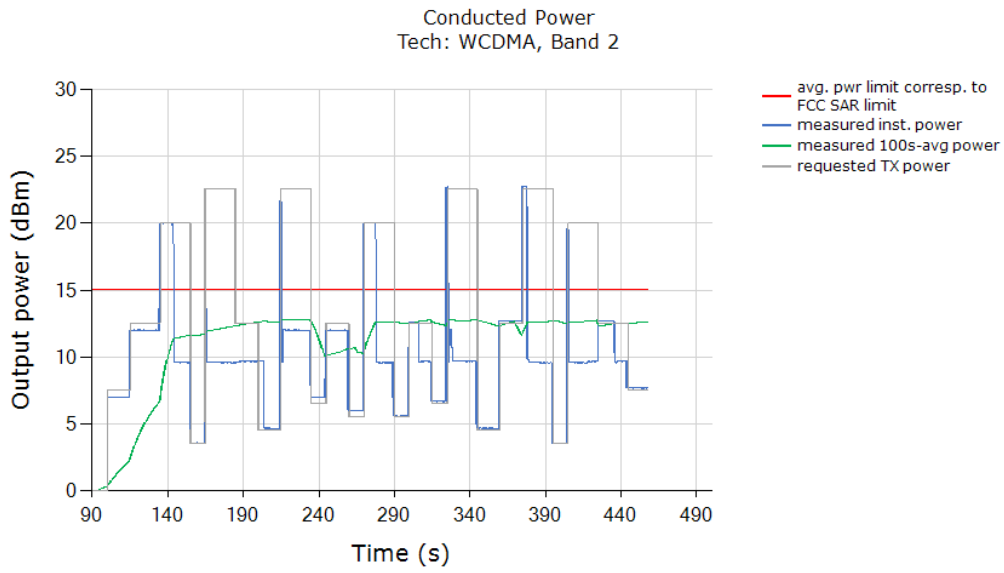

Above time-averaged conducted Tx power is converted/calculated into time-averaged SAR using Equation (1a) and plotted below to demonstrate that the time-averaged SAR versus time does not exceed the FCC limit for SAR (1.6W/kg for 1g SAR or 4.0W/kg for 10g SAR):

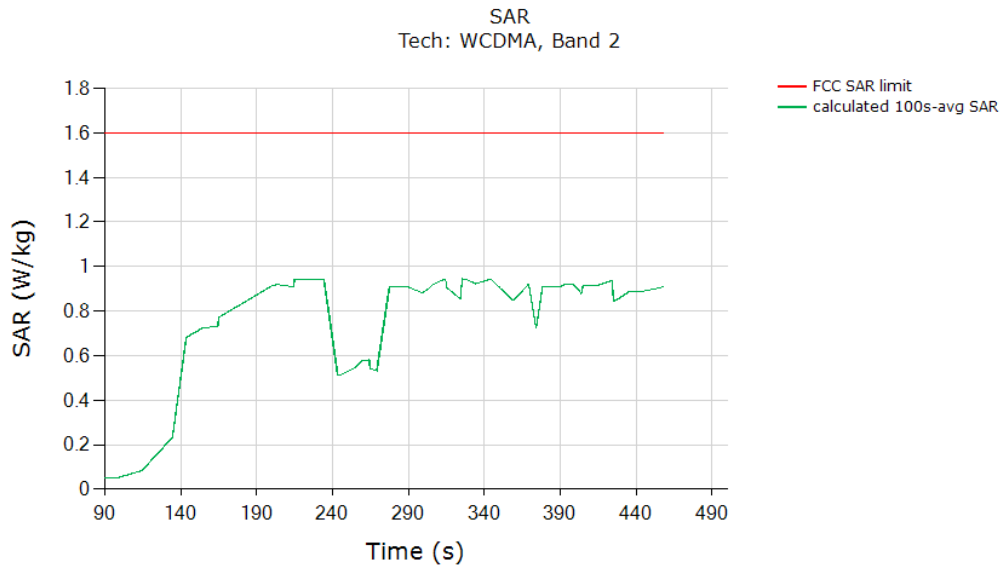

	(W/kg)
FCC 1gSAR limit	1.6
Max 100s-time averaged 1gSAR (green curve)	0.945
Validated : Max time averaged SAR (green curve) is within 1 dB device uncertainty of measured SAR at $P_{limit}$ (Table 5-2).	

### 6.3.2 WCDMA Band V

#### Test result for test sequence 1:

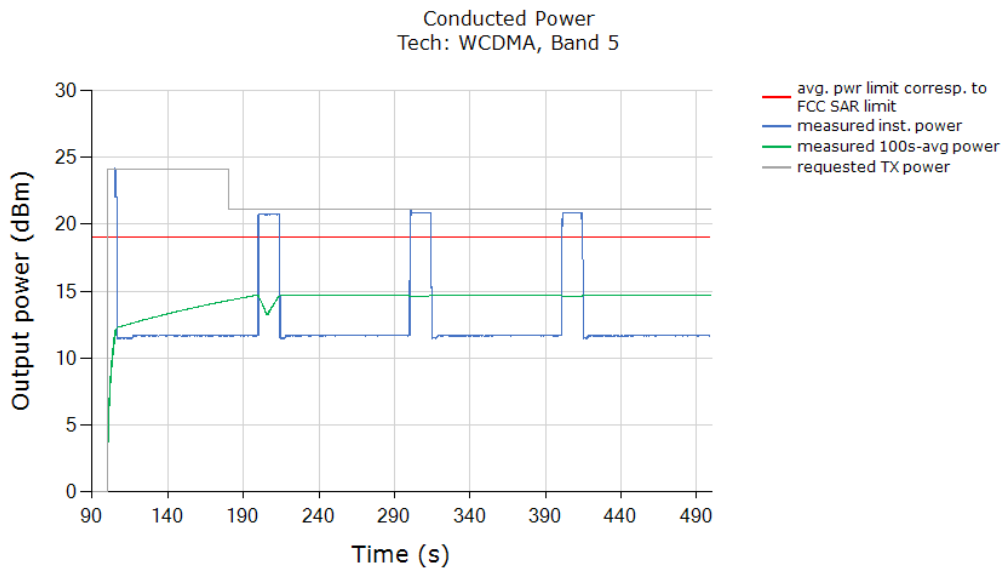

Above time-averaged conducted Tx power is converted/calculated into time-averaged SAR using Equation (1a) and plotted below to demonstrate that the time-averaged SAR versus time does not exceed the FCC limit for SAR (1.6W/kg for 1g SAR):

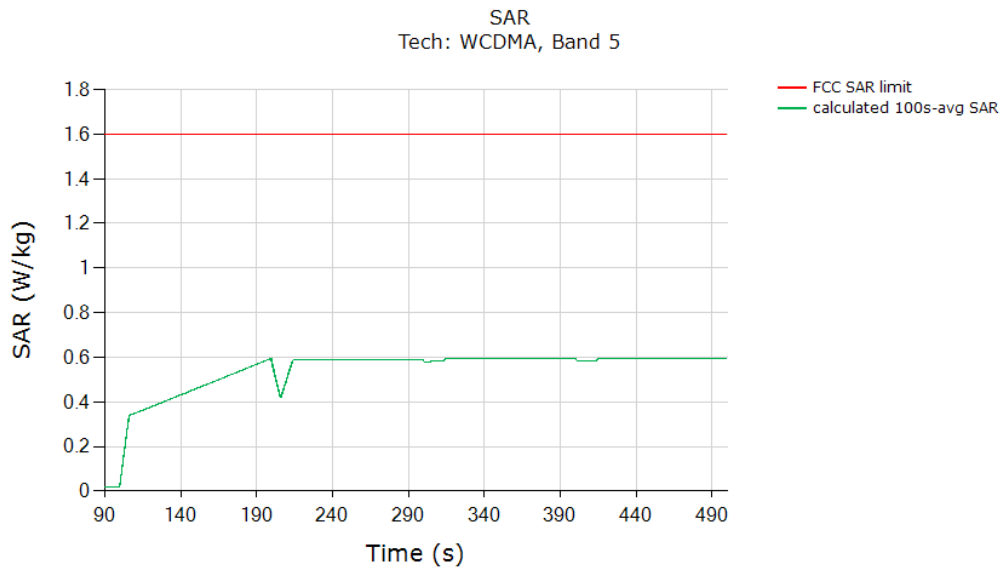

	(W/kg)
FCC 1gSAR limit	1.6
Max 100s-time averaged 1gSAR (green curve)	0.595
Validated : Max time averaged SAR (green curve) is within 1 dB device uncertainty of measured SAR at $P_{limit}$ (Table 5-2).	

Test result for test sequence 2:

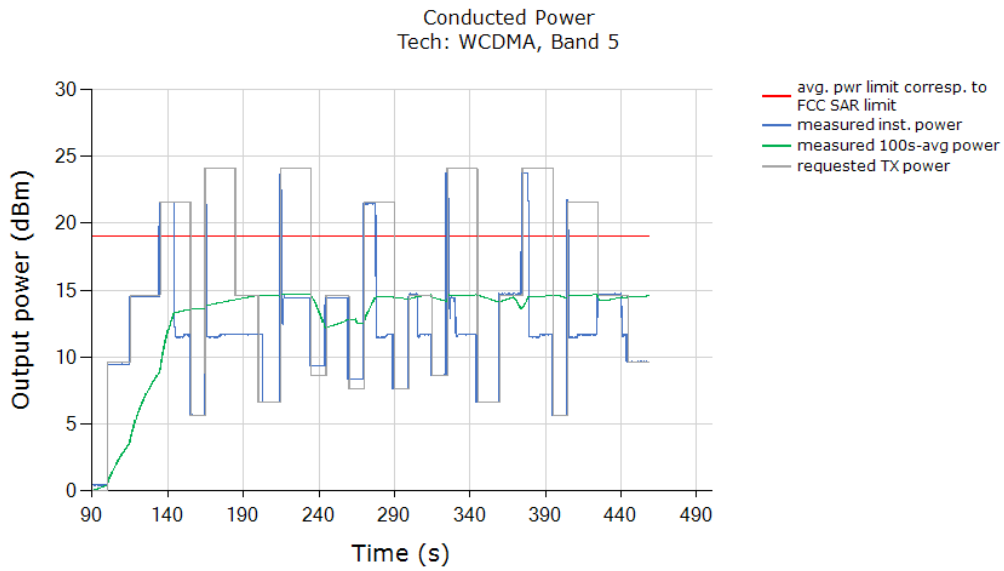

Above time-averaged conducted Tx power is converted/calculated into time-averaged SAR using Equation (1a) and plotted below to demonstrate that the time-averaged SAR versus time does not exceed the FCC limit for SAR (1.6W/kg for 1g SAR):

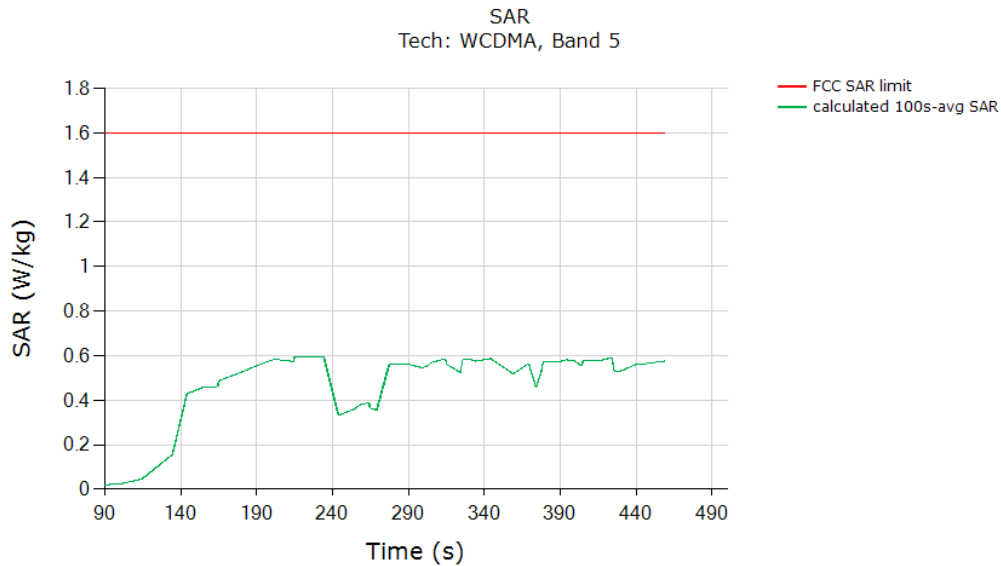

	(W/kg)
FCC 1gSAR limit	1.6
Max 100s-time averaged 1gSAR (green curve)	0.596
Validated : Max time averaged SAR (green curve) is within 1 dB device uncertainty of measured SAR at $P_{limit}$ (Table 5-2).	



### 6.3.3 LTE Band 26

#### Test result for test sequence 1:

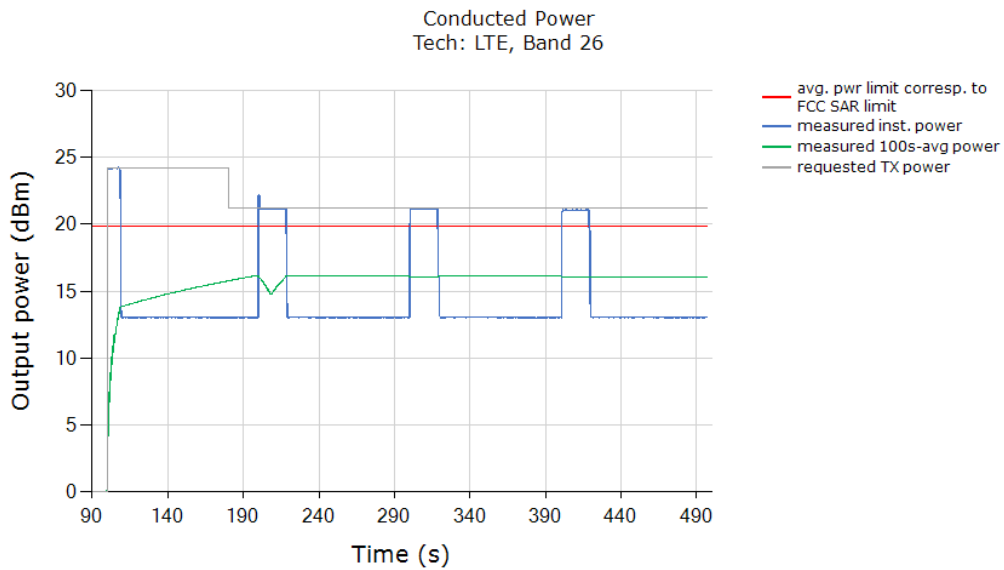

Above time-averaged conducted Tx power is converted/calculated into time-averaged SAR using Equation (1a) and plotted below to demonstrate that the time-averaged SAR versus time does not exceed the FCC limit for SAR (1.6W/kg for 1g SAR):

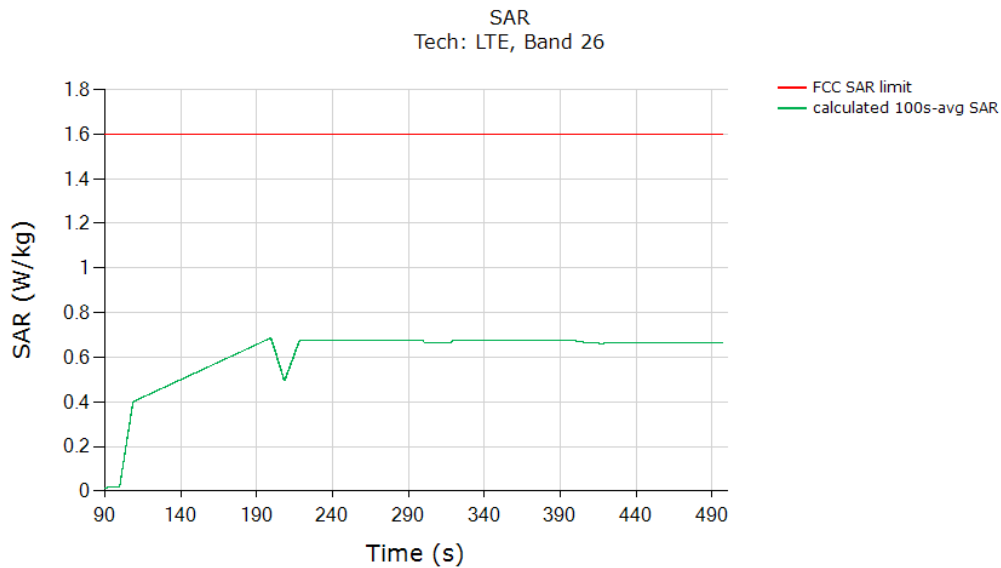

	(W/kg)
FCC 1gSAR limit	1.6
Max 100s-time averaged 1gSAR (green curve)	0.686
Validated : Max time averaged SAR (green curve) is within 1 dB device uncertainty of measured SAR at $P_{limit}$ (Table 5-2).	

Test result for test sequence 2:

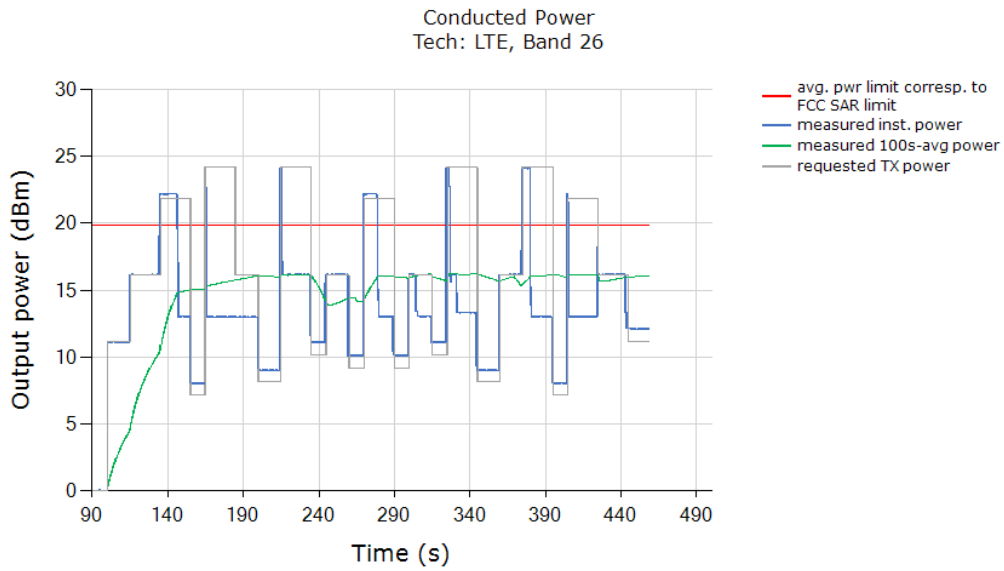

Above time-averaged conducted Tx power is converted/calculated into time-averaged SAR using Equation (1a) and plotted below to demonstrate that the time-averaged SAR versus time does not exceed the FCC limit for SAR (1.6W/kg for 1g SAR):

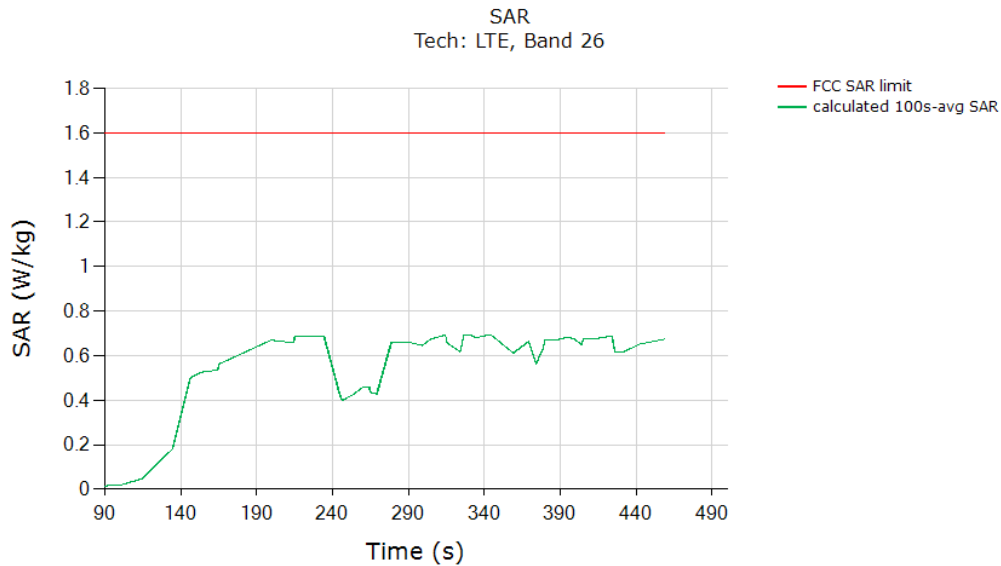

	(W/kg)
FCC 1gSAR limit	1.6
Max 100s-time averaged 1gSAR (green curve)	0.694
Validated : Max time averaged SAR (green curve) is within 1 dB device uncertainty of measured SAR at $P_{limit}$ (Table 5-2).	

### 6.3.4 LTE Band 7

#### Test result for test sequence 1:

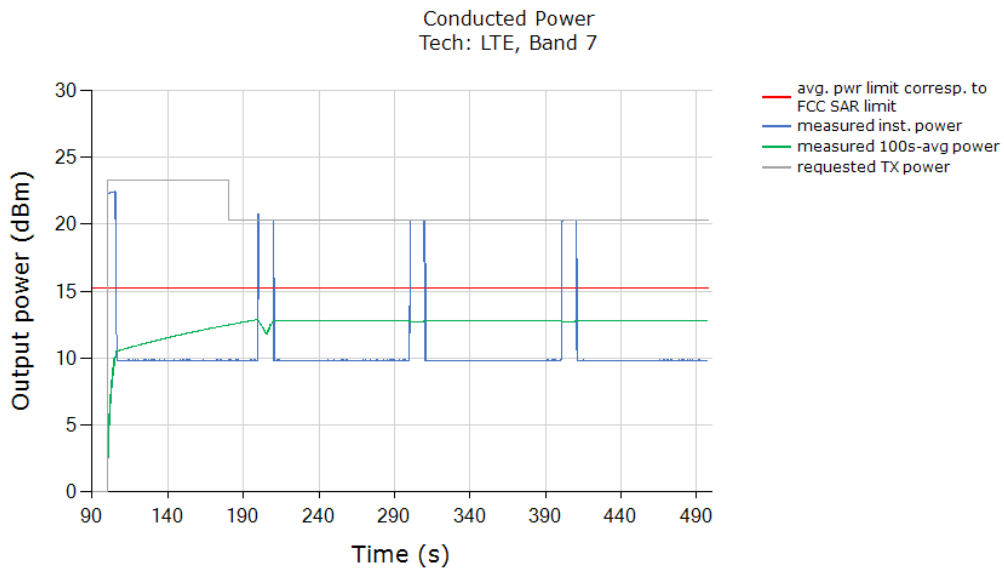

Above time-averaged conducted Tx power is converted/calculated into time-averaged SAR using Equation (1a) and plotted below to demonstrate that the time-averaged SAR versus time does not exceed the FCC limit for SAR (1.6W/kg for 1g SAR):

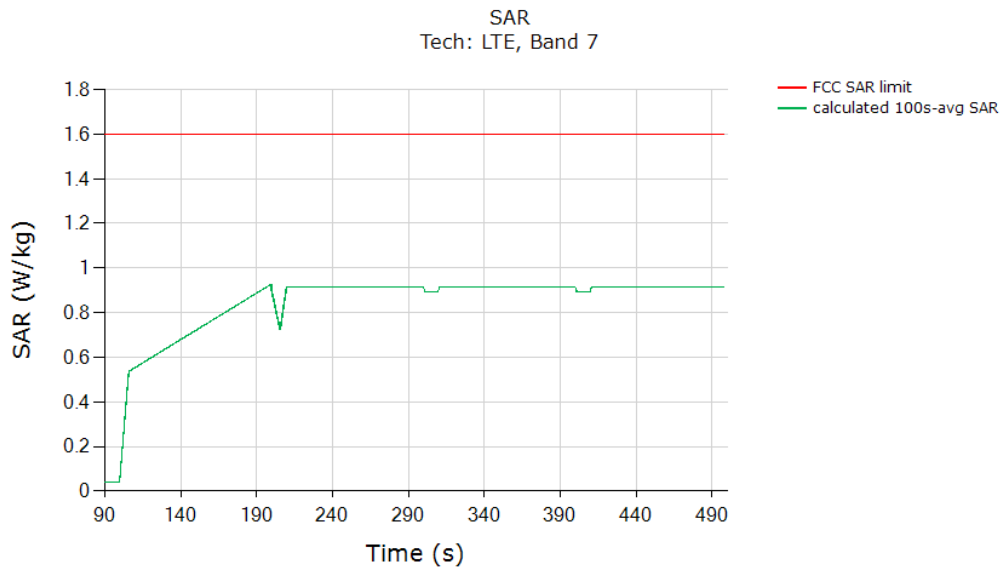

	(W/kg)
FCC 1gSAR limit	1.6
Max 100s-time averaged 1gSAR (green curve)	0.926
Validated : Max time averaged SAR (green curve) is within 1 dB device uncertainty of measured SAR at $P_{limit}$ (Table 5-2).	

Test result for test sequence 2:

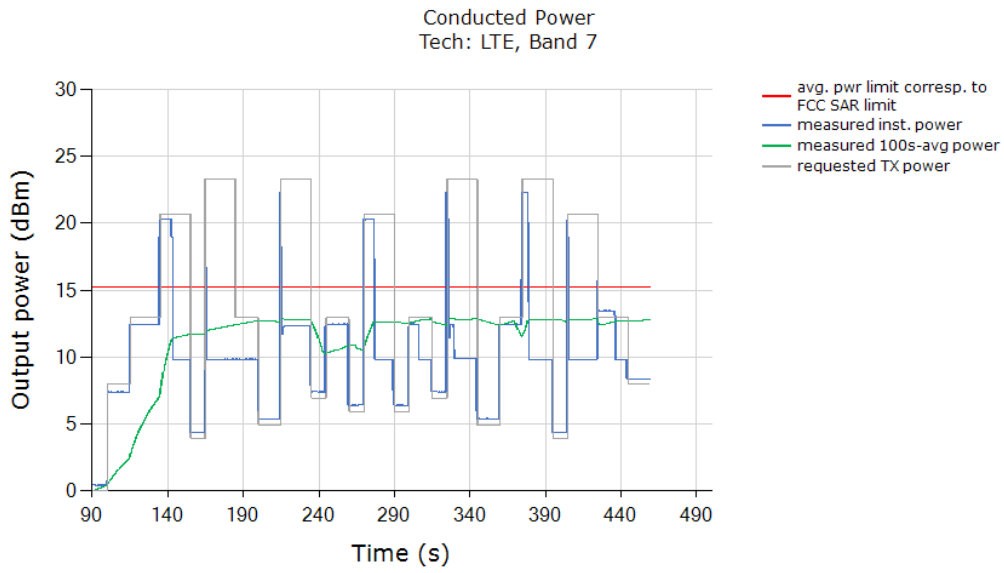

Above time-averaged conducted Tx power is converted/calculated into time-averaged SAR using Equation (1a) and plotted below to demonstrate that the time-averaged SAR versus time does not exceed the FCC limit for SAR (1.6W/kg for 1g SAR):

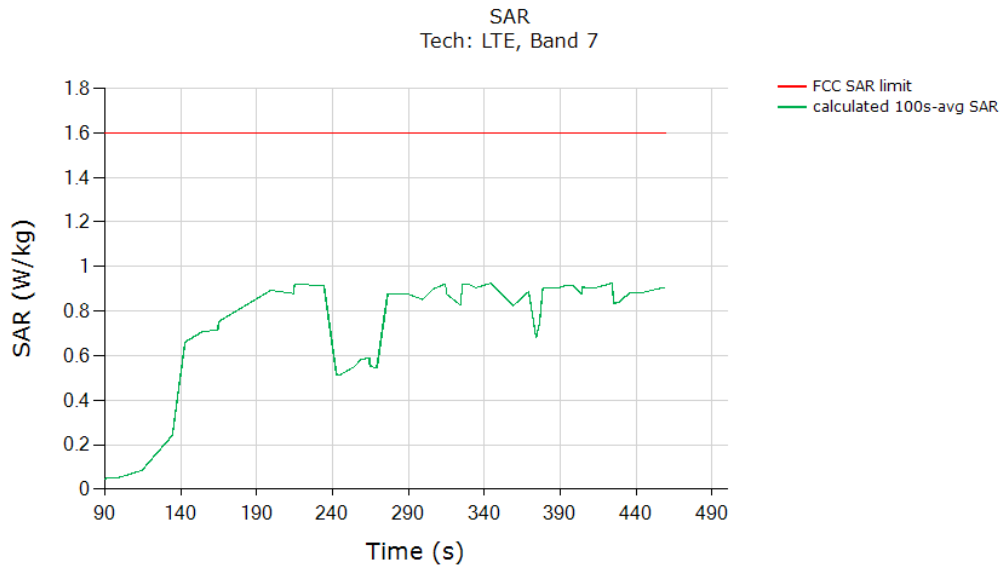

	(W/kg)
FCC 1gSAR limit	1.6
Max 100s-time averaged 1gSAR (green curve)	0.925
Validated : Max time averaged SAR (green curve) is within 1 dB device uncertainty of measured SAR at $P_{limit}$ (Table 5-2).	

### 6.3.5 NR Band n5

#### Test result for test sequence 1:

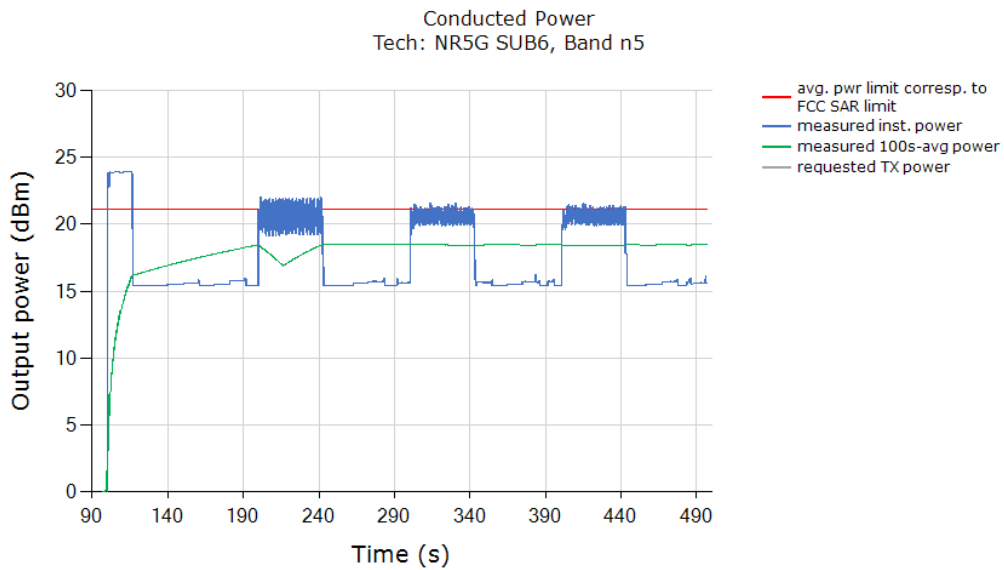

Above time-averaged conducted Tx power is converted/calculated into time-averaged SAR using Equation (1a) and plotted below to demonstrate that the time-averaged SAR versus time does not exceed the FCC limit for SAR (1.6W/kg for 1g SAR):

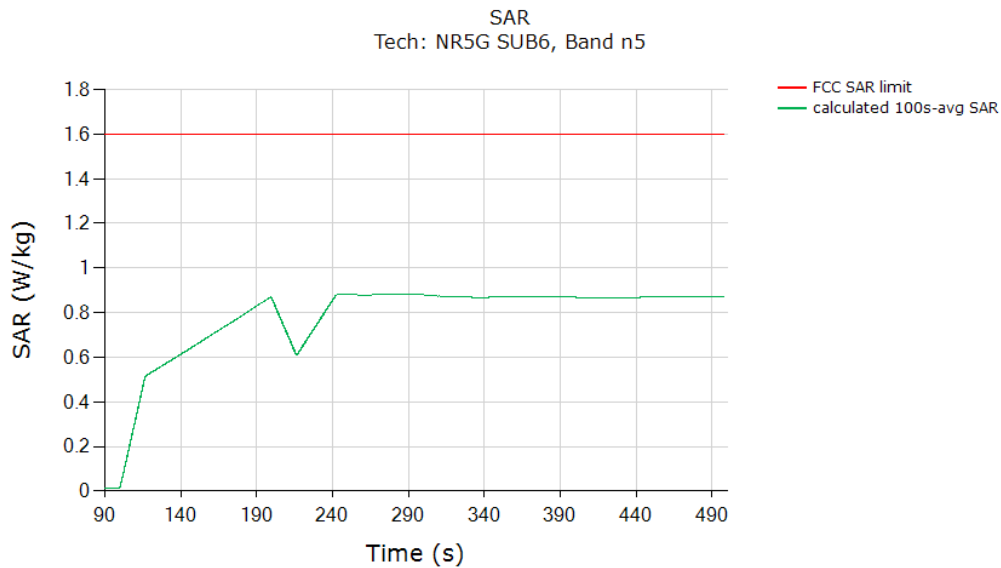

	(W/kg)
FCC 1gSAR limit	1.6
Max 100s-time averaged 1gSAR (green curve)	0.882
Validated : Max time averaged SAR (green curve) is within 1 dB device uncertainty of measured SAR at $P_{limit}$ (Table 5-2).	

Test result for test sequence 2:

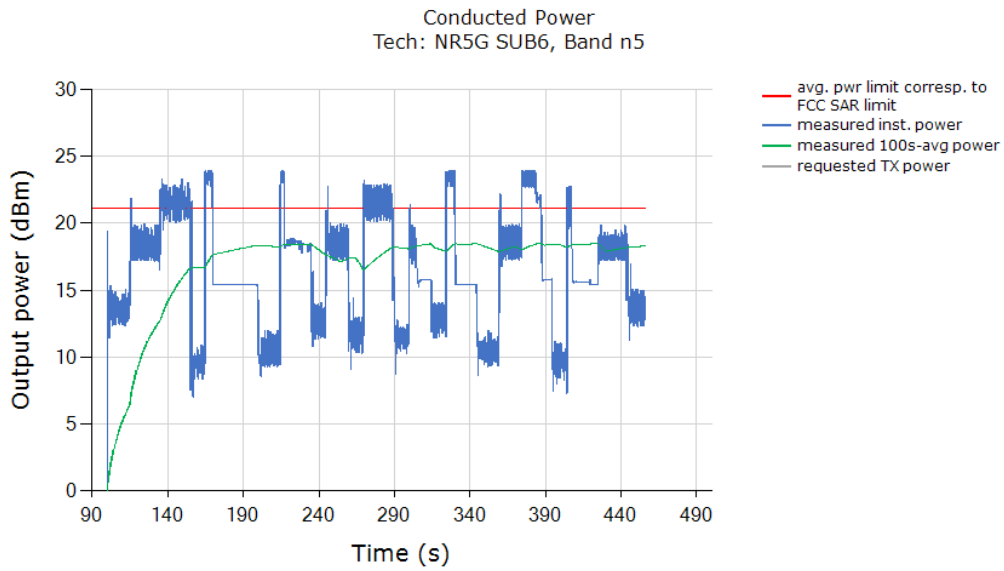

Above time-averaged conducted Tx power is converted/calculated into time-averaged SAR using Equation (1a) and plotted below to demonstrate that the time-averaged SAR versus time does not exceed the FCC limit for SAR (1.6W/kg for 1g SAR):

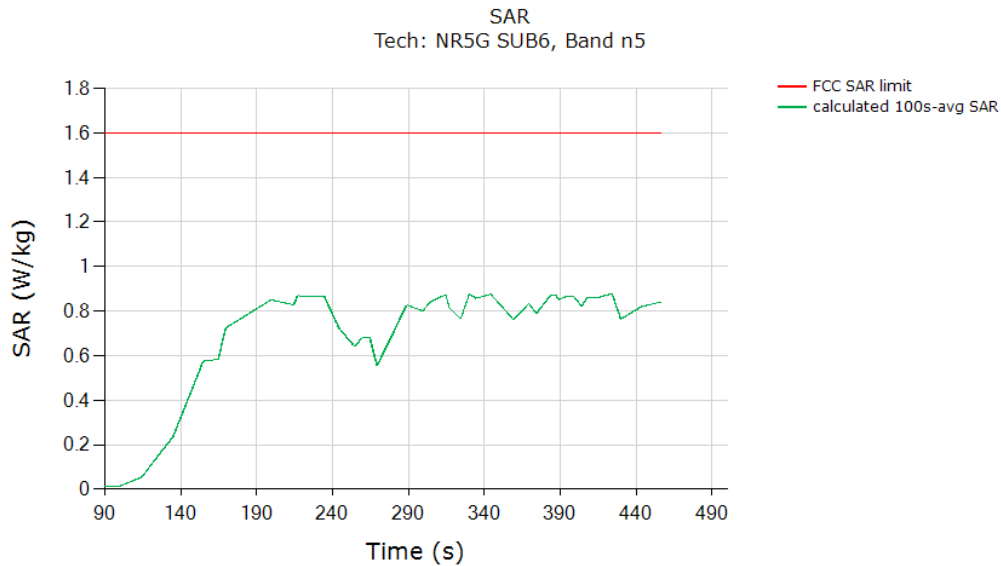

	(W/kg)
FCC 1gSAR limit	1.6
Max 100s-time averaged 1gSAR (green curve)	0.878
Validated : Max time averaged SAR (green curve) is within 1 dB device uncertainty of measured SAR at $P_{limit}$ (Table 5-2).	

### 6.3.6 NR Band n77

#### Test result for test sequence 1:

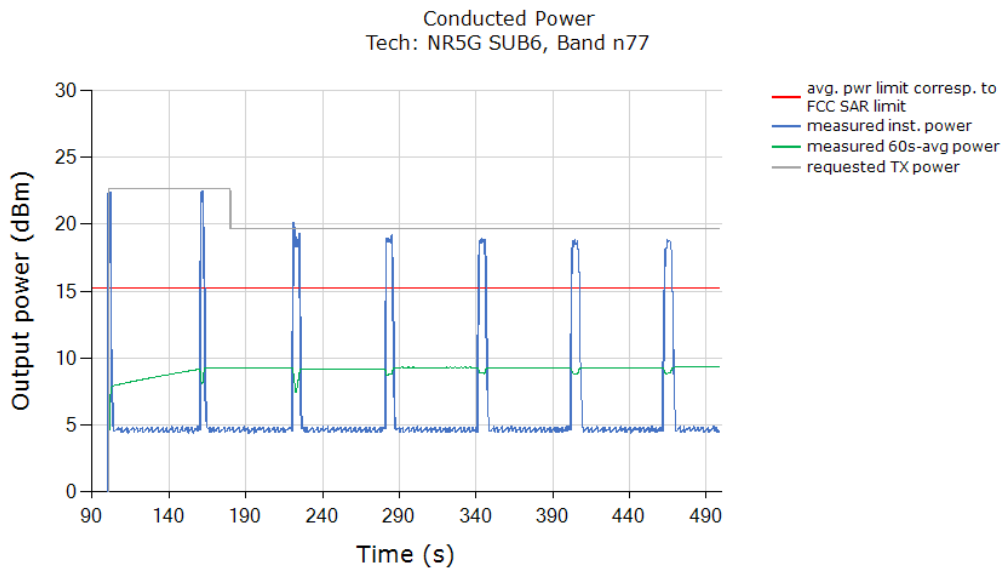

Above time-averaged conducted Tx power is converted/calculated into time-averaged SAR using Equation (1a) and plotted below to demonstrate that the time-averaged SAR versus time does not exceed the FCC limit for SAR (1.6W/kg for 1g SAR):

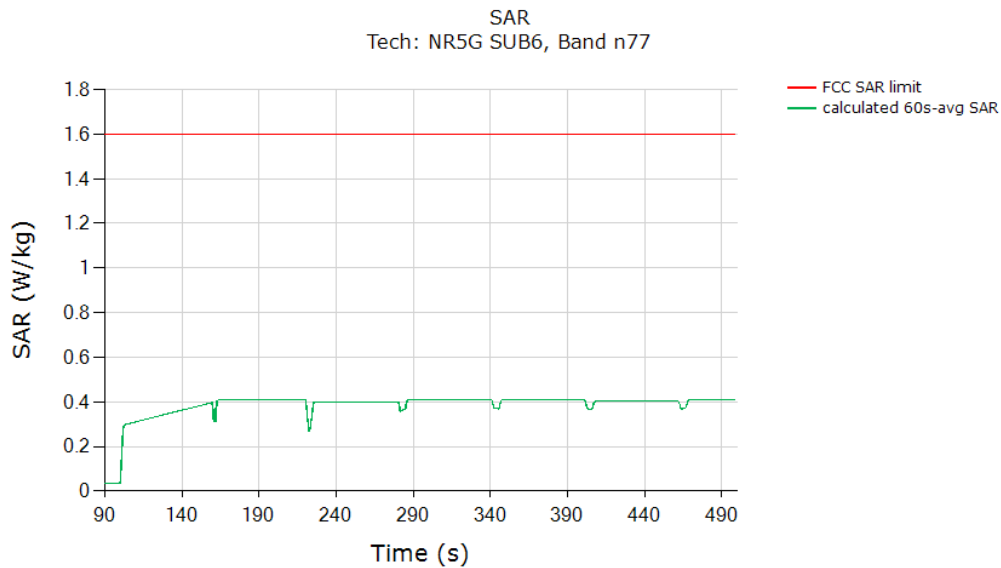

	(W/kg)
FCC 1gSAR limit	1.6
Max 60s-time averaged 1gSAR (green curve)	0.410
Validated : Max time averaged SAR (green curve) is within 1 dB device uncertainty of measured SAR at $P_{limit}$ (Table 5-2).	

Test result for test sequence 2:

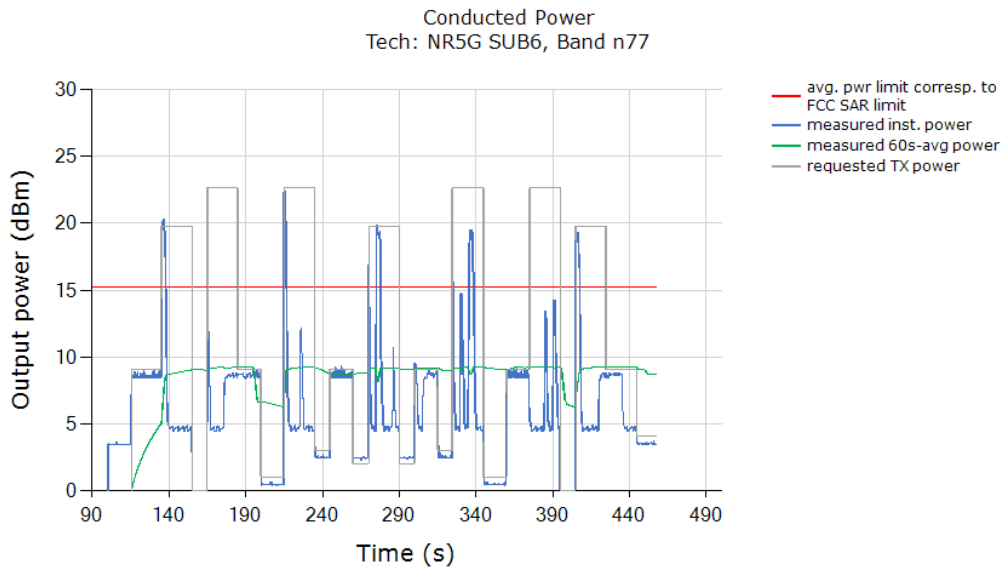

Above time-averaged conducted Tx power is converted/calculated into time-averaged SAR using Equation (1a) and plotted below to demonstrate that the time-averaged SAR versus time does not exceed the FCC limit for SAR (1.6W/kg for 1g SAR):

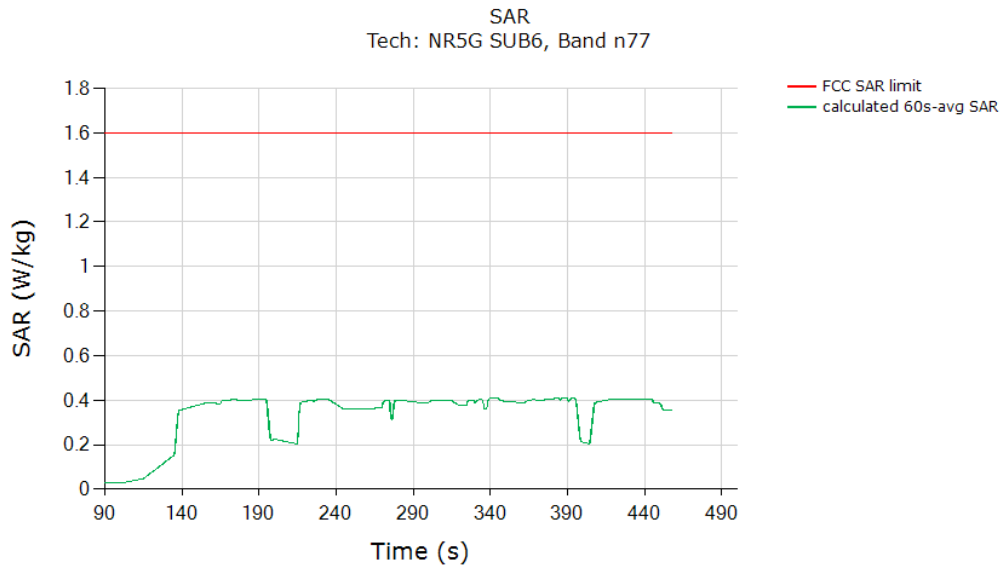

	(W/kg)
FCC 1gSAR limit	1.6
Max 60s-time averaged 1gSAR (green curve)	0.409
Validated : Max time averaged SAR (green curve) is within 1 dB device uncertainty of measured SAR at $P_{limit}$ (Table 5-2).	



### 6.4. Change in Call Test Results (test case 7 in Table 5-2)

This test was measured with NR Band n77, Main.3 Ant, DSI =1, and with callbox requesting maximum power. The call drop was manually performed when the EUT is transmitting at  $P_{reserve}$  level as shown in the plot below (dotted black region). The measurement setup is shown in Figure B-1(d). The detailed test procedures is described in Section 3.3.2.

Call drop test result:

**Plot 1** : Measured Tx power (dBm) versus time shows that the transmitting power kept the same  $P_{reserve}$  level of NR Band n77 after the call was re-established:

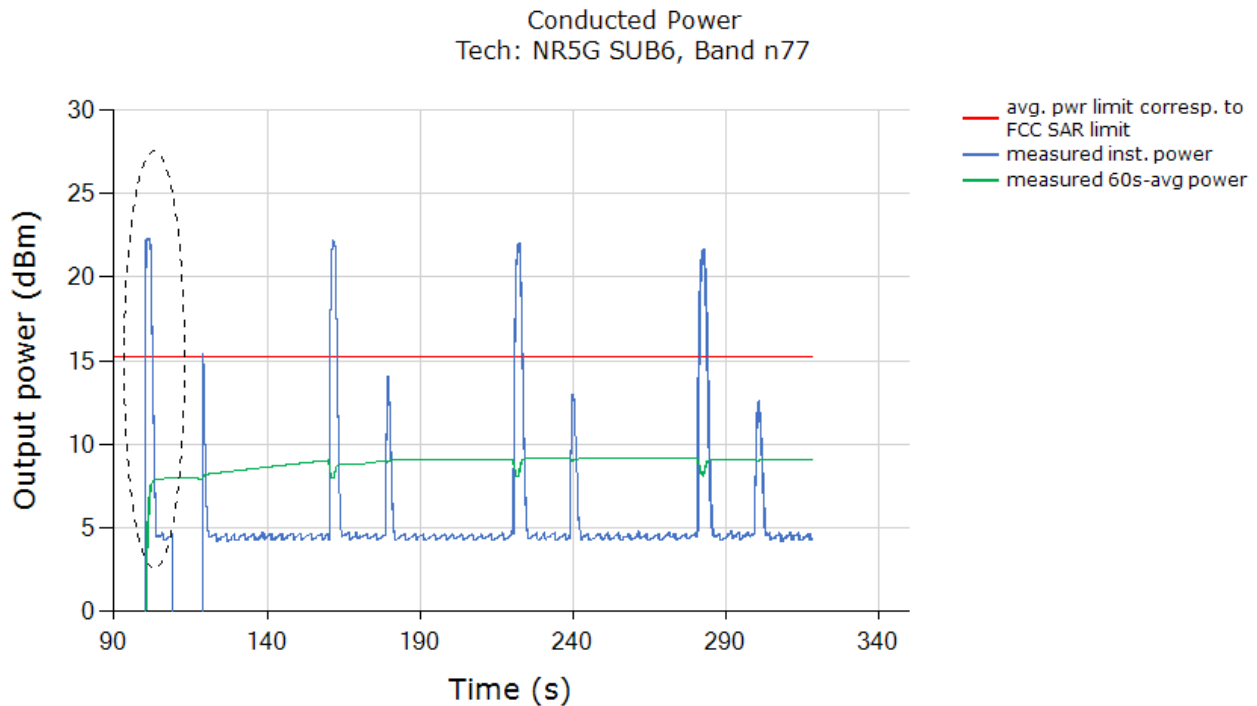

**Plot Notes:** The power level after the change in call kept the same  $P_{reserve}$  level of NR Band n77. The conducted power plot shows expected Tx transition.

**Plot 2** : Above time-averaged conducted Tx power is converted/calculated into time-averaged SAR using Equation (1a) and plotted below to demonstrate that the time-averaged SAR versus time does not exceed the FCC limit for SAR(1.6W/kg for 1g SAR):

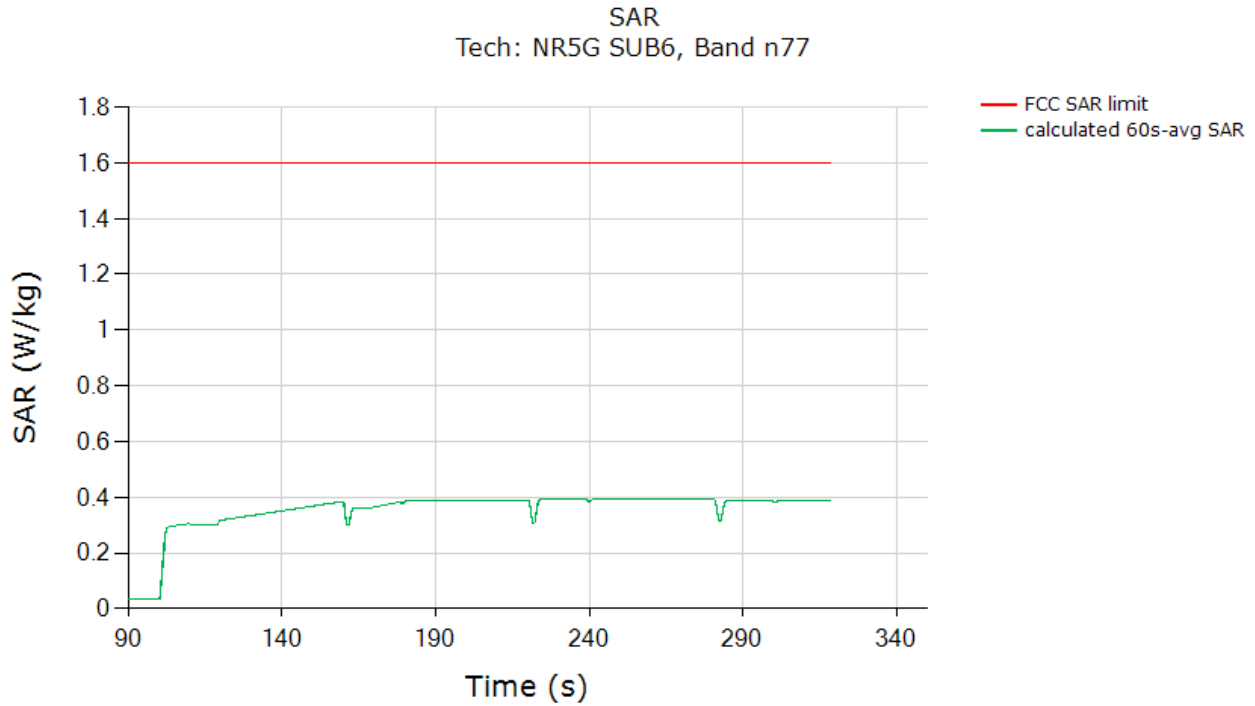

	(W/kg)
FCC 1gSAR limit	1.6
Max 60s-time averaged 1gSAR (green curve)	0.393
<b>Validated</b>	

The test result validated the continuity of power limiting in call change scenario.

## 6.5. Change in technology/band test results (test case 8 in Table 5-2)

This test was conducted with callbox requesting maximum power, and with antenna & technology switch from WCDMA Band II, Main.1 Ant, DSI = 1 to LTE Band 26, Main.1 Ant, DSI =1. Following procedure detailed in Section 3.3.3, and using the measurement setup shown in Figure B-1 (b), the technology/band switch was performed when the EUT is transmitting at  $P_{reserve}$  level as shown in the plot below (dotted black region).

Test result for change in technology/band:

**Plot 1** : Measured Tx power (dBm) versus time shows that the transmitting power changed from LTE Band 26, Main.1 Ant, DSI = 1  $P_{reserve}$  level to WCDMA Band II, Main.1 Ant, DSI = 1  $P_{reserve}$  level (within 1dB device uncertainty):

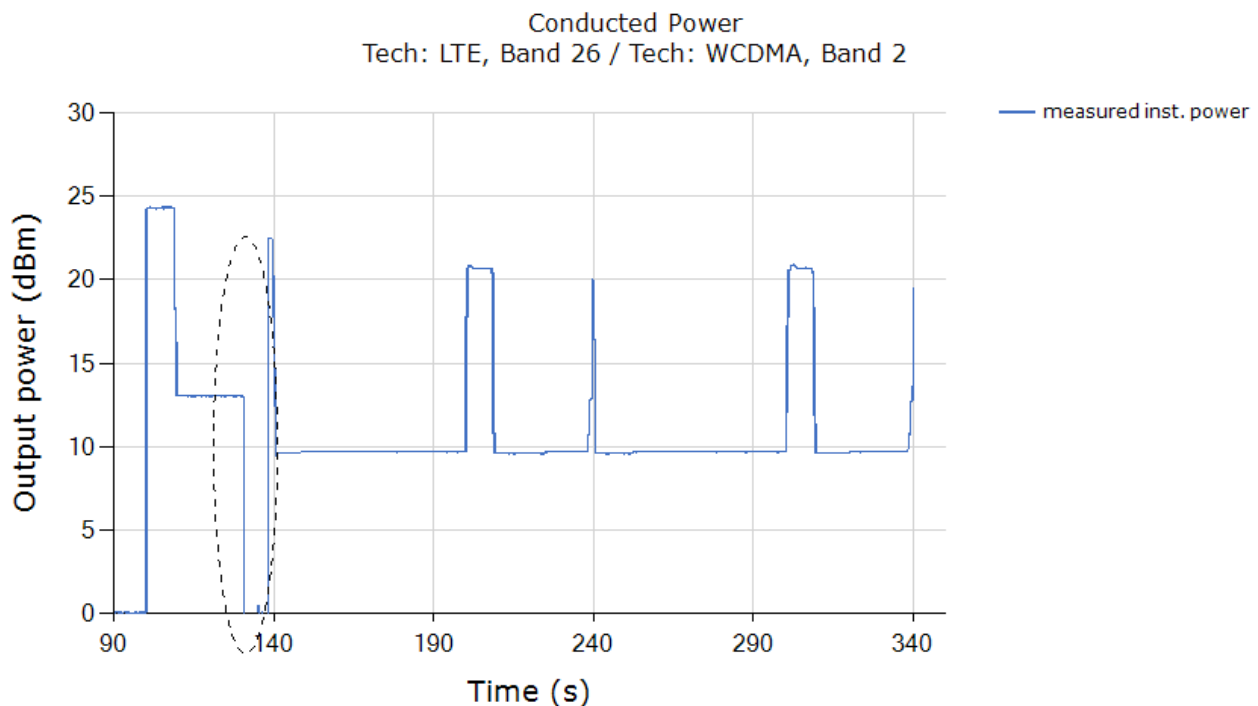

**Plot Notes** :  $Reserve\_power\_margin = 3\text{dB}$  according to the manufacturer. Based on Table 5-1,  
 $P_{limit} = 16.5\text{ dBm}$  for LTE Band 26 (DSI = 1), and  
 $P_{limit} = 12.5\text{ dBm}$  for WCDMA Band II (DSI = 1)

It can be calculated that  $P_{reserve} (P_{limit} - Reserve\_power\_margin) = 13.5\text{ dBm}$  and  $9.5\text{ dBm}$   
 For LTE Band 26 and WCDMA Band II, respectively.

**Plot 2:** All the time-averaged conducted Tx power measurement results were converted into time-averaged normalized SAR values using Equation (6a), (6b) and (6c), and plotted below to demonstrate that the time-average normalized SAR versus time does not exceed the normalized FCC limit of 1.0:

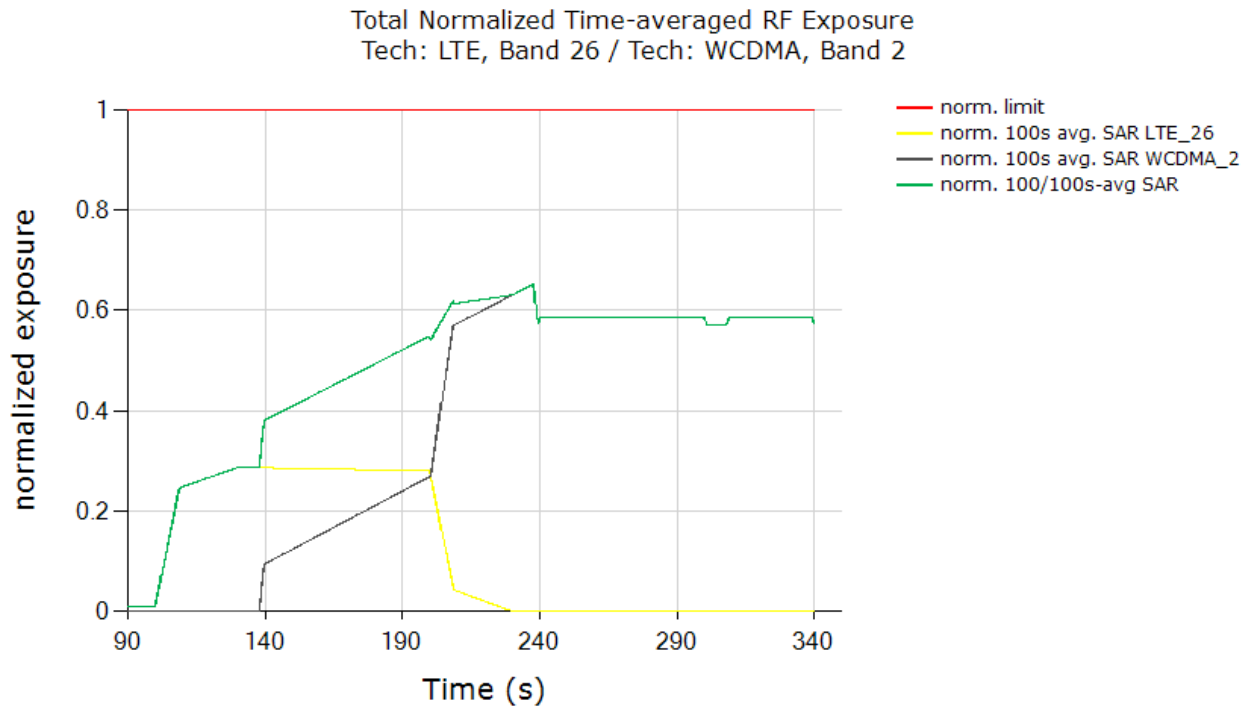

	(W/kg)
FCC normalized SAR limit	1.0
Max 100s-time averaged normalized SAR (green curve)	0.653
<b>Validated</b>	

The test result validated the continuity of power limiting in technology/band switch scenario.

### 6.6. Change in Time Window/Antenna test results (test case 9 in Table 5-2)

This test was conducted with callbox requesting maximum power, and with time-window/antenna switch between LTE Band 71, Main.1 Ant, DSI = 1 (100s window) and LTE Band 48, Main Ant.3, DSI = 1 (60s window). Following procedure detailed in Section 3.3.6, and using the measurement setup shown in Figure B-1(C), the time-window switch via tech/band/antenna switch was performed when the EUT is transmitting at  $P_{reserve}$  level.

#### Test case.1) Test result for change in time-window (from 100s to 60s to 100s):

**Plot 1** : Measured Tx power (dBm) versus time shows that the transmitting power changed when LTE Band 71 (100s window) switches to LTE Band 48 (60s window) and switches back to LTE Band 71 (100s window).

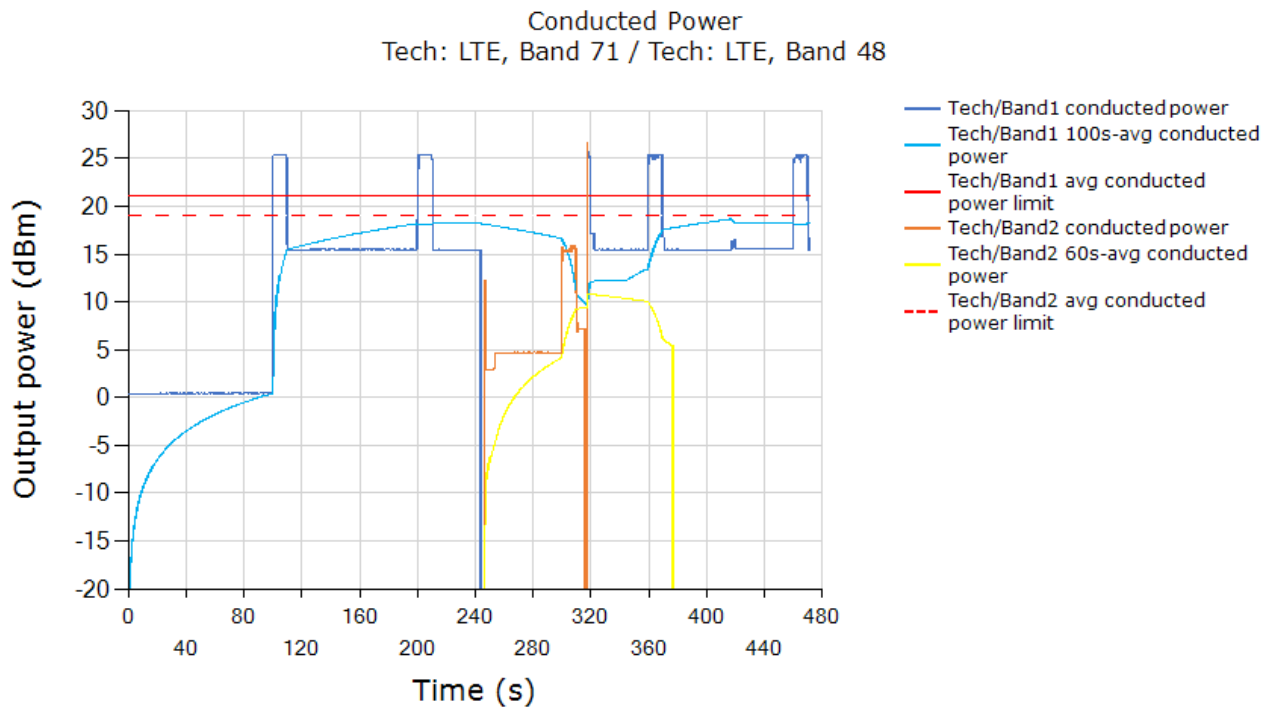

**Plot Notes** :  $Reserve\_power\_margin = 3\text{dB}$  according to the manufacturer,

$P_{limit} = 16.0\text{ dBm}$  for LTE Band 71, and  $P_{limit} = 14.0\text{ dBm}$  for LTE Band 48 according to Table 5.1.

The conducted power plot shows expected transitions in Tx power at ~245 seconds (100s-to-60s transition) and at ~318 seconds (60s-to-100s transition) in order to maintain total time-averaged RF exposure compliance across time windows, as show in next plot.

**Plot 2:** All the conducted Tx power measurement results were converted into time-averaged normalized SAR values using Equation (7a), (7b) and (7c), and plotted below to demonstrate that the time-averaged normalized SAR versus time does not exceed the FCC limit of 1.0 unit. Equation (7a) is used to convert the Tx power of device to obtain 100s-averaged normalized SAR in LTE Band 71 as shown in black curve. Similarly, equation (7b) is used to obtain 60s-averaged normalized SAR in LTE Band 48 as shown in orange curve. Equation (7c) is used to obtain total time-averaged normalized SAR as shown in green curve (i.e., sum of black and orange curves).

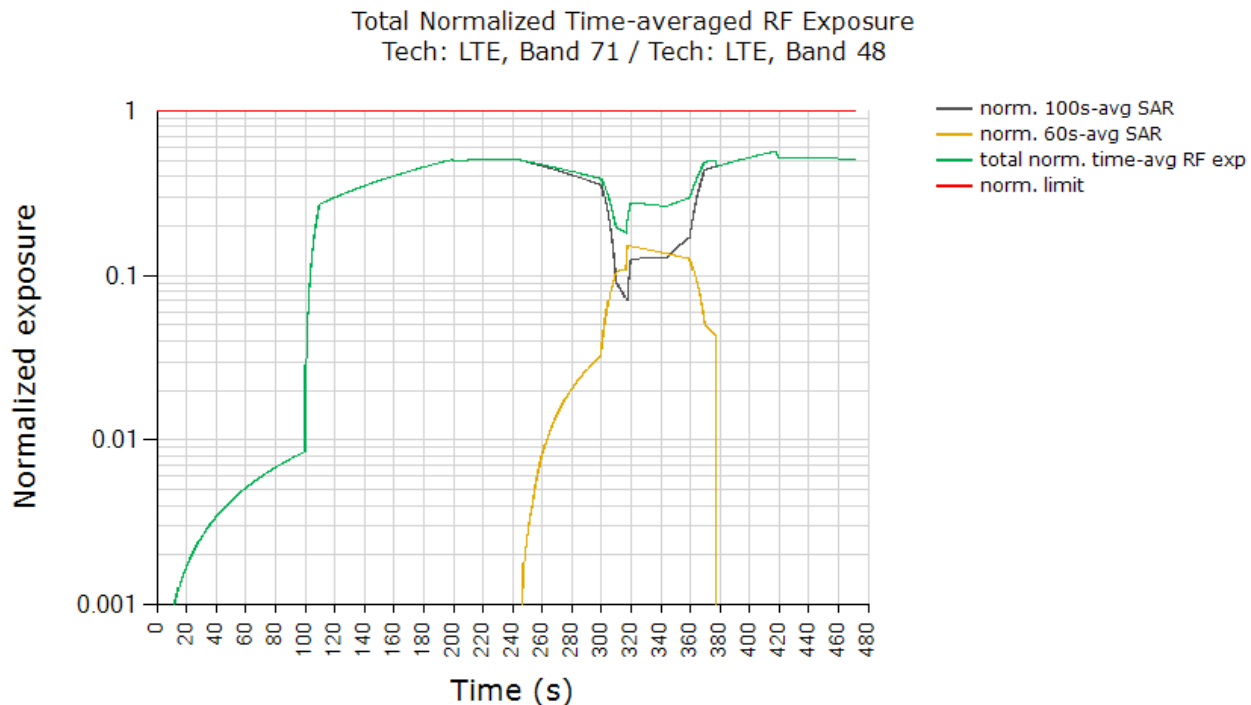

	(W/kg)
FCC normalized total exposure limit	1.0
Max 100s-time averaged normalized SAR (green curve)	0.567
<b>Validated</b>	

**Plot Notes:** Maximum power is requested by callbox for the entire duration of the test, with tech/band switches from 100s-to-60s window at ~245s time stamp, and from 60s-to-100s window at ~318s time stamp. Smart Transmit controls the Tx power during these time-window switches to ensure total time-averaged RF exposure, i.e., sum of black and orange curves given by equation (7c), is always compliant. In time-window switch test, at all times the total time-averaged normalized RF exposure (green curve) should not exceed normalized SAR<sub>design target</sub> + 1.0 dB device uncertainty. In this test, with a maximum normalized SAR of 0.567 being ≤ 0.79 (=1.0/1.6 + 1.0 dB device uncertainty), the above test result validated the continuity of power limiting in time=window switch scenario.

**Test case.2) Test result for change in time-window (from 60s to 100s to 60s):**

**Plot 1** : Measured Tx power (dBm) versus time shows that the transmitting power changed when LTE Band 48 (60s window) switches to LTE Band 71 (100s window) and switches back to LTE Band 48 (60s window).

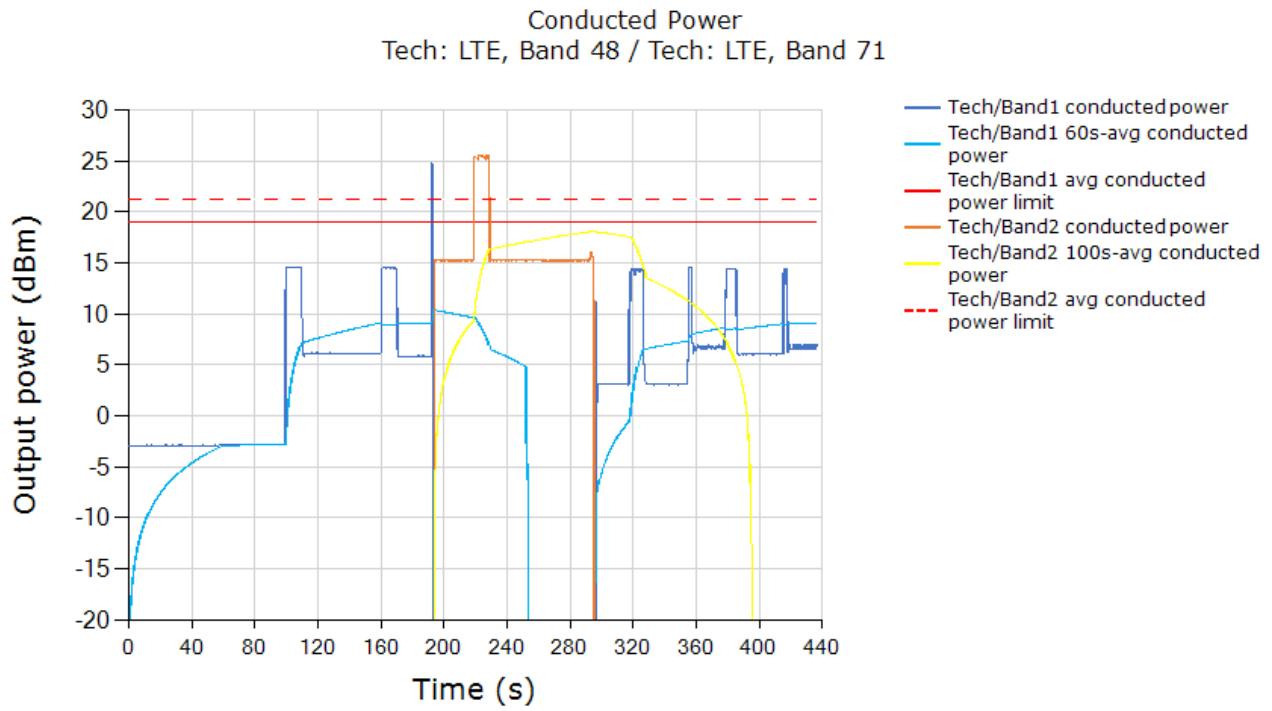

**Plot Notes** : *Reserve\_power\_margin* = 3dB according to the manufacturer,

$P_{limit}$  = 16.0 dBm for LTE Band 71, and  $P_{limit}$  = 14.0 dBm for LTE Band 48 according to Table 5.1.

The conducted power plot shows expected transitions in Tx power at ~194 seconds (60s-to-100s transition) and at ~297 seconds (100s-to-60s transition) in order to maintain total time-averaged RF exposure compliance across time windows, as show in next plot.

**Plot 2:** All the conducted Tx power measurement results were converted into time-averaged normalized SAR values using Equation (7a), (7b) and (7c), and plotted below to demonstrate that the time-averaged normalized SAR versus time does not exceed the FCC limit of 1.0 unit. Equation (7a) is used to convert the Tx power of device to obtain 60s-averaged normalized SAR in LTE Band 48 as shown in black curve. Similarly, equation (7b) is used to obtain 100s-averaged normalized SAR in LTE Band 71 as shown in orange curve. Equation (7c) is used to obtain total time-averaged normalized SAR as shown in green curve (i.e., sum of black and orange curves).

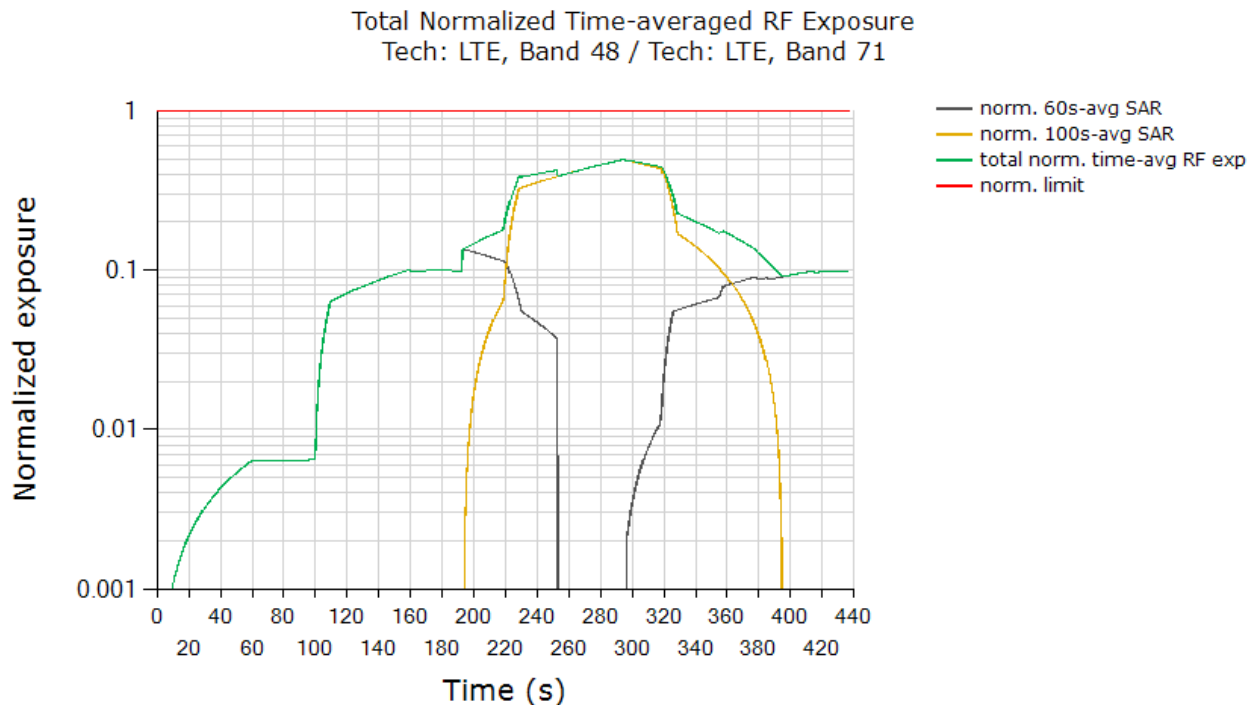

	(W/kg)
FCC normalized total exposure limit	1.0
Max 100s-time averaged normalized SAR (green curve)	0.492
<b>Validated</b>	

**Plot Notes:** Maximum power is requested by callbox for the entire duration of the test, with tech/band switches from 60s-to-100s window at ~245s time stamp, and from 100s-to-60s window at ~330s time stamp. Smart Transmit controls the Tx power during these time-window switches to ensure total time-averaged RF exposure, i.e., sum of black and orange curves given by equation (7c), is always compliant. In time-window switch test, at all times the total time-averaged normalized RF exposure (green curve) should not exceed normalized SAR<sub>design\_target</sub> + 1.0 dB device uncertainty. In this test, with a maximum normalized SAR of 0.492 being ≤ 0.79 (=1.0/1.6 + 1.0 dB device uncertainty), the above test result validated the continuity of power limiting in time=window switch scenario.



## 6.7. Change in DSI test results (test case 10 in Table 5-2)

This test was conducted with callbox requesting maximum power, and with DSI switch from NR Band n77 DSI = 1 to DSI = 0. Following procedure detailed in Section 3.3.5 using the measurement setup shown in Figure B-1(d), the DSI switch was performed when the EUT is transmitting at  $P_{reserve}$  level as shown in the plot below (dotted black circle).

### Test result for change in DSI:

**Plot 1** : Measured Tx power (dBm) versus time shows that the transmitting power changed when DSI = 1 switches to DSI = 0:

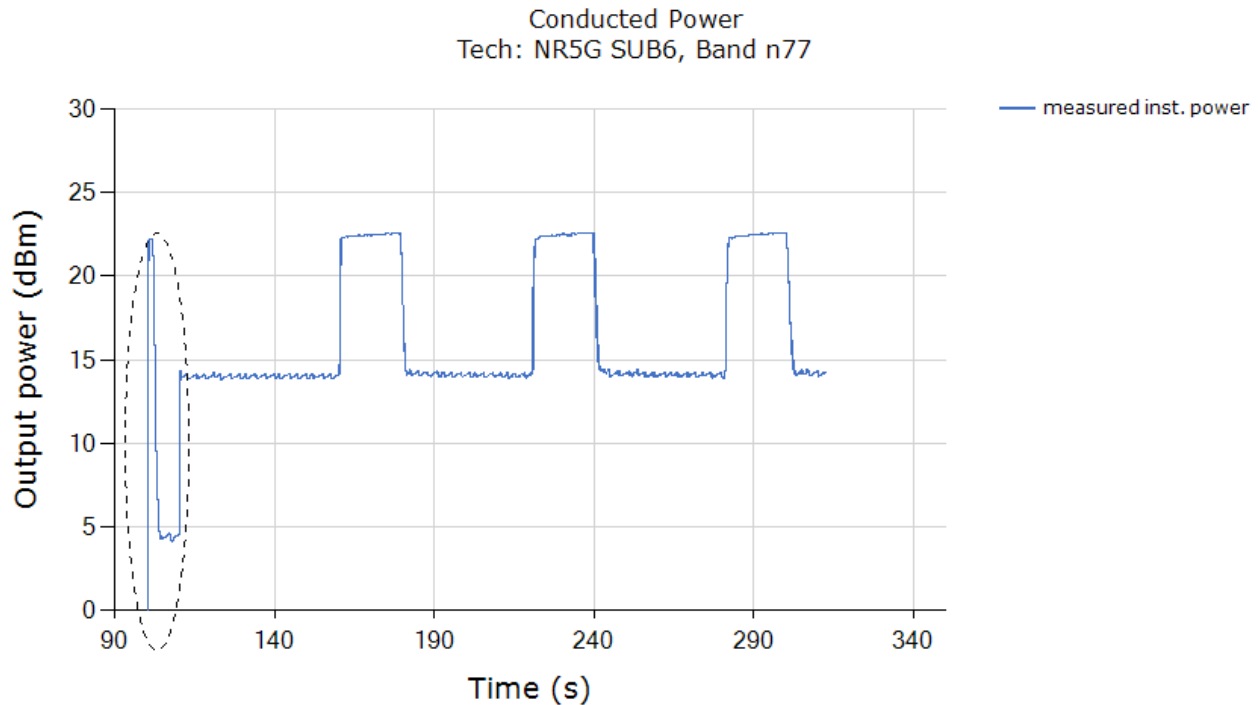

**Plot Notes** :  $Reserve\_power\_margin = 3\text{dB}$  according to the manufacturer,

$P_{limit} = 11.0\text{ dBm}$  for DSI = 1, and  $P_{limit} = 20.5\text{ dBm}$  for DSI = 0 according to Table 5.1.

**Plot 2:** All the time-averaged conducted Tx power measurement results were converted into time-averaged normalized SAR values using Equation (6a), (6b) and (6c), and plotted below to demonstrate that the time-average normalized SAR versus time does not exceed the normalized FCC limit of 1.0 unit.

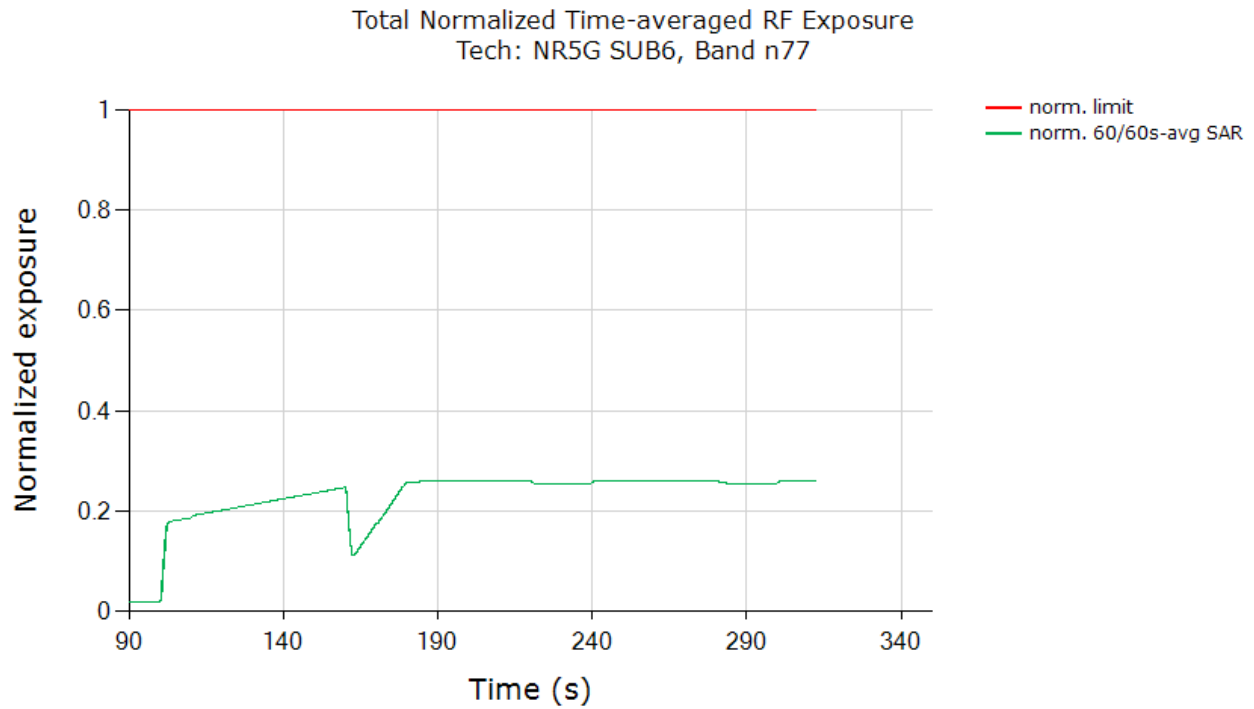

	(W/kg)
FCC normalized SAR limit	1.0
Max 60s-time averaged normalized SAR (green curve)	0.262
<b>Validated</b>	

The test result validated the continuity of power limiting in DSI scenario.

### 6.8. Switch in SAR exposure test results (test case 11 in Table 5-2)

This test was conducted with callbox requesting maximum power, and with the EUT in LTE Band 66 + Sub6 NR Band n71 call. Following procedure detailed in Section 3.3.7 and Section B.2, and using the Measurement setup shown in Figure B-1(d) since LTE and Sub6 NR are sharing the same antenna port, the SAR exposure switch measurement is performed with the EUT in various SAR exposure scenarios,

**Plot 1:** SAR<sub>sub6NR</sub> only scenario (t = 0s ~ 120s), SAR<sub>sub6NR</sub> + SAR<sub>LTE</sub> scenario (t =120s ~240s) and SAR<sub>LTE</sub> only scenario (t > 240s).

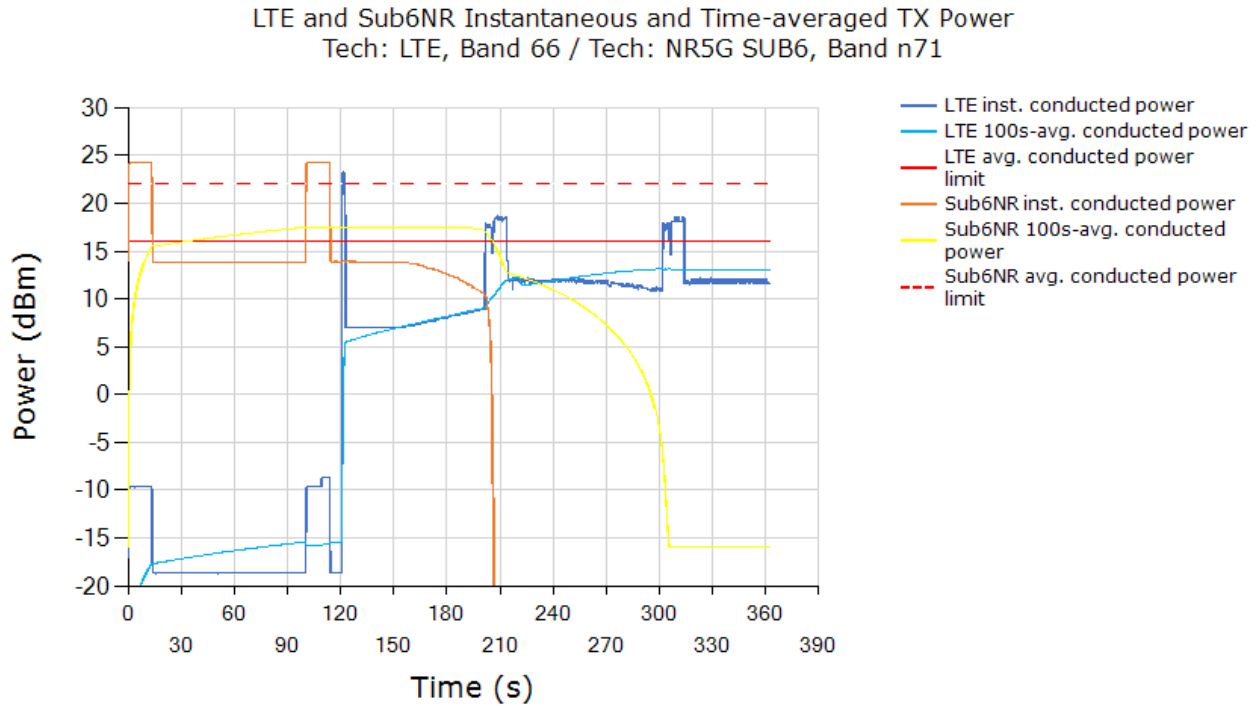

**Plot 2:** All the conducted Tx power measurement results were converted into time-averaged normalized SAR values using Equation (7a), (7b) and (7c), and plotted below to demonstrate that the time-averaged normalized SAR versus time does not exceed the FCC limit of 1.0 unit. Equation (7a) is used to convert the LTE Tx power of device to obtain 100s-averaged normalized SAR in LTE Band 66 as show in black curve. Similarly, equation (7b) is used to obtain 100s-averaged normalized SAR in Sub6 NR Band n71 as shown in orange curve. Equation (7c) is used to obtain total time-averaged normalized SAR as shown in green curve (i.e., sum of black and orange curves).

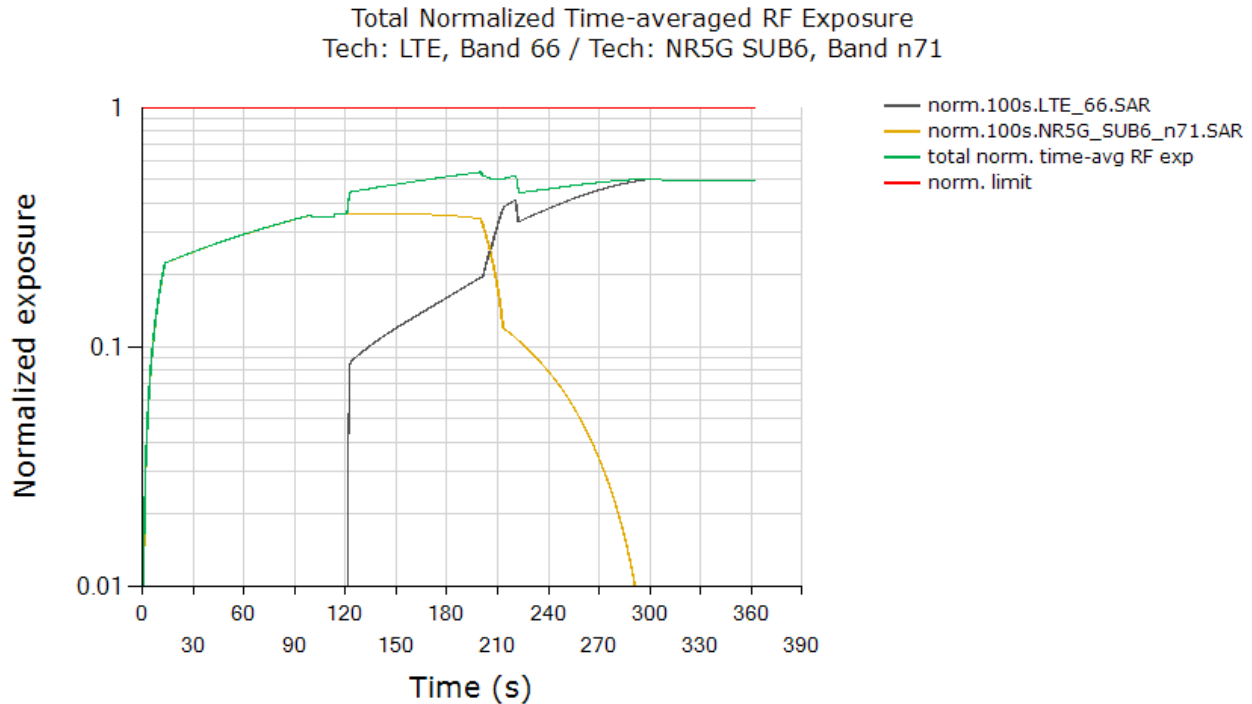

	(W/kg)
FCC normalized total exposure limit	1.0
Max 100s-time averaged normalized SAR (green curve)	0.538
Validated	

**Plot Notes:** Device starts predominantly in Sub6 NR SAR exposure scenario between 0s and 120s, and LTE SAR + Sub6 NR SAR exposure scenario between 120s and 240s, and in predominantly in LTE SAR exposure scenario after t=240s, Here, Smart Transmit allocates a maximum of 75% of exposure margin (based on 3 dB reserve margin setting) for Sub6 NR. This corresponds to a normalized 1gSAR exposure value =  $75\% \times 0.944 \text{ W/kg measured SAR at Sub6 NR } P_{limit} / 1.6 \text{ W/kg limit} = 0.443 \pm 1.0\text{dB}$  device related uncertainty (see orange curve between 10s~125s). For predominantly LTE SAR exposure scenario, maximum normalized 1gSAR exposure should correspond to 100% exposure margin =  $0.834 \text{ W/kg measured SAR at LTE } P_{limit} / 1.6 \text{ W/kg limit} = 0.521 \pm 1.0\text{dB}$  device related uncertainty (see orange black between after t = 240s). Additionally, in SAR exposure switch test, at all times the total time-averaged normalized RF exposure (green curve) should not exceed normalized  $SAR_{design\_target} + 1.0\text{dB}$  device uncertainty. In this test, with a maximum normalized SAR of 0.538 being  $\leq 0.79 (= 1.0/1.6 + 1.0\text{dB device uncertainty})$ , the above test result validated the continuity of power limiting in SAR exposure switch scenario.

## 7. SAR Test Results for Sub-6 Smart Transmit Feature Validation

### 7.1. Dielectric Property Measurements & System Check

Please detail of explain refer to Sec.8 in SAR part.1 report.

#### 7.1.1 Dielectric Property Measurements

Dielectric Property Measurements Results:

##### SAR 5 Room

Date	Freq. (MHz)	Liquid Parameters		Measured	Target	Delta (%)	Limit ±(%)	
5-13-2021	Head 835	e'	42.2700	Relative Permittivity ( $\epsilon_r$ ):	42.27	41.50	1.86	5
		e"	19.3000	Conductivity ( $\sigma$ ):	0.90	0.90	-0.44	5
	Head 820	e'	42.3300	Relative Permittivity ( $\epsilon_r$ ):	42.33	41.60	1.75	5
		e"	19.5900	Conductivity ( $\sigma$ ):	0.89	0.90	-0.59	5
	Head 850	e'	42.2300	Relative Permittivity ( $\epsilon_r$ ):	42.23	41.50	1.76	5
		e"	19.0500	Conductivity ( $\sigma$ ):	0.90	0.92	-1.60	5
5-16-2021	Head 835	e'	42.2700	Relative Permittivity ( $\epsilon_r$ ):	42.27	41.50	1.86	5
		e"	19.3000	Conductivity ( $\sigma$ ):	0.90	0.90	-0.44	5
	Head 820	e'	42.3300	Relative Permittivity ( $\epsilon_r$ ):	42.33	41.60	1.75	5
		e"	19.5900	Conductivity ( $\sigma$ ):	0.89	0.90	-0.59	5
	Head 850	e'	42.2300	Relative Permittivity ( $\epsilon_r$ ):	42.23	41.50	1.76	5
		e"	19.0500	Conductivity ( $\sigma$ ):	0.90	0.92	-1.60	5
5-17-2021	Head 1900	e'	39.1600	Relative Permittivity ( $\epsilon_r$ ):	39.16	40.00	-2.10	5
		e"	13.6100	Conductivity ( $\sigma$ ):	1.44	1.40	2.70	5
	Head 1850	e'	39.2000	Relative Permittivity ( $\epsilon_r$ ):	39.20	40.00	-2.00	5
		e"	13.6900	Conductivity ( $\sigma$ ):	1.41	1.40	0.59	5
	Head 1910	e'	39.1500	Relative Permittivity ( $\epsilon_r$ ):	39.15	40.00	-2.13	5
		e"	13.6000	Conductivity ( $\sigma$ ):	1.44	1.40	3.17	5
5-17-2021	Head 2600	e'	38.0100	Relative Permittivity ( $\epsilon_r$ ):	38.01	39.01	-2.57	5
		e"	13.4400	Conductivity ( $\sigma$ ):	1.94	1.96	-0.98	5
	Head 2500	e'	38.1800	Relative Permittivity ( $\epsilon_r$ ):	38.18	39.14	-2.45	5
		e"	13.4200	Conductivity ( $\sigma$ ):	1.87	1.85	0.62	5
	Head 2700	e'	37.8400	Relative Permittivity ( $\epsilon_r$ ):	37.84	38.88	-2.69	5
		e"	13.4800	Conductivity ( $\sigma$ ):	2.02	2.07	-2.25	5
5-24-2021	Head 3600	e'	39.6500	Relative Permittivity ( $\epsilon_r$ ):	39.65	37.82	4.85	5
		e"	14.6900	Conductivity ( $\sigma$ ):	2.94	3.01	-2.43	5
	Head 3650	e'	39.5600	Relative Permittivity ( $\epsilon_r$ ):	39.56	37.76	4.77	5
		e"	14.7500	Conductivity ( $\sigma$ ):	2.99	3.07	-2.33	5
	Head 3700	e'	38.4900	Relative Permittivity ( $\epsilon_r$ ):	38.49	37.70	2.09	5
		e"	14.7800	Conductivity ( $\sigma$ ):	3.04	3.12	-2.42	5
	Head 3750	e'	39.4200	Relative Permittivity ( $\epsilon_r$ ):	39.42	37.64	4.72	5
		e"	14.8300	Conductivity ( $\sigma$ ):	3.09	3.17	-2.37	5
	Head 3800	e'	39.3500	Relative Permittivity ( $\epsilon_r$ ):	39.35	37.59	4.69	5
		e"	14.8700	Conductivity ( $\sigma$ ):	3.14	3.22	-2.38	5

## 7.1.2 SAR system check

### Reference Target SAR Values

The reference SAR values can be obtained from the calibration certificate of system validation dipoles.

System Dipole	Serial No.	Cal. Date	Freq. (MHz)	Target SAR Values (W/kg)	
				1g/10g	Head
D835V2	4d174	2021-03-17	835	1g	9.70
				10g	6.29
D1900V2	5d199	2020-03-19	1900	1g	40.50
				10g	21.00
D2600V2	1097	2019-09-19	2600	1g	57.30
				10g	25.70
D3700V2	1026	2020-09-18	3700	1g	67.10
				10g	24.30

### System Check Results

The 1-g and 10-g SAR measured with a reference dipole, using the required tissue-equivalent medium at the test frequency, must be within 10% of the manufacturer calibrated dipole SAR target.

### SAR 5 Room

Date Tested	System Dipole		T.S. Liquid	Measured Results		Target (Ref. Value)	Delta $\pm 10\%$	Plot No.	
	Type	Serial #		Zoom Scan to 100 mW	Normalize to 1 W				
5-13-2021	D835V2	4d174	Head	1g	0.93	9.3	9.70	-4.64	1
				10g	0.60	6.0	6.29	-4.29	
5-16-2021	D835V2	4d174	Head	1g	0.90	9.0	9.70	-6.80	2
				10g	0.59	5.9	6.29	-6.52	
5-17-2021	D1900V2	5d199	Head	1g	4.12	41.2	40.50	1.73	3
				10g	2.13	21.3	21.00	1.43	
5-17-2021	D2600V2	1097	Head	1g	5.40	54.0	57.30	-5.76	4
				10g	2.42	24.2	25.70	-5.84	
5-24-2021	D3700V2	1026	Head	1g	6.99	69.9	67.10	4.17	5
				10g	2.60	26.0	24.30	7.00	

## 7.2. Measurement setup

This measurement setup is similar to normal SAR measurements. The difference in SAR measurement setup for time averaging feature validation is that the callbox is signaling in close loop power control mode (instead of requesting maximum power in open loop control mode) and callbox is connected to the PC using GPIB so that the test script executed on PC can send GPIB commands to control the callbox's requested power over time (test sequence). The same test script used in conducted setup for time-varying Tx power measurements is also used in this section for running the test sequences during SAR measurements, and the recorded values from the disconnected power meter by the test script were discarded.

As mentioned in Section 3.4, for EUT to follow TPC command sent from the callbox wirelessly, the "path loss" between callbox antenna and the EUT needs to be very well calibrated. Since the SAR chamber is in uncontrolled environment, precautions must be taken to minimize the environmental influences on "path loss". Similarly, in the case of time-varying SAR measurements in Sub6 NR (with LTE as anchor), "path loss" between callbox antenna and the EUT needs to be carefully calibrated for both LTE link as well as for Sub6 NR link.

The EUT is placed in Worst-case position against flat section of SAM Twin phantom as shown in A.7 & A.8 in Appendix A.

### 7.3. SAR measurement results for time-varying Tx power transmission scenario

Following Section 3.4 procedure, time-averaged SAR measurements are conducted using EX3DV4 probe at peak location of area scan over 500 seconds. cDASY6 system validation for SAR measurement is provided in Section 7.1, and the associated SPEAG certificates are attached in Appendix E(Probes) & F(Dipoles) in SAR part 1 report. SAR probe integration times depend on the communication signal being tested. Integration times used by SPEAG for their probe calibrations can be downloaded from here (integration time is listed on the bottom of the first page for each tech):

[http://www.speag.com/assets/downloads/servces/cs/UIDSummary\\_171205.pdf](http://www.speag.com/assets/downloads/servces/cs/UIDSummary_171205.pdf)

Since the sampling rate used by cDASY6 for pointSAR measurements is not in user control, the number of points in 100s or 60s interval is determined from the scan duration setting in cDASY6 time-average pointSAR measurement by (100s or 60s / cDASY6\_scan\_duration \* total number of pointSAR values recorded). Running average is performed over these number of points in excel spreadsheet to obtain 100s-/60s-averaged pointSAR.

Following Section 3.4, for each of selected technology/band (listed in Table 5-2):

1. With *Reserve\_power\_margin* set to 0 dB, area scan is performed at  $P_{limit}$  and time-averaged pointSAR measurements are conducted to determine the pointSAR at  $P_{limit}$  at peak location, denoted as  $pointSAR_{P_{limit}}$ .
2. With *Reserve\_power\_margin* set to actual (intended) value, two more time-averaged pointSAR measurements are performed at the same peak location for test sequences 1 and 2. To demonstrate compliance, all the pointSAR measurement results were converted into 1gSAR or 10gSAR values by using Equation (3a), rewritten below:

$$1g\_or\_10gSAR(t) = \frac{pointSAR(t)}{pointSAR_{P_{limit}}} * 1g\_or\_10gSAR_{P_{limit}} \quad (3a)$$

Where,  $pointSAR(t)$ ,  $pointSAR_{P_{limit}}$ , and  $1g\_or\_10gSAR_{P_{limit}}$  correspond to the measured instantaneous point SAR, measured point SAR at  $P_{limit}$  from above step 1 and 2, and measured 1gSAR or 10gSAR values at  $P_{limit}$  obtained from Part 1 report and listed in Table 5-2 in Section 5.1 of this report.

### 7.3.1 WCDMA Band II

#### Test result for test sequence 1:

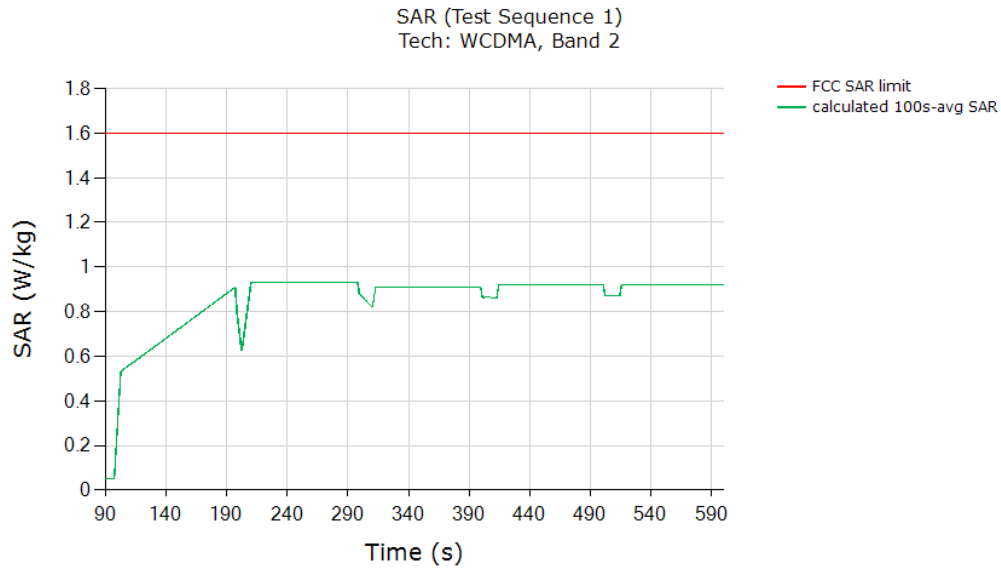

#### Test result for test sequence 2:

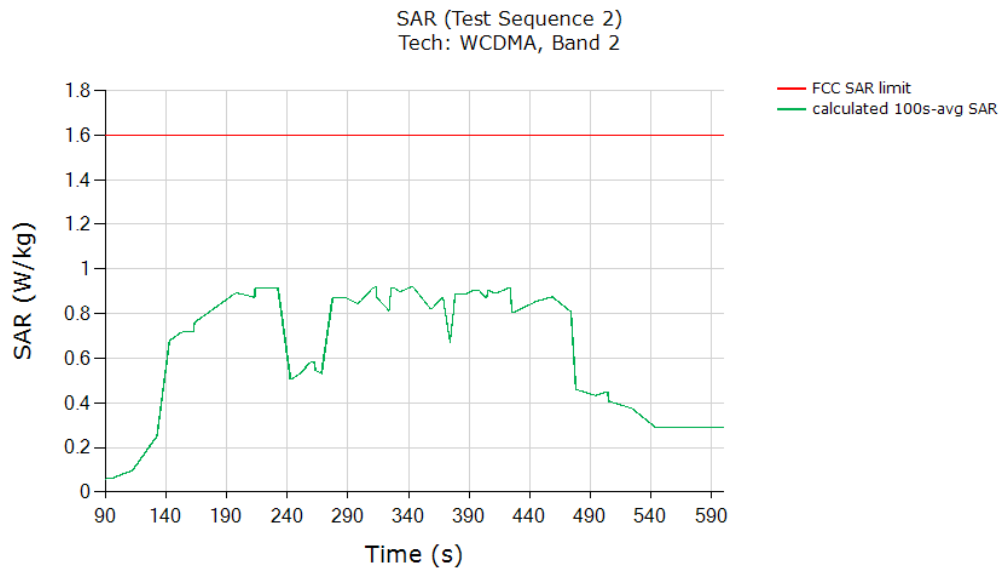

	Test sequence 1	Test sequence 2
	(W/kg)	(W/kg)
FCC 1gSAR limit	1.6	1.6
Max 100s-time averaged 1gSAR (green curve)	0.931	0.921
Validated : Max time averaged SAR (green curve) is within 1 dB device uncertainty of measured SAR at $P_{limit}$ (Table 5-2).		



### 7.3.2 WCDMA Band V

#### Test result for test sequence 1:

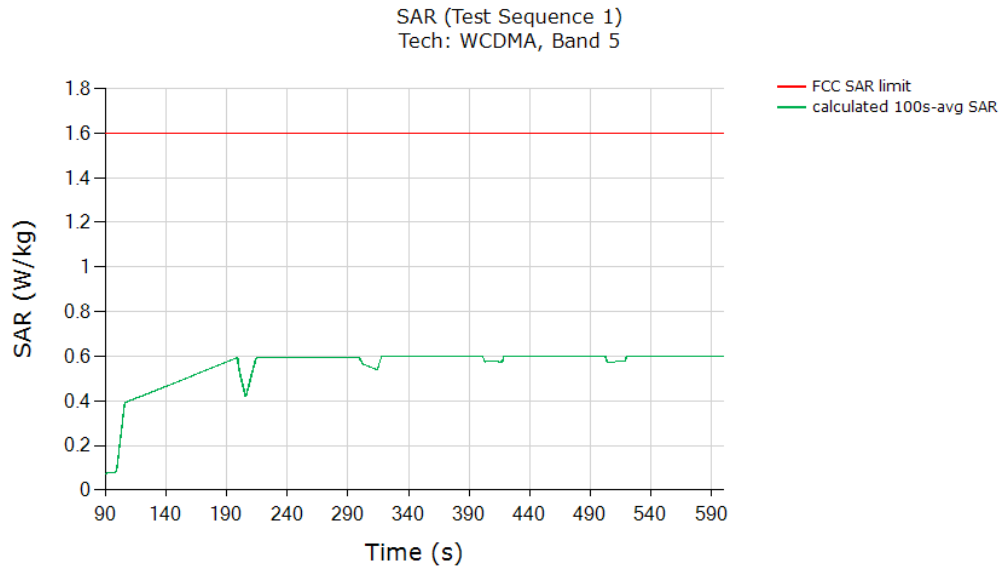

#### Test result for test sequence 2:

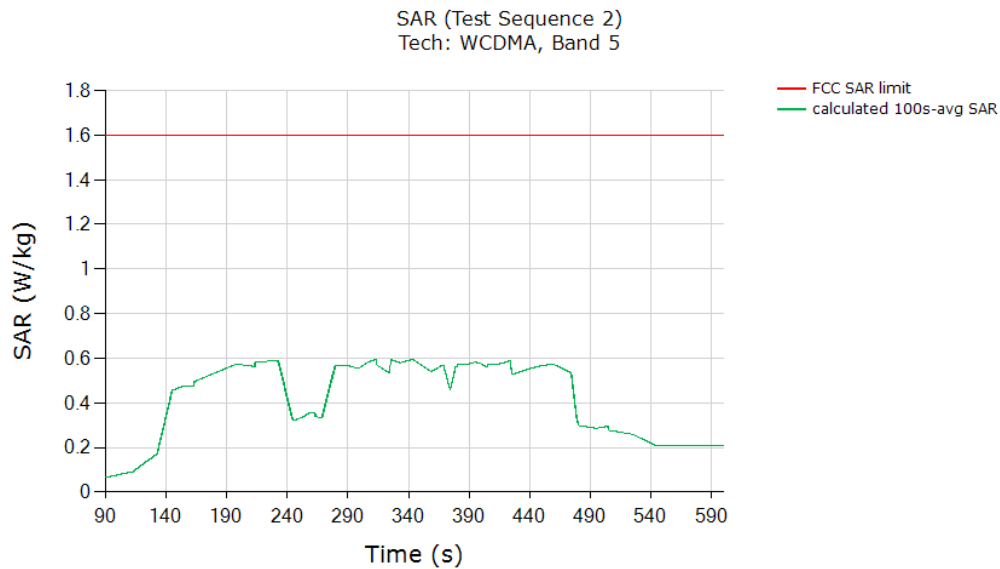

	Test sequence 1	Test sequence 2
	(W/kg)	(W/kg)
FCC 1gSAR limit	1.6	1.6
Max 100s-time averaged 1gSAR (green curve)	0.600	0.594
Validated : Max time averaged SAR (green curve) is within 1 dB device uncertainty of measured SAR at $P_{limit}$ (Table 5-2).		

### 7.3.3 LTE Band 26

#### Test result for test sequence 1:

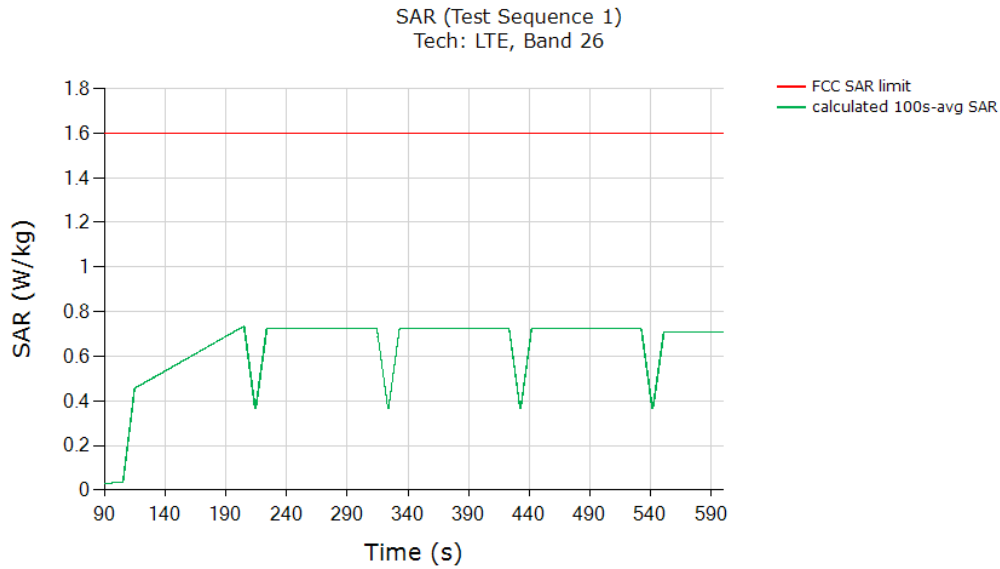

#### Test result for test sequence 2:

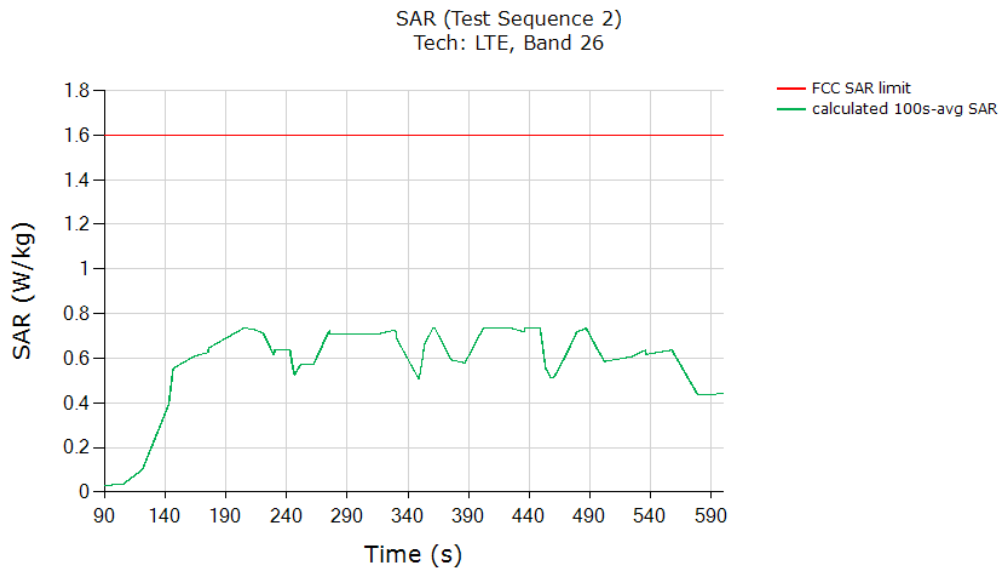

	Test sequence 1	Test sequence 2
	(W/kg)	(W/kg)
FCC 1gSAR limit	1.6	1.6
Max 100s-time averaged 1gSAR (green curve)	0.735	0.736
Validated : Max time averaged SAR (green curve) is within 1 dB device uncertainty of measured SAR at $P_{limit}$ (Table 5-2).		

### 7.3.4 LTE Band 7

#### Test result for test sequence 1:

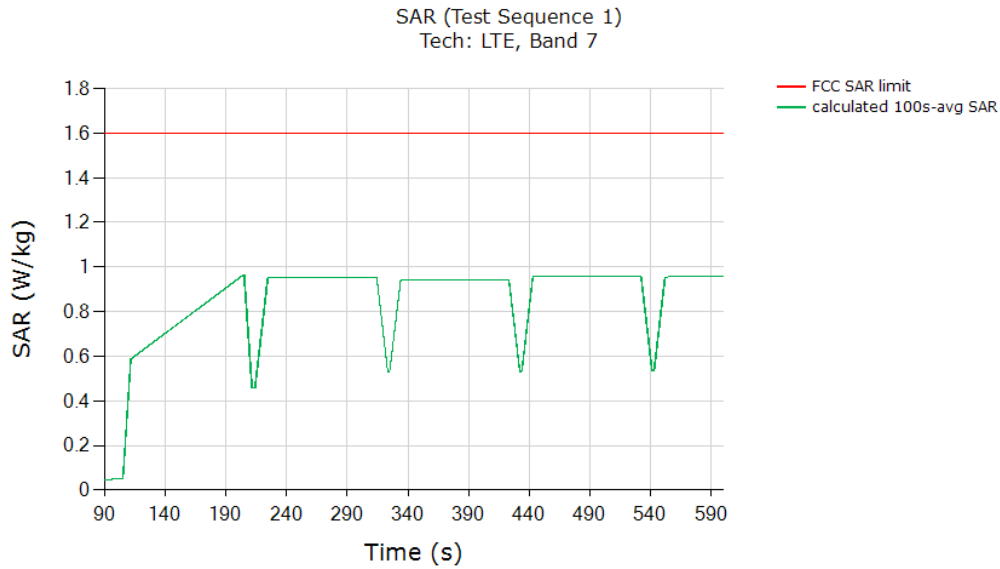

#### Test result for test sequence 2:

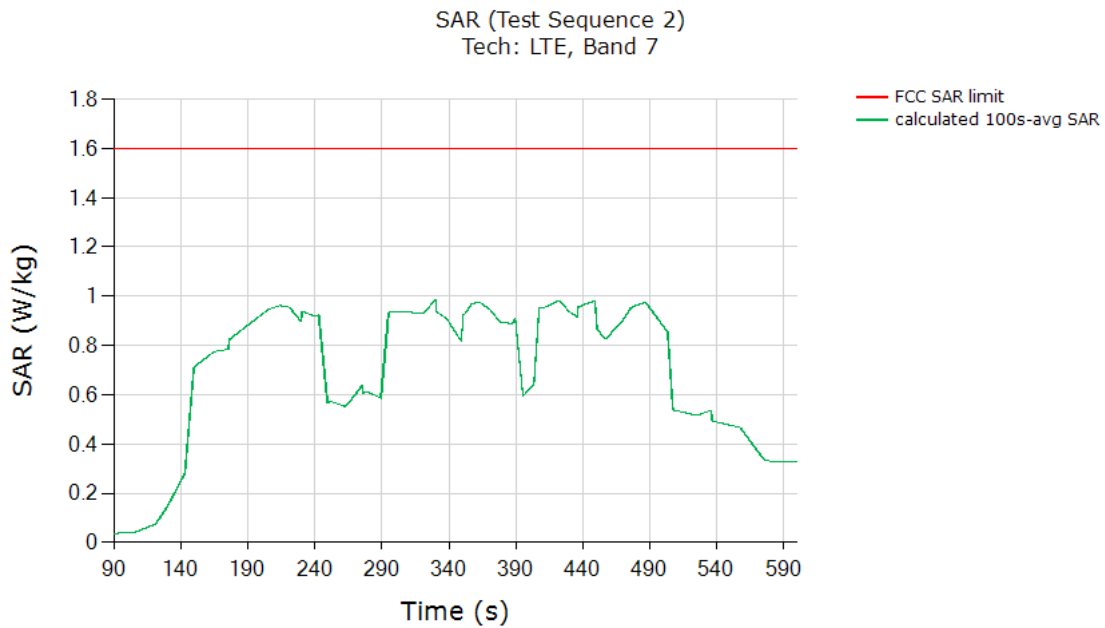

	Test sequence 1	Test sequence 2
	(W/kg)	(W/kg)
FCC 1gSAR limit	1.6	1.6
Max 100s-time averaged 1gSAR (green curve)	0.966	0.985
Validated : Max time averaged SAR (green curve) is within 1 dB device uncertainty of measured SAR at $P_{limit}$ (Table 5-2).		

### 7.3.5 NR Band n5

#### Test result for test sequence 1:

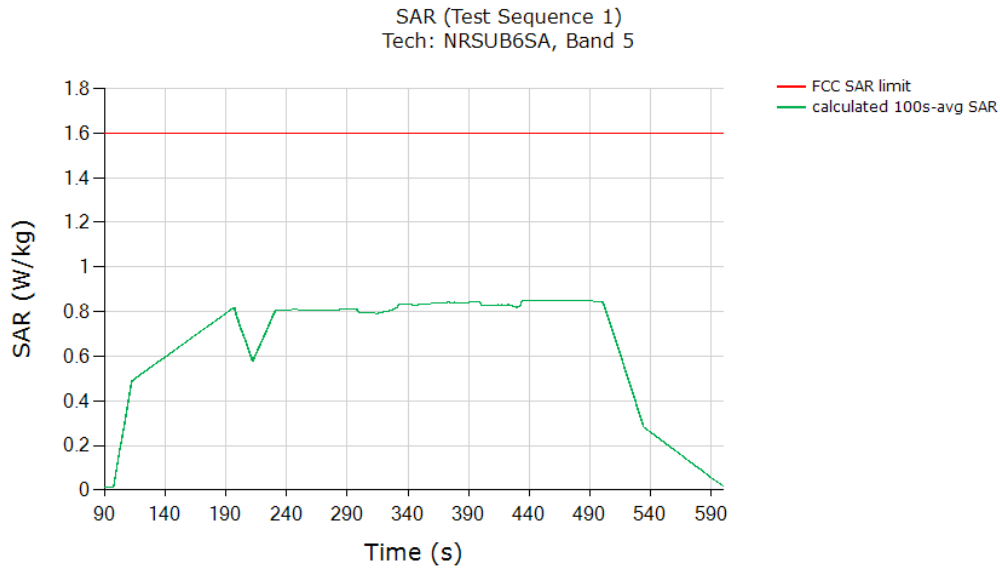

#### Test result for test sequence 2:

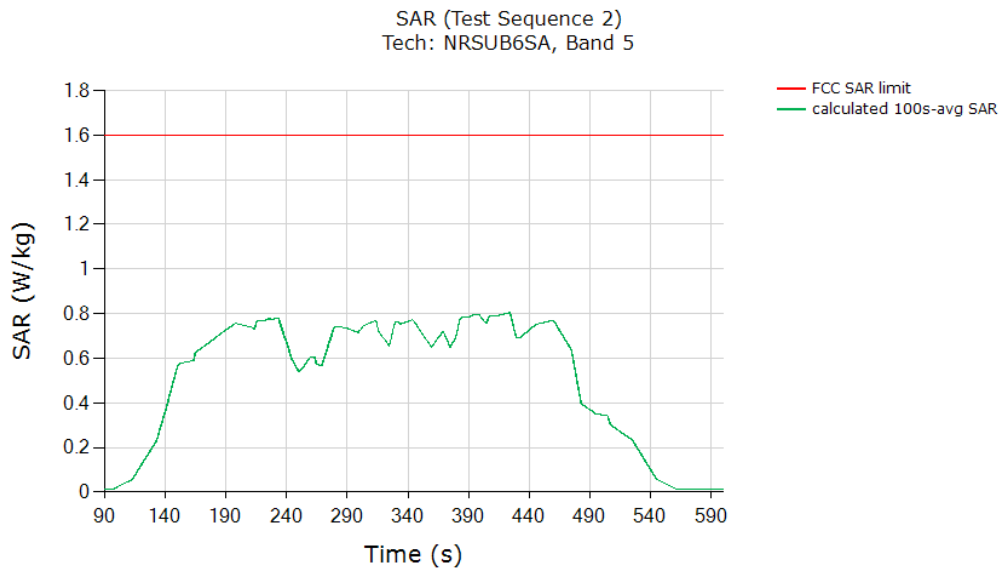

	Test sequence 1	Test sequence 2
	(W/kg)	(W/kg)
FCC 1gSAR limit	1.6	1.6
Max 100s-time averaged 1gSAR (green curve)	0.852	0.804
<b>Validated</b> : Max time averaged SAR (green curve) is within 1 dB device uncertainty of measured SAR at $P_{limit}$ (Table 5-2).		

### 7.3.6 NR Band n77

#### Test result for test sequence 1:

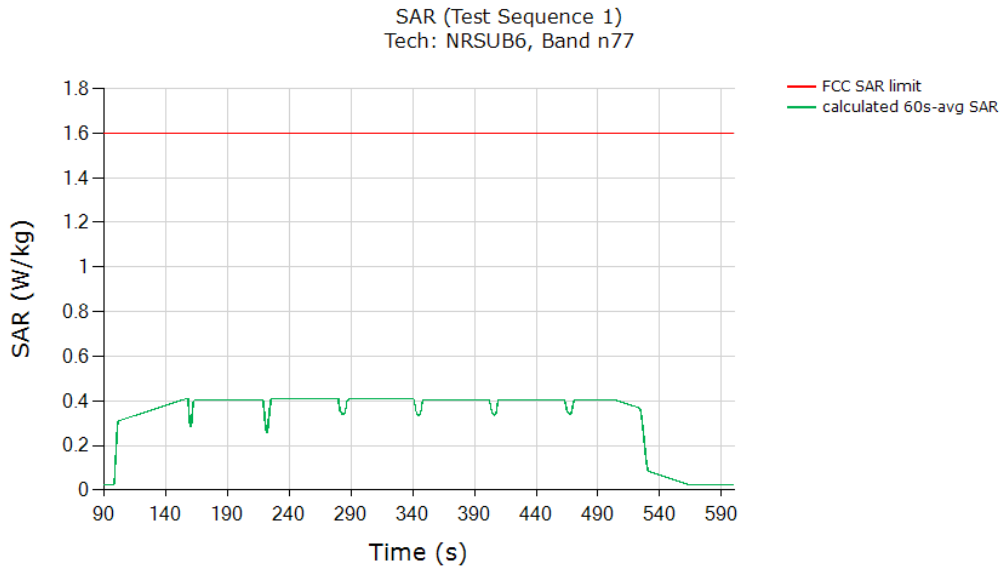

#### Test result for test sequence 2:

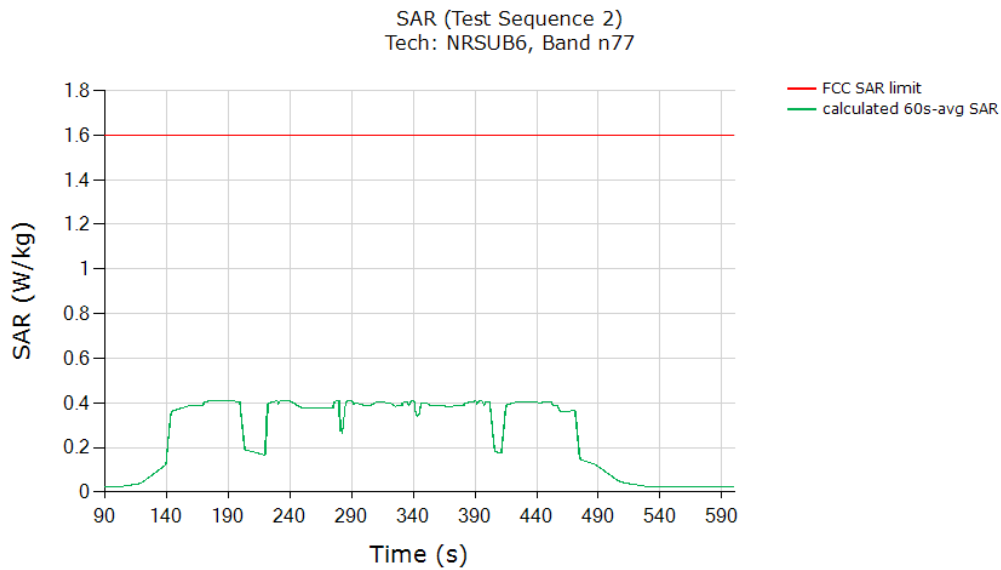

	Test sequence 1	Test sequence 2
	(W/kg)	(W/kg)
FCC 1gSAR limit	1.6	1.6
Max 60s-time averaged 1gSAR (green curve)	0.412	0.411
Validated : Max time averaged SAR (green curve) is within 1 dB device uncertainty of measured SAR at $P_{limit}$ (Table 5-2).		

## 8. Radiated Power Test Results for mmW Smart Transmit Feature Validation

### 8.1. Measurement setup

The Keysight Technologies E7515B UXM callbox is used in this test. The schematic of the setup is shown in Figure C-1 (A.10 in Appendix A). The UXM callbox has two RF radio heads to up/down convert IF to mmW frequencies, which in turn are connected to two horn antennas for V- and H-polarizations for downlink communication. In the uplink, a directional coupler is used in the path of one of the horn antennas to measure and record radiated power using a Rohde & Schwarz NR50S power sensor and NRP2 power meter. Note here that the isolation of the directional coupler may not be sufficient to attenuate the downlink signal from the callbox, which will result in high noise floor making the recording of radiated power from EUT. In that case, either lower the downlink signal strength emanating from the RF radio heads of callbox or add an attenuator between callbox radio heads and directional coupler. Additionally, note that since the measurements performed in this validation are all relative, measurement of EUT's radiated power in one polarization is sufficient. The EUT is placed inside an anechoic chamber with V- and H-pol horn antennas to establish the radio link as shown in Figure C-1. The callbox's LTE port is directly connected to the EUT's RF port via a directional coupler to measure the EUT's conducted Tx power using a Rohde & Schwarz NRP50S power sensor and NRP2 power meter. Additionally, EUT is connected to the PC via USB connection for sending beam switch command. Care is taken to route the USB cable and RF cable (for LTE connection) away from the EUT's mmW antenna modules.

Setup in Figure C-1 is used for the test scenario 1, 5 and 8 described in Section 2. The test procedures described in Section 4 are followed. The path losses from the EUT to both the power meters are calibrated and used as offset in the power meter.

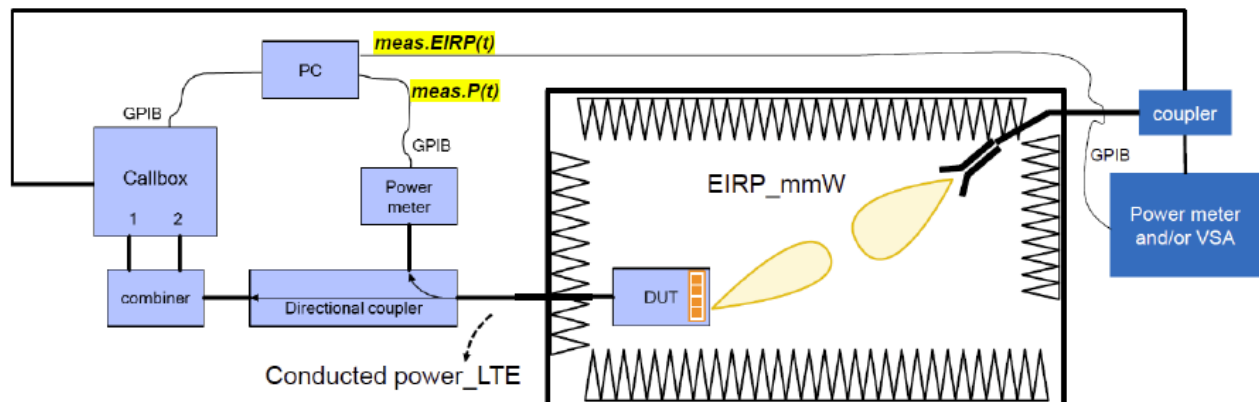

**Figure C-1 mmW NR radiated power measurement setup**

Both the callbox and power meters are connected to the PC using USB cables. Test scripts are custom made for automation of establishing LTE + mmW call, conducted Tx power recording for LTE and radiated Tx power recording for mmW. These tests are manually stopped after desired time duration. Test script is programmed to set LTE Tx power to all-down bits on the callbox immediately after the mmW link is established, and programmed to set toggle between all-up and all-down bits depending on the transmission scenario being evaluated. Similarly, test script is also programmed to send beam switch command manually to the EUT via USB connection. For all the tests, the callbox is set to request maximum Tx power in mmW NR radio from EUT all the time.

Test configurations for this validation are detailed in Section 5.2. Test procedures are listed in Section 4.3.

## 8.2. mmW NR radiated power test results

To demonstrate the compliance, the connected Tx power of LTE Band 5 in DSI = 1 is converted to 1gSAR exposure by applying the corresponding worst-case 1gSAR value at  $P_{limit}$  as reported in Part 1 report and listed in Table 5-2 of this report.

Similarly, following Step 4 in Section 4.3.1, radiated Tx power of mmW Bane n261 and n260 for the beams tested is converted by applying the corresponding worst-case 4cm<sup>2</sup>PD values measured in UL lab, and listed in below Table 8-1. The measured EIRP at *input.power.limit* for the beams tested in this section are also listed in Table 8-1. Qualcomm Smart Transmit feature operates based on time-averaged Tx power reported on a per symbol basis, which is independent of modulation, channel and bandwidth (RBs), therefore the worst-case 4cm<sup>2</sup>PD was conducted with the EUT in FTM mode, with CW modulation and 100% duty cycle.

Both the worst-case 1gSAR and 4cm<sup>2</sup>PD values used in this section are listed in Table 8-1. The measured EIRP at *input.power.limit* for the beams tested in this section are also listed in Table 8-1.

**Table 8-1: EIRP measured at *input.power.limit* for the selected configurations**

Test Case	Test Scenario	Antenna	mmW Band	mmW Beam ID	input.power.limit (dBm)	Configuratrion	Meas. 4cm2PD at input.power.limit (W/m^2)	Meas. EIRP at input.power.limit (dBm)
1	Max.Power Test	K-patch	n261	Beam ID 18	2.2	Rear	3.31	8.1
2	SAR vs. PD Switch			Beam ID 18	2.2	Rear	3.31	8.1
3	Beam Switch			Beam ID 18	2.2	Rear	3.31	8.1
				Beam ID 146	2.3	Rear	4.19	1.8
4	Max.Power Test	K-patch	n260	Beam ID 26	5.2	Rear	3.81	8.6
5	SAR vs. PD Switch			Beam ID 26	5.2	Rear	3.81	8.6
6	Beam Switch			Beam ID 20	5.4	Rear	3.66	8.0
				Beam ID 148	4.9	Rear	3.23	5.2

Tech	Antenna	Band	DSI	Configuration	meas. Plimit (dBm)	meas 1g SAR at Plimit (W/kg)
LTE Anchor	Main.1	5	1	Edge 4	15.4	0.789

The 4cm<sup>2</sup>-averaged PD distributions for the highest PD value per band, as listed in Table 8-1, are plotted below:

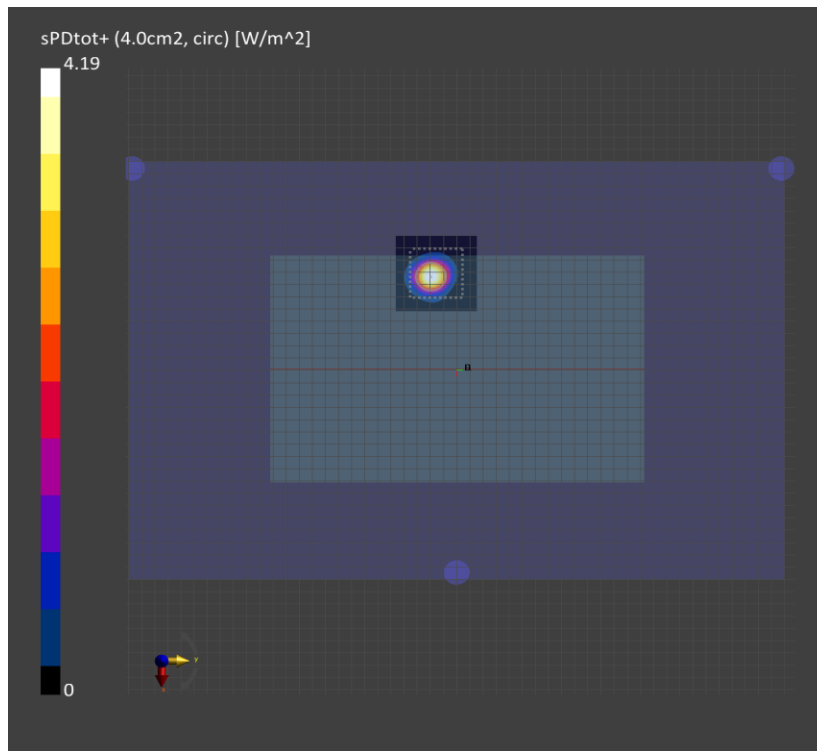

Figure C-2 4cm<sup>2</sup>-averaged power density distribution measured at *input.power.limit* of 2.3dBm on the Rear Surface n261 beam ID 146.

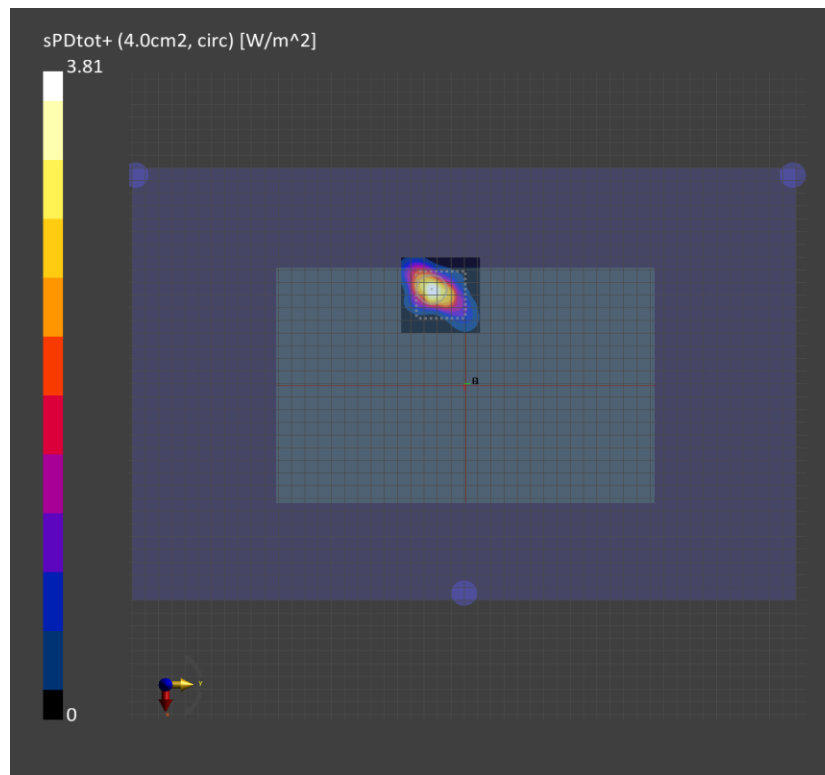

Figure C-3 4cm<sup>2</sup>-averaged power density distribution measured at *input.power.limit* of 5.2dBm on the Rear Surface n260 beam ID 26.



### 8.2.1 Maximum Tx power test results for n261

This test was measured with LTE Band 5 and mmW band n261 Beam ID 18, by following the detailed test procedure described in Section 4.3.1.

Instantaneous and 100s-averaged conducted LTE Tx power versus time, instantaneous and 4s-averaged radiated mmW Tx power versus time, time-averaged conducted LTE Tx power limit and time-averaged radiated mmW Tx power limit:

**Plot 1:**

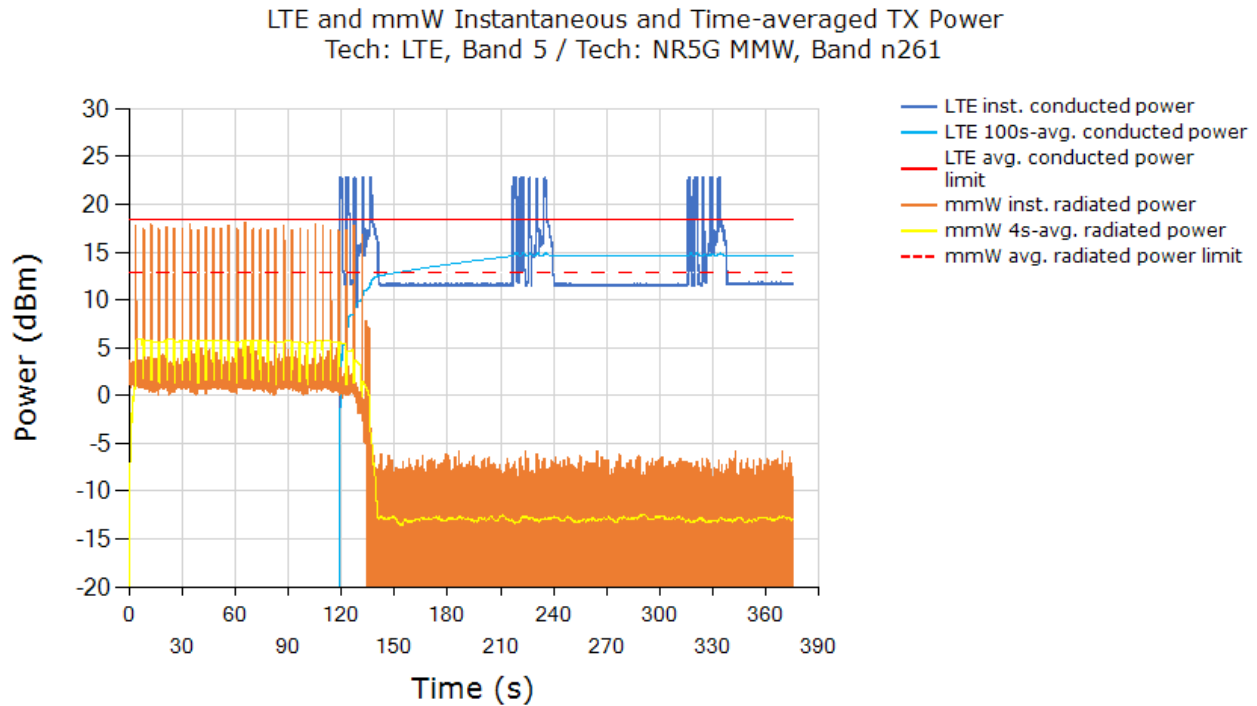

**Plot 1**'s time-averaged conducted Tx power for LTE Band 2 and radiated Tx power for mmW Band n261 Beam ID 29 are converted into time-averaged 1gSAR and time-averaged 4cm<sup>2</sup>PD using Equation (2a) and (2b), which are divided by FCC 1gSAR limit 1.6 W/kg and 4cm<sup>2</sup>PD limit of 10 W/m<sup>2</sup>, respectively, to obtain normalized exposures versus time. **Plot 2** shows (a) normalized time-averaged 1gSAR versus time, (b) normalized time-averaged 4cm<sup>2</sup>-avg.PD versus time, (c) sum of normalized time-averaged 1gSAR and normalized time-averaged 4cm<sup>2</sup>-avg.PD:

**Plot 2:**

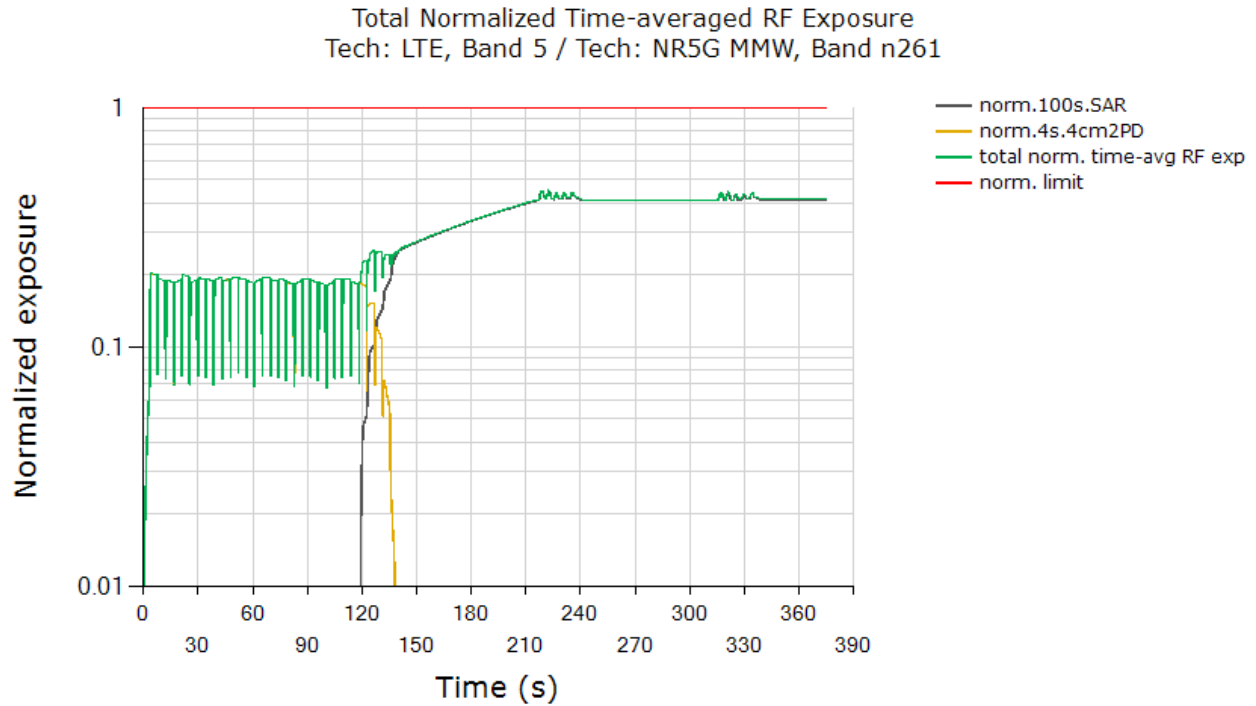

FCC requirement for total RF exposure (normalized)	1.0
Max total normalized time-averaged RF exposure (green curve)	0.453
Validated	

**Plot notes:** As soon as 5G mmW NR call was established, LTE was placed in all-down bits immediately. Between 0s ~ 120s, mmW exposure is the dominant contributor. Here, Smart Transmit feature allocates a maximum of 75% for mmW (based on the 3dB reserve setting in Part 1 report). From Table 8-1, this corresponds to a normalized 4cm<sup>2</sup>PD exposure value for Beam ID 18 of  $(75\% * 3.31 \text{ W/m}^2)/(10 \text{ W/m}^2) = 24.8\% \pm 2.1\text{dB}$  device related uncertainty (See green/orange curve between 0s ~ 120s). At ~120s time mark, LTE is set to all-up bits, taking away margin from mmW exposure gradually. Towards the end of test, LTE is the dominant contributor towards RF exposure, i.e., corresponding normalized 1gSAR exposure value of  $(100\% * 0.789 \text{ W/kg})/(1.6 \text{ W/kg}) = 49.3\% \pm 1.0\text{dB}$  design related uncertainty (See black curve approaching this level toward end of the test).

As can be seen, the power limiting enforcement is effective and the total normalized time-averaged RF exposure does not exceed 1.0. Therefore, Qualcomm Smart Transmit time averaging feature is validated.

### 8.2.2 Maximum Tx power test results for n260

This test was measured with LTE Band 5 and mmW band n260 Beam ID 26, by following the detailed test procedure described in Section 4.3.1.

Instantaneous and 100s-averaged conducted LTE Tx power versus time, instantaneous and 4s-averaged radiated mmW Tx power versus time, time-averaged conducted LTE Tx power limit and time-averaged radiated mmW Tx power limit:

**Plot 1:**

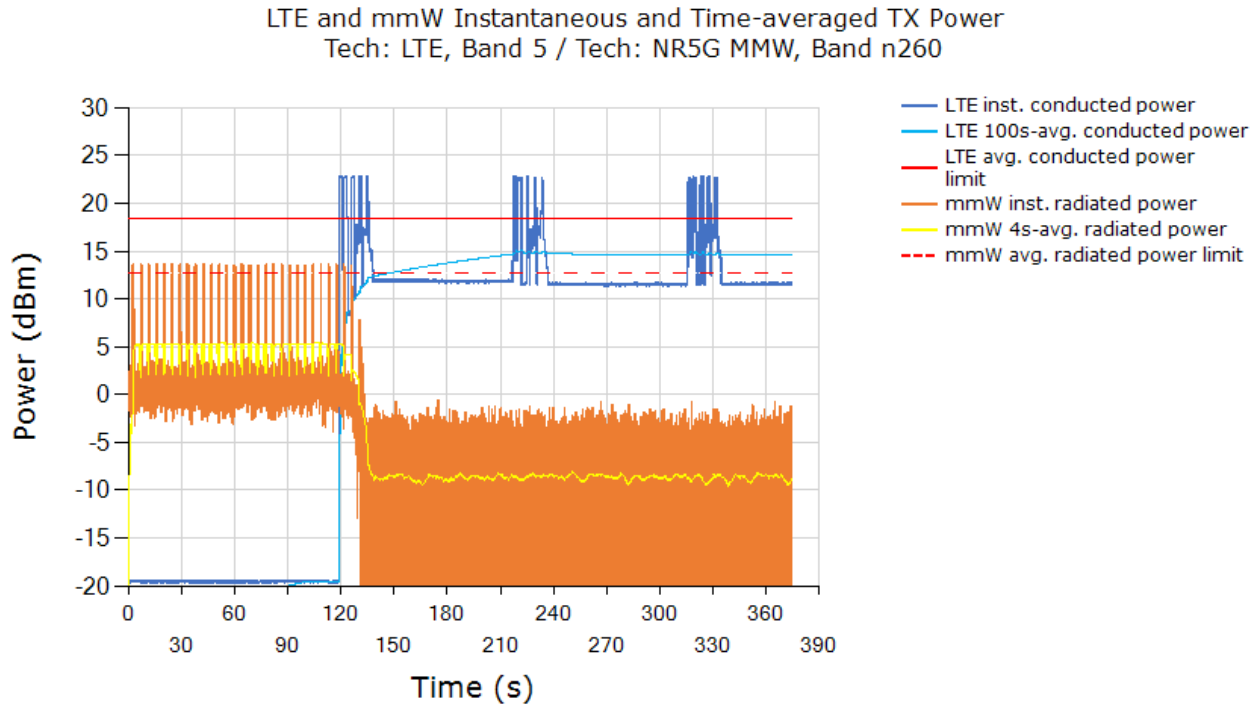

**Plot 1's** time-averaged conducted Tx power for LTE Band 2 and radiated Tx power for mmW Band n260 Beam ID 29 are converted into time-averaged 1gSAR and time-averaged 4cm<sup>2</sup>PD using Equation (2a) and (2b), which are divided by FCC 1gSAR limit 1.6 W/kg and 4cm<sup>2</sup>PD limit of 10 W/m<sup>2</sup>, respectively, to obtain normalized exposures versus time. **Plot 2** shows (a) normalized time-averaged 1gSAR versus time, (b) normalized time-averaged 4cm<sup>2</sup>-avg.PD versus time, (c) sum of normalized time-averaged 1gSAR and normalized time-averaged 4cm<sup>2</sup>-avg.PD:

**Plot 2:**

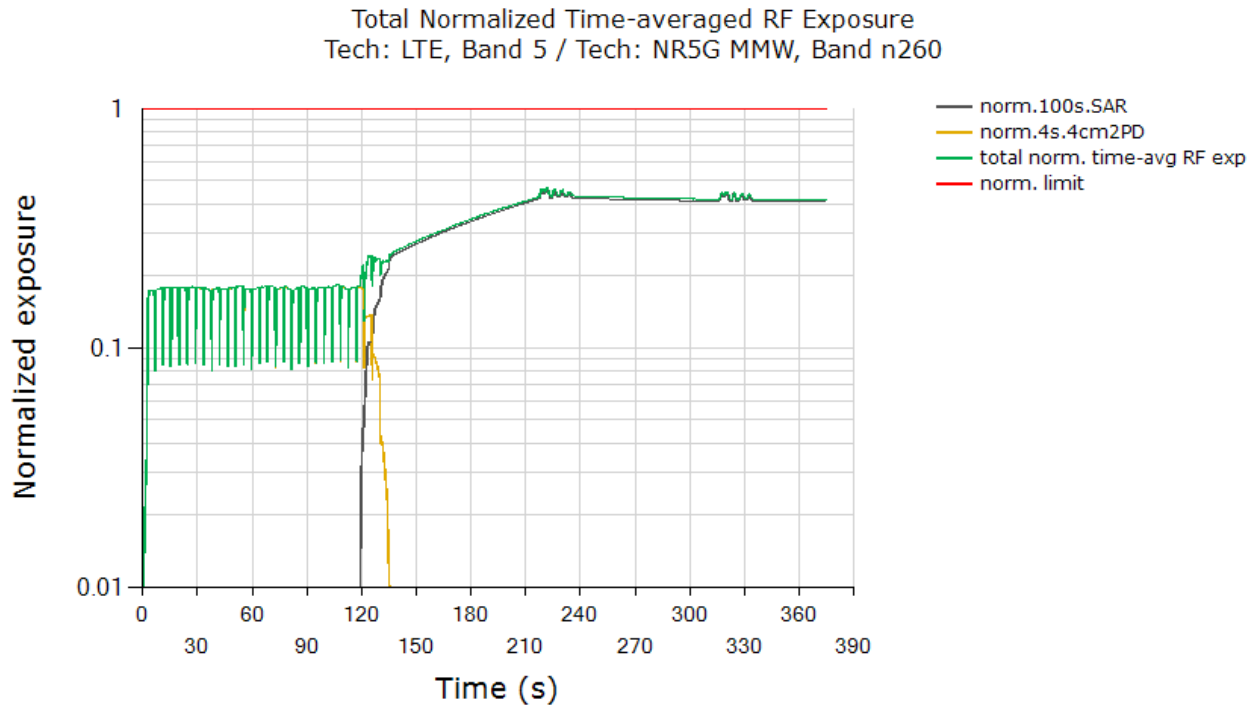

FCC requirement for total RF exposure (normalized)	1.0
Max total normalized time-averaged RF exposure (green curve)	0.466
Validated	

**Plot notes:** As soon as 5G mmW NR call was established, LTE was placed in all-down bits immediately. Between 0s ~ 120s, mmW exposure is the dominant contributor. Here, Smart Transmit feature allocates a maximum of 75% for mmW (based on the 3dB reserve setting in Part 1 report). From Table 8-1, this corresponds to a normalized 4cm<sup>2</sup>PD exposure value for Beam ID 26 of  $(75\% * 3.81 \text{ W/m}^2)/(10 \text{ W/m}^2) = 28.6\% \pm 2.1\text{dB}$  device related uncertainty (See green/orange curve between 0s ~ 120s). At ~120s time mark, LTE is set to all-up bits, taking away margin from mmW exposure gradually. Towards the end of test, LTE is the dominant contributor towards RF exposure, i.e., corresponding normalized 1gSAR exposure value of  $(100\% * 0.789 \text{ W/kg})/(1.6 \text{ W/kg}) = 49.3\% \pm 1.0\text{dB}$  design related uncertainty (See black curve approaching this level toward end of the test).

As can be seen, the power limiting enforcement is effective and the total normalized time-averaged RF exposure does not exceed 1.0. Therefore, Qualcomm Smart Transmit time averaging feature is validated.

### 8.2.3 Switch in SAR vs. PD exposure test results for n261

This test was measured with LTE Band 5 (DSI = 1) and mmW band n261 Beam ID 18, by following the detailed test procedure is described in Section 4.3.2.

Instantaneous and 100s-averaged conducted LTE Tx power versus time, instantaneous and 4s-averaged radiated mmW Tx power versus time, time-averaged conducted LTE Tx power limit and time-averaged radiated mmW Tx power limit:

**Plot 1:**

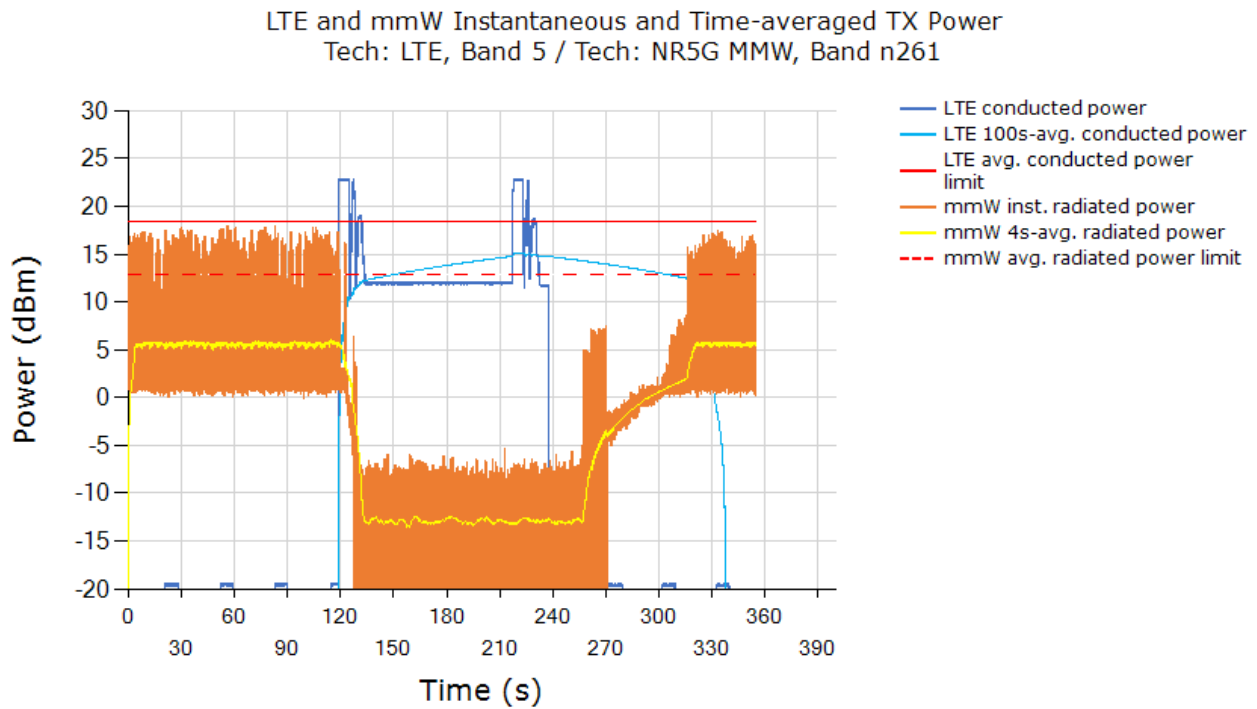

From **Plot 1**, it is predominantly instantaneous PD exposure between 0s ~ 120s, it is instantaneous SAR + PD exposure between 120s ~ 140s, it is predominantly instantaneous SAR exposure between 140s ~ 200s, and above 200s, it is predominantly instantaneous PD exposure.

**Plot 2:** Normalized time-averaged exposure for LTE (1gSAR) and mmW (4cm<sup>2</sup>PD), as well as total normalized time-averaged exposure versus time:

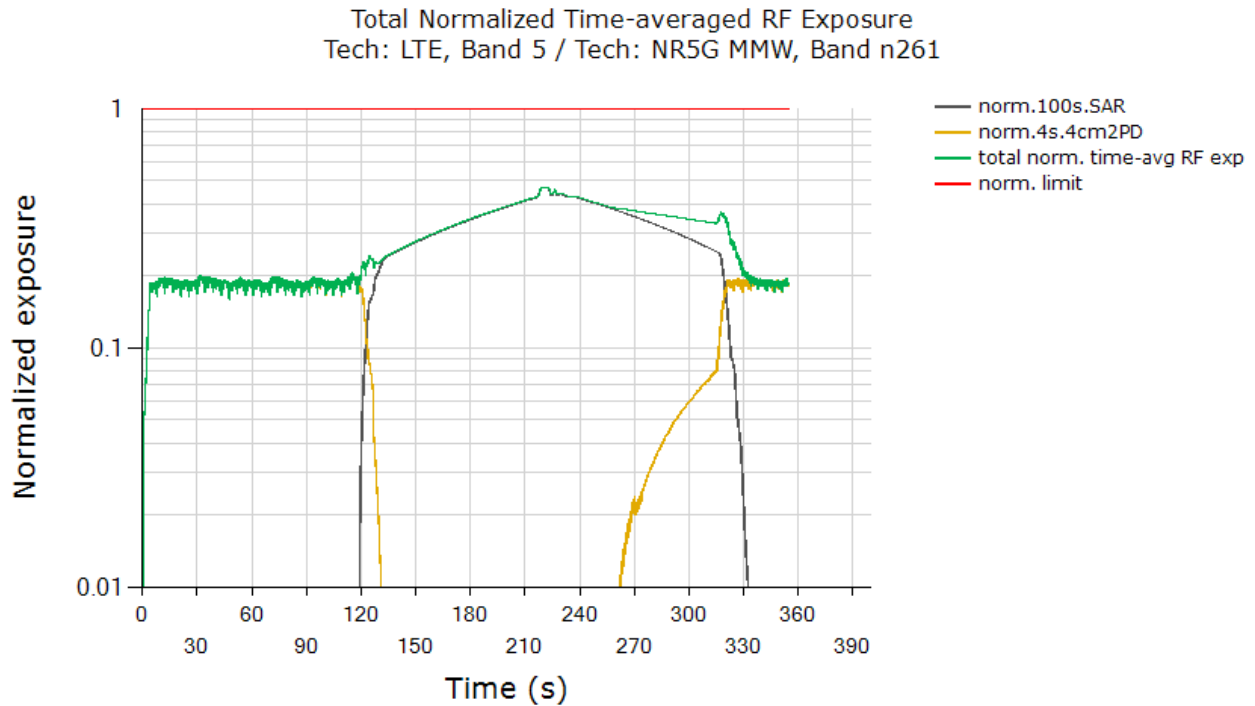

FCC requirement for total RF exposure (normalized)	1.0
Max total normalized time-averaged RF exposure (green curve)	0.469
Validated	

**Plot notes:** As soon as 5G mmW NR call was established, LTE was placed in all-down bits immediately. Between 0s ~ 120s, mmW exposure is the dominant contributor. Here, Smart Transmit feature allocates a maximum of 75% for mmW (based on 3 dB reserve setting in Part 1 report). From Table 8-1, this corresponds to a normalized 4cm<sup>2</sup>PD exposure value for Beam ID 18 of  $(75\% * 3.31 \text{ W/m}^2)/(10\text{W/m}^2) = 24.8\% \pm 2.1\text{dB}$  device related uncertainty (See orange/green curve between 0s ~ 120s). At ~ 120s time mark, LTE is set to all-up bits, taking away margin from mmW exposure gradually (orange curve for mmW exposure goes down while black curve for LTE exposure goes up). At ~ 200s time mark, LTE is set to all-down bits, which results in mmW getting back RF margin slowly as seen by gradual increase in mmW exposure (orange curve for mmW exposure goes up while black curve for LTE exposure goes down). The calculated maximum RF exposure from LTE corresponds to normalized 1gSAR exposure value of  $(100\% * 0.789 \text{ W/kg})/(1.6 \text{ W/kg}) = 49.3\% \pm 1.0\text{dB}$  design related uncertainty (note that this level will be achieved by green and black curves if LTE remains in all-up bits for longer time duration which was already demonstrated in maximum Tx power test in Section 8.2.1). Total normalized time-averaged exposure (green curve) for this test should be within the calculated range between  $24.8\% \pm 2.1\text{dB}$  device related uncertainty (only PD exposure) and  $49.3\% \pm 1.0\text{dB}$  design related uncertainty (only SAR exposure).

As can be seen, the power limiting enforcement is effective during transmission when SAR and PD exposures are switched, and the total normalized time-averaged RF exposure does not exceed 1.0. Therefore, Qualcomm Smart Transmit time averaging feature is validated.

### 8.2.4 Switch in SAR vs. PD exposure test results for n260

This test was measured with LTE Band 5 (DSI = 1) and mmW band n260 Beam ID 26, by following the detailed test procedure is described in Section 4.3.2.

Instantaneous and 100s-averaged conducted LTE Tx power versus time, instantaneous and 4s-averaged radiated mmW Tx power versus time, time-averaged conducted LTE Tx power limit and time-averaged radiated mmW Tx power limit:

**Plot 1:**

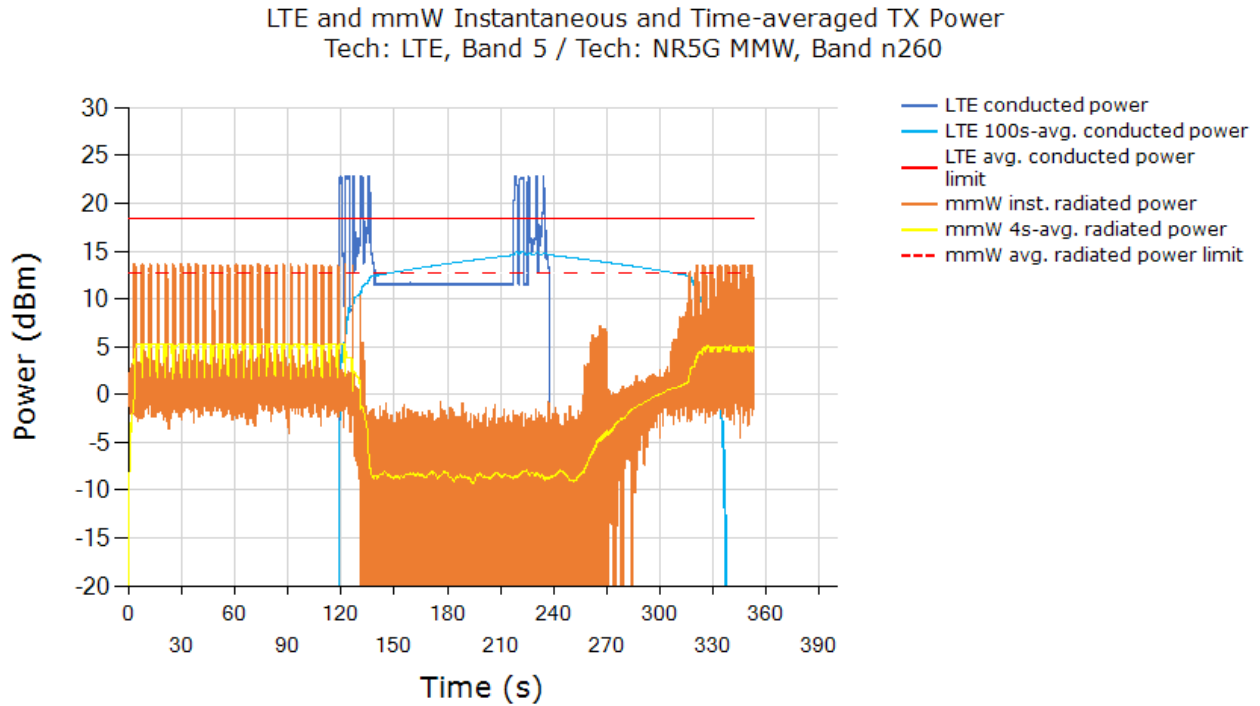

From **Plot 1**, it is predominantly instantaneous PD exposure between 0s ~ 120s, it is instantaneous SAR + PD exposure between 120s ~ 140s, it is predominantly instantaneous SAR exposure between 140s ~ 200s, and above 200s, it is predominantly instantaneous PD exposure.

**Plot 2:** Normalized time-averaged exposure for LTE (1gSAR) and mmW (4cm<sup>2</sup>PD), as well as total normalized time-averaged exposure versus time:

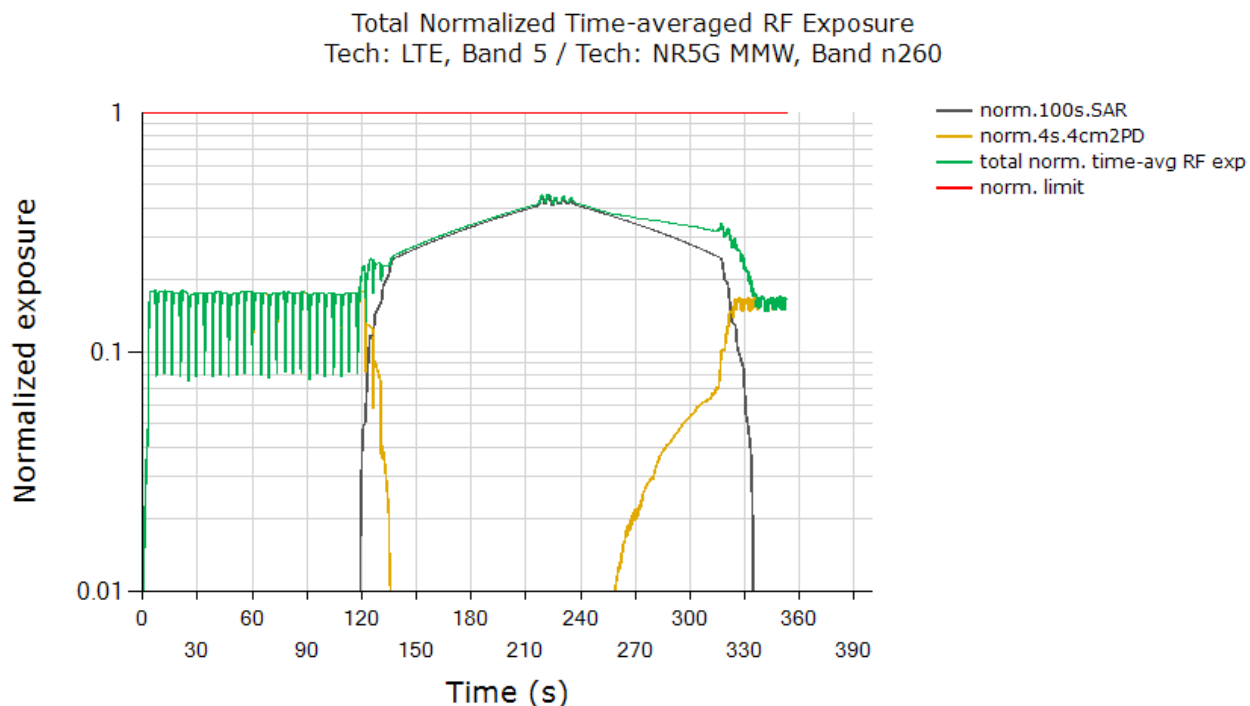

FCC requirement for total RF exposure (normalized)	1.0
Max total normalized time-averaged RF exposure (green curve)	0.455
Validated	

**Plot notes:** As soon as 5G mmW NR call was established, LTE was placed in all-down bits immediately. Between 0s ~ 120s, mmW exposure is the dominant contributor. Here, Smart Transmit feature allocates a maximum of 75% for mmW (based on 3 dB reserve setting in Part 1 report). From Table 8-1, this corresponds to a normalized 4cm<sup>2</sup>PD exposure value for Beam ID 26 of  $(75\% * 3.81 \text{ W/m}^2) / (10 \text{ W/m}^2) = 28.6\% \pm 2.1 \text{ dB}$  device related uncertainty (See orange/green curve between 0s ~ 120s). At ~ 120s time mark, LTE is set to all-up bits, taking away margin from mmW exposure gradually (orange curve for mmW exposure goes down while black curve for LTE exposure goes up). At ~ 200s time mark, LTE is set to all-down bits, which results in mmW getting back RF margin slowly as seen by gradual increase in mmW exposure (orange curve for mmW exposure goes up while black curve for LTE exposure goes down). The calculated maximum RF exposure from LTE corresponds to normalized 1gSAR exposure value of  $(100\% * 0.789 \text{ W/kg}) / (1.6 \text{ W/kg}) = 49.3\% \pm 1.0 \text{ dB}$  design related uncertainty (note that this level will be achieved by green and black curves if LTE remains in all-up bits for longer time duration which was already demonstrated in maximum Tx power test in Section 8.2.1). Total normalized time-averaged exposure (green curve) for this test should be within the calculated range between  $28.6\% \pm 2.1 \text{ dB}$  device related uncertainty (only PD exposure) and  $49.3\% \pm 1.0 \text{ dB}$  design related uncertainty (only SAR exposure).

As can be seen, the power limiting enforcement is effective during transmission when SAR and PD exposures are switched, and the total normalized time-averaged RF exposure does not exceed 1.0. Therefore, Qualcomm Smart Transmit time averaging feature is validated.



### 8.2.5 Change in Beam test results for n261

This test was measured with LTE Band 5 (DSI = 1) and mmW Band n261, with beam switch from Beam ID 18 to Beam ID 146, by following the test procedure is described in Section 4.3.3.

**Plot 1:** Instantaneous conducted LTE Tx power versus time, instantaneous and 4s-averaged radiated mmW Tx power versus time, time-averaged radiated mmW Tx power limits for Beam ID 18 and Beam ID 146:

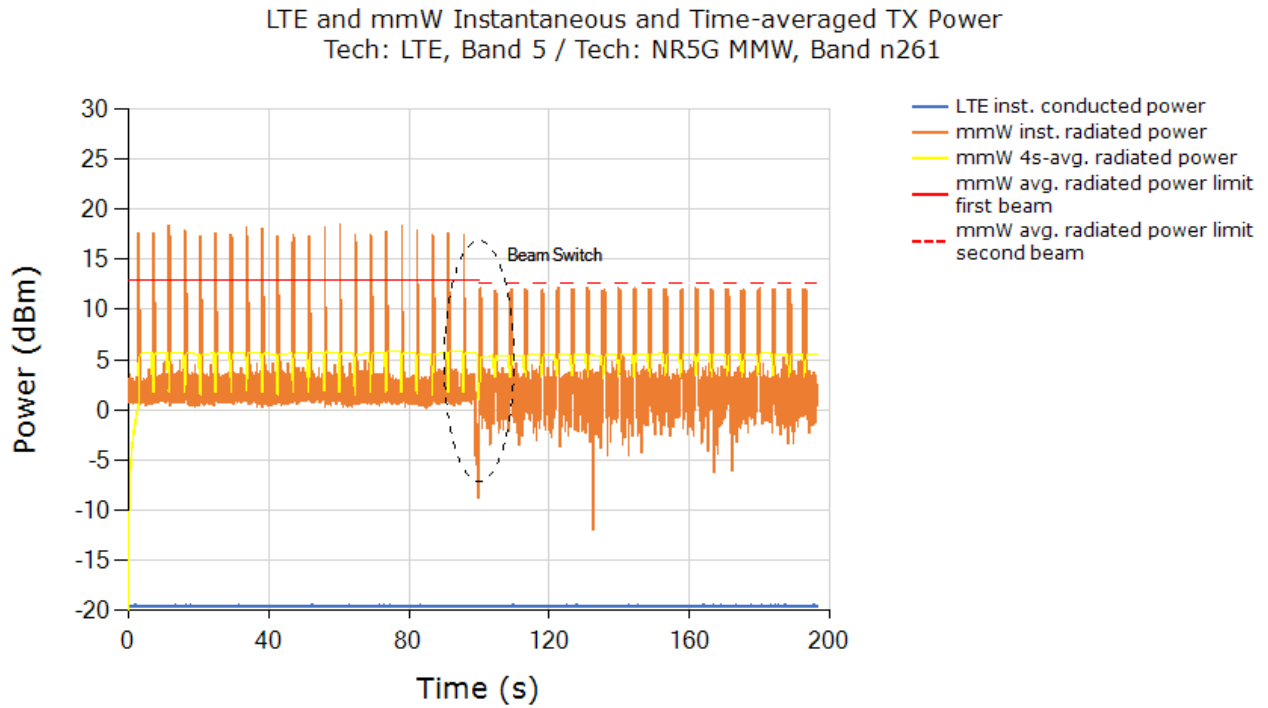

**Plot 2:** Normalized time-averaged exposure for LTE and mmW (4cm<sup>2</sup>PD), as well as total normalized time-averaged exposure versus time:

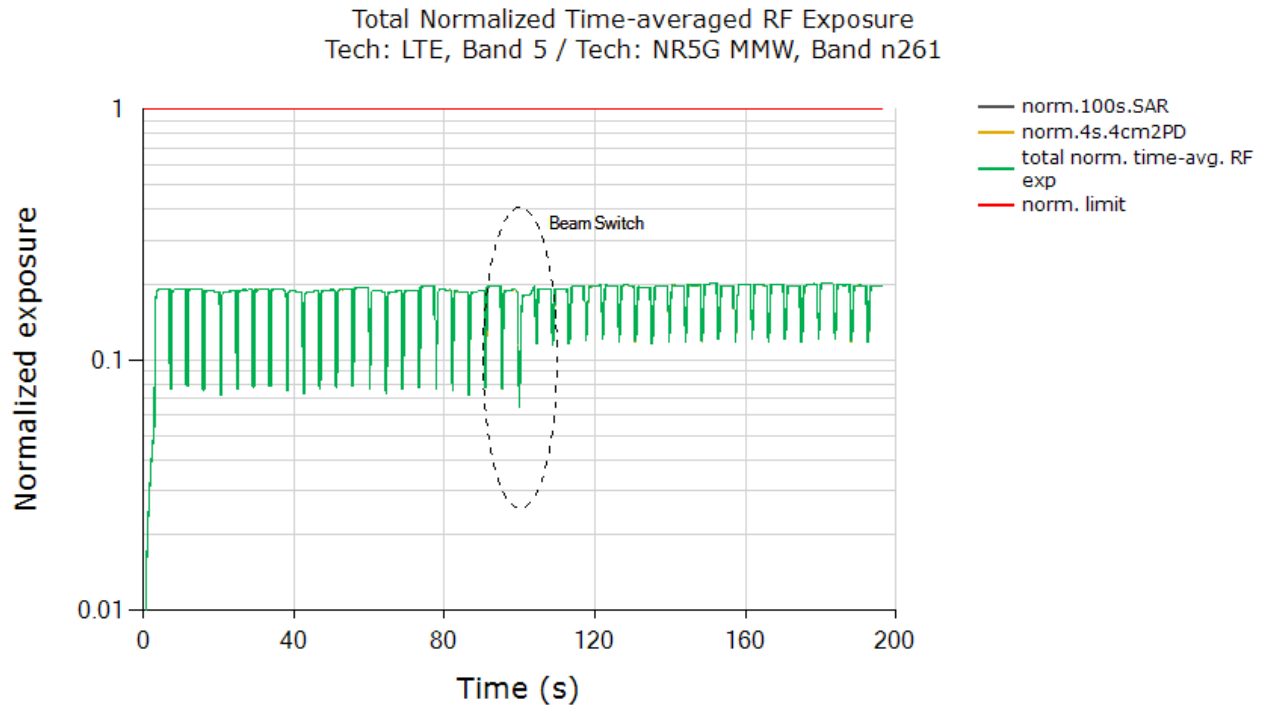

FCC requirement for total RF exposure (normalized)	1.0
Max total normalized time-averaged RF exposure (green curve)	0.202
Validated	

**Plot notes:** 5G mmW NR call was established at ~1s time mark and LTE was placed in all-down bits immediately after 5G mmW NR call was established. For the rest of this test, mmW exposure is the dominant contributor as LTE is left in all-down bits. Here, Smart Transmit feature allocates a maximum of 75% for mmW (based on 3dB reserve setting in Part 1 report). From Table 8-1, exposure between 1s ~ 100s corresponds to a normalized 4cm<sup>2</sup>PD exposure value for Beam ID 18 of  $(75\% \cdot 3.31 \text{ W/m}^2) / (10 \text{ W/m}^2) = 24.8\% \pm 2.1\text{dB}$  device related uncertainty. At ~100s time mark (shown in black dotted ellipse), the normalized 4cm<sup>2</sup>PD exposure value for n261 Beam ID 146 =  $(75\% \cdot 4.19 \text{ W/m}^2) / (10 \text{ W/m}^2) = 31.4\% \pm 2.1\text{dB}$  device related uncertainty. Additionally, during the switch, the ratio between the averaged radiated powers of the two beams (yellow curve) should correspond to the difference in EIRPs measured at each corresponding *input.power.limit* for these beams listed in Table 8-1.

### 8.2.6 Change in Beam test results for n260

This test was measured with LTE Band 5 (DSI = 1) and mmW Band n260, with beam switch from Beam ID 20 to Beam ID 148, by following the test procedure is described in Section 4.3.3.

**Plot 1:** Instantaneous conducted LTE Tx power versus time, instantaneous and 4s-averaged radiated mmW Tx power versus time, time-averaged radiated mmW Tx power limits for Beam ID 20 and Beam ID 148:

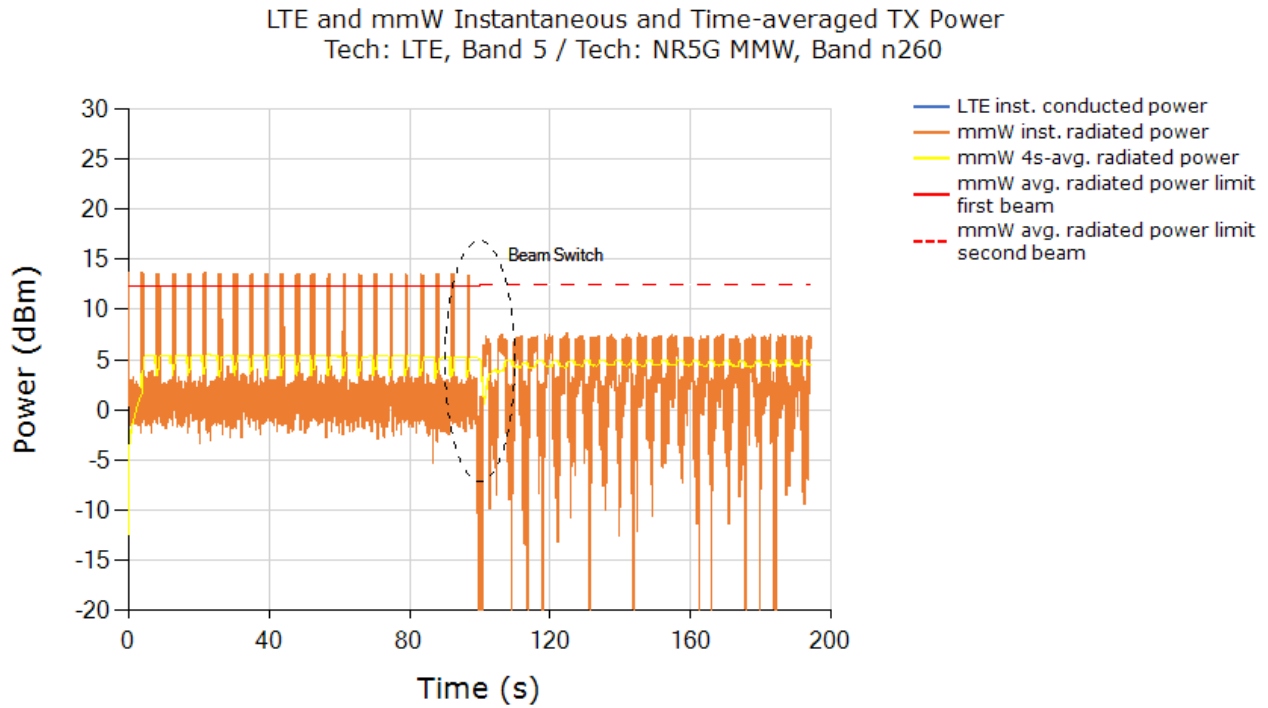

**Plot 2:** Normalized time-averaged exposure for LTE and mmW (4cm<sup>2</sup>PD), as well as total normalized time-averaged exposure versus time:

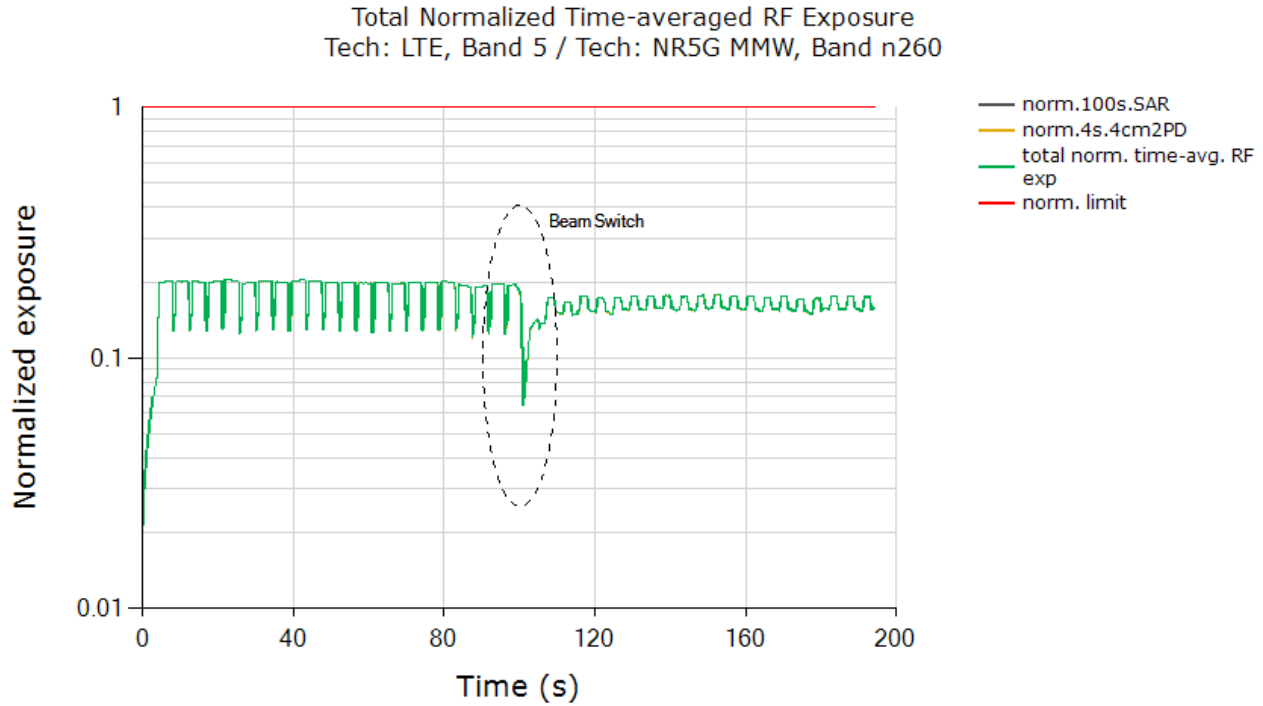

FCC requirement for total RF exposure (normalized)	1.0
Max total normalized time-averaged RF exposure (green curve)	0.206
Validated	

**Plot notes:** 5G mmW NR call was established at ~1s time mark and LTE was placed in all-down bits immediately after 5G mmW NR call was established. For the rest of this test, mmW exposure is the dominant contributor as LTE is left in all-down bits. Here, Smart Transmit feature allocates a maximum of 75% for mmW (based on 3dB reserve setting in Part 1 report). From Table 8-1, exposure between 1s ~ 100s corresponds to a normalized 4cm<sup>2</sup>PD exposure value for Beam ID 20 of  $(75\% \cdot 3.66 \text{ W/m}^2) / (10 \text{ W/m}^2) = 27.5\% \pm 2.1\text{dB}$  device related uncertainty. At ~100s time mark (shown in black dotted ellipse), the normalized 4cm<sup>2</sup>PD exposure value for n261 Beam ID 148 =  $(75\% \cdot 3.23 \text{ W/m}^2) / (10 \text{ W/m}^2) = 24.2\% \pm 2.1\text{dB}$  device related uncertainty. Additionally, during the switch, the ratio between the averaged radiated powers of the two beams (yellow curve) should correspond to the difference in EIRPs measured at each corresponding *input.power.limit* for these beams listed in Table 8-1.

## 9. PD Test Results for mmW Smart Transmit Feature Validation.

### 9.1. Power density measurement system

The power density measurement system is constructed based on the DASY6 platform by SPEAG. The DASY6 with EummWV2 and 5G software module can measure the RF exposure (power density) up to 110GHz as close as 2mm from any transmitter.

### 9.2. Power density probe

The EummWV2 probe is used in the power density measurement. It is designed for precise near-field measurements in the mm-wave range by Schmid & Partner Engineering AG of Zurich, Switzerland. The specifications are:

- Frequency range: 0.75 ~ 110 GHz
- Dynamic range: <math><50 - 3000 \text{ V/m}</math> (up to 10000 V/m with additional PRE-10 voltage divider)
- Linearity: <math><\pm 0.2 \text{ dB}</math>
- Supports sensor model calibration (SMC)
- ISO17025 accredited calibration

### 9.3. Power density measurement system verification

The power density system verification is performed using the SPEAG verification device. It consists of a ka-band horn antenna with a corresponding gun oscillator packaged within a cube-shaped housing.

The specification of the verification device is:

- Calibrated frequency: 30 GHz at 10 mm from the case surface
- Frequency accuracy:  $\pm 100\text{MHz}$
- E-field polarization: linear
- Harmonics: -20 dBc(typ)
- Total radiated power: 14 dBm (typ)
- Power stability: 0.05 dB
- Power consumption: 5W (max)
- Size: 100 x 100 x 100 mm
- Weight: 1 kg

Below Table shows the verification test results. The measured power density (PD) value is within 0.4dB of target level target level. Note that the uncertainty of 5G verification source is 1.4 dB (K=2).

#### SAR 1 Room

Date Tested	Source		Total psPD (W/m <sup>2</sup> over 4cm <sup>2</sup> )		Deviation (dB)	Plot No.
	Type	Serial #	Target	Measured		
5-4-2021	1047	1-22-2022	68.70	67.50	-0.08	6
5-25-2021	1047	1-22-2022	68.70	69.00	0.02	7
6-3-2021	1047	1-22-2022	68.70	68.20	-0.03	8

#### SAR 7 Room

Date Tested	Source		Total psPD (W/m <sup>2</sup> over 4cm <sup>2</sup> )		Deviation (dB)	Plot No.
	Serial #	Cal. Due date	Target	Measured		
6-2-2021	1082	4-7-2022	46.90	45.70	-0.11	9

### 9.4. Measurement setup

This measurement setup is similar to normal PD measurements, the EUT is positioned in cDASY6 platform, and is connected with the callbox (conducted for LTE and wirelessly for mmW). Keysight UXM callbox is set to request maximum mmW Tx power from EUT all the time. Hence, “path loss” calibration between callbox antenna and EUT is not needed in this test. The callbox’s LTE port is directly connected to the EUT’s RF port via a directional coupler to measure the EUT’s conducted Tx power using a Rohde & Schwarz NRP50S power sensor. Additionally, EUT is connected to the PC via USB connection for toggling between FTM and online mode with Smart Transmit enabled following the test procedures described Section 4.4.

Worst-surface of EUT (for the mmW beam being tested) is positioned facing up for PD measurement with cDASY6 mmW probe as shown in Figure C-2 (see A.9 in Appendix A). Figure C-3 shows the schematic of this measurement setup.

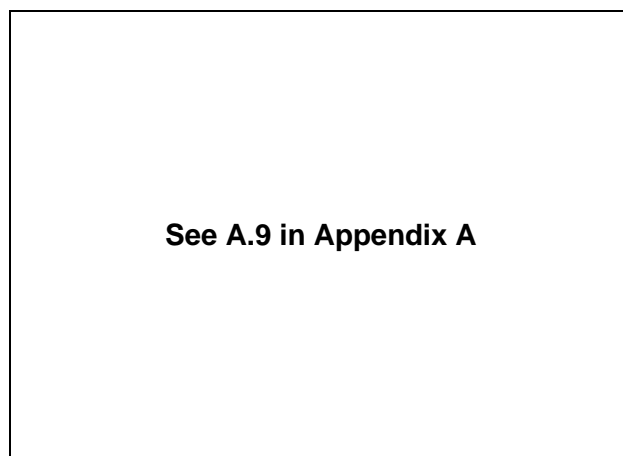

Figure C-2 Worst-surface of EUT positioned facing up for the mmW beam being tested

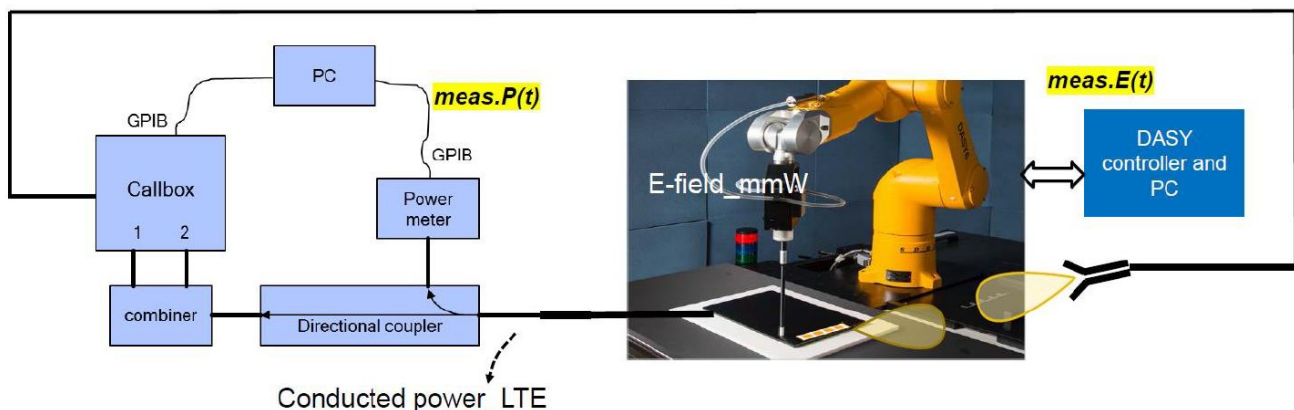

Figure C-3 PD measurement setup

Both callbox and power meters are connected to the PC using USB cables. Test scripts are custom made for automation of establishing LTE + mmW call, and for conducted Tx power recording of LTE transmission. These tests are manually stopped after desired time duration. Once the mmW link is established, LTE Tx power is programmed to toggle between all-up and all-down bits on the callbox. For all the tests, the callbox is set to request maximum Tx power in mmW NR radio from EUT all the time. Therefore, the calibration for the pathloss between the EUT and the horn antenna connected to the remote radio head of the callbox is not required.

Power meter reading are periodically recorded every 10ms on NRP50S power sensor for LTE conducted Tx power. Time-averaged E-field measurements are performed using EummWV2 mmW probe at peak location of fast area scan. The distance between EummWV2 mmW probe tip to EUT surface is ~0.5 mm, and the distance between EummWV2 probe sensor to probe tip is 1.5 mm. cDASY6 records relative point E-field (i.e., radio  $[pointE(t)]^2 / [pointE\_input.power.limit]^2$  versus time for mmW NR transmission.

## 9.5. PD measurement results for maximum power transmission scenario

cDASY6 system validation for PD measurement is provided in Section 9.3, and the associated SPEAG certificates are attached in Appendix D(Probes) & E(Verification sources) in PD part 1 report. The following configurations were measured by following the detailed test procedure is described in Section 4.4:

1. LTE Band 5 (DSI = 1) and mmW Band n261 Beam ID 18
2. LTE Band 5 (DSI = 1) and mmW Band n260 Beam ID 26

The measured conducted Tx power of LTE and ratio of  $[pointE(t)]^2 / [pointE\_input.power.limit]^2$  of mmW is convert into 1gSAR and 4cm<sup>2</sup>PD value, respectively, using Eq. (4a) and (4b), rewritten below:

$$1g\_or\_10gSAR(t) = \frac{conducted\_Tx\_power(t)}{conducted\_Tx\_power\_P_{limit}} * 1g\_or\_10gSAR\_P_{limit} \quad (4a)$$

$$4cm^2PD(t) = \frac{[pointE(t)]^2}{[pointE\_input.power.limit]^2} * 4cm^2PD\_input.power.limit \quad (4b)$$

$$\frac{\frac{1}{T_{SAR}} \int_{t-T_{SAR}}^t 1g\_or\_10gSAR(t) dt}{FCC\ SAR\ limit} + \frac{\frac{1}{T_{PD}} \int_{t-T_{PD}}^t 4cm^2PD(t) dt}{FCC\ 4cm^2PD\ limit} \leq 1 \quad (4c)$$

Where,  $conducted\_Tx\_power(t)$ ,  $conducted\_Tx\_power\_P_{limit}$ , and  $1g\_or\_10gSAR\_P_{limit}$  correspond to the measured instantaneous conducted Tx power, measured conducted Tx power at  $P_{limit}$ , and measured 1gSAR or 10gSAR values at  $P_{limit}$  corresponding to LTE transmission. Similarly,  $pointE(t)$ ,  $pointE\_input.power.limit$ , and  $4cm^2PD@input.power.limit$  correspond to the measured instantaneous E-field, E-field at  $input.power.limit$ , and 4cm<sup>2</sup>PD value at  $input.power.limit$  corresponding to mmW transmission.

Note: cDASY6 system measures relative E-field, and provides ratio of  $[pointE(t)]^2 / [pointE\_input.power.limit]^2$  Versus time.

The radio configurations tested are described in Table 5-3 and 5-4. The 1gSAR at  $P_{limit}$  for LTE Band 5 DSI =1, the measured 4cm<sup>2</sup>PD at  $input.power.limit$  of mmW n261 beam 18 and n260 beam 26, are all listed in Table 8-1.

### 9.2.1 PD test results for n261

Step 2.e plot (in Section 4.4) for normalized instantaneous and time-averaged exposure for LTE and mmW n261 beam 18:

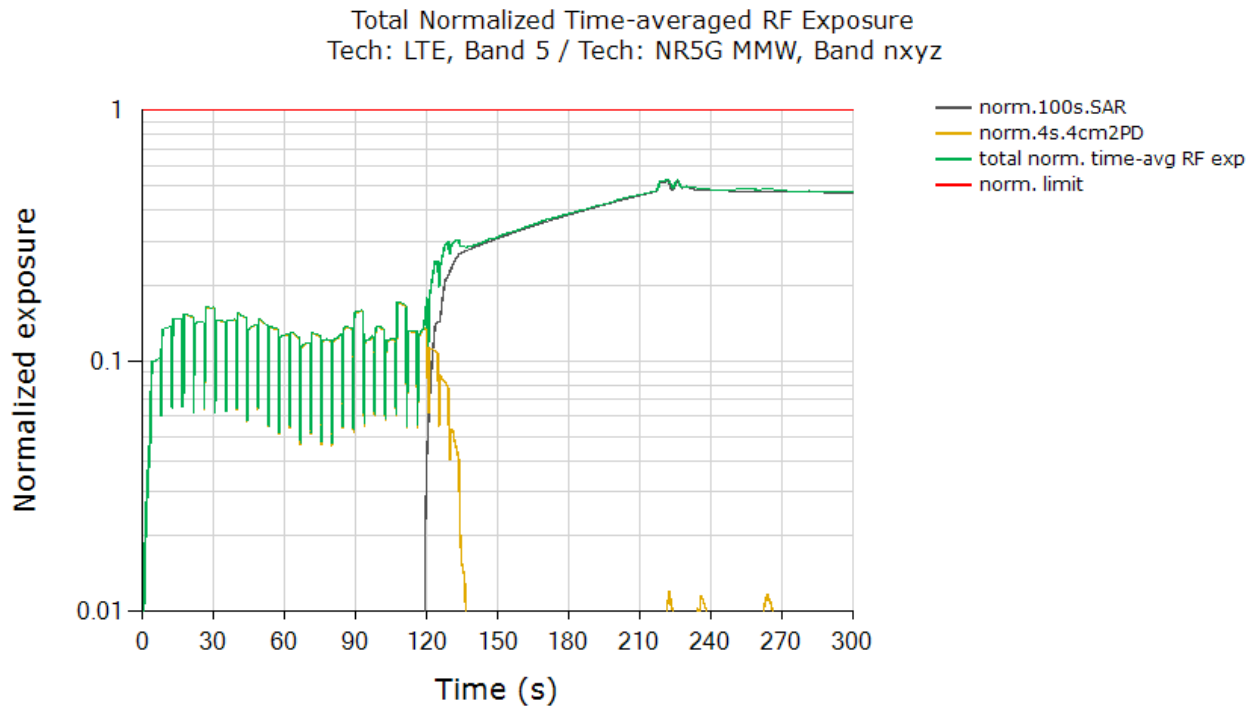

FCC limit for total RF exposure (normalized)	1.0
Max total normalized time-averaged RF exposure (green curve)	0.529
Validated	

**Plot notes:** LTE was placed in all-down bits immediately after 5G mmW NR call was established. Between 0s ~ 120s, mmW exposure is the dominant contributor. Here, Smart Transmit feature allocates a maximum of 75% for mmW (based on the 3dB reserve setting in Part 1 report). From Table 8-1, this corresponds to a normalized 4cm<sup>2</sup>PD exposure value for Beam ID 18 of (75% \* 3.31 W/m<sup>2</sup>)/(10W/m<sup>2</sup>) = 24.8% ± 2.1dB device related uncertainty (See orange/green curve between 0s ~ 120s). Around 120s time mark, LTE is set to all-up bits, taking away margin from mmW exposure gradually. Towards the end of the test, LTE is the dominant contributor towards RF exposure, i.e., corresponding normalized 1gSAR exposure value of (100% \* 0.789 W/kg)/(1.6 W/kg) = 49.3% ± 1.0dB design related uncertainty (See black curves approaching this level towards end of the test).

As can be seen, the power limiting enforcement is effective and the total normalized time-averaged RF exposure does not exceed 1.0. Therefore, Qualcomm Smart Transmit time averaging feature is validated.



### 9.2.2 PD test results for n260

Step 2.e plot (in Section 4.4) for normalized instantaneous and time-averaged exposure for LTE and mmW n260 beam 26:

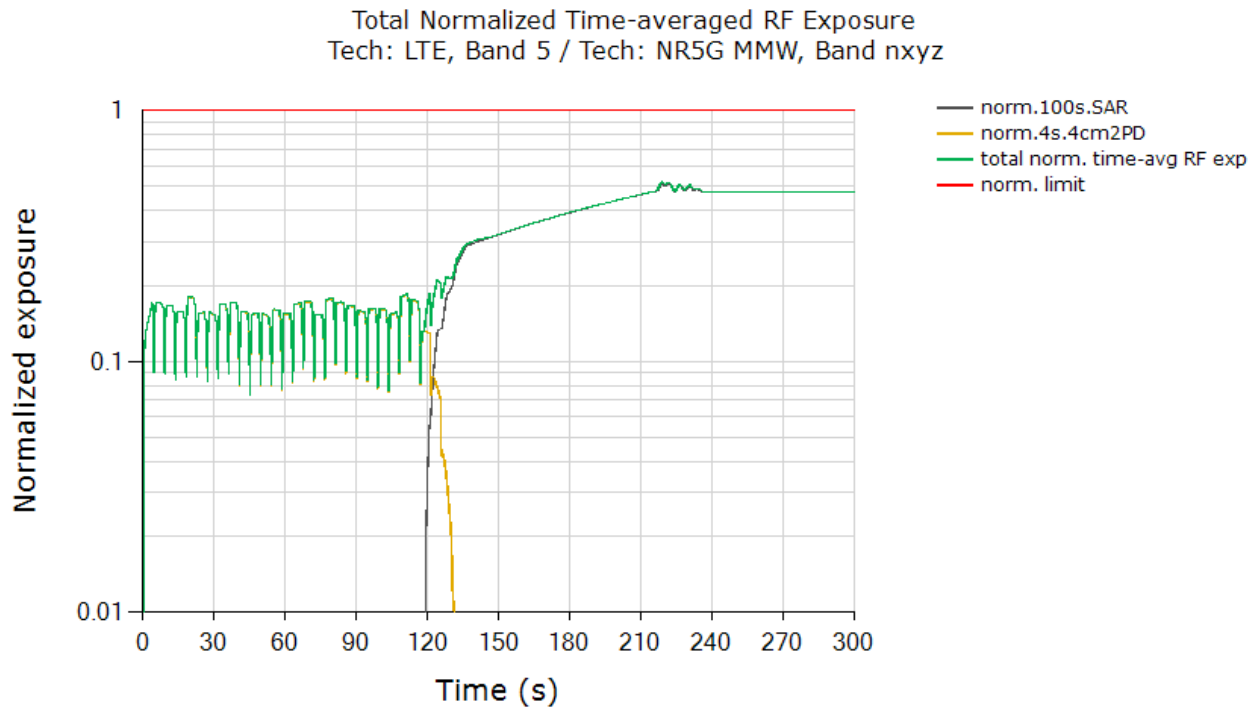

FCC limit for total RF exposure (normalized)	1.0
Max total normalized time-averaged RF exposure (green curve)	0.517
Validated	

**Plot notes:** LTE was placed in all-down bits immediately after 5G mmW NR call was established. Between 0s ~ 120s, mmW exposure is the dominant contributor. Here, Smart Transmit feature allocates a maximum of 75% for mmW (based on the 3dB reserve setting in Part 1 report). From Table 8-1, this corresponds to a normalized 4cm<sup>2</sup>PD exposure value for Beam ID 26 of  $(75\% * 3.81 \text{ W/m}^2)/(10\text{W/m}^2) = 28.6\% \pm 2.1\text{dB}$  device related uncertainty (See orange/green curve between 0s ~ 120s). Around 120s time mark, LTE is set to all-up bits, taking away margin from mmW exposure gradually. Towards the end of the test, LTE is the dominant contributor towards RF exposure, i.e., corresponding normalized 1gSAR exposure value of  $(100\% * 0.789 \text{ W/kg})/(1.6 \text{ W/kg}) = 49.3\% \pm 1.0\text{dB}$  design related uncertainty (See black curves approaching this level towards end of the test).

As can be seen, the power limiting enforcement is effective and the total normalized time-averaged RF exposure does not exceed 1.0. Therefore, Qualcomm Smart Transmit time averaging feature is validated.

## 10. Test Equipment

The measuring equipment used to perform the tests documented in this report has been calibrated in accordance with the manufacturers' recommendations, and is traceable to recognized national standards.

### SAR test

#### Dielectric Property Measurements

Name of Equipment	Manufacturer	Type/Model	Serial No.	Cal. Due Date
Network Analyzer	Agilent	E5071C	MY46522054	8-4-2021
Dielectric Assessment Kit	SPEAG	DAK-3.5	1196	7-17-2021
Shorting block	SPEAG	DAK-3.5 Short	SM DAK 200 BA	N/A
Thermometer	LKM	DTM3000	3424	8-11-2021

#### System Check

Name of Equipment	Manufacturer	Type/Model	Serial No.	Cal. Due Date
MXG Analog Signal Generator	Agilent	N5181A	MY50145882	8-4-2021
Power Sensor	Agilent	U2000A	MY60180020	9-9-2021
Power Sensor	Agilent	U2000A	MY54260007	8-7-2021
Power Amplifier	EXODUS	1410025-AMP2027-10003	10003	8-4-2021
Directional Coupler	Agilent	772D	MY52180193	8-4-2021
Directional Coupler	Agilent	778D	MY52180432	8-4-2021
Low Pass Filter	MICROLAB	LA-15N	3943	8-4-2021
Low Pass Filter	FILTRON	L14012FL	1410003S	8-4-2021
Low Pass Filter	MICROLAB	LA-60N	3942	8-4-2021
Attenuator	Agilent	8491B/003	MY39271969	12-3-2021
Attenuator	Agilent	8491B/010	MY39271981	9-9-2021
Attenuator	Agilent	8491B/020	MY39271973	9-9-2021
E-Field Probe	SPEAG	EX3DV4	7376	7-31-2021
E-Field Probe	SPEAG	EX3DV4	7645	4-15-2022
Data Acquisition Electronics	SPEAG	DAE4	1591	8-25-2021
System Validation Dipole	SPEAG	D835V2	4d174	2-24-2022
System Validation Dipole	SPEAG	D1900V2	5d199	3-19-2022
System Validation Dipole	SPEAG	D2600V2	1097	9-19-2021
System Validation Dipole	SPEAG	D3700V2	1026	9-18-2022
Thermometer (SAR5)	Lutron	MHB-382SD	AH.91463	8-11-2021

#### Others

Name of Equipment	Manufacturer	Type/Model	Serial No.	Cal. Due Date
Base Station Simulator	R & S	CMW500	162790	8-4-2021
UXM 5G Wireless Test Platform	Keysight	E7515B	MY57510596	1-13-2022

## Power density test

#### System Check

Name of Equipment	Manufacturer	Type/Model	Serial No.	Cal. Due Date
5G Probe (SAR 1)	SPEAG	EUMMWV4	9493	8-18-2021
5G Probe (SAR 7)	SPEAG	EUMMWV4	9536	4-24-2022
Data Acquisition Electronics	SPEAG	DAE4	1468	8-25-2021
Data Acquisition Electronics	SPEAG	DAE4	1668	4-8-2022
Verification kit	SPEAG	5G Verification Source 30GHz	1047	1-22-2022
Verification kit	SPEAG	5G Verification Source 30GHz	1082	4-7-2022

#### Note(s):

For calibration reports of probe (PD & SAR) reference dipole and reference source, Please refer to Part.1 appendixes.

## 11. Measurement Uncertainty

### 11.1. SAR

Per KDB 865664 D01 SAR Measurement 100 MHz to 6 GHz, when the highest measured 1-g SAR within a frequency band is < 1.5 W/kg and the measured 10-g SAR within a frequency band is < 3.75 W/kg. The expanded SAR measurement uncertainty must be ≤ 30%, for a confidence interval of k = 2. If these conditions are met, extensive SAR measurement uncertainty analysis described in IEEE Std 1528-2013 is not required in SAR reports submitted for equipment approval.

### 11.2. Power density

#### Measurement Uncertainty for cDASY6 Module mmWave

Error Description	Uncertainty value (±dB)	Probe Dist.	Divisor	(Ci)	Std. Unc. (±dB)	(Vi)
<b>Uncertainty terms dependent on the measurement system</b>						
Calibration	0.49	Normal	1	1	0.49	Infinity
Probe correction	0.00	Rectangular	1.73	1	0.00	Infinity
Frequency response (BW =< 1 GHz)	0.20	Rectangular	1.73	1	0.12	Infinity
Sensor cross coupling	0.00	Rectangular	1.73	1	0.00	Infinity
Isotropy	0.50	Rectangular	1.73	1	0.29	Infinity
Linearity	0.20	Rectangular	1.73	1	0.12	Infinity
Probe scattering	0.00	Rectangular	1.73	1	0.00	Infinity
Probe positioning offset	0.30	Rectangular	1.73	1	0.17	Infinity
Probe positioning repeatability	0.04	Rectangular	1.73	1	0.02	Infinity
Sensor mechanical offset	0.00	Rectangular	1.73	1	0.00	Infinity
Probe spatial resolution	0.00	Rectangular	1.73	1	0.00	Infinity
Field impedance dependance	0.00	Rectangular	1.73	1	0.00	Infinity
Amplitude and phase drift	0.00	Rectangular	1.73	1	0.00	Infinity
Amplitude and phase noise	0.04	Rectangular	1.73	1	0.02	Infinity
Measurement area truncation	0.10	Rectangular	1.73	1	0.06	Infinity
Data acquisition	0.03	Normal	1.00	1	0.03	Infinity
Sampling	0.00	Rectangular	1.73	1	0.00	Infinity
Field reconstruction	0.60	Rectangular	1.73	1	0.35	Infinity
Forward transformation	0.00	Rectangular	1.73	1	0.00	Infinity
Power density scaling	-	Rectangular	1.73	1	-	Infinity
Spatial averaging	0.10	Rectangular	1.73	1	0.06	Infinity
System detection limit	0.04	Rectangular	1.73	1	0.02	Infinity
<b>Uncertainty terms dependent on the DUT and environmental factors</b>						
Probe coupling with DUT	0.00	Rectangular	1.73	1	0.00	Infinity
Modulation response	0.40	Rectangular	1.73	1	0.23	Infinity
Integration time	0.00	Rectangular	1.73	1	0.00	Infinity
Response time	0.00	Rectangular	1.73	1	0.00	Infinity
Device holder influence	0.10	Rectangular	1.73	1	0.06	Infinity
DUT alignment	0.00	Rectangular	1.73	1	0.00	Infinity
RF ambient conditions	0.04	Rectangular	1.73	1	0.02	Infinity
Ambient reflections	0.04	Rectangular	1.73	1	0.02	Infinity
Immunity / secondary reception	0.00	Rectangular	1.73	1	0.00	Infinity
Drift of the DUT	0.22	Rectangular	1.73	1	0.13	Infinity
Combined Std. Uncertainty					0.76	Infinity
<b>Expanded Standard Uncertainty (95%)</b>					<b>1.53</b>	

## 12. Conclusions

Qualcomm Smart Transmit feature employed in Samsung device (FCC ID: A3LSMT738U) has been validated through the conducted/radiated power measurement (as demonstrated in Chapters 6 and 8), as well as SAR and PD measurement (as demonstrated in chapters 7 and 9).

As demonstrated in this report, the power limiting enforcement is effective and the total normalized time-averaged RF exposure does not exceed 1.0 for all the transmission scenarios described in Section 2. Therefore, the EUT complies with FCC RF exposure requirement.

## Section A. Test Sequences

1. Test sequence is generated based on below parameters of the EUT:
  - a. Measured maximum power ( $P_{max}$ )
  - b. Measured Tx\_power\_at\_SAR\_design\_target ( $P_{limit}$ )
  - c. Reserve\_power\_margin (dB)
    - $P_{reserve}$  (dBm) = measured  $P_{limit}$  (dBm) – Reserve\_power\_margin (dB)
  - d. SAR\_time\_window (100s for FCC)
2. **Test Sequence 1** Waveform:

Based on the parameter above, the Test Sequence 1 is generated with one transmission between high and low Tx powers. Here, high power =  $P_{max}$ ; low power =  $P_{max}/2$ , and the transition occurs after 80 seconds at high power  $P_{max}$ . As long as the power enforcement is taking into effective during one 100s/60s time window, the validation test with this defined test sequence 1 is valid, otherwise, select other radio configuration (band/DSI within the same technology group) having lower  $P_{limit}$  for this test. The test sequence 1 waveform is shown below:

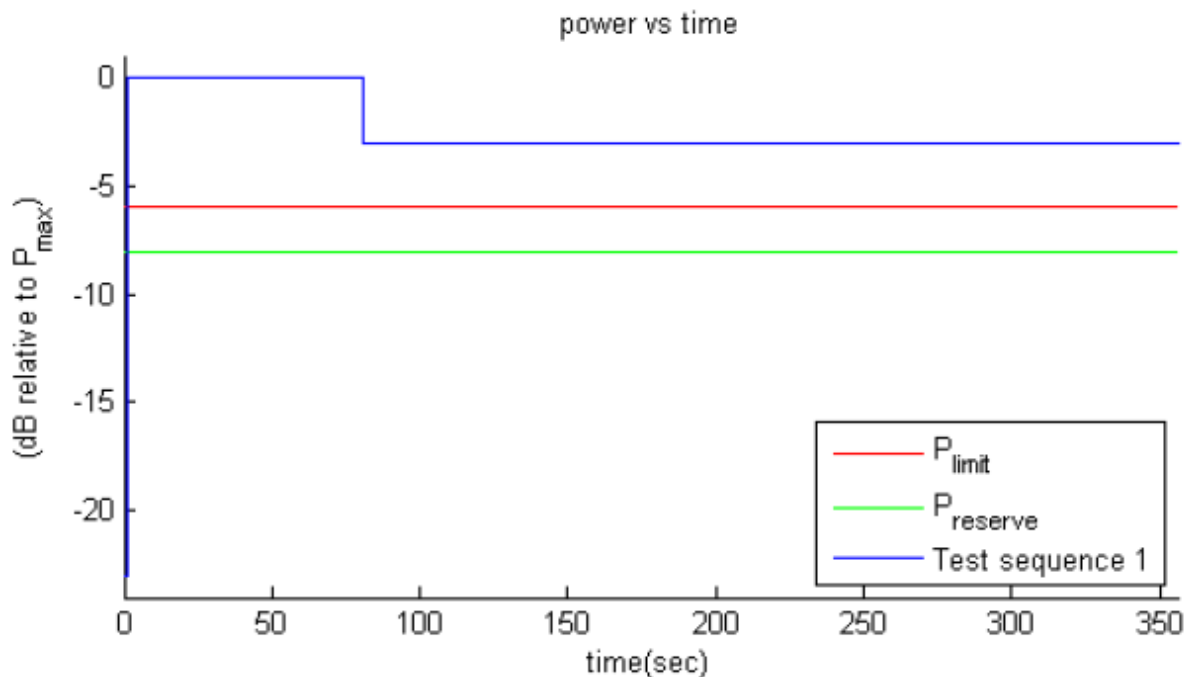

Figure A-1: Test sequence 1 waveform

3. **Test Sequence 2** Waveform:

Based on the parameters in Figure A-1, the Test Sequence 2 is generated as described in Table A-1, which contains two 170 second-long sequences (yellow and green highlighted rows) that are mirrored around the center row of 20s, resulting in a total duration of 360 seconds:

**Table A-1: Test sequence 2**

Time duration (seconds)	dB relative to $P_{limit}$ or $P_{reserve}$
15	$P_{reserve} - 2$
20	$P_{limit}$
20	$(P_{limit} + P_{max})/2$ averaged in mW and rounded to nearest 0.1 dB step
10	$P_{reserve} - 6$
20	$P_{max}$
15	$P_{limit}$
15	$P_{reserve} - 5$
20	$P_{max}$
10	$P_{reserve} - 3$
15	$P_{limit}$
10	$P_{reserve} - 4$
20	$(P_{limit} + P_{max})/2$ averaged in mW and rounded to nearest 0.1 dB step
10	$P_{reserve} - 4$
15	$P_{limit}$
10	$P_{reserve} - 3$
20	$P_{max}$
15	$P_{reserve} - 5$
15	$P_{limit}$
20	$P_{max}$
10	$P_{reserve} - 6$
20	$(P_{limit} + P_{max})/2$ averaged in mW and rounded to nearest 0.1 dB step
20	$P_{limit}$
15	$P_{reserve} - 2$

The test Sequence 2 waveform is shown in Figure A-2.

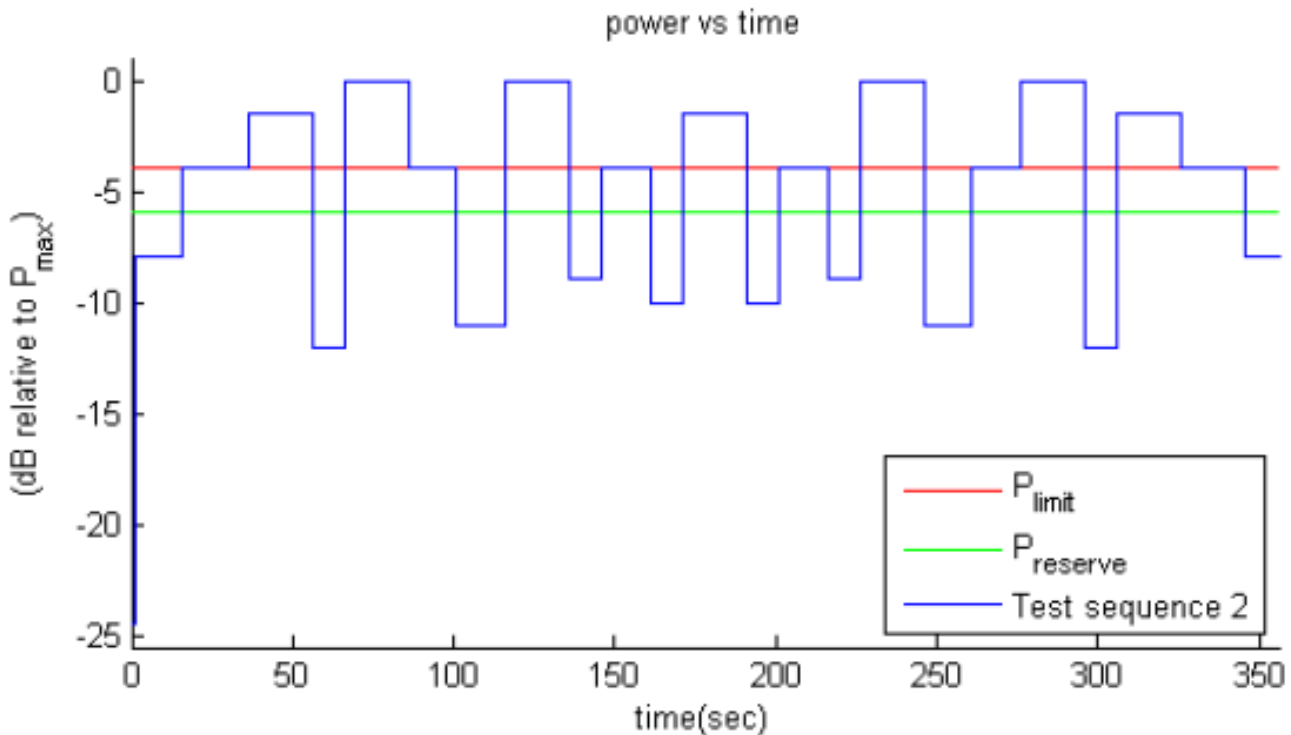

**Figure A-2: Test sequence 2 waveform**

## Section B. Test Procedures for sub6 NR + LTE Radio

Section B provides the test procedures for validating Qualcomm Smart Transmit feature for LTE + Sub6 NR non-standalone (NSA) mode transmission scenario, where sub-6GHz LTE link acts as an anchor, and Sub6 NR standalone mode (SA) transmission scenario.

### B.1 Time-varying Tx power test for sub6 NR in NSA mode and SA mode

Follows Section 3.2.1 to select test configurations for time-varying test. This test is performed with two pre-defined test sequences (described in Section 3.1) applied to Sub6 NR (with LTE on all-down bits or low power for the entire test after establishing the LTE + Sub6 NR call with the callbox). Follow the test procedures described in Section 3.3.1 to demonstrate the effectiveness of power limiting enforcement and that the time averaged Tx power of Sub6 NR when converted into 1gSAR values does not exceed the regulatory limit at all times (See Eq. (1a) and (1b)). Sub6 NR response to test sequence 1 and test sequence 2 will be similar to other technologies (say, LTE), and are shown in Sections 6.3.7 and 6.3.8.

### B.2 Switch in SAR exposure between LTE vs. Sub6 NR during transmission

This test is to demonstrate that Smart Transmit feature accurately accounts for switching in exposures among SAR for LTE radio only, SAR from both LTE radio and sub6 NR, and SAR from sub6 NR only scenarios, and ensures total time-averaged RF exposure compliance with FCC limit.

#### Test procedure:

1. Measure conducted Tx power corresponding to  $P_{limit}$  for LTE and sub6 NR in selected band. Test condition to measure conducted  $P_{limit}$  is:
  - Establish device in call with the callbox for LTE in desired band. Measure conducted Tx power corresponding to LTE  $P_{limit}$  with Smart Transmit enable and *Reserve\_power\_margin* set to 0 dB, callbox set to request maximum power.
  - Repeat above step to measure conducted Tx power corresponding to Sub6 NR  $P_{limit}$ . If testing LTE + Sub6 NR in non-standalone mode, then establish LTE + Sub6 NR call with callbox and request all down bits for radio1 LTE. In this scenario, with callbox requesting maximum power from Sub6 NR, measured conducted Tx power corresponds to radio2  $P_{limit}$  (as radio1 LTE is at all-down bits).
2. Set *Reserve\_power\_margin* to actual (intended) value with EUT setup for LTE\_Sub6 NR call. First, establish LTE connection in all-up bits with the callbox, and then Sub6 NR connection is added with callbox requesting UE to transmit at maximum power in Sub6 NR. As soon as the Sub6 NR connection is established, request all-down bits on LTE link (otherwise, Sub6 NR will not have sufficient RF exposure margin to sustain the call with LTE in all-up bits). Continue LTE(all-down bits) + Sub6 NR transmission for more than one time-window duration to test predominantly Sub6 NR SAR exposure scenario (as SAR exposure is negligible from all-down bits in LTE). After at least one time-window, request LTE to go all-up bits to test LTE SAR and Sub6 NR SAR exposure scenario. After at least one more time-window, drop (or request all-down bits) Sub6 NR transmission to test predominantly LTE SAR exposure scenario. Continue the test for at least one more time-window. Record the conducted Tx powers for both LTE and Sub6 NR for the entire duration of this test.

3. Once the measurement is done, extract instantaneous Tx power versus time for both LTE and Sub6 NR links. Similar to technology/band switch test in Section 3.3.3, convert the conducted Tx power for both these radios into 1gSAR value (see Eq. (6a) and (6b)) using corresponding technology/band  $P_{limit}$  measured in Step 1, and then perform 100s running average to determine time-averaged 1gSAR versus time as illustrated in Figure A-1. Note that here it is assumed both radios have Tx frequencies < 3GHz, otherwise, 60s running average should be performed for radios having Tx frequency between 3GHz and 6GHz.
4. Make one plot containing: (a) instantaneous Tx power versus time measured in Step 2.
5. Make another plot containing: (a) instantaneous 1gSAR versus time determined in Step 3, (b) computed time-averaged 1gSAR versus time determined in Step 3, and (c) corresponding regulatory  $1gSAR_{limit}$  of 1.6 W/kg.

The validation criteria is, at all times, the time-averaged 1gSAR versus time shall not exceed the regulatory  $1gSAR_{limit}$  of 1.6 W/kg.

### B.3 Switch in SAR exposure between LTE vs. Sub6 NR during transmission

For Sub6 NR TDD test cases, a modified procedure was used due to a limitation of the available test equipment.

#### Test procedure for Conducted Test Sequences:

1. Measure  $P_{max}$ , measure  $P_{limit}$  and calculate  $P_{reserve}$  (= measured  $P_{limit}$  in dBm = *Reserve\_power\_margin* in dB) and follow Section 3.1 to generate the test sequences for all the technologies and bands selected in Section 3.2.1. Both test sequence 1 and test sequence 2 are created based on generated Pmax\_sequences of the DUT as described below. Test condition to measure  $P_{max}$  and  $P_{limit}$  is:
  - a. Measure Pmax\_online\_avg\_dBm with Smart Transmit disabled and callbox set to request maximum power.
  - b. Measure Plimit\_online\_avg\_dBm with Smart Transmit enabled and *Reserve\_power\_margin* set to 0 dB, callbox set to request maximum power.
  - c. Measure Plimit\_ftm\_dBm in FTM Mode at 25% Duty Cycle.
  - d. Calculate the DutyCycle\_dB = Plimit\_ftm\_dBm – Plimit\_online\_avg\_dBm + 6 dB
  - e. Calculate Pmax\_sequence = Pmax\_online\_avg\_dBm + DutyCycle\_dB
  - f. Calculate Plimit\_sequence = Plimit\_online\_avg\_dBm + DutyCycle\_dB
2. Follow remaining steps in Section 3.3.1 to complete time-varying Tx test cases

For the SAR test cases, the procedure in Section 3.4 applies however the initial area scan as described in section 3.4 step 2) i) is performed with the device in FTM mode.



## **Appendixes**

**Refer to separated files for the following appendixes.**

**4789867826-S1 FCC Report RF exposure\_App A\_Test setup photos**

**4789867826-S1 FCC Report RF exposure\_App B\_System Check plots**

**End OF REPORT**