

## 12. WORST-CASE BELOW 1 GHz

### SPURIOUS EMISSIONS 30 TO 1000 MHz (WORST-CASE CONFIGURATION, HORIZONTAL)

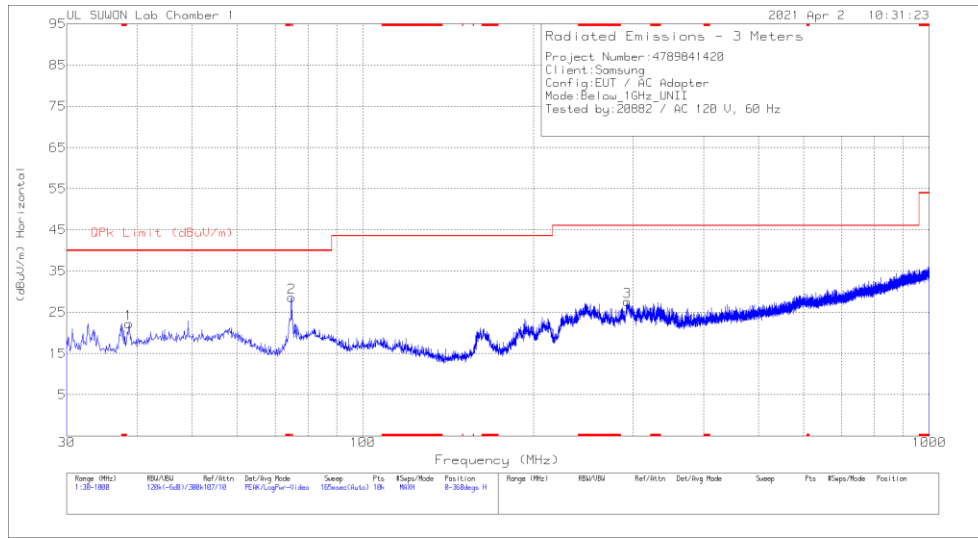

### SPURIOUS EMISSIONS 30 TO 1000 MHz (WORST-CASE CONFIGURATION, VERTICAL)

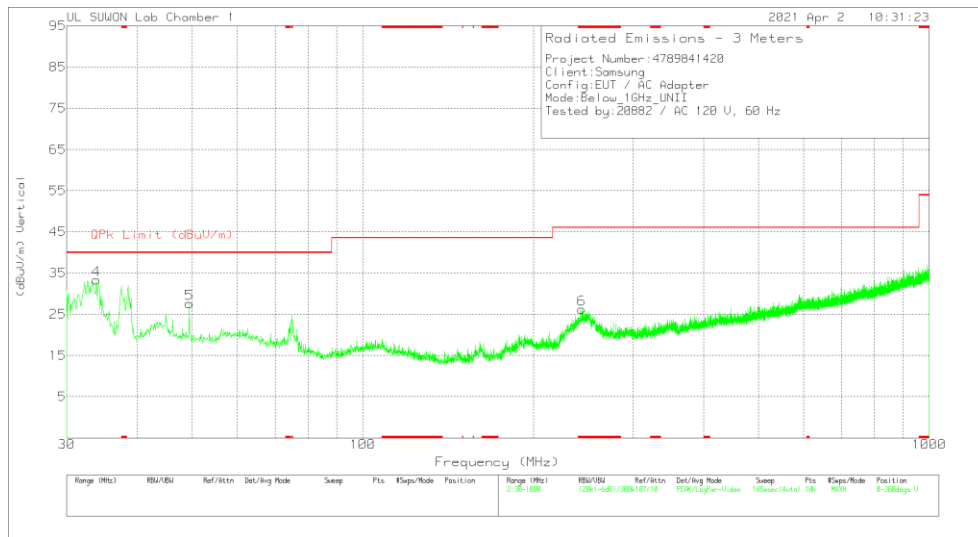

#### Below 1G Data

Marker	Frequency (MHz)	Meter Reading (dBuV)	Det	VULB9163_750	Below_1G[dB]	DC Corr (dB)	Corrected Reading (dBuV/m)	QPk Limit (dBuV/m)	Margin (dB)	Azimuth (Degs)	Height (cm)	Polarity
1	38.633	34.89	Pk	18.2	-30.8	0	22.29	40	-17.71	0-360	200	H
2	* 74.814	45.14	Pk	13.5	-30	0	28.64	40	-11.36	0-360	300	H
3	293.355	36.09	Pk	19.2	-27.7	0	27.59	46.02	-18.43	0-360	100	H
4	33.88	47.97	Pk	16.2	-30.8	0	33.37	40	-6.63	0-360	100	V
5	49.4	38.21	Pk	19.8	-30.4	0	27.61	40	-12.39	0-360	200	V
6	* 243.691	36.07	Pk	18.3	-28.1	0	26.27	46.02	-19.75	0-360	100	V

\* - indicates frequency in CFR47 Pt 15 / IC RSS-Restricted Band

Pk - Peak detector

### 13. AC POWER LINE CONDUCTED EMISSIONS

#### LIMITS

FCC §15.207 (a)  
IC RSS-GEN Clause 8.8

Frequency of Emission (MHz)	Conducted Limit (dBuV)	
	Quasi-peak	Average
0.15-0.5	66 to 56 <sup>*</sup>	56 to 46 <sup>*</sup>
0.5-5	56	46
5-30	60	50

<sup>\*</sup>Decreases with the logarithm of the frequency.

#### TEST PROCEDURE

The EUT is placed on a non-conducting table 40 cm from the vertical ground plane and 80 cm above the horizontal ground plane. The EUT is configured in accordance with ANSI C63.10.

The receiver is set to a resolution bandwidth of 9 kHz. Peak detection is used unless otherwise noted as quasi-peak or average.

Line conducted data is recorded for both NEUTRAL and HOT lines.

#### RESULTS

**WORST EMISSIONS**

**LINE 1 DATA**

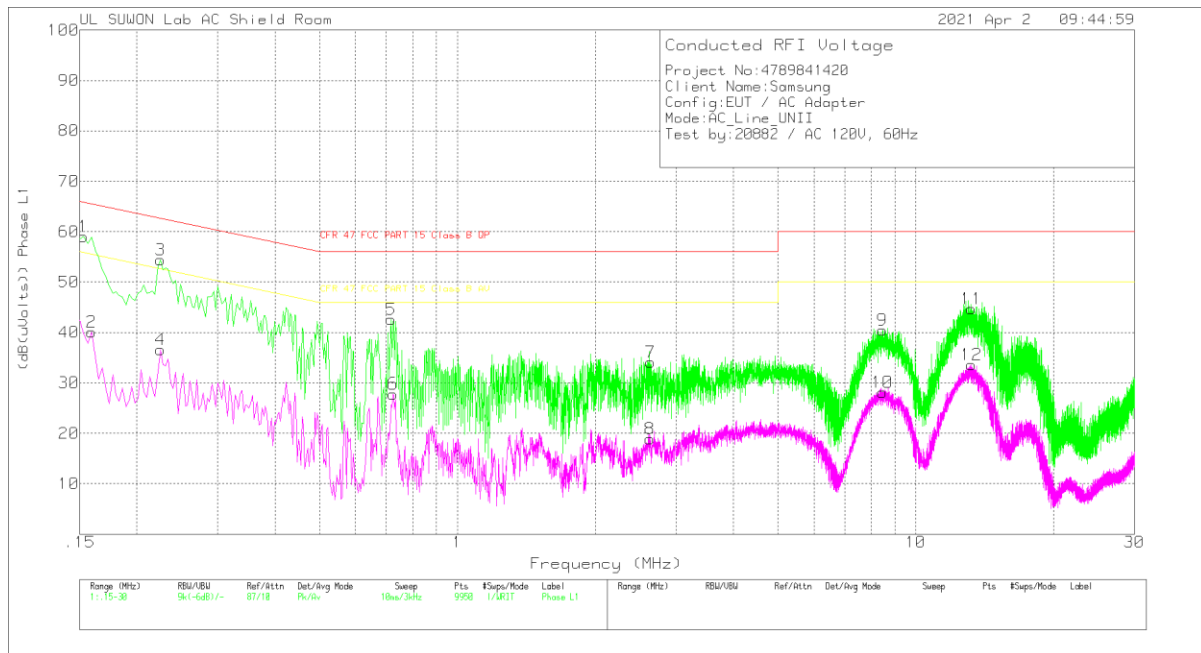

**Trace Markers**

Range 1: Phase L1 .15 - 30MHz

Marker	Frequency (MHz)	Meter Reading (dBuV)	Det	101836_With EX_L1[dB]	CABLELOS S(dB)	Corrected Reading (dB(uVolts))	CFR 47 FCC PART 15 Class B QP	Margin (dB)	CFR 47 FCC PART 15 Class B AV	Margin (dB)
1	.153	49.12	Pk	9.8	.1	59.02	65.84	-6.82	-	-
2	.159	30.1	Av	9.9	.1	40.1	-	-	55.52	-15.42
3	.225	44.39	Pk	9.8	.2	54.39	62.63	-8.24	-	-
4	.225	26.65	Av	9.8	.2	36.65	-	-	52.63	-15.98
5	.717	32.53	Pk	9.9	.2	42.63	56	-13.37	-	-
6	.723	17.71	Av	9.9	.2	27.81	-	-	46	-18.19
7	2.643	24.13	Pk	9.7	.3	34.13	56	-21.87	-	-
8	2.634	8.86	Av	9.7	.3	18.86	-	-	46	-27.14
9	8.454	30.31	Pk	9.9	.3	40.51	60	-19.49	-	-
10	8.46	17.96	Av	9.9	.3	28.16	-	-	50	-21.84
11	13.245	34.33	Pk	10	.4	44.73	60	-15.27	-	-
12	13.245	23.15	Av	10	.4	33.55	-	-	50	-16.45

Pk - Peak detector

Av - Average detection

**Quasi-Peak Emissions**

Range 1: Phase L1 .15 - 30MHz

Frequency (MHz)	Meter Reading (dBuV)	Det	101836_With EX_L1[dB]	CABLELOS S(dB)	Corrected Reading (dB(uVolts))	CFR 47 FCC PART 15 Class B QP	Margin (dB)	CFR 47 FCC PART 15 Class B AV	Margin (dB)
.15375	26.94	Qp	9.8	.1	36.84	65.79	-28.95	-	-
.15915	25.03	Qp	9.9	.1	35.03	65.51	-30.48	-	-
.22425	23.94	Qp	9.8	.2	33.94	62.66	-28.72	-	-

Qp - Quasi-Peak detector

LINE 2 DATA

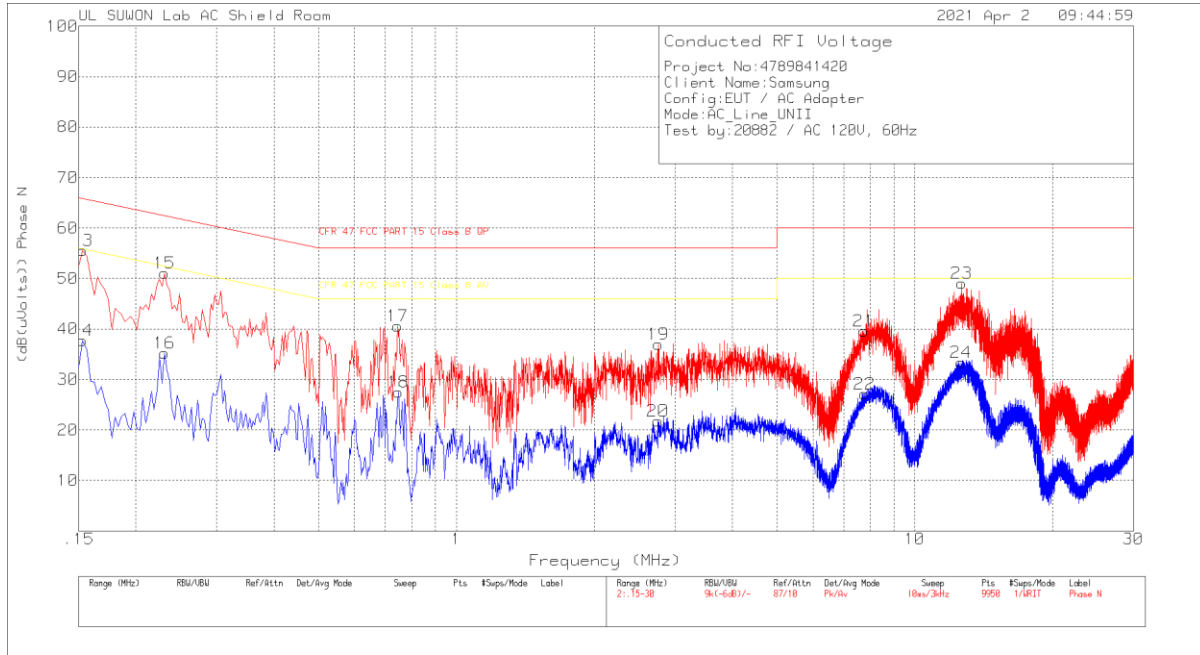

Trace Markers

Range 2: Phase N .15 - 30MHz

Marker	Frequency (MHz)	Meter Reading (dBuV)	Det	101836_Wit h EX_N[dB]	CABLELOS S(dB)	Corrected Reading (dB(uVolts))	CFR 47 FCC PART 15 Class B QP	Margin (dB)	CFR 47 FCC PART 15 Class B AV	Margin (dB)
13	.153	45.61	Pk	9.8	.1	55.51	65.84	-10.33	-	-
14	.153	27.83	Av	9.8	.1	37.73	-	-	55.84	-18.11
15	.231	41.11	Pk	9.8	.2	51.11	62.41	-11.3	-	-
16	.231	25.21	Av	9.8	.2	35.21	-	-	52.41	-17.2
17	.744	30.43	Pk	9.9	.2	40.53	56	-15.47	-	-
18	.747	17.37	Av	9.9	.2	27.47	-	-	46	-18.53
19	2.757	26.85	Pk	9.8	.3	36.95	56	-19.05	-	-
20	2.754	11.63	Av	9.8	.3	21.73	-	-	46	-24.27
21	7.758	29.42	Pk	9.9	.3	39.62	60	-20.38	-	-
22	7.767	16.98	Av	9.9	.3	27.18	-	-	50	-22.82
23	12.648	38.81	Pk	10	.3	49.11	60	-10.89	-	-
24	12.615	23	Av	10	.3	33.3	-	-	50	-16.7

Pk - Peak detector

Av - Average detection

## 14. DYNAMIC FREQUENCY SELECTION

### 14.1. OVERVIEW

#### 14.1.1. LIMITS

#### FCC

§15.407 (h), FCC KDB 905462 D02 “COMPLIANCE MEASUREMENT PROCEDURES FOR UNLICENSED-NATIONAL INFORMATION INFRASTRUCTURE DEVICES OPERATING IN THE 5250-5350 MHz AND 5470-5725 MHz BANDS INCORPORATING DYNAMIC FREQUENCY SELECTION” and KDB 905462 D03 “U-NII CLIENT DEVICES WITHOUT RADAR DETECTION CAPABILITY”.

**Table 1: Applicability of DFS requirements prior to use of a channel**

Requirement	Operational Mode		
	Master	Client (without radar detection)	Client (with radar detection)
Non-Occupancy Period	Yes	Not required	Yes
DFS Detection Threshold	Yes	Not required	Yes
Channel Availability Check Time	Yes	Not required	Not required
U-NII Detection Bandwidth	Yes	Not required	Yes

**Table 2: Applicability of DFS requirements during normal operation**

Requirement	Operational Mode		
	Master	Client (without DFS)	Client (with DFS)
DFS Detection Threshold	Yes	Not required	Yes
Channel Closing Transmission Time	Yes	Yes	Yes
Channel Move Time	Yes	Yes	Yes
U-NII Detection Bandwidth	Yes	Not required	Yes

Additional requirements for devices with multiple bandwidth modes	Master Device or Client with Radar DFS	Client (without DFS)
U-NII Detection Bandwidth and Statistical Performance Check	All BW modes must be tested	Not required
Channel Move Time and Channel Closing Transmission Time	Test using widest BW mode available	Test using the widest BW mode available for the link
All other tests	Any single BW mode	Not required

**Note:** Frequencies selected for statistical performance check (Section 7.8.4) should include several frequencies within the radar detection bandwidth and frequencies near the edge of the radar detection bandwidth. For 802.11 devices it is suggested to select frequencies in all 20 MHz channel blocks and a null frequency between the bonded 20 MHz channel blocks.

**Table 3: Interference Threshold values, Master or Client incorporating In-Service Monitoring**

Maximum Transmit Power	Value (see notes)
E.I.R.P. $\geq$ 200 mill watt	-64 dBm
E.I.R.P. < 200 mill watt and power spectral density < 10 dBm/MHz	-62 dBm
E.I.R.P. < 200 mill watt that do not meet power spectral density requirement	-64 dBm
<p><b>Note 1:</b> This is the level at the input of the receiver assuming a 0 dBi receive antenna  <b>Note 2:</b> Throughout these test procedures an additional 1 dB has been added to the amplitude of the test transmission waveforms to account for variations in measurement equipment. This will ensure that the test signal is at or above the detection threshold level to trigger a DFS response.  <b>Note 3:</b> E.I.R.P. is based on the highest antenna gain. For MIMO devices refer to KDB publication 662911 D01.</p>	

**Table 4: DFS Response requirement values**

Parameter	Value
<i>Non-occupancy period</i>	30 minutes
<i>Channel Availability Check Time</i>	60 seconds
<i>Channel Move Time</i>	10 seconds (See Note 1)
<i>Channel Closing Transmission Time</i>	200 milliseconds + approx. 60 milliseconds over remaining 10 second period. (See Notes 1 and 2)
<i>U-NII Detection Bandwidth</i>	Minimum 100% of the U- NII 99% transmission power bandwidth. (See Note 3)
<p><b>Note 1:</b> <i>Channel Move Time</i> and the <i>Channel Closing Transmission Time</i> should be performed with Radar Type 0. The measurement timing begins at the end of the Radar Type 0 burst.  <b>Note 2:</b> The <i>Channel Closing Transmission Time</i> is comprised of 200 milliseconds starting at the beginning of the <i>Channel Move Time</i> plus any additional intermittent control signals required to facilitate a <i>Channel</i> move (an aggregate of 60 milliseconds) during the remainder of the 10 second period. The aggregate duration of control signals will not count quiet periods in between transmissions.  <b>Note 3:</b> During the <i>U-NII Detection Bandwidth</i> detection test, radar type 0 should be used. For each frequency step the minimum percentage of detection is 90 percent. Measurements are performed with no data traffic.</p>	

**Table 5 – Short Pulse Radar Test Waveforms**

Radar Type	Pulse Width (usec)	PRI (usec)	Pulses	Minimum Percentage of Successful Detection	Minimum Trials
0	1	1428	18	See Note 1	See Note 1
1	1	Test A: 15 unique PRI values randomly selected from the list of 23 PRI values in table 5a	Roundup: $\{(1/360) \times (19 \times 10^6 \text{ PRI}_{\text{usec}})\}$	60%	30
		Test B: 15 unique PRI values randomly selected within the range of 518-3066 usec. With a minimum increment of 1 usec, excluding PRI values selected in Test A			
2	1-5	150-230	23-29	60%	30
3	6-10	200-500	16-18	60%	30
4	11-20	200-500	12-16	60%	30
Aggregate (Radar Types 1-4)				80%	120
<b>Note 1:</b> Short Pulse Radar Type 0 should be used for the <i>Detection Bandwidth</i> test, <i>Channel Move Time</i> , and <i>Channel Closing Time</i> tests.					

**Table 6 – Long Pulse Radar Test Signal**

Radar Waveform Type	Pulse Width (μsec)	Chirp Width (MHz)	PRI (μsec)	Pulses per Burst	Number of Bursts	Minimum Percentage of Successful Detection	Minimum Trials
5	50-100	5-20	1000-2000	1-3	8-20	80%	30

**Table 7 – Frequency Hopping Radar Test Signal**

Radar Waveform Type	Pulse Width (μsec)	PRI (μsec)	Pulses per Hop	Hopping Rate (kHz)	Hopping Sequence Length (msec)	Minimum Percentage of Successful Detection	Minimum Trials
6	1	333	9	0.333	300	70%	30

### 14.1.2. TEST AND MEASUREMENT SYSTEM

#### CONDUCTED METHOD SYSTEM BLOCK DIAGRAM

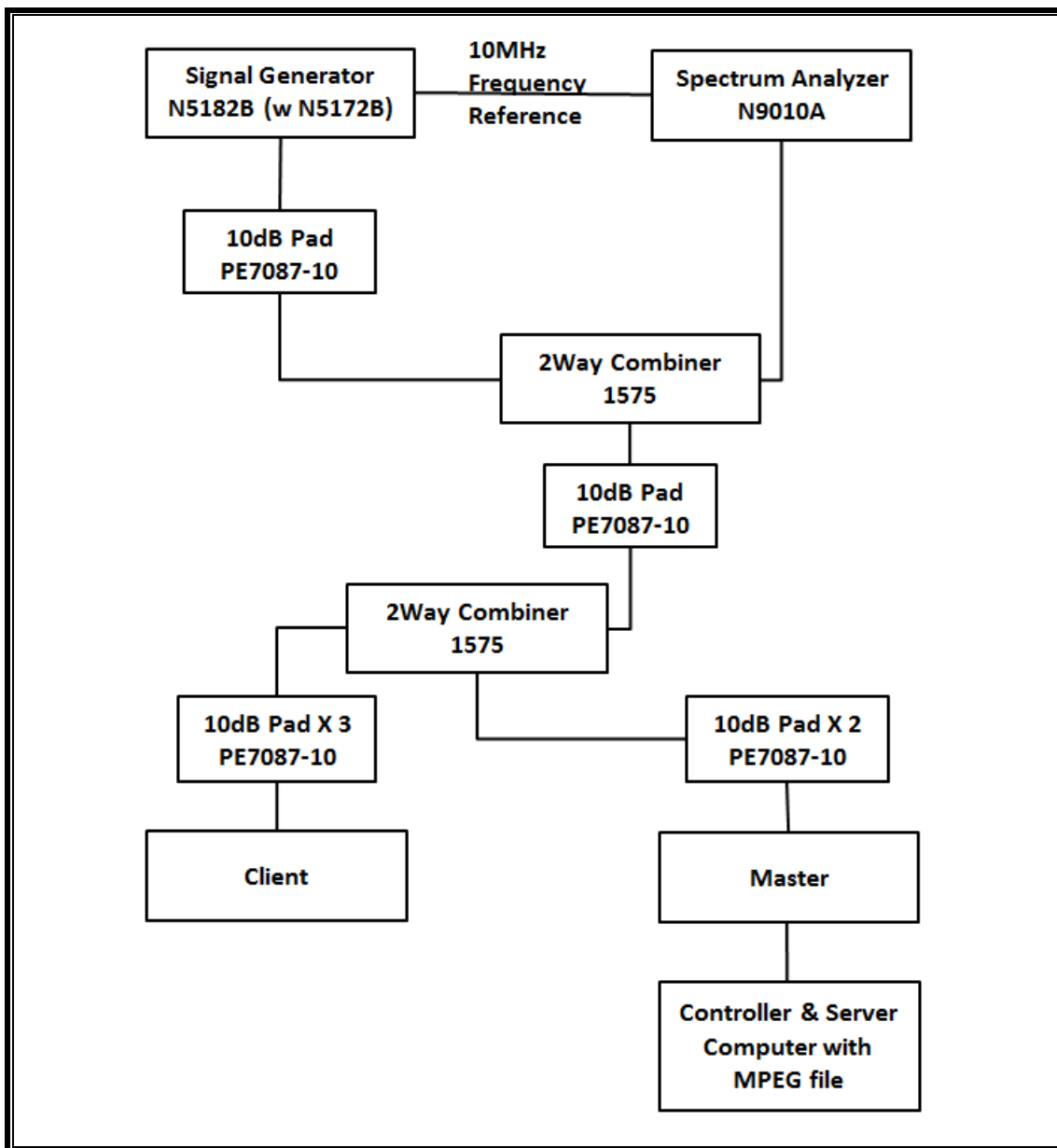



## **SYSTEM OVERVIEW**

The short pulse and long pulse signal generating system utilizes the Keysite Signal Studio for Pulse Building as N5172B. The Vector Signal Generator has been validated by the NTIA. The hopping signal generating system utilizes the CCS simulated hopping method and system, which has been validated by the DoD, FCC and NTIA. The software selects waveform parameters from within the bounds of the signal type on a random basis using uniform distribution.

The short pulse types 1, 2, 3 and 4, and the long pulse type 5 parameters are randomized at run-time.

The hopping type 6 pulse parameters are fixed while the hopping sequence is based on the August 2005 NTIA Hopping Frequency List. The initial starting point randomized at run-time and each subsequent starting point is incremented by 475. Each frequency in the 100-length segment is compared to the boundaries of the EUT Detection Bandwidth and the software creates a hopping burst pattern in accordance with Section 7.4.1.3 Method #2 Simulated Frequency Hopping Radar Waveform Generating Subsystem of KDB 905462 D02. The frequency of the signal generator is incremented in 1 MHz steps from  $F_L$  to  $F_H$  for each successive trial. This incremental sequence is repeated as required to generate a minimum of 30 total trials and to maintain a uniform frequency distribution over the entire Detection Bandwidth.

The signal monitoring equipment consists of a spectrum analyzer. The aggregate ON time is calculated by multiplying the number of bins above a threshold during a particular observation period by the dwell time per bin, with the analyzer set to peak detection and max hold.

## **SYSTEM CALIBRATION**

A 50-ohm load is connected in place of the spectrum analyzer, and the spectrum analyzer is connected to a horn antenna via a coaxial cable, with the reference level offset set to (horn antenna gain – coaxial cable loss). The signal generator is set to CW mode. The amplitude of the signal generator is adjusted to yield a level of –64 dBm as measured on the spectrum analyzer.

Without changing any of the instrument settings, the spectrum analyzer is reconnected to the Common port of the Spectrum Analyzer Combiner/Divider. The Reference Level Offset of the spectrum analyzer is adjusted so that the displayed amplitude of the signal is –64 dBm.

The spectrum analyzer displays the level of the signal generator as received at the antenna ports of the Master Device. The interference detection threshold may be varied from the calibrated value of –64 dBm and the spectrum analyzer will still indicate the level as received by the Master Device.

**ADJUSTMENT OF DISPLAYED TRAFFIC LEVEL**

A link is established between the Master and Slave and the distance between the units is adjusted as needed to provide a suitable received level at the Master and Slave devices. The video test file is streamed to generate WLAN traffic. The monitoring antenna is adjusted so that the WLAN traffic level, as displayed on the spectrum analyzer, is at lower amplitude than the radar detection threshold.

**TEST AND MEASUREMENT EQUIPMENT**

The following test and measurement equipment was utilized for the DFS tests documented in this report:

TEST EQUIPMENT LIST				
Description	Manufacturer	Model	S/N	Next Cal Due
Spectrum Analyzer, 7 GHz	Agilent / HP	N9010A	MY54200580	08-05-21
Vector Signal Generator, 6GHz	Agilent / HP	N5182B	MY53051241	08-03-21
Combiner	WEINSCHTEL	WA1534	UL001	01-27-22
Combiner	WEINSCHTEL	WA1535	UL002	01-27-22

### 14.1.3. SETUP OF EUT

#### CONDUCTED METHOD EUT TEST SETUP

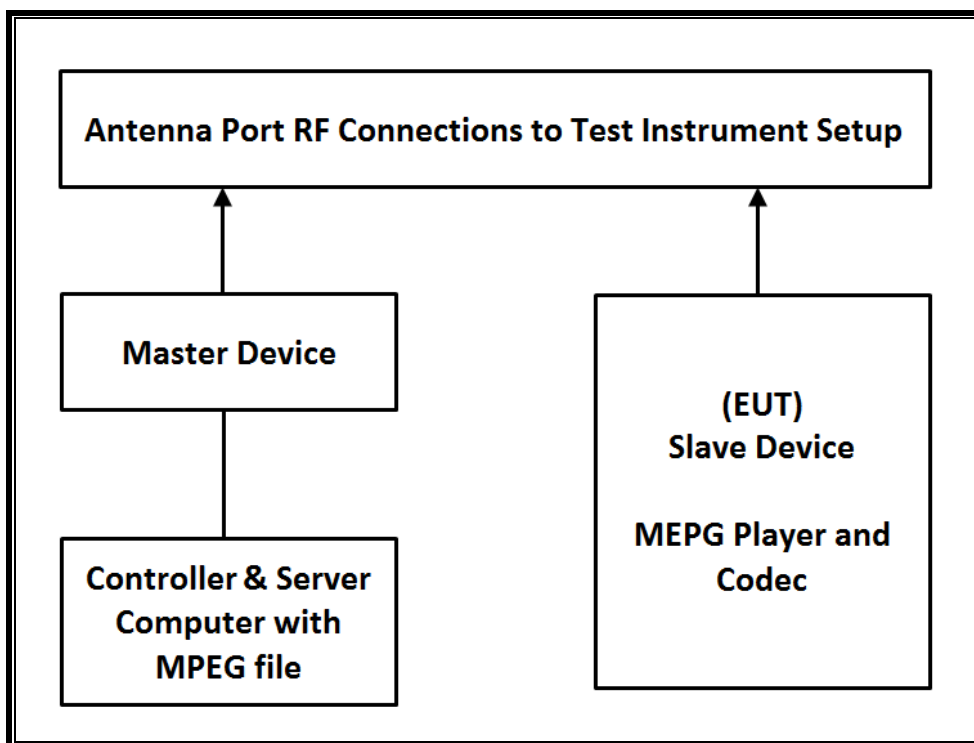

#### SUPPORT EQUIPMENT

The following support equipment was utilized for the DFS tests documented in this report:

PERIPHERAL SUPPORT EQUIPMENT LIST				
Description	Manufacturer	Model	Serial Number	FCC ID
Wireless Access Point	Cisco	AIR-CAP3702E-A-K9	FTX182276QX	LDK102087
Notebook PC (Controller/Server)	HP	HP EliteDesk 800 G1 TWR	CZC4125J25	DoC

#### **14.1.4. DESCRIPTION OF EUT**

The EUT operates over the 5250-5350 MHz and 5470-5725 MHz ranges.

The EUT is a Slave Device without Radar Detection.

The highest power level of the widest bandwidth (802.11ac VHT80) within these bands is 12.48 dBm in the 5250-5350 MHz band and 12.72 dBm in the 5470-5725 MHz band.

The antenna assembly utilized two antenna.

Gain of ANT1 : -1.64 dBi for UNII 2A and -1.67 dBi for UNII 2C.

Gain of ANT2 : -4.02 dBi for UNII 2A and -5.55 dBi for UNII 2C.

The rated output power of the Master unit is > 23dBm (EIRP). Therefore the required interference threshold level is -64 dBm. After correction for procedural adjustments, the required conducted threshold at the antenna port is  $-64 + 1 = -63$  dBm.

The calibrated radiated DFS Detection Threshold level is set to -64 dBm. The tested level is lower than the required level hence it provides a margin to the limit.

The EUT uses one transmitter/receiver chain connected to an antenna to perform radiated tests. WLAN traffic that meets or exceeds the minimum required loading was generated by transferring a data stream from the controller/server PC to the EUT using iPerf version 2.0.5 software package.

TPC is not required since the maximum EIRP is less than 500 mW (27 dBm).

The EUT utilizes the 802.11 architecture. Three nominal channel bandwidths are implemented: 20 MHz, 40 MHz and 80 MHz.

The software installed in the access point is 12.4(25d)JA1.

#### **UNIFORM CHANNEL SPREADING**

This requirement is not applicable to Slave radio devices.

#### **OVERVIEW OF MASTER DEVICE WITH RESPECT TO §15.407 (h) REQUIREMENTS**

The Master Device is a Cisco Access Point, FCC ID: LDK102087. The minimum antenna gain for the Master Device is 6 dBi.

The rated output power of the Master unit is > 23dBm (EIRP). Therefore the required interference threshold level is -64 dBm. After correction for procedural adjustments, the required radiated threshold at the antenna port is  $-64 + 1 = -63$  dBm.

The calibrated radiated DFS Detection Threshold level is set to -64 dBm. The tested level is lower than the required level hence it provides a margin to the limit.

## 14.2. RESULTS FOR 80 MHz BANDWIDTH (UNII-2A BAND)

### 14.2.1. TEST CHANNEL

All tests were performed at a channel center frequency of 5290 MHz.

### 14.2.2. RADAR WAVEFORM AND TRAFFIC

#### RADAR WAVEFORM



### 14.2.3. OVERLAPPING CHANNEL TESTS

#### RESULTS

These tests are not applicable.

### 14.2.4. MOVE AND CLOSING TIME

#### REPORTING NOTES

The reference marker is set at the end of last radar pulse.

The delta marker is set at the end of the last WLAN transmission following the radar pulse. This delta is the channel move time.

The aggregate channel closing transmission time is calculated as follows:

Aggregate Transmission Time =  
(Number of analyzer bins showing transmission) \* (dwell time per bin)

The observation period over which the aggregate time is calculated begins at (Reference Marker + 200 msec) and ends no earlier than (Reference Marker + 10 sec).

#### RESULTS

Channel Move Time (sec)	Limit (sec)
0.756	10

Aggregate Channel Closing Transmission Time (msec)	Limit (msec)
3.750	60

**MOVE TIME & CHANNEL CLOSING TIME**

**AGGREGATE CHANNEL CLOSING TRANSMISSION TIME**

No transmissions are observed during the aggregate monitoring period.

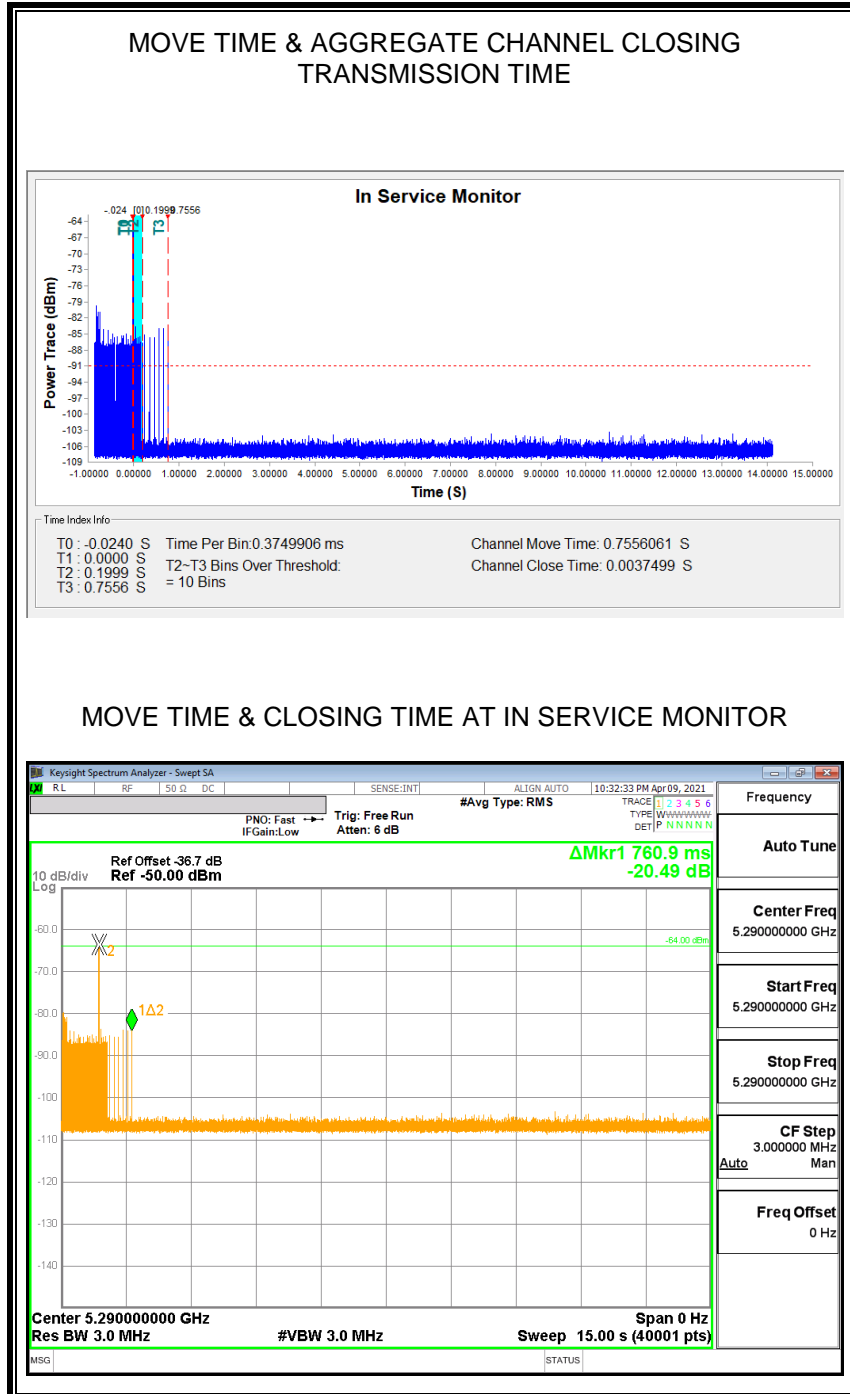

**NON-OCCUPANCY PERIOD**

**RESULTS**

No EUT transmissions were observed on the test channel during the 10-minute observation time.

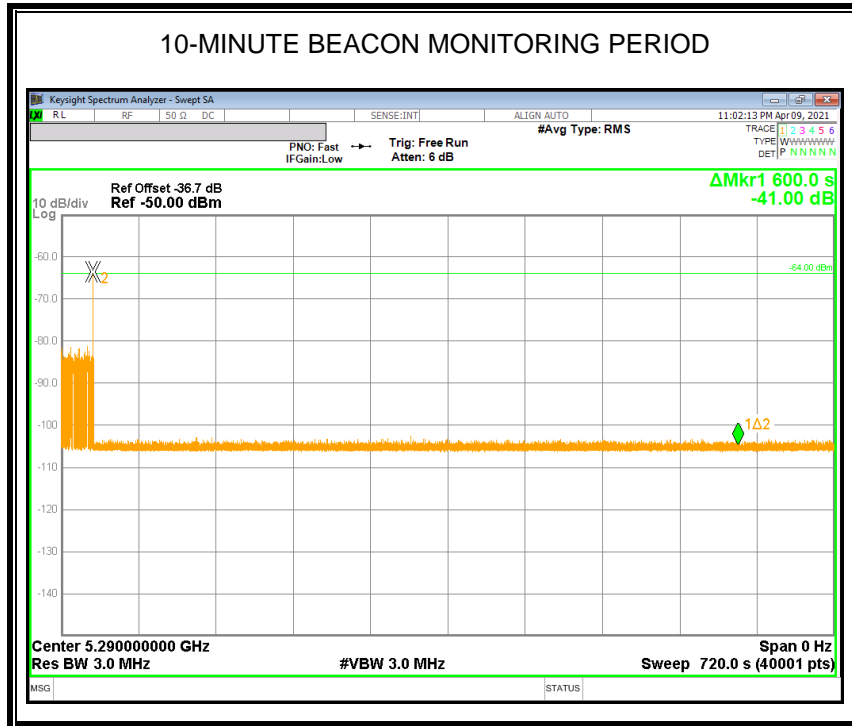



### 14.3. RESULTS FOR 80 MHz BANDWIDTH (UNII-2C BAND)

#### 14.3.1. TEST CHANNEL

All tests were performed at a channel center frequency of 5530 MHz.

#### 14.3.2. RADAR WAVEFORM AND TRAFFIC

##### RADAR WAVEFORM



### 14.3.3. OVERLAPPING CHANNEL TESTS

#### RESULTS

These tests are not applicable.

### 14.3.4. MOVE AND CLOSING TIME

#### REPORTING NOTES

The reference marker is set at the end of last radar pulse.

The delta marker is set at the end of the last WLAN transmission following the radar pulse. This delta is the channel move time.

The aggregate channel closing transmission time is calculated as follows:

Aggregate Transmission Time =  
(Number of analyzer bins showing transmission) \* (dwell time per bin)

The observation period over which the aggregate time is calculated begins at (Reference Marker + 200 msec) and ends no earlier than (Reference Marker + 10 sec).

#### RESULTS

Channel Move Time (sec)	Limit (sec)
0.713	10

Aggregate Channel Closing Transmission Time (msec)	Limit (msec)
4.125	60

**MOVE TIME & CHANNEL CLOSING TIME**

**AGGREGATE CHANNEL CLOSING TRANSMISSION TIME**

No transmissions are observed during the aggregate monitoring period.

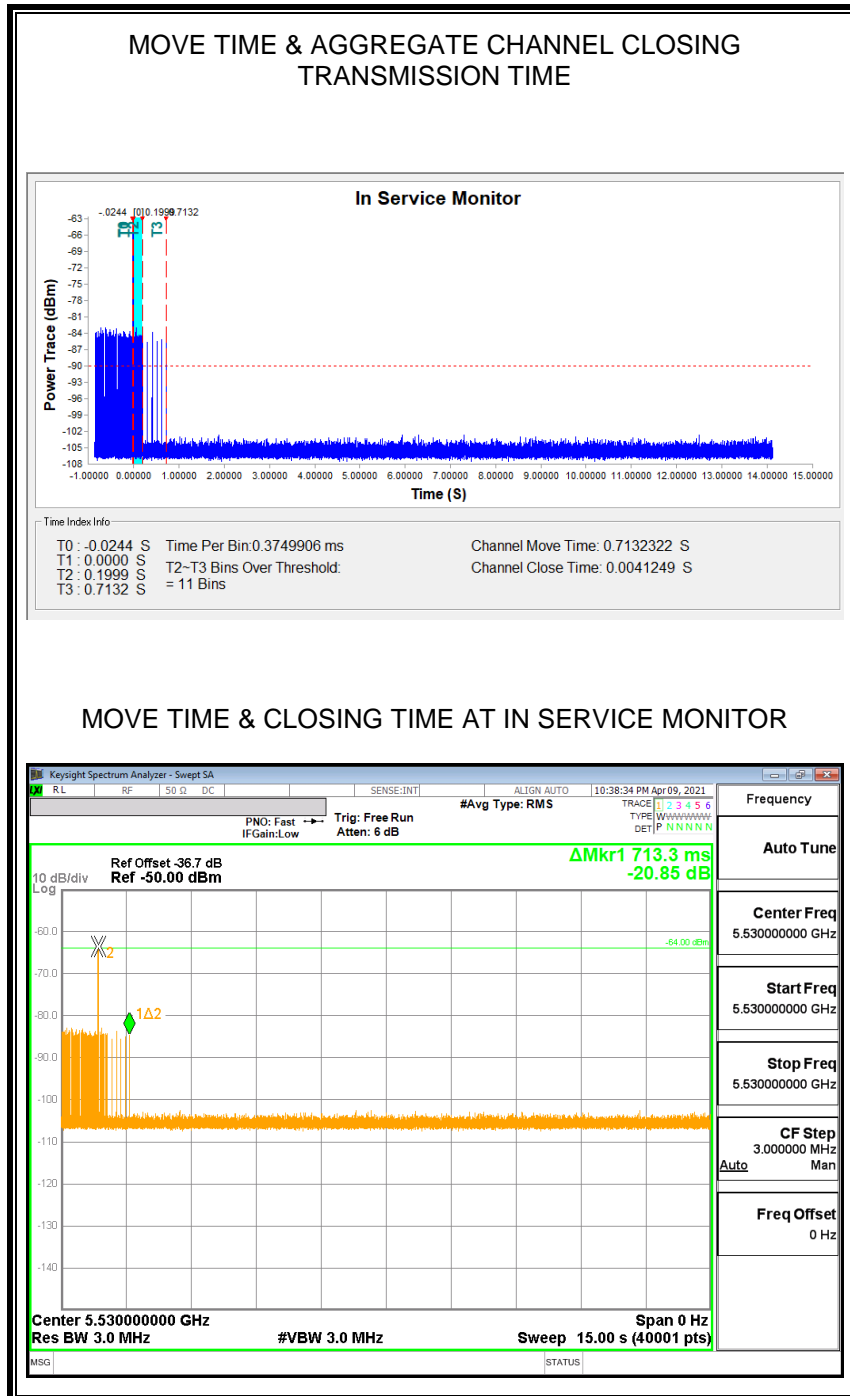

**NON-OCCUPANCY PERIOD**

**RESULTS**

No EUT transmissions were observed on the test channel during the 10-minute observation time.

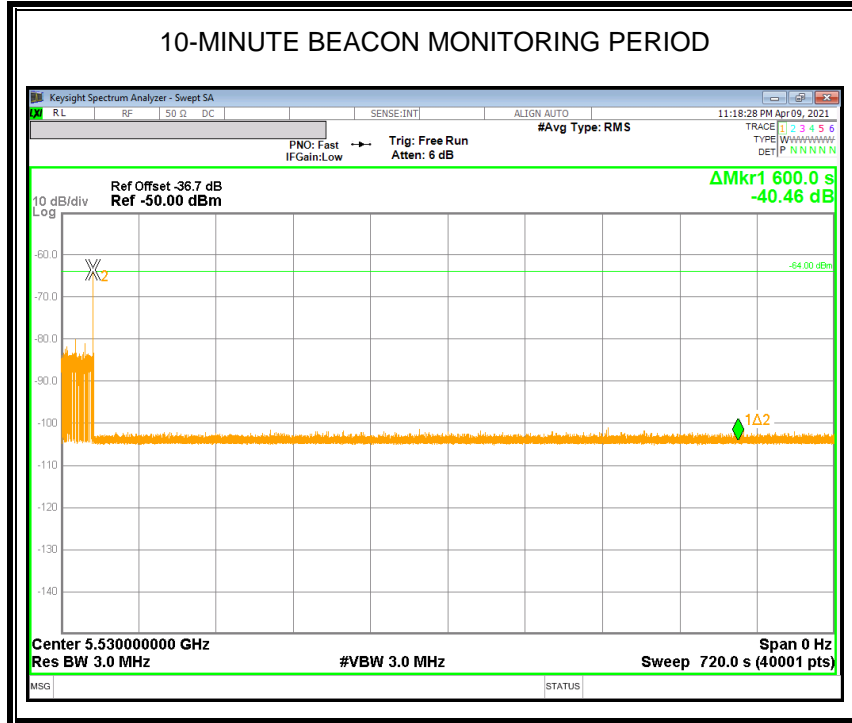

**END OF TEST REPORT**