

APPENDIX C: PROBE CALIBRATION



Accredited by the Swiss Accreditation Service (SAS)
The Swiss Accreditation Service is one of the signatories to the EA
Multilateral Agreement for the recognition of calibration certificates

Accreditation No.: **SCS 108**

Client **PC Test**

Certificate No: **D750V3-1003_Jan14**

CALIBRATION CERTIFICATE

Object **D750V3 - SN: 1003**

Calibration procedure(s) **QA CAL-05.v9
Calibration procedure for dipole validation kits above 700 MHz**

Calibration date: **January 20, 2014**

*CC
21/14 ✓*

This calibration certificate documents the traceability to national standards, which realize the physical units of measurements (SI).
The measurements and the uncertainties with confidence probability are given on the following pages and are part of the certificate.

All calibrations have been conducted in the closed laboratory facility: environment temperature (22 ± 3)°C and humidity < 70%.

Calibration Equipment used (M&TE critical for calibration)

Primary Standards	ID #	Cal Date (Certificate No.)	Scheduled Calibration
Power meter EPM-442A	GB37480704	09-Oct-13 (No. 217-01827)	Oct-14
Power sensor HP 8481A	US37292783	09-Oct-13 (No. 217-01827)	Oct-14
Power sensor HP 8481A	MY41092317	09-Oct-13 (No. 217-01828)	Oct-14
Reference 20 dB Attenuator	SN: 5058 (20k)	04-Apr-13 (No. 217-01736)	Apr-14
Type-N mismatch combination	SN: 5047.3 / 06327	04-Apr-13 (No. 217-01739)	Apr-14
Reference Probe ES3DV3	SN: 3205	30-Dec-13 (No. ES3-3205_Dec13)	Dec-14
DAE4	SN: 601	25-Apr-13 (No. DAE4-601_Apr13)	Apr-14
Secondary Standards	ID #	Check Date (in house)	Scheduled Check
RF generator R&S SMT-06	100005	04-Aug-99 (in house check Oct-13)	In house check: Oct-16
Network Analyzer HP 8753E	US37390585 S4206	18-Oct-01 (in house check Oct-13)	In house check: Oct-14

Calibrated by: **Israe El-Naouq** Laboratory Technician
Approved by: **Katja Pokovic** Technical Manager

Signature
Israe El-Naouq
Katja Pokovic

Issued: January 21, 2014

This calibration certificate shall not be reproduced except in full without written approval of the laboratory.



Accredited by the Swiss Accreditation Service (SAS)

The Swiss Accreditation Service is one of the signatories to the EA
Multilateral Agreement for the recognition of calibration certificates

Accreditation No.: **SCS 108**

Glossary:

TSL	tissue simulating liquid
ConvF	sensitivity in TSL / NORM x,y,z
N/A	not applicable or not measured

Calibration is Performed According to the Following Standards:

- IEEE Std 1528-2013, "IEEE Recommended Practice for Determining the Peak Spatial-Averaged Specific Absorption Rate (SAR) in the Human Head from Wireless Communications Devices: Measurement Techniques", June 2013
- IEC 62209-1, "Procedure to measure the Specific Absorption Rate (SAR) for hand-held devices used in close proximity to the ear (frequency range of 300 MHz to 3 GHz)", February 2005
- KDB 865664, "SAR Measurement Requirements for 100 MHz to 6 GHz"

Additional Documentation:

- DASY4/5 System Handbook

Methods Applied and Interpretation of Parameters:

- Measurement Conditions:** Further details are available from the Validation Report at the end of the certificate. All figures stated in the certificate are valid at the frequency indicated.
- Antenna Parameters with TSL:** The dipole is mounted with the spacer to position its feed point exactly below the center marking of the flat phantom section, with the arms oriented parallel to the body axis.
- Feed Point Impedance and Return Loss:** These parameters are measured with the dipole positioned under the liquid filled phantom. The impedance stated is transformed from the measurement at the SMA connector to the feed point. The Return Loss ensures low reflected power. No uncertainty required.
- Electrical Delay:** One-way delay between the SMA connector and the antenna feed point. No uncertainty required.
- SAR measured:** SAR measured at the stated antenna input power.
- SAR normalized:** SAR as measured, normalized to an input power of 1 W at the antenna connector.
- SAR for nominal TSL parameters:** The measured TSL parameters are used to calculate the nominal SAR result.

The reported uncertainty of measurement is stated as the standard uncertainty of measurement multiplied by the coverage factor $k=2$, which for a normal distribution corresponds to a coverage probability of approximately 95%.

Measurement Conditions

DASY system configuration, as far as not given on page 1.

DASY Version	DASY5	V52.8.7
Extrapolation	Advanced Extrapolation	
Phantom	Modular Flat Phantom	
Distance Dipole Center - TSL	15 mm	with Spacer
Zoom Scan Resolution	dx, dy, dz = 5 mm	
Frequency	750 MHz \pm 1 MHz	

Head TSL parameters

The following parameters and calculations were applied.

	Temperature	Permittivity	Conductivity
Nominal Head TSL parameters	22.0 °C	41.9	0.89 mho/m
Measured Head TSL parameters	(22.0 \pm 0.2) °C	40.8 \pm 6 %	0.92 mho/m \pm 6 %
Head TSL temperature change during test	< 0.5 °C	----	----

SAR result with Head TSL

SAR averaged over 1 cm³ (1 g) of Head TSL	Condition	
SAR measured	250 mW input power	2.16 W/kg
SAR for nominal Head TSL parameters	normalized to 1W	8.37 W/kg \pm 17.0 % (k=2)

SAR averaged over 10 cm³ (10 g) of Head TSL	condition	
SAR measured	250 mW input power	1.40 W/kg
SAR for nominal Head TSL parameters	normalized to 1W	5.46 W/kg \pm 16.5 % (k=2)

Body TSL parameters

The following parameters and calculations were applied.

	Temperature	Permittivity	Conductivity
Nominal Body TSL parameters	22.0 °C	55.5	0.96 mho/m
Measured Body TSL parameters	(22.0 \pm 0.2) °C	54.0 \pm 6 %	0.98 mho/m \pm 6 %
Body TSL temperature change during test	< 0.5 °C	----	----

SAR result with Body TSL

SAR averaged over 1 cm³ (1 g) of Body TSL	Condition	
SAR measured	250 mW input power	2.24 W/kg
SAR for nominal Body TSL parameters	normalized to 1W	8.77 W/kg \pm 17.0 % (k=2)

SAR averaged over 10 cm³ (10 g) of Body TSL	condition	
SAR measured	250 mW input power	1.47 W/kg
SAR for nominal Body TSL parameters	normalized to 1W	5.78 W/kg \pm 16.5 % (k=2)

Appendix

Antenna Parameters with Head TSL

Impedance, transformed to feed point	54.7 Ω - 0.2 j Ω
Return Loss	- 27.0 dB

Antenna Parameters with Body TSL

Impedance, transformed to feed point	49.5 Ω - 2.6 j Ω
Return Loss	- 31.4 dB

General Antenna Parameters and Design

Electrical Delay (one direction)	1.043 ns
----------------------------------	----------

After long term use with 100W radiated power, only a slight warming of the dipole near the feedpoint can be measured.

The dipole is made of standard semirigid coaxial cable. The center conductor of the feeding line is directly connected to the second arm of the dipole. The antenna is therefore short-circuited for DC-signals. On some of the dipoles, small end caps are added to the dipole arms in order to improve matching when loaded according to the position as explained in the "Measurement Conditions" paragraph. The SAR data are not affected by this change. The overall dipole length is still according to the Standard.

No excessive force must be applied to the dipole arms, because they might bend or the soldered connections near the feedpoint may be damaged.

Additional EUT Data

Manufactured by	SPEAG
Manufactured on	January 21, 2009

DASY5 Validation Report for Head TSL

Date: 20.01.2014

Test Laboratory: SPEAG, Zurich, Switzerland

DUT: Dipole 750 MHz; Type: D750V3; Serial: D750V3 - SN: 1003

Communication System: UID 0 - CW; Frequency: 750 MHz

Medium parameters used: $f = 750$ MHz; $\sigma = 0.92$ S/m; $\epsilon_r = 40.8$; $\rho = 1000$ kg/m³

Phantom section: Flat Section

Measurement Standard: DASY5 (IEEE/IEC/ANSI C63.19-2007)

DASY52 Configuration:

- Probe: ES3DV3 - SN3205; ConvF(6.37, 6.37, 6.37); Calibrated: 30.12.2013;
- Sensor-Surface: 3mm (Mechanical Surface Detection)
- Electronics: DAE4 Sn601; Calibrated: 25.04.2013
- Phantom: Flat Phantom 4.9L; Type: QD000P49AA; Serial: 1001
- DASY52 52.8.7(1137); SEMCAD X 14.6.10(7164)

Dipole Calibration for Head Tissue/Pin=250 mW, d=15mm/Zoom Scan (7x7x7)/Cube 0:

Measurement grid: dx=5mm, dy=5mm, dz=5mm

Reference Value = 53.711 V/m; Power Drift = 0.02 dB

Peak SAR (extrapolated) = 3.27 W/kg

SAR(1 g) = 2.16 W/kg; SAR(10 g) = 1.4 W/kg

Maximum value of SAR (measured) = 2.51 W/kg

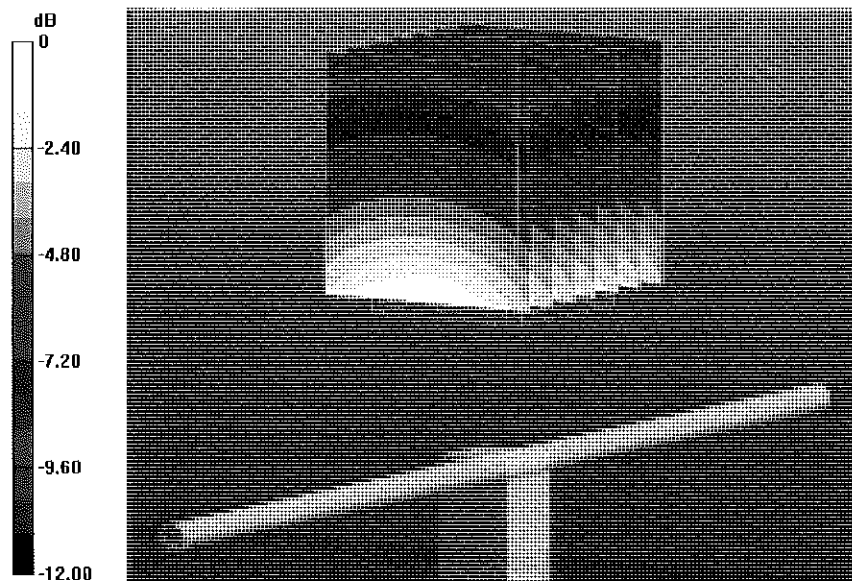

0 dB = 2.51 W/kg = 4.00 dBW/kg

Impedance Measurement Plot for Head TSL

20 Jan 2014 16:36:06

CH1 S11 1 U FS

1: 54.678 Ω -156.25 m \angle 1.3581 nF 750.000 000 MHz

*
De1

C Δ

Avg
16

H1d

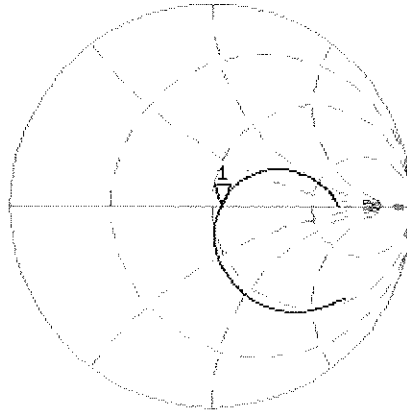

CH2 S11 LOG 5 dB/REF -20 dB 1: -26.992 dB 750.000 000 MHz

C Δ

Avg
16

H1d

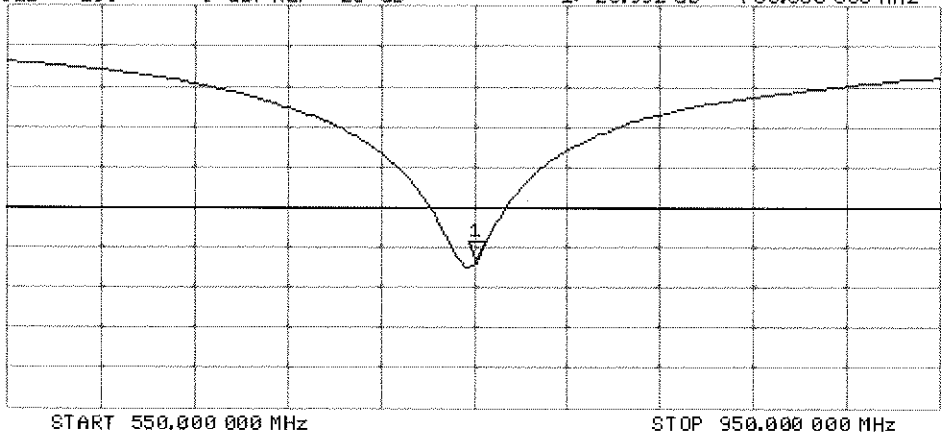

DASY5 Validation Report for Body TSL

Date: 20.01.2014

Test Laboratory: SPEAG, Zurich, Switzerland

DUT: Dipole 750 MHz; Type: D750V3; Serial: D750V3 - SN: 1003

Communication System: UID 0 - CW; Frequency: 750 MHz

Medium parameters used: $f = 750$ MHz; $\sigma = 0.98$ S/m; $\epsilon_r = 54$; $\rho = 1000$ kg/m³

Phantom section: Flat Section

Measurement Standard: DASY5 (IEEE/IEC/ANSI C63.19-2007)

DASY52 Configuration:

- Probe: ES3DV3 - SN3205; ConvF(6.13, 6.13, 6.13); Calibrated: 30.12.2013;
- Sensor-Surface: 3mm (Mechanical Surface Detection)
- Electronics: DAE4 Sn601; Calibrated: 25.04.2013
- Phantom: Flat Phantom 4.9L; Type: QD000P49AA; Serial: 1001
- DASY52 52.8.7(1137); SEMCAD X 14.6.10(7164)

Dipole Calibration for Body Tissue/Pin=250 mW, d=15mm/Zoom Scan (7x7x7)/Cube 0:

Measurement grid: dx=5mm, dy=5mm, dz=5mm

Reference Value = 53.082 V/m; Power Drift = 0.03 dB

Peak SAR (extrapolated) = 3.31 W/kg

SAR(1 g) = 2.24 W/kg; SAR(10 g) = 1.47 W/kg

Maximum value of SAR (measured) = 2.58 W/kg

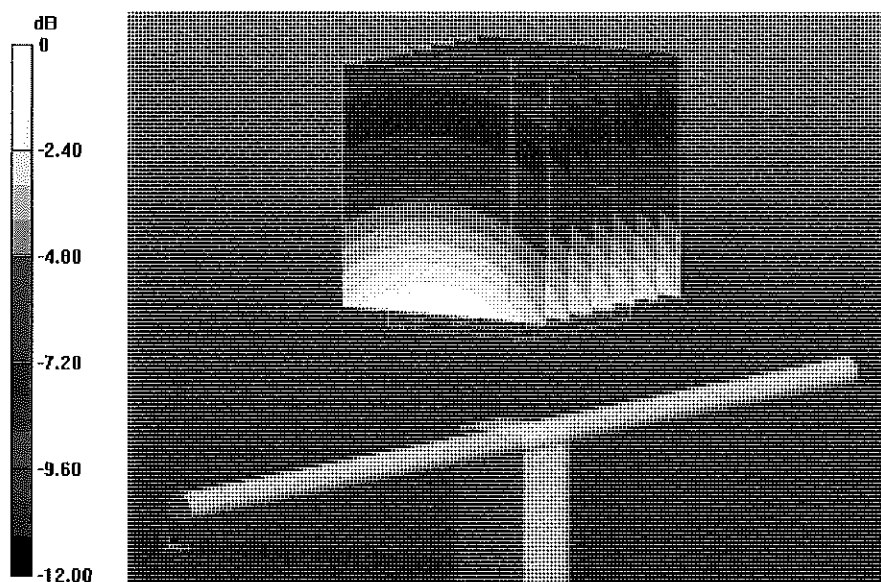

0 dB = 2.58 W/kg = 4.12 dBW/kg

Impedance Measurement Plot for Body TSL

20 Jan 2014 10:20:18

CH1 S11 1 U FS 1: 49.459 Ω -2.6367 Ω 80.481 pF 750.000 000 MHz

*
De1

CA

Avg
16

H1d

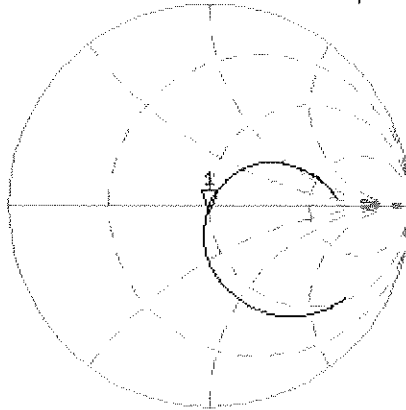

CH2 S11 LOG 5 dB/REF -20 dB 1: -31.359 dB 750.000 000 MHz

CA

Avg
16

H1d

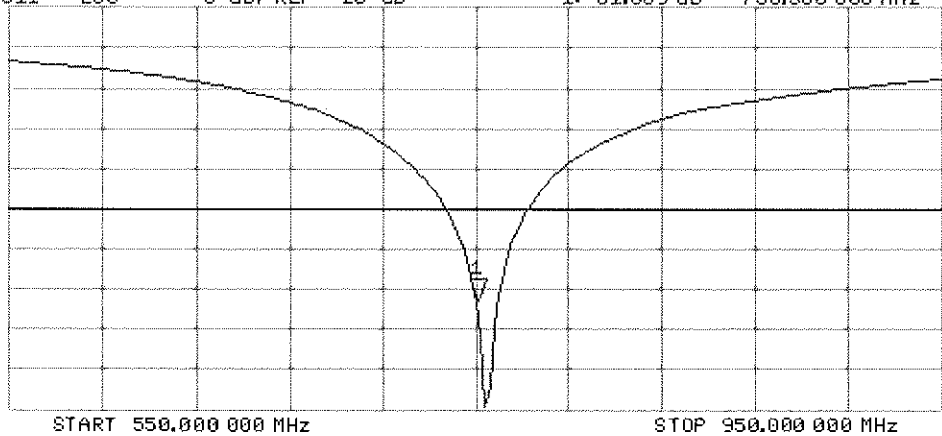



Accredited by the Swiss Accreditation Service (SAS)
The Swiss Accreditation Service is one of the signatories to the EA
Multilateral Agreement for the recognition of calibration certificates

Accreditation No.: **SCS 108**

Client **PC Test**

Certificate No: **D835V2-4d119_Apr14**

CALIBRATION CERTIFICATE

Object **D835V2 - SN: 4d119**

Calibration procedure(s) **QA CAL-05.v9
Calibration procedure for dipole validation kits above 700 MHz**

*CCV
4/25/14*

Calibration date: **April 07, 2014**

This calibration certificate documents the traceability to national standards, which realize the physical units of measurements (SI).
The measurements and the uncertainties with confidence probability are given on the following pages and are part of the certificate.

All calibrations have been conducted in the closed laboratory facility: environment temperature (22 ± 3)°C and humidity < 70%.

Calibration Equipment used (M&TE critical for calibration)

Primary Standards	ID #	Cal Date (Certificate No.)	Scheduled Calibration
Power meter EPM-442A	GB37480704	09-Oct-13 (No. 217-01827)	Oct-14
Power sensor HP 8481A	US37292783	09-Oct-13 (No. 217-01827)	Oct-14
Power sensor HP 8481A	MY41092317	09-Oct-13 (No. 217-01828)	Oct-14
Reference 20 dB Attenuator	SN: 5058 (20k)	03-Apr-14 (No. 217-01918)	Apr-15
Type-N mismatch combination	SN: 5047.2 / 06327	03-Apr-14 (No. 217-01921)	Apr-15
Reference Probe ES3DV3	SN: 3205	30-Dec-13 (No. ES3-3205_Dec13)	Dec-14
DAE4	SN: 601	25-Apr-13 (No. DAE4-601_Apr13)	Apr-14

Secondary Standards	ID #	Check Date (in house)	Scheduled Check
RF generator R&S SMT-06	100005	04-Aug-99 (in house check Oct-13)	In house check: Oct-16
Network Analyzer HP 8753E	US37390585 S4206	18-Oct-01 (in house check Oct-13)	In house check: Oct-14

Calibrated by:	Name Leif Klysner	Function Laboratory Technician	Signature
Approved by:	Katja Pokovic	Technical Manager	

Issued: April 9, 2014

This calibration certificate shall not be reproduced except in full without written approval of the laboratory.



Accredited by the Swiss Accreditation Service (SAS)
The Swiss Accreditation Service is one of the signatories to the EA
Multilateral Agreement for the recognition of calibration certificates

Accreditation No.: **SCS 108**

Glossary:

TSL	tissue simulating liquid
ConvF	sensitivity in TSL / NORM x,y,z
N/A	not applicable or not measured

Calibration is Performed According to the Following Standards:

- a) IEEE Std 1528-2013, "IEEE Recommended Practice for Determining the Peak Spatial-Averaged Specific Absorption Rate (SAR) in the Human Head from Wireless Communications Devices: Measurement Techniques", June 2013
- b) IEC 62209-1, "Procedure to measure the Specific Absorption Rate (SAR) for hand-held devices used in close proximity to the ear (frequency range of 300 MHz to 3 GHz)", February 2005
- c) KDB 865664, "SAR Measurement Requirements for 100 MHz to 6 GHz"

Additional Documentation:

- d) DASY4/5 System Handbook

Methods Applied and Interpretation of Parameters:

- *Measurement Conditions:* Further details are available from the Validation Report at the end of the certificate. All figures stated in the certificate are valid at the frequency indicated.
- *Antenna Parameters with TSL:* The dipole is mounted with the spacer to position its feed point exactly below the center marking of the flat phantom section, with the arms oriented parallel to the body axis.
- *Feed Point Impedance and Return Loss:* These parameters are measured with the dipole positioned under the liquid filled phantom. The impedance stated is transformed from the measurement at the SMA connector to the feed point. The Return Loss ensures low reflected power. No uncertainty required.
- *Electrical Delay:* One-way delay between the SMA connector and the antenna feed point. No uncertainty required.
- *SAR measured:* SAR measured at the stated antenna input power.
- *SAR normalized:* SAR as measured, normalized to an input power of 1 W at the antenna connector.
- *SAR for nominal TSL parameters:* The measured TSL parameters are used to calculate the nominal SAR result.

The reported uncertainty of measurement is stated as the standard uncertainty of measurement multiplied by the coverage factor $k=2$, which for a normal distribution corresponds to a coverage probability of approximately 95%.

Measurement Conditions

DASY system configuration, as far as not given on page 1.

DASY Version	DASY5	V52.8.7
Extrapolation	Advanced Extrapolation	
Phantom	Modular Flat Phantom	
Distance Dipole Center - TSL	15 mm	with Spacer
Zoom Scan Resolution	dx, dy, dz = 5 mm	
Frequency	835 MHz \pm 1 MHz	

Head TSL parameters

The following parameters and calculations were applied.

	Temperature	Permittivity	Conductivity
Nominal Head TSL parameters	22.0 °C	41.5	0.90 mho/m
Measured Head TSL parameters	(22.0 \pm 0.2) °C	41.6 \pm 6 %	0.94 mho/m \pm 6 %
Head TSL temperature change during test	< 0.5 °C	----	----

SAR result with Head TSL

SAR averaged over 1 cm ³ (1 g) of Head TSL	Condition	
SAR measured	250 mW input power	2.38 W/kg
SAR for nominal Head TSL parameters	normalized to 1W	9.22 W/kg \pm 17.0 % (k=2)

SAR averaged over 10 cm ³ (10 g) of Head TSL	condition	
SAR measured	250 mW input power	1.53 W/kg
SAR for nominal Head TSL parameters	normalized to 1W	5.97 W/kg \pm 16.5 % (k=2)

Body TSL parameters

The following parameters and calculations were applied.

	Temperature	Permittivity	Conductivity
Nominal Body TSL parameters	22.0 °C	55.2	0.97 mho/m
Measured Body TSL parameters	(22.0 \pm 0.2) °C	53.6 \pm 6 %	1.02 mho/m \pm 6 %
Body TSL temperature change during test	< 0.5 °C	----	----

SAR result with Body TSL

SAR averaged over 1 cm ³ (1 g) of Body TSL	Condition	
SAR measured	250 mW input power	2.44 W/kg
SAR for nominal Body TSL parameters	normalized to 1W	9.34 W/kg \pm 17.0 % (k=2)

SAR averaged over 10 cm ³ (10 g) of Body TSL	condition	
SAR measured	250 mW input power	1.59 W/kg
SAR for nominal Body TSL parameters	normalized to 1W	6.15 W/kg \pm 16.5 % (k=2)

Appendix

Antenna Parameters with Head TSL

Impedance, transformed to feed point	51.2 Ω - 1.6 j Ω
Return Loss	- 34.0 dB

Antenna Parameters with Body TSL

Impedance, transformed to feed point	46.3 Ω - 4.5 j Ω
Return Loss	- 24.4 dB

General Antenna Parameters and Design

Electrical Delay (one direction)	1.386 ns
----------------------------------	----------

After long term use with 100W radiated power, only a slight warming of the dipole near the feedpoint can be measured.

The dipole is made of standard semirigid coaxial cable. The center conductor of the feeding line is directly connected to the second arm of the dipole. The antenna is therefore short-circuited for DC-signals. On some of the dipoles, small end caps are added to the dipole arms in order to improve matching when loaded according to the position as explained in the "Measurement Conditions" paragraph. The SAR data are not affected by this change. The overall dipole length is still according to the Standard.

No excessive force must be applied to the dipole arms, because they might bend or the soldered connections near the feedpoint may be damaged.

Additional EUT Data

Manufactured by	SPEAG
Manufactured on	June 29, 2010

DASY5 Validation Report for Head TSL

Date: 07.04.2014

Test Laboratory: SPEAG, Zurich, Switzerland

DUT: Dipole 835 MHz; Type: D835V2; Serial: D835V2 - SN: 4d119

Communication System: UID 0 - CW; Frequency: 835 MHz

Medium parameters used: $f = 835$ MHz; $\sigma = 0.94$ S/m; $\epsilon_r = 41.6$; $\rho = 1000$ kg/m³

Phantom section: Flat Section

Measurement Standard: DASY5 (IEEE/IEC/ANSI C63.19-2007)

DASY52 Configuration:

- Probe: ES3DV3 - SN3205; ConvF(6.22, 6.22, 6.22); Calibrated: 30.12.2013;
- Sensor-Surface: 3mm (Mechanical Surface Detection)
- Electronics: DAE4 Sn601; Calibrated: 25.04.2013
- Phantom: Flat Phantom 4.9L; Type: QD000P49AA; Serial: 1001
- DASY52 52.8.7(1137); SEMCAD X 14.6.10(7164)

Dipole Calibration for Head Tissue/Pin=250 mW, d=15mm/Zoom Scan (7x7x7)/Cube 0:

Measurement grid: dx=5mm, dy=5mm, dz=5mm

Reference Value = 56.289 V/m; Power Drift = 0.01 dB

Peak SAR (extrapolated) = 3.59 W/kg

SAR(1 g) = 2.38 W/kg; SAR(10 g) = 1.53 W/kg

Maximum value of SAR (measured) = 2.80 W/kg

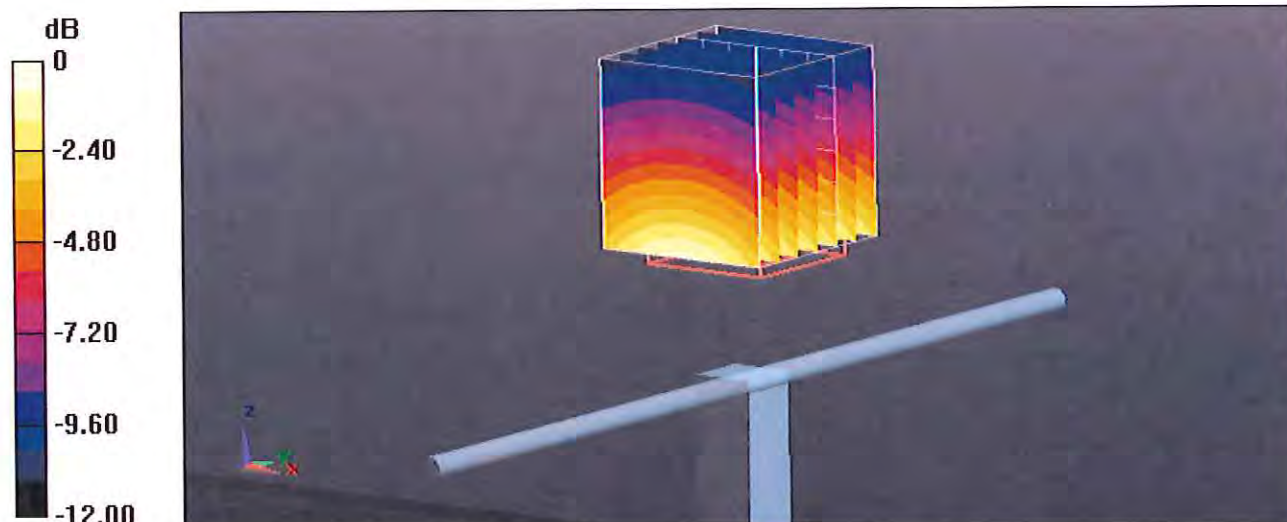

Impedance Measurement Plot for Head TSL

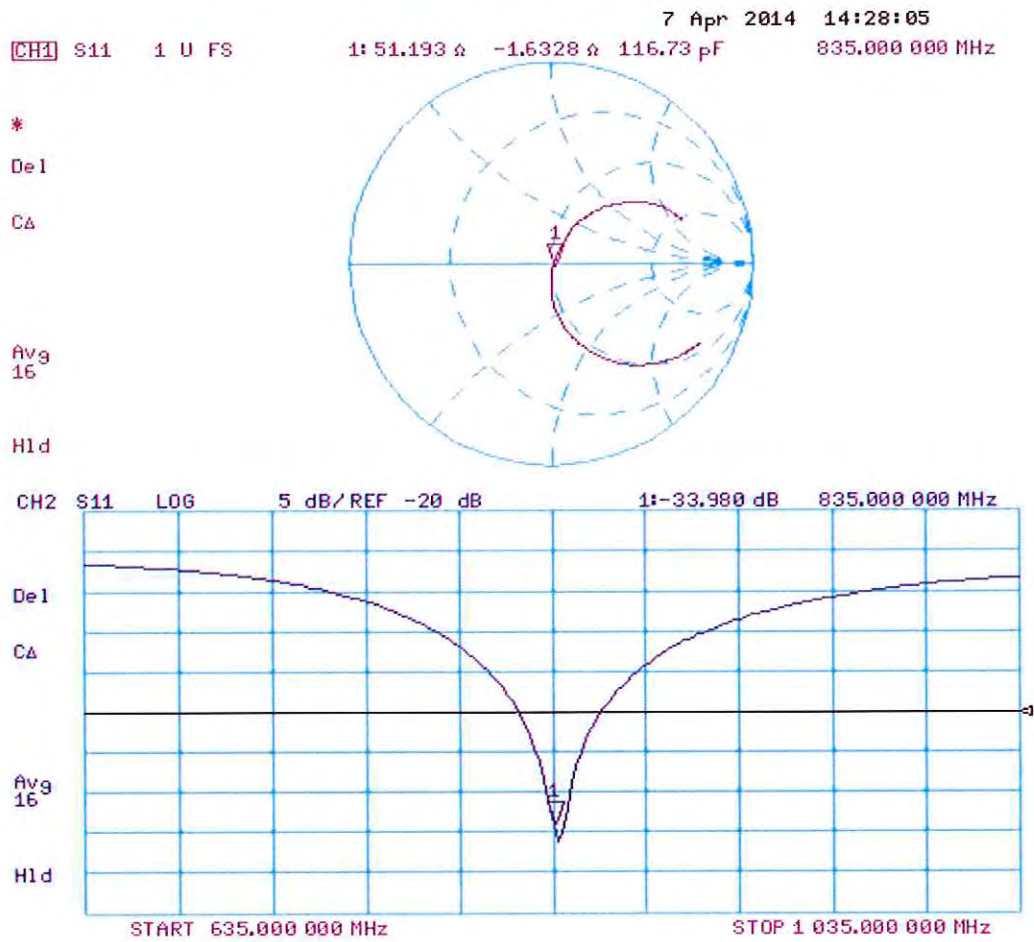

DASY5 Validation Report for Body TSL

Date: 07.04.2014

Test Laboratory: SPEAG, Zurich, Switzerland

DUT: Dipole 835 MHz; Type: D835V2; Serial: D835V2 - SN: 4d119

Communication System: UID 0 - CW; Frequency: 835 MHz

Medium parameters used: $f = 835$ MHz; $\sigma = 1.02$ S/m; $\epsilon_r = 53.6$; $\rho = 1000$ kg/m³

Phantom section: Flat Section

Measurement Standard: DASY5 (IEEE/IEC/ANSI C63.19-2007)

DASY52 Configuration:

- Probe: ES3DV3 - SN3205; ConvF(6.09, 6.09, 6.09); Calibrated: 30.12.2013;
- Sensor-Surface: 3mm (Mechanical Surface Detection)
- Electronics: DAE4 Sn601; Calibrated: 25.04.2013
- Phantom: Flat Phantom 4.9L; Type: QD000P49AA; Serial: 1001
- DASY52 52.8.7(1137); SEMCAD X 14.6.10(7164)

Dipole Calibration for Body Tissue/Pin=250 mW, d=15mm/Zoom Scan (7x7x7)/Cube 0:

Measurement grid: dx=5mm, dy=5mm, dz=5mm

Reference Value = 54.594 V/m; Power Drift = -0.01 dB

Peak SAR (extrapolated) = 3.61 W/kg

SAR(1 g) = 2.44 W/kg; SAR(10 g) = 1.59 W/kg

Maximum value of SAR (measured) = 2.85 W/kg

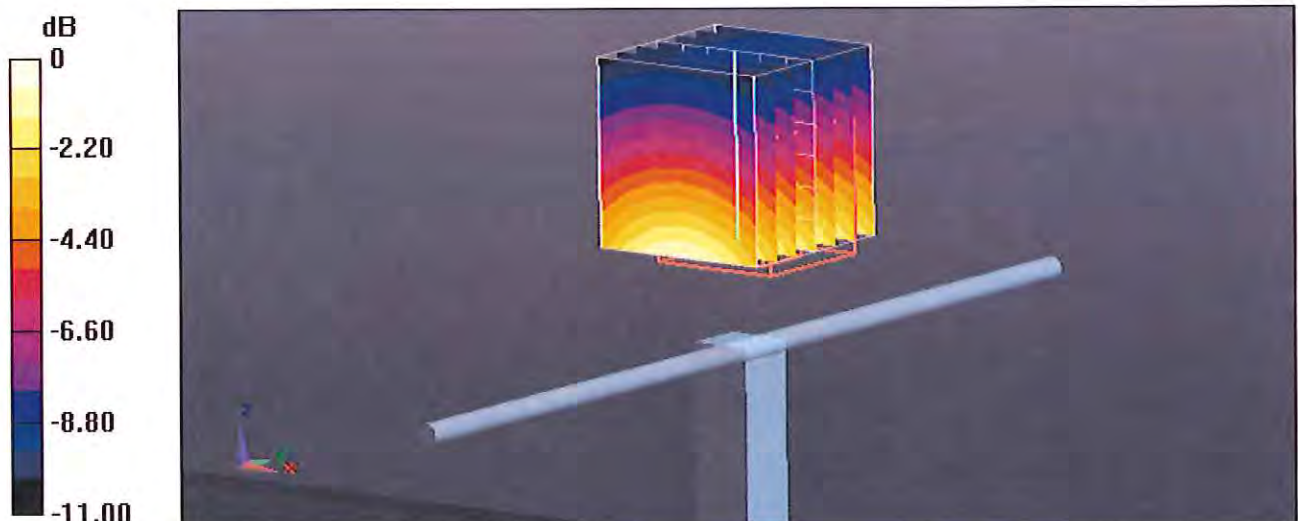

0 dB = 2.85 W/kg = 4.55 dBW/kg

Impedance Measurement Plot for Body TSL

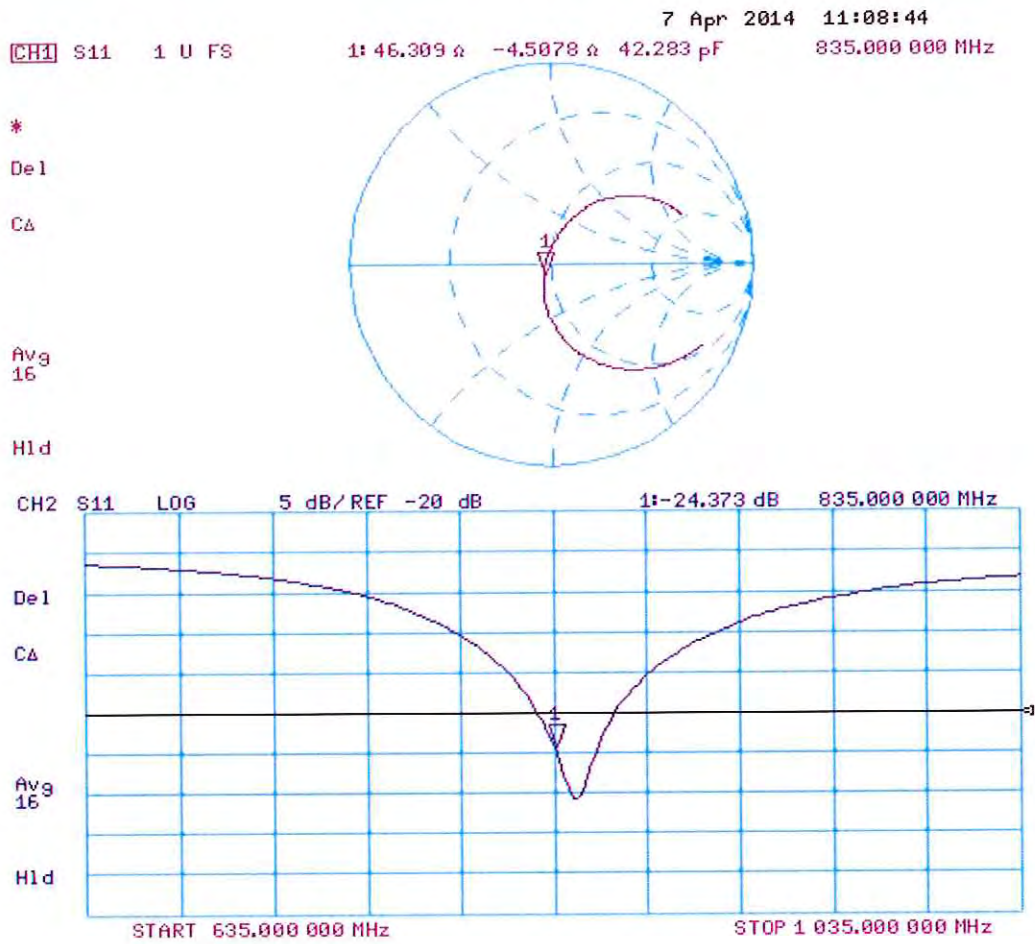



Accredited by the Swiss Accreditation Service (SAS)
 The Swiss Accreditation Service is one of the signatories to the EA
 Multilateral Agreement for the recognition of calibration certificates

Accreditation No.: **SCS 108**

Client **PC Test**

Certificate No: **D1750V2-1051_Apr14**

CALIBRATION CERTIFICATE

Object **D1750V2 - SN: 1051**

Calibration procedure(s) **QA CAL-05.v9**
Calibration procedure for dipole validation kits above 700 MHz

Calibration date: **April 10, 2014**

✓
 KOK
 5/7/14

This calibration certificate documents the traceability to national standards, which realize the physical units of measurements (SI).
 The measurements and the uncertainties with confidence probability are given on the following pages and are part of the certificate.

All calibrations have been conducted in the closed laboratory facility: environment temperature (22 ± 3)°C and humidity < 70%.

Calibration Equipment used (M&TE critical for calibration)

Primary Standards	ID #	Cal Date (Certificate No.)	Scheduled Calibration
Power meter EPM-442A	GB37480704	09-Oct-13 (No. 217-01827)	Oct-14
Power sensor HP 8481A	US37292783	09-Oct-13 (No. 217-01827)	Oct-14
Power sensor HP 8481A	MY41092317	09-Oct-13 (No. 217-01828)	Oct-14
Reference 20 dB Attenuator	SN: 5058 (20k)	03-Apr-14 (No. 217-01918)	Apr-15
Type-N mismatch combination	SN: 5047.2 / 06327	03-Apr-14 (No. 217-01921)	Apr-15
Reference Probe ES3DV3	SN: 3205	30-Dec-13 (No. ES3-3205_Dec13)	Dec-14
DAE4	SN: 601	25-Apr-13 (No. DAE4-601_Apr13)	Apr-14
Secondary Standards	ID #	Check Date (in house)	Scheduled Check
RF generator R&S SMT-06	100005	04-Aug-99 (in house check Oct-13)	In house check: Oct-16
Network Analyzer HP 8753E	US37390585 S4206	18-Oct-01 (in house check Oct-13)	In house check: Oct-14

Calibrated by:	Name Israe El-Naouq	Function Laboratory Technician	Signature
Approved by:	Name Katja Pokovic	Function Technical Manager	Signature

Issued: April 10, 2014

This calibration certificate shall not be reproduced except in full without written approval of the laboratory.



Accredited by the Swiss Accreditation Service (SAS)
The Swiss Accreditation Service is one of the signatories to the EA
Multilateral Agreement for the recognition of calibration certificates

Accreditation No.: **SCS 108**

Glossary:

TSL	tissue simulating liquid
ConvF	sensitivity in TSL / NORM x,y,z
N/A	not applicable or not measured

Calibration is Performed According to the Following Standards:

- IEEE Std 1528-2013, "IEEE Recommended Practice for Determining the Peak Spatial-Averaged Specific Absorption Rate (SAR) in the Human Head from Wireless Communications Devices: Measurement Techniques", June 2013
- IEC 62209-1, "Procedure to measure the Specific Absorption Rate (SAR) for hand-held devices used in close proximity to the ear (frequency range of 300 MHz to 3 GHz)", February 2005
- KDB 865664, "SAR Measurement Requirements for 100 MHz to 6 GHz"

Additional Documentation:

- DASY4/5 System Handbook

Methods Applied and Interpretation of Parameters:

- Measurement Conditions:* Further details are available from the Validation Report at the end of the certificate. All figures stated in the certificate are valid at the frequency indicated.
- Antenna Parameters with TSL:* The dipole is mounted with the spacer to position its feed point exactly below the center marking of the flat phantom section, with the arms oriented parallel to the body axis.
- Feed Point Impedance and Return Loss:* These parameters are measured with the dipole positioned under the liquid filled phantom. The impedance stated is transformed from the measurement at the SMA connector to the feed point. The Return Loss ensures low reflected power. No uncertainty required.
- Electrical Delay:* One-way delay between the SMA connector and the antenna feed point. No uncertainty required.
- SAR measured:* SAR measured at the stated antenna input power.
- SAR normalized:* SAR as measured, normalized to an input power of 1 W at the antenna connector.
- SAR for nominal TSL parameters:* The measured TSL parameters are used to calculate the nominal SAR result.

The reported uncertainty of measurement is stated as the standard uncertainty of measurement multiplied by the coverage factor $k=2$, which for a normal distribution corresponds to a coverage probability of approximately 95%.

Measurement Conditions

DASY system configuration, as far as not given on page 1.

DASY Version	DASY5	V52.8.7
Extrapolation	Advanced Extrapolation	
Phantom	Modular Flat Phantom	
Distance Dipole Center - TSL	10 mm	with Spacer
Zoom Scan Resolution	dx, dy, dz = 5 mm	
Frequency	1750 MHz \pm 1 MHz	

Head TSL parameters

The following parameters and calculations were applied.

	Temperature	Permittivity	Conductivity
Nominal Head TSL parameters	22.0 °C	40.1	1.37 mho/m
Measured Head TSL parameters	(22.0 \pm 0.2) °C	39.1 \pm 6 %	1.35 mho/m \pm 6 %
Head TSL temperature change during test	< 0.5 °C	----	----

SAR result with Head TSL

SAR averaged over 1 cm ³ (1 g) of Head TSL	Condition	
SAR measured	250 mW input power	9.02 W/kg
SAR for nominal Head TSL parameters	normalized to 1W	36.2 W/kg \pm 17.0 % (k=2)

SAR averaged over 10 cm ³ (10 g) of Head TSL	condition	
SAR measured	250 mW input power	4.79 W/kg
SAR for nominal Head TSL parameters	normalized to 1W	19.2 W/kg \pm 16.5 % (k=2)

Body TSL parameters

The following parameters and calculations were applied.

	Temperature	Permittivity	Conductivity
Nominal Body TSL parameters	22.0 °C	53.4	1.49 mho/m
Measured Body TSL parameters	(22.0 \pm 0.2) °C	52.0 \pm 6 %	1.48 mho/m \pm 6 %
Body TSL temperature change during test	< 0.5 °C	----	----

SAR result with Body TSL

SAR averaged over 1 cm ³ (1 g) of Body TSL	Condition	
SAR measured	250 mW input power	9.37 W/kg
SAR for nominal Body TSL parameters	normalized to 1W	37.4 W/kg \pm 17.0 % (k=2)

SAR averaged over 10 cm ³ (10 g) of Body TSL	condition	
SAR measured	250 mW input power	5.04 W/kg
SAR for nominal Body TSL parameters	normalized to 1W	20.1 W/kg \pm 16.5 % (k=2)

Appendix

Antenna Parameters with Head TSL

Impedance, transformed to feed point	50.7 Ω + 0.4 j Ω
Return Loss	- 41.5 dB

Antenna Parameters with Body TSL

Impedance, transformed to feed point	46.8 Ω + 0.8 j Ω
Return Loss	- 29.3 dB

General Antenna Parameters and Design

Electrical Delay (one direction)	1.222 ns
----------------------------------	----------

After long term use with 100W radiated power, only a slight warming of the dipole near the feedpoint can be measured.

The dipole is made of standard semirigid coaxial cable. The center conductor of the feeding line is directly connected to the second arm of the dipole. The antenna is therefore short-circuited for DC-signals. On some of the dipoles, small end caps are added to the dipole arms in order to improve matching when loaded according to the position as explained in the "Measurement Conditions" paragraph. The SAR data are not affected by this change. The overall dipole length is still according to the Standard.

No excessive force must be applied to the dipole arms, because they might bend or the soldered connections near the feedpoint may be damaged.

Additional EUT Data

Manufactured by	SPEAG
Manufactured on	February 19, 2010

DASY5 Validation Report for Head TSL

Date: 10.04.2014

Test Laboratory: SPEAG, Zurich, Switzerland

DUT: Dipole 1750 MHz; Type: D1750V2; Serial: D1750V2 - SN: 1051

Communication System: UID 0 - CW; Frequency: 1750 MHz

Medium parameters used: $f = 1750$ MHz; $\sigma = 1.35$ S/m; $\epsilon_r = 39.1$; $\rho = 1000$ kg/m³

Phantom section: Flat Section

Measurement Standard: DASY5 (IEEE/IEC/ANSI C63.19-2007)

DASY52 Configuration:

- Probe: ES3DV3 - SN3205; ConvF(5.23, 5.23, 5.23); Calibrated: 30.12.2013;
- Sensor-Surface: 3mm (Mechanical Surface Detection)
- Electronics: DAE4 Sn601; Calibrated: 25.04.2013
- Phantom: Flat Phantom 5.0 (front); Type: QD000P50AA; Serial: 1001
- DASY52 52.8.7(1137); SEMCAD X 14.6.10(7164)

Dipole Calibration for Head Tissue/Pin=250 mW, d=10mm/Zoom Scan (7x7x7)/Cube 0:

Measurement grid: dx=5mm, dy=5mm, dz=5mm

Reference Value = 94.631 V/m; Power Drift = 0.00 dB

Peak SAR (extrapolated) = 16.2 W/kg

SAR(1 g) = 9.02 W/kg; SAR(10 g) = 4.79 W/kg

Maximum value of SAR (measured) = 11.3 W/kg

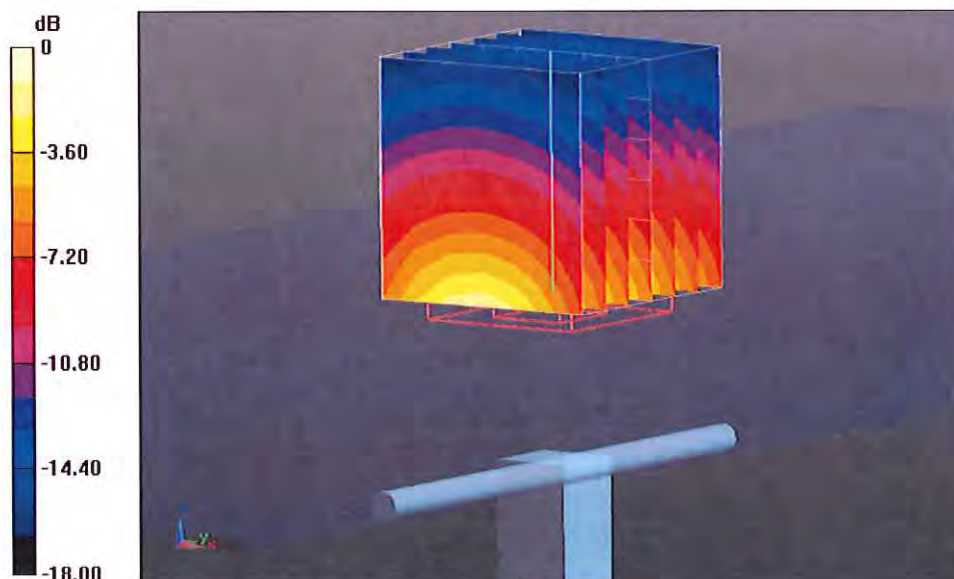

Impedance Measurement Plot for Head TSL

10 Apr 2014 12:21:05

CH1 S11 1 U FS 1: 50.727 Ω 0.4238 Ω 38.545 μH 1 750.000 000 MHz

*
Del
CA
Avg
16
H1d

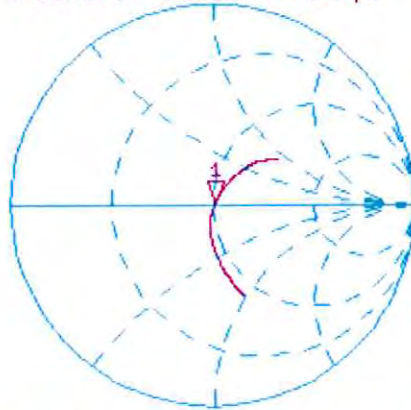

CH2 S11 LOG 5 dB/REF -20 dB 1:-41.536 dB 1 750.000 000 MHz

CA
Avg
16
H1d

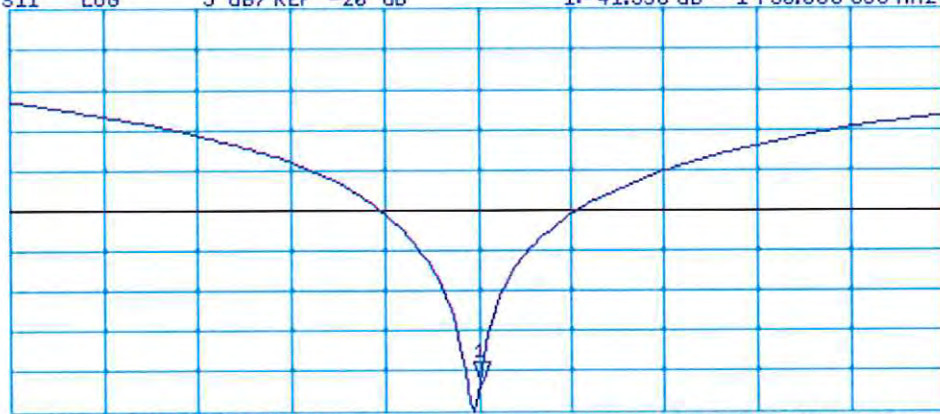

START 1 550.000 000 MHz

STOP 1 950.000 000 MHz

DASY5 Validation Report for Body TSL

Date: 10.04.2014

Test Laboratory: SPEAG, Zurich, Switzerland

DUT: Dipole 1750 MHz; Type: D1750V2; Serial: D1750V2 - SN: 1051

Communication System: UID 0 - CW; Frequency: 1750 MHz

Medium parameters used: $f = 1750$ MHz; $\sigma = 1.48$ S/m; $\epsilon_r = 52$; $\rho = 1000$ kg/m³

Phantom section: Flat Section

Measurement Standard: DASY5 (IEEE/IEC/ANSI C63.19-2007)

DASY52 Configuration:

- Probe: ES3DV3 - SN3205; ConvF(4.89, 4.89, 4.89); Calibrated: 30.12.2013;
- Sensor-Surface: 3mm (Mechanical Surface Detection)
- Electronics: DAE4 Sn601; Calibrated: 25.04.2013
- Phantom: Flat Phantom 5.0 (back); Type: QD000P50AA; Serial: 1002
- DASY52 52.8.7(1137); SEMCAD X 14.6.10(7164)

Dipole Calibration for Body Tissue/Pin=250 mW, d=10mm/Zoom Scan (7x7x7)/Cube 0:

Measurement grid: dx=5mm, dy=5mm, dz=5mm

Reference Value = 93.321 V/m; Power Drift = -0.01 dB

Peak SAR (extrapolated) = 16.1 W/kg

SAR(1 g) = 9.37 W/kg; SAR(10 g) = 5.04 W/kg

Maximum value of SAR (measured) = 11.8 W/kg

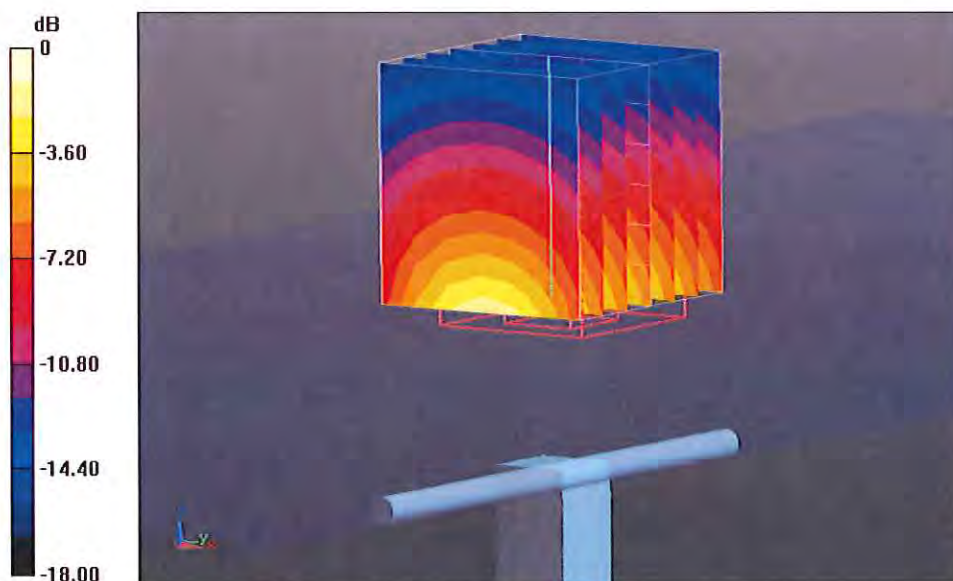

Impedance Measurement Plot for Body TSL

10 Apr 2014 12:20:40

[CH1] S11 1 U FS 1: 46.787 Ω 0.8086 Ω 73.538 pF 1 750.000 000 MHz

*
De l
CA

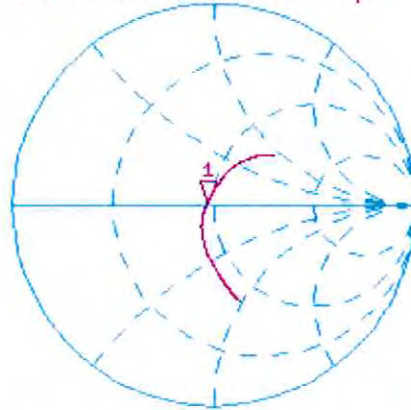

Avg
16

H1 d

CH2 S11 LOG 5 dB/ REF -20 dB 1: -29.320 dB 1 750.000 000 MHz

CA

Avg
16

H1 d

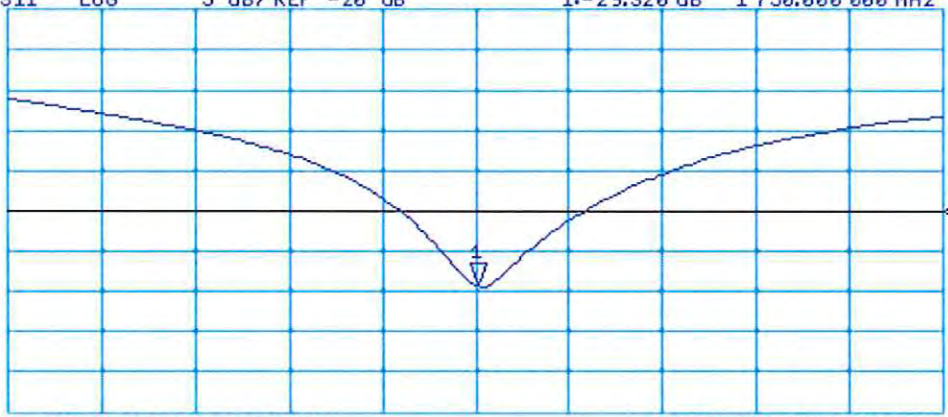

START 1 550.000 000 MHz

STOP 1 950.000 000 MHz



Accredited by the Swiss Accreditation Service (SAS)
The Swiss Accreditation Service is one of the signatories to the EA
Multilateral Agreement for the recognition of calibration certificates

Accreditation No.: **SCS 108**

Client **PC Test**

Certificate No: **D1900V2-5d149_Jul13**

CALIBRATION CERTIFICATE

Object **D1900V2 - SN: 5d149**

Calibration procedure(s) **QA CAL-05.v9
Calibration procedure for dipole validation kits above 700 MHz**

Calibration date: **July 22, 2013**

*✓
Kok
8/19/13*

This calibration certificate documents the traceability to national standards, which realize the physical units of measurements (SI).
The measurements and the uncertainties with confidence probability are given on the following pages and are part of the certificate.

All calibrations have been conducted in the closed laboratory facility: environment temperature (22 ± 3)°C and humidity < 70%.

Calibration Equipment used (M&TE critical for calibration)

Primary Standards	ID #	Cal Date (Certificate No.)	Scheduled Calibration
Power meter EPM-442A	GB37480704	01-Nov-12 (No. 217-01640)	Oct-13
Power sensor HP 8481A	US37292783	01-Nov-12 (No. 217-01640)	Oct-13
Reference 20 dB Attenuator	SN: 5058 (20k)	04-Apr-13 (No. 217-01736)	Apr-14
Type-N mismatch combination	SN: 5047.3 / 06327	04-Apr-13 (No. 217-01739)	Apr-14
Reference Probe ES3DV3	SN: 3205	28-Dec-12 (No. ES3-3205_Dec12)	Dec-13
DAE4	SN: 601	25-Apr-13 (No. DAE4-601_Apr13)	Apr-14
Secondary Standards	ID #	Check Date (in house)	Scheduled Check
Power sensor HP 8481A	MY41092317	18-Oct-02 (in house check Oct-11)	In house check: Oct-13
RF generator R&S SMT-06	100005	04-Aug-99 (in house check Oct-11)	In house check: Oct-13
Network Analyzer HP 8753E	US37390585 S4206	18-Oct-01 (in house check Oct-12)	In house check: Oct-13

	Name	Function	Signature
Calibrated by:	Jeton Kastrali	Laboratory Technician	
Approved by:	Katja Pokovic	Technical Manager	

Issued: July 22, 2013

This calibration certificate shall not be reproduced except in full without written approval of the laboratory.



Accredited by the Swiss Accreditation Service (SAS)
The Swiss Accreditation Service is one of the signatories to the EA
Multilateral Agreement for the recognition of calibration certificates

Accreditation No.: **SCS 108**

Glossary:

TSL	tissue simulating liquid
ConvF	sensitivity in TSL / NORM x,y,z
N/A	not applicable or not measured

Calibration is Performed According to the Following Standards:

- a) IEEE Std 1528-2003, "IEEE Recommended Practice for Determining the Peak Spatial-Averaged Specific Absorption Rate (SAR) in the Human Head from Wireless Communications Devices: Measurement Techniques", December 2003
- b) IEC 62209-1, "Procedure to measure the Specific Absorption Rate (SAR) for hand-held devices used in close proximity to the ear (frequency range of 300 MHz to 3 GHz)", February 2005
- c) Federal Communications Commission Office of Engineering & Technology (FCC OET), "Evaluating Compliance with FCC Guidelines for Human Exposure to Radiofrequency Electromagnetic Fields; Additional Information for Evaluating Compliance of Mobile and Portable Devices with FCC Limits for Human Exposure to Radiofrequency Emissions", Supplement C (Edition 01-01) to Bulletin 65

Additional Documentation:

- d) DASY4/5 System Handbook

Methods Applied and Interpretation of Parameters:

- *Measurement Conditions:* Further details are available from the Validation Report at the end of the certificate. All figures stated in the certificate are valid at the frequency indicated.
- *Antenna Parameters with TSL:* The dipole is mounted with the spacer to position its feed point exactly below the center marking of the flat phantom section, with the arms oriented parallel to the body axis.
- *Feed Point Impedance and Return Loss:* These parameters are measured with the dipole positioned under the liquid filled phantom. The impedance stated is transformed from the measurement at the SMA connector to the feed point. The Return Loss ensures low reflected power. No uncertainty required.
- *Electrical Delay:* One-way delay between the SMA connector and the antenna feed point. No uncertainty required.
- *SAR measured:* SAR measured at the stated antenna input power.
- *SAR normalized:* SAR as measured, normalized to an input power of 1 W at the antenna connector.
- *SAR for nominal TSL parameters:* The measured TSL parameters are used to calculate the nominal SAR result.

The reported uncertainty of measurement is stated as the standard uncertainty of measurement multiplied by the coverage factor $k=2$, which for a normal distribution corresponds to a coverage probability of approximately 95%.

Measurement Conditions

DASY system configuration, as far as not given on page 1.

DASY Version	DASY5	V52.8.7
Extrapolation	Advanced Extrapolation	
Phantom	Modular Flat Phantom	
Distance Dipole Center - TSL	10 mm	with Spacer
Zoom Scan Resolution	dx, dy, dz = 5 mm	
Frequency	1900 MHz \pm 1 MHz	

Head TSL parameters

The following parameters and calculations were applied.

	Temperature	Permittivity	Conductivity
Nominal Head TSL parameters	22.0 °C	40.0	1.40 mho/m
Measured Head TSL parameters	(22.0 \pm 0.2) °C	38.9 \pm 6 %	1.36 mho/m \pm 6 %
Head TSL temperature change during test	< 0.5 °C	----	----

SAR result with Head TSL

SAR averaged over 1 cm³ (1 g) of Head TSL	Condition	
SAR measured	250 mW input power	9.99 W/kg
SAR for nominal Head TSL parameters	normalized to 1W	40.4 W/kg \pm 17.0 % (k=2)

SAR averaged over 10 cm³ (10 g) of Head TSL	condition	
SAR measured	250 mW input power	5.28 W/kg
SAR for nominal Head TSL parameters	normalized to 1W	21.3 W/kg \pm 16.5 % (k=2)

Body TSL parameters

The following parameters and calculations were applied.

	Temperature	Permittivity	Conductivity
Nominal Body TSL parameters	22.0 °C	53.3	1.52 mho/m
Measured Body TSL parameters	(22.0 \pm 0.2) °C	53.4 \pm 6 %	1.49 mho/m \pm 6 %
Body TSL temperature change during test	< 0.5 °C	----	----

SAR result with Body TSL

SAR averaged over 1 cm³ (1 g) of Body TSL	Condition	
SAR measured	250 mW input power	10.0 W/kg
SAR for nominal Body TSL parameters	normalized to 1W	40.5 W/kg \pm 17.0 % (k=2)

SAR averaged over 10 cm³ (10 g) of Body TSL	condition	
SAR measured	250 mW input power	5.36 W/kg
SAR for nominal Body TSL parameters	normalized to 1W	21.6 W/kg \pm 16.5 % (k=2)

Appendix

Antenna Parameters with Head TSL

Impedance, transformed to feed point	52.9 Ω + 6.0 j Ω
Return Loss	- 23.8 dB

Antenna Parameters with Body TSL

Impedance, transformed to feed point	48.5 Ω + 6.4 j Ω
Return Loss	- 23.5 dB

General Antenna Parameters and Design

Electrical Delay (one direction)	1.196 ns
----------------------------------	----------

After long term use with 100W radiated power, only a slight warming of the dipole near the feedpoint can be measured.

The dipole is made of standard semirigid coaxial cable. The center conductor of the feeding line is directly connected to the second arm of the dipole. The antenna is therefore short-circuited for DC-signals. On some of the dipoles, small end caps are added to the dipole arms in order to improve matching when loaded according to the position as explained in the "Measurement Conditions" paragraph. The SAR data are not affected by this change. The overall dipole length is still according to the Standard.

No excessive force must be applied to the dipole arms, because they might bend or the soldered connections near the feedpoint may be damaged.

Additional EUT Data

Manufactured by	SPEAG
Manufactured on	March 11, 2011

DASY5 Validation Report for Head TSL

Date: 22.07.2013

Test Laboratory: SPEAG, Zurich, Switzerland

DUT: Dipole 1900 MHz; Type: D1900V2; Serial: D1900V2 - SN: 5d149

Communication System: UID 0 - CW ; Frequency: 1900 MHz

Medium parameters used: $f = 1900$ MHz; $\sigma = 1.36$ S/m; $\epsilon_r = 38.9$; $\rho = 1000$ kg/m³

Phantom section: Flat Section

Measurement Standard: DASY5 (IEEE/IEC/ANSI C63.19-2007)

DASY52 Configuration:

- Probe: ES3DV3 - SN3205; ConvF(4.98, 4.98, 4.98); Calibrated: 28.12.2012;
- Sensor-Surface: 3mm (Mechanical Surface Detection)
- Electronics: DAE4 Sn601; Calibrated: 25.04.2013
- Phantom: Flat Phantom 5.0 (front); Type: QD000P50AA; Serial: 1001
- DASY52 52.8.7(1137); SEMCAD X 14.6.10(7164)

Dipole Calibration for Head Tissue/Pin=250 mW, d=10mm/Zoom Scan (7x7x7)/Cube 0:

Measurement grid: dx=5mm, dy=5mm, dz=5mm

Reference Value = 96.173 V/m; Power Drift = 0.04 dB

Peak SAR (extrapolated) = 18.0 W/kg

SAR(1 g) = 9.99 W/kg; SAR(10 g) = 5.28 W/kg

Maximum value of SAR (measured) = 12.4 W/kg

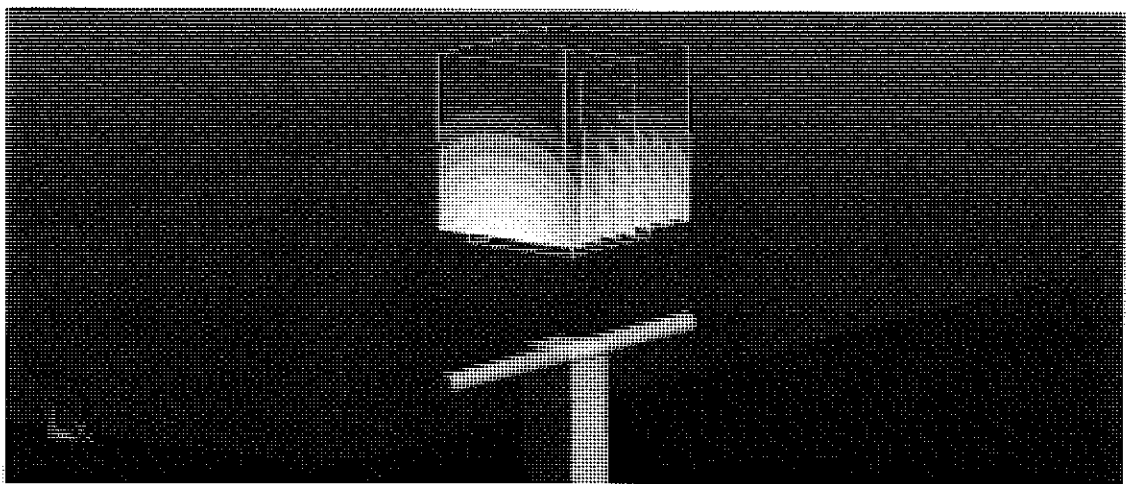
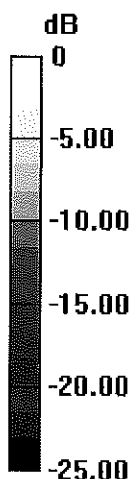

0 dB = 12.4 W/kg = 10.93 dBW/kg

Impedance Measurement Plot for Head TSL

22 Jul 2013 11:59:34

CH1 S11 1 U FS 1: 52.941 Ω 6.0059 Ω 503.09 ρH 1 900.000 000 MHz

*
De1
CA
Avg
16
H1d

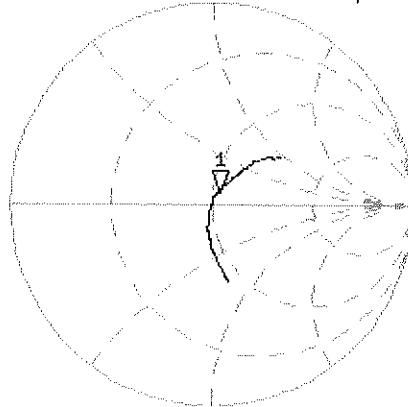

CH2 S11 LOG 5 dB/REF -20 dB 1:-23.758 dB 1 900.000 000 MHz

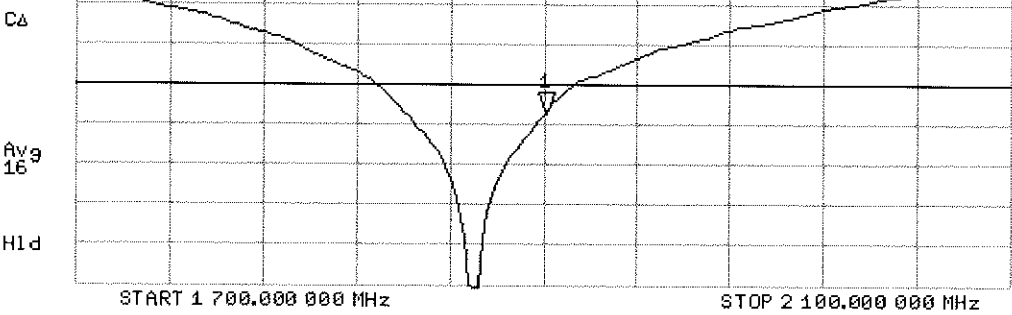

DASY5 Validation Report for Body TSL

Date: 22.07.2013

Test Laboratory: SPEAG, Zurich, Switzerland

DUT: Dipole 1900 MHz; Type: D1900V2; Serial: D1900V2 - SN: 5d149

Communication System: UID 0 - CW ; Frequency: 1900 MHz

Medium parameters used: $f = 1900$ MHz; $\sigma = 1.49$ S/m; $\epsilon_r = 53.4$; $\rho = 1000$ kg/m³

Phantom section: Flat Section

Measurement Standard: DASY5 (IEEE/IEC/ANSI C63.19-2007)

DASY52 Configuration:

- Probe: ES3DV3 - SN3205; ConvF(4.6, 4.6, 4.6); Calibrated: 28.12.2012;
- Sensor-Surface: 3mm (Mechanical Surface Detection)
- Electronics: DAE4 Sn601; Calibrated: 25.04.2013
- Phantom: Flat Phantom 5.0 (back); Type: QD000P50AA; Serial: 1002
- DASY52 52.8.7(1137); SEMCAD X 14.6.10(7164)

Dipole Calibration for Body Tissue/Pin=250 mW, d=10mm/Zoom Scan (7x7x7)/Cube 0:

Measurement grid: dx=5mm, dy=5mm, dz=5mm

Reference Value = 96.173 V/m; Power Drift = 0.01 dB

Peak SAR (extrapolated) = 17.0 W/kg

SAR(1 g) = 10 W/kg; SAR(10 g) = 5.36 W/kg

Maximum value of SAR (measured) = 12.6 W/kg

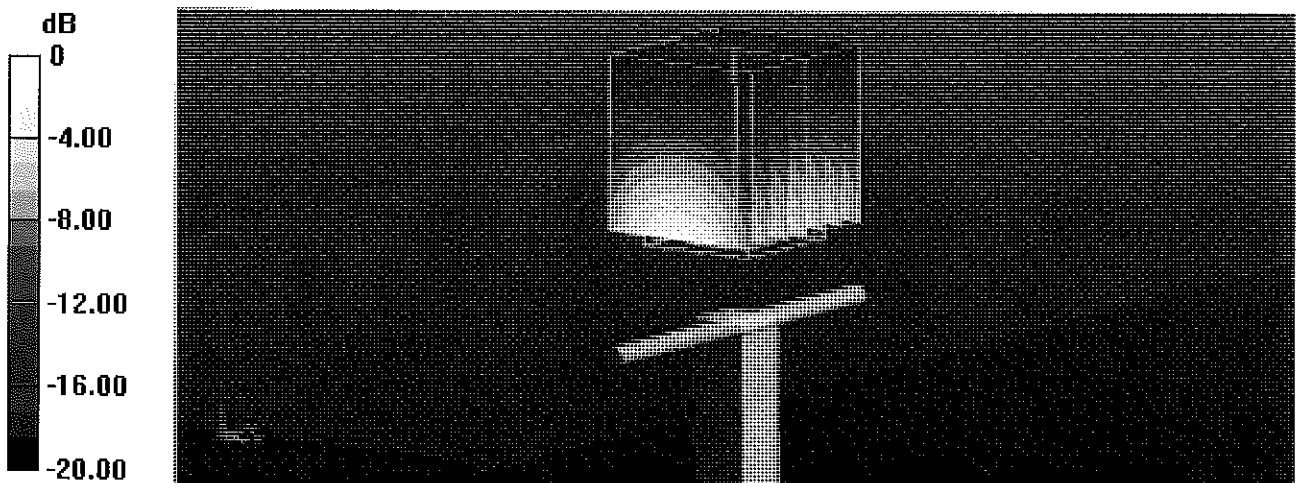

0 dB = 12.6 W/kg = 11.00 dBW/kg

Impedance Measurement Plot for Body TSL

22 Jul 2013 11:32:14

CH1 S11 1 U FS 1: 48.525 Ω 6.3906 μ 535.32 pF 1 900.000 000 MHz

*
De1
CA

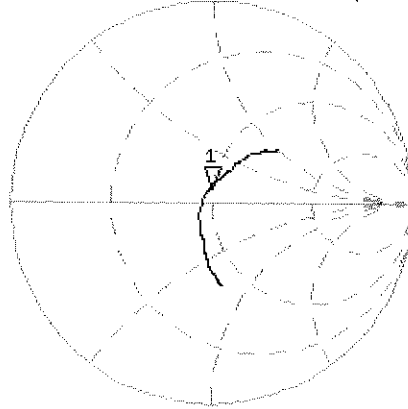

Avg
16

H1d

CH2 S11 LOG 5 dB/REF -20 dB 1:-23.547 dB 1 900.000 000 MHz

CA

Avg
16

H1d

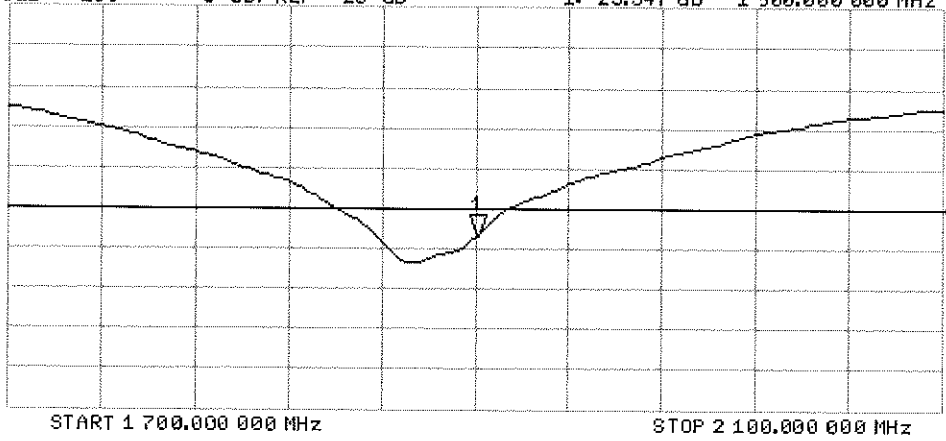



Accredited by the Swiss Accreditation Service (SAS)
The Swiss Accreditation Service is one of the signatories to the EA
Multilateral Agreement for the recognition of calibration certificates

Accreditation No.: **SCS 108**

Client **PC Test**

Certificate No: **D2450V2-797_Jan14**

CALIBRATION CERTIFICATE

Object **D2450V2 - SN: 797**

Calibration procedure(s) **QA CAL-05.v9
Calibration procedure for dipole validation kits above 700 MHz**

Calibration date: **January 21, 2014**

*CC ✓
2/5/14*

This calibration certificate documents the traceability to national standards, which realize the physical units of measurements (SI).
The measurements and the uncertainties with confidence probability are given on the following pages and are part of the certificate.

All calibrations have been conducted in the closed laboratory facility: environment temperature (22 ± 3)°C and humidity < 70%.

Calibration Equipment used (M&TE critical for calibration)

Primary Standards	ID #	Cal Date (Certificate No.)	Scheduled Calibration
Power meter EPM-442A	GB37480704	09-Oct-13 (No. 217-01827)	Oct-14
Power sensor HP 8481A	US37292783	09-Oct-13 (No. 217-01827)	Oct-14
Power sensor HP 8481A	MY41092317	09-Oct-13 (No. 217-01828)	Oct-14
Reference 20 dB Attenuator	SN: 5058 (20k)	04-Apr-13 (No. 217-01736)	Apr-14
Type-N mismatch combination	SN: 5047.3 / 06327	04-Apr-13 (No. 217-01739)	Apr-14
Reference Probe ES3DV3	SN: 3205	30-Dec-13 (No. ES3-3205_Dec13)	Dec-14
DAE4	SN: 601	25-Apr-13 (No. DAE4-601_Apr13)	Apr-14
Secondary Standards	ID #	Check Date (in house)	Scheduled Check
RF generator R&S SMT-06	100005	04-Aug-99 (in house check Oct-13)	In house check: Oct-16
Network Analyzer HP 8753E	US37390585 S4206	18-Oct-01 (in house check Oct-13)	In house check: Oct-14

Calibrated by:	Name Israe El-Naouq	Function Laboratory Technician	Signature
Approved by:	Katja Pokovic	Technical Manager	

Issued: January 21, 2014

This calibration certificate shall not be reproduced except in full without written approval of the laboratory.



Accredited by the Swiss Accreditation Service (SAS)

Accreditation No.: **SCS 108**

The Swiss Accreditation Service is one of the signatories to the EA
Multilateral Agreement for the recognition of calibration certificates

Glossary:

TSL	tissue simulating liquid
ConvF	sensitivity in TSL / NORM x,y,z
N/A	not applicable or not measured

Calibration is Performed According to the Following Standards:

- IEEE Std 1528-2013, "IEEE Recommended Practice for Determining the Peak Spatial-Averaged Specific Absorption Rate (SAR) in the Human Head from Wireless Communications Devices: Measurement Techniques", June 2013
- IEC 62209-1, "Procedure to measure the Specific Absorption Rate (SAR) for hand-held devices used in close proximity to the ear (frequency range of 300 MHz to 3 GHz)", February 2005
- KDB 865664, "SAR Measurement Requirements for 100 MHz to 6 GHz"

Additional Documentation:

- DASY4/5 System Handbook

Methods Applied and Interpretation of Parameters:

- Measurement Conditions:** Further details are available from the Validation Report at the end of the certificate. All figures stated in the certificate are valid at the frequency indicated.
- Antenna Parameters with TSL:** The dipole is mounted with the spacer to position its feed point exactly below the center marking of the flat phantom section, with the arms oriented parallel to the body axis.
- Feed Point Impedance and Return Loss:** These parameters are measured with the dipole positioned under the liquid filled phantom. The impedance stated is transformed from the measurement at the SMA connector to the feed point. The Return Loss ensures low reflected power. No uncertainty required.
- Electrical Delay:** One-way delay between the SMA connector and the antenna feed point. No uncertainty required.
- SAR measured:** SAR measured at the stated antenna input power.
- SAR normalized:** SAR as measured, normalized to an input power of 1 W at the antenna connector.
- SAR for nominal TSL parameters:** The measured TSL parameters are used to calculate the nominal SAR result.

The reported uncertainty of measurement is stated as the standard uncertainty of measurement multiplied by the coverage factor $k=2$, which for a normal distribution corresponds to a coverage probability of approximately 95%.

Measurement Conditions

DASY system configuration, as far as not given on page 1.

DASY Version	DASY5	V52.8.7
Extrapolation	Advanced Extrapolation	
Phantom	Modular Flat Phantom	
Distance Dipole Center - TSL	10 mm	with Spacer
Zoom Scan Resolution	dx, dy, dz = 5 mm	
Frequency	2450 MHz \pm 1 MHz	

Head TSL parameters

The following parameters and calculations were applied.

	Temperature	Permittivity	Conductivity
Nominal Head TSL parameters	22.0 °C	39.2	1.80 mho/m
Measured Head TSL parameters	(22.0 \pm 0.2) °C	38.7 \pm 6 %	1.86 mho/m \pm 6 %
Head TSL temperature change during test	< 0.5 °C	---	---

SAR result with Head TSL

SAR averaged over 1 cm³ (1 g) of Head TSL	Condition	
SAR measured	250 mW input power	13.2 W/kg
SAR for nominal Head TSL parameters	normalized to 1W	51.8 W/kg \pm 17.0 % (k=2)

SAR averaged over 10 cm³ (10 g) of Head TSL	condition	
SAR measured	250 mW input power	6.13 W/kg
SAR for nominal Head TSL parameters	normalized to 1W	24.3 W/kg \pm 16.5 % (k=2)

Body TSL parameters

The following parameters and calculations were applied.

	Temperature	Permittivity	Conductivity
Nominal Body TSL parameters	22.0 °C	52.7	1.95 mho/m
Measured Body TSL parameters	(22.0 \pm 0.2) °C	51.3 \pm 6 %	2.04 mho/m \pm 6 %
Body TSL temperature change during test	< 0.5 °C	---	---

SAR result with Body TSL

SAR averaged over 1 cm³ (1 g) of Body TSL	Condition	
SAR measured	250 mW input power	12.7 W/kg
SAR for nominal Body TSL parameters	normalized to 1W	49.4 W/kg \pm 17.0 % (k=2)

SAR averaged over 10 cm³ (10 g) of Body TSL	condition	
SAR measured	250 mW input power	5.86 W/kg
SAR for nominal Body TSL parameters	normalized to 1W	23.1 W/kg \pm 16.5 % (k=2)

Appendix

Antenna Parameters with Head TSL

Impedance, transformed to feed point	$53.5 \Omega + 3.2 j\Omega$
Return Loss	- 26.7 dB

Antenna Parameters with Body TSL

Impedance, transformed to feed point	$50.0 \Omega + 4.9 j\Omega$
Return Loss	- 26.2 dB

General Antenna Parameters and Design

Electrical Delay (one direction)	1.151 ns
----------------------------------	----------

After long term use with 100W radiated power, only a slight warming of the dipole near the feedpoint can be measured.

The dipole is made of standard semirigid coaxial cable. The center conductor of the feeding line is directly connected to the second arm of the dipole. The antenna is therefore short-circuited for DC-signals. On some of the dipoles, small end caps are added to the dipole arms in order to improve matching when loaded according to the position as explained in the "Measurement Conditions" paragraph. The SAR data are not affected by this change. The overall dipole length is still according to the Standard.

No excessive force must be applied to the dipole arms, because they might bend or the soldered connections near the feedpoint may be damaged.

Additional EUT Data

Manufactured by	SPEAG
Manufactured on	January 24, 2006

DASY5 Validation Report for Head TSL

Date: 21.01.2014

Test Laboratory: SPEAG, Zurich, Switzerland

DUT: Dipole 2450 MHz; Type: D2450V2; Serial: D2450V2 - SN: 797

Communication System: UID 0 - CW; Frequency: 2450 MHz

Medium parameters used: $f = 2450$ MHz; $\sigma = 1.86$ S/m; $\epsilon_r = 38.7$; $\rho = 1000$ kg/m³

Phantom section: Flat Section

Measurement Standard: DASY5 (IEEE/IEC/ANSI C63.19-2007)

DASY52 Configuration:

- Probe: ES3DV3 - SN3205; ConvF(4.53, 4.53, 4.53); Calibrated: 30.12.2013;
- Sensor-Surface: 3mm (Mechanical Surface Detection)
- Electronics: DAE4 Sn601; Calibrated: 25.04.2013
- Phantom: Flat Phantom 5.0 (front); Type: QD000P50AA; Serial: 1001
- DASY52 52.8.7(1137); SEMCAD X 14.6.10(7164)

Dipole Calibration for Head Tissue/Pin=250 mW, d=10mm/Zoom Scan (7x7x7)/Cube 0:

Measurement grid: dx=5mm, dy=5mm, dz=5mm

Reference Value = 99.151 V/m; Power Drift = 0.05 dB

Peak SAR (extrapolated) = 27.5 W/kg

SAR(1 g) = 13.2 W/kg; SAR(10 g) = 6.13 W/kg

Maximum value of SAR (measured) = 16.9 W/kg

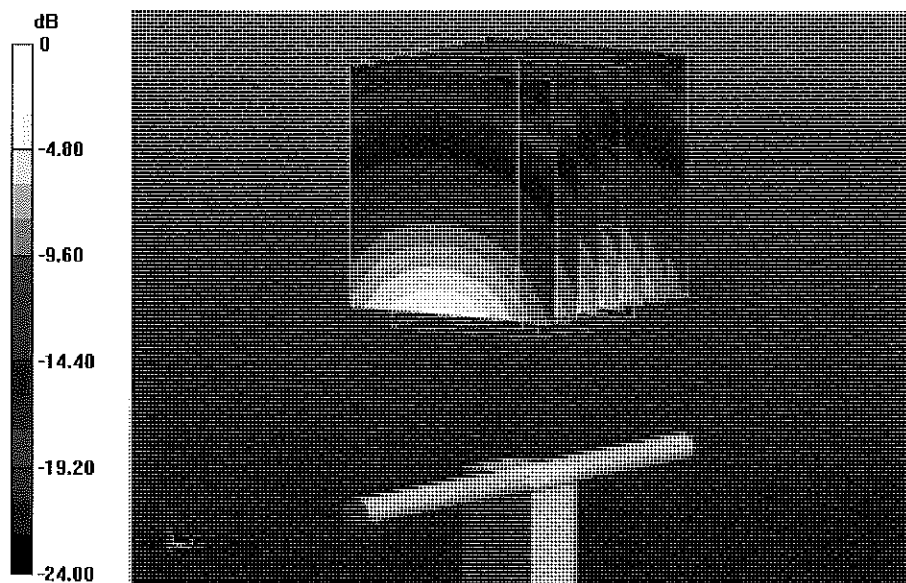

0 dB = 16.9 W/kg = 12.28 dBW/kg

Impedance Measurement Plot for Head TSL

21 Jan 2014 11:31:52

CHI S11 1 U FS 2: 53.512 Δ 3.2285 Δ 209.73 pH 2 450.000 000 MHz

*
De1
CA

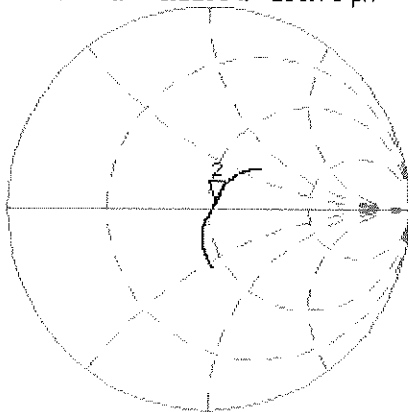

Avg
1E

H1d

CH2 S11 LOG 5 dB/REF -20 dB 2:-26.730 dB 2 450.000 000 MHz

CA

Avg
1E

H1d

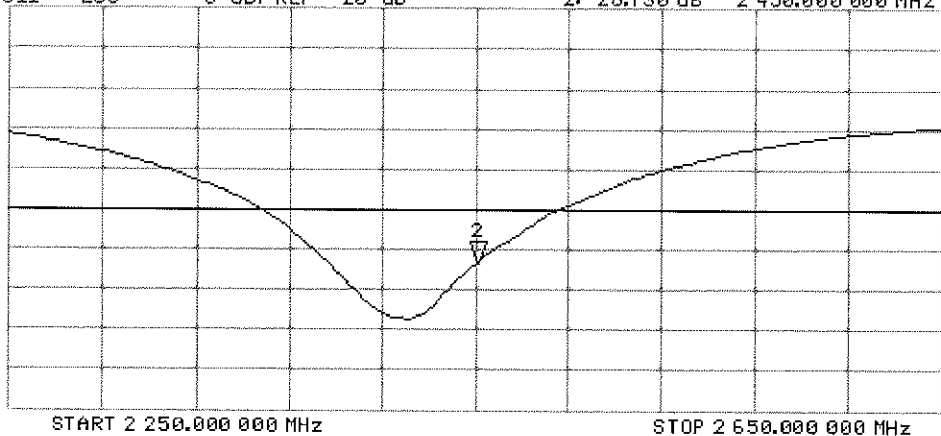

DASY5 Validation Report for Body TSL

Date: 21.01.2014

Test Laboratory: SPEAG, Zurich, Switzerland

DUT: Dipole 2450 MHz; Type: D2450V2; Serial: D2450V2 - SN: 797

Communication System: UID 0 - CW; Frequency: 2450 MHz

Medium parameters used: $f = 2450$ MHz; $\sigma = 2.04$ S/m; $\epsilon_r = 51.3$; $\rho = 1000$ kg/m³

Phantom section: Flat Section

Measurement Standard: DASY5 (IEEE/IEC/ANSI C63.19-2007)

DASY52 Configuration:

- Probe: ES3DV3 - SN3205; ConvF(4.35, 4.35, 4.35); Calibrated: 30.12.2013;
- Sensor-Surface: 3mm (Mechanical Surface Detection)
- Electronics: DAE4 Sn601; Calibrated: 25.04.2013
- Phantom: Flat Phantom 5.0 (back); Type: QD000P50AA; Serial: 1002
- DASY52 52.8.7(1137); SEMCAD X 14.6.10(7164)

Dipole Calibration for Body Tissue/Pin=250 mW, d=10mm/Zoom Scan (7x7x7)/Cube 0:

Measurement grid: dx=5mm, dy=5mm, dz=5mm

Reference Value = 93.709 V/m; Power Drift = 0.01 dB

Peak SAR (extrapolated) = 26.4 W/kg

SAR(1 g) = 12.7 W/kg; SAR(10 g) = 5.86 W/kg

Maximum value of SAR (measured) = 16.8 W/kg

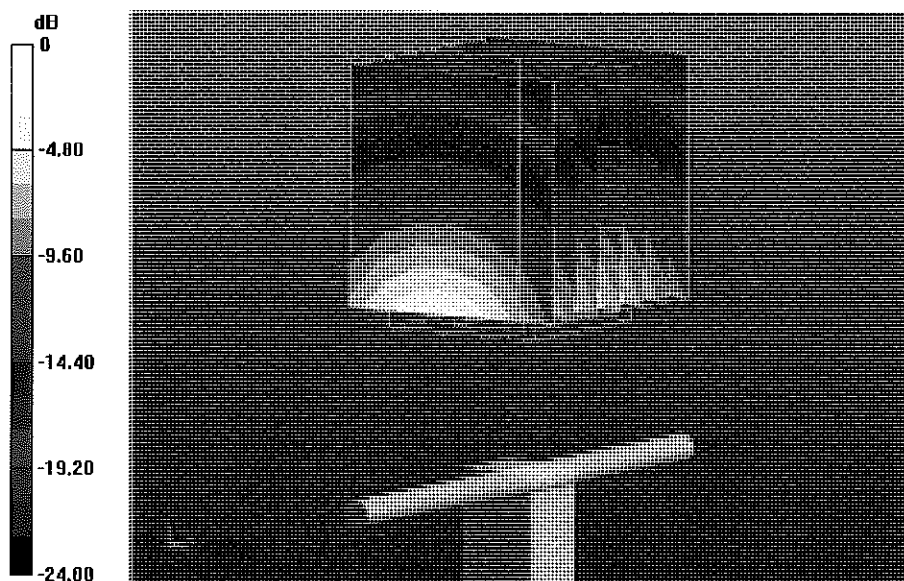

0 dB = 16.8 W/kg = 12.25 dBW/kg

Impedance Measurement Plot for Body TSL

21 Jan 2014 11:31:29

CH1 S11 1 U FS 2: 49.994 Ω 4.9258 Ω 319.98 μH 2 450.000 000 MHz

*
De l

CA

Avg
16

H1 d

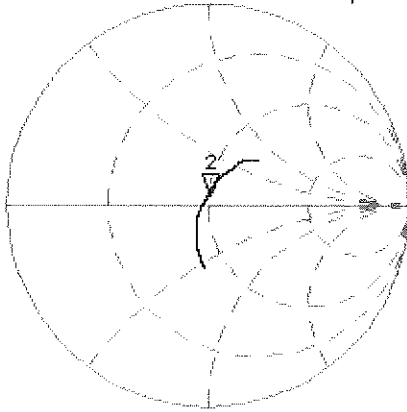

CH2 S11 LOG 5 dB/REF -20 dB 2:-26.162 dB 2 450.000 000 MHz

CA

Avg
16

H1 d

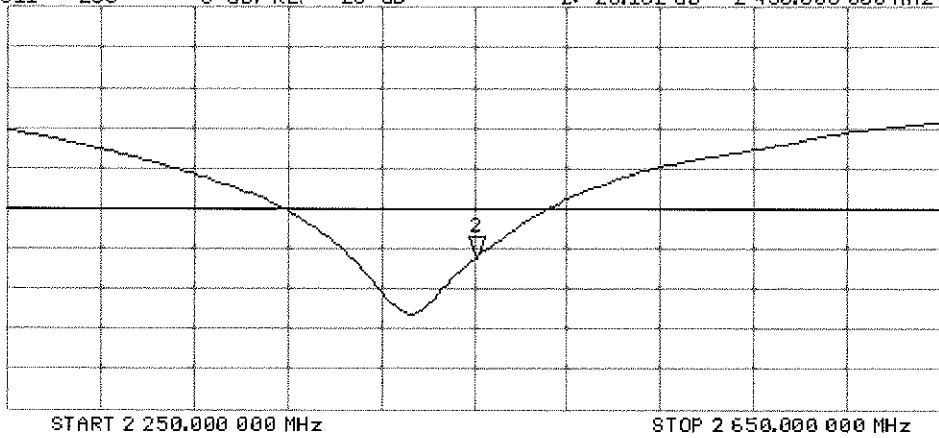



Accredited by the Swiss Accreditation Service (SAS)
The Swiss Accreditation Service is one of the signatories to the EA
Multilateral Agreement for the recognition of calibration certificates

Accreditation No.: **SCS 108**

Client **PC Test**

Certificate No: **D835V2-4d132_Jan14**

CALIBRATION CERTIFICATE

Object **D835V2 - SN: 4d132**

Calibration procedure(s) **QA CAL-05.v9
Calibration procedure for dipole validation kits above 700 MHz**

Calibration date: **January 22, 2014**

CC
21/14 ✓

This calibration certificate documents the traceability to national standards, which realize the physical units of measurements (SI).
The measurements and the uncertainties with confidence probability are given on the following pages and are part of the certificate.

All calibrations have been conducted in the closed laboratory facility: environment temperature (22 ± 3)°C and humidity < 70%.

Calibration Equipment used (M&TE critical for calibration)

Primary Standards	ID #	Cal Date (Certificate No.)	Scheduled Calibration
Power meter EPM-442A	GB37480704	09-Oct-13 (No. 217-01827)	Oct-14
Power sensor HP 8481A	US37292783	09-Oct-13 (No. 217-01827)	Oct-14
Power sensor HP 8481A	MY41092317	09-Oct-13 (No. 217-01828)	Oct-14
Reference 20 dB Attenuator	SN: 5058 (20k)	04-Apr-13 (No. 217-01736)	Apr-14
Type-N mismatch combination	SN: 5047.3 / 06327	04-Apr-13 (No. 217-01739)	Apr-14
Reference Probe ES3DV3	SN: 3205	30-Dec-13 (No. ES3-3205_Dec13)	Dec-14
DAE4	SN: 601	25-Apr-13 (No. DAE4-601_Apr13)	Apr-14
Secondary Standards	ID #	Check Date (in house)	Scheduled Check
RF generator R&S SMT-06	100005	04-Aug-99 (in house check Oct-13)	In house check: Oct-16
Network Analyzer HP 8753E	US37390585 S4206	18-Oct-01 (in house check Oct-13)	In house check: Oct-14

Calibrated by:	Name Jeton Kastrati	Function Laboratory Technician	Signature
Approved by:	Name Katja Pokovic	Function Technical Manager	Signature

Issued: January 22, 2014

This calibration certificate shall not be reproduced except in full without written approval of the laboratory.



Accredited by the Swiss Accreditation Service (SAS)

The Swiss Accreditation Service is one of the signatories to the EA Multilateral Agreement for the recognition of calibration certificates

Accreditation No.: **SCS 108**

Glossary:

TSL	tissue simulating liquid
ConvF	sensitivity in TSL / NORM x,y,z
N/A	not applicable or not measured

Calibration is Performed According to the Following Standards:

- IEEE Std 1528-2013, "IEEE Recommended Practice for Determining the Peak Spatial-Averaged Specific Absorption Rate (SAR) in the Human Head from Wireless Communications Devices: Measurement Techniques", June 2013
- IEC 62209-1, "Procedure to measure the Specific Absorption Rate (SAR) for hand-held devices used in close proximity to the ear (frequency range of 300 MHz to 3 GHz)", February 2005
- KDB 865664, "SAR Measurement Requirements for 100 MHz to 6 GHz"

Additional Documentation:

- DASY4/5 System Handbook

Methods Applied and Interpretation of Parameters:

- Measurement Conditions:** Further details are available from the Validation Report at the end of the certificate. All figures stated in the certificate are valid at the frequency indicated.
- Antenna Parameters with TSL:** The dipole is mounted with the spacer to position its feed point exactly below the center marking of the flat phantom section, with the arms oriented parallel to the body axis.
- Feed Point Impedance and Return Loss:** These parameters are measured with the dipole positioned under the liquid filled phantom. The impedance stated is transformed from the measurement at the SMA connector to the feed point. The Return Loss ensures low reflected power. No uncertainty required.
- Electrical Delay:** One-way delay between the SMA connector and the antenna feed point. No uncertainty required.
- SAR measured:** SAR measured at the stated antenna input power.
- SAR normalized:** SAR as measured, normalized to an input power of 1 W at the antenna connector.
- SAR for nominal TSL parameters:** The measured TSL parameters are used to calculate the nominal SAR result.

The reported uncertainty of measurement is stated as the standard uncertainty of measurement multiplied by the coverage factor $k=2$, which for a normal distribution corresponds to a coverage probability of approximately 95%.

Measurement Conditions

DASY system configuration, as far as not given on page 1.

DASY Version	DASY5	V52.8.7
Extrapolation	Advanced Extrapolation	
Phantom	Modular Flat Phantom	
Distance Dipole Center - TSL	15 mm	with Spacer
Zoom Scan Resolution	dx, dy, dz = 5 mm	
Frequency	835 MHz ± 1 MHz	

Head TSL parameters

The following parameters and calculations were applied.

	Temperature	Permittivity	Conductivity
Nominal Head TSL parameters	22.0 °C	41.5	0.90 mho/m
Measured Head TSL parameters	(22.0 ± 0.2) °C	40.6 ± 6 %	0.93 mho/m ± 6 %
Head TSL temperature change during test	< 0.5 °C	----	----

SAR result with Head TSL

SAR averaged over 1 cm³ (1 g) of Head TSL	Condition	
SAR measured	250 mW input power	2.37 W/kg
SAR for nominal Head TSL parameters	normalized to 1W	9.20 W/kg ± 17.0 % (k=2)

SAR averaged over 10 cm³ (10 g) of Head TSL	condition	
SAR measured	250 mW input power	1.54 W/kg
SAR for nominal Head TSL parameters	normalized to 1W	6.02 W/kg ± 16.5 % (k=2)

Body TSL parameters

The following parameters and calculations were applied.

	Temperature	Permittivity	Conductivity
Nominal Body TSL parameters	22.0 °C	55.2	0.97 mho/m
Measured Body TSL parameters	(22.0 ± 0.2) °C	53.6 ± 6 %	1.01 mho/m ± 6 %
Body TSL temperature change during test	< 0.5 °C	----	----

SAR result with Body TSL

SAR averaged over 1 cm³ (1 g) of Body TSL	Condition	
SAR measured	250 mW input power	2.41 W/kg
SAR for nominal Body TSL parameters	normalized to 1W	9.31 W/kg ± 17.0 % (k=2)

SAR averaged over 10 cm³ (10 g) of Body TSL	condition	
SAR measured	250 mW input power	1.56 W/kg
SAR for nominal Body TSL parameters	normalized to 1W	6.08 W/kg ± 16.5 % (k=2)

Appendix

Antenna Parameters with Head TSL

Impedance, transformed to feed point	51.9 Ω - 1.4 j Ω
Return Loss	- 32.9 dB

Antenna Parameters with Body TSL

Impedance, transformed to feed point	47.0 Ω - 2.9 j Ω
Return Loss	- 27.4 dB

General Antenna Parameters and Design

Electrical Delay (one direction)	1.389 ns
----------------------------------	----------

After long term use with 100W radiated power, only a slight warming of the dipole near the feedpoint can be measured.

The dipole is made of standard semirigid coaxial cable. The center conductor of the feeding line is directly connected to the second arm of the dipole. The antenna is therefore short-circuited for DC-signals. On some of the dipoles, small end caps are added to the dipole arms in order to improve matching when loaded according to the position as explained in the "Measurement Conditions" paragraph. The SAR data are not affected by this change. The overall dipole length is still according to the Standard.

No excessive force must be applied to the dipole arms, because they might bend or the soldered connections near the feedpoint may be damaged.

Additional EUT Data

Manufactured by	SPEAG
Manufactured on	July 22, 2011

DASY5 Validation Report for Head TSL

Date: 22.01.2014

Test Laboratory: SPEAG, Zurich, Switzerland

DUT: Dipole 835 MHz; Type: D835V2; Serial: D835V2 - SN: 4d132

Communication System: UID 0 - CW; Frequency: 835 MHz

Medium parameters used: $f = 835$ MHz; $\sigma = 0.93$ S/m; $\epsilon_r = 40.6$; $\rho = 1000$ kg/m³

Phantom section: Flat Section

Measurement Standard: DASY5 (IEEE/IEC/ANSI C63.19-2007)

DASY52 Configuration:

- Probe: ES3DV3 - SN3205; ConvF(6.22, 6.22, 6.22); Calibrated: 30.12.2013;
- Sensor-Surface: 3mm (Mechanical Surface Detection)
- Electronics: DAE4 Sn601; Calibrated: 25.04.2013
- Phantom: Flat Phantom 4.9L; Type: QD000P49AA; Serial: 1001
- DASY52 52.8.7(1137); SEMCAD X 14.6.10(7164)

Dipole Calibration for Head Tissue/Pin=250 mW, d=15mm/Zoom Scan (7x7x7)/Cube 0:

Measurement grid: dx=5mm, dy=5mm, dz=5mm

Reference Value = 58.681 V/m; Power Drift = 0.02 dB

Peak SAR (extrapolated) = 3.56 W/kg

SAR(1 g) = 2.37 W/kg; SAR(10 g) = 1.54 W/kg

Maximum value of SAR (measured) = 2.77 W/kg

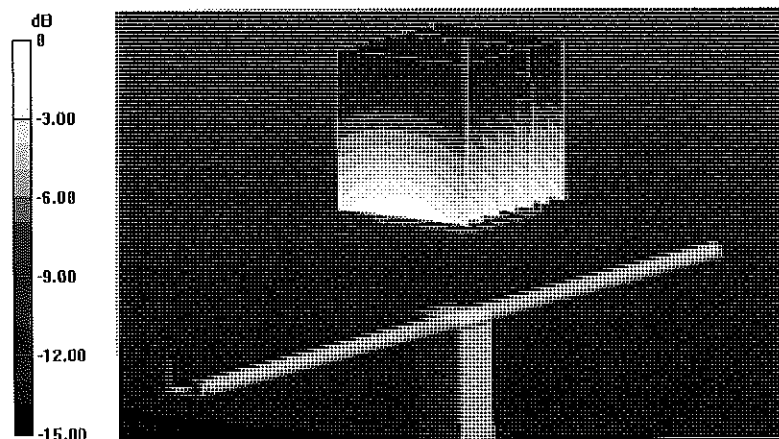

0 dB = 2.77 W/kg = 4.42 dBW/kg

Impedance Measurement Plot for Head TSL

22 Jan 2014 12:03:00

CH1 S11 1 U FS 1: 51.861 \angle -1.3574 \angle 140.42 pF 835.000 000 MHz

*
Del
CA
Avg
16
H1d

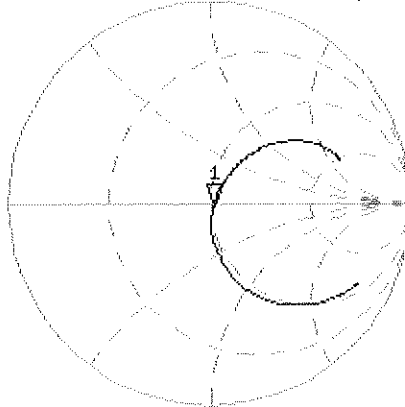

CH2 S11 LOG 5 dB/REF -20 dB 1: -32.916 dB 835.000 000 MHz

CA
Avg
16
H1d

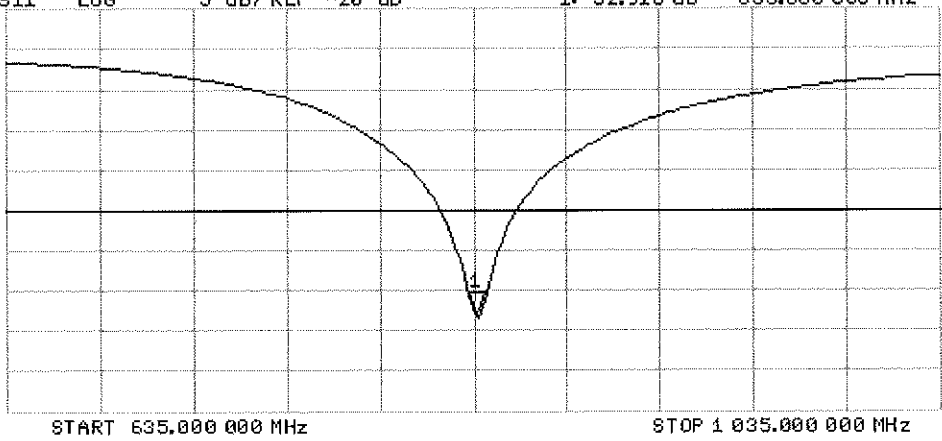

DASY5 Validation Report for Body TSL

Date: 20.01.2014

Test Laboratory: SPEAG, Zurich, Switzerland

DUT: Dipole 835 MHz; Type: D835V2; Serial: D835V2 - SN: 4d132

Communication System: UID 0 - CW; Frequency: 835 MHz

Medium parameters used: $f = 835$ MHz; $\sigma = 1.007$ S/m; $\epsilon_r = 53.6$; $\rho = 1000$ kg/m³

Phantom section: Flat Section

Measurement Standard: DASY5 (IEEE/IEC/ANSI C63.19-2007)

DASY52 Configuration:

- Probe: ES3DV3 - SN3205; ConvF(6.09, 6.09, 6.09); Calibrated: 30.12.2013;
- Sensor-Surface: 3mm (Mechanical Surface Detection)
- Electronics: DAE4 Sn601; Calibrated: 25.04.2013
- Phantom: Flat Phantom 4.9L; Type: QD000P49AA; Serial: 1001
- DASY52 52.8.7(1137); SEMCAD X 14.6.10(7164)

Dipole Calibration for Body Tissue/Pin=250 mW, d=15mm/Zoom Scan (7x7x7)/Cube 0:

Measurement grid: dx=5mm, dy=5mm, dz=5mm

Reference Value = 54.687 V/m; Power Drift = -0.00 dB

Peak SAR (extrapolated) = 3.57 W/kg

SAR(1 g) = 2.41 W/kg; SAR(10 g) = 1.56 W/kg

Maximum value of SAR (measured) = 2.79 W/kg

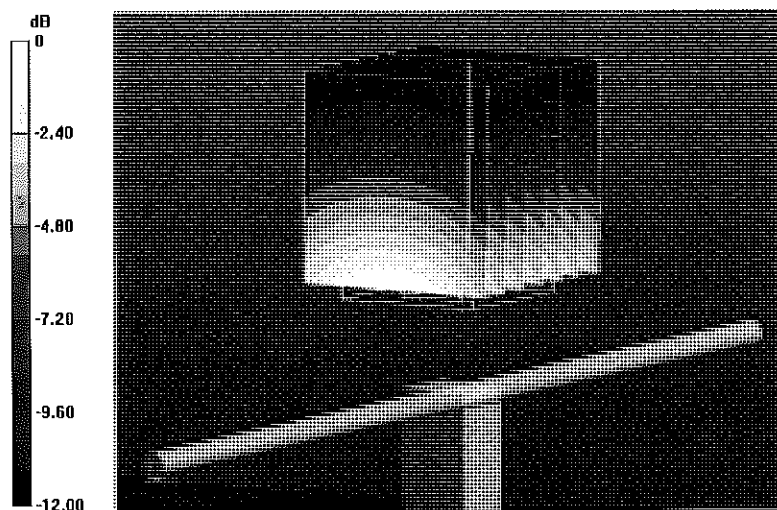

0 dB = 2.79 W/kg = 4.46 dBW/kg

Impedance Measurement Plot for Body TSL

20 Jan 2014 10:35:09

CH1 S11 1 U FS 2: 46.990 Ω -2.8711 Ω 66.388 pF 835.000 000 MHz

*
De1
CA
Avg
16
H1d

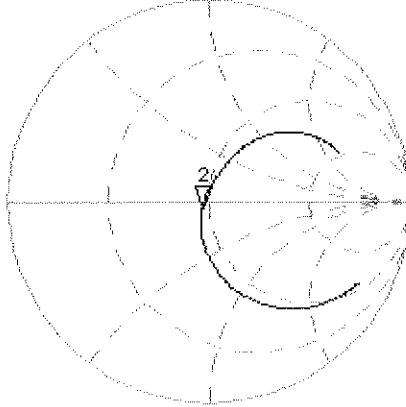

CH2 S11 LOG 5 dB/REF -20 dB 21-27.356 dB 835.000 000 MHz

CA
Avg
16
H1d

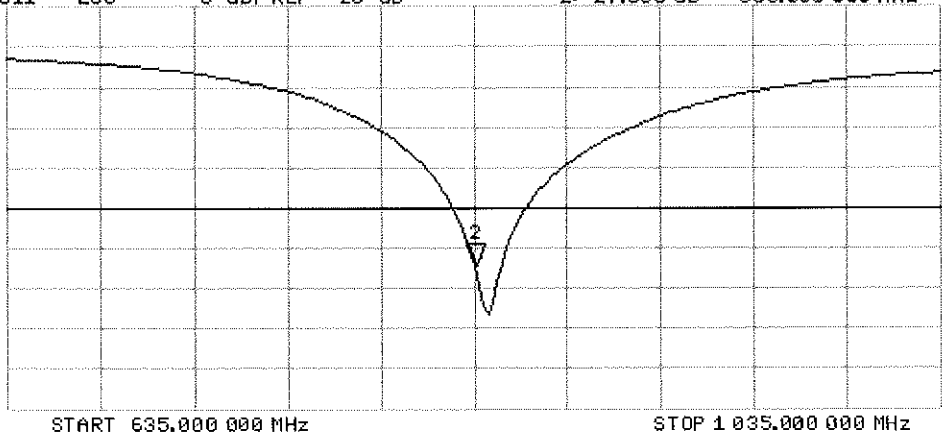



Accredited by the Swiss Accreditation Service (SAS)
The Swiss Accreditation Service is one of the signatories to the EA
Multilateral Agreement for the recognition of calibration certificates

Accreditation No.: **SCS 108**

Client **PC Test**

Certificate No: **ES3-3287_Nov13**

CALIBRATION CERTIFICATE

Object **ES3DV3 - SN:3287**

Calibration procedure(s) **QA CAL-01.v9, QA CAL-23.v5, QA CAL-25.v6
Calibration procedure for dosimetric E-field probes**

Calibration date: **November 20, 2013** ✓ CC 11/20/2013

This calibration certificate documents the traceability to national standards, which realize the physical units of measurements (SI).
The measurements and the uncertainties with confidence probability are given on the following pages and are part of the certificate.

All calibrations have been conducted in the closed laboratory facility: environment temperature (22 ± 3)°C and humidity < 70%.

Calibration Equipment used (M&TE critical for calibration)

Primary Standards	ID	Cal Date (Certificate No.)	Scheduled Calibration
Power meter E4419B	GB41293874	04-Apr-13 (No. 217-01733)	Apr-14
Power sensor E4412A	MY41498087	04-Apr-13 (No. 217-01733)	Apr-14
Reference 3 dB Attenuator	SN: S5054 (3c)	04-Apr-13 (No. 217-01737)	Apr-14
Reference 20 dB Attenuator	SN: S5277 (20x)	04-Apr-13 (No. 217-01735)	Apr-14
Reference 30 dB Attenuator	SN: S5129 (30b)	04-Apr-13 (No. 217-01738)	Apr-14
Reference Probe ES3DV2	SN: 3013	28-Dec-12 (No. ES3-3013_Dec12)	Dec-13
DAE4	SN: 660	4-Sep-13 (No. DAE4-660_Sep13)	Sep-14
Secondary Standards	ID	Check Date (in house)	Scheduled Check
RF generator HP 8648C	US3642U01700	4-Aug-99 (in house check Apr-13)	In house check: Apr-15
Network Analyzer HP 8753E	US37390585	18-Oct-01 (in house check Oct-13)	In house check: Oct-14

	Name	Function	Signature
Calibrated by:	Leif Klysner	Laboratory Technician	
Approved by:	Kalja Pokovic	Technical Manager	
			Issued: November 20, 2013
This calibration certificate shall not be reproduced except in full without written approval of the laboratory.			



Accredited by the Swiss Accreditation Service (SAS)
 The Swiss Accreditation Service is one of the signatories to the EA
 Multilateral Agreement for the recognition of calibration certificates

Accreditation No.: **SCS 108**

Glossary:

TSL	tissue simulating liquid
NORM _{x,y,z}	sensitivity in free space
ConvF	sensitivity in TSL / NORM _{x,y,z}
DCP	diode compression point
CF	crest factor (1/duty_cycle) of the RF signal
A, B, C, D	modulation dependent linearization parameters
Polarization φ	φ rotation around probe axis
Polarization ϑ	ϑ rotation around an axis that is in the plane normal to probe axis (at measurement center), i.e., ϑ = 0 is normal to probe axis
Connector Angle	information used in DASY system to align probe sensor X to the robot coordinate system

Calibration is Performed According to the Following Standards:

- a) IEEE Std 1528-2013, "IEEE Recommended Practice for Determining the Peak Spatial-Averaged Specific Absorption Rate (SAR) in the Human Head from Wireless Communications Devices: Measurement Techniques", June 2013
- b) IEC 62209-1, "Procedure to measure the Specific Absorption Rate (SAR) for hand-held devices used in close proximity to the ear (frequency range of 300 MHz to 3 GHz)", February 2005

Methods Applied and Interpretation of Parameters:

- **NORM_{x,y,z}**: Assessed for E-field polarization ϑ = 0 (f ≤ 900 MHz in TEM-cell; f > 1800 MHz: R22 waveguide). NORM_{x,y,z} are only intermediate values, i.e., the uncertainties of NORM_{x,y,z} does not affect the E²-field uncertainty inside TSL (see below *ConvF*).
- **NORM(f)_{x,y,z}** = NORM_{x,y,z} * *frequency_response* (see Frequency Response Chart). This linearization is implemented in DASY4 software versions later than 4.2. The uncertainty of the frequency response is included in the stated uncertainty of *ConvF*.
- **DCP_{x,y,z}**: DCP are numerical linearization parameters assessed based on the data of power sweep with CW signal (no uncertainty required). DCP does not depend on frequency nor media.
- **PAR**: PAR is the Peak to Average Ratio that is not calibrated but determined based on the signal characteristics
- **A_{x,y,z}; B_{x,y,z}; C_{x,y,z}; D_{x,y,z}; VR_{x,y,z}**: A, B, C, D are numerical linearization parameters assessed based on the data of power sweep for specific modulation signal. The parameters do not depend on frequency nor media. VR is the maximum calibration range expressed in RMS voltage across the diode.
- **ConvF and Boundary Effect Parameters**: Assessed in flat phantom using E-field (or Temperature Transfer Standard for f ≤ 800 MHz) and inside waveguide using analytical field distributions based on power measurements for f > 800 MHz. The same setups are used for assessment of the parameters applied for boundary compensation (alpha, depth) of which typical uncertainty values are given. These parameters are used in DASY4 software to improve probe accuracy close to the boundary. The sensitivity in TSL corresponds to NORM_{x,y,z} * ConvF whereby the uncertainty corresponds to that given for ConvF. A frequency dependent ConvF is used in DASY version 4.4 and higher which allows extending the validity from ± 50 MHz to ± 100 MHz.
- **Spherical isotropy (3D deviation from isotropy)**: in a field of low gradients realized using a flat phantom exposed by a patch antenna.
- **Sensor Offset**: The sensor offset corresponds to the offset of virtual measurement center from the probe tip (on probe axis). No tolerance required.
- **Connector Angle**: The angle is assessed using the information gained by determining the NORM_x (no uncertainty required).

Probe ES3DV3

SN:3287

Manufactured: June 7, 2010
Calibrated: November 20, 2013

Calibrated for DASY/EASY Systems
(Note: non-compatible with DASY2 system!)

DASY/EASY - Parameters of Probe: ES3DV3 - SN:3287

Basic Calibration Parameters

	Sensor X	Sensor Y	Sensor Z	Unc (k=2)
Norm ($\mu\text{V}/(\text{V}/\text{m})^2$) ^A	1.31	1.25	1.25	$\pm 10.1\%$
DCP (mV) ^B	102.6	102.5	100.4	

Modulation Calibration Parameters

UID	Communication System Name		A dB	B dB $\sqrt{\mu\text{V}}$	C	D dB	VR mV	Unc ^E (k=2)
0	CW	X	0.0	0.0	1.0	0.00	157.3	$\pm 2.7\%$
		Y	0.0	0.0	1.0		159.9	
		Z	0.0	0.0	1.0		152.5	
10010- CAA	SAR Validation (Square, 100ms, 10ms)	X	2.23	57.9	9.9	10.00	45.7	$\pm 1.4\%$
		Y	2.13	57.6	9.8		46.6	
		Z	3.31	61.1	11.8		47.6	
10011- CAA	UMTS-FDD (WCDMA)	X	3.25	66.3	17.9	2.91	124.8	$\pm 0.5\%$
		Y	3.16	65.7	17.4		127.4	
		Z	3.15	65.5	17.4		122.8	
10012- CAA	IEEE 802.11b WiFi 2.4 GHz (DSSS, 1 Mbps)	X	3.08	68.7	18.3	1.87	127.2	$\pm 0.7\%$
		Y	3.03	68.2	17.9		129.4	
		Z	2.87	67.0	17.3		126.5	
10021- DAA	GSM-FDD (TDMA, GMSK)	X	15.99	90.6	25.0	9.39	99.9	$\pm 1.2\%$
		Y	12.41	86.6	23.6		101.5	
		Z	29.18	99.9	28.5		109.2	
10023- DAA	GPRS-FDD (TDMA, GMSK, TN 0)	X	25.67	98.9	27.8	9.57	97.9	$\pm 1.7\%$
		Y	14.20	88.5	24.3		100.6	
		Z	27.68	99.8	28.8		107.7	
10024- DAA	GPRS-FDD (TDMA, GMSK, TN 0-1)	X	42.95	99.6	24.9	6.56	124.4	$\pm 1.4\%$
		Y	45.27	99.9	24.8		128.8	
		Z	42.64	99.6	25.5		135.7	
10027- DAA	GPRS-FDD (TDMA, GMSK, TN 0-1-2)	X	27.78	91.3	21.1	4.80	136.0	$\pm 1.4\%$
		Y	32.74	93.9	21.9		146.6	
		Z	23.93	89.5	21.1		144.8	
10028- DAA	GPRS-FDD (TDMA, GMSK, TN 0-1-2-3)	X	59.17	99.6	22.4	3.55	142.5	$\pm 1.2\%$
		Y	78.76	99.7	21.7		104.9	
		Z	38.06	94.2	21.4		148.8	
10032- CAA	IEEE 802.15.1 Bluetooth (GFSK, DH5)	X	93.35	99.7	19.5	1.16	108.1	$\pm 0.9\%$
		Y	96.67	94.0	16.9		114.7	
		Z	98.17	96.2	18.2		108.9	
10039- CAA	CDMA2000 (1xRTT, RC1)	X	4.84	66.7	18.8	4.57	126.5	$\pm 0.9\%$
		Y	4.83	66.6	18.6		134.4	
		Z	4.76	66.0	18.3		125.9	
10081- CAA	CDMA2000 (1xRTT, RC3)	X	4.00	66.2	18.5	3.97	121.9	$\pm 0.7\%$
		Y	3.91	65.5	17.9		128.9	
		Z	3.88	65.2	17.8		120.7	

10098-CAA	UMTS-FDD (HSUPA, Subtest 2)	X	4.66	66.6	18.4	3.98	132.5	±0.7 %
		Y	4.66	66.5	18.2		141.3	
		Z	4.54	65.9	17.9		130.7	
10100-CAB	LTE-FDD (SC-FDMA, 100% RB, 20 MHz, QPSK)	X	6.65	68.3	20.1	5.67	139.5	±1.4 %
		Y	6.69	68.3	19.9		148.9	
		Z	6.60	67.9	19.8		137.5	
10108-CAB	LTE-FDD (SC-FDMA, 100% RB, 10 MHz, QPSK)	X	6.52	67.8	20.0	5.80	137.3	±1.4 %
		Y	6.53	67.6	19.7		147.5	
		Z	6.51	67.6	19.8		135.3	
10110-CAB	LTE-FDD (SC-FDMA, 100% RB, 5 MHz, QPSK)	X	6.19	67.2	19.7	5.75	134.3	±1.2 %
		Y	6.24	67.3	19.6		142.9	
		Z	6.23	67.1	19.6		132.3	
10151-CAB	LTE-TDD (SC-FDMA, 50% RB, 20 MHz, QPSK)	X	11.56	79.1	27.9	9.28	130.1	±3.0 %
		Y	11.01	76.8	26.2		141.9	
		Z	12.98	81.2	28.7		135.7	
10154-CAB	LTE-FDD (SC-FDMA, 50% RB, 10 MHz, QPSK)	X	6.25	67.4	19.8	5.75	135.1	±1.2 %
		Y	6.17	66.9	19.3		143.6	
		Z	6.16	66.8	19.4		132.8	
10160-CAB	LTE-FDD (SC-FDMA, 50% RB, 15 MHz, QPSK)	X	6.66	67.8	20.0	5.82	140.3	±1.4 %
		Y	6.72	67.9	19.9		148.8	
		Z	6.66	67.6	19.8		137.4	
10169-CAB	LTE-FDD (SC-FDMA, 1 RB, 20 MHz, QPSK)	X	5.05	66.7	19.5	5.73	117.8	±0.9 %
		Y	4.93	66.0	18.9		125.0	
		Z	5.08	66.3	19.3		116.3	
10172-CAB	LTE-TDD (SC-FDMA, 1 RB, 20 MHz, QPSK)	X	8.47	76.8	26.9	9.21	100.3	±2.2 %
		Y	8.06	74.6	25.3		107.5	
		Z	9.43	78.2	27.4		102.5	
10175-CAB	LTE-FDD (SC-FDMA, 1 RB, 10 MHz, QPSK)	X	4.98	66.3	19.3	5.72	118.2	±0.9 %
		Y	4.96	66.1	19.0		119.9	
		Z	5.03	66.1	19.1		116.1	
10181-CAB	LTE-FDD (SC-FDMA, 1 RB, 15 MHz, QPSK)	X	5.06	66.7	19.6	5.72	118.7	±0.9 %
		Y	4.97	66.2	19.1		120.0	
		Z	5.03	66.1	19.1		116.3	
10225-CAA	UMTS-FDD (HSPA+)	X	6.78	66.1	18.9	5.97	105.3	±1.2 %
		Y	6.68	65.7	18.6		106.8	
		Z	7.32	67.6	19.7		148.0	
10237-CAB	LTE-TDD (SC-FDMA, 1 RB, 10 MHz, QPSK)	X	8.56	77.1	27.1	9.21	100.8	±1.9 %
		Y	8.33	75.8	26.1		103.8	
		Z	9.39	78.0	27.3		101.9	
10252-CAB	LTE-TDD (SC-FDMA, 50% RB, 10 MHz, QPSK)	X	10.58	77.8	27.4	9.24	123.3	±2.5 %
		Y	10.48	76.9	26.5		128.1	
		Z	11.79	79.6	28.0		127.0	
10267-CAB	LTE-TDD (SC-FDMA, 100% RB, 10 MHz, QPSK)	X	11.52	79.1	27.9	9.30	130.1	±2.7 %
		Y	11.24	77.7	26.9		136.0	
		Z	12.96	81.2	28.8		134.8	

10274-CAA	UMTS-FDD (HSUPA, Subtest 5, 3GPP Rel8.10)	X	6.14	67.4	19.0	4.87	145.5	±1.2 %
		Y	6.19	67.4	19.0		149.2	
		Z	6.10	66.9	18.8		142.3	
10275-CAA	UMTS-FDD (HSUPA, Subtest 5, 3GPP Rel8.4)	X	4.41	66.4	18.3	3.96	126.4	±0.7 %
		Y	4.43	66.3	18.2		130.4	
		Z	4.36	65.9	18.0		123.8	
10291-AAA	CDMA2000, RC3, SO55, Full Rate	X	3.57	65.9	17.9	3.46	120.0	±0.5 %
		Y	3.55	65.6	17.6		121.7	
		Z	3.50	65.1	17.5		117.2	
10292-AAA	CDMA2000, RC3, SO32, Full Rate	X	3.55	66.1	18.0	3.39	121.3	±0.5 %
		Y	3.54	66.0	17.8		123.6	
		Z	3.45	65.2	17.4		118.9	
10297-AAA	LTE-FDD (SC-FDMA, 50% RB, 20 MHz, QPSK)	X	6.53	67.8	20.0	5.81	136.2	±1.2 %
		Y	6.48	67.5	19.6		139.3	
		Z	6.52	67.6	19.8		134.1	
10311-AAA	LTE-FDD (SC-FDMA, 100% RB, 15 MHz, QPSK)	X	7.12	68.4	20.4	6.06	141.7	±1.4 %
		Y	7.11	68.3	20.1		145.3	
		Z	7.14	68.4	20.3		139.8	
10315-AAA	IEEE 802.11b WiFi 2.4 GHz (DSSS, 1 Mbps, 96pc duty cycle)	X	2.79	67.6	18.0	1.71	125.5	±0.5 %
		Y	2.71	66.9	17.3		128.2	
		Z	2.64	66.2	17.0		123.5	
10403-AAA	CDMA2000 (1xEV-DO, Rev. 0)	X	4.78	67.5	18.3	3.76	130.6	±0.5 %
		Y	4.77	67.5	18.2		133.8	
		Z	4.65	66.5	17.8		130.0	
10404-AAA	CDMA2000 (1xEV-DO, Rev. A)	X	4.83	68.2	18.6	3.77	129.2	±0.7 %
		Y	4.68	67.4	18.0		131.9	
		Z	4.52	66.3	17.7		128.7	

The reported uncertainty of measurement is stated as the standard uncertainty of measurement multiplied by the coverage factor $k=2$, which for a normal distribution corresponds to a coverage probability of approximately 95%.

^A The uncertainties of NormX,Y,Z do not affect the E^2 -field uncertainty inside TSL (see Pages 7 and 8).

^B Numerical linearization parameter: uncertainty not required.

^E Uncertainty is determined using the max. deviation from linear response applying rectangular distribution and is expressed for the square of the field value.

DASY/EASY - Parameters of Probe: ES3DV3 - SN:3287

Calibration Parameter Determined in Head Tissue Simulating Media

f (MHz) ^C	Relative Permittivity ^F	Conductivity (S/m) ^F	ConvF X	ConvF Y	ConvF Z	Alpha ^G	Depth ^G (mm)	Unct. (k=2)
750	41.9	0.89	6.52	6.52	6.52	0.47	1.46	± 12.0 %
835	41.5	0.90	6.30	6.30	6.30	0.40	1.59	± 12.0 %
1750	40.1	1.37	5.27	5.27	5.27	0.63	1.34	± 12.0 %
1900	40.0	1.40	5.08	5.08	5.08	0.62	1.37	± 12.0 %
2450	39.2	1.80	4.43	4.43	4.43	0.79	1.28	± 12.0 %
2600	39.0	1.96	4.29	4.29	4.29	0.77	1.38	± 12.0 %

^C Frequency validity of ± 100 MHz only applies for DASY v4.4 and higher (see Page 2), else it is restricted to ± 50 MHz. The uncertainty is the RSS of the ConvF uncertainty at calibration frequency and the uncertainty for the indicated frequency band.

^F At frequencies below 3 GHz, the validity of tissue parameters (ϵ and σ) can be relaxed to ± 10% if liquid compensation formula is applied to measured SAR values. At frequencies above 3 GHz, the validity of tissue parameters (ϵ and σ) is restricted to ± 5%. The uncertainty is the RSS of the ConvF uncertainty for indicated target tissue parameters.

^G Alpha/Depth are determined during calibration. SPEAG warrants that the remaining deviation due to the boundary effect after compensation is always less than ± 1% for frequencies below 3 GHz and below ± 2% for frequencies between 3-6 GHz at any distance larger than half the probe tip diameter from the boundary.

DASY/EASY - Parameters of Probe: ES3DV3 - SN:3287

Calibration Parameter Determined in Body Tissue Simulating Media

f (MHz) ^C	Relative Permittivity ^F	Conductivity (S/m) ^F	ConvF X	ConvF Y	ConvF Z	Alpha ^G	Depth ^G (mm)	Unct. (k=2)
750	55.5	0.96	6.09	6.09	6.09	0.55	1.37	± 12.0 %
835	55.2	0.97	6.04	6.04	6.04	0.55	1.39	± 12.0 %
1750	53.4	1.49	4.93	4.93	4.93	0.39	1.73	± 12.0 %
1900	53.3	1.52	4.67	4.67	4.67	0.38	1.75	± 12.0 %
2450	52.7	1.95	4.17	4.17	4.17	0.60	1.20	± 12.0 %
2600	52.5	2.16	4.00	4.00	4.00	0.60	1.10	± 12.0 %

^C Frequency validity of ± 100 MHz only applies for DASY v4.4 and higher (see Page 2), else it is restricted to ± 50 MHz. The uncertainty is the RSS of the ConvF uncertainty at calibration frequency and the uncertainty for the indicated frequency band.

^F At frequencies below 3 GHz, the validity of tissue parameters (ϵ and σ) can be relaxed to ± 10% if liquid compensation formula is applied to measured SAR values. At frequencies above 3 GHz, the validity of tissue parameters (ϵ and σ) is restricted to ± 5%. The uncertainty is the RSS of the ConvF uncertainty for indicated target tissue parameters.

^G Alpha/Depth are determined during calibration. SPEAG warrants that the remaining deviation due to the boundary effect after compensation is always less than ± 1% for frequencies below 3 GHz and below ± 2% for frequencies between 3-6 GHz at any distance larger than half the probe tip diameter from the boundary.

Frequency Response of E-Field

(TEM-Cell:ifi110 EXX, Waveguide: R22)

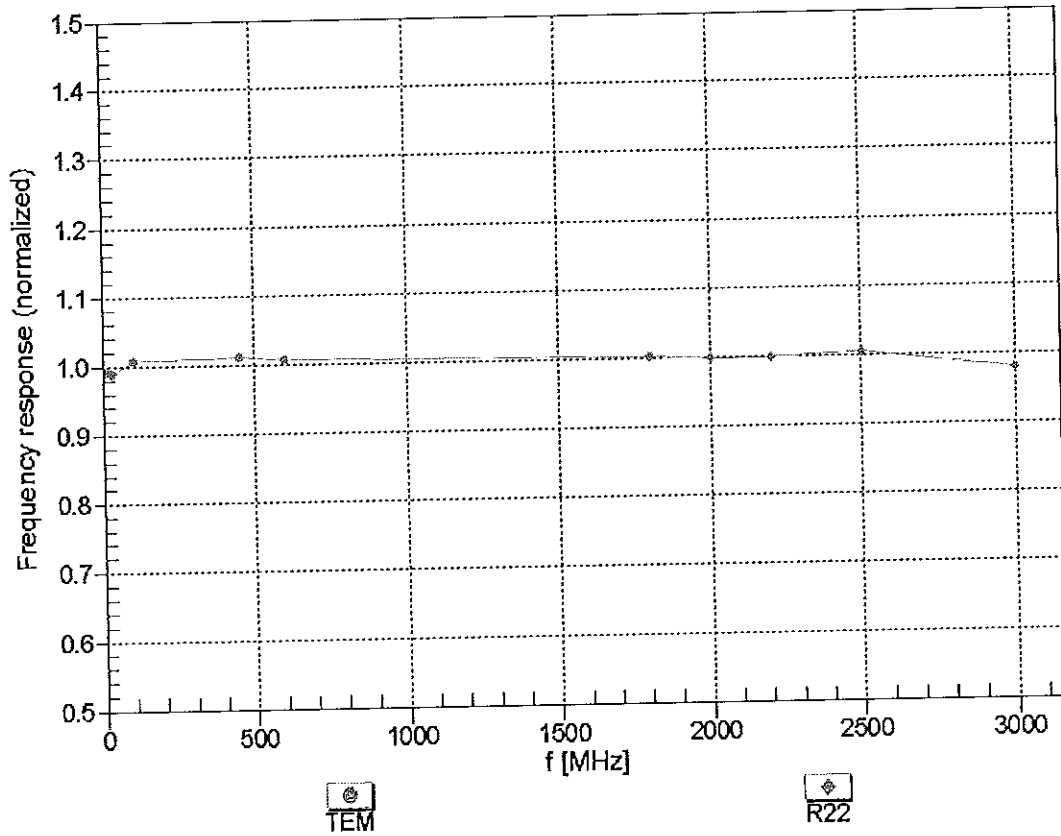

Uncertainty of Frequency Response of E-field: $\pm 6.3\%$ (k=2)

Receiving Pattern (ϕ), $\vartheta = 0^\circ$

f=600 MHz, TEM

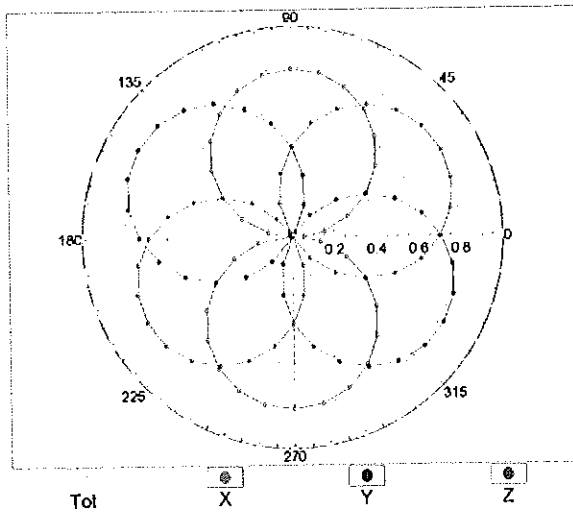

f=1800 MHz, R22

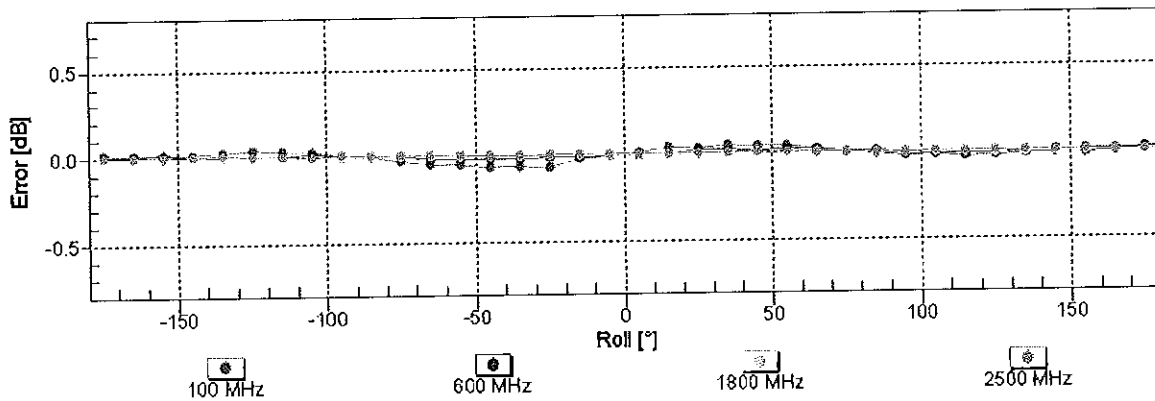
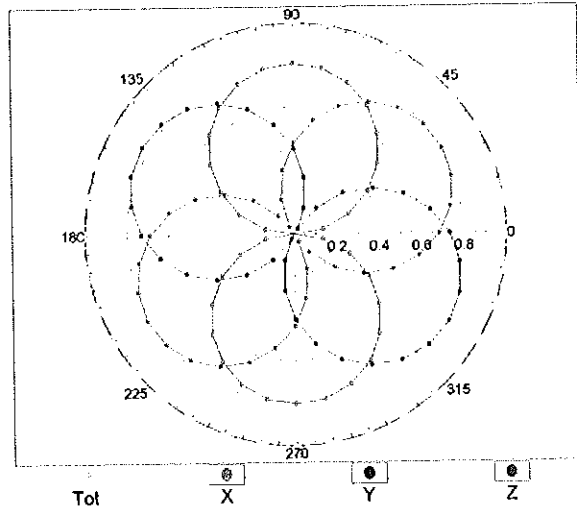

Uncertainty of Axial Isotropy Assessment: $\pm 0.5\%$ (k=2)

Dynamic Range f(SAR_{head}) (TEM cell , f = 900 MHz)

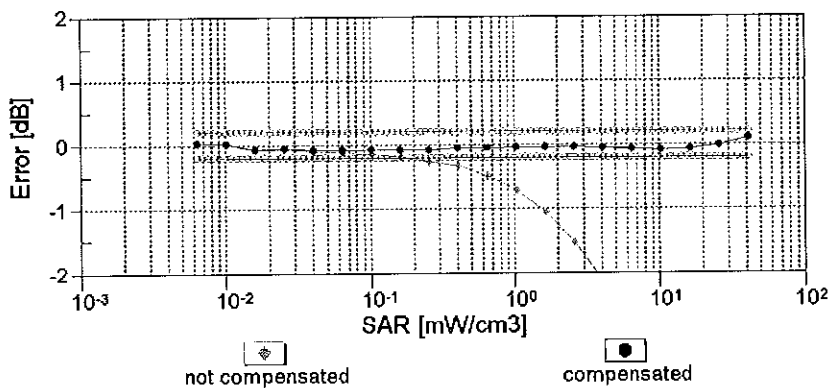
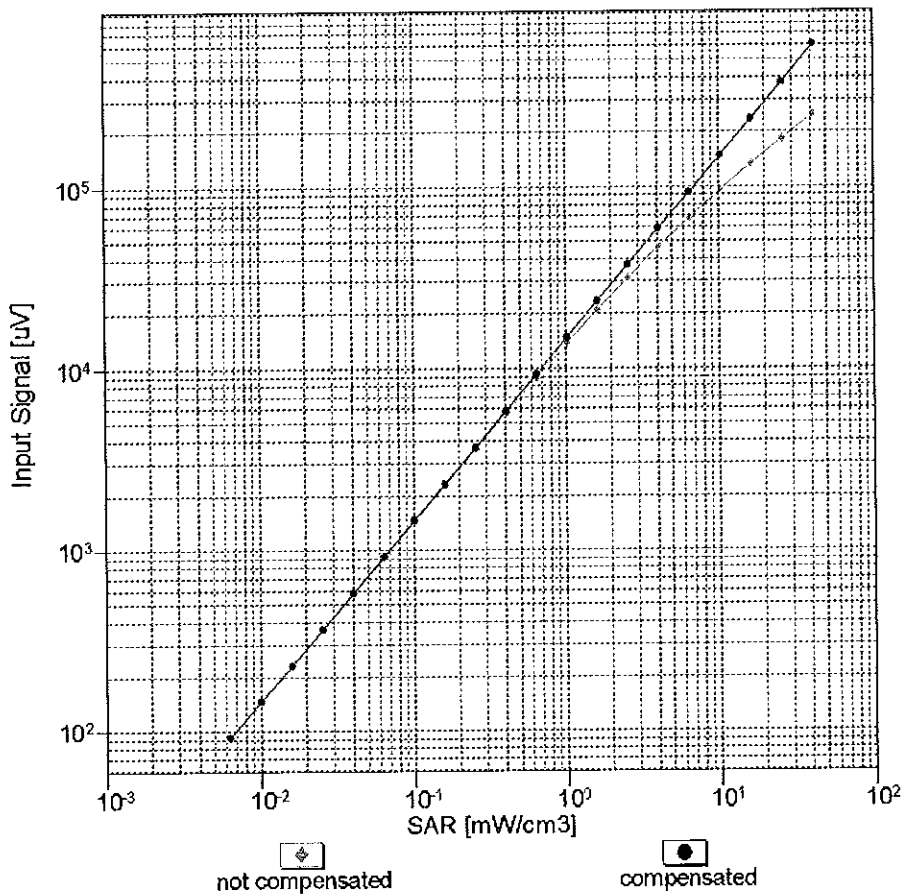

Uncertainty of Linearity Assessment: ± 0.6% (k=2)

Conversion Factor Assessment

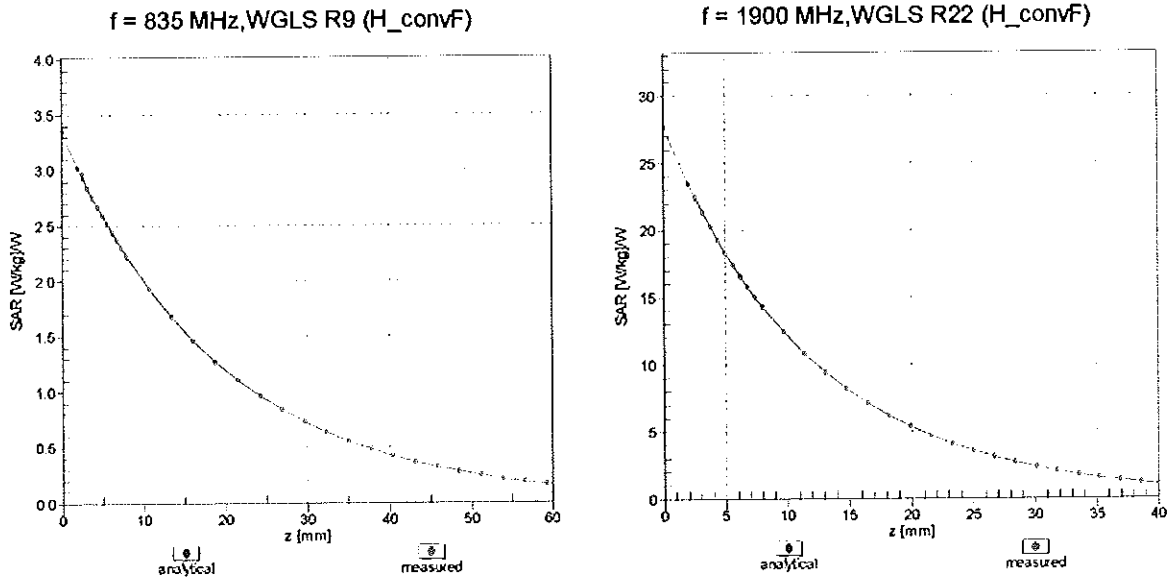

Deviation from Isotropy in Liquid Error (ϕ, θ), f = 900 MHz

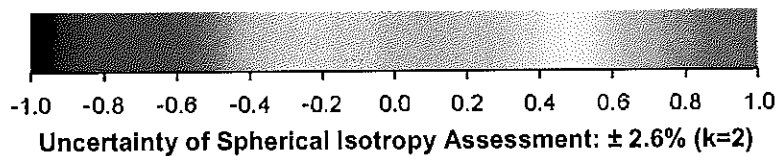
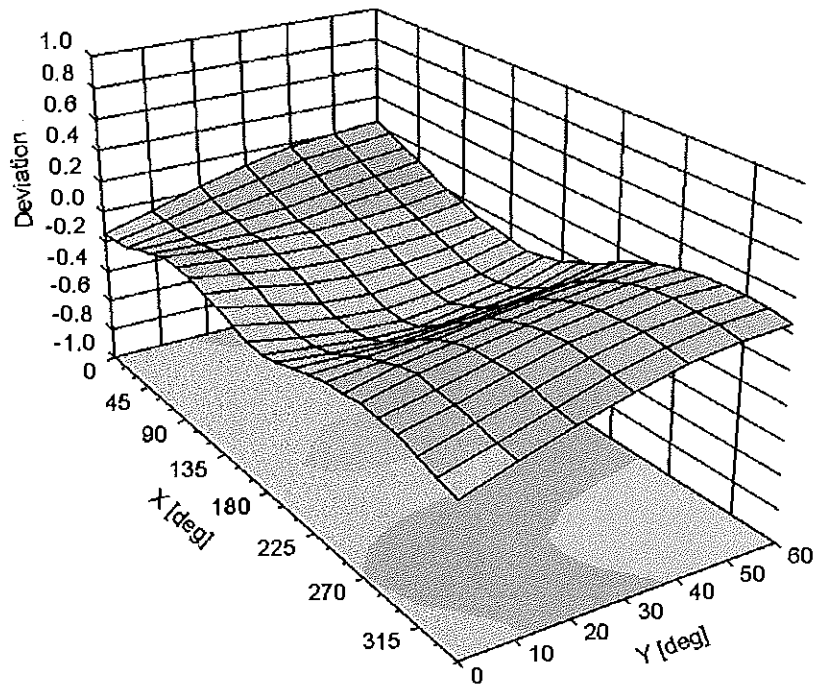

DASY/EASY - Parameters of Probe: ES3DV3 - SN:3287**Other Probe Parameters**

Sensor Arrangement	Triangular
Connector Angle (°)	-15
Mechanical Surface Detection Mode	enabled
Optical Surface Detection Mode	disabled
Probe Overall Length	337 mm
Probe Body Diameter	10 mm
Tip Length	10 mm
Tip Diameter	4 mm
Probe Tip to Sensor X Calibration Point	2 mm
Probe Tip to Sensor Y Calibration Point	2 mm
Probe Tip to Sensor Z Calibration Point	2 mm
Recommended Measurement Distance from Surface	3 mm



Accredited by the Swiss Accreditation Service (SAS)

Accreditation No.: **SCS 108**

The Swiss Accreditation Service is one of the signatories to the EA
Multilateral Agreement for the recognition of calibration certificates

Client **PC Test**

Certificate No: **ES3-3209_Mar14**

CALIBRATION CERTIFICATE

Object **ES3DV3 - SN:3209**

Calibration procedure(s) **QA CAL-01.v9, QA CAL-23.v5, QA CAL-25.v6
Calibration procedure for dosimetric E-field probes**

*CCV
3/27/14*

Calibration date: **March 19, 2014**

This calibration certificate documents the traceability to national standards, which realize the physical units of measurements (SI).
The measurements and the uncertainties with confidence probability are given on the following pages and are part of the certificate.

All calibrations have been conducted in the closed laboratory facility: environment temperature (22 ± 3)°C and humidity < 70%.

Calibration Equipment used (M&TE critical for calibration)

Primary Standards	ID	Cal Date (Certificate No.)	Scheduled Calibration
Power meter E4419B	GB41293874	04-Apr-13 (No. 217-01733)	Apr-14
Power sensor E4412A	MY41498087	04-Apr-13 (No. 217-01733)	Apr-14
Reference 3 dB Attenuator	SN: S5054 (3c)	04-Apr-13 (No. 217-01737)	Apr-14
Reference 20 dB Attenuator	SN: S5277 (20x)	04-Apr-13 (No. 217-01735)	Apr-14
Reference 30 dB Attenuator	SN: S5129 (30b)	04-Apr-13 (No. 217-01738)	Apr-14
Reference Probe ES3DV2	SN: 3013	30-Dec-13 (No. ES3-3013_Dec13)	Dec-14
DAE4	SN: 660	13-Dec-13 (No. DAE4-660_Dec13)	Dec-14
Secondary Standards	ID	Check Date (in house)	Scheduled Check
RF generator HP 8648C	US3642U01700	4-Aug-99 (in house check Apr-13)	In house check: Apr-16
Network Analyzer HP 8753E	US37390585	18-Oct-01 (in house check Oct-13)	In house check: Oct-14

Calibrated by:	Name Claudio Leubler	Function Laboratory Technician	Signature
Approved by:	Name Katja Pokovic	Function Technical Manager	Signature
			Issued: March 20, 2014
This calibration certificate shall not be reproduced except in full without written approval of the laboratory.			



Accredited by the Swiss Accreditation Service (SAS)

Accreditation No.: **SCS 108**

The Swiss Accreditation Service is one of the signatories to the EA
Multilateral Agreement for the recognition of calibration certificates

Glossary:

TSL	tissue simulating liquid
NORM _{x,y,z}	sensitivity in free space
ConvF	sensitivity in TSL / NORM _{x,y,z}
DCP	diode compression point
CF	crest factor (1/duty_cycle) of the RF signal
A, B, C, D	modulation dependent linearization parameters
Polarization φ	φ rotation around probe axis
Polarization ϑ	ϑ rotation around an axis that is in the plane normal to probe axis (at measurement center), i.e., $\vartheta = 0$ is normal to probe axis
Connector Angle	information used in DASY system to align probe sensor X to the robot coordinate system

Calibration is Performed According to the Following Standards:

- IEEE Std 1528-2013, "IEEE Recommended Practice for Determining the Peak Spatial-Averaged Specific Absorption Rate (SAR) in the Human Head from Wireless Communications Devices: Measurement Techniques", June 2013
- IEC 62209-1, "Procedure to measure the Specific Absorption Rate (SAR) for hand-held devices used in close proximity to the ear (frequency range of 300 MHz to 3 GHz)", February 2005

Methods Applied and Interpretation of Parameters:

- NORM_{x,y,z}**: Assessed for E-field polarization $\vartheta = 0$ ($f \leq 900$ MHz in TEM-cell; $f > 1800$ MHz: R22 waveguide). NORM_{x,y,z} are only intermediate values, i.e., the uncertainties of NORM_{x,y,z} does not affect the E²-field uncertainty inside TSL (see below ConvF).
- NORM(f)_{x,y,z} = NORM_{x,y,z} * frequency_response** (see Frequency Response Chart). This linearization is implemented in DASY4 software versions later than 4.2. The uncertainty of the frequency response is included in the stated uncertainty of ConvF.
- DCP_{x,y,z}**: DCP are numerical linearization parameters assessed based on the data of power sweep with CW signal (no uncertainty required). DCP does not depend on frequency nor media.
- PAR**: PAR is the Peak to Average Ratio that is not calibrated but determined based on the signal characteristics
- A_{x,y,z}; B_{x,y,z}; C_{x,y,z}; D_{x,y,z}; VR_{x,y,z}**: A, B, C, D are numerical linearization parameters assessed based on the data of power sweep for specific modulation signal. The parameters do not depend on frequency nor media. VR is the maximum calibration range expressed in RMS voltage across the diode.
- ConvF and Boundary Effect Parameters**: Assessed in flat phantom using E-field (or Temperature Transfer Standard for $f \leq 800$ MHz) and inside waveguide using analytical field distributions based on power measurements for $f > 800$ MHz. The same setups are used for assessment of the parameters applied for boundary compensation (alpha, depth) of which typical uncertainty values are given. These parameters are used in DASY4 software to improve probe accuracy close to the boundary. The sensitivity in TSL corresponds to NORM_{x,y,z} * ConvF whereby the uncertainty corresponds to that given for ConvF. A frequency dependent ConvF is used in DASY version 4.4 and higher which allows extending the validity from ± 50 MHz to ± 100 MHz.
- Spherical isotropy (3D deviation from isotropy)**: in a field of low gradients realized using a flat phantom exposed by a patch antenna.
- Sensor Offset**: The sensor offset corresponds to the offset of virtual measurement center from the probe tip (on probe axis). No tolerance required.
- Connector Angle**: The angle is assessed using the information gained by determining the NORM_x (no uncertainty required).

Probe ES3DV3

SN:3209

Manufactured: October 14, 2008
Calibrated: March 19, 2014

Calibrated for DASY/EASY Systems
(Note: non-compatible with DASY2 system!)

DASY/EASY - Parameters of Probe: ES3DV3 - SN:3209

Basic Calibration Parameters

	Sensor X	Sensor Y	Sensor Z	Unc (k=2)
Norm ($\mu\text{V}/(\text{V}/\text{m})^2$) ^A	1.35	1.32	1.13	$\pm 10.1\%$
DCP (mV) ^B	101.5	101.0	102.5	

Modulation Calibration Parameters

UID	Communication System Name		A dB	B dB $\sqrt{\mu\text{V}}$	C	D dB	VR mV	Unc ^F (k=2)
0	CW	X	0.0	0.0	1.0	0.00	188.4	$\pm 3.8\%$
		Y	0.0	0.0	1.0		180.7	
		Z	0.0	0.0	1.0		200.1	
10010- CAA	SAR Validation (Square, 100ms, 10ms)	X	2.80	64.7	12.3	10.00	43.2	$\pm 1.4\%$
		Y	3.12	65.6	13.1		41.9	
		Z	2.67	64.0	11.7		39.4	
10011- CAB	UMTS-FDD (WCDMA)	X	3.39	67.7	19.0	2.91	149.2	$\pm 0.5\%$
		Y	3.38	67.7	19.0		146.1	
		Z	3.35	67.6	18.7		136.1	
10012- CAA	IEEE 802.11b WiFi 2.4 GHz (DSSS, 1 Mbps)	X	3.01	69.8	19.4	1.87	149.4	$\pm 0.7\%$
		Y	3.06	70.1	19.6		147.1	
		Z	2.98	69.7	19.2		136.4	
10021- DAB	GSM-FDD (TDMA, GMSK)	X	5.47	79.6	20.4	9.39	146.9	$\pm 1.7\%$
		Y	7.76	84.9	22.9		134.2	
		Z	4.34	75.3	18.5		134.2	
10023- DAB	GPRS-FDD (TDMA, GMSK, TN 0)	X	6.66	82.9	21.6	9.57	139.8	$\pm 2.5\%$
		Y	9.36	88.2	24.2		131.5	
		Z	4.67	76.1	18.8		144.8	
10024- DAB	GPRS-FDD (TDMA, GMSK, TN 0-1)	X	5.89	79.1	17.9	6.56	141.2	$\pm 1.9\%$
		Y	27.58	99.6	24.8		145.8	
		Z	5.42	77.8	17.4		129.3	
10027- DAB	GPRS-FDD (TDMA, GMSK, TN 0-1-2)	X	9.68	85.3	19.0	4.80	136.9	$\pm 2.2\%$
		Y	36.47	100.0	23.3		139.2	
		Z	31.63	96.5	21.4		149.2	
10028- DAB	GPRS-FDD (TDMA, GMSK, TN 0-1-2-3)	X	40.09	99.7	21.7	3.55	125.9	$\pm 1.9\%$
		Y	47.92	99.6	21.7		127.6	
		Z	61.98	99.9	20.8		136.2	
10032- CAA	IEEE 802.15.1 Bluetooth (GFSK, DH5)	X	99.32	95.7	16.5	1.16	145.1	$\pm 1.7\%$
		Y	55.30	99.5	19.3		145.6	
		Z	0.54	60.4	5.7		132.7	
10039- CAB	CDMA2000 (1xRTT, RC1)	X	4.77	67.1	19.2	4.57	145.6	$\pm 0.9\%$
		Y	4.85	67.5	19.5		147.8	
		Z	4.67	66.7	18.9		133.4	

10081-CAB	CDMA2000 (1xRTT, RC3)	X	3.93	66.4	18.8	3.97	140.9	±0.7 %
		Y	4.02	66.9	19.1		146.0	
		Z	3.86	66.1	18.5		129.1	
10098-CAB	UMTS-FDD (HSUPA, Subtest 2)	X	4.56	66.6	18.6	3.98	132.8	±0.7 %
		Y	4.58	66.7	18.7		135.9	
		Z	4.63	67.0	18.7		143.0	
10100-CAB	LTE-FDD (SC-FDMA, 100% RB, 20 MHz, QPSK)	X	6.42	67.5	19.8	5.67	139.3	±1.4 %
		Y	6.49	67.9	20.1		143.0	
		Z	6.18	66.7	19.3		126.9	
10108-CAB	LTE-FDD (SC-FDMA, 100% RB, 10 MHz, QPSK)	X	6.28	67.1	19.7	5.80	136.9	±1.4 %
		Y	6.35	67.5	20.0		140.4	
		Z	6.36	67.5	19.8		147.1	
10110-CAB	LTE-FDD (SC-FDMA, 100% RB, 5 MHz, QPSK)	X	5.94	66.5	19.4	5.75	134.0	±1.4 %
		Y	6.01	66.9	19.8		136.4	
		Z	5.99	66.8	19.5		143.6	
10114-CAA	IEEE 802.11n (HT Greenfield, 13.5 Mbps, BPSK)	X	10.02	68.5	21.1	8.10	127.2	±2.2 %
		Y	10.31	69.3	21.8		130.2	
		Z	10.12	68.8	21.2		139.0	
10117-CAA	IEEE 802.11n (HT Mixed, 13.5 Mbps, BPSK)	X	10.03	68.5	21.1	8.07	129.2	±2.2 %
		Y	10.31	69.3	21.7		131.2	
		Z	10.15	68.9	21.3		141.0	
10151-CAB	LTE-TDD (SC-FDMA, 50% RB, 20 MHz, QPSK)	X	8.54	72.4	24.8	9.28	139.6	±3.0 %
		Y	9.29	75.2	26.7		144.1	
		Z	8.55	72.5	24.7		149.7	
10154-CAB	LTE-FDD (SC-FDMA, 50% RB, 10 MHz, QPSK)	X	5.94	66.5	19.4	5.75	134.7	±1.4 %
		Y	6.00	66.9	19.7		136.7	
		Z	6.01	66.9	19.5		143.3	
10160-CAB	LTE-FDD (SC-FDMA, 50% RB, 15 MHz, QPSK)	X	6.40	67.1	19.7	5.82	139.9	±1.7 %
		Y	6.48	67.5	20.0		142.9	
		Z	6.43	67.3	19.7		148.7	
10169-CAB	LTE-FDD (SC-FDMA, 1 RB, 20 MHz, QPSK)	X	4.90	66.8	19.8	5.73	136.1	±1.4 %
		Y	5.03	67.2	20.2		141.1	
		Z	5.08	67.3	20.0		148.1	
10172-CAB	LTE-TDD (SC-FDMA, 1 RB, 20 MHz, QPSK)	X	6.56	72.5	25.2	9.21	125.7	±2.5 %
		Y	7.28	75.4	27.1		128.8	
		Z	6.78	73.0	25.2		138.3	
10175-CAB	LTE-FDD (SC-FDMA, 1 RB, 10 MHz, QPSK)	X	4.86	66.6	19.7	5.72	133.7	±1.4 %
		Y	4.97	66.9	20.0		136.3	
		Z	5.04	67.2	19.9		145.7	
10181-CAB	LTE-FDD (SC-FDMA, 1 RB, 15 MHz, QPSK)	X	4.88	66.7	19.7	5.72	133.3	±1.4 %
		Y	4.99	67.0	20.0		136.5	
		Z	5.06	67.3	19.9		145.7	

10193-CAA	IEEE 802.11n (HT Greenfield, 6.5 Mbps, BPSK)	X	10.05	69.2	21.7	8.09	146.7	±2.5 %
		Y	10.20	69.8	22.1		146.9	
		Z	9.76	68.5	21.1		132.1	
10196-CAA	IEEE 802.11n (HT Mixed, 6.5 Mbps, BPSK)	X	10.05	69.2	21.7	8.10	148.5	±2.2 %
		Y	10.21	69.9	22.2		148.0	
		Z	9.75	68.5	21.2		133.6	
10219-CAA	IEEE 802.11n (HT Mixed, 7.2 Mbps, BPSK)	X	9.96	69.2	21.6	8.03	148.9	±2.5 %
		Y	10.09	69.7	22.1		147.4	
		Z	9.67	68.5	21.1		133.4	
10222-CAA	IEEE 802.11n (HT Mixed, 15 Mbps, BPSK)	X	10.00	68.5	21.1	8.06	127.8	±2.2 %
		Y	10.21	69.1	21.6		127.3	
		Z	10.11	68.9	21.2		140.4	
10225-CAB	UMTS-FDD (HSPA+)	X	6.81	66.5	19.3	5.97	125.8	±1.4 %
		Y	7.07	67.5	19.9		149.0	
		Z	6.92	67.0	19.4		136.8	
10237-CAB	LTE-TDD (SC-FDMA, 1 RB, 10 MHz, QPSK)	X	6.62	72.8	25.3	9.21	128.5	±2.2 %
		Y	7.33	75.7	27.2		129.5	
		Z	6.87	73.4	25.5		141.8	
10252-CAB	LTE-TDD (SC-FDMA, 50% RB, 10 MHz, QPSK)	X	7.92	71.5	24.4	9.24	131.3	±3.0 %
		Y	8.35	73.3	25.7		131.3	
		Z	7.94	71.6	24.3		140.2	
10267-CAB	LTE-TDD (SC-FDMA, 100% RB, 10 MHz, QPSK)	X	8.52	72.3	24.8	9.30	138.8	±3.0 %
		Y	9.10	74.5	26.3		139.5	
		Z	8.53	72.3	24.6		149.4	
10274-CAB	UMTS-FDD (HSUPA, Subtest 5, 3GPP Rel8.10)	X	5.98	67.1	19.1	4.87	144.4	±0.9 %
		Y	5.99	67.3	19.2		144.0	
		Z	5.80	66.6	18.7		131.0	
10275-CAB	UMTS-FDD (HSUPA, Subtest 5, 3GPP Rel8.4)	X	4.51	67.2	19.0	3.96	148.6	±0.7 %
		Y	4.30	66.3	18.6		127.3	
		Z	4.40	66.9	18.7		135.9	
10291-AAB	CDMA2000, RC3, SO55, Full Rate	X	3.61	66.9	18.8	3.46	138.3	±0.7 %
		Y	3.67	67.2	19.0		140.5	
		Z	3.62	67.0	18.7		128.8	
10292-AAB	CDMA2000, RC3, SO32, Full Rate	X	3.59	67.1	18.9	3.39	141.5	±0.7 %
		Y	3.59	67.1	18.9		142.0	
		Z	3.59	67.2	18.8		130.8	
10297-AAA	LTE-FDD (SC-FDMA, 50% RB, 20 MHz, QPSK)	X	6.27	67.0	19.7	5.81	135.3	±1.7 %
		Y	6.31	67.3	19.9		136.0	
		Z	6.36	67.4	19.8		147.2	
10311-AAA	LTE-FDD (SC-FDMA, 100% RB, 15 MHz, QPSK)	X	6.91	67.9	20.2	6.06	141.9	±1.7 %
		Y	6.94	68.1	20.4		142.7	
		Z	6.68	67.1	19.7		130.3	

10315-AAA	IEEE 802.11b WiFi 2.4 GHz (DSSS, 1 Mbps, 96pc duty cycle)	X	2.94	69.9	19.6	1.71	148.6	±0.5 %
		Y	2.81	68.8	19.0		148.8	
		Z	2.92	69.7	19.2		138.1	
10403-AAB	CDMA2000 (1xEV-DO, Rev. 0)	X	4.76	68.7	19.1	3.76	128.0	±0.5 %
		Y	4.71	68.2	18.9		129.2	
		Z	4.85	68.8	19.0		141.9	
10404-AAB	CDMA2000 (1xEV-DO, Rev. A)	X	4.64	68.5	19.0	3.77	126.3	±0.7 %
		Y	4.60	68.2	18.9		127.9	
		Z	4.74	68.8	19.0		140.6	

The reported uncertainty of measurement is stated as the standard uncertainty of measurement multiplied by the coverage factor $k=2$, which for a normal distribution corresponds to a coverage probability of approximately 95%.

^A The uncertainties of NormX,Y,Z do not affect the E^2 -field uncertainty inside TSL (see Pages 8 and 9).

^B Numerical linearization parameter: uncertainty not required.

^E Uncertainty is determined using the max. deviation from linear response applying rectangular distribution and is expressed for the square of the field value.

DASY/EASY - Parameters of Probe: ES3DV3 - SN:3209

Calibration Parameter Determined in Head Tissue Simulating Media

f (MHz) ^C	Relative Permittivity ^F	Conductivity (S/m) ^F	ConvF X	ConvF Y	ConvF Z	Alpha ^G	Depth ^G (mm)	Unct. (k=2)
750	41.9	0.89	6.43	6.43	6.43	0.29	2.01	± 12.0 %
835	41.5	0.90	6.23	6.23	6.23	0.34	1.70	± 12.0 %
1750	40.1	1.37	5.24	5.24	5.24	0.80	1.13	± 12.0 %
1900	40.0	1.40	5.13	5.13	5.13	0.46	1.49	± 12.0 %
2450	39.2	1.80	4.54	4.54	4.54	0.63	1.38	± 12.0 %
2600	39.0	1.96	4.38	4.38	4.38	0.76	1.28	± 12.0 %

^C Frequency validity of ± 100 MHz only applies for DASY v4.4 and higher (see Page 2), else it is restricted to ± 50 MHz. The uncertainty is the RSS of the ConvF uncertainty at calibration frequency and the uncertainty for the indicated frequency band.

^F At frequencies below 3 GHz, the validity of tissue parameters (ϵ and σ) can be relaxed to ± 10% if liquid compensation formula is applied to measured SAR values. At frequencies above 3 GHz, the validity of tissue parameters (ϵ and σ) is restricted to ± 5%. The uncertainty is the RSS of the ConvF uncertainty for indicated target tissue parameters.

^G Alpha/Depth are determined during calibration. SPEAG warrants that the remaining deviation due to the boundary effect after compensation is always less than ± 1% for frequencies below 3 GHz and below ± 2% for frequencies between 3-6 GHz at any distance larger than half the probe tip diameter from the boundary.

DASY/EASY - Parameters of Probe: ES3DV3 - SN:3209

Calibration Parameter Determined in Body Tissue Simulating Media

f (MHz) ^C	Relative Permittivity ^F	Conductivity (S/m) ^F	ConvF X	ConvF Y	ConvF Z	Alpha ^G	Depth ^G (mm)	Unct. (k=2)
750	55.5	0.96	6.16	6.16	6.16	0.26	2.23	± 12.0 %
835	55.2	0.97	6.14	6.14	6.14	0.80	1.13	± 12.0 %
1750	53.4	1.49	4.85	4.85	4.85	0.59	1.42	± 12.0 %
1900	53.3	1.52	4.68	4.68	4.68	0.52	1.59	± 12.0 %
2450	52.7	1.95	4.20	4.20	4.20	0.73	1.08	± 12.0 %
2600	52.5	2.16	4.04	4.04	4.04	0.80	1.00	± 12.0 %

^C Frequency validity of ± 100 MHz only applies for DASY v4.4 and higher (see Page 2), else it is restricted to ± 50 MHz. The uncertainty is the RSS of the ConvF uncertainty at calibration frequency and the uncertainty for the indicated frequency band.

^F At frequencies below 3 GHz, the validity of tissue parameters (ϵ and σ) can be relaxed to ± 10% if liquid compensation formula is applied to measured SAR values. At frequencies above 3 GHz, the validity of tissue parameters (ϵ and σ) is restricted to ± 5%. The uncertainty is the RSS of the ConvF uncertainty for indicated target tissue parameters.

^G Alpha/Depth are determined during calibration. SPEAG warrants that the remaining deviation due to the boundary effect after compensation is always less than ± 1% for frequencies below 3 GHz and below ± 2% for frequencies between 3-6 GHz at any distance larger than half the probe tip diameter from the boundary.

Frequency Response of E-Field

(TEM-Cell:ifi110 EXX, Waveguide: R22)

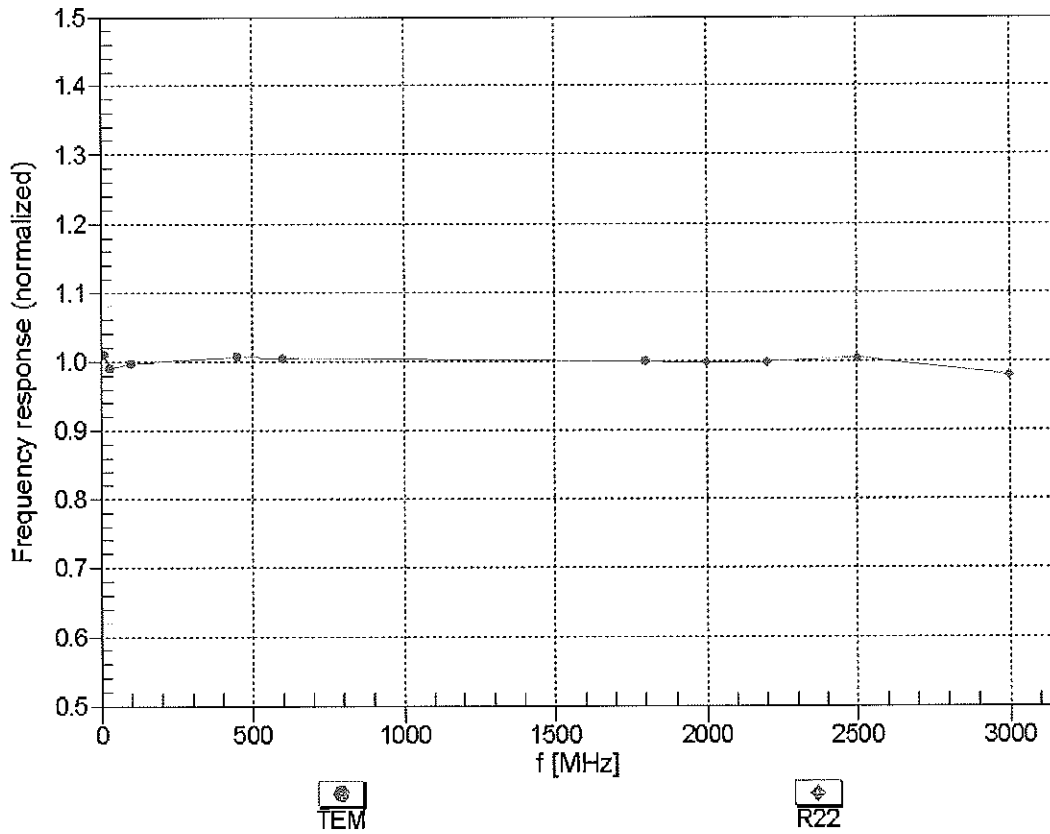

Uncertainty of Frequency Response of E-field: $\pm 6.3\%$ (k=2)

Receiving Pattern (ϕ), $\vartheta = 0^\circ$

f=600 MHz,TEM

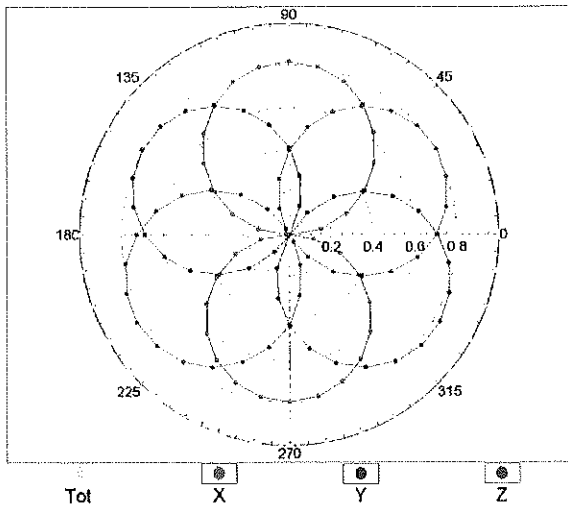

f=1800 MHz,R22

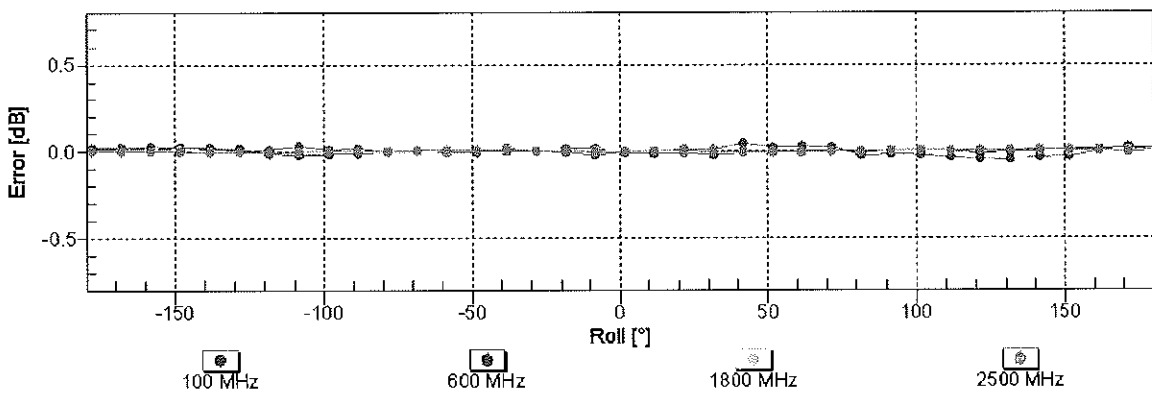
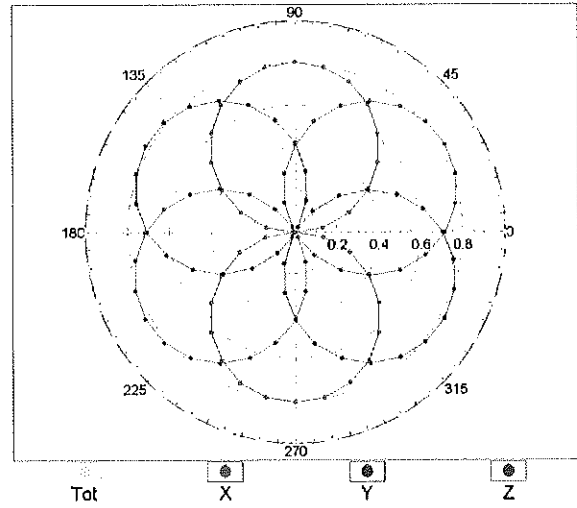

Uncertainty of Axial Isotropy Assessment: $\pm 0.5\%$ (k=2)

Dynamic Range $f(\text{SAR}_{\text{head}})$ (TEM cell , $f_{\text{eval}} = 1900 \text{ MHz}$)

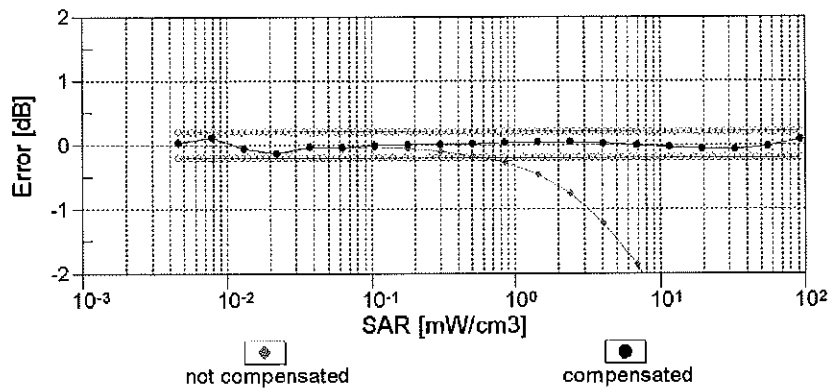
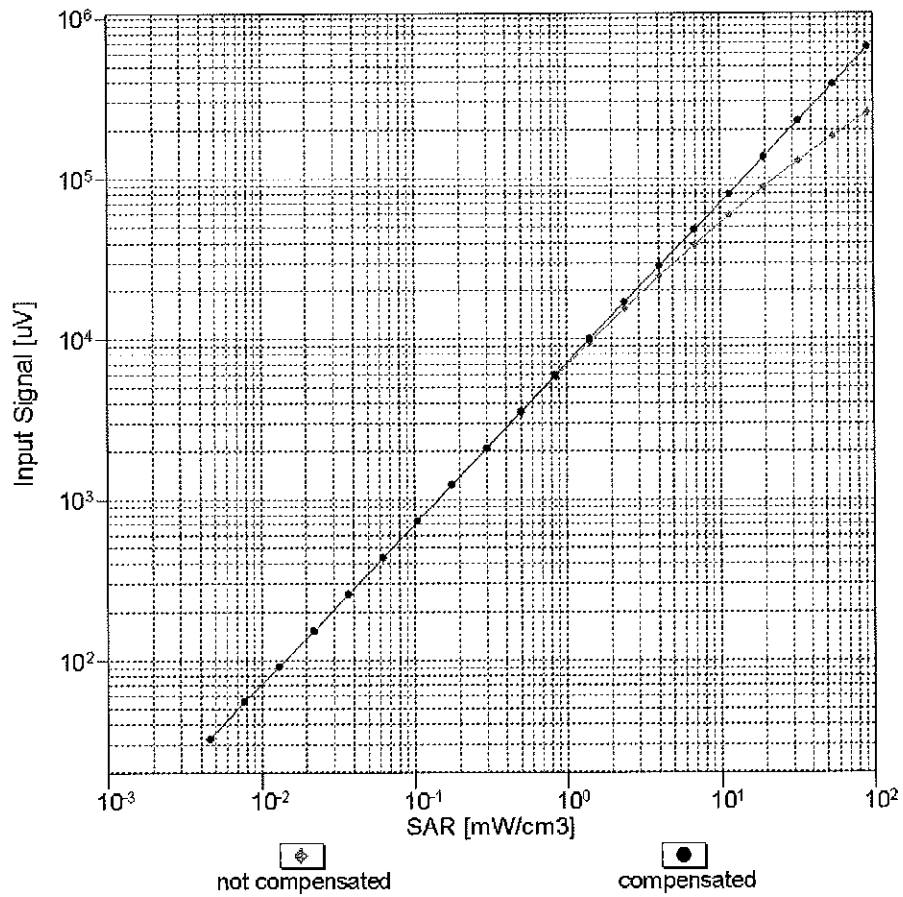

Uncertainty of Linearity Assessment: $\pm 0.6\%$ ($k=2$)

Conversion Factor Assessment

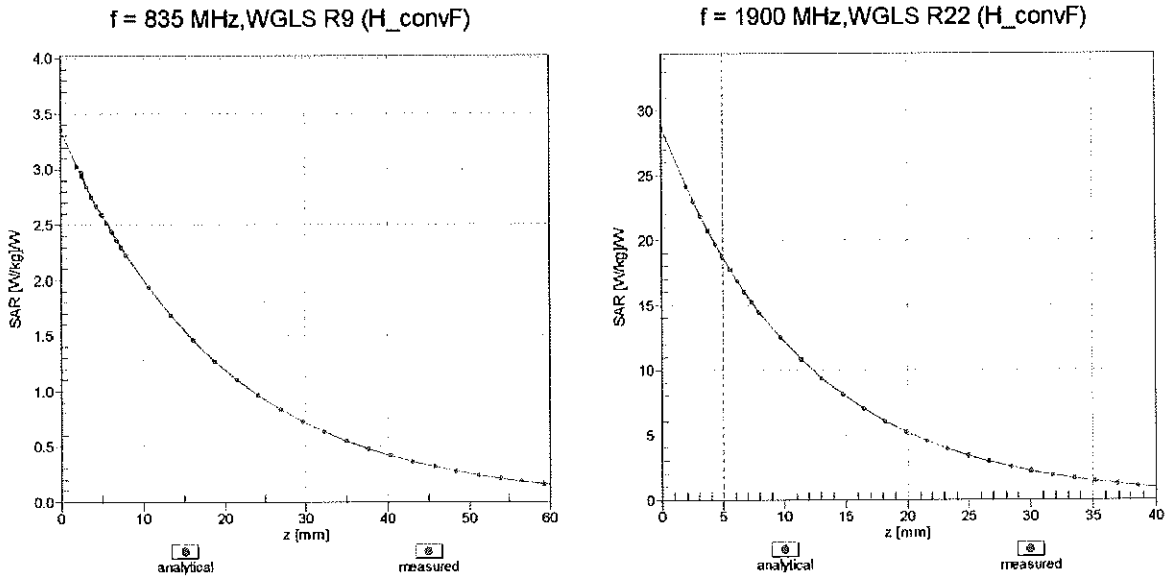

Deviation from Isotropy in Liquid Error (ϕ, θ), f = 900 MHz

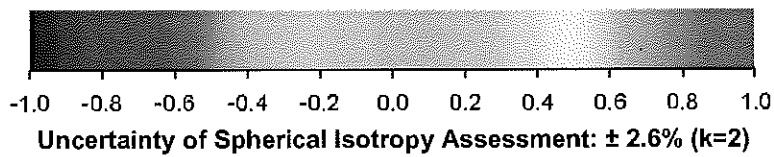
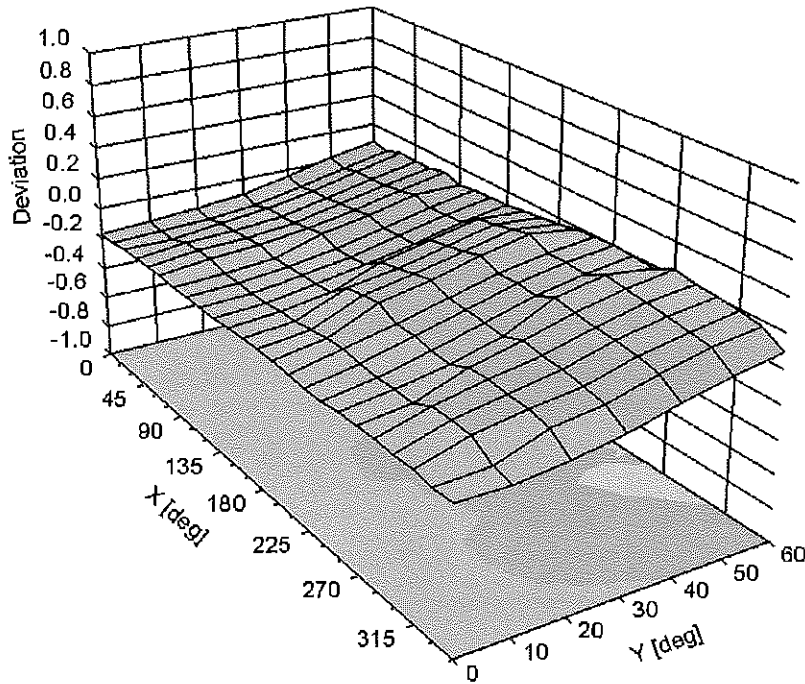

DASY/EASY - Parameters of Probe: ES3DV3 - SN:3209**Other Probe Parameters**

Sensor Arrangement	Triangular
Connector Angle (°)	-38.3
Mechanical Surface Detection Mode	enabled
Optical Surface Detection Mode	disabled
Probe Overall Length	337 mm
Probe Body Diameter	10 mm
Tip Length	10 mm
Tip Diameter	4 mm
Probe Tip to Sensor X Calibration Point	2 mm
Probe Tip to Sensor Y Calibration Point	2 mm
Probe Tip to Sensor Z Calibration Point	2 mm
Recommended Measurement Distance from Surface	3 mm



Accredited by the Swiss Accreditation Service (SAS)
The Swiss Accreditation Service is one of the signatories to the EA
Multilateral Agreement for the recognition of calibration certificates

Accreditation No.: **SCS 108**

Client **PC Test**

Certificate No: **ES3-3258_Feb14**

CALIBRATION CERTIFICATE

Object **ES3DV3 - SN:3258**

Calibration procedure(s) **QA CAL-01.v9, QA CAL-23.v5, QA CAL-25.v6
Calibration procedure for dosimetric E-field probes** *CCV
3/16/14*

Calibration date: **February 25, 2014**

This calibration certificate documents the traceability to national standards, which realize the physical units of measurements (SI).
The measurements and the uncertainties with confidence probability are given on the following pages and are part of the certificate.

All calibrations have been conducted in the closed laboratory facility: environment temperature (22 ± 3)°C and humidity < 70%.

Calibration Equipment used (M&TE critical for calibration)

Primary Standards	ID	Cal Date (Certificate No.)	Scheduled Calibration
Power meter E4419B	GB41293874	04-Apr-13 (No. 217-01733)	Apr-14
Power sensor E4412A	MY41498087	04-Apr-13 (No. 217-01733)	Apr-14
Reference 3 dB Attenuator	SN: S5054 (3c)	04-Apr-13 (No. 217-01737)	Apr-14
Reference 20 dB Attenuator	SN: S5277 (20x)	04-Apr-13 (No. 217-01735)	Apr-14
Reference 30 dB Attenuator	SN: S5129 (30b)	04-Apr-13 (No. 217-01738)	Apr-14
Reference Probe ES3DV2	SN: 3013	30-Dec-13 (No. ES3-3013_Dec13)	Dec-14
DAE4	SN: 660	13-Dec-13 (No. DAE4-660_Dec13)	Dec-14
Secondary Standards	ID	Check Date (in house)	Scheduled Check
RF generator HP 8648C	US3642U01700	4-Aug-99 (in house check Apr-13)	In house check: Apr-16
Network Analyzer HP 8753E	US37390585	18-Oct-01 (in house check Oct-13)	In house check: Oct-14

Calibrated by:	Name Israe El-Naouq	Function Laboratory Technician	Signature <i>Israe El-Naouq</i>
Approved by:	Name Katja Pokovic	Function Technical Manager	<i>Katja Pokovic</i>

Issued: February 27, 2014

This calibration certificate shall not be reproduced except in full without written approval of the laboratory.

PCT# 80615



Accredited by the Swiss Accreditation Service (SAS)

Accreditation No.: **SCS 108**

The Swiss Accreditation Service is one of the signatories to the EA
Multilateral Agreement for the recognition of calibration certificates

Glossary:

TSL	tissue simulating liquid
NORM _{x,y,z}	sensitivity in free space
ConvF	sensitivity in TSL / NORM _{x,y,z}
DCP	diode compression point
CF	crest factor (1/duty_cycle) of the RF signal
A, B, C, D	modulation dependent linearization parameters
Polarization φ	φ rotation around probe axis
Polarization ϑ	ϑ rotation around an axis that is in the plane normal to probe axis (at measurement center), i.e., $\vartheta = 0$ is normal to probe axis
Connector Angle	information used in DASY system to align probe sensor X to the robot coordinate system

Calibration is Performed According to the Following Standards:

- IEEE Std 1528-2013, "IEEE Recommended Practice for Determining the Peak Spatial-Averaged Specific Absorption Rate (SAR) in the Human Head from Wireless Communications Devices: Measurement Techniques", June 2013
- IEC 62209-1, "Procedure to measure the Specific Absorption Rate (SAR) for hand-held devices used in close proximity to the ear (frequency range of 300 MHz to 3 GHz)", February 2005

Methods Applied and Interpretation of Parameters:

- NORM_{x,y,z}:** Assessed for E-field polarization $\vartheta = 0$ ($f \leq 900$ MHz in TEM-cell; $f > 1800$ MHz: R22 waveguide). NORM_{x,y,z} are only intermediate values, i.e., the uncertainties of NORM_{x,y,z} does not affect the E²-field uncertainty inside TSL (see below ConvF).
- NORM(f)_{x,y,z} = NORM_{x,y,z} * frequency_response** (see Frequency Response Chart). This linearization is implemented in DASY4 software versions later than 4.2. The uncertainty of the frequency response is included in the stated uncertainty of ConvF.
- DCP_{x,y,z}:** DCP are numerical linearization parameters assessed based on the data of power sweep with CW signal (no uncertainty required). DCP does not depend on frequency nor media.
- PAR:** PAR is the Peak to Average Ratio that is not calibrated but determined based on the signal characteristics
- A_{x,y,z}; B_{x,y,z}; C_{x,y,z}; D_{x,y,z}; VR_{x,y,z}:** A, B, C, D are numerical linearization parameters assessed based on the data of power sweep for specific modulation signal. The parameters do not depend on frequency nor media. VR is the maximum calibration range expressed in RMS voltage across the diode.
- ConvF and Boundary Effect Parameters:** Assessed in flat phantom using E-field (or Temperature Transfer Standard for $f \leq 800$ MHz) and inside waveguide using analytical field distributions based on power measurements for $f > 800$ MHz. The same setups are used for assessment of the parameters applied for boundary compensation (alpha, depth) of which typical uncertainty values are given. These parameters are used in DASY4 software to improve probe accuracy close to the boundary. The sensitivity in TSL corresponds to NORM_{x,y,z} * ConvF whereby the uncertainty corresponds to that given for ConvF. A frequency dependent ConvF is used in DASY version 4.4 and higher which allows extending the validity from ± 50 MHz to ± 100 MHz.
- Spherical isotropy (3D deviation from isotropy):** in a field of low gradients realized using a flat phantom exposed by a patch antenna.
- Sensor Offset:** The sensor offset corresponds to the offset of virtual measurement center from the probe tip (on probe axis). No tolerance required.
- Connector Angle:** The angle is assessed using the information gained by determining the NORM_x (no uncertainty required).

Probe ES3DV3

SN:3258

Manufactured: January 25, 2010
Calibrated: February 25, 2014

Calibrated for DASY/EASY Systems
(Note: non-compatible with DASY2 system!)

DASY/EASY - Parameters of Probe: ES3DV3 - SN:3258

Basic Calibration Parameters

	Sensor X	Sensor Y	Sensor Z	Unc (k=2)
Norm ($\mu V/(V/m)^2$) ^A	1.29	1.19	1.23	± 10.1 %
DCP (mV) ^B	104.5	107.0	103.0	

Modulation Calibration Parameters

UID	Communication System Name		A dB	B dB√μV	C	D dB	VR mV	Unc ^E (k=2)
0	CW	X	0.0	0.0	1.0	0.00	222.4	±3.8 %
		Y	0.0	0.0	1.0		202.2	
		Z	0.0	0.0	1.0		207.1	
10010-CAA	SAR Validation (Square, 100ms, 10ms)	X	5.09	65.6	14.1	10.00	44.8	±1.9 %
		Y	1.68	57.4	9.3		40.7	
		Z	4.01	62.4	13.0		51.1	
10011-CAB	UMTS-FDD (WCDMA)	X	3.34	67.5	18.9	2.91	131.2	±0.5 %
		Y	3.43	67.9	18.7		137.1	
		Z	3.42	67.8	19.0		146.0	
10012-CAA	IEEE 802.11b WiFi 2.4 GHz (DSSS, 1 Mbps)	X	3.40	70.9	19.8	1.87	134.2	±0.7 %
		Y	3.19	70.2	19.2		137.9	
		Z	3.46	70.8	19.6		149.6	
10021-DAB	GSM-FDD (TDMA, GMSK)	X	30.24	99.7	28.7	9.39	131.2	±1.4 %
		Y	12.91	88.5	23.9		147.5	
		Z	30.37	99.5	28.9		128.0	
10023-DAB	GPRS-FDD (TDMA, GMSK, TN 0)	X	29.88	100.0	29.0	9.57	123.0	±1.9 %
		Y	16.02	92.5	25.4		140.7	
		Z	30.01	100.0	29.4		125.8	
10024-DAB	GPRS-FDD (TDMA, GMSK, TN 0-1)	X	44.57	99.7	25.9	6.56	119.6	±1.7 %
		Y	28.97	95.3	23.2		127.6	
		Z	43.72	99.8	26.3		120.1	
10027-DAB	GPRS-FDD (TDMA, GMSK, TN 0-1-2)	X	53.52	99.7	24.4	4.80	129.4	±2.2 %
		Y	54.55	99.9	22.9		143.3	
		Z	51.63	99.7	24.8		127.5	
10028-DAB	GPRS-FDD (TDMA, GMSK, TN 0-1-2-3)	X	58.93	99.8	23.4	3.55	133.4	±2.2 %
		Y	77.54	99.7	21.3		125.3	
		Z	56.64	99.8	23.8		130.8	
10032-CAA	IEEE 802.15.1 Bluetooth (GFSK, DH5)	X	47.03	99.5	21.3	1.16	136.3	±1.7 %
		Y	95.86	95.2	17.1		138.2	
		Z	39.68	100.0	22.2		132.3	
10039-CAB	CDMA2000 (1xRTT, RC1)	X	4.84	66.8	19.1	4.57	131.3	±0.9 %
		Y	4.75	67.0	18.9		135.2	
		Z	4.86	66.7	19.0		127.2	

10081-CAB	CDMA2000 (1xRTT, RC3)	X	4.06	66.8	19.0	3.97	148.4	±0.7 %
		Y	3.96	66.6	18.6		134.7	
		Z	4.13	66.9	19.1		143.4	
10098-CAB	UMTS-FDD (HSUPA, Subtest 2)	X	4.63	66.8	18.7	3.98	137.3	±0.7 %
		Y	4.75	67.5	18.8		148.4	
		Z	4.65	66.7	18.7		133.2	
10100-CAB	LTE-FDD (SC-FDMA, 100% RB, 20 MHz, QPSK)	X	6.66	68.5	20.3	5.67	144.0	±1.2 %
		Y	6.27	67.1	19.3		130.6	
		Z	6.62	68.2	20.1		140.5	
10108-CAB	LTE-FDD (SC-FDMA, 100% RB, 10 MHz, QPSK)	X	6.53	68.0	20.2	5.80	142.6	±1.4 %
		Y	6.17	66.8	19.3		129.2	
		Z	6.52	67.8	20.1		139.0	
10110-CAB	LTE-FDD (SC-FDMA, 100% RB, 5 MHz, QPSK)	X	6.19	67.3	19.9	5.75	137.9	±1.4 %
		Y	6.12	67.3	19.6		149.5	
		Z	6.19	67.1	19.8		136.1	
10114-CAA	IEEE 802.11n (HT Greenfield, 13.5 Mbps, BPSK)	X	10.49	69.5	21.7	8.10	132.4	±2.5 %
		Y	10.23	69.1	21.3		144.3	
		Z	10.45	69.3	21.6		129.5	
10117-CAA	IEEE 802.11n (HT Mixed, 13.5 Mbps, BPSK)	X	10.46	69.5	21.7	8.07	133.9	±2.5 %
		Y	10.26	69.2	21.3		147.4	
		Z	10.47	69.4	21.7		130.5	
10151-CAB	LTE-TDD (SC-FDMA, 50% RB, 20 MHz, QPSK)	X	11.61	77.4	26.8	9.28	118.8	±3.0 %
		Y	9.89	75.2	25.7		144.9	
		Z	12.01	77.8	26.9		119.6	
10154-CAB	LTE-FDD (SC-FDMA, 50% RB, 10 MHz, QPSK)	X	6.20	67.3	19.9	5.75	139.2	±1.2 %
		Y	5.86	66.2	19.0		128.5	
		Z	6.22	67.3	19.9		136.3	
10160-CAB	LTE-FDD (SC-FDMA, 50% RB, 15 MHz, QPSK)	X	6.63	67.8	20.1	5.82	144.1	±1.4 %
		Y	6.31	66.8	19.3		133.1	
		Z	6.66	67.7	20.0		140.9	
10169-CAB	LTE-FDD (SC-FDMA, 1 RB, 20 MHz, QPSK)	X	5.25	67.5	20.2	5.73	143.6	±1.2 %
		Y	4.92	66.7	19.5		131.0	
		Z	5.29	67.4	20.2		140.7	
10172-CAB	LTE-TDD (SC-FDMA, 1 RB, 20 MHz, QPSK)	X	13.49	87.5	31.6	9.21	139.0	±2.7 %
		Y	7.83	75.5	26.0		124.9	
		Z	13.47	86.5	31.1		137.8	
10175-CAB	LTE-FDD (SC-FDMA, 1 RB, 10 MHz, QPSK)	X	5.22	67.4	20.1	5.72	144.3	±1.4 %
		Y	5.08	67.5	19.9		147.9	
		Z	5.26	67.2	20.0		139.6	
10181-CAB	LTE-FDD (SC-FDMA, 1 RB, 15 MHz, QPSK)	X	5.24	67.5	20.1	5.72	144.5	±1.2 %
		Y	5.06	67.4	19.8		147.0	
		Z	5.29	67.3	20.1		139.2	

10193-CAA	IEEE 802.11n (HT Greenfield, 6.5 Mbps, BPSK)	X	10.12	69.1	21.6	8.09	128.8	±2.2 %
		Y	9.76	68.4	21.0		132.8	
		Z	10.08	68.9	21.5		123.4	
10196-CAA	IEEE 802.11n (HT Mixed, 6.5 Mbps, BPSK)	X	10.15	69.2	21.7	8.10	130.2	±2.2 %
		Y	9.77	68.5	21.0		134.1	
		Z	10.10	69.0	21.5		124.0	
10219-CAA	IEEE 802.11n (HT Mixed, 7.2 Mbps, BPSK)	X	10.02	69.0	21.5	8.03	128.7	±2.2 %
		Y	9.67	68.5	21.0		133.3	
		Z	10.02	68.9	21.5		123.9	
10222-CAA	IEEE 802.11n (HT Mixed, 15 Mbps, BPSK)	X	10.46	69.6	21.7	8.06	134.0	±2.2 %
		Y	10.09	68.8	21.1		139.7	
		Z	10.40	69.3	21.6		128.7	
10225-CAB	UMTS-FDD (HSPA+)	X	7.09	67.1	19.6	5.97	131.2	±1.4 %
		Y	6.98	67.2	19.4		138.0	
		Z	7.06	66.8	19.4		127.2	
10237-CAB	LTE-TDD (SC-FDMA, 1 RB, 10 MHz, QPSK)	X	13.63	87.8	31.7	9.21	141.6	±3.0 %
		Y	7.85	75.5	26.0		126.5	
		Z	13.99	87.7	31.6		141.4	
10252-CAB	LTE-TDD (SC-FDMA, 50% RB, 10 MHz, QPSK)	X	12.86	81.4	28.9	9.24	142.1	±3.0 %
		Y	8.91	73.4	24.8		129.9	
		Z	13.15	81.4	28.8		142.0	
10267-CAB	LTE-TDD (SC-FDMA, 100% RB, 10 MHz, QPSK)	X	11.63	77.5	26.8	9.30	118.7	±3.0 %
		Y	9.62	74.3	25.2		138.4	
		Z	11.96	77.7	26.9		119.3	
10274-CAB	UMTS-FDD (HSUPA, Subtest 5, 3GPP Rel8.10)	X	6.14	67.4	19.3	4.87	149.9	±0.9 %
		Y	5.90	66.9	18.7		132.8	
		Z	6.20	67.5	19.3		146.6	
10275-CAB	UMTS-FDD (HSUPA, Subtest 5, 3GPP Rel8.4)	X	4.45	66.9	18.9	3.96	130.1	±0.7 %
		Y	4.50	67.2	18.8		137.9	
		Z	4.64	67.6	19.3		149.2	
10291-AAB	CDMA2000, RC3, SO55, Full Rate	X	3.79	67.5	19.2	3.46	145.3	±0.7 %
		Y	3.74	67.5	18.9		128.2	
		Z	3.78	67.3	19.1		139.1	
10292-AAB	CDMA2000, RC3, SO32, Full Rate	X	3.77	67.8	19.3	3.39	147.0	±0.5 %
		Y	3.69	67.7	18.9		130.1	
		Z	3.73	67.3	19.0		141.3	
10297-AAA	LTE-FDD (SC-FDMA, 50% RB, 20 MHz, QPSK)	X	6.52	67.9	20.1	5.81	141.4	±1.4 %
		Y	6.41	67.6	19.7		147.4	
		Z	6.51	67.7	20.1		135.4	
10311-AAA	LTE-FDD (SC-FDMA, 100% RB, 15 MHz, QPSK)	X	7.17	68.7	20.7	6.06	147.7	±1.4 %
		Y	6.69	67.2	19.6		128.6	
		Z	7.12	68.4	20.5		142.0	

10315-AAA	IEEE 802.11b WiFi 2.4 GHz (DSSS, 1 Mbps, 96pc duty cycle)	X	3.04	70.0	19.6	1.71	129.8	±0.5 %
		Y	3.25	71.3	19.7		136.9	
		Z	3.09	69.9	19.5		148.7	
10403-AAB	CDMA2000 (1xEV-DO, Rev. 0)	X	4.73	67.3	18.6	3.76	135.7	±0.5 %
		Y	4.93	69.1	19.0		141.5	
		Z	4.73	67.1	18.4		132.7	
10404-AAB	CDMA2000 (1xEV-DO, Rev. A)	X	4.67	67.5	18.6	3.77	134.0	±0.5 %
		Y	4.92	69.4	19.1		139.8	
		Z	4.65	67.1	18.5		130.7	

The reported uncertainty of measurement is stated as the standard uncertainty of measurement multiplied by the coverage factor k=2, which for a normal distribution corresponds to a coverage probability of approximately 95%.

^A The uncertainties of NormX,Y,Z do not affect the E²-field uncertainty inside TSL (see Pages 8 and 9).
^B Numerical linearization parameter: uncertainty not required.
^E Uncertainty is determined using the max. deviation from linear response applying rectangular distribution and is expressed for the square of the field value.

DASY/EASY - Parameters of Probe: ES3DV3 - SN:3258

Calibration Parameter Determined in Head Tissue Simulating Media

f (MHz) ^C	Relative Permittivity ^F	Conductivity (S/m) ^F	ConvF X	ConvF Y	ConvF Z	Alpha ^G	Depth ^G (mm)	Unct. (k=2)
750	41.9	0.89	6.53	6.53	6.53	0.40	1.60	± 12.0 %
835	41.5	0.90	6.27	6.27	6.27	0.80	1.17	± 12.0 %
1750	40.1	1.37	5.19	5.19	5.19	0.80	1.10	± 12.0 %
1900	40.0	1.40	5.04	5.04	5.04	0.68	1.27	± 12.0 %
2450	39.2	1.80	4.52	4.52	4.52	0.78	1.23	± 12.0 %
2600	39.0	1.96	4.34	4.34	4.34	0.76	1.33	± 12.0 %

^C Frequency validity of ± 100 MHz only applies for DASY v4.4 and higher (see Page 2), else it is restricted to ± 50 MHz. The uncertainty is the RSS of the ConvF uncertainty at calibration frequency and the uncertainty for the indicated frequency band.

^F At frequencies below 3 GHz, the validity of tissue parameters (ϵ and σ) can be relaxed to ± 10% if liquid compensation formula is applied to measured SAR values. At frequencies above 3 GHz, the validity of tissue parameters (ϵ and σ) is restricted to ± 5%. The uncertainty is the RSS of the ConvF uncertainty for indicated target tissue parameters.

^G Alpha/Depth are determined during calibration. SPEAG warrants that the remaining deviation due to the boundary effect after compensation is always less than ± 1% for frequencies below 3 GHz and below ± 2% for frequencies between 3-6 GHz at any distance larger than half the probe tip diameter from the boundary.

DASY/EASY - Parameters of Probe: ES3DV3 - SN:3258

Calibration Parameter Determined in Body Tissue Simulating Media

f (MHz) ^c	Relative Permittivity ^F	Conductivity (S/m) ^F	ConvF X	ConvF Y	ConvF Z	Alpha ^G	Depth ^G (mm)	Unct. (k=2)
750	55.5	0.96	6.15	6.15	6.15	0.61	1.32	± 12.0 %
835	55.2	0.97	6.11	6.11	6.11	0.80	1.15	± 12.0 %
1750	53.4	1.49	4.83	4.83	4.83	0.47	1.74	± 12.0 %
1900	53.3	1.52	4.61	4.61	4.61	0.55	1.59	± 12.0 %
2450	52.7	1.95	4.14	4.14	4.14	0.80	1.11	± 12.0 %
2600	52.5	2.16	3.91	3.91	3.91	0.80	1.00	± 12.0 %

^c Frequency validity of ± 100 MHz only applies for DASY v4.4 and higher (see Page 2), else it is restricted to ± 50 MHz. The uncertainty is the RSS of the ConvF uncertainty at calibration frequency and the uncertainty for the indicated frequency band.

^F At frequencies below 3 GHz, the validity of tissue parameters (ϵ and σ) can be relaxed to ± 10% if liquid compensation formula is applied to measured SAR values. At frequencies above 3 GHz, the validity of tissue parameters (ϵ and σ) is restricted to ± 5%. The uncertainty is the RSS of the ConvF uncertainty for indicated target tissue parameters.

^G Alpha/Depth are determined during calibration. SPEAG warrants that the remaining deviation due to the boundary effect after compensation is always less than ± 1% for frequencies below 3 GHz and below ± 2% for frequencies between 3-6 GHz at any distance larger than half the probe tip diameter from the boundary.

Frequency Response of E-Field (TEM-Cell: ifi110 EXX, Waveguide: R22)

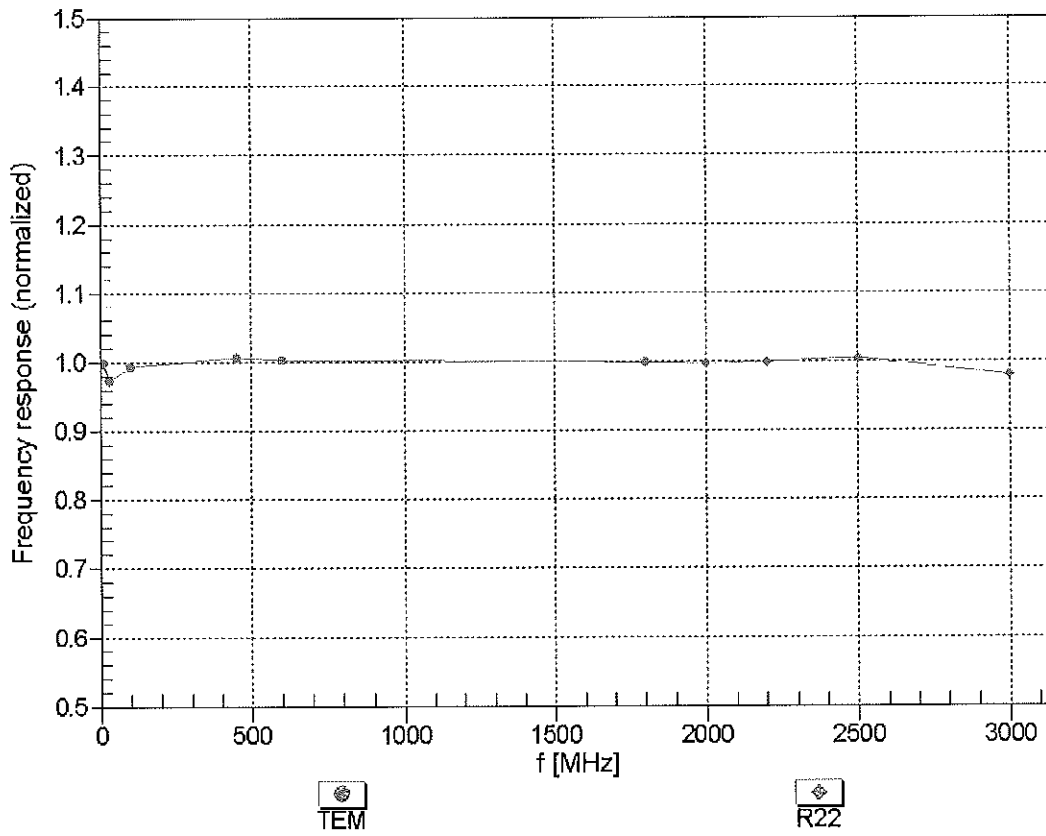

Uncertainty of Frequency Response of E-field: $\pm 6.3\%$ (k=2)

Receiving Pattern (ϕ), $\theta = 0^\circ$

f=600 MHz,TEM

f=1800 MHz,R22

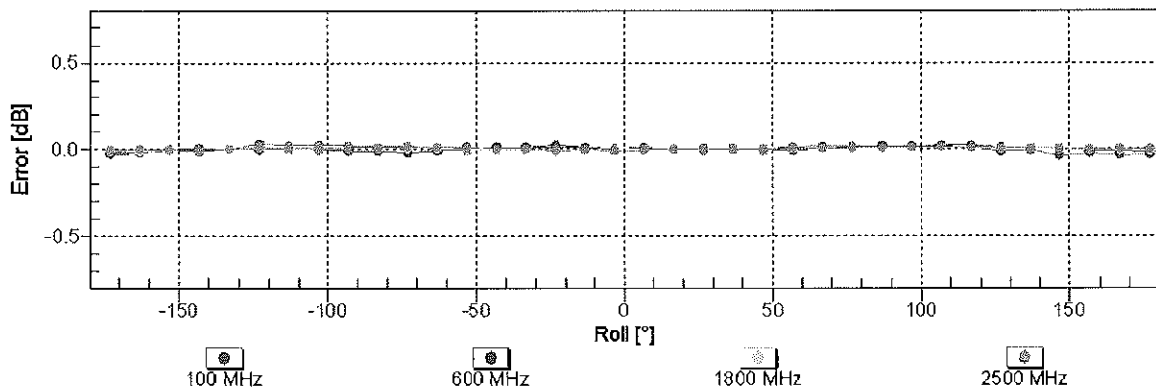
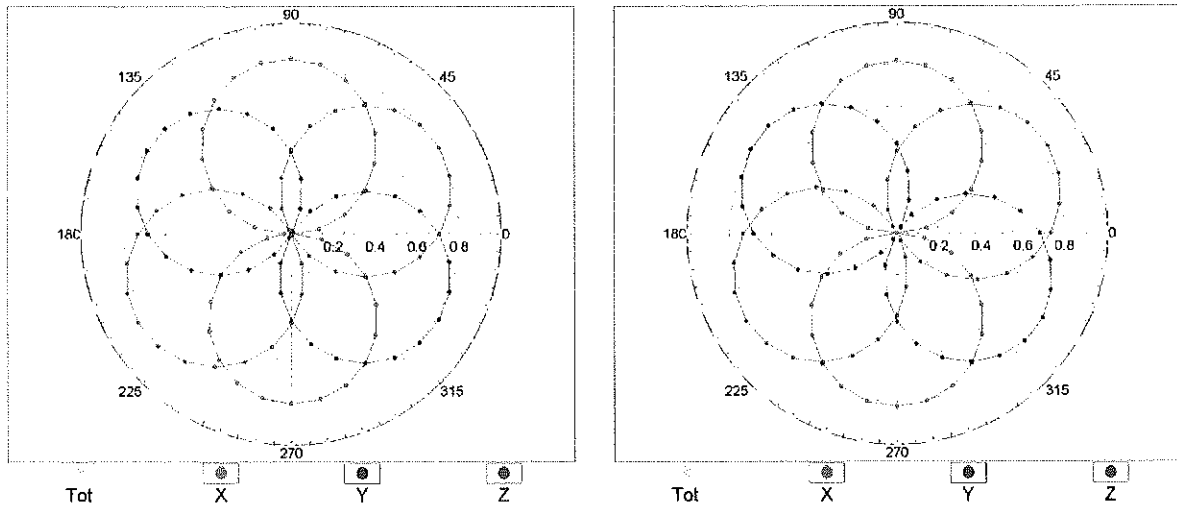

Uncertainty of Axial Isotropy Assessment: $\pm 0.5\%$ ($k=2$)

Dynamic Range f(SAR_{head}) (TEM cell , f_{eval}= 1900 MHz)

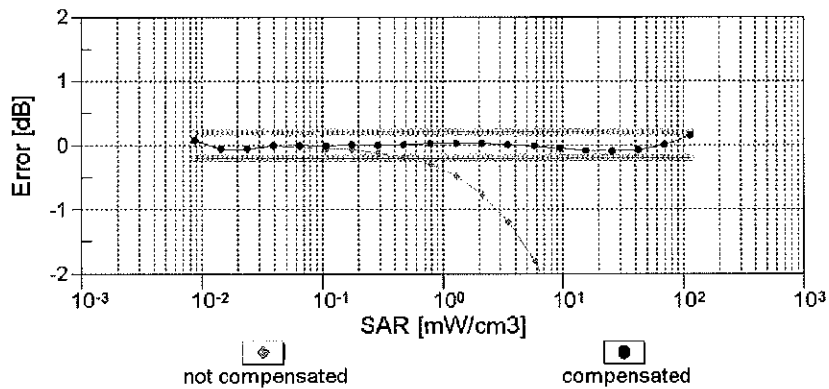
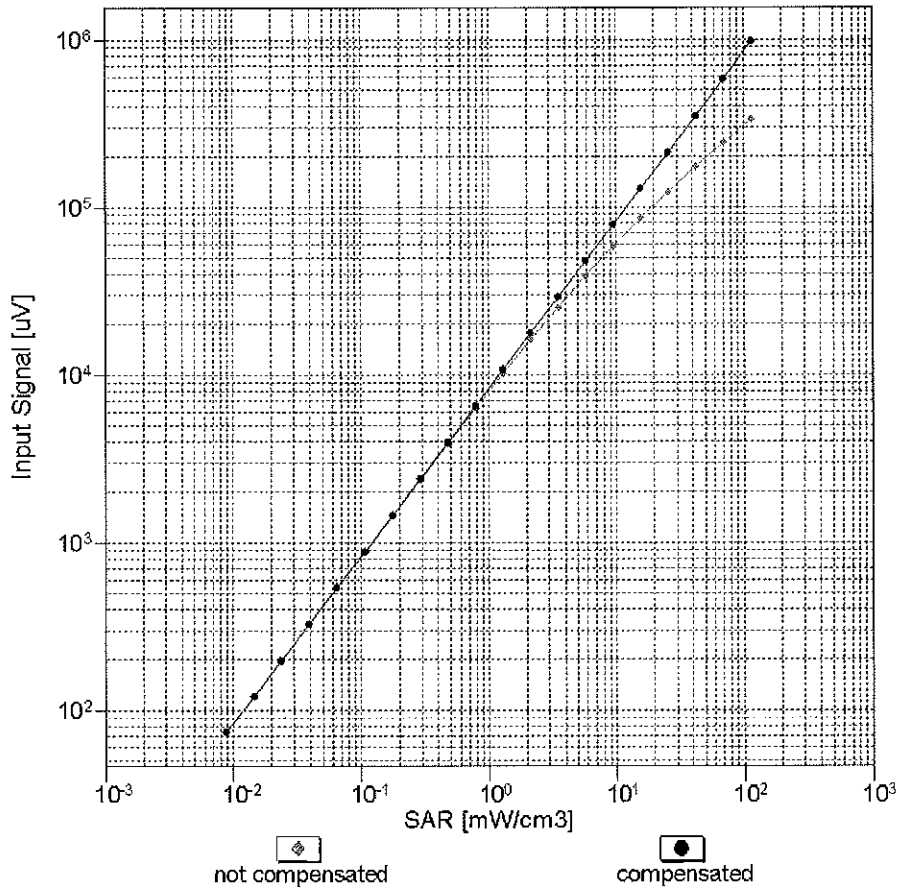

Uncertainty of Linearity Assessment: ± 0.6% (k=2)

Conversion Factor Assessment

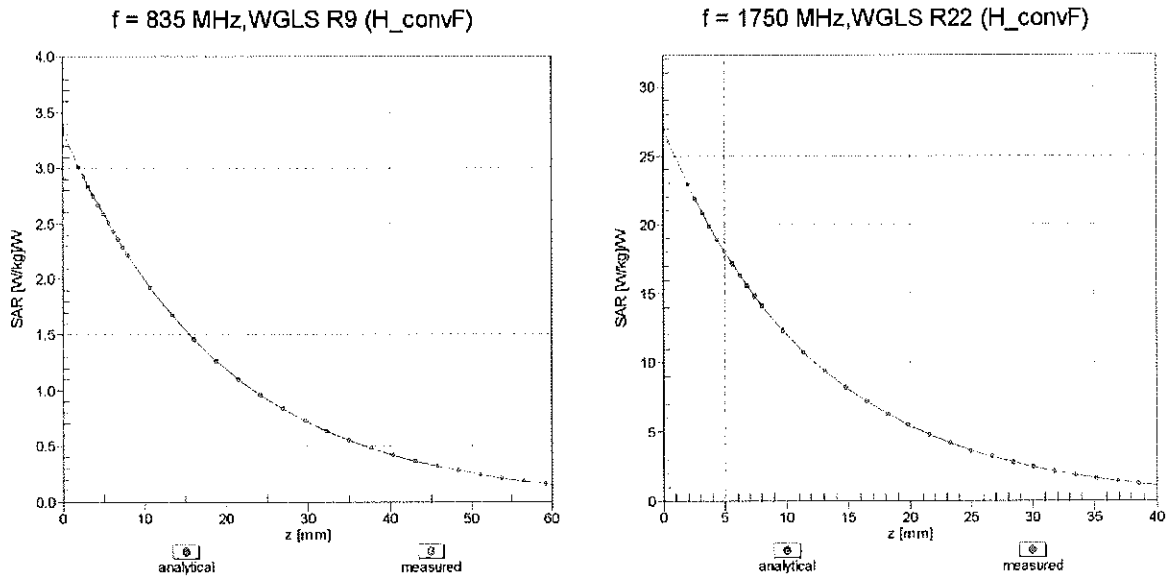

Deviation from Isotropy in Liquid Error (ϕ, ϑ), f = 900 MHz

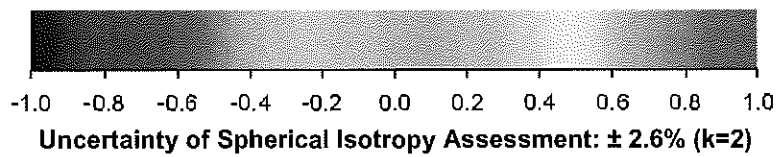
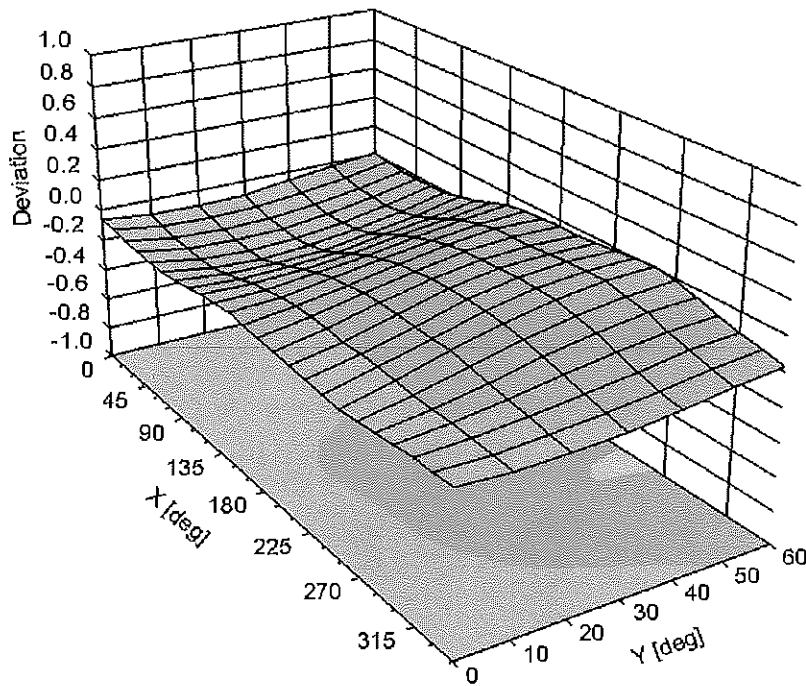

DASY/EASY - Parameters of Probe: ES3DV3 - SN:3258

Other Probe Parameters

Sensor Arrangement	Triangular
Connector Angle (°)	-123.1
Mechanical Surface Detection Mode	enabled
Optical Surface Detection Mode	disabled
Probe Overall Length	337 mm
Probe Body Diameter	10 mm
Tip Length	10 mm
Tip Diameter	4 mm
Probe Tip to Sensor X Calibration Point	2 mm
Probe Tip to Sensor Y Calibration Point	2 mm
Probe Tip to Sensor Z Calibration Point	2 mm
Recommended Measurement Distance from Surface	3 mm



Accredited by the Swiss Accreditation Service (SAS)
The Swiss Accreditation Service is one of the signatories to the EA
Multilateral Agreement for the recognition of calibration certificates

Accreditation No.: **SCS 108**

Client **PC Test**

Certificate No: **EX3-3589_Jan14**

CALIBRATION CERTIFICATE

Object **EX3DV4 - SN:3589**

Calibration procedure(s) **QA CAL-01.v9, QA CAL-14.v4, QA CAL-23.v5, QA CAL-25.v6
Calibration procedure for dosimetric E-field probes**

Calibration date: **January 29, 2014**

This calibration certificate documents the traceability to national standards, which realize the physical units of measurements (SI).
The measurements and the uncertainties with confidence probability are given on the following pages and are part of the certificate.

All calibrations have been conducted in the closed laboratory facility: environment temperature (22 ± 3)°C and humidity < 70%.

Calibration Equipment used (M&TE critical for calibration)

CC ✓
25/14

Primary Standards	ID	Cal Date (Certificate No.)	Scheduled Calibration
Power meter E4419B	GB41293874	04-Apr-13 (No. 217-01733)	Apr-14
Power sensor E4412A	MY41498087	04-Apr-13 (No. 217-01733)	Apr-14
Reference 3 dB Attenuator	SN: S5054 (3c)	04-Apr-13 (No. 217-01737)	Apr-14
Reference 20 dB Attenuator	SN: S5277 (20x)	04-Apr-13 (No. 217-01735)	Apr-14
Reference 30 dB Attenuator	SN: S5129 (30b)	04-Apr-13 (No. 217-01738)	Apr-14
Reference Probe ES3DV2	SN: 3013	30-Dec-13 (No. ES3-3013_Dec13)	Dec-14
DAE4	SN: 660	13-Dec-13 (No. DAE4-660_Dec13)	Dec-14
Secondary Standards	ID	Check Date (in house)	Scheduled Check
RF generator HP 8648C	US3642U01700	4-Aug-99 (in house check Apr-13)	In house check: Apr-16
Network Analyzer HP 8753E	US37390585	18-Oct-01 (in house check Oct-13)	In house check: Oct-14

Calibrated by:	Name Claudio Leubler	Function Laboratory Technician	Signature
Approved by:	Name Katja Pokovic	Function Technical Manager	Signature
			Issued: January 30, 2014

This calibration certificate shall not be reproduced except in full without written approval of the laboratory.

PC-T-783



Accredited by the Swiss Accreditation Service (SAS)
The Swiss Accreditation Service is one of the signatories to the EA
Multilateral Agreement for the recognition of calibration certificates

Accreditation No.: **SCS 108**

Glossary:

TSL	tissue simulating liquid
NORM _{x,y,z}	sensitivity in free space
ConvF	sensitivity in TSL / NORM _{x,y,z}
DCP	diode compression point
CF	crest factor (1/duty_cycle) of the RF signal
A, B, C, D	modulation dependent linearization parameters
Polarization φ	φ rotation around probe axis
Polarization ϑ	ϑ rotation around an axis that is in the plane normal to probe axis (at measurement center), i.e., $\vartheta = 0$ is normal to probe axis
Connector Angle	information used in DASY system to align probe sensor X to the robot coordinate system

Calibration is Performed According to the Following Standards:

- a) IEEE Std 1528-2013, "IEEE Recommended Practice for Determining the Peak Spatial-Averaged Specific Absorption Rate (SAR) in the Human Head from Wireless Communications Devices: Measurement Techniques", June 2013
- b) IEC 62209-1, "Procedure to measure the Specific Absorption Rate (SAR) for hand-held devices used in close proximity to the ear (frequency range of 300 MHz to 3 GHz)", February 2005

Methods Applied and Interpretation of Parameters:

- **NORM_{x,y,z}**: Assessed for E-field polarization $\vartheta = 0$ ($f \leq 900$ MHz in TEM-cell; $f > 1800$ MHz: R22 waveguide). NORM_{x,y,z} are only intermediate values, i.e., the uncertainties of NORM_{x,y,z} does not affect the E²-field uncertainty inside TSL (see below ConvF).
- **NORM(f)_{x,y,z}** = NORM_{x,y,z} * frequency_response (see Frequency Response Chart). This linearization is implemented in DASY4 software versions later than 4.2. The uncertainty of the frequency response is included in the stated uncertainty of ConvF.
- **DCP_{x,y,z}**: DCP are numerical linearization parameters assessed based on the data of power sweep with CW signal (no uncertainty required). DCP does not depend on frequency nor media.
- **PAR**: PAR is the Peak to Average Ratio that is not calibrated but determined based on the signal characteristics
- **A_{x,y,z}; B_{x,y,z}; C_{x,y,z}; D_{x,y,z}; VR_{x,y,z}**: A, B, C, D are numerical linearization parameters assessed based on the data of power sweep for specific modulation signal. The parameters do not depend on frequency nor media. VR is the maximum calibration range expressed in RMS voltage across the diode.
- **ConvF and Boundary Effect Parameters**: Assessed in flat phantom using E-field (or Temperature Transfer Standard for $f \leq 800$ MHz) and inside waveguide using analytical field distributions based on power measurements for $f > 800$ MHz. The same setups are used for assessment of the parameters applied for boundary compensation (alpha, depth) of which typical uncertainty values are given. These parameters are used in DASY4 software to improve probe accuracy close to the boundary. The sensitivity in TSL corresponds to NORM_{x,y,z} * ConvF whereby the uncertainty corresponds to that given for ConvF. A frequency dependent ConvF is used in DASY version 4.4 and higher which allows extending the validity from ± 50 MHz to ± 100 MHz.
- **Spherical isotropy (3D deviation from isotropy)**: in a field of low gradients realized using a flat phantom exposed by a patch antenna.
- **Sensor Offset**: The sensor offset corresponds to the offset of virtual measurement center from the probe tip (on probe axis). No tolerance required.
- **Connector Angle**: The angle is assessed using the information gained by determining the NORM_x (no uncertainty required).

Probe EX3DV4

SN:3589

Manufactured: March 30, 2006
Calibrated: January 29, 2014

Calibrated for DASY/EASY Systems
(Note: non-compatible with DASY2 system!)

DASY/EASY - Parameters of Probe: EX3DV4 - SN:3589

Basic Calibration Parameters

	Sensor X	Sensor Y	Sensor Z	Unc (k=2)
Norm ($\mu V/(V/m)^2$) ^A	0.46	0.40	0.40	± 10.1 %
DCP (mV) ^B	101.2	100.8	98.0	

Modulation Calibration Parameters

UID	Communication System Name		A dB	B dB $\sqrt{\mu V}$	C	D dB	VR mV	Unc ^E (k=2)
0	CW	X	0.0	0.0	1.0	0.00	150.4	±3.8 %
		Y	0.0	0.0	1.0		142.3	
		Z	0.0	0.0	1.0		171.7	
10010- CAA	SAR Validation (Square, 100ms, 10ms)	X	6.00	69.5	14.2	10.00	42.1	±0.9 %
		Y	7.03	71.8	15.0		40.3	
		Z	3.33	64.6	12.1		44.6	
10011- CAA	UMTS-FDD (WCDMA)	X	3.26	66.2	17.8	2.91	117.6	±0.9 %
		Y	3.38	66.8	18.2		113.0	
		Z	2.79	62.4	14.7		133.2	
10012- CAA	IEEE 802.11b WiFi 2.4 GHz (DSSS, 1 Mbps)	X	2.77	66.8	17.4	1.87	117.4	±0.7 %
		Y	3.22	69.6	18.8		113.5	
		Z	2.22	62.0	13.8		135.2	
10021- DAA	GSM-FDD (TDMA, GMSK)	X	3.61	69.7	16.6	9.39	91.2	±1.7 %
		Y	5.48	77.1	19.6		125.1	
		Z	2.18	62.5	12.6		75.3	
10023- DAA	GPRS-FDD (TDMA, GMSK, TN 0)	X	3.01	66.4	14.9	9.57	86.1	±2.7 %
		Y	7.02	82.0	22.0		120.5	
		Z	2.13	62.9	12.7		71.4	
10024- DAA	GPRS-FDD (TDMA, GMSK, TN 0-1)	X	18.01	91.8	22.6	6.56	132.3	±1.7 %
		Y	8.55	83.0	19.9		134.3	
		Z	4.04	72.4	15.7		139.6	
10027- DAA	GPRS-FDD (TDMA, GMSK, TN 0-1-2)	X	4.70	74.7	15.9	4.80	107.5	±1.7 %
		Y	4.94	76.1	16.4		107.8	
		Z	2.97	68.7	12.8		127.1	
10028- DAA	GPRS-FDD (TDMA, GMSK, TN 0-1-2-3)	X	67.89	99.9	21.4	3.55	114.7	±2.7 %
		Y	48.02	99.7	21.9		116.6	
		Z	1.36	61.4	7.8		134.4	
10032- CAA	IEEE 802.15.1 Bluetooth (GFSK, DH5)	X	97.41	97.0	17.7	1.16	129.2	±3.0 %
		Y	71.47	99.8	19.3		130.9	
		Z	0.29	53.5	0.9		109.2	
10039- CAA	CDMA2000 (1xRTT, RC1)	X	4.62	65.4	18.0	4.57	113.0	±1.7 %
		Y	4.74	66.1	18.4		111.5	
		Z	4.22	63.3	15.9		133.6	
10062- CAA	IEEE 802.11a/h WiFi 5 GHz (OFDM, 6 Mbps)	X	10.10	67.8	20.8	8.68	108.0	±2.7 %
		Y	10.07	68.1	21.1		108.1	
		Z	10.03	67.6	20.2		130.3	

10098-CAA	UMTS-FDD (HSUPA, Subtest 2)	X	4.53	65.7	17.8	3.98	122.5	±0.9 %
		Y	4.72	66.6	18.4		123.1	
		Z	4.38	64.5	16.7		147.3	
10100-CAB	LTE-FDD (SC-FDMA, 100% RB, 20 MHz, QPSK)	X	6.32	66.5	18.8	5.67	126.9	±1.2 %
		Y	6.50	67.2	19.4		128.9	
		Z	5.80	64.3	17.3		107.2	
10108-CAB	LTE-FDD (SC-FDMA, 100% RB, 10 MHz, QPSK)	X	6.22	66.1	18.8	5.80	124.2	±1.7 %
		Y	6.39	66.9	19.4		126.7	
		Z	6.10	65.2	17.7		149.4	
10110-CAB	LTE-FDD (SC-FDMA, 100% RB, 5 MHz, QPSK)	X	5.94	65.8	18.7	5.75	121.3	±1.7 %
		Y	6.05	66.3	19.1		123.1	
		Z	5.80	65.0	17.7		144.5	
10114-CAA	IEEE 802.11n (HT Greenfield, 13.5 Mbps, BPSK)	X	10.01	67.7	20.3	8.10	113.9	±2.5 %
		Y	10.16	68.3	20.8		117.0	
		Z	9.96	67.5	19.8		135.3	
10117-CAA	IEEE 802.11n (HT Mixed, 13.5 Mbps, BPSK)	X	10.07	67.9	20.4	8.07	115.2	±2.5 %
		Y	10.16	68.2	20.7		118.4	
		Z	10.02	67.7	19.9		138.0	
10151-CAB	LTE-TDD (SC-FDMA, 50% RB, 20 MHz, QPSK)	X	7.89	68.4	21.8	9.28	108.1	±1.9 %
		Y	8.15	69.7	22.8		109.4	
		Z	7.38	66.5	20.4		123.2	
10154-CAB	LTE-FDD (SC-FDMA, 50% RB, 10 MHz, QPSK)	X	5.94	65.7	18.6	5.75	122.1	±1.7 %
		Y	6.03	66.3	19.0		122.5	
		Z	5.79	65.0	17.7		144.0	
10160-CAB	LTE-FDD (SC-FDMA, 50% RB, 15 MHz, QPSK)	X	6.38	66.3	18.9	5.82	126.0	±1.7 %
		Y	6.54	67.0	19.4		128.2	
		Z	6.16	65.3	17.8		146.9	
10169-CAB	LTE-FDD (SC-FDMA, 1 RB, 20 MHz, QPSK)	X	5.17	66.5	19.2	5.73	149.7	±1.2 %
		Y	4.95	65.8	19.0		108.3	
		Z	4.64	63.9	17.1		125.3	
10172-CAB	LTE-TDD (SC-FDMA, 1 RB, 20 MHz, QPSK)	X	6.79	70.4	23.0	9.21	120.6	±3.0 %
		Y	6.96	72.0	24.2		122.8	
		Z	6.43	69.3	22.0		136.7	
10175-CAB	LTE-FDD (SC-FDMA, 1 RB, 10 MHz, QPSK)	X	5.15	66.4	19.1	5.72	143.0	±1.4 %
		Y	5.23	67.1	19.6		145.8	
		Z	4.60	63.7	17.0		121.1	
10181-CAB	LTE-FDD (SC-FDMA, 1 RB, 15 MHz, QPSK)	X	5.11	66.2	19.0	5.72	141.0	±1.4 %
		Y	5.27	67.3	19.7		144.9	
		Z	4.54	63.4	16.8		119.2	
10193-CAA	IEEE 802.11n (HT Greenfield, 6.5 Mbps, BPSK)	X	9.57	67.1	20.1	8.09	102.2	±2.2 %
		Y	9.59	67.4	20.4		105.3	
		Z	9.73	67.6	20.0		129.6	
10196-CAA	IEEE 802.11n (HT Mixed, 6.5 Mbps, BPSK)	X	9.61	67.3	20.2	8.10	104.6	±2.5 %
		Y	9.63	67.6	20.5		107.8	
		Z	9.63	67.3	19.8		130.9	

10219-CAA	IEEE 802.11n (HT Mixed, 7.2 Mbps, BPSK)	X	9.61	67.5	20.3	8.03	109.2	±2.7 %
		Y	9.54	67.5	20.4		107.4	
		Z	9.53	67.2	19.7		130.7	
10222-CAA	IEEE 802.11n (HT Mixed, 15 Mbps, BPSK)	X	10.00	67.8	20.4	8.06	114.1	±2.7 %
		Y	10.01	68.0	20.6		112.3	
		Z	9.96	67.6	19.9		137.1	
10225-CAA	UMTS-FDD (HSPA+)	X	7.18	66.9	19.2	5.97	137.5	±1.4 %
		Y	7.25	67.4	19.5		134.4	
		Z	6.48	64.4	17.3		114.6	
10237-CAB	LTE-TDD (SC-FDMA, 1 RB, 10 MHz, QPSK)	X	6.93	71.0	23.5	9.21	123.5	±3.0 %
		Y	6.88	71.6	24.0		119.3	
		Z	6.63	70.1	22.4		141.3	
10252-CAB	LTE-TDD (SC-FDMA, 50% RB, 10 MHz, QPSK)	X	8.19	70.5	23.1	9.24	142.9	±2.5 %
		Y	8.46	72.0	24.2		143.3	
		Z	7.10	67.0	20.8		119.9	
10267-CAB	LTE-TDD (SC-FDMA, 100% RB, 10 MHz, QPSK)	X	7.83	68.1	21.6	9.30	104.2	±2.2 %
		Y	8.07	69.4	22.7		103.0	
		Z	7.49	67.2	20.9		125.2	
10274-CAA	UMTS-FDD (HSUPA, Subtest 5, 3GPP Rel8.10)	X	5.96	66.2	18.3	4.87	128.1	±1.7 %
		Y	6.12	67.0	18.8		126.0	
		Z	5.31	63.8	16.4		110.2	
10275-CAA	UMTS-FDD (HSUPA, Subtest 5, 3GPP Rel8.4)	X	4.30	65.5	17.8	3.96	110.5	±1.2 %
		Y	4.47	66.4	18.4		110.3	
		Z	3.92	63.1	15.6		135.7	
10291-AAA	CDMA2000, RC3, SO55, Full Rate	X	3.59	65.7	17.7	3.46	138.1	±1.2 %
		Y	3.85	67.2	18.6		146.7	
		Z	3.08	61.7	14.7		123.3	
10292-AAA	CDMA2000, RC3, SO32, Full Rate	X	3.59	66.0	17.8	3.39	144.2	±0.9 %
		Y	3.83	67.5	18.7		148.4	
		Z	3.18	63.1	15.7		128.6	
10297-AAA	LTE-FDD (SC-FDMA, 50% RB, 20 MHz, QPSK)	X	6.13	65.8	18.7	5.81	116.5	±1.7 %
		Y	6.30	66.6	19.2		119.4	
		Z	6.20	65.9	18.4		145.6	
10311-AAA	LTE-FDD (SC-FDMA, 100% RB, 15 MHz, QPSK)	X	6.70	66.4	19.0	6.06	122.5	±1.4 %
		Y	6.92	67.3	19.6		124.5	
		Z	6.28	65.0	17.9		103.7	
10315-AAA	IEEE 802.11b WiFi 2.4 GHz (DSSS, 1 Mbps, 96pc duty cycle)	X	2.66	66.7	17.4	1.71	109.5	±0.7 %
		Y	3.18	70.0	19.2		111.5	
		Z	2.08	61.6	13.4		134.4	
10317-AAA	IEEE 802.11a WiFi 5 GHz (OFDM, 6 Mbps, 96pc duty cycle)	X	9.78	67.4	20.4	8.36	103.5	±2.5 %
		Y	9.81	67.7	20.7		107.1	
		Z	9.86	67.6	20.3		129.5	
10400-AAA	IEEE 802.11ac WiFi (20MHz, 64-QAM, 99pc duty cycle)	X	9.86	67.5	20.4	8.37	104.9	±2.7 %
		Y	9.93	67.9	20.8		107.9	
		Z	9.97	67.7	20.2		134.3	

10402-AAA	IEEE 802.11ac WiFi (80MHz, 64-QAM, 99pc duty cycle)	X	10.47	67.9	20.5	8.53	109.9	±3.0 %
		Y	10.86	68.8	21.1		116.0	
		Z	10.68	68.2	20.4		142.5	
10403-AAA	CDMA2000 (1xEV-DO, Rev. 0)	X	4.74	67.0	17.9	3.76	114.9	±0.9 %
		Y	5.02	68.5	18.7		116.6	
		Z	4.23	64.4	15.8		145.1	
10404-AAA	CDMA2000 (1xEV-DO, Rev. A)	X	4.71	67.1	17.9	3.77	112.3	±1.4 %
		Y	4.95	68.5	18.7		115.0	
		Z	4.01	63.4	15.1		138.9	

The reported uncertainty of measurement is stated as the standard uncertainty of measurement multiplied by the coverage factor $k=2$, which for a normal distribution corresponds to a coverage probability of approximately 95%.

^A The uncertainties of NormX,Y,Z do not affect the E^2 -field uncertainty inside TSL (see Pages 8 and 9).

^B Numerical linearization parameter: uncertainty not required.

^E Uncertainty is determined using the max. deviation from linear response applying rectangular distribution and is expressed for the square of the field value.

DASY/EASY - Parameters of Probe: EX3DV4 - SN:3589

Calibration Parameter Determined in Head Tissue Simulating Media

f (MHz) ^C	Relative Permittivity ^F	Conductivity (S/m) ^F	ConvF X	ConvF Y	ConvF Z	Alpha ^G	Depth ^G (mm)	Unct. (k=2)
750	41.9	0.89	8.86	8.86	8.86	0.80	0.62	± 12.0 %
835	41.5	0.90	8.49	8.49	8.49	0.45	0.82	± 12.0 %
1750	40.1	1.37	7.31	7.31	7.31	0.80	0.60	± 12.0 %
1900	40.0	1.40	7.05	7.05	7.05	0.52	0.73	± 12.0 %
2450	39.2	1.80	6.45	6.45	6.45	0.29	1.08	± 12.0 %
2600	39.0	1.96	6.24	6.24	6.24	0.76	0.62	± 12.0 %
5200	36.0	4.66	4.78	4.78	4.78	0.30	1.80	± 13.1 %
5300	35.9	4.76	4.58	4.58	4.58	0.30	1.80	± 13.1 %
5500	35.6	4.96	4.44	4.44	4.44	0.31	1.80	± 13.1 %
5600	35.5	5.07	4.20	4.20	4.20	0.35	1.80	± 13.1 %
5800	35.3	5.27	4.39	4.39	4.39	0.32	1.80	± 13.1 %

^C Frequency validity of ± 100 MHz only applies for DASY v4.4 and higher (see Page 2), else it is restricted to ± 50 MHz. The uncertainty is the RSS of the ConvF uncertainty at calibration frequency and the uncertainty for the indicated frequency band.

^F At frequencies below 3 GHz, the validity of tissue parameters (ϵ and σ) can be relaxed to ± 10% if liquid compensation formula is applied to measured SAR values. At frequencies above 3 GHz, the validity of tissue parameters (ϵ and σ) is restricted to ± 5%. The uncertainty is the RSS of the ConvF uncertainty for indicated target tissue parameters.

^G Alpha/Depth are determined during calibration. SPEAG warrants that the remaining deviation due to the boundary effect after compensation is always less than ± 1% for frequencies below 3 GHz and below ± 2% for frequencies between 3-6 GHz at any distance larger than half the probe tip diameter from the boundary.

DASY/EASY - Parameters of Probe: EX3DV4 - SN:3589

Calibration Parameter Determined in Body Tissue Simulating Media

f (MHz) ^C	Relative Permittivity ^F	Conductivity (S/m) ^F	ConvF X	ConvF Y	ConvF Z	Alpha ^G	Depth (mm) ^G	Unct. (k=2)
750	55.5	0.96	8.34	8.34	8.34	0.66	0.72	± 12.0 %
835	55.2	0.97	8.29	8.29	8.29	0.31	1.11	± 12.0 %
1750	53.4	1.49	6.68	6.68	6.68	0.80	0.61	± 12.0 %
1900	53.3	1.52	6.54	6.54	6.54	0.72	0.64	± 12.0 %
2450	52.7	1.95	6.26	6.26	6.26	0.80	0.57	± 12.0 %
2600	52.5	2.16	6.08	6.08	6.08	0.68	0.50	± 12.0 %
5200	49.0	5.30	4.19	4.19	4.19	0.38	1.90	± 13.1 %
5300	48.9	5.42	3.98	3.98	3.98	0.38	1.90	± 13.1 %
5500	48.6	5.65	3.76	3.76	3.76	0.42	1.90	± 13.1 %
5600	48.5	5.77	3.81	3.81	3.81	0.30	1.90	± 13.1 %
5800	48.2	6.00	3.97	3.97	3.97	0.43	1.90	± 13.1 %

^C Frequency validity of ± 100 MHz only applies for DASY v4.4 and higher (see Page 2), else it is restricted to ± 50 MHz. The uncertainty is the RSS of the ConvF uncertainty at calibration frequency and the uncertainty for the indicated frequency band.

^F At frequencies below 3 GHz, the validity of tissue parameters (ϵ and σ) can be relaxed to ± 10% if liquid compensation formula is applied to measured SAR values. At frequencies above 3 GHz, the validity of tissue parameters (ϵ and σ) is restricted to ± 5%. The uncertainty is the RSS of the ConvF uncertainty for indicated target tissue parameters.

^G Alpha/Depth are determined during calibration. SPEAG warrants that the remaining deviation due to the boundary effect after compensation is always less than ± 1% for frequencies below 3 GHz and below ± 2% for frequencies between 3-6 GHz at any distance larger than half the probe tip diameter from the boundary.

Frequency Response of E-Field (TEM-Cell:ifi110 EXX, Waveguide: R22)

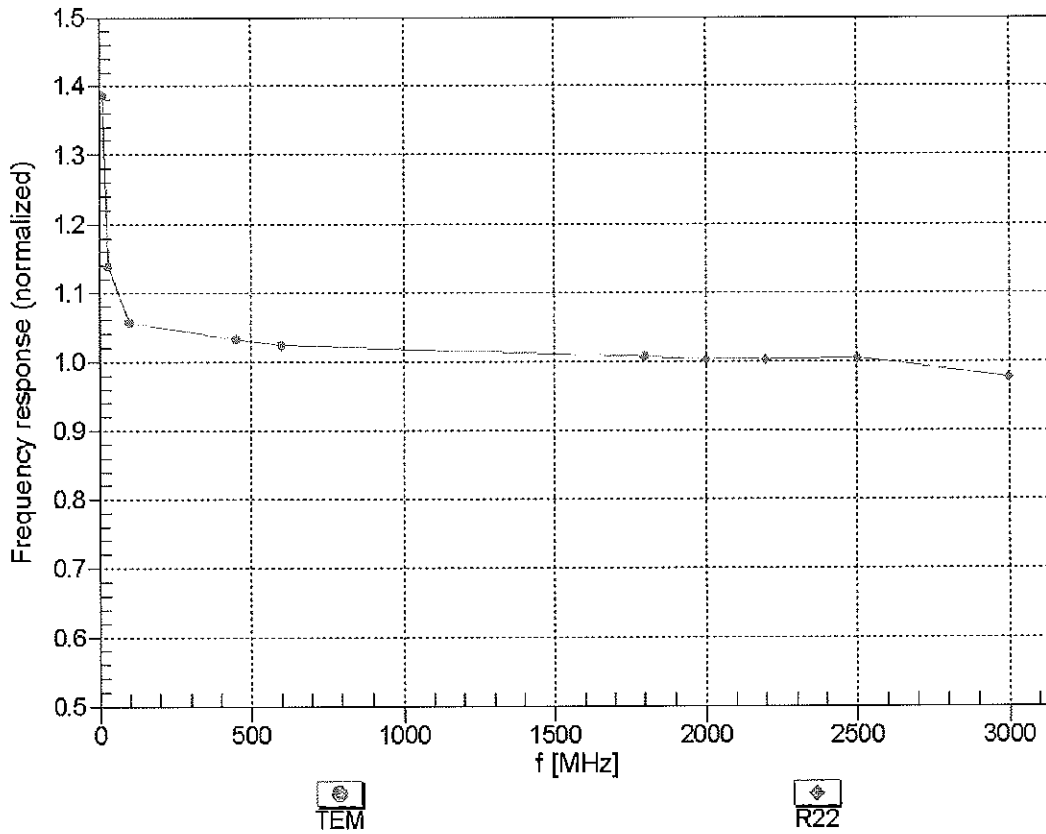

Uncertainty of Frequency Response of E-field: $\pm 6.3\%$ (k=2)

Receiving Pattern (ϕ), $\vartheta = 0^\circ$

f=600 MHz, TEM

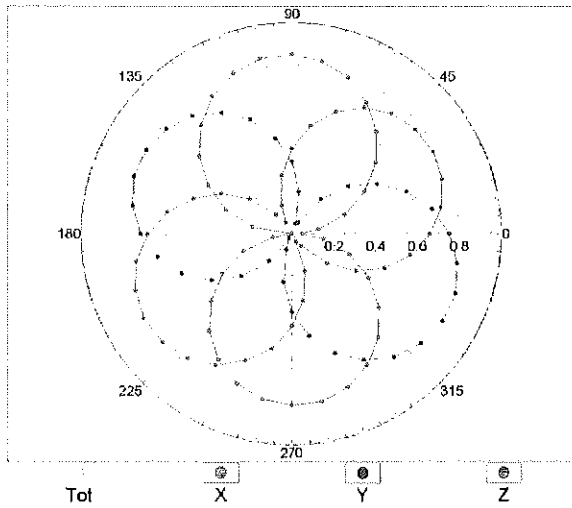

f=1800 MHz, R22

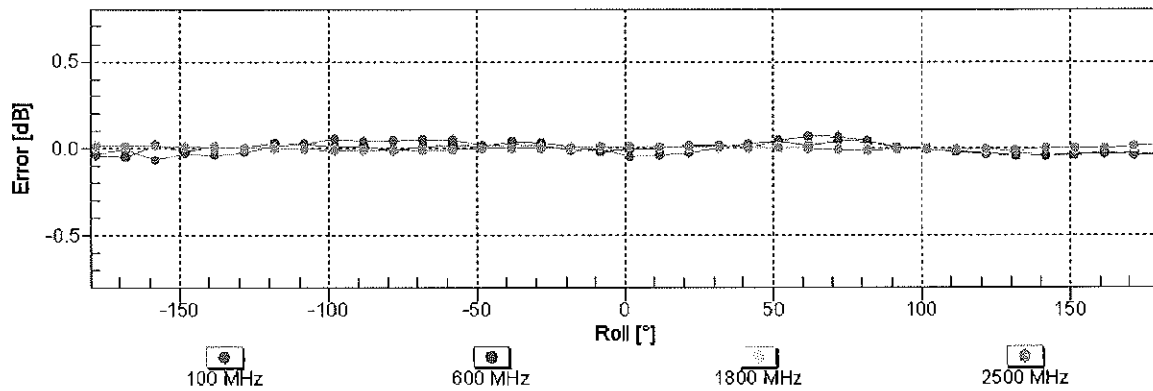
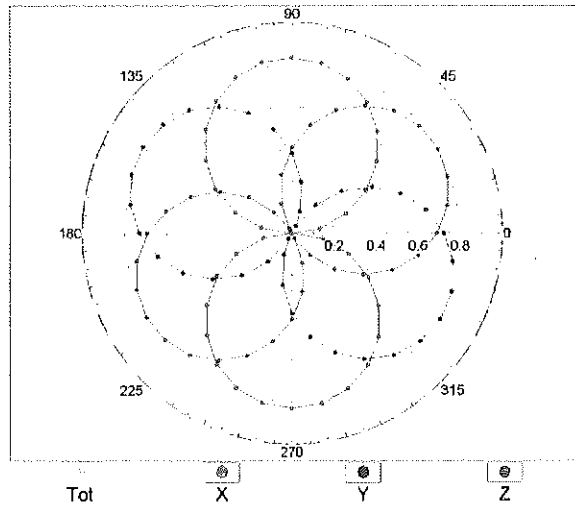

Uncertainty of Axial Isotropy Assessment: $\pm 0.5\%$ (k=2)

Dynamic Range $f(\text{SAR}_{\text{head}})$ (TEM cell , $f = 900 \text{ MHz}$)

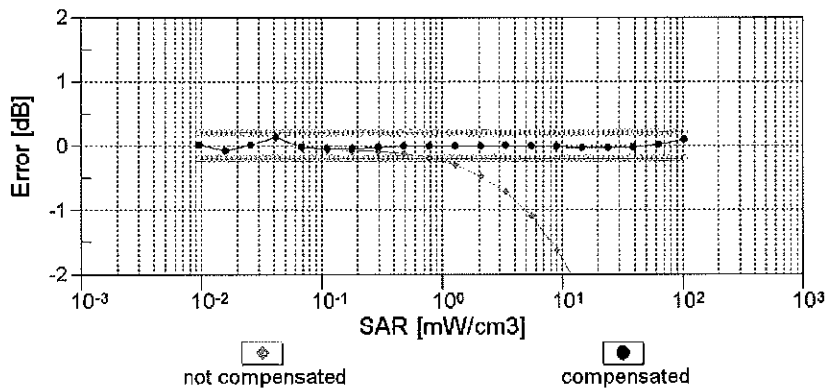
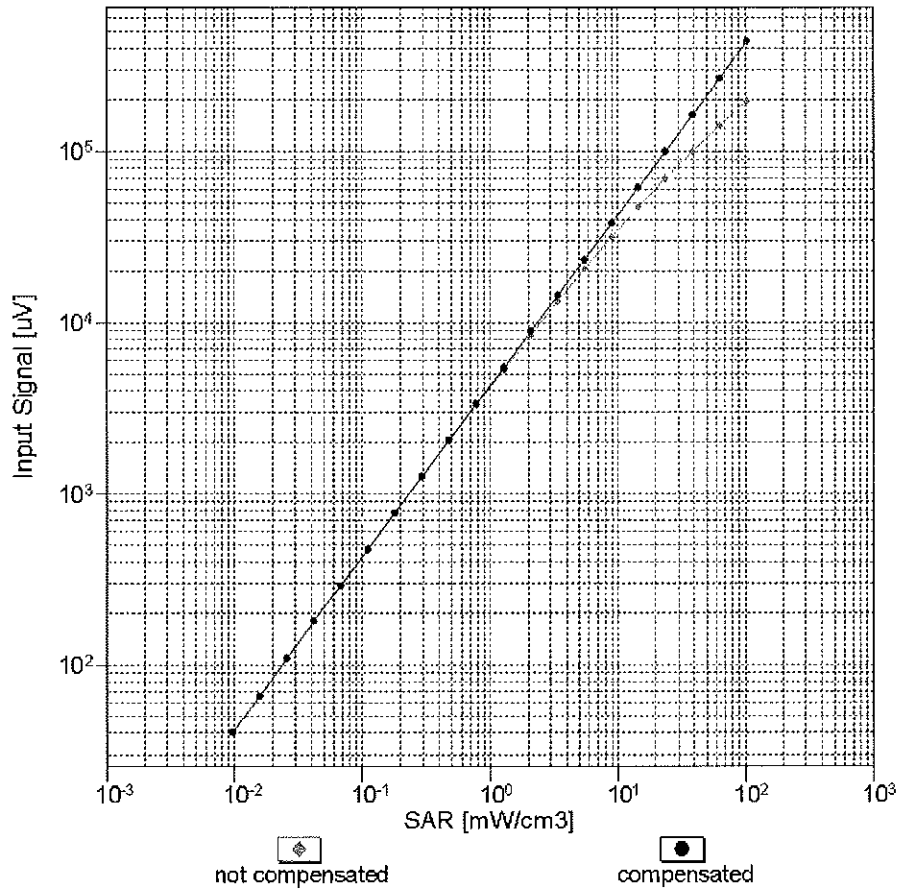

Uncertainty of Linearity Assessment: $\pm 0.6\%$ ($k=2$)

Conversion Factor Assessment

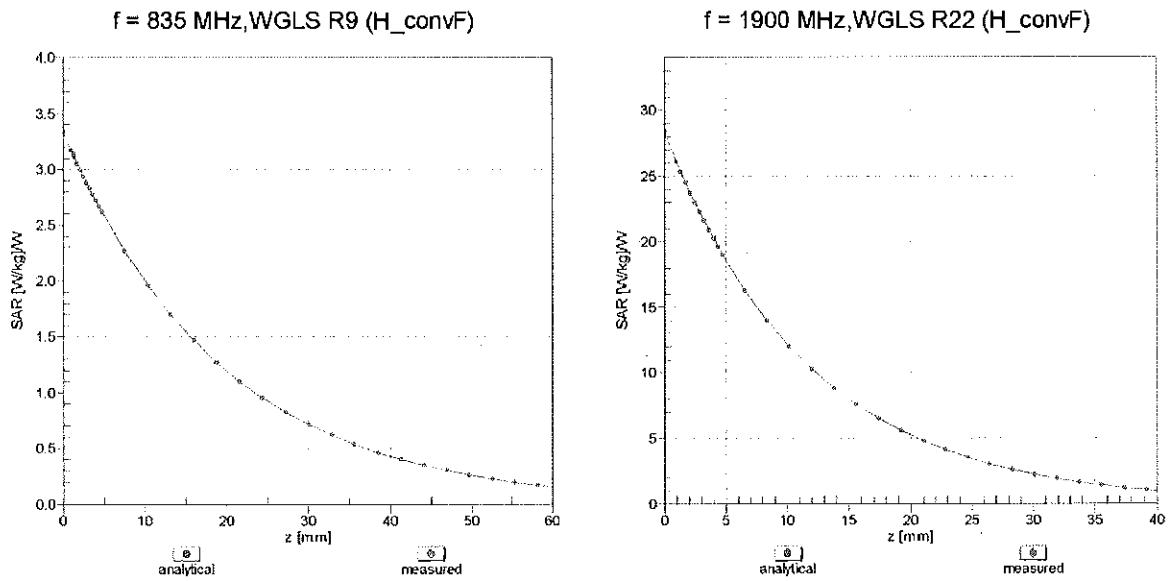

Deviation from Isotropy in Liquid Error (ϕ, ϑ), f = 900 MHz

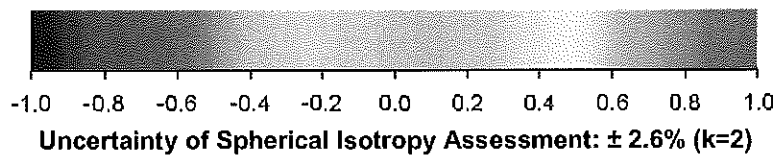
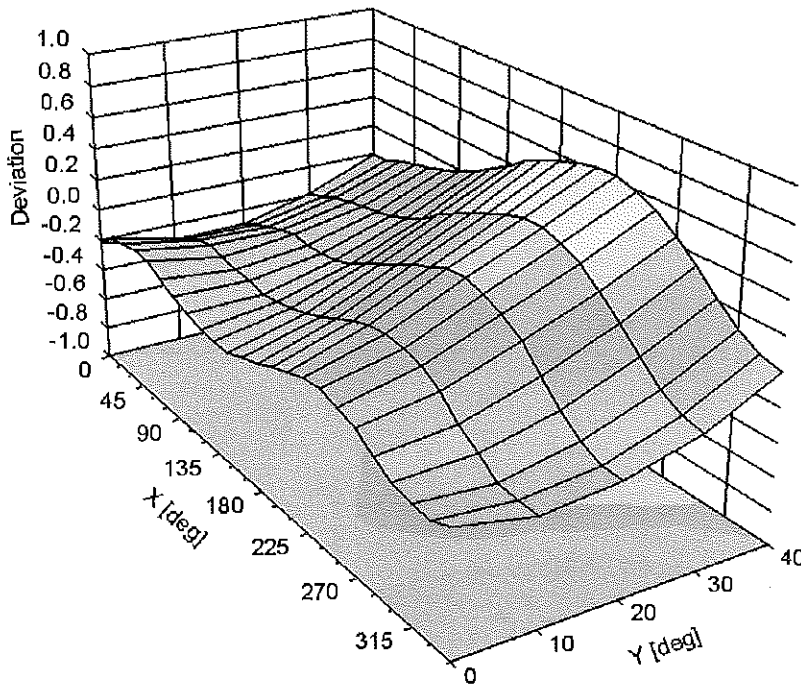

DASY/EASY - Parameters of Probe: EX3DV4 - SN:3589

Other Probe Parameters

Sensor Arrangement	Triangular
Connector Angle (°)	-38.2
Mechanical Surface Detection Mode	enabled
Optical Surface Detection Mode	disabled
Probe Overall Length	337 mm
Probe Body Diameter	10 mm
Tip Length	9 mm
Tip Diameter	2.5 mm
Probe Tip to Sensor X Calibration Point	1 mm
Probe Tip to Sensor Y Calibration Point	1 mm
Probe Tip to Sensor Z Calibration Point	1 mm
Recommended Measurement Distance from Surface	2 mm



Accredited by the Swiss Accreditation Service (SAS)
The Swiss Accreditation Service is one of the signatories to the EA
Multilateral Agreement for the recognition of calibration certificates

Accreditation No.: **SCS 108**

Client **PC Test**

Certificate No: **ES3-3333_Nov13**

CALIBRATION CERTIFICATE

Object **ES3DV3 - SN:3333**

Calibration procedure(s) **QA CAL 01.15, QA CAL 23.15, QA CAL 25.15
Calibration procedure for dielectric E-field probes**

Calibration date: **November 22, 2013**

*KOK
11/21/14*

This calibration certificate documents the traceability to national standards, which realize the physical units of measurements (SI).
The measurements and the uncertainties with confidence probability are given on the following pages and are part of the certificate.

All calibrations have been conducted in the closed laboratory facility: environment temperature (22 ± 3)°C and humidity < 70%.

Calibration Equipment used (M&TE critical for calibration)

Primary Standards	ID	Cal Date (Certificate No.)	Scheduled Calibration
Power meter E4419B	GB41293874	04-Apr-13 (No. 217-01733)	Apr-14
Power sensor E4412A	MY41498087	04-Apr-13 (No. 217-01733)	Apr-14
Reference 3 dB Attenuator	SN: S5054 (3c)	04-Apr-13 (No. 217-01737)	Apr-14
Reference 20 dB Attenuator	SN: S5277 (20x)	04-Apr-13 (No. 217-01735)	Apr-14
Reference 30 dB Attenuator	SN: S5129 (30b)	04-Apr-13 (No. 217-01738)	Apr-14
Reference Probe ES3DV2	SN: 3013	28-Dec-12 (No. ES3-3013_Dec12)	Dec-13
DAE4	SN: 660	4-Sep-13 (No. DAE4-660_Sep13)	Sep-14
Secondary Standards	ID	Check Date (in house)	Scheduled Check
RF generator HP 8648C	US3642U01700	4-Aug-99 (in house check Apr-13)	In house check: Apr-15
Network Analyzer HP 8753E	US37390585	18-Oct-01 (in house check Oct-13)	In house check: Oct-14

	Name	Function	Signature
Calibrated by:	Jeton Kastrati	Laboratory Technician	<i>[Signature]</i>
Approved by:	Katja Pokovic	Technical Manager	<i>[Signature]</i>

Issued: November 25, 2013

This calibration certificate shell not be reproduced except in full without written approval of the laboratory.



Accredited by the Swiss Accreditation Service (SAS)

Accreditation No.: **SCS 108**

The Swiss Accreditation Service is one of the signatories to the EA
Multilateral Agreement for the recognition of calibration certificates

Glossary:

TSL	tissue simulating liquid
NORM _{x,y,z}	sensitivity in free space
ConvF	sensitivity in TSL / NORM _{x,y,z}
DCP	diode compression point
CF	crest factor (1/duty_cycle) of the RF signal
A, B, C, D	modulation dependent linearization parameters
Polarization ϕ	ϕ rotation around probe axis
Polarization ϑ	ϑ rotation around an axis that is in the plane normal to probe axis (at measurement center), i.e., $\vartheta = 0$ is normal to probe axis
Connector Angle	information used in DASY system to align probe sensor X to the robot coordinate system

Calibration is Performed According to the Following Standards:

- IEEE Std 1528-2013, "IEEE Recommended Practice for Determining the Peak Spatial-Averaged Specific Absorption Rate (SAR) in the Human Head from Wireless Communications Devices: Measurement Techniques", June 2013
- IEC 62209-1, "Procedure to measure the Specific Absorption Rate (SAR) for hand-held devices used in close proximity to the ear (frequency range of 300 MHz to 3 GHz)", February 2005

Methods Applied and Interpretation of Parameters:

- NORM_{x,y,z}**: Assessed for E-field polarization $\vartheta = 0$ ($f \leq 900$ MHz in TEM-cell; $f > 1800$ MHz: R22 waveguide). NORM_{x,y,z} are only intermediate values, i.e., the uncertainties of NORM_{x,y,z} does not affect the E²-field uncertainty inside TSL (see below ConvF).
- NORM(f)_{x,y,z}** = NORM_{x,y,z} * frequency_response (see Frequency Response Chart). This linearization is implemented in DASY4 software versions later than 4.2. The uncertainty of the frequency response is included in the stated uncertainty of ConvF.
- DCP_{x,y,z}**: DCP are numerical linearization parameters assessed based on the data of power sweep with CW signal (no uncertainty required). DCP does not depend on frequency nor media.
- PAR**: PAR is the Peak to Average Ratio that is not calibrated but determined based on the signal characteristics
- A_{x,y,z}; B_{x,y,z}; C_{x,y,z}; D_{x,y,z}; VR_{x,y,z}; A, B, C, D** are numerical linearization parameters assessed based on the data of power sweep for specific modulation signal. The parameters do not depend on frequency nor media. VR is the maximum calibration range expressed in RMS voltage across the diode.
- ConvF and Boundary Effect Parameters**: Assessed in flat phantom using E-field (or Temperature Transfer Standard for $f \leq 800$ MHz) and inside waveguide using analytical field distributions based on power measurements for $f > 800$ MHz. The same setups are used for assessment of the parameters applied for boundary compensation (alpha, depth) of which typical uncertainty values are given. These parameters are used in DASY4 software to improve probe accuracy close to the boundary. The sensitivity in TSL corresponds to NORM_{x,y,z} * ConvF whereby the uncertainty corresponds to that given for ConvF. A frequency dependent ConvF is used in DASY version 4.4 and higher which allows extending the validity from ± 50 MHz to ± 100 MHz.
- Spherical isotropy (3D deviation from isotropy)**: in a field of low gradients realized using a flat phantom exposed by a patch antenna.
- Sensor Offset**: The sensor offset corresponds to the offset of virtual measurement center from the probe tip (on probe axis). No tolerance required.
- Connector Angle**: The angle is assessed using the information gained by determining the NORM_x (no uncertainty required).

Probe ES3DV3

SN:3333

Manufactured: January 24, 2012
Calibrated: November 22, 2013

Calibrated for DASY/EASY Systems
(Note: non-compatible with DASY2 system!)

DASY/EASY - Parameters of Probe: ES3DV3 - SN:3333

Basic Calibration Parameters

	Sensor X	Sensor Y	Sensor Z	Unc (k=2)
Norm ($\mu\text{V}/(\text{V}/\text{m})^2$) ^A	1.08	0.90	0.88	$\pm 10.1 \%$
DCP (mV) ^B	104.9	103.3	101.7	

Modulation Calibration Parameters

UID	Communication System Name		A dB	B dB $\sqrt{\mu\text{V}}$	C	D dB	VR mV	Unc ^E (k=2)
0	CW	X	0.0	0.0	1.0	0.00	140.9	$\pm 2.2 \%$
		Y	0.0	0.0	1.0		132.0	
		Z	0.0	0.0	1.0		170.3	

The reported uncertainty of measurement is stated as the standard uncertainty of measurement multiplied by the coverage factor $k=2$, which for a normal distribution corresponds to a coverage probability of approximately 95%.

^A The uncertainties of NormX,Y,Z do not affect the E^2 -field uncertainty inside TSL (see Pages 5 and 6).

^B Numerical linearization parameter: uncertainty not required.

^E Uncertainty is determined using the max. deviation from linear response applying rectangular distribution and is expressed for the square of the field value.

DASY/EASY - Parameters of Probe: ES3DV3 - SN:3333

Calibration Parameter Determined in Head Tissue Simulating Media

f (MHz) ^C	Relative Permittivity ^F	Conductivity (S/m) ^F	ConvF X	ConvF Y	ConvF Z	Alpha ^G	Depth ^G (mm)	Unct. (k=2)
750	41.9	0.89	6.56	6.56	6.56	0.44	1.54	± 12.0 %
850	41.5	0.92	6.30	6.30	6.30	0.46	1.48	± 12.0 %
1750	40.1	1.37	5.23	5.23	5.23	0.77	1.17	± 12.0 %
1900	40.0	1.40	5.05	5.05	5.05	0.80	1.19	± 12.0 %
2450	39.2	1.80	4.42	4.42	4.42	0.74	1.31	± 12.0 %
2600	39.0	1.96	4.28	4.28	4.28	0.80	1.30	± 12.0 %

^C Frequency validity of ± 100 MHz only applies for DASY v4.4 and higher (see Page 2), else it is restricted to ± 50 MHz. The uncertainty is the RSS of the ConvF uncertainty at calibration frequency and the uncertainty for the indicated frequency band.

^F At frequencies below 3 GHz, the validity of tissue parameters (ϵ and σ) can be relaxed to ± 10% if liquid compensation formula is applied to measured SAR values. At frequencies above 3 GHz, the validity of tissue parameters (ϵ and σ) is restricted to ± 5%. The uncertainty is the RSS of the ConvF uncertainty for indicated target tissue parameters.

^G Alpha/Depth are determined during calibration. SPEAG warrants that the remaining deviation due to the boundary effect after compensation is always less than ± 1% for frequencies below 3 GHz and below ± 2% for frequencies between 3-6 GHz at any distance larger than half the probe tip diameter from the boundary.

DASY/EASY - Parameters of Probe: ES3DV3 - SN:3333

Calibration Parameter Determined in Body Tissue Simulating Media

f (MHz) ^C	Relative Permittivity ^F	Conductivity (S/m) ^F	ConvF X	ConvF Y	ConvF Z	Alpha ^G	Depth ^G (mm)	Unct. (k=2)
750	55.5	0.96	6.11	6.11	6.11	0.33	1.90	± 12.0 %
850	55.2	0.99	6.07	6.07	6.07	0.80	1.19	± 12.0 %
1750	53.4	1.49	4.95	4.95	4.95	0.80	1.26	± 12.0 %
1900	53.3	1.52	4.71	4.71	4.71	0.49	1.54	± 12.0 %
2450	52.7	1.95	4.22	4.22	4.22	0.80	0.95	± 12.0 %
2600	52.5	2.16	4.16	4.16	4.16	0.80	1.07	± 12.0 %

^C Frequency validity of ± 100 MHz only applies for DASY v4.4 and higher (see Page 2), else it is restricted to ± 50 MHz. The uncertainty is the RSS of the ConvF uncertainty at calibration frequency and the uncertainty for the indicated frequency band.

^F At frequencies below 3 GHz, the validity of tissue parameters (ϵ and σ) can be relaxed to ± 10% if liquid compensation formula is applied to measured SAR values. At frequencies above 3 GHz, the validity of tissue parameters (ϵ and σ) is restricted to ± 5%. The uncertainty is the RSS of the ConvF uncertainty for indicated target tissue parameters.

^G Alpha/Depth are determined during calibration. SPEAG warrants that the remaining deviation due to the boundary effect after compensation is always less than ± 1% for frequencies below 3 GHz and below ± 2% for frequencies between 3-6 GHz at any distance larger than half the probe tip diameter from the boundary.

Frequency Response of E-Field (TEM-Cell:ifi110 EXX, Waveguide: R22)

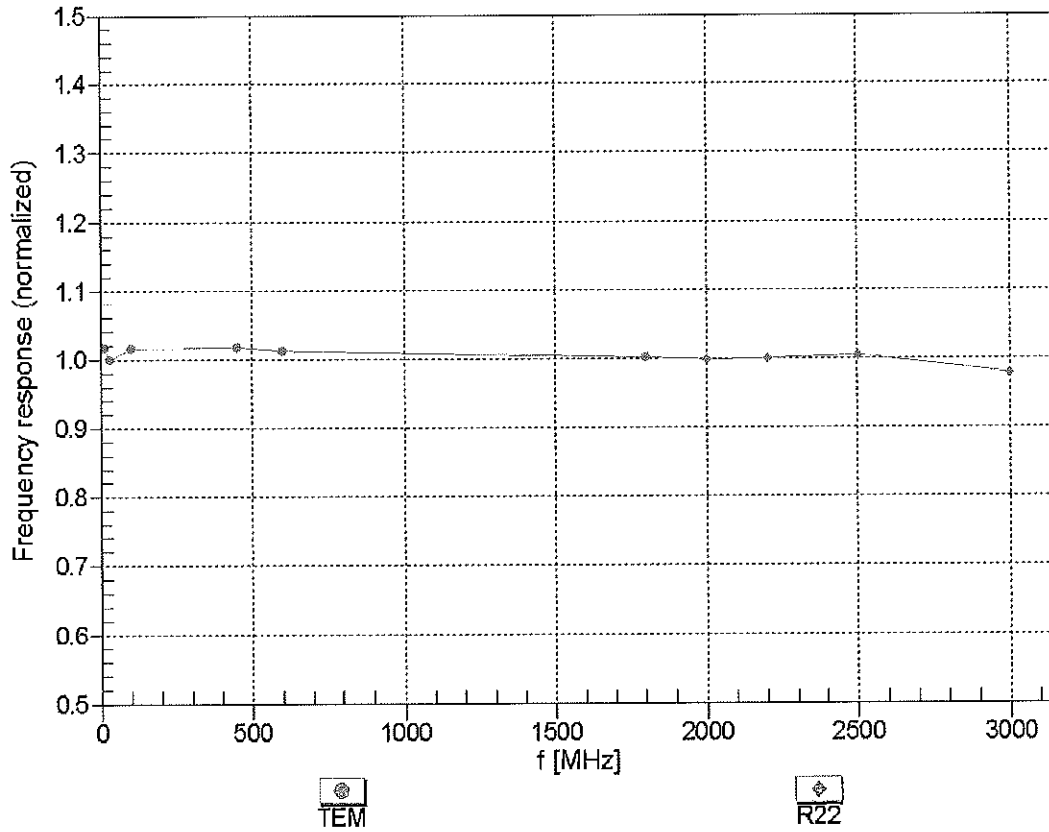

Uncertainty of Frequency Response of E-field: $\pm 6.3\%$ (k=2)

Receiving Pattern (ϕ), $\theta = 0^\circ$

f=600 MHz,TEM

f=1800 MHz,R22

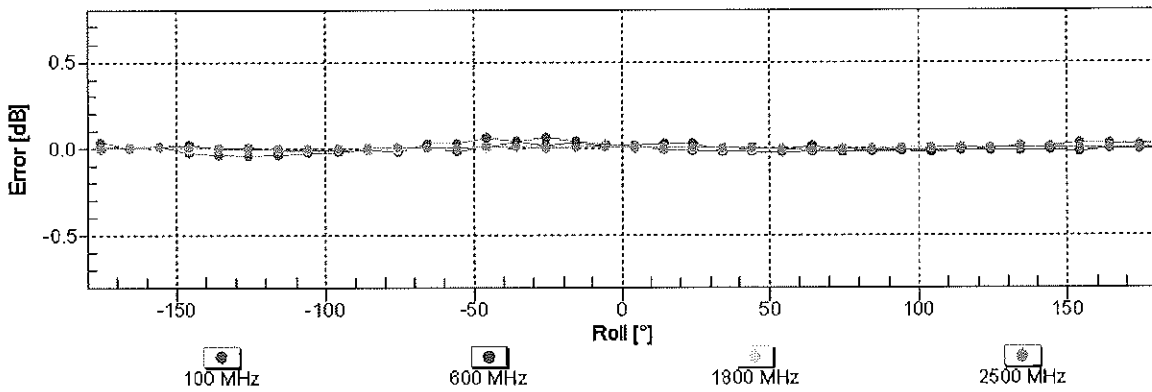
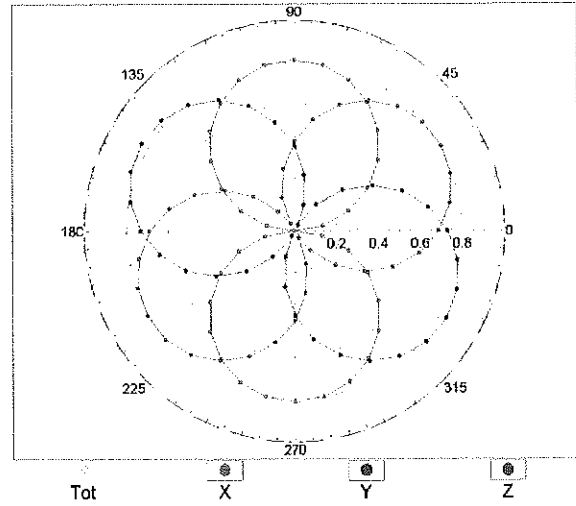
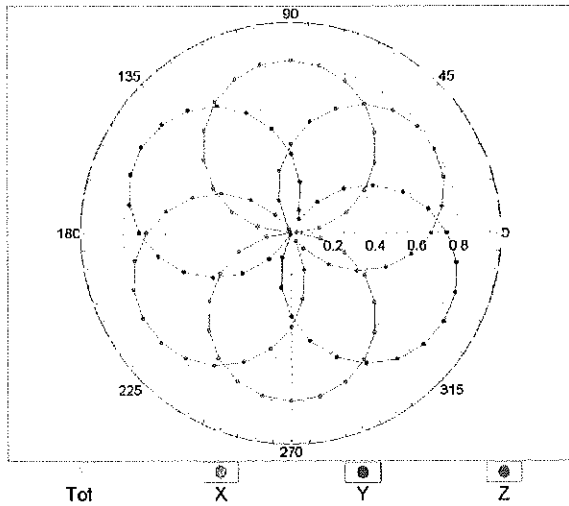

Uncertainty of Axial Isotropy Assessment: $\pm 0.5\%$ (k=2)

Dynamic Range $f(\text{SAR}_{\text{head}})$ (TEM cell , $f = 900 \text{ MHz}$)

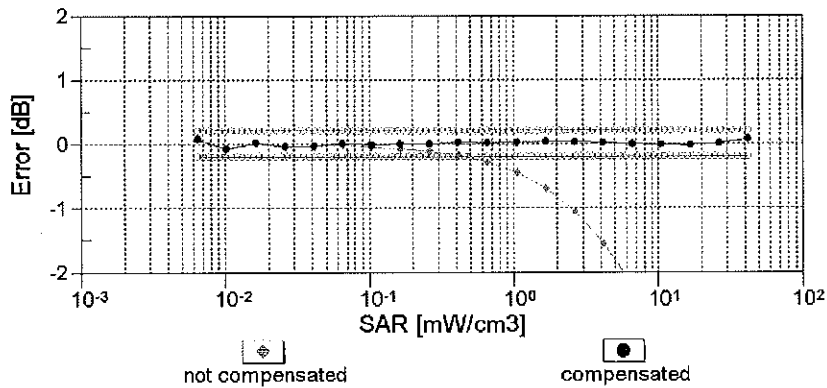
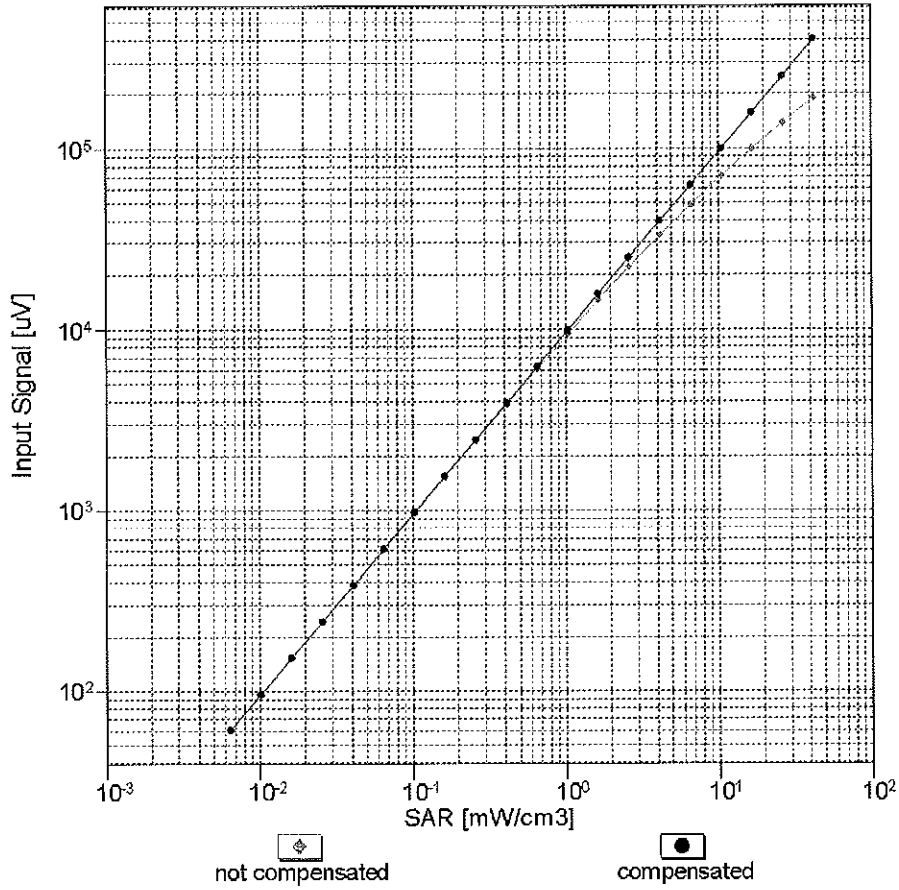

Uncertainty of Linearity Assessment: $\pm 0.6\%$ ($k=2$)

Conversion Factor Assessment

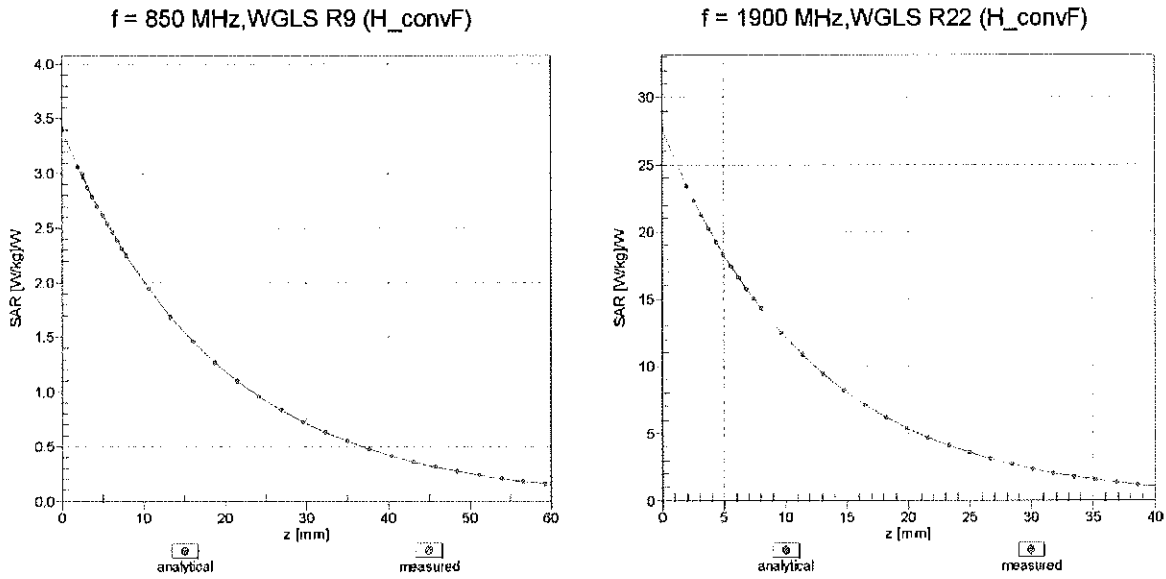

Deviation from Isotropy in Liquid Error (ϕ, θ), f = 900 MHz

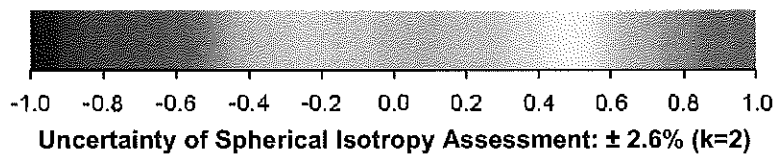
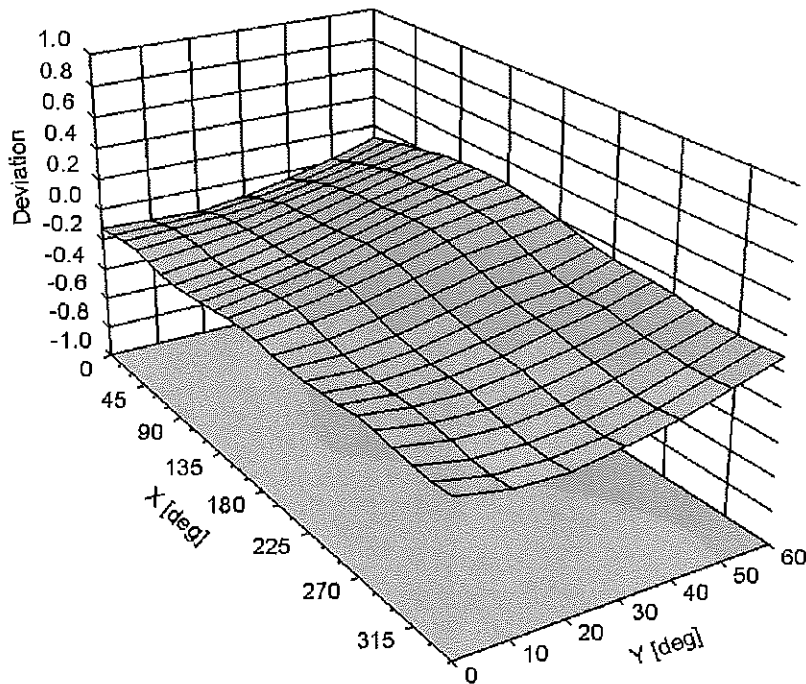

DASY/EASY - Parameters of Probe: ES3DV3 - SN:3333

Other Probe Parameters

Sensor Arrangement	Triangular
Connector Angle (°)	-35.7
Mechanical Surface Detection Mode	enabled
Optical Surface Detection Mode	disabled
Probe Overall Length	337 mm
Probe Body Diameter	10 mm
Tip Length	10 mm
Tip Diameter	4 mm
Probe Tip to Sensor X Calibration Point	2 mm
Probe Tip to Sensor Y Calibration Point	2 mm
Probe Tip to Sensor Z Calibration Point	2 mm
Recommended Measurement Distance from Surface	3 mm



Accredited by the Swiss Accreditation Service (SAS)
The Swiss Accreditation Service is one of the signatories to the EA
Multilateral Agreement for the recognition of calibration certificates

Accreditation No.: **SCS 108**

Client **PC Test**

Certificate No.: **ES3-3022_Aug13**

CALIBRATION CERTIFICATE

Object **ES3DV2 - SN:3022**

Calibration procedure(s) **QA CAL-01.v9, QA CAL-23.v5, QA CAL-25.v6
Calibration procedure for dosimetric E-field probes**

Calibration date: **August 22, 2013**

UTC
9/13/13

This calibration certificate documents the traceability to national standards, which realize the physical units of measurements (SI).
The measurements and the uncertainties with confidence probability are given on the following pages and are part of the certificate.

All calibrations have been conducted in the closed laboratory facility: environment temperature (22 ± 3)°C and humidity < 70%.

Calibration Equipment used (M&TE critical for calibration)

Primary Standards	ID	Cal Date (Certificate No.)	Scheduled Calibration
Power meter E4419B	GB41293874	04-Apr-13 (No. 217-01733)	Apr-14
Power sensor E4412A	MY41498087	04-Apr-13 (No. 217-01733)	Apr-14
Reference 3 dB Attenuator	SN: S5054 (3c)	04-Apr-13 (No. 217-01737)	Apr-14
Reference 20 dB Attenuator	SN: S5277 (20x)	04-Apr-13 (No. 217-01735)	Apr-14
Reference 30 dB Attenuator	SN: S5129 (30b)	04-Apr-13 (No. 217-01738)	Apr-14
Reference Probe ES3DV2	SN: 3013	28-Dec-12 (No. ES3-3013_Dec12)	Dec-13
DAE4	SN: 660	31-Jan-13 (No. DAE4-660_Jan13)	Jan-14
Secondary Standards	ID	Check Date (in house)	Scheduled Check
RF generator HP 8648C	US3642U01700	4-Aug-99 (in house check Apr-13)	In house check: Apr-15
Network Analyzer HP 8753E	US37390585	18-Oct-01 (in house check Oct-12)	In house check: Oct-13

	Name	Function	Signature
Calibrated by:	Jeton Kastrati	Laboratory Technician	
Approved by:	Katja Pokovic	Technical Manager	

Issued: August 23, 2013

This calibration certificate shall not be reproduced except in full without written approval of the laboratory.



Accredited by the Swiss Accreditation Service (SAS)

Accreditation No.: **SCS 108**

The Swiss Accreditation Service is one of the signatories to the EA Multilateral Agreement for the recognition of calibration certificates

Glossary:

TSL	tissue simulating liquid
NORM _{x,y,z}	sensitivity in free space
ConvF	sensitivity in TSL / NORM _{x,y,z}
DCP	diode compression point
CF	crest factor (1/duty_cycle) of the RF signal
A, B, C, D	modulation dependent linearization parameters
Polarization φ	φ rotation around probe axis
Polarization ϑ	ϑ rotation around an axis that is in the plane normal to probe axis (at measurement center), i.e., $\vartheta = 0$ is normal to probe axis

Calibration is Performed According to the Following Standards:

- IEEE Std 1528-2003, "IEEE Recommended Practice for Determining the Peak Spatial-Averaged Specific Absorption Rate (SAR) in the Human Head from Wireless Communications Devices: Measurement Techniques", December 2003
- IEC 62209-1, "Procedure to measure the Specific Absorption Rate (SAR) for hand-held devices used in close proximity to the ear (frequency range of 300 MHz to 3 GHz)", February 2005

Methods Applied and Interpretation of Parameters:

- NORM_{x,y,z}**: Assessed for E-field polarization $\vartheta = 0$ ($f \leq 900$ MHz in TEM-cell; $f > 1800$ MHz: R22 waveguide). NORM_{x,y,z} are only intermediate values, i.e., the uncertainties of NORM_{x,y,z} does not affect the E²-field uncertainty inside TSL (see below ConvF).
- NORM(f)_{x,y,z}** = NORM_{x,y,z} * frequency_response (see Frequency Response Chart). This linearization is implemented in DASY4 software versions later than 4.2. The uncertainty of the frequency response is included in the stated uncertainty of ConvF.
- DCP_{x,y,z}**: DCP are numerical linearization parameters assessed based on the data of power sweep with CW signal (no uncertainty required). DCP does not depend on frequency nor media.
- PAR**: PAR is the Peak to Average Ratio that is not calibrated but determined based on the signal characteristics
- A_{x,y,z}; B_{x,y,z}; C_{x,y,z}; D_{x,y,z}; VR_{x,y,z}**: A, B, C, D are numerical linearization parameters assessed based on the data of power sweep for specific modulation signal. The parameters do not depend on frequency nor media. VR is the maximum calibration range expressed in RMS voltage across the diode.
- ConvF and Boundary Effect Parameters**: Assessed in flat phantom using E-field (or Temperature Transfer Standard for $f \leq 800$ MHz) and inside waveguide using analytical field distributions based on power measurements for $f > 800$ MHz. The same setups are used for assessment of the parameters applied for boundary compensation (alpha, depth) of which typical uncertainty values are given. These parameters are used in DASY4 software to improve probe accuracy close to the boundary. The sensitivity in TSL corresponds to NORM_{x,y,z} * ConvF whereby the uncertainty corresponds to that given for ConvF. A frequency dependent ConvF is used in DASY version 4.4 and higher which allows extending the validity from ± 50 MHz to ± 100 MHz.
- Spherical isotropy (3D deviation from isotropy)**: in a field of low gradients realized using a flat phantom exposed by a patch antenna.
- Sensor Offset**: The sensor offset corresponds to the offset of virtual measurement center from the probe tip (on probe axis). No tolerance required.

Probe ES3DV2

SN:3022

Manufactured: April 15, 2003
Calibrated: August 22, 2013

Calibrated for DASY/EASY Systems
(Note: non-compatible with DASY2 system!)

DASY/EASY - Parameters of Probe: ES3DV2 - SN:3022

Basic Calibration Parameters

	Sensor X	Sensor Y	Sensor Z	Unc (k=2)
Norm ($\mu\text{V}/(\text{V}/\text{m})^2$) ^A	1.00	1.04	0.99	± 10.1 %
DCP (mV) ^B	100.7	97.4	99.7	

Modulation Calibration Parameters

UID	Communication System Name		A dB	B dB $\sqrt{\mu\text{V}}$	C	D dB	VR mV	Unc ^E (k=2)
0	CW	X	0.0	0.0	1.0	0.00	178.6	±3.0 %
		Y	0.0	0.0	1.0		141.9	
		Z	0.0	0.0	1.0		134.7	

The reported uncertainty of measurement is stated as the standard uncertainty of measurement multiplied by the coverage factor k=2, which for a normal distribution corresponds to a coverage probability of approximately 95%.

^A The uncertainties of NormX,Y,Z do not affect the E²-field uncertainty inside TSL (see Pages 5 and 6).

^B Numerical linearization parameter: uncertainty not required.

^E Uncertainty is determined using the max. deviation from linear response applying rectangular distribution and is expressed for the square of the field value.

DASY/EASY - Parameters of Probe: ES3DV2 - SN:3022

Calibration Parameter Determined in Head Tissue Simulating Media

f (MHz) ^C	Relative Permittivity ^F	Conductivity (S/m) ^F	ConvF X	ConvF Y	ConvF Z	Alpha	Depth (mm)	Unct. (k=2)
750	41.9	0.89	6.21	6.21	6.21	0.19	2.37	± 12.0 %
835	41.5	0.90	6.09	6.09	6.09	0.30	1.70	± 12.0 %
1750	40.1	1.37	5.19	5.19	5.19	0.65	1.23	± 12.0 %
1900	40.0	1.40	5.03	5.03	5.03	0.51	1.43	± 12.0 %
2450	39.2	1.80	4.36	4.36	4.36	0.51	1.51	± 12.0 %
2600	39.0	1.96	4.16	4.16	4.16	0.74	1.29	± 12.0 %

^C Frequency validity of ± 100 MHz only applies for DASY v4.4 and higher (see Page 2), else it is restricted to ± 50 MHz. The uncertainty is the RSS of the ConvF uncertainty at calibration frequency and the uncertainty for the indicated frequency band.

^F At frequencies below 3 GHz, the validity of tissue parameters (ϵ and σ) can be relaxed to ± 10% if liquid compensation formula is applied to measured SAR values. At frequencies above 3 GHz, the validity of tissue parameters (ϵ and σ) is restricted to ± 5%. The uncertainty is the RSS of the ConvF uncertainty for indicated target tissue parameters.

DASY/EASY - Parameters of Probe: ES3DV2 - SN:3022

Calibration Parameter Determined in Body Tissue Simulating Media

f (MHz) ^C	Relative Permittivity ^F	Conductivity (S/m) ^F	ConvF X	ConvF Y	ConvF Z	Alpha	Depth (mm)	Unct. (k=2)
750	55.5	0.96	5.92	5.92	5.92	0.24	1.99	± 12.0 %
835	55.2	0.97	5.91	5.91	5.91	0.29	1.85	± 12.0 %
1750	53.4	1.49	4.75	4.75	4.75	0.52	1.52	± 12.0 %
1900	53.3	1.52	4.49	4.49	4.49	0.49	1.56	± 12.0 %
2450	52.7	1.95	4.01	4.01	4.01	0.70	1.02	± 12.0 %
2600	52.5	2.16	3.85	3.85	3.85	0.58	0.90	± 12.0 %

^C Frequency validity of ± 100 MHz only applies for DASY v4.4 and higher (see Page 2), else it is restricted to ± 50 MHz. The uncertainty is the RSS of the ConvF uncertainty at calibration frequency and the uncertainty for the indicated frequency band.

^F At frequencies below 3 GHz, the validity of tissue parameters (ϵ and σ) can be relaxed to ± 10% if liquid compensation formula is applied to measured SAR values. At frequencies above 3 GHz, the validity of tissue parameters (ϵ and σ) is restricted to ± 5%. The uncertainty is the RSS of the ConvF uncertainty for indicated target tissue parameters.

Frequency Response of E-Field (TEM-Cell:ifi110 EXX, Waveguide: R22)

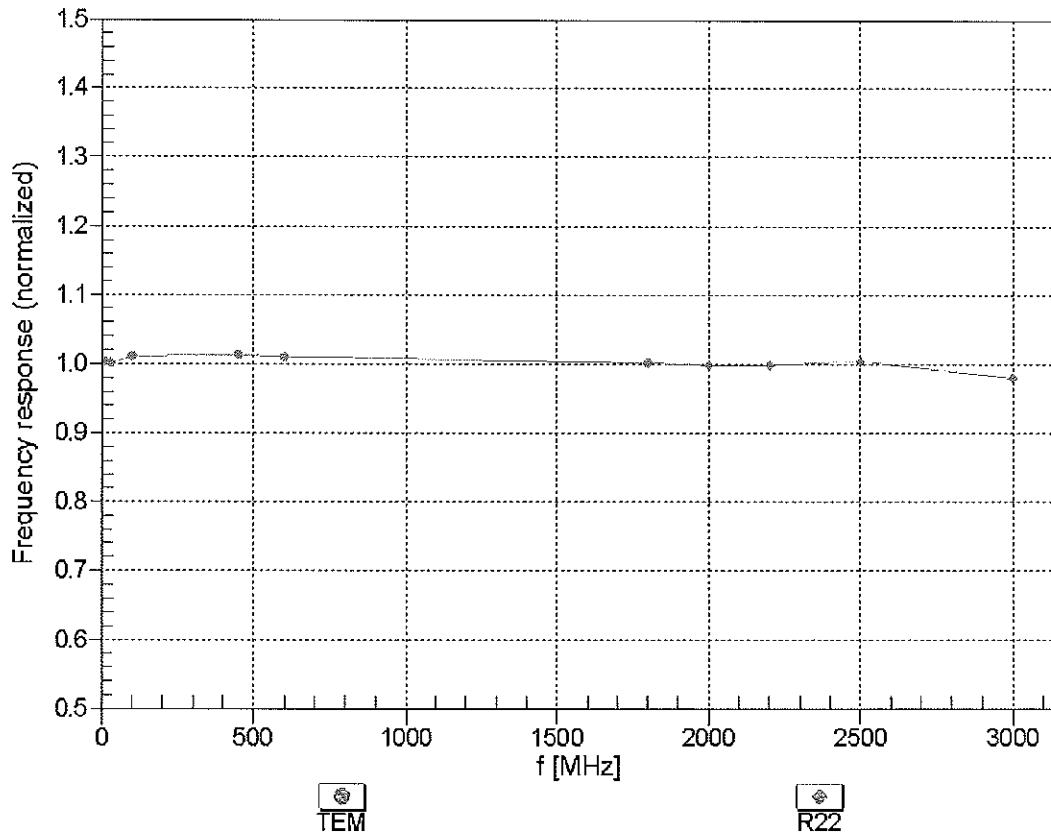

Uncertainty of Frequency Response of E-field: $\pm 6.3\%$ (k=2)

Receiving Pattern (ϕ), $\theta = 0^\circ$

f=600 MHz,TEM

f=1800 MHz,R22

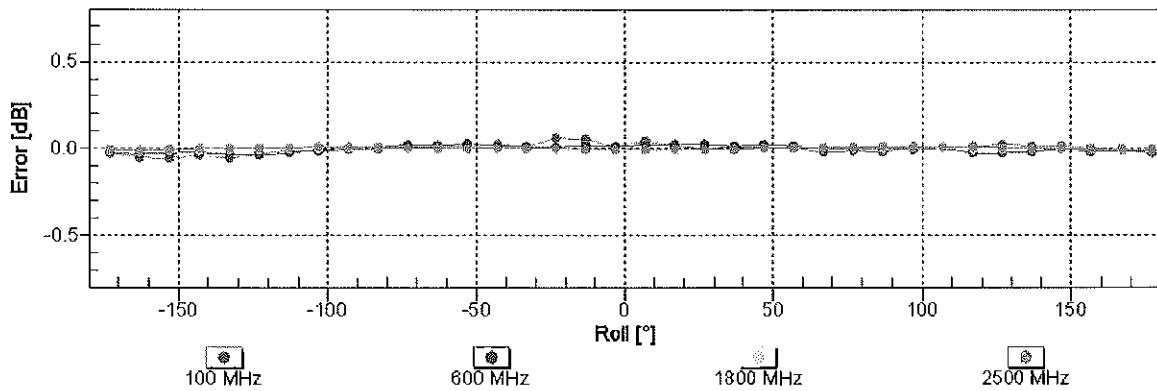
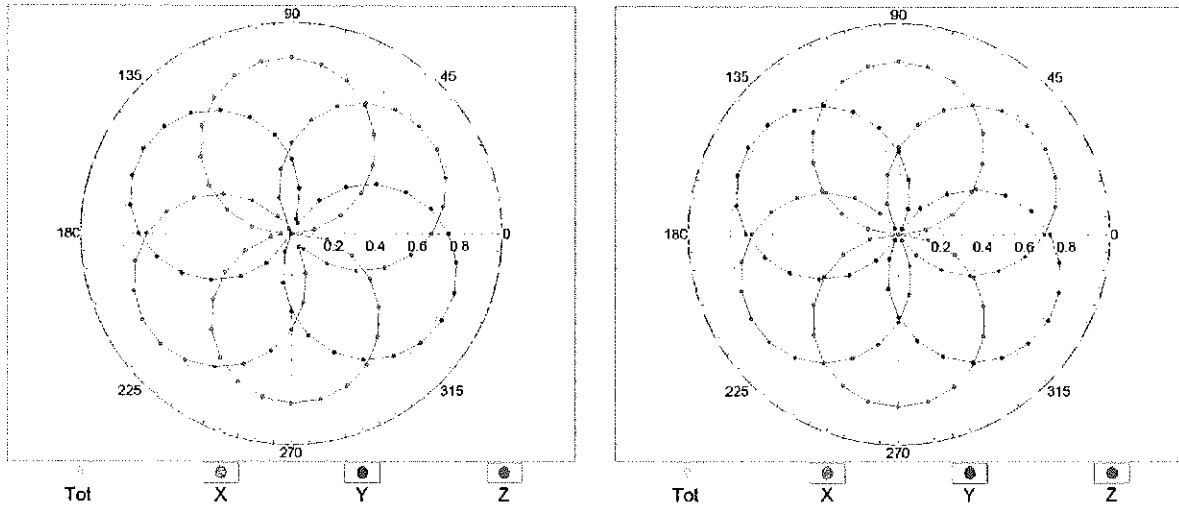

Uncertainty of Axial Isotropy Assessment: $\pm 0.5\%$ ($k=2$)

Dynamic Range f(SAR_{head}) (TEM cell , f = 900 MHz)

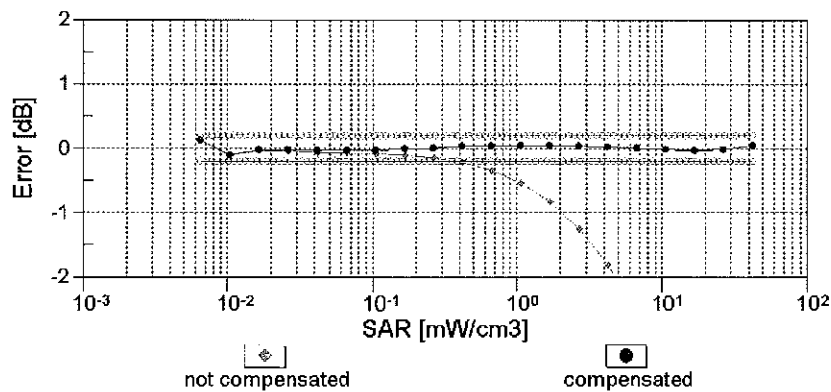
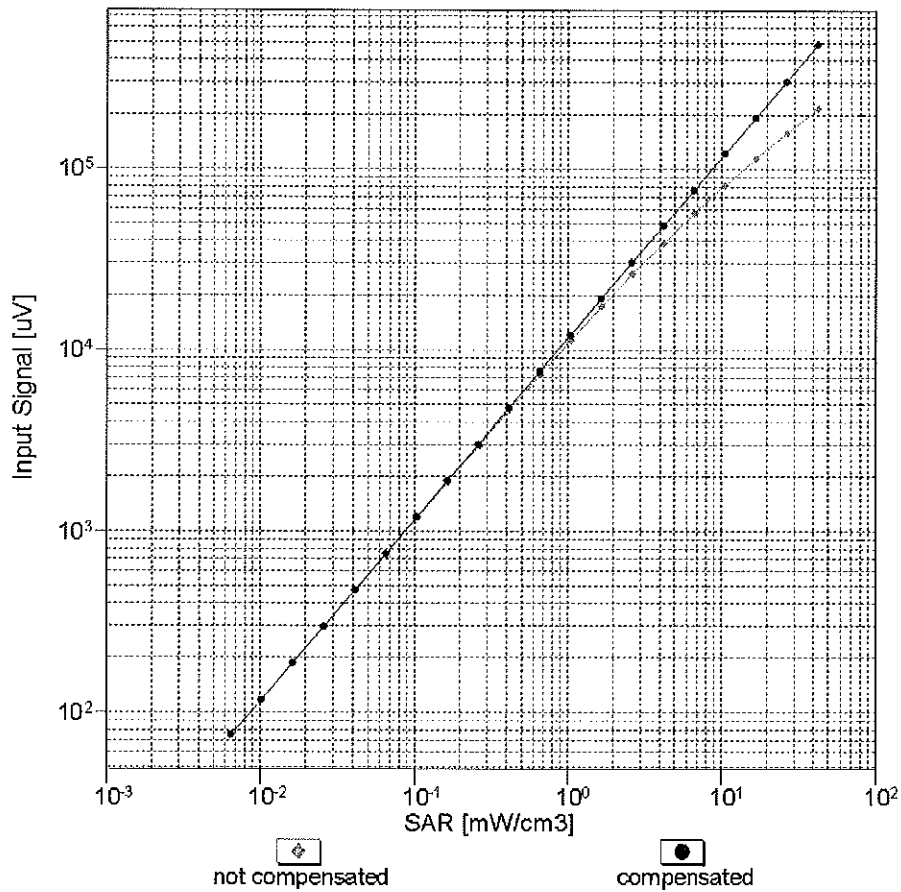

Uncertainty of Linearity Assessment: ± 0.6% (k=2)

Conversion Factor Assessment

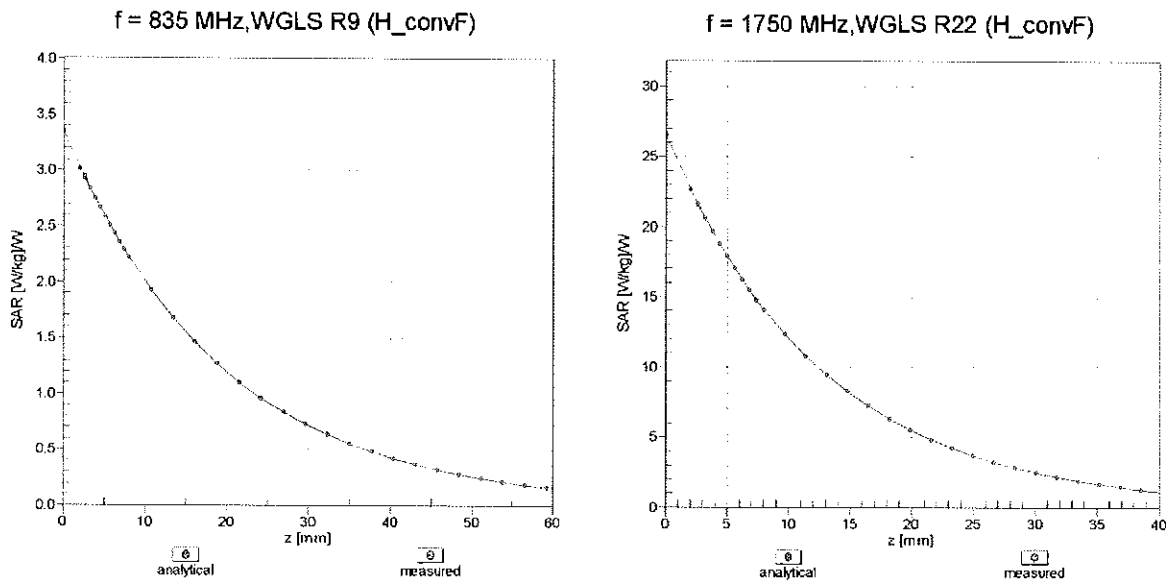

Deviation from Isotropy in Liquid Error (ϕ, θ), f = 900 MHz

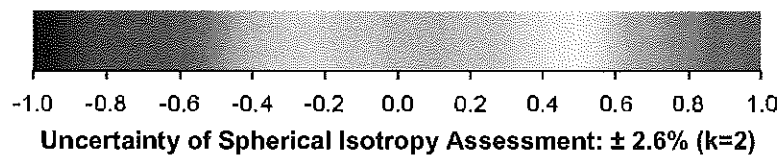
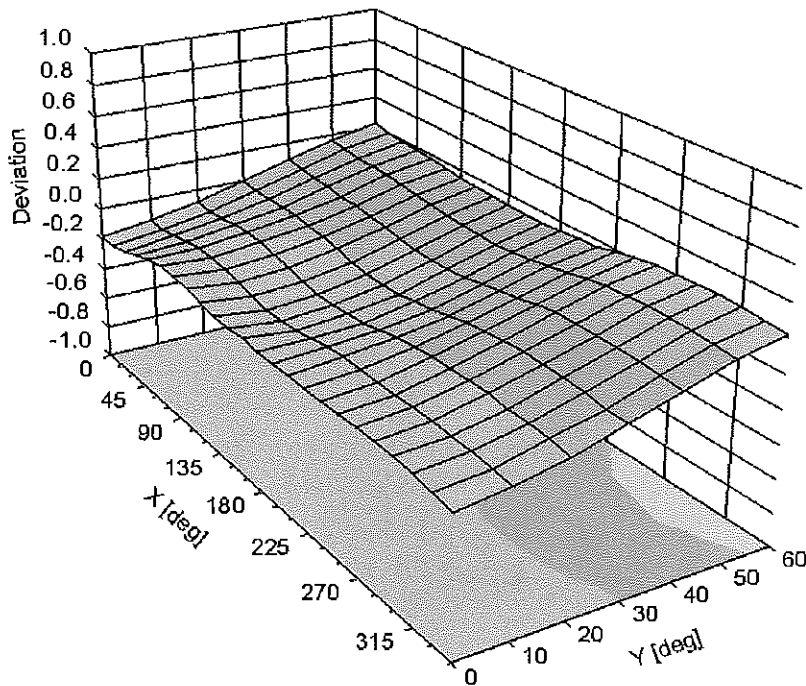

DASY/EASY - Parameters of Probe: ES3DV2 - SN:3022

Other Probe Parameters

Sensor Arrangement	Triangular
Connector Angle (°)	-83.1
Mechanical Surface Detection Mode	enabled
Optical Surface Detection Mode	disabled
Probe Overall Length	337 mm
Probe Body Diameter	10 mm
Tip Length	10 mm
Tip Diameter	4 mm
Probe Tip to Sensor X Calibration Point	2 mm
Probe Tip to Sensor Y Calibration Point	2 mm
Probe Tip to Sensor Z Calibration Point	2 mm
Recommended Measurement Distance from Surface	3 mm



Accredited by the Swiss Accreditation Service (SAS)
The Swiss Accreditation Service is one of the signatories to the EA
Multilateral Agreement for the recognition of calibration certificates

Accreditation No.: **SCS 108**

Client **PC Test**

Certificate No: **ES3-3332_Nov13**

CALIBRATION CERTIFICATE

Object **ES3DV3 - SN:3332**

Calibration procedure(s) **QA CAL-01.v9, QA CAL-23.v5, QA CAL-25.v6
Calibration procedure for dosimetric E-field probes**

Calibration date: **November 25, 2013**

VCC
1/12/13

This calibration certificate documents the traceability to national standards, which realize the physical units of measurements (SI).
The measurements and the uncertainties with confidence probability are given on the following pages and are part of the certificate.

All calibrations have been conducted in the closed laboratory facility: environment temperature (22 ± 3)°C and humidity < 70%.

Calibration Equipment used (M&TE critical for calibration)

Primary Standards	ID	Cal Date (Certificate No.)	Scheduled Calibration
Power meter E4419B	GB41293874	04-Apr-13 (No. 217-01733)	Apr-14
Power sensor E4412A	MY41498087	04-Apr-13 (No. 217-01733)	Apr-14
Reference 3 dB Attenuator	SN: S5054 (3c)	04-Apr-13 (No. 217-01737)	Apr-14
Reference 20 dB Attenuator	SN: S5277 (20x)	04-Apr-13 (No. 217-01735)	Apr-14
Reference 30 dB Attenuator	SN: S5129 (30b)	04-Apr-13 (No. 217-01738)	Apr-14
Reference Probe ES3DV2	SN: 3013	28-Dec-12 (No. ES3-3013_Dec12)	Dec-13
DAE4	SN: 660	4-Sep-13 (No. DAE4-660_Sep13)	Sep-14
Secondary Standards	ID	Check Date (in house)	Scheduled Check
RF generator HP 8648C	US3642U01700	4-Aug-99 (in house check Apr-13)	In house check: Apr-15
Network Analyzer HP 8753E	US37390585	18-Oct-01 (in house check Oct-13)	In house check: Oct-14

Calibrated by:	Name Leif Klysner	Function Laboratory Technician	Signature
Approved by:	Name Katja Pokovic	Function Technical Manager	Signature

Issued: November 25, 2013

This calibration certificate shall not be reproduced except in full without written approval of the laboratory.



Accredited by the Swiss Accreditation Service (SAS)

Accreditation No.: **SCS 108**

The Swiss Accreditation Service is one of the signatories to the EA
Multilateral Agreement for the recognition of calibration certificates

Glossary:

TSL	tissue simulating liquid
NORM _{x,y,z}	sensitivity in free space
ConvF	sensitivity in TSL / NORM _{x,y,z}
DCP	diode compression point
CF	crest factor (1/duty_cycle) of the RF signal
A, B, C, D	modulation dependent linearization parameters
Polarization φ	φ rotation around probe axis
Polarization ϑ	ϑ rotation around an axis that is in the plane normal to probe axis (at measurement center), i.e., $\vartheta = 0$ is normal to probe axis
Connector Angle	information used in DASY system to align probe sensor X to the robot coordinate system

Calibration is Performed According to the Following Standards:

- IEEE Std 1528-2013, "IEEE Recommended Practice for Determining the Peak Spatial-Averaged Specific Absorption Rate (SAR) in the Human Head from Wireless Communications Devices: Measurement Techniques", June 2013
- IEC 62209-1, "Procedure to measure the Specific Absorption Rate (SAR) for hand-held devices used in close proximity to the ear (frequency range of 300 MHz to 3 GHz)", February 2005

Methods Applied and Interpretation of Parameters:

- NORM_{x,y,z}**: Assessed for E-field polarization $\vartheta = 0$ ($f \leq 900$ MHz in TEM-cell; $f > 1800$ MHz: R22 waveguide). NORM_{x,y,z} are only intermediate values, i.e., the uncertainties of NORM_{x,y,z} does not affect the E^2 -field uncertainty inside TSL (see below *ConvF*).
- NORM(f)_{x,y,z}** = NORM_{x,y,z} * *frequency_response* (see Frequency Response Chart). This linearization is implemented in DASY4 software versions later than 4.2. The uncertainty of the frequency response is included in the stated uncertainty of *ConvF*.
- DCP_{x,y,z}**: DCP are numerical linearization parameters assessed based on the data of power sweep with CW signal (no uncertainty required). DCP does not depend on frequency nor media.
- PAR**: PAR is the Peak to Average Ratio that is not calibrated but determined based on the signal characteristics
- A_{x,y,z}; B_{x,y,z}; C_{x,y,z}; D_{x,y,z}; VR_{x,y,z}; A, B, C, D** are numerical linearization parameters assessed based on the data of power sweep for specific modulation signal. The parameters do not depend on frequency nor media. VR is the maximum calibration range expressed in RMS voltage across the diode.
- ConvF and Boundary Effect Parameters**: Assessed in flat phantom using E-field (or Temperature Transfer Standard for $f \leq 800$ MHz) and inside waveguide using analytical field distributions based on power measurements for $f > 800$ MHz. The same setups are used for assessment of the parameters applied for boundary compensation (alpha, depth) of which typical uncertainty values are given. These parameters are used in DASY4 software to improve probe accuracy close to the boundary. The sensitivity in TSL corresponds to NORM_{x,y,z} * ConvF whereby the uncertainty corresponds to that given for ConvF. A frequency dependent ConvF is used in DASY version 4.4 and higher which allows extending the validity from ± 50 MHz to ± 100 MHz.
- Spherical isotropy (3D deviation from isotropy)**: in a field of low gradients realized using a flat phantom exposed by a patch antenna.
- Sensor Offset**: The sensor offset corresponds to the offset of virtual measurement center from the probe tip (on probe axis). No tolerance required.
- Connector Angle**: The angle is assessed using the information gained by determining the NORM_x (no uncertainty required).

Probe ES3DV3

SN:3332

Manufactured: January 24, 2012
Calibrated: November 25, 2013

Calibrated for DASY/EASY Systems
(Note: non-compatible with DASY2 system!)

DASY/EASY - Parameters of Probe: ES3DV3 - SN:3332

Basic Calibration Parameters

	Sensor X	Sensor Y	Sensor Z	Unc (k=2)
Norm ($\mu\text{V}/(\text{V}/\text{m})^2$) ^A	0.94	1.16	0.97	± 10.1 %
DCP (mV) ^B	103.5	101.0	111.0	

Modulation Calibration Parameters

UID	Communication System Name		A dB	B dB $\sqrt{\mu\text{V}}$	C	D dB	VR mV	Unc ^E (k=2)
0	CW	X	0.0	0.0	1.0	0.00	179.7	±2.5 %
		Y	0.0	0.0	1.0		147.3	
		Z	0.0	0.0	1.0		188.8	

The reported uncertainty of measurement is stated as the standard uncertainty of measurement multiplied by the coverage factor k=2, which for a normal distribution corresponds to a coverage probability of approximately 95%.

^A The uncertainties of NormX,Y,Z do not affect the E²-field uncertainty inside TSL (see Pages 5 and 6).

^B Numerical linearization parameter: uncertainty not required.

^E Uncertainty is determined using the max. deviation from linear response applying rectangular distribution and is expressed for the square of the field value.

DASY/EASY - Parameters of Probe: ES3DV3 - SN:3332

Calibration Parameter Determined in Head Tissue Simulating Media

f (MHz) ^C	Relative Permittivity ^F	Conductivity (S/m) ^F	ConvF X	ConvF Y	ConvF Z	Alpha ^G	Depth ^G (mm)	Unct. (k=2)
750	41.9	0.89	6.46	6.46	6.46	0.52	1.42	± 12.0 %
850	41.5	0.92	6.29	6.29	6.29	0.78	1.17	± 12.0 %
1750	40.1	1.37	5.27	5.27	5.27	0.80	1.10	± 12.0 %
1900	40.0	1.40	5.06	5.06	5.06	0.80	1.18	± 12.0 %
2450	39.2	1.80	4.50	4.50	4.50	0.80	1.19	± 12.0 %
2600	39.0	1.96	4.38	4.38	4.38	0.76	1.31	± 12.0 %

^C Frequency validity of ± 100 MHz only applies for DASY v4.4 and higher (see Page 2), else it is restricted to ± 50 MHz. The uncertainty is the RSS of the ConvF uncertainty at calibration frequency and the uncertainty for the indicated frequency band.

^F At frequencies below 3 GHz, the validity of tissue parameters (ϵ and σ) can be relaxed to ± 10% if liquid compensation formula is applied to measured SAR values. At frequencies above 3 GHz, the validity of tissue parameters (ϵ and σ) is restricted to ± 5%. The uncertainty is the RSS of the ConvF uncertainty for indicated target tissue parameters.

^G Alpha/Depth are determined during calibration. SPEAG warrants that the remaining deviation due to the boundary effect after compensation is always less than ± 1% for frequencies below 3 GHz and below ± 2% for frequencies between 3-6 GHz at any distance larger than half the probe tip diameter from the boundary.

DASY/EASY - Parameters of Probe: ES3DV3 - SN:3332

Calibration Parameter Determined in Body Tissue Simulating Media

f (MHz) ^C	Relative Permittivity ^F	Conductivity (S/m) ^F	ConvF X	ConvF Y	ConvF Z	Alpha ^G	Depth (mm) ^G	Unct. (k=2)
750	55.5	0.96	6.21	6.21	6.21	0.80	1.19	± 12.0 %
850	55.2	0.99	6.08	6.08	6.08	0.51	1.48	± 12.0 %
1750	53.4	1.49	4.93	4.93	4.93	0.42	1.72	± 12.0 %
1900	53.3	1.52	4.70	4.70	4.70	0.48	1.59	± 12.0 %
2450	52.7	1.95	4.24	4.24	4.24	0.80	1.01	± 12.0 %
2600	52.5	2.16	4.07	4.07	4.07	0.80	0.50	± 12.0 %

^C Frequency validity of ± 100 MHz only applies for DASY v4.4 and higher (see Page 2), else it is restricted to ± 50 MHz. The uncertainty is the RSS of the ConvF uncertainty at calibration frequency and the uncertainty for the indicated frequency band.

^F At frequencies below 3 GHz, the validity of tissue parameters (ϵ and σ) can be relaxed to ± 10% if liquid compensation formula is applied to measured SAR values. At frequencies above 3 GHz, the validity of tissue parameters (ϵ and σ) is restricted to ± 5%. The uncertainty is the RSS of the ConvF uncertainty for indicated target tissue parameters.

^G Alpha/Depth are determined during calibration. SPEAG warrants that the remaining deviation due to the boundary effect after compensation is always less than ± 1% for frequencies below 3 GHz and below ± 2% for frequencies between 3-6 GHz at any distance larger than half the probe tip diameter from the boundary.

Frequency Response of E-Field (TEM-Cell:ifi110 EXX, Waveguide: R22)

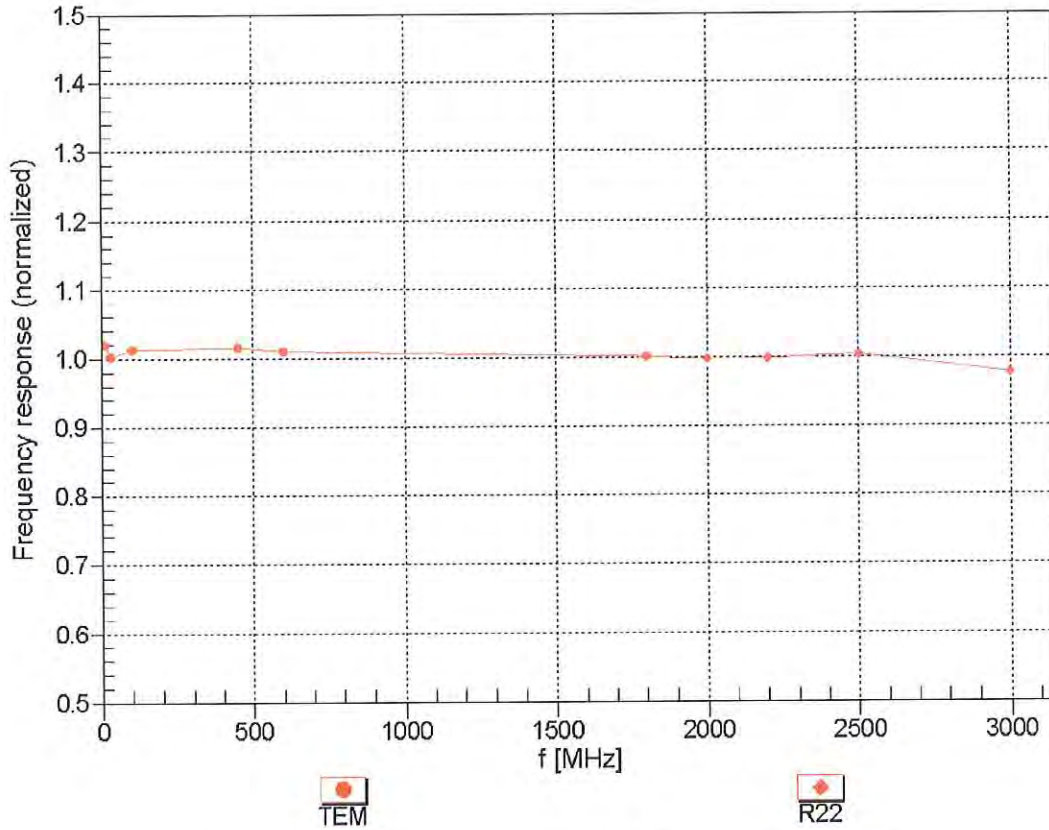

Uncertainty of Frequency Response of E-field: $\pm 6.3\%$ (k=2)

Receiving Pattern (ϕ), $\vartheta = 0^\circ$

f=600 MHz,TEM

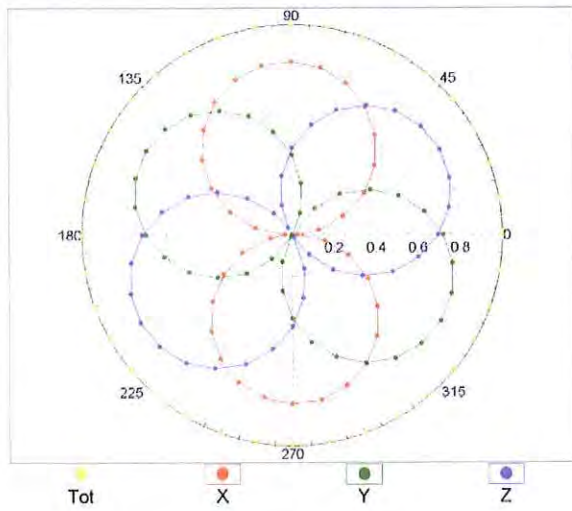

f=1800 MHz,R22

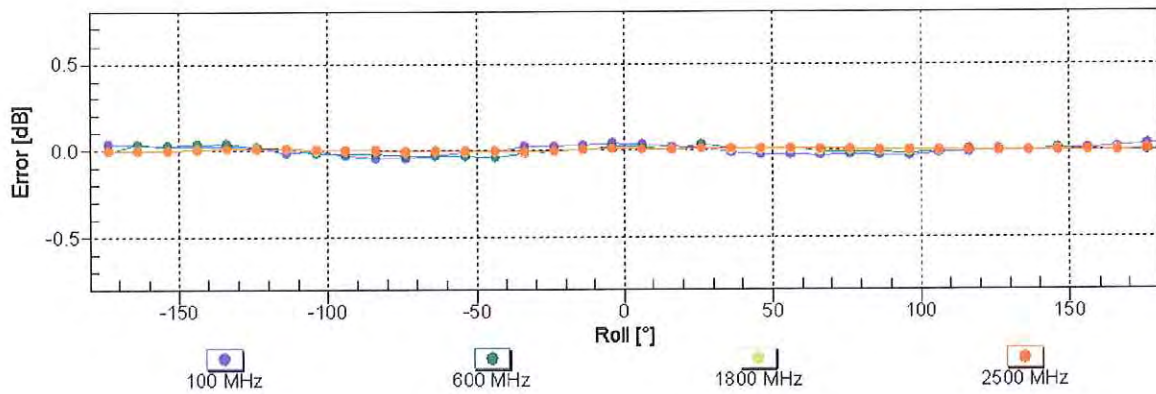
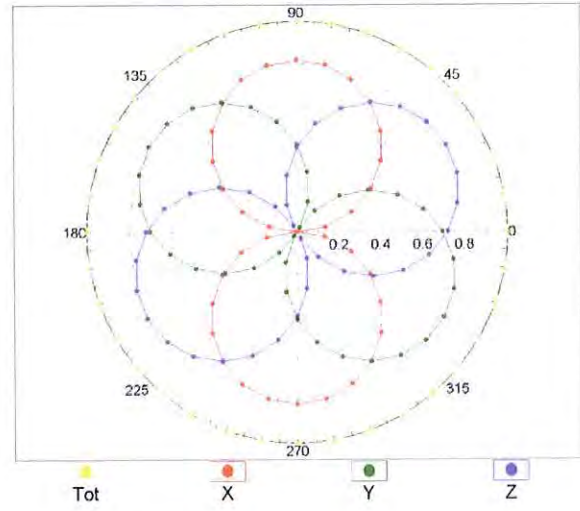

Uncertainty of Axial Isotropy Assessment: $\pm 0.5\%$ ($k=2$)

Dynamic Range $f(\text{SAR}_{\text{head}})$ (TEM cell , $f = 900 \text{ MHz}$)

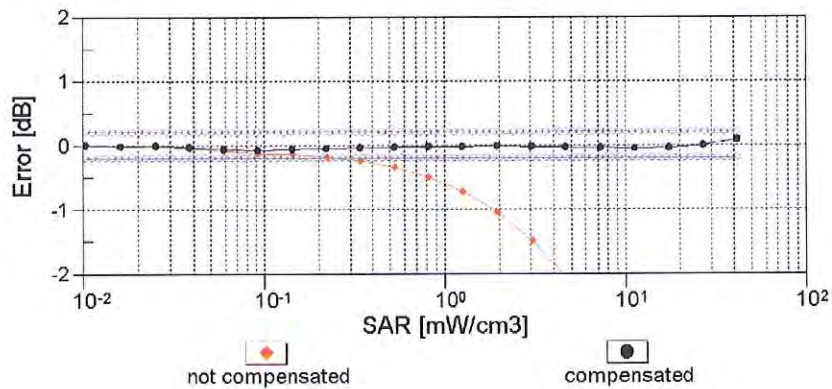
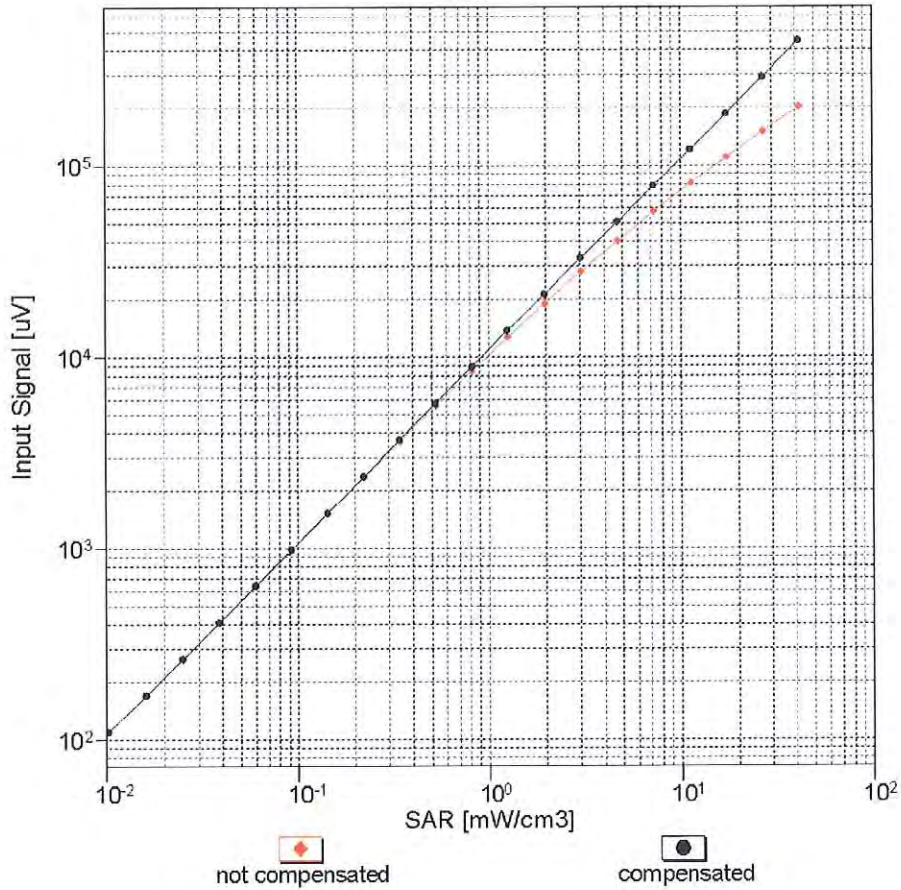

Uncertainty of Linearity Assessment: $\pm 0.6\%$ ($k=2$)

Conversion Factor Assessment

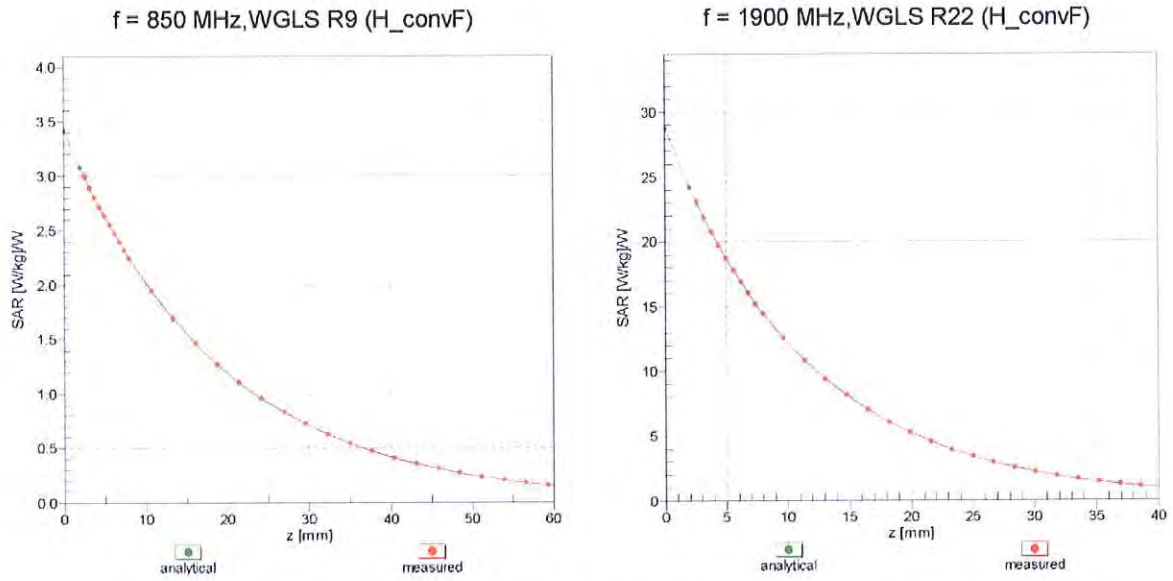

Deviation from Isotropy in Liquid Error (ϕ, ϑ), f = 900 MHz

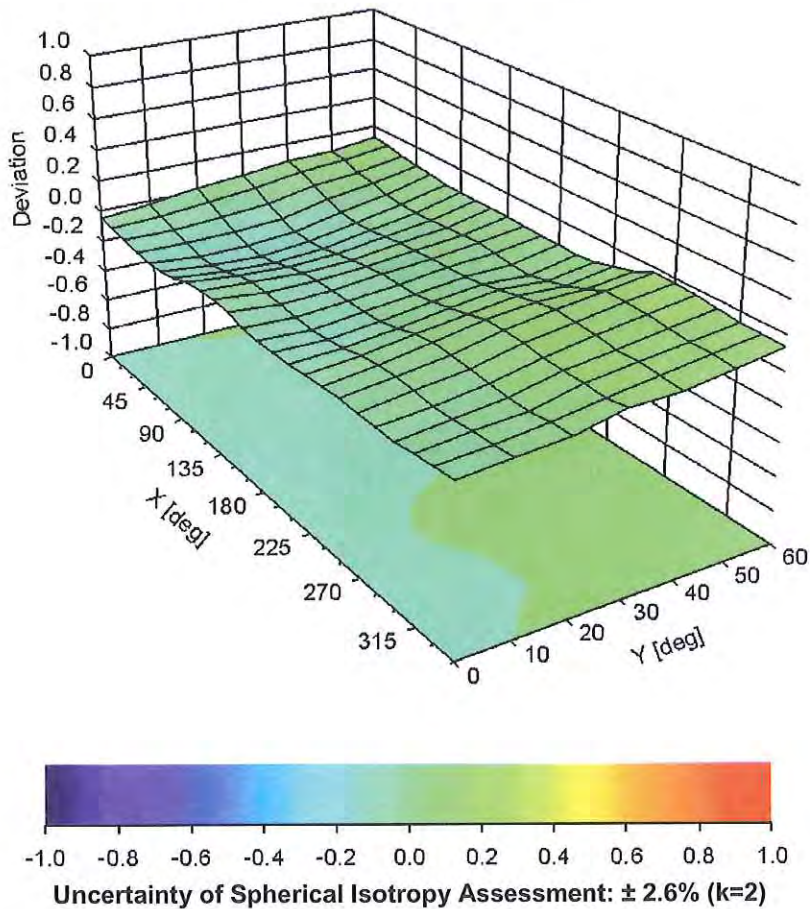

DASY/EASY - Parameters of Probe: ES3DV3 - SN:3332

Other Probe Parameters

Sensor Arrangement	Triangular
Connector Angle (°)	-3.9
Mechanical Surface Detection Mode	enabled
Optical Surface Detection Mode	disabled
Probe Overall Length	337 mm
Probe Body Diameter	10 mm
Tip Length	10 mm
Tip Diameter	4 mm
Probe Tip to Sensor X Calibration Point	2 mm
Probe Tip to Sensor Y Calibration Point	2 mm
Probe Tip to Sensor Z Calibration Point	2 mm
Recommended Measurement Distance from Surface	3 mm

Calibration Laboratory of
Schmid & Partner
Engineering AG
Zeughausstrasse 43, 8004 Zurich, Switzerland



SCS Schweizerischer Kalibrierdienst
Service suisse d'étalonnage
Servizio svizzero di taratura
Swiss Calibration Service

Accredited by the Swiss Accreditation Service (SAS)
The Swiss Accreditation Service is one of the signatories to the EA
Multilateral Agreement for the recognition of calibration certificates

Accreditation No.: **SCS 108**

Client **PC Test**

Certificate No: **EX3-3914_Oct13**

CALIBRATION CERTIFICATE

Object **EX3DV4 - SN:3914**

Calibration procedure(s) **DIA CAL-01 v3, GA CAL-14 v4, GA CAL-23 v5, DIA CAL-25 v6
Calibration procedure for dielectric E-field probes**

Calibration date: **October 23, 2013** VCC
11/20/2013

This calibration certificate documents the traceability to national standards, which realize the physical units of measurements (SI).
The measurements and the uncertainties with confidence probability are given on the following pages and are part of the certificate.

All calibrations have been conducted in the closed laboratory facility: environment temperature (22 ± 3)°C and humidity < 70%.

Calibration Equipment used (M&TE critical for calibration)

Primary Standards	ID	Cal Date (Certificate No.)	Scheduled Calibration
Power meter E4419B	GB41293874	04-Apr-13 (No. 217-01733)	Apr-14
Power sensor E4412A	MY41498087	04-Apr-13 (No. 217-01733)	Apr-14
Reference 3 dB Attenuator	SN: S5054 (3c)	04-Apr-13 (No. 217-01737)	Apr-14
Reference 20 dB Attenuator	SN: S5277 (20x)	04-Apr-13 (No. 217-01735)	Apr-14
Reference 30 dB Attenuator	SN: S5129 (30b)	04-Apr-13 (No. 217-01738)	Apr-14
Reference Probe ES3DV2	SN: 3013	28-Dec-12 (No. ES3-3013_Dec12)	Dec-13
DAE4	SN: 660	4-Sep-13 (No. DAE4-660_Sep13)	Sep-14
Secondary Standards	ID	Check Date (in house)	Scheduled Check
RF generator HP 8648C	US3642U01700	4-Aug-99 (in house check Apr-13)	In house check: Apr-15
Network Analyzer HP 8753E	US37390585	18-Oct-01 (in house check Oct-13)	In house check: Oct-14

Calibrated by:	Name Leif Klysner	Function Laboratory Technician	Signature
Approved by:	Name Katja Pokovic	Function Technical Manager	

Issued: October 25, 2013

This calibration certificate shall not be reproduced except in full without written approval of the laboratory.

PCT # 81072



Accredited by the Swiss Accreditation Service (SAS)
 The Swiss Accreditation Service is one of the signatories to the EA
 Multilateral Agreement for the recognition of calibration certificates

Accreditation No.: **SCS 108**

Glossary:

TSL	tissue simulating liquid
NORM _{x,y,z}	sensitivity in free space
ConvF	sensitivity in TSL / NORM _{x,y,z}
DCP	diode compression point
CF	crest factor (1/duty_cycle) of the RF signal
A, B, C, D	modulation dependent linearization parameters
Polarization φ	φ rotation around probe axis
Polarization ϑ	ϑ rotation around an axis that is in the plane normal to probe axis (at measurement center), i.e., $\vartheta = 0$ is normal to probe axis
Connector Angle	information used in DASY system to align probe sensor X to the robot coordinate system

Calibration is Performed According to the Following Standards:

- a) IEEE Std 1528-2013, "IEEE Recommended Practice for Determining the Peak Spatial-Averaged Specific Absorption Rate (SAR) in the Human Head from Wireless Communications Devices: Measurement Techniques", June 2013
- b) IEC 62209-1, "Procedure to measure the Specific Absorption Rate (SAR) for hand-held devices used in close proximity to the ear (frequency range of 300 MHz to 3 GHz)", February 2005

Methods Applied and Interpretation of Parameters:

- *NORM_{x,y,z}*: Assessed for E-field polarization $\vartheta = 0$ ($f \leq 900$ MHz in TEM-cell; $f > 1800$ MHz: R22 waveguide). *NORM_{x,y,z}* are only intermediate values, i.e., the uncertainties of *NORM_{x,y,z}* does not affect the E^2 -field uncertainty inside TSL (see below *ConvF*).
- *NORM(f)_{x,y,z}* = *NORM_{x,y,z}* * *frequency_response* (see Frequency Response Chart). This linearization is implemented in DASY4 software versions later than 4.2. The uncertainty of the frequency response is included in the stated uncertainty of *ConvF*.
- *DCP_{x,y,z}*: DCP are numerical linearization parameters assessed based on the data of power sweep with CW signal (no uncertainty required). DCP does not depend on frequency nor media.
- *PAR*: PAR is the Peak to Average Ratio that is not calibrated but determined based on the signal characteristics
- *A_{x,y,z}*; *B_{x,y,z}*; *C_{x,y,z}*; *D_{x,y,z}*; *VR_{x,y,z}*; *A, B, C, D* are numerical linearization parameters assessed based on the data of power sweep for specific modulation signal. The parameters do not depend on frequency nor media. *VR* is the maximum calibration range expressed in RMS voltage across the diode.
- *ConvF* and *Boundary Effect Parameters*: Assessed in flat phantom using E-field (or Temperature Transfer Standard for $f \leq 800$ MHz) and inside waveguide using analytical field distributions based on power measurements for $f > 800$ MHz. The same setups are used for assessment of the parameters applied for boundary compensation (alpha, depth) of which typical uncertainty values are given. These parameters are used in DASY4 software to improve probe accuracy close to the boundary. The sensitivity in TSL corresponds to *NORM_{x,y,z}* * *ConvF* whereby the uncertainty corresponds to that given for *ConvF*. A frequency dependent *ConvF* is used in DASY version 4.4 and higher which allows extending the validity from ± 50 MHz to ± 100 MHz.
- *Spherical isotropy (3D deviation from isotropy)*: in a field of low gradients realized using a flat phantom exposed by a patch antenna.
- *Sensor Offset*: The sensor offset corresponds to the offset of virtual measurement center from the probe tip (on probe axis). No tolerance required.
- *Connector Angle*: The angle is assessed using the information gained by determining the *NORM_x* (no uncertainty required).

Probe EX3DV4

SN:3914

Manufactured: December 18, 2012
Calibrated: October 23, 2013

Calibrated for DASY/EASY Systems
(Note: non-compatible with DASY2 system!)

DASY/EASY - Parameters of Probe: EX3DV4 - SN:3914

Basic Calibration Parameters

	Sensor X	Sensor Y	Sensor Z	Unc (k=2)
Norm ($\mu\text{V}/(\text{V}/\text{m})^2$) ^A	0.47	0.49	0.51	$\pm 10.1 \%$
DCP (mV) ^B	99.2	98.9	98.2	

Modulation Calibration Parameters

UID	Communication System Name		A dB	B dB $\sqrt{\mu\text{V}}$	C	D dB	VR mV	Unc ^E (k=2)
0	CW	X	0.0	0.0	1.0	0.00	158.3	$\pm 3.0 \%$
		Y	0.0	0.0	1.0		154.6	
		Z	0.0	0.0	1.0		170.8	
10010- CAA	SAR Validation (Square, 100ms, 10ms)	X	0.71	53.3	6.1	10.00	48.4	$\pm 2.5 \%$
		Y	2.43	67.0	13.8		39.9	
		Z	4.18	68.7	13.8		45.7	
10011- CAA	UMTS-FDD (WCDMA)	X	3.05	64.4	16.5	2.91	122.4	$\pm 0.5 \%$
		Y	3.31	66.5	18.2		123.5	
		Z	3.34	66.3	17.8		136.6	
10012- CAA	IEEE 802.11b WiFi 2.4 GHz (DSSS, 1 Mbps)	X	2.49	64.8	16.1	1.87	120.6	$\pm 0.5 \%$
		Y	2.94	68.6	18.7		123.6	
		Z	2.63	65.9	17.0		135.4	
10021- DAA	GSM-FDD (TDMA, GMSK)	X	1.52	61.5	10.9	9.39	83.6	$\pm 1.2 \%$
		Y	2.22	67.4	15.0		116.0	
		Z	2.47	66.8	14.7		95.9	
10023- DAA	GPRS-FDD (TDMA, GMSK, TN 0)	X	1.73	63.3	11.9	9.57	81.5	$\pm 1.7 \%$
		Y	2.11	66.2	14.2		111.8	
		Z	2.76	69.0	16.0		93.6	
10024- DAA	GPRS-FDD (TDMA, GMSK, TN 0-1)	X	1.34	62.1	9.4	6.56	121.0	$\pm 1.2 \%$
		Y	4.24	78.6	17.9		130.0	
		Z	2.91	70.7	14.9		141.4	
10027- DAA	GPRS-FDD (TDMA, GMSK, TN 0-1-2)	X	1.25	63.5	9.7	4.80	143.5	$\pm 1.4 \%$
		Y	1.59	66.9	12.2		149.7	
		Z	2.98	71.5	14.0		123.3	
10028- DAA	GPRS-FDD (TDMA, GMSK, TN 0-1-2-3)	X	0.51	58.3	7.4	3.55	113.4	$\pm 1.2 \%$
		Y	25.43	100.0	22.6		121.3	
		Z	38.67	97.5	20.6		133.3	
10032- CAA	IEEE 802.15.1 Bluetooth (GFSK, DH5)	X	0.28	58.6	5.3	1.16	134.7	$\pm 0.9 \%$
		Y	65.75	99.6	18.6		141.3	
		Z	0.20	55.6	4.1		112.1	
10039- CAA	CDMA2000 (1xRTT, RC1)	X	4.33	64.6	17.4	4.57	113.8	$\pm 0.7 \%$
		Y	4.55	66.0	18.6		120.8	
		Z	4.85	66.2	18.4		135.9	
10062- CAA	IEEE 802.11a/h WiFi 5 GHz (OFDM, 6 Mbps)	X	9.83	67.6	20.7	8.68	109.0	$\pm 2.5 \%$
		Y	10.06	68.4	21.5		118.2	
		Z	10.66	69.2	21.7		134.0	

10081-CAA	CDMA2000 (1xRTT, RC3)	X	3.59	63.9	16.9	3.97	113.6	±0.7 %
		Y	3.84	65.6	18.2		119.6	
		Z	3.95	65.4	17.8		134.5	
10098-CAA	UMTS-FDD (HSUPA, Subtest 2)	X	4.41	65.2	17.3	3.98	126.0	±0.7 %
		Y	4.73	66.9	18.6		132.5	
		Z	4.51	65.5	17.7		105.6	
10100-CAB	LTE-FDD (SC-FDMA, 100% RB, 20 MHz, QPSK)	X	6.26	66.2	18.6	5.67	130.5	±1.2 %
		Y	6.61	67.7	19.8		139.3	
		Z	6.21	66.0	18.7		107.7	
10108-CAB	LTE-FDD (SC-FDMA, 100% RB, 10 MHz, QPSK)	X	6.13	65.8	18.6	5.80	126.3	±1.2 %
		Y	6.40	67.1	19.6		135.6	
		Z	6.10	65.5	18.5		107.4	
10110-CAB	LTE-FDD (SC-FDMA, 100% RB, 5 MHz, QPSK)	X	5.78	65.3	18.3	5.75	123.1	±1.2 %
		Y	5.97	66.3	19.2		131.5	
		Z	5.86	65.3	18.4		104.9	
10114-CAA	IEEE 802.11n (HT Greenfield, 13.5 Mbps, BPSK)	X	9.92	67.7	20.3	8.10	115.7	±2.5 %
		Y	10.25	68.7	21.2		126.8	
		Z	10.71	69.4	21.3		146.0	
10117-CAA	IEEE 802.11n (HT Mixed, 13.5 Mbps, BPSK)	X	9.95	67.8	20.3	8.07	116.6	±2.5 %
		Y	10.26	68.7	21.1		128.3	
		Z	10.70	69.4	21.3		146.9	
10151-CAB	LTE-TDD (SC-FDMA, 50% RB, 20 MHz, QPSK)	X	7.19	67.3	21.5	9.28	145.0	±2.2 %
		Y	7.40	68.3	22.4		110.8	
		Z	7.79	68.4	22.0		128.0	
10154-CAB	LTE-FDD (SC-FDMA, 50% RB, 10 MHz, QPSK)	X	5.79	65.3	18.3	5.75	124.2	±1.2 %
		Y	6.03	66.5	19.4		131.9	
		Z	6.29	66.9	19.3		149.7	
10160-CAB	LTE-FDD (SC-FDMA, 50% RB, 15 MHz, QPSK)	X	6.23	65.9	18.6	5.82	128.3	±1.2 %
		Y	6.51	67.2	19.7		136.9	
		Z	6.24	65.7	18.6		107.3	
10169-CAB	LTE-FDD (SC-FDMA, 1 RB, 20 MHz, QPSK)	X	4.83	66.0	18.9	5.73	147.5	±1.2 %
		Y	4.72	65.8	19.2		113.8	
		Z	5.03	66.1	19.1		129.7	
10172-CAB	LTE-TDD (SC-FDMA, 1 RB, 20 MHz, QPSK)	X	5.83	69.2	22.8	9.21	149.9	±1.9 %
		Y	5.81	69.4	23.4		120.3	
		Z	6.38	70.0	23.2		137.2	
10175-CAB	LTE-FDD (SC-FDMA, 1 RB, 10 MHz, QPSK)	X	4.86	66.1	18.9	5.72	149.8	±1.2 %
		Y	4.72	65.8	19.2		113.3	
		Z	5.09	66.4	19.1		126.0	
10181-CAB	LTE-FDD (SC-FDMA, 1 RB, 15 MHz, QPSK)	X	4.83	66.0	18.9	5.72	146.3	±1.2 %
		Y	4.69	65.6	19.1		112.2	
		Z	5.02	66.1	19.0		125.1	
10193-CAA	IEEE 802.11n (HT Greenfield, 6.5 Mbps, BPSK)	X	9.51	67.4	20.2	8.09	108.6	±2.5 %
		Y	9.72	68.1	20.9		118.2	
		Z	10.30	68.9	21.1		135.0	

10196-CAA	IEEE 802.11n (HT Mixed, 6.5 Mbps, BPSK)	X	9.52	67.4	20.2	8.10	111.6	±2.5 %
		Y	9.79	68.3	21.1		121.3	
		Z	10.30	68.9	21.2		139.2	
10219-CAA	IEEE 802.11n (HT Mixed, 7.2 Mbps, BPSK)	X	9.47	67.4	20.2	8.03	111.8	±2.2 %
		Y	9.67	68.3	21.0		120.0	
		Z	10.20	68.9	21.1		138.0	
10222-CAA	IEEE 802.11n (HT Mixed, 15 Mbps, BPSK)	X	9.96	67.9	20.4	8.06	118.4	±2.5 %
		Y	10.25	68.8	21.2		128.2	
		Z	10.65	69.3	21.3		144.5	
10225-CAA	UMTS-FDD (HSPA+)	X	6.96	66.7	18.9	5.97	140.0	±1.4 %
		Y	7.23	67.9	20.0		148.9	
		Z	7.03	66.4	18.9		115.6	
10237-CAB	LTE-TDD (SC-FDMA, 1 RB, 10 MHz, QPSK)	X	5.51	67.5	21.8	9.21	114.2	±1.9 %
		Y	5.82	69.4	23.4		123.0	
		Z	6.49	70.6	23.6		140.2	
10252-CAB	LTE-TDD (SC-FDMA, 50% RB, 10 MHz, QPSK)	X	6.83	67.1	21.4	9.24	136.6	±1.9 %
		Y	7.30	69.4	23.2		147.3	
		Z	7.36	68.1	22.0		117.5	
10267-CAB	LTE-TDD (SC-FDMA, 100% RB, 10 MHz, QPSK)	X	7.26	67.5	21.6	9.30	142.7	±1.9 %
		Y	7.44	68.4	22.4		110.5	
		Z	7.84	68.7	22.2		122.6	
10274-CAA	UMTS-FDD (HSUPA, Subtest 5, 3GPP Rel8.10)	X	5.86	66.2	18.2	4.87	135.4	±0.9 %
		Y	6.12	67.5	19.2		142.3	
		Z	5.91	65.9	18.2		107.6	
10275-CAA	UMTS-FDD (HSUPA, Subtest 5, 3GPP Rel8.4)	X	4.17	64.8	17.3	3.96	115.6	±0.7 %
		Y	4.42	66.4	18.5		124.6	
		Z	4.47	66.0	18.0		132.6	
10291-AAA	CDMA2000, RC3, SO55, Full Rate	X	3.36	64.7	17.1	3.46	109.4	±0.5 %
		Y	3.55	66.2	18.3		118.2	
		Z	3.60	65.6	17.7		120.9	
10292-AAA	CDMA2000, RC3, SO32, Full Rate	X	3.34	64.9	17.2	3.39	110.1	±0.5 %
		Y	3.57	66.7	18.5		121.0	
		Z	3.54	65.6	17.7		123.9	
10297-AAA	LTE-FDD (SC-FDMA, 50% RB, 20 MHz, QPSK)	X	6.14	65.8	18.6	5.81	125.1	±1.2 %
		Y	6.44	67.2	19.7		135.7	
		Z	6.52	67.0	19.3		142.2	
10311-AAA	LTE-FDD (SC-FDMA, 100% RB, 15 MHz, QPSK)	X	6.76	66.6	19.1	6.06	131.8	±1.4 %
		Y	7.03	67.8	20.0		142.5	
		Z	7.15	67.7	19.7		148.6	
10315-AAA	IEEE 802.11b WiFi 2.4 GHz (DSSS, 1 Mbps, 96pc duty cycle)	X	2.42	64.6	16.1	1.71	116.8	±0.5 %
		Y	3.00	69.3	19.0		126.9	
		Z	2.61	66.3	17.2		128.2	
10317-AAA	IEEE 802.11a WiFi 5 GHz (OFDM, 6 Mbps, 96pc duty cycle)	X	9.71	67.6	20.5	8.36	111.7	±2.5 %
		Y	9.99	68.6	21.4		122.2	
		Z	10.38	68.9	21.3		129.5	

10400-AAA	IEEE 802.11ac WiFi (20MHz, 64-QAM, 99pc duty cycle)	X	9.83	67.8	20.6	8.37	112.9	±2.5 %
		Y	10.09	68.7	21.4		123.9	
		Z	10.48	68.9	21.3		130.5	
10402-AAA	IEEE 802.11ac WiFi (80MHz, 64-QAM, 99pc duty cycle)	X	10.61	68.3	20.7	8.53	121.1	±2.5 %
		Y	11.25	70.0	21.9		135.4	
		Z	11.15	69.4	21.4		137.4	
10403-AAA	CDMA2000 (1xEV-DO, Rev. 0)	X	4.51	67.4	17.8	3.76	119.2	±0.5 %
		Y	4.91	69.5	19.3		128.3	
		Z	4.84	67.5	18.1		135.4	
10404-AAA	CDMA2000 (1xEV-DO, Rev. A)	X	4.51	67.7	18.0	3.77	117.4	±0.5 %
		Y	4.92	69.8	19.5		125.4	
		Z	4.71	67.3	18.0		131.9	

The reported uncertainty of measurement is stated as the standard uncertainty of measurement multiplied by the coverage factor $k=2$, which for a normal distribution corresponds to a coverage probability of approximately 95%.

^A The uncertainties of NormX,Y,Z do not affect the E^2 -field uncertainty inside TSL (see Pages 8 and 9).

^B Numerical linearization parameter: uncertainty not required.

^E Uncertainty is determined using the max. deviation from linear response applying rectangular distribution and is expressed for the square of the field value.

DASY/EASY - Parameters of Probe: EX3DV4 - SN:3914

Calibration Parameter Determined in Head Tissue Simulating Media

f (MHz) ^C	Relative Permittivity ^F	Conductivity (S/m) ^F	ConvF X	ConvF Y	ConvF Z	Alpha ^G	Depth ^G (mm)	Unct. (k=2)
750	41.9	0.89	9.70	9.70	9.70	0.34	1.01	± 12.0 %
835	41.5	0.90	9.34	9.34	9.34	0.67	0.67	± 12.0 %
1750	40.1	1.37	7.99	7.99	7.99	0.79	0.56	± 12.0 %
1900	40.0	1.40	7.69	7.69	7.69	0.80	0.58	± 12.0 %
2450	39.2	1.80	6.95	6.95	6.95	0.41	0.77	± 12.0 %
2600	39.0	1.96	6.79	6.79	6.79	0.40	0.82	± 12.0 %
5200	36.0	4.66	4.99	4.99	4.99	0.30	1.80	± 13.1 %
5300	35.9	4.76	4.82	4.82	4.82	0.30	1.80	± 13.1 %
5500	35.6	4.96	4.55	4.55	4.55	0.35	1.80	± 13.1 %
5600	35.5	5.07	4.37	4.37	4.37	0.35	1.80	± 13.1 %
5800	35.3	5.27	4.52	4.52	4.52	0.35	1.80	± 13.1 %

^C Frequency validity of ± 100 MHz only applies for DASY v4.4 and higher (see Page 2), else it is restricted to ± 50 MHz. The uncertainty is the RSS of the ConvF uncertainty at calibration frequency and the uncertainty for the indicated frequency band.

^F At frequencies below 3 GHz, the validity of tissue parameters (ϵ and σ) can be relaxed to ± 10% if liquid compensation formula is applied to measured SAR values. At frequencies above 3 GHz, the validity of tissue parameters (ϵ and σ) is restricted to ± 5%. The uncertainty is the RSS of the ConvF uncertainty for indicated target tissue parameters.

^G Alpha/Depth are determined during calibration. SPEAG warrants that the remaining deviation due to the boundary effect after compensation is always less than ± 1% for frequencies below 3 GHz and below ± 2% for frequencies between 3-6 GHz at any distance larger than half the probe tip diameter from the boundary.

DASY/EASY - Parameters of Probe: EX3DV4 - SN:3914

Calibration Parameter Determined in Body Tissue Simulating Media

f (MHz) ^C	Relative Permittivity ^F	Conductivity (S/m) ^F	ConvF X	ConvF Y	ConvF Z	Alpha ^G	Depth ^G (mm)	Unct. (k=2)
750	55.5	0.96	9.39	9.39	9.39	0.63	0.74	± 12.0 %
835	55.2	0.97	9.31	9.31	9.31	0.56	0.76	± 12.0 %
1750	53.4	1.49	7.89	7.89	7.89	0.32	1.03	± 12.0 %
1900	53.3	1.52	7.51	7.51	7.51	0.51	0.76	± 12.0 %
2450	52.7	1.95	7.02	7.02	7.02	0.80	0.50	± 12.0 %
2600	52.5	2.16	6.81	6.81	6.81	0.80	0.50	± 12.0 %
5200	49.0	5.30	4.52	4.52	4.52	0.35	1.90	± 13.1 %
5300	48.9	5.42	4.32	4.32	4.32	0.35	1.90	± 13.1 %
5500	48.6	5.65	4.07	4.07	4.07	0.35	1.90	± 13.1 %
5600	48.5	5.77	3.97	3.97	3.97	0.35	1.90	± 13.1 %
5800	48.2	6.00	4.14	4.14	4.14	0.40	1.90	± 13.1 %

^C Frequency validity of ± 100 MHz only applies for DASY v4.4 and higher (see Page 2), else it is restricted to ± 50 MHz. The uncertainty is the RSS of the ConvF uncertainty at calibration frequency and the uncertainty for the indicated frequency band.

^F At frequencies below 3 GHz, the validity of tissue parameters (ϵ and σ) can be relaxed to ± 10% if liquid compensation formula is applied to measured SAR values. At frequencies above 3 GHz, the validity of tissue parameters (ϵ and σ) is restricted to ± 5%. The uncertainty is the RSS of the ConvF uncertainty for indicated target tissue parameters.

^G Alpha/Depth are determined during calibration. SPEAG warrants that the remaining deviation due to the boundary effect after compensation is always less than ± 1% for frequencies below 3 GHz and below ± 2% for frequencies between 3-6 GHz at any distance larger than half the probe tip diameter from the boundary.

Frequency Response of E-Field

(TEM-Cell:ifi110 EXX, Waveguide: R22)

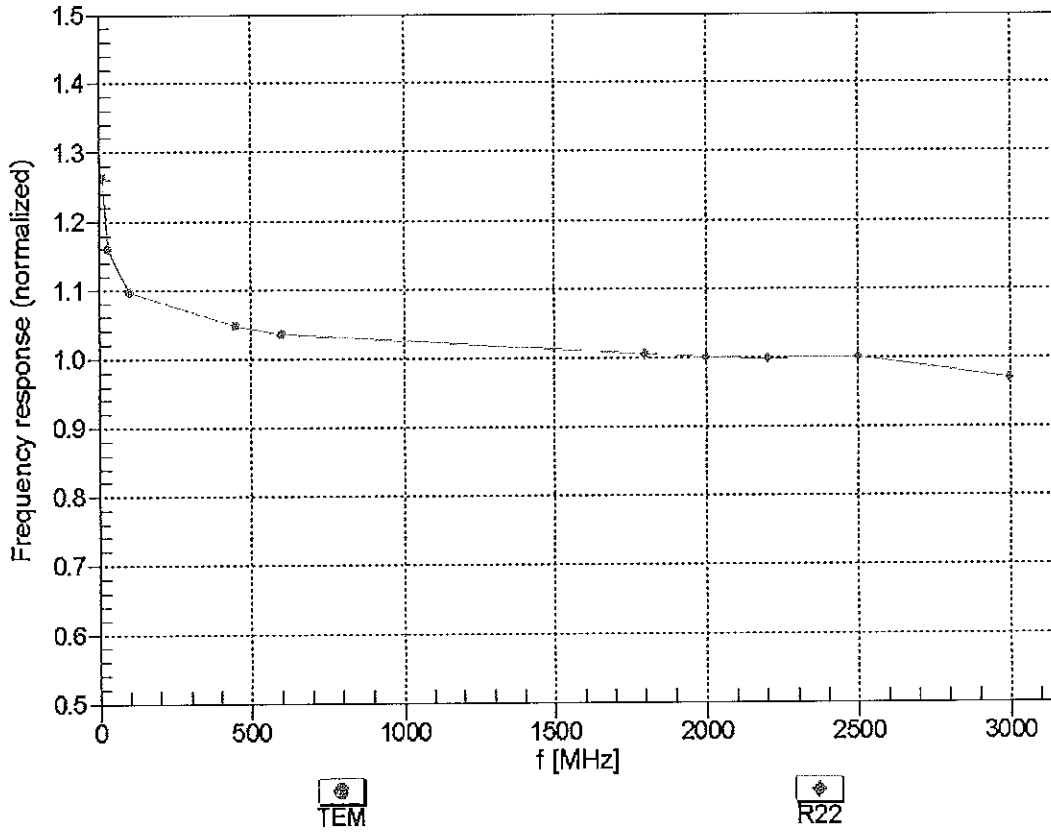

Uncertainty of Frequency Response of E-field: $\pm 6.3\%$ (k=2)

Receiving Pattern (ϕ), $\theta = 0^\circ$

f=600 MHz,TEM

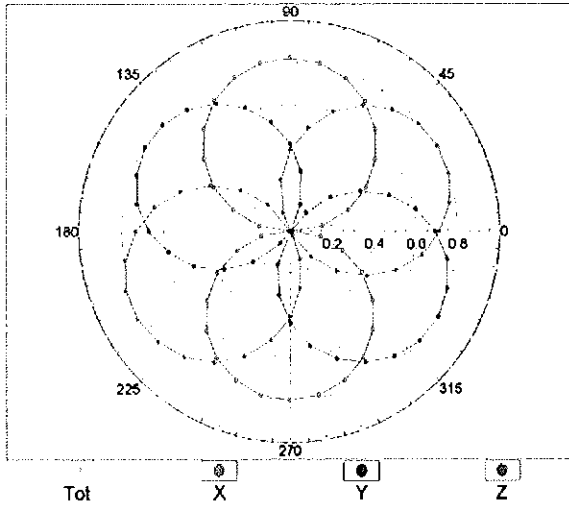

f=1800 MHz,R22

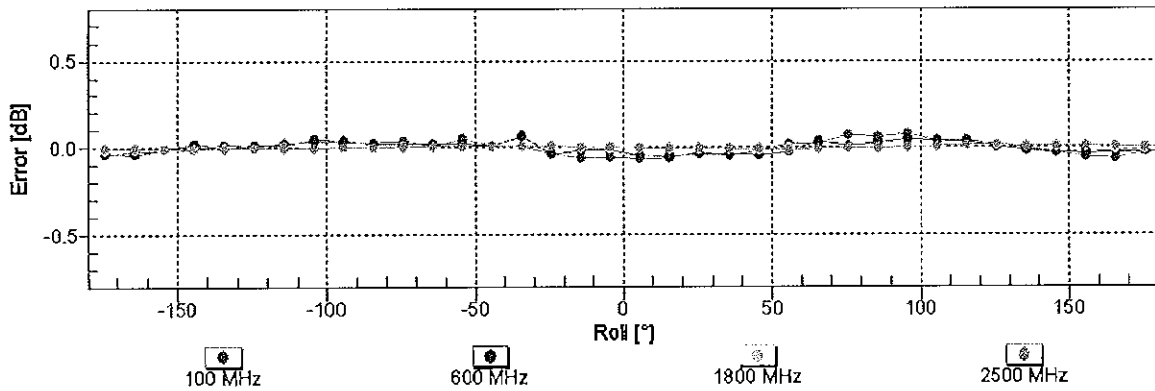
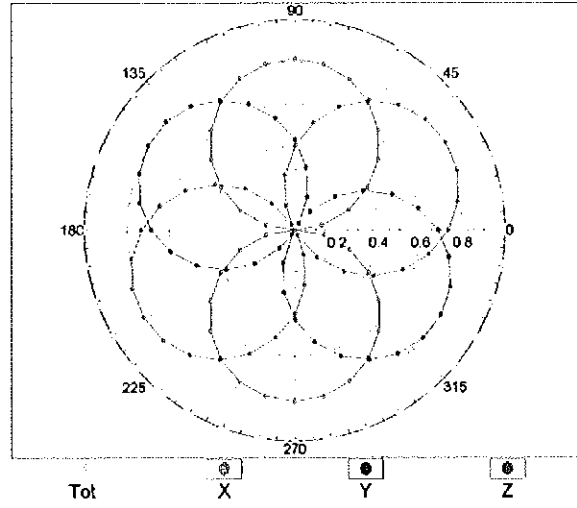

Uncertainty of Axial Isotropy Assessment: $\pm 0.5\%$ (k=2)

Dynamic Range $f(\text{SAR}_{\text{head}})$ (TEM cell , $f = 900 \text{ MHz}$)

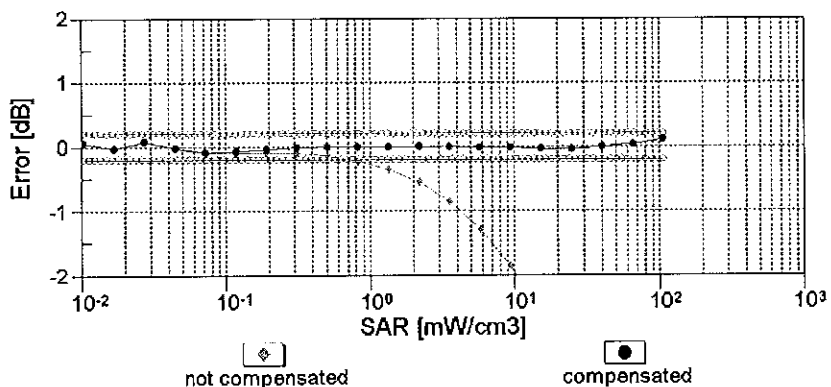
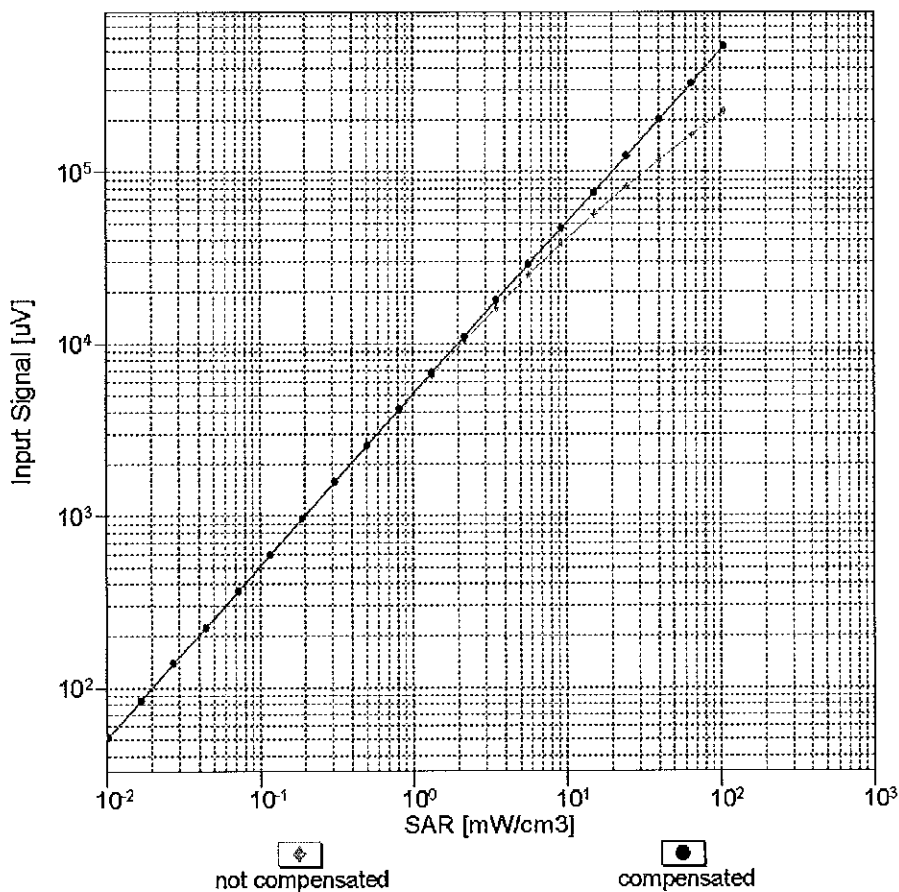

Uncertainty of Linearity Assessment: $\pm 0.6\%$ ($k=2$)

Conversion Factor Assessment

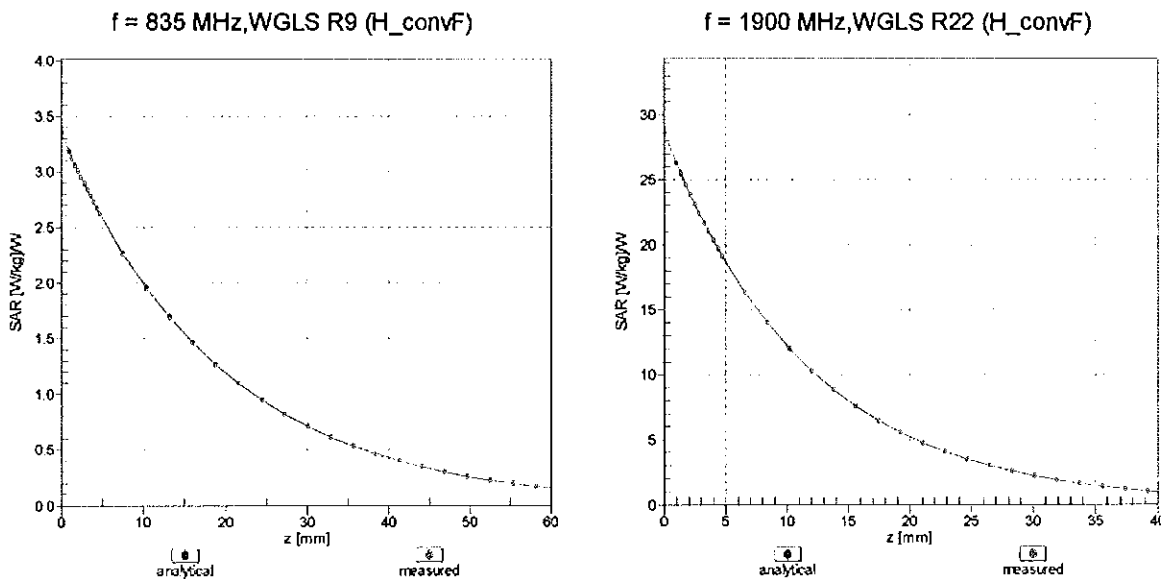

Deviation from Isotropy in Liquid

Error (ϕ, θ), f = 900 MHz

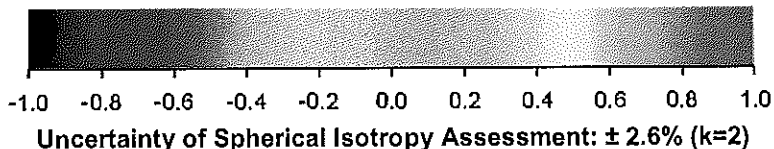
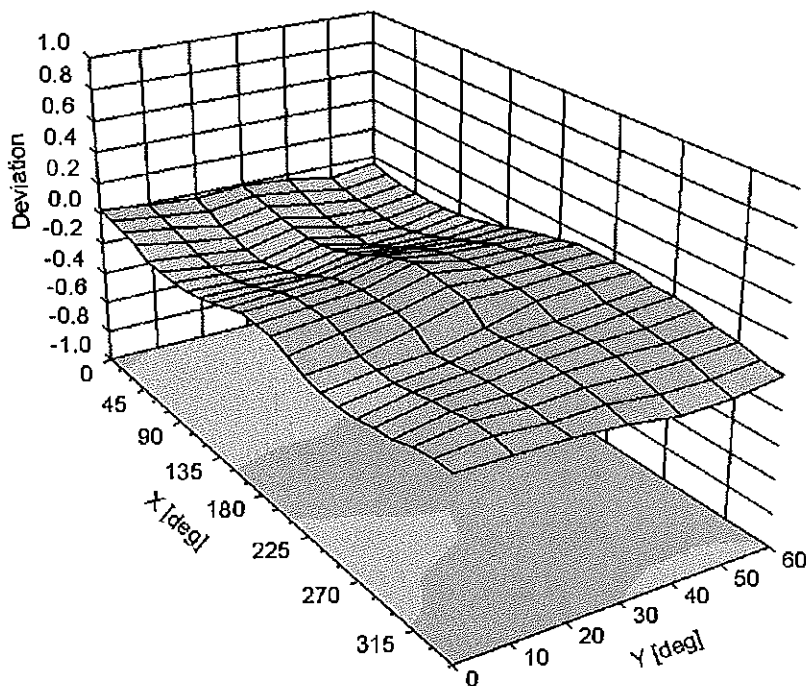

DASY/EASY - Parameters of Probe: EX3DV4 - SN:3914**Other Probe Parameters**

Sensor Arrangement	Triangular
Connector Angle (°)	-24.3
Mechanical Surface Detection Mode	enabled
Optical Surface Detection Mode	disabled
Probe Overall Length	337 mm
Probe Body Diameter	10 mm
Tip Length	9 mm
Tip Diameter	2.5 mm
Probe Tip to Sensor X Calibration Point	1 mm
Probe Tip to Sensor Y Calibration Point	1 mm
Probe Tip to Sensor Z Calibration Point	1 mm
Recommended Measurement Distance from Surface	2 mm

APPENDIX D: SAR TISSUE SPECIFICATIONS

Measurement Procedure for Tissue verification:



- 1) The network analyzer and probe system was configured and calibrated.
- 2) The probe was immersed in the tissue. The tissue was placed in a nonmetallic container. Trapped air bubbles beneath the flange were minimized by placing the probe at a slight angle.
- 3) The complex admittance with respect to the probe aperture was measured
- 4) The complex relative permittivity ϵ can be calculated from the below equation (Pournaropoulos and Misra):

$$Y = \frac{j2\omega\epsilon_r\epsilon_0}{[\ln(b/a)]^2} \int_a^b \int_a^b \int_0^\pi \cos\phi' \frac{\exp[-j\omega r(\mu_0\epsilon_r'\epsilon_0)^{1/2}]}{r} d\phi' d\rho' d\rho$$

where Y is the admittance of the probe in contact with the sample, the primed and unprimed coordinates refer to source and observation points, respectively, $r^2 = \rho^2 + \rho'^2 - 2\rho\rho' \cos\phi'$, ω is the angular frequency, and $j = \sqrt{-1}$.

**Table D-I
Composition of the Tissue Equivalent Matter**

Frequency (MHz)	750	750	835	835	1750	1750	1900	1900	2450	2450
Tissue	Head	Body	Head	Body	Head	Body	Head	Body	Head	Body
Ingredients (% by weight)										
Bactericide	See Page 2, 3	See Page 2	0.1	0.1					See Page 4	
DGBE					47	31	44.92	29.44		26.7
HEC			1	1						
NaCl			1.45	0.94	0.4	0.2	0.18	0.39		0.1
Sucrose			57	44.9						
Water			40.45	53.06	52.6	68.8	54.9	70.17		73.2

FCC ID: A3LSMT705M		SAR EVALUATION REPORT		Reviewed by: Quality Manager
Test Dates: 04/30/14 - 05/14/14	DUT Type: Portable Tablet			APPENDIX D: Page 1 of 4

2 Composition / Information on ingredients

The Item is composed of the following ingredients:

H ₂ O	Water, 35 – 58%
Sucrose	Sugar, white, refined, 40 – 60%
NaCl	Sodium Chloride, 0 – 6%
Hydroxyethyl-cellulose	Medium Viscosity (CAS# 9004-62-0), <0.3%
Preventol-D7	Preservative: aqueous preparation, (CAS# 55965-84-9), containing 5-chloro-2-methyl-3(2H)-isothiazolone and 2-methyl-3(2H)-isothiazolone, 0.1 – 0.7%

Relevant for safety; Refer to the respective Safety Data Sheet*.

Figure D-1
Composition of 750 MHz Head and Body Tissue Equivalent Matter

Note: 750MHz liquid recipes are proprietary SPEAG. Since the composition is approximate to the actual liquids utilized, the manufacturer tissue-equivalent liquid data sheets are provided below.

Measurement Certificate / Material Test

Item Name	Body Tissue Simulating Liquid (MSL750V2)
Product No.	SL AAM 075 AA (Charge: 130313-1)
Manufacturer	SPEAG

Measurement Method

TSL dielectric parameters measured using calibrated OCP probe.

Setup Validation

Validation results were within ± 2.5% towards the target values of Methanol.

Target Parameters

Target parameters as defined in the IEEE 1528 and IEC 62209 compliance standards.

Test Condition

Ambient	Environment temperature (22 ± 3)°C and humidity < 70%.
TSL Temperature	22°C
Test Date	13-Mar-13
Operator	IEH

Additional Information

TSL Density	1.212 g/cm ³
TSL Heat-capacity	3.006 kJ/(kg*K)

f [MHz]	Measured			Target		Diff. to Target [%]	
	HP-e'	HP-e''	sigma	eps	sigma	Δ-eps	Δ-sigma
600	57.5	24.64	0.82	56.1	0.95	2.5	-13.6
625	57.2	24.31	0.84	56.0	0.95	2.1	-11.4
650	57.0	23.99	0.87	55.9	0.96	1.8	-9.2
675	56.7	23.69	0.89	55.8	0.96	1.5	-7.1
700	56.4	23.39	0.91	55.7	0.96	1.2	-5.1
725	56.2	23.18	0.93	55.6	0.96	1.0	-2.8
750	55.9	22.97	0.96	55.5	0.96	0.7	-0.5
775	55.7	22.78	0.98	55.4	0.97	0.4	1.7
800	55.4	22.60	1.01	55.3	0.97	0.1	4.0
825	55.2	22.44	1.03	55.2	0.98	-0.2	5.3
850	55.0	22.36	1.04	55.2	0.98	-0.3	5.9
875	54.9	22.28	1.05	55.2	0.99	-0.4	6.6
900	54.7	22.16	1.08	55.1	1.02	-0.7	5.8
925	54.5	22.03	1.10	55.0	1.05	-1.0	5.1
950	54.2	21.93	1.13	55.0	1.06	-1.3	6.2
975	54.0	21.82	1.15	54.9	1.08	-1.7	7.2
1000	53.8	21.74	1.18	54.9	1.09	-2.0	8.5
1000	53.6	21.66	1.21	54.8	1.10	-2.3	9.7

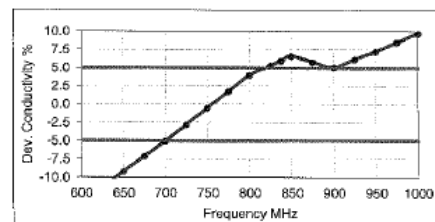
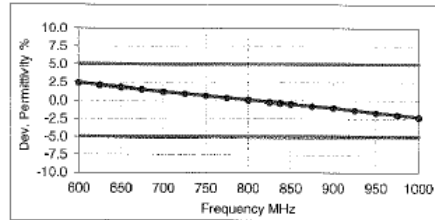



Figure D-2
750MHz Body Tissue Equivalent Matter

FCC ID: A3LSMT705M		SAR EVALUATION REPORT		Reviewed by: Quality Manager
Test Dates: 04/30/14 - 05/14/14	DUT Type: Portable Tablet			APPENDIX D: Page 2 of 4

Measurement Certificate / Material Test

Item Name	Head Tissue Simulating Liquid (HSL750V2)
Product No.	SL AAH 075 AA (Charge: 130312-4)
Manufacturer	SPEAG

Measurement Method

TSL dielectric parameters measured using calibrated OCP probe.

Setup Validation

Validation results were within $\pm 2.5\%$ towards the target values of Methanol.

Target Parameters

Target parameters as defined in the IEEE 1528 and IEC 62209 compliance standards.

Test Condition

Ambient	Environment temperatur (22 ± 3)°C and humidity < 70%.
TSL Temperature	22°C
Test Date	13-Mar-13
Operator	IEN

Additional Information

TSL Density	1.284 g/cm ³
TSL Heat-capacity	2.701 kJ/(kg*K)

f [MHz]	Measured			Target		Diff. to Target [%]	
	HP-e'	HP-e''	sigma	eps	sigma	Δ-eps	Δ-sigma
600	44.6	23.25	0.78	42.7	0.88	4.3	-12.0
625	44.2	23.00	0.80	42.6	0.88	3.8	-9.5
650	43.8	22.76	0.82	42.5	0.89	3.2	-7.1
675	43.4	22.50	0.84	42.3	0.89	2.6	-4.9
700	43.1	22.24	0.87	42.2	0.89	2.1	-2.6
725	42.7	22.06	0.89	42.1	0.89	1.6	-0.2
750	42.4	21.88	0.91	41.9	0.89	1.1	2.2
775	42.1	21.72	0.94	41.8	0.90	0.6	4.6
800	41.7	21.55	0.96	41.7	0.90	0.1	6.9
825	41.4	21.40	0.98	41.6	0.91	-0.4	8.3
838	41.3	21.32	0.99	41.5	0.91	-0.6	9.0
850	41.1	21.24	1.00	41.5	0.92	-0.9	9.6
875	40.8	21.11	1.03	41.5	0.94	-1.6	9.0
900	40.6	20.99	1.05	41.5	0.97	-2.3	8.3
925	40.3	20.87	1.07	41.5	0.98	-2.9	9.4
950	40.0	20.76	1.10	41.4	0.99	-3.5	10.3
975	39.7	20.66	1.12	41.4	1.00	-4.0	11.5
1000	39.5	20.57	1.14	41.3	1.01	-4.5	12.7

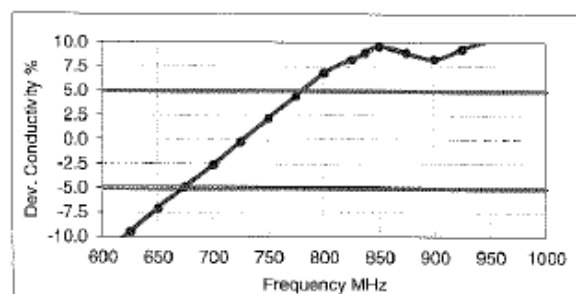
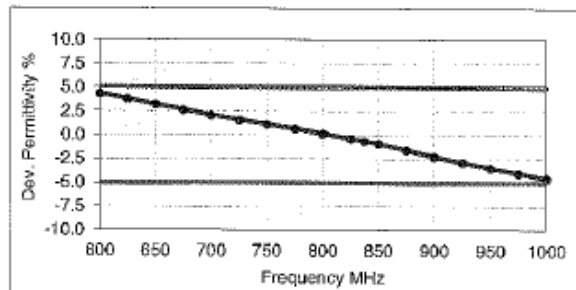



Figure D-3
750MHz Head Tissue Equivalent Matter

FCC ID: A3LSMT705M		SAR EVALUATION REPORT		Reviewed by: Quality Manager
Test Dates: 04/30/14 - 05/14/14	DUT Type: Portable Tablet			APPENDIX D: Page 3 of 4

2 Composition / Information on ingredients

The Item is composed of the following ingredients:

H2O	Water, 52 – 75%
C8H18O3	Diethylene glycol monobutyl ether (DGBE), 25 – 48% (CAS-No. 112-34-5, EC-No. 203-961-6, EC-index-No. 603-096-00-8) Relevant for safety; Refer to the respective Safety Data Sheet*.
NaCl	Sodium Chloride, <1.0%

Figure D-4
Composition of 2.4 GHz Head Tissue Equivalent Matter

Note: 2.4 GHz head liquid recipes are proprietary SPEAG. Since the composition is approximate to the actual liquids utilized, the manufacturer tissue-equivalent liquid data sheets are provided below.

Measurement Certificate / Material Test

Item Name	Head Tissue Simulating Liquid (HSL2450V2)
Product No.	SL AAH 245 BA (Charge: 130212-2)
Manufacturer	SPEAG

Measurement Method

TSL dielectric parameters measured using calibrated OCP probe.

Setup Validation

Validation results were within $\pm 2.5\%$ towards the target values of Methanol.

Target Parameters

Target parameters as defined in the IEEE 1528 and IEC 62209 compliance standards.

Test Condition

Ambient	Environment temperatur (22 ± 3)°C and humidity < 70%.
TSL Temperature	23°C
Test Date	13-Feb-13
Operator	DI

Additional Information

TSL Density	0.988 g/cm ³
TSL Heat-capacity	3.680 kJ/(kg*K)

f (MHz)	Measured			Target		Diff. to Target [%]	
	HP-e'	HP-e''	sigma	eps	sigma	Δ-eps	Δ-sigma
1900	40.4	11.94	1.26	40.0	1.40	1.0	-9.9
1925	40.3	12.02	1.29	40.0	1.40	0.7	-8.0
1950	40.2	12.11	1.31	40.0	1.40	0.5	-6.2
1975	40.1	12.20	1.34	40.0	1.40	0.2	-4.2
2000	40.0	12.29	1.37	40.0	1.40	-0.1	-2.3
2025	39.9	12.39	1.40	40.0	1.42	-0.2	-1.9
2050	39.8	12.49	1.42	39.9	1.44	-0.4	-1.4
2075	39.6	12.57	1.45	39.9	1.47	-0.6	-1.1
2100	39.5	12.65	1.48	39.8	1.49	-0.7	-0.7
2125	39.4	12.74	1.51	39.8	1.51	-0.9	-0.4
2150	39.3	12.82	1.53	39.7	1.53	-1.0	0.0
2175	39.2	12.89	1.56	39.7	1.56	-1.2	0.3
2200	39.1	12.97	1.59	39.6	1.58	-1.3	0.6
2225	39.0	13.04	1.61	39.6	1.60	-1.5	0.9
2250	38.9	13.11	1.64	39.6	1.62	-1.7	1.2
2275	38.8	13.20	1.67	39.5	1.64	-1.8	1.6
2300	38.7	13.28	1.70	39.5	1.67	-2.0	2.0
2325	38.6	13.35	1.73	39.4	1.69	-2.1	2.3
2350	38.5	13.42	1.75	39.4	1.71	-2.3	2.6
2375	38.4	13.50	1.78	39.3	1.73	-2.4	2.9
2400	38.3	13.58	1.81	39.3	1.76	-2.6	3.3
2425	38.2	13.65	1.84	39.2	1.78	-2.7	3.6
2450	38.1	13.73	1.87	39.2	1.80	-2.9	4.0
2475	38.0	13.79	1.90	39.2	1.83	-3.1	3.9
2500	37.9	13.85	1.93	39.1	1.85	-3.3	3.9
2525	37.8	13.94	1.96	39.1	1.88	-3.4	4.0
2550	37.7	14.02	1.99	39.1	1.91	-3.6	4.2
2575	37.6	14.09	2.02	39.0	1.94	-3.8	4.3
2600	37.5	14.17	2.05	39.0	1.96	-4.0	4.4
2625	37.4	14.23	2.08	39.0	1.99	-4.2	4.4
2650	37.3	14.29	2.11	38.9	2.02	-4.3	4.4
2675	37.1	14.36	2.14	38.9	2.05	-4.5	4.5
2700	37.0	14.43	2.17	38.9	2.07	-4.8	4.6

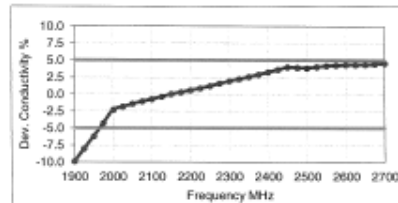
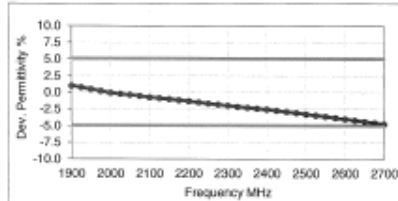



Figure D-5
2.4 GHz Head Tissue Equivalent Matter

FCC ID: A3LSMT705M		SAR EVALUATION REPORT		Reviewed by: Quality Manager
Test Dates: 04/30/14 - 05/14/14	DUT Type: Portable Tablet			APPENDIX D: Page 4 of 4

APPENDIX E: SAR SYSTEM VALIDATION



Per FCC KDB 865664 D02v01, SAR system validation status should be documented to confirm measurement accuracy. The SAR systems (including SAR probes, system components and software versions) used for this device were validated against its performance specifications prior to the SAR measurements. Reference dipoles were used with the required tissue- equivalent media for system validation, according to the procedures outlined in FCC KDB 865664 D01 v01 and IEEE 1528-2013. Since SAR probe calibrations are frequency dependent, each probe calibration point was validated at a frequency within the valid frequency range of the probe calibration point, using the system that normally operates with the probe for routine SAR measurements and according to the required tissue-equivalent media.

A tabulated summary of the system validation status including the validation date(s), measurement frequencies, SAR probes and tissue dielectric parameters has been included.



Table E-I
SAR System Validation Summary

SAR SYSTEM #	FREQ. [MHz]	DATE	PROBE SN	PROBE TYPE	PROBE CAL. POINT		COND.	PERM.	CW VALIDATION			MOD. VALIDATION		
							(σ)	(ϵ_r)	SENSI- TIVITY	PROBE LINEARITY	PROBE ISOTROPY	MOD. TYPE	DUTY FACTOR	PAR
K	750	4/2/2014	3287	ES3DV3	750	Head	0.932	41.87	PASS	PASS	PASS	N/A	N/A	N/A
I	835	5/14/2014	3209	ES3DV3	835	Head	0.943	43.06	PASS	PASS	PASS	GMSK	PASS	N/A
G	1750	3/5/2014	3258	ES3DV3	1750	Head	1.398	39.97	PASS	PASS	PASS	N/A	N/A	N/A
G	1900	3/7/2014	3258	ES3DV3	1900	Head	1.448	40.49	PASS	PASS	PASS	GMSK	PASS	N/A
H	2450	3/31/2014	3589	ES3DV3	2450	Head	2.027	38.04	PASS	PASS	PASS	OFDM	N/A	PASS
K	750	12/21/2013	3333	ES3DV3	750	Body	0.975	55.77	PASS	PASS	PASS	N/A	N/A	N/A
D	835	10/8/2013	3022	ES3DV2	835	Body	1.012	53.65	PASS	PASS	PASS	GMSK	PASS	N/A
J	1750	1/14/2014	3332	ES3DV3	1750	Body	1.450	52.15	PASS	PASS	PASS	N/A	N/A	N/A
E	1900	12/18/2013	3914	EX3DV4	1900	Body	1.579	51.41	PASS	PASS	PASS	GMSK	PASS	N/A
D	1900	9/10/2013	3022	ES3DV2	1900	Body	1.516	52.49	PASS	PASS	PASS	GMSK	PASS	N/A
G	2450	3/5/2014	3258	ES3DV3	2450	Body	2.044	51.30	PASS	PASS	PASS	OFDM	N/A	PASS

NOTE: While the probes have been calibrated for both a CW and modulated signals, all measurements were performed using communication systems calibrated for CW signals only. Modulations in the table above represent test configurations for which the measurement system has been validated per FCC KDB Publication 865664 D01v01 for scenarios when CW probe calibrations are used with other signal types. SAR systems were validated for modulated signals with a periodic duty cycle, such as GMSK, or with a high peak to average ratio (>5 dB), such as OFDM according to KDB 865664.

FCC ID: A3LSMT705M	 SAR EVALUATION REPORT 	Reviewed by: Quality Manager
Test Dates: 04/30/14 - 05/14/14	DUT Type: Portable Tablet	APPENDIX E: Page 1 of 1

APPENDIX G: SENSOR TRIGGERING DATA SUMMARY



FCC ID: A3LSMT705M	 PCTEST ENGINEERING LABORATORY, INC.	SAR EVALUATION REPORT		Reviewed by: Quality Manager
Test Dates: 04/30/2014 - 05/14/2014	DUT Type: Portable Tablet			APPENDIX G: Page 1 of 5

A3LSMT705M Sensor Triggering Data Summary

Per FCC KDB Publication 616217 D04v01, this device was tested by the manufacturer to determine the proximity sensor triggering distances for the back and top edge of the device. The measured output power within ± 5 mm of the triggering points (or until touching the phantom) is included for back side and each applicable edge.

To ensure all production units are compliant it is necessary to test SAR at a distance 1 mm less than the smallest distance from the device and SAR phantom (determined from these triggering tests according to the KDB 616217 D04v01) with the device at maximum output power without power reduction. These SAR Tests are included in addition to the SAR tests for the device touching the SAR phantom, with reduced power.

The operational description contains information explaining how this device remains compliant in the event of a sensor malfunction.

FCC ID: A3LSMT705M	 PCTEST ENGINEERING LABORATORY, INC.	SAR EVALUATION REPORT		Reviewed by: Quality Manager
Test Dates: 04/30/2014 - 05/14/2014	DUT Type: Portable Tablet		APPENDIX G: Page 2 of 5	

Back Side



Moving device toward the phantom:

KDB 616217 6.2.6 Measured Power [dBm]											
Distance[mm]	21	20	19	18	17	16	15	14	13	12	11
GSM 850	32.93	32.81	32.7	32.77	32.6	24.63	24.83	24.69	24.6	24.87	24.95
GSM 1900	29.9	29.95	29.73	29.7	29.68	17.44	17.27	17.31	17.12	17.32	17.2
GPRS 850 1Tx	32.7	32.86	32.92	32.6	32.64	24.95	24.66	24.81	24.82	24.78	24.8
GPRS 850 2Tx	30.19	30.4	30.39	30.36	30.5	22.4	22.28	22.19	22.42	22.39	22.39
GPRS 850 3Tx	28.45	28.42	28.26	28.2	28.41	20.4	20.24	20.22	20.38	20.44	20.17
GPRS 850 4Tx	26.79	26.69	26.79	26.94	26.88	18.92	18.74	18.84	18.73	18.74	18.66
GPRS 1900 1Tx	29.83	29.83	29.83	29.87	29.84	17.39	17.33	17.34	17.23	17.36	17.18
GPRS 1900 2Tx	27.5	27.23	27.31	27.24	27.18	14.93	14.82	14.87	14.79	14.83	14.92
GPRS 1900 3Tx	25.38	25.27	25.3	25.3	25.34	12.66	12.91	12.91	12.93	12.63	12.61
GPRS 1900 4Tx	23.87	23.85	23.86	23.69	23.89	11.37	11.22	11.19	11.41	11.11	11.11
EDGE850 1Tx	28.16	28.31	28.38	28.42	28.3	21.4	21.28	21.42	21.38	21.32	21.33
EDGE850 2Tx	27.28	27.37	27.1	27.38	27.36	20.18	20.11	20.36	20.24	20.32	20.22
EDGE850 3Tx	26.28	26.17	26.23	26.32	26.4	19.29	19.19	19.13	19.37	19.2	19.37
EDGE850 4Tx	25.94	25.77	25.63	25.76	25.78	18.9	18.62	18.71	18.81	18.68	18.94
EDGE1900 1Tx	25.76	25.79	25.67	25.61	25.74	13.68	13.88	13.94	13.89	13.65	13.62
EDGE1900 2Tx	24.91	24.71	24.7	24.63	24.66	12.74	12.93	12.93	12.84	12.64	12.77
EDGE1900 3Tx	23.8	23.9	23.83	23.76	23.95	11.61	11.65	11.67	11.93	11.71	11.87
EDGE1900 4Tx	23.39	23.2	23.42	23.42	23.34	11.41	11.41	11.31	11.38	11.16	11.27
WCDMA 850	22.74	22.81	22.71	22.7	22.79	5.37	5.19	5.13	5.15	5.38	5.11
WCDMA 1900	22.72	22.67	22.9	22.82	22.69	10.72	10.94	10.83	10.9	10.94	10.8
LTE B17	22.32	22.12	22.29	22.24	22.11	14.32	14.15	14.13	14.29	14.31	14.39
LTE B5	22.19	22.4	22.38	22.36	22.16	10.41	10.27	10.45	10.43	10.39	10.24
LTE B4	22.77	22.73	22.63	22.68	22.91	10.31	10.27	10.22	10.42	10.25	10.23
LTE B2	22.78	22.88	22.91	22.62	22.69	10.3	10.28	10.13	10.41	10.36	10.24

Moving device away from the phantom:

KDB 616217 6.2.8 Measured Power [dBm]											
Distance[mm]	21	20	19	18	17	16	15	14	13	12	11
GSM 850	32.72	32.67	32.85	32.67	32.67	24.89	24.64	24.66	24.85	24.92	24.8
GSM 1900	29.79	29.81	29.94	29.69	29.84	17.1	17.25	17.13	17.36	17.26	17.21
GPRS 850 1Tx	32.74	32.75	32.63	32.83	32.89	24.75	24.84	24.66	24.67	24.64	24.74
GPRS 850 2Tx	30.29	30.12	30.14	30.36	30.19	22.25	22.11	22.43	22.34	22.39	22.25
GPRS 850 3Tx	28.23	28.21	28.16	28.35	28.4	20.24	20.19	20.32	20.38	20.18	20.36
GPRS 850 4Tx	26.7	26.78	26.94	26.61	26.94	18.64	18.8	18.71	18.65	18.76	18.74
GPRS 1900 1Tx	29.67	29.78	29.77	29.83	29.71	17.15	17.42	17.19	17.42	17.39	17.11
GPRS 1900 2Tx	27.29	27.4	27.12	27.16	27.33	14.76	14.85	14.88	14.83	14.68	14.72
GPRS 1900 3Tx	25.26	25.27	25.37	25.21	25.22	12.6	12.94	12.67	12.77	12.7	12.95
GPRS 1900 4Tx	23.87	23.73	23.63	23.77	23.62	11.26	11.15	11.12	11.36	11.4	11.3
EDGE850 1Tx	28.28	28.29	28.22	28.42	28.1	21.33	21.42	21.16	21.22	21.32	21.31
EDGE850 2Tx	27.27	27.14	27.28	27.32	27.45	20.19	20.37	20.44	20.39	20.3	20.13
EDGE850 3Tx	26.1	26.26	26.29	26.41	26.25	19.23	19.13	19.18	19.37	19.31	19.12
EDGE850 4Tx	25.71	25.93	25.9	25.6	25.9	18.8	18.64	18.76	18.92	18.63	18.63
EDGE1900 1Tx	25.92	25.93	25.65	25.6	25.9	13.9	13.73	13.77	13.67	13.69	13.68
EDGE1900 2Tx	24.86	24.88	24.8	24.83	24.6	12.9	12.75	12.6	12.69	12.73	12.78
EDGE1900 3Tx	23.71	23.61	23.88	23.62	23.7	11.72	11.9	11.66	11.71	11.95	11.61
EDGE1900 4Tx	23.42	23.23	23.39	23.3	23.44	11.32	11.42	11.1	11.26	11.3	11.32
WCDMA 850	22.63	22.9	22.82	22.61	22.73	5.21	5.35	5.36	5.1	5.21	5.33
WCDMA 1900	22.75	22.73	22.94	22.83	22.93	10.89	10.77	10.81	10.73	10.71	10.85
LTE B17	22.31	22.36	22.21	22.3	22.1	14.39	14.21	14.14	14.18	14.4	14.39
LTE B5	22.35	22.38	22.27	22.11	22.35	10.27	10.33	10.27	10.37	10.32	10.42
LTE B4	22.81	22.7	22.75	22.61	22.6	10.18	10.36	10.4	10.21	10.45	10.14
LTE B2	22.68	22.73	22.74	22.77	22.77	10.34	10.16	10.21	10.2	10.36	10.3

Based on the most conservative measured triggering distance of 16 mm, additional SAR measurements were required at 15 mm from the back side.

FCC ID: A3LSMT705M	 PCTEST ENGINEERING LABORATORY, INC.	SAR EVALUATION REPORT		Reviewed by: Quality Manager
Test Dates: 04/30/2014 - 05/14/2014	DUT Type: Portable Tablet	APPENDIX G: Page 3 of 5		

Bottom Edge



Moving device toward the phantom:

KDB 616217 6.2.6 Measured Power [dBm]											
Distance[mm]	16	15	14	13	12	11	10	9	8	7	6
GSM 850	32.87	32.83	32.66	32.82	32.62	24.89	24.89	24.62	24.91	24.92	24.91
GSM 1900	29.78	29.81	29.81	29.8	29.8	17.33	17.44	17.33	17.13	17.15	17.21
GPRS 850 1Tx	32.64	32.82	32.66	32.84	32.78	24.61	24.74	24.94	24.69	24.85	24.95
GPRS 850 2Tx	30.15	30.22	30.31	30.25	30.18	22.29	22.16	22.27	22.45	22.25	22.29
GPRS 850 3Tx	28.43	28.36	28.34	28.45	28.18	20.19	20.21	20.27	20.3	20.39	20.45
GPRS 850 4Tx	26.71	26.63	26.72	26.85	26.79	18.62	18.65	18.87	18.73	18.62	18.6
GPRS 1900 1Tx	29.87	29.84	29.76	29.92	29.65	17.4	17.26	17.14	17.25	17.38	17.25
GPRS 1900 2Tx	27.35	27.12	27.45	27.12	27.24	14.84	14.93	14.7	14.85	14.82	14.69
GPRS 1900 3Tx	25.3	25.29	25.22	25.26	25.32	12.95	12.69	12.73	12.8	12.87	12.94
GPRS 1900 4Tx	23.78	23.84	23.8	23.83	23.77	11.14	11.43	11.3	11.14	11.31	11.27
EDGE850 1Tx	28.25	28.37	28.36	28.42	28.32	21.16	21.23	21.31	21.43	21.32	21.44
EDGE850 2Tx	27.34	27.32	27.21	27.29	27.16	20.2	20.25	20.2	20.16	20.27	20.19
EDGE850 3Tx	26.38	26.34	26.26	26.15	26.41	19.15	19.4	19.42	19.17	19.44	19.38
EDGE850 4Tx	25.76	25.74	25.72	25.67	25.82	18.62	18.86	18.94	18.93	18.89	18.85
EDGE1900 1Tx	25.85	25.83	25.69	25.6	25.76	13.67	13.71	13.95	13.93	13.63	13.88
EDGE1900 2Tx	24.75	24.69	24.69	24.63	24.8	12.79	12.83	12.66	12.87	12.9	12.88
EDGE1900 3Tx	23.63	23.92	23.91	23.68	23.75	11.85	11.94	11.85	11.92	11.84	11.67
EDGE1900 4Tx	23.38	23.28	23.23	23.36	23.24	11.27	11.3	11.44	11.26	11.25	11.3
WCDMA 850	22.7	22.78	22.62	22.64	22.63	15.32	15.43	15.1	15.36	15.29	15.19
WCDMA 1900	22.88	22.73	22.84	22.85	22.76	10.6	10.72	10.63	10.62	10.75	10.72
LTE B17	22.15	22.2	22.12	22.29	22.12	14.41	14.24	14.41	14.37	14.33	14.45
LTE B5	22.32	22.37	22.18	22.42	22.31	10.15	10.42	10.2	10.37	10.43	10.4
LTE B4	22.7	22.65	22.91	22.72	22.65	10.23	10.15	10.12	10.16	10.41	10.27
LTE B2	22.69	22.65	22.87	22.9	22.81	10.27	10.35	10.2	10.41	10.23	10.43

Moving device away from the phantom:

KDB 616217 6.2.8 Measured Power [dBm]											
Distance[mm]	16	15	14	13	12	11	10	9	8	7	6
GSM 850	32.71	32.75	32.9	32.79	32.64	24.94	24.73	24.92	24.93	24.61	24.66
GSM 1900	29.65	29.62	29.65	29.64	29.68	17.11	17.29	17.14	17.32	17.19	17.29
GPRS 850 1Tx	32.9	32.71	32.71	32.61	32.62	24.87	24.6	24.94	24.83	24.69	24.77
GPRS 850 2Tx	30.43	30.15	30.42	30.1	30.31	22.31	22.12	22.29	22.13	22.33	22.42
GPRS 850 3Tx	28.26	28.12	28.23	28.27	28.43	20.18	20.33	20.45	20.18	20.37	20.17
GPRS 850 4Tx	26.64	26.68	26.88	26.91	26.82	18.91	18.9	18.87	18.68	18.95	18.62
GPRS 1900 1Tx	29.72	29.94	29.87	29.73	29.71	17.13	17.41	17.13	17.31	17.28	17.1
GPRS 1900 2Tx	27.34	27.23	27.44	27.33	27.35	14.91	14.74	14.84	14.88	14.84	14.76
GPRS 1900 3Tx	25.13	25.37	25.43	25.29	25.18	12.75	12.93	12.68	12.6	12.95	12.95
GPRS 1900 4Tx	23.9	23.77	23.95	23.71	23.73	11.12	11.1	11.41	11.39	11.17	11.1
EDGE850 1Tx	28.13	28.29	28.34	28.33	28.13	21.45	21.29	21.35	21.13	21.3	21.36
EDGE850 2Tx	27.36	27.44	27.17	27.12	27.1	20.17	20.38	20.44	20.13	20.38	20.34
EDGE850 3Tx	26.24	26.15	26.18	26.34	26.21	19.37	19.18	19.39	19.4	19.34	19.19
EDGE850 4Tx	25.65	25.79	25.71	25.65	25.9	18.79	18.78	18.78	18.68	18.65	18.71
EDGE1900 1Tx	25.66	25.79	25.61	25.63	25.8	13.85	13.86	13.67	13.67	13.66	13.61
EDGE1900 2Tx	24.87	24.64	24.79	24.94	24.69	12.8	12.86	12.66	12.6	12.88	12.65
EDGE1900 3Tx	23.92	23.73	23.84	23.62	23.91	11.77	11.92	11.86	11.9	11.85	11.74
EDGE1900 4Tx	23.29	23.34	23.37	23.43	23.22	11.28	11.15	11.32	11.25	11.19	11.14
WCDMA 850	22.71	22.65	22.91	22.74	22.95	15.28	15.39	15.43	15.27	15.23	15.32
WCDMA 1900	22.76	22.91	22.87	22.67	22.95	10.75	10.85	10.69	10.94	10.93	10.74
LTE B17	22.18	22.11	22.45	22.27	22.2	14.42	14.34	14.13	14.42	14.43	14.33
LTE B5	22.15	22.2	22.42	22.35	22.35	10.11	10.22	10.36	10.26	10.4	10.24
LTE B4	22.84	22.76	22.79	22.72	22.61	10.31	10.3	10.33	10.45	10.24	10.1
LTE B2	22.9	22.9	22.91	22.94	22.94	10.25	10.33	10.3	10.28	10.23	10.45

Based on the most conservative measured triggering distance of 11 mm, additional SAR measurements were required at 10 mm from the top edge

FCC ID: A3LSMT705M	 PCTEST Engineering Laboratory, Inc.	SAR EVALUATION REPORT		Reviewed by: Quality Manager
Test Dates: 04/30/2014 - 05/14/2014	DUT Type: Portable Tablet	APPENDIX G: Page 4 of 5		

Right Edge



Moving device toward the phantom:

KDB 616217 6.2.6 Measured Power [dBm]											
Distance[mm]	10	9	8	7	6	5	4	3	2	1	0
GSM 850	32.62	32.77	32.88	32.72	32.88	24.89	24.83	24.95	24.8	24.79	24.6
GSM 1900	29.65	29.62	29.62	29.9	29.65	17.35	17.13	17.27	17.12	17.19	17.17
GPRS 850 1Tx	32.6	32.91	32.63	32.6	32.77	24.63	24.67	24.67	24.66	24.94	24.73
GPRS 850 2Tx	30.23	30.13	30.11	30.27	30.23	22.14	22.27	22.33	22.22	22.25	22.12
GPRS 850 3Tx	28.43	28.3	28.43	28.18	28.17	20.41	20.25	20.33	20.14	20.37	20.4
GPRS 850 4Tx	26.91	26.62	26.81	26.75	26.85	18.87	18.64	18.82	18.72	18.62	18.92
GPRS 1900 1Tx	29.62	29.66	29.66	29.83	29.94	17.19	17.18	17.3	17.26	17.32	17.14
GPRS 1900 2Tx	27.41	27.23	27.11	27.37	27.42	14.84	14.83	14.94	14.64	14.67	14.68
GPRS 1900 3Tx	25.16	25.37	25.16	25.34	25.1	12.69	12.74	12.8	12.77	12.94	12.86
GPRS 1900 4Tx	23.78	23.73	23.84	23.85	23.95	11.27	11.41	11.16	11.14	11.35	11.41
EDGE850 1Tx	28.3	28.5	28.19	28.4	28.17	21.34	21.42	21.41	21.25	21.42	21.34
EDGE850 2Tx	27.17	27.12	27.15	27.34	27.24	20.16	20.24	20.41	20.1	20.34	20.15
EDGE850 3Tx	26.22	26.3	26.2	26.2	26.23	19.32	19.11	19.12	19.26	19.14	19.3
EDGE850 4Tx	25.94	25.9	25.66	25.89	25.84	18.6	18.68	18.88	18.76	18.63	18.65
EDGE1900 1Tx	25.87	25.78	25.75	25.73	25.73	13.64	13.64	13.63	13.8	13.63	13.95
EDGE1900 2Tx	24.84	24.77	24.75	24.9	24.79	12.82	12.94	12.89	12.92	12.79	12.61
EDGE1900 3Tx	23.84	23.65	23.84	23.84	23.6	11.82	11.94	11.6	11.77	11.67	11.68
EDGE1900 4Tx	23.45	23.18	23.11	23.28	23.11	11.41	11.44	11.34	11.27	11.43	11.31
WCDMA 850	22.94	22.77	22.95	22.95	22.94	15.32	15.14	15.23	15.4	15.38	15.41
WCDMA 1900	22.68	22.63	22.61	22.76	22.92	10.8	10.87	10.94	10.94	10.84	10.68
LTE B17	22.28	22.23	22.25	22.37	22.33	14.43	14.45	14.22	14.15	14.17	14.44
LTE B5	22.41	22.28	22.25	22.25	22.19	10.23	10.25	10.19	10.1	10.24	10.22
LTE B4	22.66	22.62	22.64	22.67	22.72	10.37	10.11	10.14	10.34	10.3	10.3
LTE B2	22.9	22.87	22.7	22.76	22.85	10.32	10.26	10.38	10.11	10.39	10.36

Moving device away from the phantom:

KDB 616217 6.2.8 Measured Power [dBm]											
Distance[mm]	10	9	8	7	6	5	4	3	2	1	0
GSM 850	32.79	32.94	32.69	32.74	32.65	24.76	24.89	24.67	24.94	24.92	24.76
GSM 1900	29.81	29.74	29.89	29.85	29.62	17.38	17.21	17.44	17.45	17.27	17.23
GPRS 850 1Tx	32.66	32.65	32.79	32.82	32.8	24.85	24.61	24.73	24.69	24.83	24.84
GPRS 850 2Tx	30.28	30.13	30.31	30.36	30.38	22.18	22.34	22.44	22.37	22.25	22.14
GPRS 850 3Tx	28.22	28.23	28.35	28.15	28.17	20.14	20.38	20.33	20.33	20.24	20.27
GPRS 850 4Tx	26.68	26.81	26.93	26.66	26.92	18.68	18.9	18.73	18.86	18.76	18.65
GPRS 1900 1Tx	29.69	29.73	29.72	29.89	29.74	17.32	17.41	17.12	17.35	17.24	17.28
GPRS 1900 2Tx	27.38	27.28	27.21	27.2	27.15	14.84	14.62	14.69	14.95	14.83	14.76
GPRS 1900 3Tx	25.32	25.22	25.26	25.45	25.21	12.92	12.81	12.61	12.84	12.95	12.9
GPRS 1900 4Tx	23.85	23.63	23.93	23.84	23.84	11.13	11.14	11.37	11.41	11.21	11.31
EDGE850 1Tx	28.1	28.39	28.39	28.41	28.22	21.31	21.19	21.21	21.11	21.34	21.14
EDGE850 2Tx	27.4	27.2	27.32	27.33	27.37	20.17	20.42	20.43	20.18	20.25	20.1
EDGE850 3Tx	26.45	26.3	26.23	26.1	26.13	19.15	19.25	19.31	19.14	19.17	19.19
EDGE850 4Tx	25.95	25.71	25.66	25.7	25.9	18.79	18.92	18.66	18.84	18.69	18.63
EDGE1900 1Tx	25.84	25.69	25.83	25.92	25.75	13.65	13.6	13.88	13.71	13.73	13.91
EDGE1900 2Tx	24.66	24.76	24.83	24.75	24.68	12.73	12.73	12.91	12.6	12.63	12.84
EDGE1900 3Tx	23.69	23.71	23.81	23.92	23.62	11.9	11.6	11.75	11.84	11.76	11.72
EDGE1900 4Tx	23.38	23.18	23.25	23.35	23.38	11.3	11.16	11.35	11.34	11.13	11.15
WCDMA 850	22.83	22.67	22.71	22.7	22.86	15.22	15.12	15.43	15.35	15.21	15.12
WCDMA 1900	22.61	22.88	22.8	22.85	22.71	10.85	10.91	10.6	10.67	10.63	10.73
LTE B17	22.21	22.11	22.28	22.21	22.26	14.29	14.23	14.23	14.23	14.23	14.11
LTE B5	22.4	22.22	22.45	22.12	22.14	10.19	10.34	10.15	10.23	10.34	10.24
LTE B4	22.66	22.78	22.71	22.65	22.78	10.14	10.34	10.37	10.34	10.44	10.3
LTE B2	22.95	22.71	22.91	22.95	22.81	10.24	10.2	10.23	10.34	10.38	10.43

Based on the most conservative measured triggering distance of 5 mm, additional SAR measurements were required at 4 mm from the top edge

FCC ID: A3LSMT705M	 PCTEST Engineering Laboratory, Inc.	SAR EVALUATION REPORT		Reviewed by: Quality Manager
Test Dates: 04/30/2014 - 05/14/2014	DUT Type: Portable Tablet			APPENDIX G: Page 5 of 5